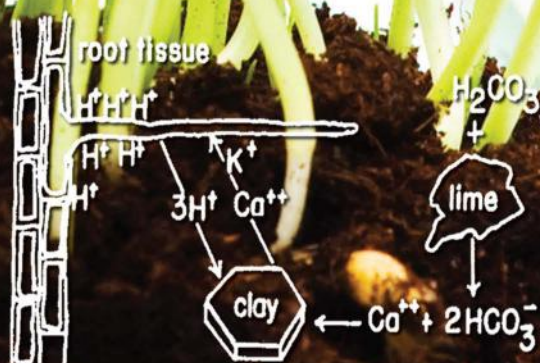


# PRINCIPLES OF SOIL CHEMISTRY

Fourth Edition

Kim H. Tan



 **CRC Press**  
Taylor & Francis Group

# **PRINCIPLES OF SOIL CHEMISTRY**

Fourth Edition

## BOOKS IN SOILS, PLANTS, AND THE ENVIRONMENT

### Editorial Board

<i>Agricultural Engineering</i>	Robert M. Peart, University of Florida, Gainesville
<i>Crops</i>	Mohammad Pessaraki, University of Arizona, Tucson
<i>Environment</i>	Kenneth G. Cassman, University of Nebraska, Lincoln
<i>Irrigation and Hydrology</i>	Donald R. Nielsen, University of California, Davis
<i>Microbiology</i>	Jan Dirk van Elsas, Research Institute for Plant Protection, Wageningen, The Netherlands
<i>Plants</i>	L. David Kuykendall, U.S. Department of Agriculture, Beltsville, Maryland Kenneth B. Marcum, Arizona State University, Tempe
<i>Soils</i>	Jean-Marc Bollag, Pennsylvania State University, University Park Tsuyoshi Miyazaki, University of Tokyo, Japan

- Soil Biochemistry, Volume 1*, edited by A. D. McLaren and G. H. Peterson  
*Soil Biochemistry, Volume 2*, edited by A. D. McLaren and J. Skujins  
*Soil Biochemistry, Volume 3*, edited by E. A. Paul and A. D. McLaren  
*Soil Biochemistry, Volume 4*, edited by E. A. Paul and A. D. McLaren  
*Soil Biochemistry, Volume 5*, edited by E. A. Paul and J. N. Ladd  
*Soil Biochemistry, Volume 6*, edited by Jean-Marc Bollag and G. Stotzky  
*Soil Biochemistry, Volume 7*, edited by G. Stotzky and Jean-Marc Bollag  
*Soil Biochemistry, Volume 8*, edited by Jean-Marc Bollag and G. Stotzky  
*Soil Biochemistry, Volume 9*, edited by G. Stotzky and Jean-Marc Bollag  
*Organic Chemicals in the Soil Environment, Volumes 1 and 2*, edited by C. A. I. Goring  
and J. W. Hamaker  
*Humic Substances in the Environment*, M. Schnitzer and S. U. Khan  
*Microbial Life in the Soil: An Introduction*, T. Hattori  
*Principles of Soil Chemistry*, Kim H. Tan  
*Soil Analysis: Instrumental Techniques and Related Procedures*, edited by  
Keith A. Smith  
*Soil Reclamation Processes: Microbiological Analyses and Applications*, edited by  
Robert L. Tate III and Donald A. Klein  
*Symbiotic Nitrogen Fixation Technology*, edited by Gerald H. Elkan

*Soil–Water Interactions: Mechanisms and Applications*, Shingo Iwata and Toshio Tabuchi with Benno P. Warkentin

*Soil Analysis: Modern Instrumental Techniques, Second Edition*, edited by Keith A. Smith

*Soil Analysis: Physical Methods*, edited by Keith A. Smith and Chris E. Mullins

*Growth and Mineral Nutrition of Field Crops*, N. K. Fageria, V. C. Baligar, and Charles Allan Jones

*Semiarid Lands and Deserts: Soil Resource and Reclamation*, edited by J. Skujins

*Plant Roots: The Hidden Half*, edited by Yoav Waisel, Amram Eshel, and Uzi Kafkafi

*Plant Biochemical Regulators*, edited by Harold W. Gausman

*Maximizing Crop Yields*, N. K. Fageria

*Transgenic Plants: Fundamentals and Applications*, edited by Andrew Hiatt

*Soil Microbial Ecology: Applications in Agricultural and Environmental Management*, edited by F. Blaine Metting, Jr.

*Principles of Soil Chemistry: Second Edition*, Kim H. Tan

*Water Flow in Soils*, edited by Tsuyoshi Miyazaki

*Handbook of Plant and Crop Stress*, edited by Mohammad Pessarakli

*Genetic Improvement of Field Crops*, edited by Gustavo A. Slafer

*Agricultural Field Experiments: Design and Analysis*, Roger G. Petersen

*Mechanisms of Plant Growth and Improved Productivity: Modern Approaches*, edited by Amarjit S. Basra

*Selenium in the Environment*, edited by W. T. Frankenberger, Jr. and Sally Benson

*Plant–Environment Interactions*, edited by Robert E. Wilkinson

*Handbook of Plant and Crop Physiology*, edited by Mohammad Pessarakli

*Handbook of Phytoalexin Metabolism and Action*, edited by M. Daniel and R. P. Purkayastha

*Soil–Water Interactions: Mechanisms and Applications, Second Edition, Revised and Expanded*, Shingo Iwata, Toshio Tabuchi, and Benno P. Warkentin

*Stored-Grain Ecosystems*, edited by Digvir S. Jayas, Noel D. G. White, and William E. Muir

*Agrochemicals from Natural Products*, edited by C. R. A. Godfrey

*Seed Development and Germination*, edited by Jaime Kigel and Gad Galili

*Nitrogen Fertilization in the Environment*, edited by Peter Edward Bacon

*Phytohormones in Soils: Microbial Production and Function*, William T. Frankenberger, Jr., and Muhammad Arshad

*Handbook of Weed Management Systems*, edited by Albert E. Smith

*Soil Sampling, Preparation, and Analysis*, Kim H. Tan

*Soil Erosion, Conservation, and Rehabilitation*, edited by Menachem Agassi

*Plant Roots: The Hidden Half, Second Edition, Revised and Expanded*, edited by Yoav Waisel, Amram Eshel, and Uzi Kafkafi

*Photoassimilate Distribution in Plants and Crops: Source–Sink Relationships*, edited by Eli Zamski and Arthur A. Schaffer

*Mass Spectrometry of Soils*, edited by Thomas W. Boutton and Shinichi Yamasaki

*Handbook of Photosynthesis*, edited by Mohammad Pessarakli

*Chemical and Isotopic Groundwater Hydrology: The Applied Approach, Second Edition, Revised and Expanded*, Emanuel Mazor

*Fauna in Soil Ecosystems: Recycling Processes, Nutrient Fluxes, and Agricultural Production*, edited by Gero Benckiser



*Soil and Plant Analysis in Sustainable Agriculture and Environment*, edited by Teresa Hood and J. Benton Jones, Jr.

*Seeds Handbook: Biology, Production, Processing, and Storage*, B. B. Desai, P. M. Kotecha, and D. K. Salunkhe

*Modern Soil Microbiology*, edited by J. D. van Elsas, J. T. Trevors, and E. M. H. Wellington

*Growth and Mineral Nutrition of Field Crops: Second Edition*, N. K. Fageria, V. C. Baligar, and Charles Allan Jones

*Fungal Pathogenesis in Plants and Crops: Molecular Biology and Host Defense Mechanisms*, P. Vidhyasekaran

*Plant Pathogen Detection and Disease Diagnosis*, P. Narayanasamy

*Agricultural Systems Modeling and Simulation*, edited by Robert M. Peart and R. Bruce Curry

*Agricultural Biotechnology*, edited by Arie Altman

*Plant–Microbe Interactions and Biological Control*, edited by Greg J. Boland and L. David Kuykendall

*Handbook of Soil Conditioners: Substances That Enhance the Physical Properties of Soil*, edited by Arthur Wallace and Richard E. Terry

*Environmental Chemistry of Selenium*, edited by William T. Frankenberger, Jr., and Richard A. Engberg

*Principles of Soil Chemistry: Third Edition, Revised and Expanded*, Kim H. Tan

*Sulfur in the Environment*, edited by Douglas G. Maynard

*Soil–Machine Interactions: A Finite Element Perspective*, edited by Jie Shen and Radhey Lal Kushwaha

*Mycotoxins in Agriculture and Food Safety*, edited by Kaushal K. Sinha and Deepak Bhatnagar

*Plant Amino Acids: Biochemistry and Biotechnology*, edited by Bijay K. Singh

*Handbook of Functional Plant Ecology*, edited by Francisco I. Pugnaire and Fernando Valladares

*Handbook of Plant and Crop Stress: Second Edition, Revised and Expanded*, edited by Mohammad Pessarakli

*Plant Responses to Environmental Stresses: From Phytohormones to Genome Reorganization*, edited by H. R. Lerner

*Handbook of Pest Management*, edited by John R. Ruberson

*Microbial Endophytes*, edited by Charles W. Bacon and James F. White, Jr.

*Plant–Environment Interactions: Second Edition*, edited by Robert E. Wilkinson

*Microbial Pest Control*, Sushil K. Khetan

*Soil and Environmental Analysis: Physical Methods, Second Edition, Revised and Expanded*, edited by Keith A. Smith and Chris E. Mullins

*The Rhizosphere: Biochemistry and Organic Substances at the Soil–Plant Interface*, Roberto Pinton, Zeno Varanini, and Paolo Nannipieri

*Woody Plants and Woody Plant Management: Ecology, Safety, and Environmental Impact*, Rodney W. Bovey

*Metals in the Environment*, M. N. V. Prasad

*Plant Pathogen Detection and Disease Diagnosis: Second Edition, Revised and Expanded*, P. Narayanasamy

*Handbook of Plant and Crop Physiology: Second Edition, Revised and Expanded*, edited by Mohammad Pessarakli

*Environmental Chemistry of Arsenic*, edited by William T. Frankenberger, Jr.

*Enzymes in the Environment: Activity, Ecology, and Applications*, edited by Richard G. Burns and Richard P. Dick

*Plant Roots: The Hidden Half, Third Edition, Revised and Expanded*, edited by Yoav Waisel, Amram Eshel, and Uzi Kafkafi

*Handbook of Plant Growth: pH as the Master Variable*, edited by Zdenko Rengel

*Biological Control of Major Crop Plant Diseases* edited by Samuel S. Gnanamanickam

*Pesticides in Agriculture and the Environment*, edited by Willis B. Wheeler

*Mathematical Models of Crop Growth and Yield*, , Allen R. Overman and Richard Scholtz

*Plant Biotechnology and Transgenic Plants*, edited by Kirsi-Marja Oksman Caldentey and Wolfgang Barz

*Handbook of Postharvest Technology: Cereals, Fruits, Vegetables, Tea, and Spices*, edited by Amalendu Chakraverty, Arun S. Mujumdar, G. S. Vijaya Raghavan, and Hosahalli S. Ramaswamy

*Handbook of Soil Acidity*, edited by Zdenko Rengel

*Humic Matter in Soil and the Environment: Principles and Controversies*, edited by Kim H. Tan

*Molecular Host Plant Resistance to Pests*, edited by S. Sadasivam and B. Thayumanayan

*Soil and Environmental Analysis: Modern Instrumental Techniques, Third Edition*, edited by Keith A. Smith and Malcolm S. Cresser

*Chemical and Isotopic Groundwater Hydrology, Third Edition*, edited by Emanuel Mazor

*Agricultural Systems Management: Optimizing Efficiency and Performance*, edited by Robert M. Peart and W. David Shoup

*Physiology and Biotechnology Integration for Plant Breeding*, edited by Henry T. Nguyen and Abraham Blum

*Global Water Dynamics: Shallow and Deep Groundwater: Petroleum Hydrology: Hydrothermal Fluids, and Landscaping*, edited by Emanuel Mazor

*Principles of Soil Physics*, edited by Rattan Lal

*Seeds Handbook: Biology, Production, Processing, and Storage, Second Edition*, Babasaheb B. Desai

*Field Sampling: Principles and Practices in Environmental Analysis*, edited by Alfred R. Conklin

*Sustainable Agriculture and the International Rice-Wheat System*, edited by Rattan Lal, Peter R. Hobbs, Norman Uphoff, and David O. Hansen

*Plant Toxicology, Fourth Edition*, edited by Bertold Hock and Erich F. Elstner

*Drought and Water Crises: Science, Technology, and Management Issues*, edited by Donald A. Wilhite

*Soil Sampling, Preparation, and Analysis, Second Edition*, Kim H. Tan

*Climate Change and Global Food Security*, edited by Rattan Lal, Norman Uphoff, B. A. Stewart, and David O. Hansen

*Handbook of Photosynthesis, Second Edition*, edited by Mohammad Pessaraki

*Environmental Soil-Landscape Modeling: Geographic Information Technologies and Pedometrics*, edited by Sabine Grunwald

*Water Flow In Soils, Second Edition*, Tsuyoshi Miyazaki

*Biological Approaches to Sustainable Soil Systems*, edited by Norman Uphoff, Andrew S. Ball, Erick Fernandes, Hans Herren, Olivier Husson, Mark Laing, Cheryl Palm, Jules Pretty, Pedro Sanchez, Nteranya Sanginga, and Janice Thies

*Plant–Environment Interactions, Third Edition*, edited by Bingru Huang  
*Biodiversity In Agricultural Production Systems*, edited by Gero Benckiser  
and Sylvia Schnell  
*Organic Production and Use of Alternative Crops*, Franc Bavec and Martina Bavec  
*Handbook of Plant Nutrition*, edited by Allen V. Barker and David J. Pilbeam  
*Modern Soil Microbiology, Second Edition*, edited by Jan Dirk van Elsas,  
Janet K. Jansson, and Jack T. Trevors  
*Functional Plant Ecology, Second Edition*, edited by Francisco I. Pugnaire  
and Fernando Valladares  
*Fungal Pathogenesis in Plants and Crops: Molecular Biology and Host Defense  
Mechanisms Second Edition*, P. Vidhyasekaran  
*Handbook of Turfgrass Management and Physiology*, edited by Mohammad Pessaraki  
*Soils in the Humid Tropics and Monsoon Region of Indonesia*, Kim H. Tan  
*Handbook of Agricultural Geophysics*, edited by Barry J. Allred, Jeffrey J. Daniels,  
and M. Reza Ehsani  
*Environmental Soil Science, Third Edition*, Kim H. Tan

# PRINCIPLES OF SOIL CHEMISTRY

Fourth Edition

Kim H. Tan  
*University of Georgia  
Athens, Georgia, U.S.A.*



CRC Press

Taylor & Francis Group

Boca Raton London New York

---

CRC Press is an imprint of the  
Taylor & Francis Group, an **informa** business

CRC Press  
Taylor & Francis Group  
6000 Broken Sound Parkway NW, Suite 300  
Boca Raton, FL 33487-2742

© 2011 by Taylor and Francis Group, LLC  
CRC Press is an imprint of Taylor & Francis Group, an Informa business

No claim to original U.S. Government works

Printed in the United States of America on acid-free paper  
10 9 8 7 6 5 4 3 2 1

International Standard Book Number-13: 978-1-4398-1395-9 (Ebook-PDF)

This book contains information obtained from authentic and highly regarded sources. Reasonable efforts have been made to publish reliable data and information, but the author and publisher cannot assume responsibility for the validity of all materials or the consequences of their use. The authors and publishers have attempted to trace the copyright holders of all material reproduced in this publication and apologize to copyright holders if permission to publish in this form has not been obtained. If any copyright material has not been acknowledged please write and let us know so we may rectify in any future reprint.

Except as permitted under U.S. Copyright Law, no part of this book may be reprinted, reproduced, transmitted, or utilized in any form by any electronic, mechanical, or other means, now known or hereafter invented, including photocopying, microfilming, and recording, or in any information storage or retrieval system, without written permission from the publishers.

For permission to photocopy or use material electronically from this work, please access [www.copyright.com](http://www.copyright.com) (<http://www.copyright.com/>) or contact the Copyright Clearance Center, Inc. (CCC), 222 Rosewood Drive, Danvers, MA 01923, 978-750-8400. CCC is a not-for-profit organization that provides licenses and registration for a variety of users. For organizations that have been granted a photocopy license by the CCC, a separate system of payment has been arranged.

**Trademark Notice:** Product or corporate names may be trademarks or registered trademarks, and are used only for identification and explanation without intent to infringe.

**Visit the Taylor & Francis Web site at**  
**<http://www.taylorandfrancis.com>**

**and the CRC Press Web site at**  
**<http://www.crcpress.com>**



---

# Contents

Preface to the Fourth Edition.....	xix
Acknowledgments.....	xxv
Author .....	xxvii
<b>Chapter 1</b> Definitions and Concepts of Soil Chemistry.....	1
1.1 The Issue of Soil Chemistry .....	1
1.2 Definition of Chemistry.....	2
1.2.1 Analytical Chemistry.....	2
1.2.2 Biochemistry .....	2
1.2.3 Geochemistry .....	3
1.2.4 Inorganic Chemistry.....	3
1.2.5 Organic Chemistry.....	3
1.2.6 Physical Chemistry.....	3
1.3 The Concept of Soil Physical Chemistry .....	3
1.4 The Concept of Geochemistry .....	4
1.5 The Concept of Soil Chemistry.....	5
<b>Chapter 2</b> Overview of Basic Chemical Principles and Units .....	7
2.1 Atom and Atomic Structures.....	7
2.2 Particle Accelerators or Synchrotrons.....	8
2.2.1 The Stanford Linear Accelerator.....	8
2.2.2 The Continuous Electron Beam Accelerator and ELIC.....	8
2.2.3 The Fermi National Laboratory Accelerator.....	9
2.2.4 The Brookhaven Realistic Heavy Ion Collider .....	9
2.2.5 The CERN Tevatron.....	9
2.3 Elementary Particles.....	10
2.3.1 Quarks .....	11
2.3.2 Leptons.....	11
2.3.2.1 Electrons .....	11
2.3.2.2 Neutrinos .....	11
2.3.3 Force Carriers: Bosons and Mesons.....	13
2.4 String Theory .....	13
2.5 The Atomic Model of Rutherford and Bohr.....	14
2.6 Mass and Weight .....	15
2.6.1 Mass .....	15
2.6.2 Weight .....	15
2.7 Atomic Mass and Atomic Mass Number .....	15
2.7.1 Atomic Mass Unit or Dalton .....	16
2.8 Atomic Numbers .....	17
2.9 Atomic Weights .....	17
2.10 Avogadro's Number.....	17
2.11 Atomic Orbitals .....	18
2.12 Atomic Radius.....	18
2.13 Valence .....	18

2.14	Equivalent Weight .....	19
2.14.1	Acid–Base Titrations .....	19
2.14.2	Precipitation and Complex Reactions .....	20
2.14.3	Oxidation–Reduction Reactions.....	20
2.15	Chemical Units .....	21
2.15.1	Normality .....	21
2.15.2	Molarity, Molality, and Formality.....	21
2.15.3	Mole Fractions.....	22
2.16	Isotopes.....	22
2.17	Radioactivity.....	23
2.18	Half-Life of Radioactive Material and Carbon Dating .....	24
<b>Chapter 3</b>	<b>Soil Composition and Electrochemical Potentials .....</b>	<b>25</b>
3.1	Soil Composition .....	25
3.2	The Concept of Electrochemical Potentials .....	26
3.2.1	Electrochemical Cells and Electrode Potentials .....	27
3.3	The Nernst Equation.....	28
3.4	Electrode Potentials in Redox Reactions.....	28
3.5	Electron Activity .....	31
3.5.1	Electron Activity in the Biochemical Cycle.....	32
3.5.2	The Relationship between Electron Activity and Electrode Potential.....	33
3.6	The rH Concept .....	34
3.6.1	The Relationship between rH and $p_e + p_H$ .....	35
3.7	Chemical Potential .....	36
3.8	Electrochemical Potential.....	37
3.9	Membrane or Donnan Potential .....	38
<b>Chapter 4</b>	<b>Soil Gas and Liquid Phases.....</b>	<b>41</b>
4.1	The Gaseous Phase.....	41
4.2	Composition of Soil Air .....	41
4.2.1	Aerobic Respiration and Decomposition.....	41
4.2.1.1	Aerobic Respiration of Plant Roots and Soil Organisms.....	42
4.2.1.2	Aerobic Decomposition of Organic Matter .....	42
4.2.2	Anaerobic Respiration and Decomposition.....	42
4.2.2.1	Anaerobic Respiration .....	42
4.2.2.2	Anaerobic Decomposition .....	43
4.3	The Oxygen Revolution.....	43
4.4	Soil Aeration or Aerification .....	44
4.4.1	Mass Flow .....	44
4.4.2	Diffusion.....	45
4.5	Characterization of Soil Air Quality .....	45
4.5.1	Determination of $O_2$ Concentration .....	45
4.5.2	Determination of the Oxygen Diffusion Rate (ODR) .....	45
4.5.3	Determination of the Redox Potential.....	46
4.6	Humidity of Soil Air .....	46
4.6.1	Relative Humidity .....	46
4.6.2	Absolute Humidity .....	47

4.6.3	Specific Humidity.....	47
4.7	Hydrotropism.....	48
4.8	The Liquid Phase.....	48
4.8.1	The Concept and Importance of the Soil Solution.....	48
4.8.2	Approximations of Soil Solutions.....	48
4.8.3	The Effect of the Gas Phase on the Soil Solution.....	49
4.8.4	Hypoxia.....	50
4.9	Chemistry of Soil Water.....	50
4.10	Oxygen Demand of Water.....	52
4.10.1	The Importance of Oxygen Demand in the Environment.....	53
4.11	Soil Water Energy Concepts.....	53
4.11.1	Water Potential ( $\Psi_w$ ).....	54
4.11.2	The Relationship of Water Potential and Chemical Potential of Water.....	54
4.11.3	Total Soil Water Potential ( $\Psi_t$ ).....	55
4.11.4	Matric Potential ( $\Psi_m$ ).....	55
4.11.5	Pressure Potential ( $\Psi_p$ ).....	56
4.11.6	Osmotic Potential ( $\Psi_o$ ).....	56
4.11.7	Gravitational Potential ( $\Psi_g$ ).....	56
4.11.8	Units of Soil Water Potential.....	56
4.11.9	The Relationship between $\Psi_w$ , Water Content, and Relative Humidity.....	57
4.12	The Plant–Soil–Water Energy Relation.....	58
4.13	The Law of Mass Action and Equilibrium Constant.....	59
4.14	Solubility Products.....	61
4.15	The Dissociation of Water.....	62
4.16	The Dissociation of Strong Electrolytes.....	62
4.17	The Dissociation of Weak Electrolytes.....	63
4.18	The Henderson–Hasselbalch Equation.....	64
4.18.1	Application of the Henderson–Hasselbalch Concept.....	65
4.19	The Equilibrium Constant and Ion Pairs.....	65
4.20	The Exchange Constant and Ion Exchange.....	67
4.21	The Relationship between the Equilibrium Constant and Cell or Electrode Potential.....	67
4.22	The Equilibrium Constant and Free Energy Relationship.....	68
4.23	The Equilibrium Constant and Electron Activity.....	69
4.24	Activity and Standard State.....	70
4.25	The Debye–Hückel Theory and Activity Coefficients.....	71
4.26	Ionic Strength.....	72
<b>Chapter 5</b>	<b>Colloidal Chemistry of Organic Soil Constituents.....</b>	<b>75</b>
5.1	The Colloidal System.....	75
5.2	The Organic Components.....	76
5.3	Soil Humus.....	77
5.3.1	The Issue of Glomalin in Humus.....	78
5.4	Carbohydrates.....	78
5.4.1	Properties of Carbohydrates and Their Accumulation in Soils.....	80
5.4.2	The Effect of Carbohydrates on Soil Properties.....	81
5.4.3	The Issue of Carbohydrates in Soil Hydrophobicity or Water Repellency.....	81

5.4.4	The Importance of Carbohydrates in Human Nutrition.....	82
5.4.4.1	The Issue of the Glycemic Index .....	82
5.4.5	Carbohydrates for Biofuel Production.....	82
5.5	Amino Acids, Peptides, and Proteins .....	83
5.5.1	The Colloidal Chemistry of Amino Acids.....	85
5.5.2	The Issue of Amino Acids in Human Health.....	86
5.6	Lipids.....	87
5.6.1	Colloidal Chemistry and the Importance of Lipids in Soils .....	88
5.6.2	The Significance of Fatty Acids in Human Health .....	89
5.7	Nucleic Acids.....	89
5.7.1	Colloidal Properties and the Importance of Nucleic Acids in Soil.....	90
5.7.1.1	Cation Exchange Reactions of Nucleic Acids.....	90
5.8	Lignins.....	90
5.8.1	Colloidal Chemistry and the Importance of Lignins in Soil .....	92
5.8.2	The Significance of Lignins in Industry and Pharmacology .....	93
5.9	Humic Matter .....	94
5.9.1	The Old and New Look of Humic Matter.....	94
5.9.1.1	The Issue of the Operational Concept of Humic Substances.....	94
5.9.1.2	The Emergence of the Supramolecular Association Concept.....	95
5.9.2	Types of Humic Matter .....	97
5.9.3	Extraction and Isolation of Humic Substances from Soils and Water .....	97
5.9.3.1	Extraction of Soil Humic Matter .....	97
5.9.3.2	Extraction of Aquatic Humic Matter.....	99
5.9.4	Chemical Characterization and Composition .....	99
5.9.4.1	Elemental Composition.....	99
5.9.4.2	Total Acidity .....	101
5.9.4.3	Carboxyl Groups.....	102
5.9.4.4	Hydroxyl Groups.....	103
5.9.5	Colloidal Chemistry and Reactions.....	103
5.9.6	Colloidal Properties and Potentiometric Titrations of Humic Acid .....	104
5.9.7	Chromatography of Humic Substances.....	105
5.9.7.1	Gel Chromatography .....	106
5.9.7.2	Gas–Liquid Chromatography .....	109
5.9.8	Molecular Weights of Humic Compounds.....	110
5.9.9	Spectral Characteristics of Humic Compounds .....	112
5.9.9.1	Ultraviolet and Visible Light Spectrophotometry .....	112
5.9.9.2	Infrared Spectroscopy .....	114
5.9.9.3	Magnetic Resonance Spectroscopy .....	115
5.9.10	Electron Microscopy of Humic Matter .....	121
5.9.11	Structural Chemistry of Humic Acids .....	124
5.9.11.1	The Hypothesis of Schnitzer and Khan (1972).....	125
5.9.11.2	The Hypothesis of Kononova (1961).....	125
5.9.11.3	The Hypothesis of Flaig (1975) .....	126
5.9.11.4	The Dimer Concept of Stevenson (1994).....	126
5.9.11.5	The Author’s Hypothesis .....	128
5.9.11.6	The Supramolecular Assemblage of Piccolo (2002) .....	129

5.9.11.7	The Issue of Pseudostructures and Molecular Modeling of Humic Matter Structures .....	129
5.9.12	The Agricultural, Industrial, and Environmental Importance of Humic Acids.....	130
<b>Chapter 6</b>	<b>The Colloidal Chemistry of Inorganic Soil Constituents.....</b>	<b>133</b>
6.1	The Clay Fraction of Soils.....	133
6.2	The Structural Chemistry of Clay Materials.....	135
6.2.1	The Unit Cell and Crystal Lattice .....	135
6.2.2	The Structure of Silicate Clays .....	136
6.2.3	The Kaolinite Group (1:1 Layer Clays) .....	138
6.2.4	Halloysite (1:1 Layer Clay) .....	139
6.2.5	The Smectite Group (Expanding 2:1 Layer Clays).....	141
6.2.6	Illites (Nonexpanding 2:1 Layer Clays).....	143
6.2.7	Vermiculites .....	144
6.2.8	Chlorites (2:2 Layer Clays).....	145
6.2.9	Mixed-Layer Clays.....	146
6.2.10	Silica Minerals .....	147
6.2.11	Iron and Aluminum Hydrous Oxide Clays .....	148
6.2.12	Amorphous Clays, Allophane, and Imogolite.....	151
6.3	The Identification of Clay Minerals .....	155
6.3.1	Differential Thermal Analysis (DTA).....	155
6.3.2	X-Ray Diffraction Analysis.....	158
6.3.3	Infrared Spectroscopy .....	161
6.4	The Surface Chemistry of Soil Clays.....	167
6.5	Surface Areas .....	169
6.5.1	Total Surface Areas.....	169
6.5.2	The Specific Surface Area .....	170
6.6	The Origin of Negative Charges in Soil Clays.....	171
6.6.1	Isomorphous Substitution.....	171
6.6.2	The Dissociation of Exposed Hydroxyl Groups.....	172
6.7	Positive Charges and Zero Point of Charge.....	173
6.8	The Use of $\Delta\text{pH}$ in the Determination of Negative or Positive Charges .....	174
6.9	Surface Potential.....	174
6.10	Electric Double Layer.....	175
6.10.1	The Helmholtz Double-Layer Theory.....	175
6.10.2	The Gouy–Chapman Double-Layer Theory .....	176
6.10.3	The Effect of Electrolytes on the Thickness of the Diffuse Double Layer .....	177
6.10.4	The Effect of Valence of Cations on the Thickness of the Diffuse Double Layer.....	177
6.10.5	Limitations to the Gouy–Chapman Diffuse Double-Layer Theory .....	178
6.10.6	The Stern Double-Layer Theory .....	178
6.10.7	The Triple-Layer Theory.....	178
6.11	The Zeta ( $\zeta$ ) Potential.....	179
6.11.1	The Effect of Electrolytes on the Zeta ( $\zeta$ ) Potential .....	180
6.12	The Electric Double Layer and Stability of Clays.....	180
6.13	The Effect of Flocculation and Dispersion on Plant Growth .....	181



<b>Chapter 7</b>	Adsorption in Soils.....	183
7.1	Types of Adsorption .....	183
7.1.1	Positive and Negative Adsorption .....	183
7.1.2	Specific and Nonspecific Adsorption.....	184
7.2	Adsorption Characteristics .....	185
7.3	Forces of Adsorption .....	186
7.3.1	Physical Forces.....	186
7.3.2	Chemical Forces.....	186
7.3.3	Hydrogen Bonding .....	187
7.3.4	Hydrophobic Bonding .....	187
7.3.5	Electrostatic Bonding .....	187
7.3.6	Coordination Reactions.....	187
7.3.7	Ligand Exchanges .....	188
7.4	Adsorption Isotherms .....	188
7.4.1	The Freundlich Equation.....	189
7.4.2	The Langmuir Equation .....	190
7.4.3	BET and GAB Equations .....	191
7.4.4	The Gibbs Equation.....	192
7.5	Adsorption of Water .....	193
7.5.1	Adsorption of Water by Silicate and Hydrous Oxide Clays.....	193
7.5.2	Adsorption of Water by Organic Matter .....	195
7.6	The Plant–Soil–Water Energy Relation.....	197
7.7	Adsorption of Organic Compounds .....	198
7.7.1	Physicochemical Properties of Organic Substances That Influence Adsorption .....	199
7.7.2	Interlayer Adsorption and Molecular Orientation of Organic Compounds.....	200
7.7.3	The Effect of Molecular Size on Adsorption .....	201
7.7.4	The Nature of Adsorption Isotherms .....	202
7.8	Interparticle Attraction.....	203
<b>Chapter 8</b>	Cation Exchange.....	205
8.1	Adsorption of Cations by Soil Colloids.....	205
8.2	Cation Exchange Reactions .....	206
8.3	Cation Exchange Capacity.....	208
8.3.1	Types of Cation Exchange Capacity.....	210
8.4	The Exchanging Powers of Cations.....	210
8.5	The Ionic Composition of the Exchange Complex.....	210
8.6	Empirical Equations of Cation Exchange .....	212
8.6.1	The Freundlich Equation.....	212
8.6.2	The Langmuir–Vageler Equation .....	212
8.7	Mass Action Law Equations of Cation Exchange .....	213
8.7.1	The Kerr and Gapon Equation .....	213
8.7.1.1	The Mono-Monovalent Cation Exchange Reaction.....	213
8.7.1.2	The Mono-Divalent Cation Exchange Reaction .....	214
8.7.2	The Vanselow Equation.....	214
8.8	Kinetic Equations of Cation Exchange.....	214
8.9	Thermodynamic Equations of Cation Exchange.....	215
8.9.1	The Quantity/Intensity (Q/I) Relation.....	216

8.10	The Cation Exchange Equation Based on the Donnan Theory.....	218
8.10.1	The Donnan Equilibrium Law .....	218
8.10.2	The Donnan Equation of Cation Exchange.....	218
8.11	The Cation Exchange Equation of Eriksson .....	220
8.12	The Cation Exchange Equation According to the Diffuse Double-Layer Theory .....	220
8.13	Schofield's Ratio Law .....	220
8.14	Fixation of Cations .....	222
8.15	Base Saturation.....	223
8.16	Adsorption and Exchange of Cations by Soil Organic Matter.....	224
<b>Chapter 9</b>	<b>Anion Exchange .....</b>	<b>225</b>
9.1	Positive Charges .....	225
9.2	Adsorption of Anions by Soil Colloids .....	226
9.2.1	Nonspecific Adsorption.....	227
9.2.1.1	Negative Adsorption .....	227
9.2.1.2	Positive Adsorption.....	228
9.2.2	Specific Adsorption .....	229
9.3	Phosphate Retention and Fixation .....	230
9.3.1	Phosphate Retention .....	230
9.3.2	Phosphate Fixation in Acid Soils .....	231
9.3.3	Phosphate Fixation in Alkaline Soils.....	233
9.4	Biological Fixation of Phosphate.....	233
9.4.1	Immobilization of Phosphates.....	235
9.4.2	The Interaction of Phosphates with Humic Acids and Other Organic Acids.....	236
9.5	Soil Reaction and Availability of Inorganic Phosphates .....	237
9.6	Prediction of Phosphate Ion Concentration According to Schofield's Ratio Law .....	239
9.7	The Phosphate Potential .....	240
9.7.1	The Chemical Potential of Phosphate .....	240
9.7.2	The Electrochemical Potential of Phosphate .....	240
9.7.3	Schofield's Phosphate Potential .....	241
<b>Chapter 10</b>	<b>Soil Reaction .....</b>	<b>243</b>
10.1	Definition and Importance .....	243
10.2	Acid–Base Chemistry.....	244
10.2.1	The Arrhenius Concept .....	244
10.2.2	The Brønsted–Lowry Concept.....	244
10.2.3	The Lewis Concept.....	245
10.2.4	The Usanovich Concept .....	246
10.2.5	The Lux and Flood Concept.....	246
10.2.6	The Pearson Concept.....	246
10.3	Application in Soils .....	246
10.4	Formulation of Soil Acidity and Alkalinity .....	247
10.4.1	Soil pH.....	247
10.4.2	Acidity Constant.....	248
10.4.3	Acid Strength and Ion Pairs .....	248
10.5	Concepts of Soil Acidity.....	249

10.5.1	Soil pH Range .....	249
10.5.2	Active versus Potential Acidity .....	250
10.5.3	Nonselective and Preferential Adsorption of Hydrogen Ions by Soils .....	251
10.6	The Role of Aluminum in Soil Acidity .....	252
10.7	The Role of Fertilizers, Sulfur, Pyrite, N Fixation, and Acid Rain in Soil Acidity .....	254
10.7.1	Ammonium Fertilizers .....	254
10.7.1.1	Equivalent Acidity and Acidity Index .....	255
10.7.2	Phosphate Fertilizers .....	256
10.7.3	Elemental Sulfur .....	256
10.7.4	Pyrite (FeS <sub>2</sub> ) .....	256
10.7.5	Biological Nitrogen Fixation .....	257
10.7.6	Acid Precipitation .....	257
10.8	Buffering Capacity of Soils .....	259
10.9	Electrometric Measurement of Soil pH .....	259
10.9.1	Measurement of pH in Water Extract .....	261
10.9.2	Measurement of pH in Soil Suspension .....	261
10.9.3	Measurement of pH in a KCl Solution .....	261
10.9.4	Measurement of pH in a CaCl <sub>2</sub> Solution .....	261
10.10	Suspension Effect in Soil pH Measurement .....	261
10.11	Lime Potential .....	262
10.12	The Need for Acidic Soil Reactions .....	262
10.13	Soil Reactions in Saline and Sodic Soils .....	262
10.13.1	Salinization .....	262
10.13.2	Sodication and Alkalinization .....	263
10.14	Chemical Characterization of Saline and Sodic Soils .....	263
10.15	Effect of Salinization and Sodication on Plant Growth .....	264
10.16	Irrigation of Saline and Sodic Soils .....	265
10.16.1	Salinity Hazards .....	265
10.16.2	Hazards of Sodication .....	265
10.17	Salt Balance and Leaching Ratio .....	266
10.18	Irrigation-Induced Salinization and Sodication .....	266
<b>Chapter 11</b>	<b>Soil Chemistry and Soil Formation .....</b>	<b>267</b>
11.1	Concepts of Weathering .....	267
11.2	Weathering Processes .....	268
11.3	Stability and Weathering of Soil Minerals .....	269
11.3.1	Crystal Chemistry and Mineral Properties .....	269
11.3.2	Coordination Theory and Pauling's Rules .....	269
11.3.3	Stability of Minerals and Bond Strength .....	272
11.4	Weathering of Feldspars and the Silica Potential .....	274
11.5	Weathering of Kaolinite and the Gibbsite Potential .....	274
11.6	Stability and Phase Relationships of Soil Minerals .....	275
11.7	Biological and Biochemical Weathering .....	276
11.7.1	Biological Weathering .....	276
11.7.2	Biochemical Weathering .....	278
11.8	Soil Formation Processes or Pedogenesis .....	279
11.8.1	Desilicification .....	279
11.8.2	Translocation of Clays .....	281

11.8.3	Translocation of Aluminum and Iron.....	282
11.9	Oxidation and Reduction Reaction in Soils.....	285
11.9.1	Redox Potentials.....	286
11.9.2	Redox Reaction Limits in Soils and the $E_h$ -pH Relation.....	286
11.9.3	The $pe$ -pH Relation.....	288
11.9.4	The Importance of $E_h$ -pH or $pe$ -pH Relations in Soil and Biological Systems.....	288
11.9.5	Constancy in $E_h$ -pH or $pe$ -pH Relations.....	289
11.9.6	Application of Redox Potentials in Soils.....	289
11.9.7	Stability of Iron Oxides and Hydroxides.....	291
11.9.8	Activity of Reduction Products.....	292
<b>Chapter 12</b>	<b>Chemistry of Soil–Organic Matter Interactions.....</b>	<b>293</b>
12.1	Complex Formation and Chelation.....	293
12.1.1	Complex Formation.....	293
12.1.2	Chelation.....	294
12.2	Interactions with Soil Organic Compounds.....	295
12.2.1	Effectiveness of Organic Acids in Chelation.....	295
12.3	Metal–Organic Complex Reactions.....	296
12.3.1	Stability Constants.....	296
12.4	Clay–Organic Compound Complexes.....	298
12.4.1	Complex Formation with Organic Anions.....	298
12.4.1.1	Positive and Negative Adsorption.....	298
12.4.1.2	Metal and Water Bridging.....	299
12.4.1.3	Van der Waals Force in the Complexation of Anions.....	299
12.4.2	Complex Formation with Organic Cations.....	299
12.4.3	Complex Formation with Amphoteric Organic Compounds.....	301
12.4.4	Complex Formation with Nonionic Organic Compounds.....	302
12.5	Complex Formation and Mobility of Soil Constituents.....	303
12.5.1	Metal Mobility.....	303
12.6	Stability Diagram of Metal Chelates.....	304
12.7	Complex Formation and Clay Mobility.....	305
12.8	Complex Formation and Soil Fertility.....	305
12.8.1	Complex Formation and Soil Physical Characteristics.....	305
12.8.2	Complex Formation and Soil Chemical Characteristics.....	306
12.8.3	Complex Formation and Soil Biological Characteristics.....	307
12.8.4	Chelation and Complexation in Industry and Medicines.....	309
<b>Appendix A:</b>	<b>Fundamental Constants.....</b>	<b>311</b>
<b>Appendix B:</b>	<b>Greek Alphabet.....</b>	<b>313</b>
<b>Appendix C:</b>	<b>Periodic Classification of Elements.....</b>	<b>315</b>
<b>Appendix D:</b>	<b>X-Ray Diffraction <math>2\theta</math> d-Spacing Conversion.....</b>	<b>317</b>
<b>Appendix E:</b>	<b>System International (SI) Units.....</b>	<b>319</b>
<b>Appendix F:</b>	<b>Factors for Converting U.S. Units into System International (SI) Units.....</b>	<b>321</b>
<b>References and Additional Readings.....</b>		<b>323</b>
<b>Index.....</b>		<b>343</b>





---

# Preface to the Fourth Edition

Since the first edition was printed in 1982 by Marcel Dekker, the *Principles of Soil Chemistry* has not only been used by the author at the University of Georgia, but was also selected for use at various universities overseas and in the United States for teaching senior-level undergraduate and graduate courses in soil chemistry. It is also a helpful reference for professionals and scientists in need of the basics in soil chemistry. It is the main textbook at the Hebrew University, Israel; the Universiti Pertanian Malaysia, Serdang, Malaysia; the Universidad Nacional del Sur, Bahia Blanca, Argentina; and at major universities in India. In addition, it is a required textbook at the University of Andalas and the University of North Sumatra in Indonesia. The first edition was translated into Bahasa Indonesia, the formal Indonesian language, and published by the University of Gajah Mada Press, Yogyakarta, Indonesia, under contract with Marcel Dekker (New York). It was so well received by southeast Asian students, scientists, and professionals whose main language was not English, that soon after its publication the translated version was sold out.

This fourth edition reexamines the entire reach of soil chemistry. By completely revising, updating, and incorporating a decade's worth of new information, this new edition is an entirely new and improved book. Though some reorganization of the chapters has been necessary, the simple writing style has been maintained to reach most of the audience in need of the basics in soil chemistry, which made the previous editions bestsellers overseas. The author's attempt is to now address the definitions and concepts of soil chemistry, comparing them with geochemistry and physical chemistry, and names that have been suggested to replace *soil chemistry*, which are preferred by a number of U.S. scientists. The comments made by a great number of readers have been gladly accepted and incorporated wherever possible, whereas the suggestions launched by reviewers to pay attention to competing books have been taken seriously by addressing differences in concepts and "bad" science to their full extent. Comments and corrections are suggested by the author for inaccuracies and discrepancies found in the competing literature. The author addressed these issues in the third edition as differences of opinions, and it was only a matter of caring by critics to read them. The alleged competing books also differ in style and scope with high-level statistics and, as such, are, in the author's opinion, "companion" books targeting a higher-level audience that should be well-versed in the basics of soil chemistry.

## THE CHAPTERS

A new chapter, Chapter 1 examines the origins of soil chemistry by J. T. Way, Van Helmont, Boussingault, and Moses in biblical times. The different names used throughout history, such as *agricultural chemistry*, *agrogeology*, and more are addressed, including the rebirth of the modern name *soil chemistry*, which occurred from 1970 to 1980, and was underlined by the publication of books by Bolt and Bruggenwert (1976) and Bohn et al. (1976). The concepts and definitions of *chemistry*, *geochemistry*, *physical chemistry*, and *soil chemistry* are examined, and conclude that identifying soil chemistry as geochemistry is like identifying soil science as geology.

Chapter 2 is about basic chemical principles and chemical units. The concepts of atoms, subatomic particles, mass, and weight are discussed as the underlying principles of chemistry. Major particle accelerators, especially the Fermi National Accelerator Laboratory and CERN tevatrons, are described for creating elementary particles, quarks, leptons, and neutrinos and for finding the force carriers, bosons, and mesons, and, in particular, the elusive graviton. A new bold theory, the *string theory*, is presented as the basis of the *theory of everything*, which scientists believe can be connected with the graviton concept. The atomic model of Rutherford and Bohr, atomic mass unit

or Dalton, valence and equivalent weights, isotopes, radioactivity, and half-life, and more are discussed as still representing the current ideas in soil chemistry.

Chapter 3 highlights soil composition, underscoring micropedology with the plasma and soil matrix concepts. The underlying view of soils representing electrochemical cells, similar to a battery, forming the basis of discussions of electrochemical potentials. Several types of potentials, electrode, electrochemical, chemical potentials, membrane, or Donnan, are distinguished with the Nernst equation, which plays a pivotal role in their formulation. The relation with electron activity,  $p_e$ , and the  $rH$  concept are provided.

Chapter 4 covers the soil gas and liquid phases. Soil air composition is explained as being dependent on aerobic and anaerobic respiration and decomposition that results in an imbalance between  $CO_2$  and  $O_2$  content. *Aeration*, also called *aerification*, the method for restoring  $O_2$  content, is described as an exchange of soil air for atmospheric air, with mass flow and diffusion affecting the movement of soil air. Oxygen content, oxygen diffusion rate, and redox potentials are examined as factors for determining soil air quality. The *oxygen revolution*, a new theory, is introduced to show oxygen as a key element in life today. Oxygen was absent some 3 billion years ago when a different earth atmosphere existed, which would have been highly toxic for life as we know it. Soil air humidity is discussed to introduce another new topic, called *hydrotropism*, a root response to a gradient in relative humidity in soil air, which is of great importance to *gravitropism* in space agriculture. The second part of Chapter 4 discusses the chemistry of soil water, oxygen demand, water potentials, and soil–plant–water energy issues. The rules and laws of reaction in soil water are presented, based on the *Law of Mass Action* or the *Law of Equilibrium*, in reactions involving solubility products, dissociation of water, strong and weak electrolytes, the Henderson–Hasselbalch equation, ion pairs, exchange constant, activity coefficient, the Debye–Hückel theory, and more. The relationship between equilibrium constants, electrode potentials, thermodynamics, and electron activity is addressed.

Chapter 5, concerning colloidal chemistry of organic soil constituents, begins with a study of the concepts and definitions of colloids in terms of linear dimension and mass. A definition of soil humus is given and a division suggested into a nonhumified and humified colloidal fraction. The chemistry, reactions, and implications in environmental quality, industry, and human health of carbohydrates, amino acids, lipids, nucleic acids, and lignins, as the major nonhumified components, are explored. The old and new looks of the humified fraction, represented by the *operational* and *supramolecular association concepts*, respectively, are examined. Three major types of humic matter are recognized—terrestrial, aquatic, and geologic—and the extraction procedures of humic and fulvic acids and their chemical characterization are provided in some detail. Gel, gas–liquid chromatography, visible light and infrared spectroscopy, in addition to electron paramagnetic, nuclear magnetic resonance spectroscopy, and electron microscopy of humic acids are discussed as important tools in the identification and explanation of the chemical reactions of humic acids. The chapter closes with a summary of the agricultural, industrial, and environmental significance of humic acids.

Chapter 6 examines the colloidal chemistry of inorganic soil components, the clay fractions of soils. Definitions of clay and how its unit cell and crystal lattice are formulated, and how clays are grouped into crystalline and amorphous, paracrystalline, or short-range-order (SRO) clays. The crystal structure, chemistry, reaction, and characterization by infrared spectroscopy, differential thermal and x-ray diffraction analyses, and electron microscopy are presented for the major crystalline silicate clays and SRO minerals. The newly discovered minerals *akaganeite* and *schwertmannite* are also discussed. Explanations are provided for surface chemistry; surface charges; positive, negative, and zero point charges (ZPCs); and surface potentials. Corrections are proposed for Sposito's concept on inner- and outersphere charges. The surface chemistry of soil clays is presented, recognizing three important surfaces: (1) the siloxane surface with innersphere cavities too small for the adsorption of water; (2) the oxyhydroxy surfaces; and (3) the group of silanol, aluminol, and ferrol surfaces of significance as outersphere surfaces. Surface areas, designated as *total* or *specific surfaces*, are studied in light of their importance in charge distribution and issues

of adsorption. The origin of negative and positive charges, major electric double-layer theories, and the zeta potential are presented. An examination of ZPC, classified by some into ZPC, ZPPC (zero point proton charge), and ZPNC (zero point net charge), finds ZPPC and ZPNC to be insignificant. The importance of the electrochemical behavior of clays is evaluated on dispersion and flocculation of soils in light of soil stability and plant growth.

Chapter 7 discusses adsorption in soils as consequences of electrochemical behavior, types of surfaces, surface areas, and surface-charge densities of the organic and inorganic soil colloids. The definition of *adsorption* is presented as reversible, and equilibrium reactions are characterized by a positive heat of adsorption in contrast to pseudo-adsorption. The concepts of positive and negative adsorption are compared with those of specific and nonspecific adsorption. The use of too many names to replace specific and nonspecific adsorption is discussed and the confusion it is causing for many readers, due also to the fact that the concepts proposed by several authors are totally in disagreement with each other. Physical, chemical, and electrochemical forces responsible for adsorption processes are presented, and some, such as hydrophobic bonding, coordination reaction, and ligand exchange, are handled as special issues. Major adsorption isotherms for characterizing the behavior of adsorption are discussed and separated into two groups. The first group is based on identification of shape and curvature of isotherms, and the second group is based on statistical formulation (for example, Freundlich, Langmuir, Brunauer, Emmett, and Teller (BET) and Guggenheim, Anderson, and de Boer (GAB), and Gibbs equations). Changing the names of the isotherms to Van Bemmelen–Freundlich and Langmuir–Freundlich equations, based only on the use of different symbols, is presented as confusing the issue. Adsorption of water is discussed on the basis of water potentials and availability to plants, and on the forces of attraction by silicate, hydrous oxide clays, and organic matter. The final sections discuss the adsorption of organic matter in view of concerns of increasing pollution due to pesticides, underscoring physicochemical properties, interlayer adsorption, and molecular orientation of the organics.

Chapter 8 discusses cation exchange, beginning with definitions and concepts, lyotropic series, and the law of Coulomb governing differences in preferential adsorption and exchange. The conversion of primary minerals, such as orthoclase into albite and more, as postulated by some, is examined as an aberration of science that sends an improper message about cation exchange reactions. The *cation exchange capacity* (CEC) is defined scientifically on the basis of surface area and charge density and practically by analysis and summation of the determined exchangeable cations. Several types of CECs are recognized— $CEC_p$ ,  $CEC_v$ ,  $CEC_t$ , and ECEC—and explained. Statistical models or formulas of exchange reactions are classified into empirical, mass action law, kinetic, and thermodynamic equations, which to some extent differ from the ideas of Sparks. The van Laar, Rothmund–Kornfeld, Freundlich, and Langmuir equations, often used by several scientists, are evaluated to be more applicable to adsorption than to exchange reactions. Considering the van Laar equivalent to the Vanselow equation as postulated by Sposito confuses the basic concept proposed by Vanselow. The Donnan equation and Schofield's ratio law in cation exchange reactions, seldom used in other books, are addressed, and the differences between the Donnan and Kerr equations are discussed. The fixation of cations is emphasized as a temporary nuisance rather than as a harmful effect on crop production. Adsorption and cation exchange reactions by soil organic matter are underlined as a special issue related to complex formation and chelation.

Chapter 9 relates anion adsorption and exchange by nonspecific and specific adsorption processes due to the attraction of positive charges and the displacement of lattice O or exposed OH groups on clay mineral surfaces by anions, respectively. Phosphate ions, the most important anion, are highlighted, and differences in specific adsorption, retention, and fixation of phosphate are outlined. Biological fixation is explained as the immobilization of phosphate by plants and microorganisms into their cellular constituents and as an interaction of phosphates with organic substances secreted by roots or humic acids synthesized from decomposition products of soil organic matter. The chemical potential and Schofield's phosphate potential are formulated, and predictions are made of phosphate ion concentration by the application of Schofield's ratio law.

Chapter 10 addresses the soil reaction that is being used to indicate the acid–base reaction in soils. Acids and bases are defined by the Arrhenius, Brønsted–Lowry, and Lewis theories, and new concepts as postulated by Usanovich, Lux–Flood, and Pearson. The acidity constant, defined by using the Brønsted–Lowry concept, is applied in distinguishing strong from weak acids, whereas the pH is formulated from the  $H^+$  ion concentrations. Based on soil pH ranges, *soil acidity classes*, such as weakly, moderately, and strongly acidic (or basic) soils, are created as the proper terminology in indicating the acid–base conditions in soils. The use of terms such as *acidic pH*, *neutral pH*, and *basic pH* by a number of scientists is explained as being inappropriate. Acid strength, potential and active acidity, preferential and nonselective adsorption of  $H^+$  ions in soils, and the role of Al and fertilizers are addressed. The magnitude of pH changes due to Al concentration is formulated and expressed in terms of *aluminum potential* (pAl), whereas the degree of acidity created by fertilizers is formulated in terms of *equivalent acidity* or *acidity index*. Pyrite, which is of special importance in coastal areas and soils polluted by mine spoil, elemental S, and acid rain are additional highlighted topics. *Canopy interaction*, involving *through-fall* and *stem flow*, and the effect of biological N fixation, not realized by scientists, are highlighted. The determination of soil pH in water extracts, soil suspension, and KCl and  $CaCl_2$  solutions are discussed in detail, and the formulation of lime potential is presented. Chemical principles of potentiometric measurement of pH involving the Nernst equation are addressed. Soil reactions in saline and sodic soils, differentiating sodication from alkalization, are examined using the *exchangeable  $Na^+$  percentage* (ESP) and *electrical conductivity* (EC). The critical EC value and differences among scientists on the *sodium adsorption ratio* (SAR) in issues of hazards of salinization and sodication are evaluated.

Chapter 11 explains the application of soil chemistry in soil formation. Concepts of weathering are examined. Differences between *geological weathering* producing *weathering profiles* composed of layers of disintegrated rocks, saprolite, saprock, and bedrock underlying a strip of soil are contrasted to *pedological weathering* forming *pedons* and exhibiting *soil profiles*. Crystal chemistry and other mineral properties and Pauling's rules are examined in stability and in bond strength affecting the disintegration of cyclo-, ino-, neso-, phyllo-, soro-, and tectosilicates. The *silica potential* and *gibbsite potential* are formulated to predict the decomposition of feldspars into kaolinite, and kaolinite into gibbsite, respectively. The stability and phase relations of minerals are expressed in stability diagrams. Biological and biochemical weathering are recognized as two separate but closely related processes. Soil formation processes, called *pedogenesis*, are discussed, and silicification and desilicification are examined as main processes in poorly drained and well-drained soils, producing smectite and kaolinite, respectively. *Silicification* is suggested as the proper term, instead of *silication* as used by many U.S. scientists. *To silicify* and not *to silicate* is to impregnate with silica. The formation of argillic, albic, and spodic horizons is discussed as are the oxidation potentials invoked in the translocation of Al and Fe. Oxidation and reduction, called redox reactions, and how they affect the formation of all soils are explained. Redox potential and redox limits in soils are formulated, and the pe and pH relation is examined in biological systems. Applications of redox potentials in soils and the stability of iron oxides and hydroxides are addressed.

Chapter 12 discusses the chemistry of interactions between soil and organic matter. The concepts of complex formation and chelation are clearly delineated with complexation being a metal–ligand coordination process and chelation being an interaction with the ligand donating more than one of its donor functional groups, yielding a chelate ring. Nonhumified—live or dead—organics and humified substances serving as ligands and their effectiveness in complexation and chelation are examined. Organic substances with acidic properties due to the presence of carboxyl groups,  $-COOH$ , are capable of complexing only, in contrast to those possessing both carboxyl and phenolic–OH groups, which can exert a variety of interactions, from electrostatic attraction, coadsorption, and complexation to chelation. *Stability constants*, interpreted by several scientists as *solubility constants*, are formulated using the law of mass action, and the relative ease of dissolving or degree of solubility of the complexes or chelates are evaluated. Interactions between clay and organic substances are examined in light of positive and negative adsorption, metal and water bridging,

and hydrophobic and van der Waals interactions. The interactions between clays and in particular organic anions, both exhibiting negative charges, are addressed. Metal mobility and clay mobility of the complexes and chelates are highlighted, and the effects of the complexes or chelates on biological and biochemical soil properties are explained. Also new to this edition of the book is a discussion of the beneficial application of complexation and chelation in industry, pharmacology, and medical science. Applications that are examined include their use as water softeners, their application in steam engineering, the use of EDTA in cleaning root canals, and a newly developed chelation therapy for the treatment of clogged arteries.

**Kim H. Tan**





---

# Acknowledgments

The author wishes to thank and acknowledge students and scientists at various universities and institutions for their comments, suggestions, reviews, and contributions to the development of this fourth edition. Many thanks are due to Dr. Robert L. Wershaw, U.S. Geological Survey, Federal Center, Denver, Colorado, for extending his great cooperation in discussing and supplying the most recent information on his micellar concept of humic substances. Thanks are extended to Dr. Peter Leinweber, Institute of Soil Science, University of Rostock, Rostock, Germany, for providing some insights into the new concepts of molecular structures of humic substances. Grateful appreciation is also due to Elsevier Science, Oxford, United Kingdom, and Springer, Boston, Massachusetts, for providing permissions for the reproduction of figures of molecular structures and magnetic resonance spectra of humic substances. Special recognition goes to John Rema, the University of Georgia, Athens, Georgia, for his assistance in computer programming and literature retrieval. Last but not least, my thanks go to my wife Yelli for her encouragement and support.



---

# Author

Dr. Kim Howard Tan is Professor Emeritus at the Department of Crops and Soil Science, University of Georgia, Athens, Georgia, where he has taught basic soils, soil chemistry, advanced soil chemistry, and methodology of soil and plant analysis for more than 25 years. Since his retirement in 1996, he has been invited to teach soil chemistry and environmental soil science at various universities overseas. He was a Fulbright visiting professor at the Universidad Nacional del Sur, Argentina, from 2002 to 2003. Dr. Tan is widely known for his research on soil formation from volcanic ash and is considered one of the experts on andosols. His humic acid research has made him one of the authorities on humic acid chemistry and organic–inorganic interaction reactions. He was named Fellow of the American Society of Agronomy and the Soil Science Society of America. He is a member of the International Union of Soil Science.

Dr. Tan is the recipient of numerous awards and honors for excellence in teaching, such as the University of Georgia—College of Agriculture Alumni Award and the prestigious D. W. Brooks Award. He was named the Outstanding Teacher of the College of Agriculture for a number of consecutive years since 1972 in college-wide polls conducted by the horticulture and agronomy clubs. Dr. Tan has also established an audio-tutorial enrichment study center where students can learn at their own pace, and he organized the first soil judging team in 1972. He was elected in 1981, as a junior advisor of Alpha Zeta, an honor fraternity in agriculture, by the students.

The author or coauthor of more than 200 articles, abstracts, proceedings, and book chapters, as well as the author, coauthor, or editor of 13 books, Tan has served as the Associate Executive Editor of the *Communication of Soil Science and Plant Analysis*, *Journal of Plant Nutrition*, Marcel Dekker, and is an International Panel Member of the *Malaysian Journal of Soil Science*. His most popular book *Principles of Soil Chemistry* is now in its fourth edition. His book *Environmental Soil Science* was published in 2009 in its third edition by Taylor & Francis/CRC Press. *Andosols*, a Hutchinson Ross benchmark book by Van Nostrand Reinhold Co., was sold out as soon as it was published.

Dr. Tan received a master's degree (1955) in agronomy from the University of Indonesia and graduated with a Ph.D. degree (1958) in pedology under Dr. Ir. J. Van Schuylenborgh, past deacon of the subfaculty of the University of Amsterdam, The Netherlands. After postdoctoral training at the North Carolina State University, Raleigh, North Carolina, and Cornell University, Ithaca, New York, under the tutorship of Dr. Ralph McCracken, Dr. Adolf Mehlich, Dr. Marlin Cline, and Dr. Michael Peech, respectively, he returned to the University of Indonesia, where as the head of the Department of Soil Science, he contributed to the founding of the Agricultural University at Bogor, presently known as IPB (Institut Pertanian Bogor).



---

# 1 Definitions and Concepts of Soil Chemistry

## 1.1 THE ISSUE OF SOIL CHEMISTRY

Soil chemistry is the youngest branch of soil science. The material is at the same level and as important as that of soil physics, soil genesis and taxonomy, soil microbiology, soil fertility, soil mineralogy, and other branches of soil science. It is essential that each of the subdivisions carries a considerable amount of chemistry for explaining and illustrating their respective topics and issues. This dependency on soil chemistry is greater than many soil scientists would have expected and will be discussed in more detail in Section 1.5.

Though many scientists consider J. T. Way as the founder of soil chemistry (Sonon et al., 2001; Thomas, 1977), it was, perhaps, Jan Baptista Van Helmont, with his famous willow tree experiments in the early 17th century and J. B. Boussingault in 1834, with the discovery of C, H, and O in plant tissue coming from rain and water (Brady, 1990), who truly started soil chemistry. In many respects, the “old pioneers” are indeed important contributors to the development of some aspects of soil chemistry. But, in line with the idea that soil fertility and plant nutrition began with Phillip Carl Sprengel (1787–1859) and Justus Von Liebig (1803–1873), the argument that the early work on adsorption by J. T. Way around 1850 was the start of the science of soil chemistry may have great merits. However, adsorption and exchange reactions were mentioned long before the 1800s, and an example of these processes was stated earlier in the Bible (Rieman and Walton, 1970). In addition, J. T. Way was allegedly known for the discovery of the nitrification process, hence contributing to the emergence of *soil microbiology* instead. According to Brady (1990), Way allegedly discovered in 1856 that ammonium substances were converted in soils into nitrates, a reaction that 20 years later was demonstrated by R. Warrington to be a microbial process. Sergei Vinogradskii then isolated in 1890 the two bacteria responsible for what we call today *nitrification* (Ackert, 2006). In the past, a variety of other names have also been used for soil chemistry, such as *agricultural chemistry*, *chemistry of soil constituents*, and *colloid chemistry*. *Agricultural chemistry* was introduced perhaps in the beginning of the 19th century by Humphrey Davy (1778–1829) and is considered by Sparks (2006) to be the forerunner of soil chemistry. At one time, close to the middle of the 20th century, even *soil analysis*, *soil fertility*, and *geochemistry* were identified as soil chemistry. The Dutch school was using at that time the term *agrogeology*, apparently coined from *Agricultural Geology*, a book published in 1916 by Rastall. Claiming that soils were not the domains of geologists, Rastall indicated that mineralogical composition and *petrography* (particle size distribution) were of great value in assessing the agricultural values of soils.

As a modern science, soil chemistry started to crystallize in the 1970s, and the real giants in soil chemistry are, therefore, not yet known. The book *Soil Chemistry*, edited by Bolt and Bruggenwert (1976), and another book with the same title by Bohn et al. (1979) have paved the way for carving the identity of modern soil chemistry. A subsequent publication in 1982 of the first edition of the *Principles of Soil Chemistry* has, in fact, created an unexpected stir, and several other books have since been published in rapid succession. Though carrying different names, such as *The Chemistry of Soils*, *Soil Physical Chemistry*, *Environmental Soil Chemistry*, *Soil and Water Chemistry*, *Soils and Environmental Quality*, and *Soils and the Environment*, these seemingly opposing books

address only certain specialized chapters of soil chemistry. They are different in approach and style, often emphasizing high-powered statistics, seldom used in everyday soil chemistry and hence of academic importance only. However, the message they carry about the chemistry of soils is similar. These books can serve, perhaps, as filling alleged gaps when or if present in the *Principles of Soil Chemistry*. Such a dispute is not new and is one way science can further advance.

Identifying *soil chemistry* as *geochemistry* or *physical chemistry* and the like is like identifying *soil science* as *geological science* or *geology*. Therefore, it is deemed necessary to start the new edition of this book by addressing first the concept of soil chemistry and its relationship with pure chemistry, geochemistry, soil physical chemistry, and the like.

## 1.2 DEFINITION OF CHEMISTRY

The science of pure chemistry is defined as “the study of the composition, structure and properties of matter, chemical processes and phenomena and the changes they are bringing to matter or substances” (*Merriam-Webster*, 2003; Nebergall et al., 1972). The name *chemistry* is derived from either the Egyptian term *kême* (meaning “earth”) or the Arabic *al-kîmiyâ*, inherited from the Greek and French word *al-kemie* for *alchemie*, the ancient chemistry of trying to create gold from base metals. As a science, chemistry allegedly began with Muslim scientists and scholars, the Saracens, who performed controlled and precise analyses that were recorded very carefully. Al-kîmiâ, the most scientific of medieval analyses, has been the source of numerous accidental discoveries and hence has contributed to the development of chemical science. It introduced a distinction between alkalis and acids and produced and refined many chemicals and drugs (Durant, 1980).

The basics of pure chemistry are concerned with studying atoms, elements, and molecules and their transformation into matter or substances, ions, and salts. Chemical bonding, reactions, and energy transfer are involved in producing these transformations. All these became an established science after the discovery of the *law of conservation of mass* by Lavoisier (1743–1794), providing a quantitative basis in chemistry. This law indicates that chemical reactions are balanced reactions and occur in equivalent amounts (Nebergall et al., 1972; Rosenberg et al., 2009). With the rapid advancement in the science of chemistry, today many branches or subdisciplines of pure chemistry are recognized, including analytical chemistry, biochemistry, geochemistry, inorganic chemistry, organic chemistry, and physical chemistry. A description of each subdiscipline mentioned is provided below.

### 1.2.1 ANALYTICAL CHEMISTRY

Analytical chemistry deals with analyses of inorganic and organic materials to examine their chemical composition and structure. The methods may include physical methods, such as spectroscopy and thermal methods. Called *physicochemical analyses*, the methods are based on measurement of a physical property, but chemical reactions are essential parts of the procedures. The following example serves as an illustration. In spectrophotometry, the absorption of light by a colored solution, the *absorbance*, is measured. Chemical reactions are essential parts of the methods to develop the specific color for identification of the element, but the final step is the measurement of the amount of light absorbed by the colored solution, which is purely a measurement of a physical property. For more detail on physicochemical analyses, refer to Tan (2005).

### 1.2.2 BIOCHEMISTRY

Biochemistry is the study of the chemistry and reactions of carbohydrates, lipids, amino acids, proteins, nucleic acids, nucleotides, lignin, vitamins, hormones, viruses, and other related biocompounds that are artificially produced or present in living cells (Lehninger et al., 2008).

### 1.2.3 GEOCHEMISTRY

Geochemistry involves the study of the chemical composition of the earth, and especially of the chemical characteristics of rocks, minerals, lava, and magma, their mutual interactions, as well as their interactions with the hydrosphere and atmosphere (Krauskopf, 2003; Walther, 2009). The mineral constitution is the basis for the well-known distinction of acid, intermediate and basic igneous, and sedimentary and metamorphic rocks. With the rapid development of space science today, the science of geochemistry is extended to cover the science of *cosmochemistry*, which is the study of elements, materials, and isotopes in the cosmos. It is the science addressing the chemical composition of celestial objects, distant galaxies, and planetary nebulae (Esteban et al., 2009).

### 1.2.4 INORGANIC CHEMISTRY

Inorganic chemistry covers inorganic molecules and compounds and their properties and reactions. It is the counterpart of organic chemistry, which is defined below.

### 1.2.5 ORGANIC CHEMISTRY

Organic chemistry studies the composition, structure, properties, and reactions of organic compounds. Organic compounds are considered compounds that possess a carbon skeleton. Organic chemistry is closely associated with biochemistry.

### 1.2.6 PHYSICAL CHEMISTRY

Physical chemistry examines the physical basis of chemical reactions and systems. In other words, it is a science developed, in fact, to address the physical foundations underlying the chemical processes. It is believed that physical chemistry originated with the work of Josiah Willard Gibbs *On the Equilibrium of Heterogenous Substances*, published in 1867 (Levine, 2008). This has laid a solid foundation for physical chemistry with the famous *Gibbs phase rule*, *Gibbs free energy*, and concepts of *chemical potentials*. Today physical chemistry focuses more on energy relations and dynamics of chemical systems, including chemical thermodynamics, chemical kinetics, and electrochemical systems (Levine, 2008). All of the above laboratory or theoretical chemistry when applied to soil systems is then called soil analysis, soil biochemistry, soil inorganic chemistry, soil organic chemistry, and soil physical chemistry, respectively. The exception is the term *geochemistry* that geologists and several other people insist on using to replace the term *soil chemistry*. The term *geochemistry* is often extended to become biogeochemistry. The combination of soil biochemistry and soil inorganic and organic chemistry is, in fact, soil chemistry.

## 1.3 THE CONCEPT OF SOIL PHYSICAL CHEMISTRY

A number of scientists prefer using the term *soil physical chemistry* instead of *soil chemistry*. It is perhaps acceptable in a limited sense, because soil physical chemistry is addressing not all, but only part of the chemical processes occurring in soils, in addition to using the term *physical* differently than normally defined. The term *physics* originates from the Greek *physis* or *physikos*, which in the early days of the Greek philosophers referred to a philosophical concept of the matter and energy of earth. This led to the creation of the atomic theory by Democritus in 460 BC, suggesting that matter is composed of atoms (Greek *atomos* = indivisible), the smallest particles on earth. After being forgotten and ignored for almost 2000 years during the period of the Roman Empire, the atomic theory was revived by John Dalton in 1803. Since then, the term *physics* has been expanded to include heat, sound, mechanics, electricity, magnetism, radiation, and nuclear science. It can also mean the profession and practice of medicines.



The emphasis of the books published on soil physical chemistry is on the chemistry of double layers, adsorption and equilibrium reactions, and their statistical modeling (Sparks, 1999). As indicated by the name, one would expect to see the principles of physics being addressed underlying the soil chemical processes (see definition in Section 1.2). But, the adsorption and equilibrium reactions are too remote and far related to the fields of physics as stated above. The heavy use of statistics or calculus in deriving double-layer equations, considered by Ivy League scientists a cornerstone in thermodynamics and quantum chemistry and hailed by many students, has in fact discouraged or shied away many potential users. Chemical kinetics is also more focused on chemical reactions and on principle is concerned with the speed or rate of reactions. This science of kinetics is founded on the famous *law of mass action* as formulated in 1865 by Guldberg and Waage, which will be explained in Chapter 4 in more detail. The physical factors underlying the speed of reaction are temperature and pressure. In contrast to kinetics, thermodynamics and free energy concepts, frequently included with soil physical chemistry, determine the probability of reactions to occur. The reaction is more likely to take place if the free energy change ( $\Delta G$ ) is negative, will be at equilibrium when  $\Delta G$  is equal to 0, and will not occur if  $\Delta G$  is positive.

Another aspect of soil physical chemistry is the issue of soil physics, which typically deals with the study of particle size, sand, silt, and clay, their distribution and properties in soils, soil texture, soil classes, soil consistence, soil pore spaces, particle density, bulk density, issues on soil temperature and soil moisture, and more. Hence, in view of the name, it is perhaps more than reasonable to expect that soil physical chemistry should be dealing with the chemistry underlying the soil physical properties above rather than addressing topics of adsorption and rate of reactions, which are plain chemical issues.

## 1.4 THE CONCEPT OF GEOCHEMISTRY

Geochemistry is also, for some reason, another name preferred by geologists and several soil scientists for replacing the name *soil chemistry*. As indicated in Section 1.2, *geochemistry* is the chemistry of geological material present on the earth, produced from the earth's molten materials, magma and lava. It is the chemistry underlying *geology* or *geoscience*, the science of the history of earth, addressing diagenesis, metamorphism, hydrothermal deposition of ore and minerals, and the like (Krauskopf, 2003; Merriam-Webster, 2003; Walther, 2009). A review of geochemical processes and pathways is provided by McSween et al. (2004).

Previously, soil science was considered part of geology, as indicated by Robinson (1924), who considered *pedology* (Greek *pedon* = "soil") to be a branch of *geology* (*geo* = "ground, earth"). At that time, geologists tended to regard soil as dirt, covering the rocks and minerals, (Milner, 1952). However, today *soil science* is distinctly different from *geosciences* or *geology*. Though a close relation is still present, soil science has developed in a different direction than geology. *Pedology*, one branch of soil science, is the science of soil formation and soil classification. The weathering of rocks and minerals to produce soils is called *pedochemical weathering*. The soil formed is characterized by a *soil profile*, composed of several soil horizons from the surface down to the parent material, and the identity of the rock has disappeared. In contrast, geology is concerned with the solidification processes of magma and lava, yielding the various rocks and minerals, as indicated above. The weathering of these rocks and minerals in geological terms is called *geochemical weathering* and results in the formation of *saprolites* (unconsolidated disintegrated rock, lying in its original place) and *regoliths* (unconsolidated weathered rock, resembling loose earth material above the bedrock). Both are considered parent materials for soils. Pedochemical weathering takes place on the earth surface, whereas geochemical weathering normally occurs deep below the surface of the earth, in soil science terms below the solum or pedon. The chemical composition and characteristics of mineral and rock formations are the traditional domains of geology. An example of the chemical significance underlying petrography is provided as follows. The earth's crust contains approximately 47% oxygen, which occurs mostly in the form of oxides (e.g., silica, alumina, and

iron oxides). Magmas, with  $\text{SiO}_2$  contents of 65% to 75% and relatively low in alkalis (K, Na, Ca), will form acidic rocks. Upon solidification, the excess silica will crystallize into quartz; hence, acid rocks are often characterized by high quartz contents. In contrast, geologic materials low in silica ( $\text{SiO}_2$  contents between 40% and 50%) and relatively high in Fe, Ca, Mg, and K will yield basic rocks, where quartz minerals are absent. Geologic materials with  $\text{SiO}_2$  content in between the acidic and basic composition usually produce intermediate rocks.

## 1.5 THE CONCEPT OF SOIL CHEMISTRY

As discussed above, many names have been used for *soil chemistry*. At the onset, it is “the study of chemical characteristics of soils, with a tendency later on toward applications in (1) *edaphology*, the science of plant nutrition and plant growth, and (2) *pedology*, the science of soil formation or soil genesis” (Tan, 2009). With the environmental movement, expressing concerns on environmental degradation in the 1970s, the focus shifted toward issues of organic and inorganic contaminants and pollutants endangering environmental and human health. Names of *environmental soil chemistry*, *environmental chemistry*, *green chemistry*, and the like surfaced. The question is now often raised whether these new names can be used as the perfect synonyms of soil chemistry or perhaps can even be considered as superior alternative names. Therefore, an attempt is made below to analyze the term *soil chemistry*, and the ensuing discussion, based on rationale, is the opinion of the author.

*Soil* is by definition “an integrated mixture of inorganic, organic matter, water and air, called the four soil constituents” (Brady, 1990). The chemistry of these soil components, their composition, structures, mutual interactions, and interactions with the biospheres, hydrospheres, and atmospheres, can then for all practical reasons be called *soil chemistry*. The inorganic soil fraction, often called the *mineral fraction*, is by convention considered to be sand, silt, and clay. Rock and gravel are geologic materials but may form sand, silt, and clay upon pedochemical weathering. The chemical composition, structure, physicochemical properties, crystal characteristics, and electrochemical properties of sand, silt, and clay are the domains of *soil mineralogy*. However, the chemistry and electrochemical properties of clays resulting in adsorption and exchange reactions were in the early days called *colloid chemistry*, but today they are often claimed to be *geochemistry*. By virtue of their pedochemical origin, they truly are the science of soil chemistry. Organic matter, composed of dead organic remains, decomposed organic matter, the humus, including humified products (e.g., humic and fulvic acids), and a huge live biological population belong rightfully to *soil microbiology*. But the chemistry of the soil organic fractions above is *soil biochemistry*, and as defined earlier (see Section 1.2), the latter is part of soil chemistry. The *soil organic fractions* are inherent environmental features, providing the environmental basis to soil chemistry. This biological basis also includes the vital biochemical reactions, such as nutrient cycling and carbon and nitrogen cycling, which keep the soil alive. The *soil liquid phase* is the third essential soil component of importance in soil chemistry. This is the place where most of the chemical reactions take place. Simply called *soil moisture*, it nourishes plants and microbial growth. It contains the dissolved substances, ions, and solutes, creating a soil–root system, closely resembling an electrochemical cell, where ion and water movement, dissolution, dissociation, availability of elements to roots, oxidation, and reduction of elements are controlled by electrochemical potentials. In addition, the ions and solutes interact mutually and with the solid inorganic and organic fractions, by means of adsorption, exchange, ligand exchange, bridging, and chelation reactions. Dissolved gases may participate in or strongly influence the many chemical reactions. Dissolved oxygen acts as a powerful oxidant, and dissolved  $\text{CO}_2$  (carbon dioxide) affects changes in acidity of the aqueous medium. Often expressed in terms of BOD (biological oxygen demand), dissolved oxygen is used as an indicator for pollution, whereas dissolved  $\text{CO}_2$  plays an important role in determining soil pH. *Soil air*, the fourth soil constituent, is the place for oxygen supply and for removal of excess carbon dioxide, produced by respiration of plant roots and microorganisms. Anaerobic and aerobic decomposition, the latter an essential reaction in the carbon cycle, are dependent on the oxygen content in soil air. All the above and more

are essentially the domains of soil chemistry but are often claimed today to be geochemistry or soil physical chemistry.

Recently, *environmental chemistry* and *green chemistry* are recognized as two new sciences in pure chemistry. They have been created in reaction to the increasing environmental degradation starting in the 1970s. Under pressure of the environmental movement, soil scientists all over the United States were scrambling to follow suit by creating *environmental soil chemistry* (Sparks, 2002) for the application of environmental chemistry in the soils ecosystem, but surprisingly, the title of *soil green chemistry* or *green soil chemistry* has yet to appear. Using the words *environmental* and *green* in pure chemistry is essential for indicating the purpose and differences from the other chemistry branches, in view of the theoretical nature of laboratory chemistry. However, in soil science, it goes perhaps a little overboard to use the term *environmental soil chemistry*, because soil systems and their biochemical reactions are inherent to the natural environment. Although soil chemistry alone entails the connotations that environmental issues are included and considered, nevertheless it seems to be justifiable to say *environmental soil chemistry*. It can always be argued that the first word is used to reinforce the focus on environmental issues, though the question still lingers that the name is as redundant as, for example, *soil pedon* (meaning “soil soil”), because *pedon* (meaning “soil”) alone is sufficient.

The term *environmental chemistry* has been defined in the school of chemistry as the “chemistry of matter in the environment (air, water, and soil systems), its source, reactions, transport and its influence on biochemical phenomena in nature” (Manahan, 2009). Note that the factor “soil” is included, which should take care of the soil’s ecosystem, but the study of soils is not the domain of the school of chemistry, but rather of soil science. The popular book *Environmental Chemistry* (Manahan, 2009) provides meager details on soils, and its use as a soils textbook by some professors in their soil classes makes it difficult to justify the quality of such a soils education. Manahan’s book is excellent for the school of chemistry and would perhaps be a good reference for additional reading in a soils curriculum. *Green chemistry* differs from *environmental chemistry* because of its focus on chemical contaminants, pollutants, and toxic compounds, seeking to stop potential pollution of the environment at its sources. The U.S. Environmental Protection Agency (US-EPA) recognizes 12 principles of green chemistry. Three of the principles, illustrating explicitly the purposes stated above, are quoted here:

- (1) Prevent waste by designing synthesis leaving no waste for treatment and cleanup;
  - (2) Design safer chemicals and products that are fully effective with little or no toxicity;
  - and (3) Design less hazardous chemical synthesis that generates substances with little or no toxicity to humans and the environments.
- (Anastas and Warner, 1998)

For more details, refer to Anastas and Warner (1998). The information can also be obtained from the US-EPA Web site at: <http://www.epa.gov/greenchemistry/> (last accessed November 18, 2009).

---

# 2 Overview of Basic Chemical Principles and Units

## 2.1 ATOM AND ATOMIC STRUCTURES

*Quantum mechanics* or *quantum physics*, the science of atomic and subatomic systems, is the underlying principle of many fields in physics and chemistry (Scarani and Thew, 2006). It is required for understanding the behavior of systems at atomic and subatomic dimensions. This field of science was established during the beginning of the 20th century by a number of scientists, including Albert Einstein, Max Planck, and Niels Bohr. It is the theory explaining why atoms are stable and why the electrons never collide with the nucleus but remain in orbit moving around the nucleus, defying the *Law of Newton* (Serway et al., 2009). It also explains how atoms can change and form elements and molecules, all processes affecting the fate of chemical reactions. This is then why it is deemed important to start discussion in this book, *Principles of Soil Chemistry*, with atoms and atomic structures. It is about the “principles” of soil chemistry, isn’t it? Atoms, their structures, and how they behave in chemical reactions are principles underlying the science of chemistry. As explained in Section 1.2, chemistry is basically concerned with studying the properties of matter, composed of atoms and the transformation of these atoms into elements, ions, molecules, and salts. The theory goes that an atom is the smallest particle of an element that can enter into a chemical combination. Atoms of the same elements are similar in composition, but one element differs from the other in size, position, and movement of its atoms. An element is a substance composed of atoms with the same atomic number, or nuclear charge. In solid matter, the atoms vibrate within the confines of very small spaces, whereas in a gas the atoms exhibit a considerable range of movement. This concept of atoms being the smallest particles of matter was first postulated by Democritus or Leucippus, Greek philosophers, in approximately 425 BC. The term *atom* comes from the Greek *atomos*, meaning indivisibly. However, it was not before *Dalton’s atomic theory* was formulated in the first decade of the 19th century that this idea became scientifically established (Roscoe and Harden, 2008). Though John Dalton (1808) is generally credited as the founder of the atomic theory, he only revived the Greek atomic hypothesis and gave it scientific credibility (see Section 1.3). Since then, Crookes, Thomson, and others, around 1897, working on the conduction of electricity in rarified gases, made revisions in the theory and concluded that the atom was composed of still smaller particles. By the turn of the 19th century, it became known that the atom was composed of the following components:

1. *Electrons*, small negatively charged components of atoms of all substances
2. *Protons*, positively charged particles of much greater mass than electrons

With the advancement of science in the 20th century, it became clear that atoms also contain *neutrons*. The neutrons have a mass number of 1 but have zero (0) charge. Less fundamental particles were also detected, the *positrons*. Positrons are particles with the mass of an electron and the charge of a proton.

## 2.2 PARTICLE ACCELERATORS OR SYNCHROTRONS

With incredible developments in technology, it becomes evident that the atom can no longer be considered the smallest particle of matter in nature. Especially since the development of atomic smashers, many other subatomic particles have been detected or are produced by cracking the atoms and their constituents into pieces. Nuclear physicists prefer to call these machines atomic or particle accelerators or synchrotrons, modified cyclotrons in which subatomic particles are propelled by electric energy enforced by a magnetic field (Afanasiev, 2004; Appelquist, 1986; Gaillard, 1983, 1986; Glashow, 1986; McCarthy and Norum, 1986; Orr, 1986; Richter, 1986). By pounding or pummeling the atom with fast-moving subatomic particles in an atomic accelerator, the atom's central part, the nucleus, is torn apart into smaller particles. The smaller the particles to be obtained, however, the more powerful and costlier must be the machines. Depending on the energy created and the production of an ever increasingly smaller division of particles, the atomic accelerators can be distinguished into:

1. Megatrons, capable of accelerating protons to 1 mega (million) electron volts ( $1 \text{ MeV} = 1 \times 10^6$  electron volts).
2. Gigatrons, capable of accelerating protons to 1 giga (billion) electron volts ( $1 \text{ GeV} = 1 \times 10^9$  electron volts).
3. Tevatrons or teratrons, the largest and highest-energy proton synchrotron in the world, capable of accelerating protons to 1 tera (trillion) electron volts ( $1 \text{ TeV} = 1 \times 10^{12}$  electron volts).

Four of the most powerful types of particle accelerators, in the United States and one in Europe, in operation today, include: (1) The *SLAC linear collider* or *SLC*, at the Stanford Linear Accelerator Center in California. (2) The *CEBAF collider*, proposed in 1982 to be built in the 1990s at the Continuous Electron Beam Accelerator Facility, at the former site of the NASA Space Radiation Effects Laboratory, Newport News, Virginia. It has operated since 2000 at the Thomas Jefferson Accelerator Facility by the Jefferson Science Association in cooperation with Computer Science Corporation. (3) The *Tevatron*, now in operation at the Fermi National Accelerator Laboratory near Batavia, Illinois. (4) The *RHIC Synchrotron* or *Realistic Heavy Ion Collider* at Brookhaven National Laboratory in Upton, New York. (5) The *CERN* (Center for European Nuclear Research) *LHC* (*Large Hadron Collider*) in Geneva, Switzerland, considered the world's largest accelerator (Kestenbaum, 2007).

### 2.2.1 THE STANFORD LINEAR ACCELERATOR

The *SLAC collider* is an electron–positron beam collider consisting of two linear accelerators. Because the beams are fired in a linear path, no synchrotron radiation is produced. It is a powerful instrument that is capable of accelerating the speed of electrons or positrons to an energy level of 1.2 GeV, reaching 51 GeV at the end. Linear accelerators of similar or greater capacities are also in construction in Europe, Russia, and Japan. The concept that protons are composed of subatomic particles was developed for the first time at the Stanford Linear Accelerator Center following the discovery of electron scattering after its collision with a proton. Armed with sufficient energy, the electron can penetrate the proton and resolve its composite structure by bouncing away (scattering) as a result of collision with a proton constituent.

### 2.2.2 THE CONTINUOUS ELECTRON BEAM ACCELERATOR AND ELIC

The *CEBAF collider* is also an electron accelerator in the GeV energy range, and was built in the 1990s by the Southern Universities Research Association (SURA) with funds allocated by the U.S.



Department of Energy (DOE), and is now in operation. It is a combination between a linear accelerator and a ring collider, called a *pulse stretcher ring* (PSR); hence, it is a blend between a SLC and a synchrotron. The SLC is used to accelerate the speed of an electron, which is then accelerated further in the PSR. No other particles are more suited than electrons for probing the atomic nucleus. Electrons have been used in the study of a wide variety of materials (e.g., atoms, atomic nuclei, and subatomic particles) because of their well-known interactions and absence of an internal structure. Plans were drawn in 2001 to upgrade the CEBAF with an *Electron-Ion Collider* (ELIC), making it possible to investigate hadrons, the structural components of matter.

### 2.2.3 THE FERMI NATIONAL LABORATORY ACCELERATOR

The Fermi National Laboratory *tevatron* is an accelerator composed of a tunnel in circular form, hence the name cyclotron or synchrotron. In the Fermi Laboratory, the tunnel is built 9 m below the soil surface and is almost 6 km in circumference. This synchrotron is using protons, instead of electrons, as projectiles. Acceleration of the movement of protons is achieved by the use of a system of superconducting magnets, composed of 2000 electromagnets cooled at a temperature of  $-268^{\circ}\text{C}$ . At this temperature, the electromagnets become superconductors, meaning that they do not exhibit any electrical resistance. During its circular movement in the tunnel, the proton energy is increased by increasing the electromagnetic field. After approximately 750,000 rounds in the 6 km tunnel, the proton energy has reached a level of 1 TeV at a magnetic field of 4.5 T (45,000 G). At the Fermi National Accelerator Laboratory, nuclear physicists can literally tear apart the fabric of matter with its *tevatron*. The *Higgs boson* is one of the continuing active research programs at the Fermi laboratory.

### 2.2.4 THE BROOKHAVEN REALISTIC HEAVY ION COLLIDER

The *RHIC* or *Realistic Heavy Ion Collider* was allegedly the newest and biggest synchrotron until in 2008 the *Large Hadron Collider* of CERN went into operation. The RHIC is located at the Brookhaven National Laboratory in Upton, New York, a facility established in 1947 at Camp Upton, a former U.S. army base. It is operated by an alliance between Stony Brook University and Battelle Memorial Institute under the name of *Brookhaven Science Association*. The particle accelerator in the *tevatron* category is capable for investigating quark–gluon plasma materials. A center for studies in nuclear medicines and human genetics was also incorporated. Currently, the Brookhaven facility is participating in the *ATLAS project*, proposed by CERN to start in spring 2009. It is an experiment involving head-on collisions of protons, accelerated to extraordinarily high levels of energy. It is hoped that the results reveal more information about matter and the basic forces that have shaped planet earth and the universe since the beginning of time. More about ATLAS will be given below.

The RHIC synchrotron has apparently replaced the older version at the Brookhaven National Laboratory called the *cosmotron*. The *cosmotron* was built in 1948 with funds from the U.S. Department of Energy and was capable of accelerating protons at energy levels comparable to those of cosmic rays showering the outer atmosphere of earth, hence the name *cosmotron*. It allegedly reached its full capacity at 3.3 GeV in January 1953.

### 2.2.5 THE CERN TEVATRON

In addition to the Fermi and Brookhaven *tevatrons*, another, perhaps bigger, *tevatron* is present at the Center for European Nuclear Research in Geneva. Established on September 29, 1954, by 12 European countries, with the United States and Japan as major non-European contributors, the center is known today as *CERN* (*Conseil Européen pour la Recherche Nucléaire*). Fermilab's European rival, CERN, discovered the building blocks of neutrons and protons. High-energy collisions

between two protons in the tevatron reveal that protons can be broken into even smaller particles, *quarks* and *gluons*. A subsequent discovery of *bosons* by Simon van der Meer and Carlo Rubbia was another achievement in particle physics at CERN, for which the two physicists above were awarded the 1984 Nobel Prize. Built by the European Council for Nuclear Research beneath the Jura and Alps mountains, at the French–Swiss border near Geneva, the CERN tevatron is known also by the name of *LHC* or *Large Hadron Collider*. The name *hadron* (from the Greek *hadros* = “thick”) refers to bound quarks in the form of protons and neutrons. With a 27 km circumference tunnel, the CERN LHC is considered the world’s highest-energy particle accelerator in operation today. A great ambitious research program, called the *ATLAS experiment*, has already been mapped to start in 2008. Scientists are anxiously expecting to be able to recreate the *big bang* reaction, like the one proposed to have happened in the early development of earth and our solar system (Allday, 2002). The high-energy collisions, shattering the protons, are hoped to yield the *quark–gluon plasma*, *Higgs bosons*, and other extremely small particles. These and many more possible surprises may provide exciting revelations about the origin of mass, the presence of *antimatter*, and the existence of *dark matter*. Expectations are high to find the pieces of the puzzle for the true makeup of matter, and obtaining proof of the existence of the *graviton*. Rampant safety questions, presented at first concerning conceivable threats from the particle collisions, have somewhat overshadowed the importance of the LHC. Fears were raised by critics that the high-energy collisions may result in the production of *mini black holes* and other strange matter, starting “doomsday” reactions on earth. *Black holes* are thought to possess extremely powerful gravity fields that may absorb or attract all masses on earth, even electromagnetic radiation or light. However, the CERN safety commission indicated that there is no danger because the LHC energy is perhaps too low for creating a mini variety of the feared planet-gobbling black holes of the universe, a conclusion supported by the American Physical Society (Ellis et al., 2008). The thousands of elementary particles produced by a mini “big bang,” imitating a *supernova*, occur only a split second before they are gone. The mini black holes, if produced, are expected to vaporize quickly as bright flashes of gamma radiation. The LHC was fired on September 10, 2008, to test the superconducting magnets, but testing was soon aborted because of a transformer glitch that raised the operating temperature from 0–1 K to 4.5 K, a temperature, though extremely low, still allegedly too warm for the electromagnets to operate properly. Nevertheless, the unfortunate incident, causing naturally some disappointment among the many participating scientists, allegedly affected the Atlas project only somewhat. It can continue by collecting data from cosmic rays while awaiting repair of the LHC. During most of 2009, the LHC was under repair, which appeared to be successful because on March 30, 2010 at 13:06 Central European time, reports were distributed from CERN in Geneva of a test run with a beam collision at 7 TeV, “They’ve had a collision” (*Time*, 2010, p. 16). This marked a renewed start of the Atlas program as the LHC began its first long-run; CERN hopes to run the LHC for 18 to 24 months and obtain sufficient amounts of data for scientists to analyze and ponder for about a year or two. Following this run, the LHC will be shut down again to complete repairs as a result of the transformer malfunction as stated above. The LHC is usually operated on an annual cycle with 4 to 5 months of shutdown each year. It takes a month or so to bring the temperature up to room temperature and because of its cryogenic operating requirements it needs another month to cool down (*Science Daily*, 2010).

### 2.3 ELEMENTARY PARTICLES

In the atomic accelerators, not only have the building blocks of protons and neutrons been discovered, but new forms of matter can also be produced. These smallest particles on earth are today called *elementary particles*, which, in fact, include both atomic and nonatomic components. According to our knowledge today, these subatomic particles are composed of six types of quarks and six leptons. In the *Standard Model of Particle Physics*, quarks and leptons are considered to be point-like subatomic particles and are recognized as the main constituents of all matter. In addition to the above, the theory also suggests that four fundamental forces are present on earth and the universe for holding

everything together in matter. They are *gravity*, *electromagnetic*, and *weak* and *strong nuclear forces*, each of them viewed as carried and produced by elementary particles. The *graviton* is in essence a nonatomic particle associated with gravity, whereas the *photon* is an electromagnetic radiation particle or a particle of light. These forces together with the nuclear forces are responsible for holding atoms and molecules together. The major types of elementary particles and forces are described below in more detail.

### 2.3.1 QUARKS

Protons and neutrons are traditionally considered the elementary constituents of the atomic nucleus. They are collectively called *baryons* or *hadrons*. However, it is now established beyond doubt that all baryons can be broken down into more elementary constituents, the *quarks*. Protons, as now understood, are not elementary particles, but rather bags, containing *quarks* and *gluons*, held together by the *strong nuclear force*. They are the heavy components in atoms. Many types of quarks have been identified, including b-, c-, d-, and t-quarks. However, today they are differentiated into three *generations* of quarks, among which the *up* and *down quarks* are the only quarks of importance in normal matter. A proton is composed of two up-quarks and one down-quark, whereas a neutron is made up of two down-quarks and one up-quark. The quarks are confined inside the hadrons by very strong force fields; hence, individual quarks cannot exist. This is one reason why it is not possible to measure the masses of quarks.

The nuclear force responsible for binding the atomic nucleus together is attributed to the interaction between quarks and gluons. The quarks are bound inside the nucleus by a force transmitted by gluons. Gluons are believed to be carriers of the color charge, which is similar to an ordinary electric charge.

### 2.3.2 LEPTONS

*Leptons* are a group of elementary particles composed of electrons, muons, neutrinos, and tau electrons (taun). The *tau lepton* was discovered in 1975 by the Stanford Linear Accelerator Center (SLAC) in California. Leptons can exist on their own and are not affected by the strong nuclear forces. In contrast, quarks are confined in hadrons and can only exist in a combination that is strongly affected by the strong nuclear forces. In particle physics' language, both quarks and leptons are point-like particles of spin  $0.5h/2B$  (where  $h$  is Planck's constant) and are considered the constituents of all matter. Sometimes the term *spin 1/2 particle* is used for leptons, referring to particles capable of a  $360^\circ$  change in spin orientation. Because of this, leptons are also called *fermions*.

#### 2.3.2.1 Electrons

*Electrons* are the best-known leptons. They are the light components of atoms and are less numerous in types than quarks. An atom is formed by binding electrons with the atomic nucleus. The binding force is transmitted by *photons*, the *quanta of the ordinary electromagnetic field*. It is the *weak force* as opposed to the strong nuclear force holding the nucleus together.

#### 2.3.2.2 Neutrinos

In contrast to electrons, which are charged leptons, *neutrinos* are *neutral leptons* (Giunti and Kim, 2007). At first, three types of neutral leptons, collectively called neutrinos, were discovered in cosmic rays, in the form of waste energy from nuclear reactors, in the form of decay products of radioactive material, and as intense beams produced by high-energy particle acceleration. However, nine types of neutrinos have been recognized: *cosmic*; *geophysical*; *solar*; *supernova*; *atmospheric*; *astrophysical*; *G,K*; *exotic*; and *dark matter, annihilation neutrinos*, from the sun or center of the earth (De Rujula, 1983). Physically, neutrinos are not components of atoms or molecules but are



force carriers like photons. Believed to be the constituents of electromagnetic radiation or light, it is rather strange why they are grouped as leptons, the constituents of matter.

As indicated by Galileo long ago, light is a messenger from the stars, and no other form of communication than light is present in the universe contacting earth. This messenger in the form of neutrinos may enable us to see the universe in a completely different way. Currently recognized to play an important role in the universe, neutrinos are essential to the *nuclear fusion* that powers the sun. They are important ingredients in the *beta-process*, by which hydrogen can be transmuted into various elements found on earth. In the absence of neutrinos, the earth would exist as a solid ball of frozen hydrogen.

Neutrinos find practical applications in the exploration for fossil fuel and mineral deposits buried deep below the earth's surface. However, only neutrinos with a very high energy level of 10 TeV, such as produced by a synchrotron, can be used for these geological investigations, because the beam must be able to penetrate to great depths and must produce measurable and interpretable signals after collision. Four projects have recently applied intense neutrino beams, produced by a particle accelerator, to probe the remote interior of the earth for oil, gas, and mineral deposits, for example, the *GENIUS*, *GEMINI*, *GEOSCAN*, and *LUNASCAN* projects. Because of their sensitivity, these methods are intended to replace the conventional *reflective sonic seismology*, which uses sound produced by explosion or by truck-mounted vibrators. Some scientists believe that neutrinos provide the key to the eventual discovery and recovery of mineral and fossil fuel deposits buried deep below the earth and oceans.

#### 2.3.2.2.1 *The GENIUS Neutrino Project*

The *Geological Exploration by Neutrino-Induced Underground Sound* (GENIUS) is a project developed for the explorations of deposits of gas and oil buried deep beneath the surface of the earth. It is based on the interactions of a great number of neutrinos, moving as an underground beam, to produce a clear sound signal. The method is reported to be very sensitive for the detection of trapped underground fluids, because upon collision a loud sound signal is produced. The signal is louder when the neutrino beam hits a rock substrate permeated with oil and gas than when the beam hits a dry rock substrate.

#### 2.3.2.2.2 *The GEMINI Neutrino Project*

The *Geological Exploration by Muons Induced by Neutrino Interactions* (GEMINI) has been designed for prospecting distant deposits of ore buried below the earth's surface. The project is important especially for the detection and mapping of mineral ore deposits, such as copper, lead, and uranium deposits. The accelerator probe injects a neutrino beam deep into the earth. *Muons* are produced from nuclear collisions of the neutrinos, and truck-mounted muon detectors are positioned at locations where the beams reemerge from the earth. The significance of the surface measurements is affected by the number of neutrino-induced muons produced in the final leg of their underground travel.

#### 2.3.2.2.3 *The GEOSCAN Neutrino Project*

Similar in design to the GEMINI is the *GEOSCAN* for *Geological Scanning*, a project still at the experimental stage. It also employs neutrino and muon beams, but the beams are directed vertically. This method is used for sea bottom exploration. The accelerator and muon detectors are mounted on a ship. The significance of measurements is influenced by the vertical angle and by the energy of attenuation as the neutrino beam travels to the sea bottom.

#### 2.3.2.2.4 *The LUNASCAN Project*

The *LUNASCAN*, another project on the drawing board, differs from the GEOSCAN only in that it directs high-energy neutrino beams toward the moon. A vertical profile of the density of the moon is supposed to be obtained by this method.

### 2.3.3 FORCE CARRIERS: BOSONS AND MESONS

As indicated earlier, four fundamental forces are recognized on earth and in the universe for holding everything together in matter—*gravity*, *electromagnetic force*, and *weak* and *strong nuclear forces*. Each is considered carried also by fundamental particles. *Photons* are carriers of electromagnetic radiation or particles of light, as are neutrinos as discussed above. The force of gravity is also assumed to be carried by an elementary particle, called earlier the *graviton*. Some people call these force carriers *bosons*. In scientific language, bosons are light particles, obeying the Bose–Einstein statistics. Composite bosons are often called *mesons*. Two bosons of similar energy levels can occupy the same place in space, but fermions, being matter, cannot. The fermions obey the *Fermi–Dirac* statistics.

The *photons* are the best-known force carriers or field quanta. They are massless elementary excitation particles of the electromagnetic field, or in plain language they are components of our ordinary light, visualized as particles. Many types of photons can be distinguished depending on the type of light (e.g., photons from X-rays, photons from microwaves, photons from infrared radiation, photons from ultraviolet waves, and others). Although physically they are not components of atoms, the force transmitted by photons is responsible for binding electrons with nuclei to form atoms as indicated before.

The *graviton*, a massless spin-2 particle carrying the force of gravity, the force affecting all of us on earth, appears to be the most difficult to explain. At the present, no concrete evidence has been presented for the existence of a graviton, and the hope for finding a quantum theory of gravity has remained for years one of the most elusive issues in physics. Nevertheless, many scientists have high hopes of eventually finding some proof of its existence from the collision experiments in the LHC of CERN in Geneva.

## 2.4 STRING THEORY

Because the Standard Model concept of atoms, composed of electrons swirling around a nucleus of protons and neutrons, neither explains nor describes the involvement of the force of gravity and Einstein’s theory of relativity, great efforts have been made to develop a concept that applies to the fundamental particles as well as to all forces in nature, called the *Theory of Everything* (Barrow, 2008). After research in this direction was halted since Einstein’s death, the issue flared up again when astronomers, probing the distant reaches of our universe, discovered the *black holes*. Black holes are described as condensed balls of gigantic masses of matter possessing a gravitational force so strong that even light is attracted and absorbed, and hence everything becomes black. To explain all these in connection with the particle concept, a new theory has been emerging since the 1970s, known as the *String Theory* that some believe may unify the forces of nature (Greene, 1999, 2003). During the years since its inception, many variations have been advanced, such as the *superstring theory*, *multidimensional theory*, including the “brane,” M-theory, bosonic, I, IIA, IIB, HO, and HE versions (Polchinski, 1998), all bent on finding “the theory of everything.” A critical review was later provided by Polchinsky (2007) on this string theory, expressing his concerns on its validity and compatibility with existing atomic models.

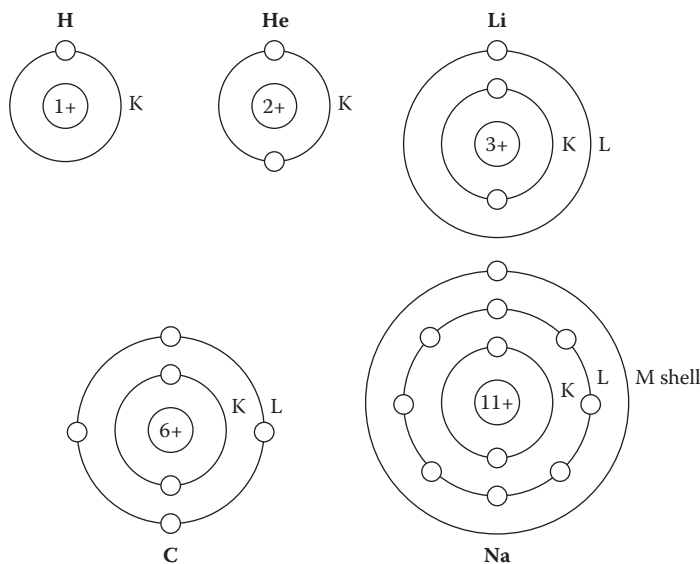
Because the new theory is very complex, often mind boggling and difficult to read, the present author tries to generalize it below using simpler, everyday language. In essence, it is an attempt to replace or unite the principles of point-like particles, advocated by the Standard Model, with the idea that the elementary particles are in fact tiny vibrating loops of strings. It just depends on the way of viewing the materials. For example, an electron when viewed from a distance can be seen as a tiny point-like particle with zero dimensions. However, many believe that at closer distance the electron is seen as a dense cloud. Suppose our rapid advancing technology allows for building an electron microscope, a thousand to a million times more powerful than the ones present today, enabling observations at very close range, and then that same electron may well be seen as a tiny

loop of a string, vibrating at a specific *resonance frequency*. The length of the string is allegedly  $10^{-35}$  m, the *Max Planck length*. The advantage of the string theory is that strings can move and also oscillate in different directions, whereas point-like particles can only move. Strings can also move through space and time and explain why bosons will pass through one another when directed at each other, as happens with two light beams. On the other hand, a head-on collision will take place when particles of matter are directed at each other, like hadrons or fermions colliding in an accelerator or on a macro scale the head-on collision of two automobiles, because they (matter) are not capable of occupying the same space at the same time. This new theory may provide a solution for the creation of a quantum gravity concept, compatible for unifying it with the current standard model particle concept. However, as it stands now due to lack of concrete evidence, more research and testing have to be done for scientists to arrive at a general consensus.

## 2.5 THE ATOMIC MODEL OF RUTHERFORD AND BOHR

Although a lot more is known currently on subatomic components, the *atomic model*, as proposed by John Rutherford and Niels Bohr (Cragg, 1971; Garrett, 1962; Hall, 1966), is still prevalent today. It represents the modern idea of the atomic structure, which provides a reasonable explanation for many phenomena in atomic physics, chemical reactions, and valences. According to this model, the fundamental particles of the atom are *electrons*, *protons*, and *neutrons*. Protons and neutrons are located in a small central portion of the atom called the nucleus. The nucleus is of high specific weight and contains most of the mass of the entire atom. The mass of electrons is very small and can be neglected. The various groups of electrons are placed in concentric shells around the nucleus. The shells may be composed again of subshells or cells. Neglecting the presence of subshells, the shells may contain one electron as is the case with a hydrogen atom, or two electrons as is the case with a helium atom, or more (Figure 2.1). The first shell adjacent to the nucleus is called the *K shell*, whereas the shell next to it is designated as the *L shell*, and so on. The densest atom is the uranium atom ( $^{238}\text{U}$ ), with 92 electrons distributed around the nucleus in K, L, M, N, O, P, and Q shells.

The diameter of the nucleus is between  $1 \times 10^{-13}$  and  $1 \times 10^{-12}$  cm. Whereas the nucleus carries an integral number of positive charges, or integral number of protons, each of  $1.6 \times 10^{-19}$  C, each



**FIGURE 2.1** Atomic structure showing the K, L, and M electron shells.

electron carries one negative charge of  $1.6 \times 10^{-19}$  C. This value is generally known as the electron charge (e).

The electrons in the inner shells are tightly bonded to the nucleus. This inner structure can be altered by bombardment with high-energy particles, and the resulting excitation of electrons in the K shell may result in emission of  $K\alpha$ , and  $K\beta$  radiation, called *x-rays* or *roentgen radiation*. With most atoms, the arrangement of energy (electrons) in the outer shells undergoes changes during chemical reactions. These outer shell electrons, called *valence electrons*, are responsible for the chemical properties of the atom. During these changes, the role of the nucleus is usually passive. The hydrogen atom is perhaps an exception, because it has only one shell and one bare proton.

Because an atom is electrically neutral, the total positive charge in the nucleus must equal the total negative charge of the electrons. An atom that loses one or more electrons from the outer shell assumes a net positive charge and is called a *cation* (Faraday). When an atom has excess electrons, not balanced by the positive charges of the nucleus, it assumes a net negative charge and is called an *anion*.

## 2.6 MASS AND WEIGHT

### 2.6.1 Mass

The term *mass* refers in essence to a quantity of matter contained in a body. However, the scientific definition of mass is far more complex than that stated above, and a number of very different definitions exist. In basic chemistry, mass is formulated as follows:

$$\text{Mass} = \text{Volume (mL)} \times \text{Density (g/mL)}$$

In physics, the *second law of Newton* defines mass as:

$$F = ma \text{ or } m = F/a$$

where  $F$  is the force acting upon a body of matter,  $m$  is the mass contained in the body, and  $a$  is the acceleration. Traditionally, the above equation is interpreted as the force, giving the body certain acceleration, is a measure of mass. On the surface of the earth it can be argued that  $a = 1$ ; hence,  $F = m$ .

### 2.6.2 WEIGHT

*Weight* ( $w$ ) pertains to the force of attraction of the earth for the body. This force is dependent upon the distance the body is from the center of the earth. On the surface of the earth, mass equals weight, because the body is close to the center of gravity. As indicated by the second law of Newton above, the acceleration,  $a$ , equals 1 on the earth's surface; hence, the force  $F = m = w$ . In space, the body is weightless, but the mass remains the same. The unit of mass in the *International System of Units* (SI) is the *kilogram* (kg).

In soil chemistry, the terms *atomic mass*, *atomic mass number*, *atomic number*, and *atomic weight* are used frequently.

## 2.7 ATOMIC MASS AND ATOMIC MASS NUMBER

The *atomic mass* is the sum of the masses of protons, neutrons, and electrons, and, therefore, is the *exact mass* of an atom. However, as indicated before, the masses of electrons are extremely small and can be neglected. Therefore, the *atomic mass number* (symbol  $A$ ) has been proposed to represent the sum of the masses of protons and neutrons only. It is the nearest integer of the atomic mass

or exact mass. In other words, the exact value is called the *atomic mass*, whereas the nearest whole number of the atomic mass is referred to as the *atomic mass number*.

### 2.7.1 ATOMIC MASS UNIT OR DALTON

Atomic masses can be expressed on a chemical or a physical scale. In general, masses on the chemical scale are smaller than a weighted average physical mass by a factor of 0.999973. On a chemical scale, the element oxygen is arbitrarily assigned the mass 16, nitrogen the mass 14, carbon the mass 12, hydrogen the mass 1, and so on. Weight units can be assigned to the atomic masses as follows:

Gram atom = mass of an element in grams

According to this definition, 1 gram atom of oxygen is then 16 g, 1 gram atom of nitrogen is 14 g, and 1 gram atom of carbon is 12 g.

However, the unit mass of single atoms is usually expressed in terms of *atomic mass units* (amu) also known as *dalton*, named after John Dalton (see Section 2.1). One atomic mass unit (1 amu = 1  $\mu$ ) or one Dalton (1 Da) is by definition 1/12 of the mass of the most abundant isotope of carbon, ( $^{12}\text{C}$ ), (McGraw-Hill, 2005):

$$1 \text{ amu} = 1 \text{ Da} = 1/12 \text{ of } ^{12}\text{C} = 1.66 \times 10^{-24} \text{ g}$$

In some books the unit *amu* is also called the *unified atomic mass constant*.

Mass is related to energy by the famous equation as formulated by *Einstein*:

$$E = mc^2$$

in which  $E$  is the energy in ergs,  $m$  is the mass in grams/amu, and  $c$  is the velocity of light in vacuum ( $3 \times 10^{10}$  cm/sec). This formula indicates that the destruction of a small amount of matter yields an extremely large amount of energy, because the value for the speed of light (which is squared in the formula) is exceptionally high. An example of the large amounts of energy developed by the destruction (burning) of an atom of oxygen (mass = 16) is given below:

$$\begin{aligned} E &= mc^2 \text{ ergs/atom} \\ &= (16)(1.66 \times 10^{-24} \text{ g/amu}) (3.0 \times 10^{10} \text{ cm/sec})^2 \\ &= 239.04 \times 10^{-4} \text{ g cm}^2/\text{sec}^2 \text{ (ergs/atom)} \\ &= 2.39 \times 10^{-2} \text{ ergs/atom} \end{aligned}$$

Because 1 erg =  $1 \times 10^{-7}$  Joules/atom,

$$E = 2.39 \times 10^{-9} \text{ J/atom}$$

The unit for  $E$  can also be expressed in electron volts. Because 1 erg =  $6.24 \times 10^{11}$  eV,

$$\begin{aligned} E &= (2.39 \times 10^{-2} \text{ ergs})(6.24 \times 10^{11} \text{ eV}) \\ &= 14.9 \times 10^9 \text{ eV} \\ &= 14.9 \text{ GeV/atom} \end{aligned}$$

As shown above, the burning of one atom of oxygen produces amounts of energy in the GeV range, the energy created in a powerful gigatron.

Einstein's formula also indicates that  $m = E/c^2$ , which means that matter can be formed from energy. However, the astronomically large figures required in this process for both energy and speed appear in practice to be an insurmountable stumbling block. Unless a very powerful synchrotron can be devised to produce an extremely high amount of energy to more than compensate for the value of  $c^2$ , the transformation of energy into matter remains a topic in a *Star Trek* science fiction story.

## 2.8 ATOMIC NUMBERS

The *atomic number* (symbol  $Z$ ), on the other hand, is the number of protons only, and hence equals the nuclear charge in the atomic nucleus. This number determines the place of the element in the periodic table of Mendeleev. Thus,  $Z$  characterizes an element as does its chemical symbol.

From the definition above, it follows that the number of neutrons equals the difference between the atomic weight and the atomic number  $Z$ .

## 2.9 ATOMIC WEIGHTS

Strictly speaking, *atomic weights* are not weights at all. They are simply numbers that indicate the relative weights of the different kinds of atoms, and no reference is made to absolute weights. Hydrogen was originally assigned a relative weight of 1, because it was considered the fundamental particle and the lightest of all atoms. The heaviest of any of the naturally occurring atoms is uranium, with an atomic weight of 238. When we say that the element oxygen has an atomic weight of 16, we simply indicate that the oxygen atom is 16 times heavier than the hydrogen atom. Therefore, no weight units have been assigned to the numbers. As is the case with atomic masses, however, weight units can be assigned as follows:

$$\text{Gram atomic weight} = \text{atomic weight in grams}$$

The mass of an element in grams is numerically equal to the atomic weight in grams. Therefore, 1 gram atom of oxygen = 1 gram atomic weight of oxygen = 16 grams, and 1 gram atom of carbon = 1 gram atomic weight of carbon = 12 grams, and so on. The selection of hydrogen as a standard base for comparative assessment of other atomic weights was later changed in favor of oxygen, which was assigned an arbitrary mass of 16.0000. The atomic weight of hydrogen changes consequently to 1.0080. To comply with suggestions from atomic physicists, this standard base was revised again in 1961, and atomic weights are currently based on the assigned relative mass of  $^{12}\text{C}$  (a.w. = 12.0000). However, the consequent changes in atomic weights of the other elements are very small (International Union of Pure and Applied Chemistry, 2009). *Atomic weight* (AW) applies only to elements. A compound has *molecular weight* (MW), which equals the sum of the atomic weights of the elements making up the compound.

## 2.10 AVOGADRO'S NUMBER

The number of atoms in 1 gram atomic weight of any element is as follows:

$$6 \times 10^{23}$$

This number is known as *Avogadro's number* and is used for a number of calculations, such as calculating the weight of one atom (see Table 2.1). How much does one atom of hydrogen weigh? One gram atom of hydrogen weighs 1 g, and 1 gram atom of hydrogen contains  $6 \times 10^{23}$  atoms, so then one atom of hydrogen will weigh  $1/(6 \times 10^{23}) = 1.67 \times 10^{-24}$  g, an extremely small number.

**TABLE 2.1**  
**Absolute Weights of 1 Atom (or 1 Molecule) of Selected**  
**Elements or Compounds**

Substance	Mole	AW or MW	g	Number of Particles or Atoms	Weight of One Atom
H <sup>+</sup> ion	1	001	001	$6 \times 10^{23}$	$1.67 \times 10^{-24}$
C	1	012	012	$6 \times 10^{23}$	$2.00 \times 10^{-23}$
Na	1	023	023	$6 \times 10^{23}$	$3.83 \times 10^{-23}$
K	1	039	039	$6 \times 10^{23}$	$6.50 \times 10^{-23}$
Ca	1	040	040	$6 \times 10^{23}$	$6.67 \times 10^{-23}$
NaCl	1	058	058	$6 \times 10^{23}$	$9.67 \times 10^{-23}$
KCl	1	074	074	$6 \times 10^{23}$	$1.23 \times 10^{-22}$
CaCO <sub>3</sub>	1	100	100	$6 \times 10^{23}$	$1.67 \times 10^{-22}$
C <sub>6</sub> H <sub>12</sub> O <sub>6</sub>	1	180	180	$6 \times 10^{23}$	$3.00 \times 10^{-22}$

Sources: Weast, R. C. (ed.). Handbook of Chemistry and Physics, The Chemical Rubber Co., Cleveland, OH, 1972; Gast, R. C. Surface and colloid chemistry. In: *Minerals in Soil Environments*, J. B. Dixon, S. B. Weed, J. A. Kittrick, M. H. Milford, and J. L. White (eds.). Soil Sci. Soc. Am., Madison, WI, 1977, pp. 27–73.

Even the actual weight of a uranium atom is inconceivably small. Yet, it is 238 times heavier than a hydrogen atom.

## 2.11 ATOMIC ORBITALS

Atomic orbitals are functions that define the spatial behavior of electrons of given energy levels in a particular atom. The number of orbital electrons is equal to the number of protons in the nucleus so that the atom as a whole has a net charge of zero.

## 2.12 ATOMIC RADIUS

The electron density around an isolated atom extends to infinity. However, if one is referring to the size of an atom in a molecule or a crystal, then one may define the *atomic radius* as the closest distance of approach of a probe to the nucleus. This radius can be distinguished into a *crystalline* and *hydrated* radius, depending on the hydration of atoms (Table 2.1). As we will see, the size of elements, especially their hydrated radius, will play an important role in many soil chemical reactions. The hydrated radius is the effective radius that determines the chemical behavior of ions in solution. Cation exchange reactions, hydration, double layers, and problems with potentials, dispersion, flocculation of colloids, and so on, are all affected by the size of ions in the reactions.

## 2.13 VALENCE

The valence of an atom or element is that property measured by the number of atoms of hydrogen (or its equivalent) that can be held in combination by one atom of that element if it is negative, or that can be displaced by one atom of that element if it is positive. In simple terms, the valence is



**TABLE 2.2**  
**Ionic Radii, Atomic Numbers, and Atomic**  
**Weights of Selected Elements**

Ion	Radius (Å) <sup>a</sup>		Atomic Number	Atomic Weight
	Crystalline	Hydrated		
Si <sup>4+</sup>	0.42	—	14	28.09
Al <sup>3+</sup>	0.51	9	13	26.98
Fe <sup>2+</sup>	0.74	—	26	55.84
Fe <sup>3+</sup>	0.64	9	26	55.84
Ca <sup>2+</sup>	0.99	4.3	20	40.08
Mg <sup>2+</sup>	0.66	4.2	12	24.32
Sr <sup>2+</sup>	1.20	4.1	38	87.60
Ba <sup>2+</sup>	1.35	4	56	137.36
Li <sup>+</sup>	0.60	3.8	3	06.94
Na <sup>+</sup>	0.98	3.6	11	22.99
K <sup>+</sup>	1.33	3.3	19	39.10
Rb <sup>+</sup>	1.48	3.3	37	85.48
Cs <sup>+</sup>	1.67	3.3	55	132.90

<sup>a</sup> 1 Å (angstrom) =  $1 \times 10^{-8}$  cm, or 1 Å = 0.1 nm.

Source: Gast, R. C. Surface and colloid chemistry. In: *Minerals in Soil Environments*, J. B. Dixon et al. (eds.), Soil Sci. Soc. Am., Madison, WI, 1977. pp. 27–73.

a measure of the combining capacity of atoms. Atoms with the smallest combining capacity are considered to have a valence of one. Valences are whole (integral) numbers and correspond to the number of valence electrons the atom carries. Valence electrons are the orbital electrons that are gained, lost, or shared in chemical reactions.

## 2.14 EQUIVALENT WEIGHT

The *equivalent weight* (Eqw) of an atom or ion is defined as follows:

$$[\text{Atomic (formula) weight}] / (\text{Valence})$$

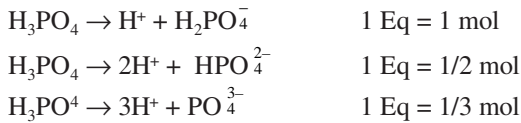
If the atomic weight is assigned as gram atomic weight, the equivalent weight is then in grams. If the atomic weight is in milligrams (mg), then the equivalent weight is in milligrams.

Elements entering into a reaction always do so in amounts proportional to their equivalent weights. The value of the atomic weight does not change with the reaction, but the valence of the atom will change depending on the type of analysis and the reaction process. The following are examples of the determination of equivalent weights.

### 2.14.1 ACID–BASE TITRATIONS

1. In this type of analysis involving reactions with monovalent ions, 1 equivalent (Eq) equals 1 mole (mol).
2. With polyvalent ions, the equivalent weight is variable and depends on the reaction process:



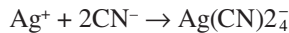


### 2.14.2 PRECIPITATION AND COMPLEX REACTIONS

In this type of analysis, the relationship between the equivalent weight and numbers of moles can be read directly from the reaction. For example, in *volumetric analysis* by which cyanide is titrated with silver according to *Mohr's method*, the reaction occurs as follows:



Here the equivalent equals 1 mol. If *Liebig's method* is used in the titration of cyanide with silver, the end point of titration is reached when the following reaction has occurred [two  $(\text{CN})^-$  are chelated]:

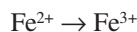


Consequently, the equivalent of cyanide equals 2 mol.

### 2.14.3 OXIDATION–REDUCTION REACTIONS

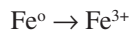
In these reactions, the *equivalence of a substance* is, by definition, that part of a mole that in its reaction corresponds to the removal of 1/2 gram atom of oxygen, or the combination with 1 gram atom of hydrogen or any other univalent element. One way to find the equivalent is to determine in the reaction the change in the oxidation state of the element, as shown in the following examples:

1. In the titration of ferrous into ferric iron using an oxidation agent, the state of oxidation of iron changes from 2 to 3:



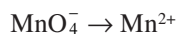
Therefore, the equivalent of ferrous iron equals 1 mol.

2. On the other hand, in the oxidation of metallic iron to ferric iron, the change in oxidation state is from 0 to 3:

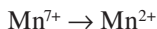


The equivalent of metallic iron, therefore, equals 1/3 mol.

3. In volumetric analysis, when permanganate is used as an oxidizing agent in acid medium, permanganate ions are reduced into manganous ions:

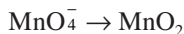


or

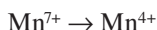


The change in oxidation state of Mn is from 7 to 2, which means a change of five units. The equivalent weight of permanganate is, therefore, 1/5 mol.

If used in neutral medium, the permanganate is reduced to  $\text{MnO}_2$ :



or

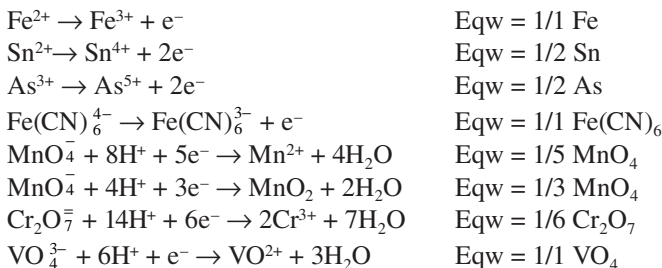


The state of oxidation of permanganate changes with three units. The equivalent then is 1/3 mol.

As indicated in the above examples, it is often not necessary to write the entire balanced equation of the reaction to find the equivalent weight. It is sufficient to write down only the change in oxidation state.

Another way to determine the equivalent weight (Eqw) is as follows. Instead of using the state of oxidation, the equivalent weight can be found by the *number of electrons transferred* in the oxidation–reduction reactions. The following reactions serve as examples:

Equivalent Weight = (Molecular Weight)/(Number of Electrons Transferred)



## 2.15 CHEMICAL UNITS

### 2.15.1 NORMALITY

The number of equivalent weights of a substance dissolved in 1 liter (L) of a solution determines the *normality* ( $N$ ) of the solution—in other words, “normality” is the strength of the solution. If one equivalent is dissolved in 1 L of a solution, the solution has a strength of 1 N (one normal). If two equivalents are present in 1 L of solution, the solution is 2 N. The symbol  $N$  is usually italicized, or when a capital letter is used underscored or underlined ( $\underline{N}$ ), to distinguish it from the symbol N, the nitrogen element.

### 2.15.2 MOLARITY, MOLALITY, AND FORMALITY

With the introduction of SI units (*Système International d'Unités*, see Appendix E), the use of concentration units expressed in terms of *molarity*, *molality*, or *formality* is preferred. The latter does not involve the determination of equivalent weights as with normality,  $N$ , and does not take

into consideration the change in valences or charges of the chemical compounds during a reaction process.

*Molarity* ( $M$ ) is defined as the number of moles of a substance per liter of solution. *Molality* ( $m$ ), on the other hand, is the number of moles per kilogram (kg) of water, and *formality* ( $f$ ) is the number of moles of a substance per kg of solution. The symbols  $M$  and  $m$ , when not italicized, should be underlined ( $\underline{M}$  and  $\underline{m}$ ) to distinguish them from the SI unit terms M (mega), and m (meter).

Molarity is expected to change in value with changes in temperature (T) and pressure (P), whereas molality and formality are independent of T and P. However, for very dilute solutions,  $M = m = f$ , because the differences between them are then very small.

### 2.15.3 MOLE FRACTIONS

Another chemical unit, which is sometimes used in soil chemistry, is the *mole fraction*. The latter is defined as the ratio of the number of moles of a given substance to the total number of moles of all constituents in solution, including the number of moles of water if it is an aqueous solution:

$$\text{Mole Fraction} = \frac{\text{Moles Ion}_1}{\text{Moles Ion}_1 + \text{Moles Ion}_2 + \dots}$$

The following examples serve as illustrations in the calculation of the mole fractions of NaCl in a 2 M solution:

$$\text{Mole fraction of NaCl} = \frac{2}{2 + 55.51} = 0.035$$

$$\text{Mole fraction of H}_2\text{O} = \frac{55.51}{2 + 55.51} = 0.965$$

In the foregoing calculations, 55.51 is the moles of water in 1 L of water. The sum of the mole fractions of NaCl and water:  $0.035 + 0.965 = 1.000$ .

## 2.16 ISOTOPES

*Isotopes* are defined as the same elements with a similar atomic number but with differing mass number. The name is derived from the Greek terms *isos* (equal), and *topos* (site). It became apparent that not all atoms of the same element had the same atomic weight. Mass spectrographic analysis yielded evidence that oxygen could be separated into three types of oxygen with mass numbers 16, 17, and 18, respectively (Budzikiewicz and Grigsby, 2006). These types of oxygen are called *isotopes of the oxygen element*. They are different forms of the same element. The atoms of the isotopes have the same number of protons but a different number of neutrons. Oxygen has three isotopes:  $^{16}\text{O}$ ,  $^{17}\text{O}$ , and  $^{18}\text{O}$ . However, 99.76% of all oxygen is in the form of  $^{16}\text{O}$ . Hydrogen is known also to have three isotopes,  $^1\text{H}$ ,  $^2\text{H}$  (called *deuterium* or *deuteron*), and  $^3\text{H}$  (called *tritium* or *triton*). Deuterium and tritium are rare. Water in which the hydrogen has been replaced by deuterium is called heavy water. Its formula is  $\text{D}_2\text{O}$ , and it has a density greater than  $\text{H}_2\text{O}$  (density = 1.076 g/mL at 20°C). At very high temperatures,  $^2\text{H}$  can be fused with  $^3\text{H}$ , a reaction called nuclear fusion, and a He nucleus and neutron are produced. This reaction, by which part of the mass is converted into energy, is the nuclear reaction of the hydrogen bomb, and the reaction that powers nuclear submarines. It is also

believed that fusion of four hydrogen nuclei to form one He nucleus is the source of energy of the sun. The mass of four hydrogen nuclei is greater than one He nucleus. The extra matter is converted into energy by nuclear fusion.

## 2.17 RADIOACTIVITY

*Radioactivity*, discovered for the first time in 1896 by Henri Becquerel, involves a spontaneous disintegration of certain types of elements or atoms to form other elements or atoms. It was Pierre and Marie Curie who revealed that this process was caused by the disintegration of the atomic nucleus to form another nucleus. For their discovery, the three scientists shared the Nobel Prize (L'Annunziata, 2007; Curie, 2002). The *SI unit* of radioactivity, *Bq* (see Appendix E), is named for Becquerel and as with other SI units derived from the names of persons, the first letter of the symbol is capitalized. But when spelled out, the unit is, by rules of the *Bureau International des Poids et Mesures* (BIPM, 2009), written with lowercase letters. Such a spontaneous decomposition of the atomic nucleus is called *radioactivity*, because it always produces emission of particles seen as radiation. Rutherford indicated that if atoms were able to eject particles, then these atoms were transformed into atoms with lower atomic weights. Ejection of  $\alpha$ -particles means that two neutrons and two protons are emitted as a single particle. The remaining part of the atom is a new element. Among the many types of radioactive elements, perhaps uranium is the best known. By emission of an  $\alpha$ -particle, the uranium nucleus loses two positive charges (two protons), and its atomic number drops from 92 to 90. Because the ejection of an  $\alpha$ -particle also means a loss of two neutrons, the mass number of the uranium nucleus decreases from 238 to 234. This new element is called *thorium*. In turn, thorium may emit electrons ( $\beta$ -particles), which is the result of a neutron decaying into a proton and an electron. A new element is then formed, called *protactinium*, with an atomic number of 91. The emission of either electrons or  $\alpha$ -particles from the nucleus of a decaying atom is a natural process. Before radioactivity stops, or the nucleus becomes stable,  $^{238}_{92}\text{U}$  will continuously exhibit radiation by emission of particles. The final product is lead 206 ( $^{206}_{82}\text{Pb}$ ).

**TABLE 2.3**  
**Half-Life of Selected Radioactive Elements**  
**Important in Soils and Agriculture**

Element	Half-Life	Element	Half-Life
$\text{U}^{238}$	$4.5 \times 10^9$ yr	$\text{Co}^{57}$	270 days
$\text{U}^{234}$	$2.5 \times 10^5$ yr	$\text{Fe}^{55}$	2.6 yr
$\text{Ra}^{226}$	1620 yr	$\text{Mn}^{53}$	$2.0 \times 10^6$ yr
$\text{Pb}^{207}$	Stable	$\text{Ca}^{45}$	165 days
$\text{Pb}^{206}$	Stable	$\text{K}^{42}$	12.4 hr
$\text{Ba}^{131}$	12 days	$\text{Cl}^{36}$	$3.1 \times 10^5$ yr
$\text{Zn}^{65}$	243.6 days	$\text{S}^{35}$	88 days
$\text{Cu}^{64}$	12.9 hr	$\text{P}^{32}$	14 days
$\text{Si}^{31}$	2.62 hr	$\text{Na}^{22}$	2.6 yr
$\text{Mg}^{28}$	21 hr	$\text{C}^{14}$	5730 yr
$\text{Al}^{26}$	$7.4 \times 10^5$ yr		

*Source:* Some data from Weast, R. C., ed. *Handbook of Chemistry and Physics*, The Chemical Rubber Co., Cleveland, OH, 1972.

## 2.18 HALF-LIFE OF RADIOACTIVE MATERIAL AND CARBON DATING

*Half-life* is a measure of the rate of decay of radioactive material. It is the length of time during which the material loses one-half of its radioactivity, or the time required for decomposition of one-half of the atom. In the latter sense, the term *half-life* has now been adopted for measuring the persistence of pollutants in soils.

Radioactive elements emit a definite number of particles per second. This rate of decay is dependent on the amount of radioactive material, and the rate of emission will, therefore, decrease as the amount of decaying atoms becomes gradually smaller and smaller as emission of particles progresses. For many of the radioactive materials, the time for complete decay is practically infinitely long, and it is very difficult, if not impossible, to determine the life span of these radioactive materials. However, the *half-life span* is relatively easy to determine. The half-life of a radioactive element is a characteristic feature that cannot be altered by physical or chemical means. Examples of characteristic half-lives of selected elements are shown in Table 2.3. The rate of decay for a given amount of radioactive material (e.g., uranium) is constant, and the final product is a stable Pb isotope, so the ratio Pb concentration/<sup>238</sup>U is considered a measure for the minimum age of the sample. The foregoing principle is applied in the analysis for determining the age of geologic and anthropologic material with <sup>14</sup>C. This analysis is called carbon dating. Carbon 14, <sup>14</sup>C, is a radioactive isotope that has been formed by cosmic rays from outer space hitting nitrogen atoms in the atmosphere. Nitrogen is then transmuted into <sup>14</sup>C, which decays into <sup>12</sup>C. Equilibrium usually exists in nature between the rate of <sup>14</sup>C formation and its rate of decay into <sup>12</sup>C. During growth, the organism in nature obtains its carbon from the atmosphere directly or indirectly, and both <sup>12</sup>C and <sup>14</sup>C are absorbed in proportion to the equilibrium concentration existing in the air. As soon as the organism dies, the uptake of <sup>12</sup>C and <sup>14</sup>C ceases, but radioactive decay of <sup>14</sup>C into <sup>12</sup>C continues. By measuring the amount of <sup>14</sup>C in the material, the length of time since death can be estimated. Fresh or living material contains more <sup>14</sup>C than decomposed or dead residue. Because the half-life of <sup>14</sup>C is only 5370 years, carbon dating is limited in its determination of age to approximately 10,000 to 15,000 years. For older materials, other radioactive methods are available, such as argon dating, potassium–argon dating, and argon–argon dating (Kuiper et al., 2008). Potassium–argon (K/Ar) dating has been used to date the ages of rocks as old as 4 billion years.

---

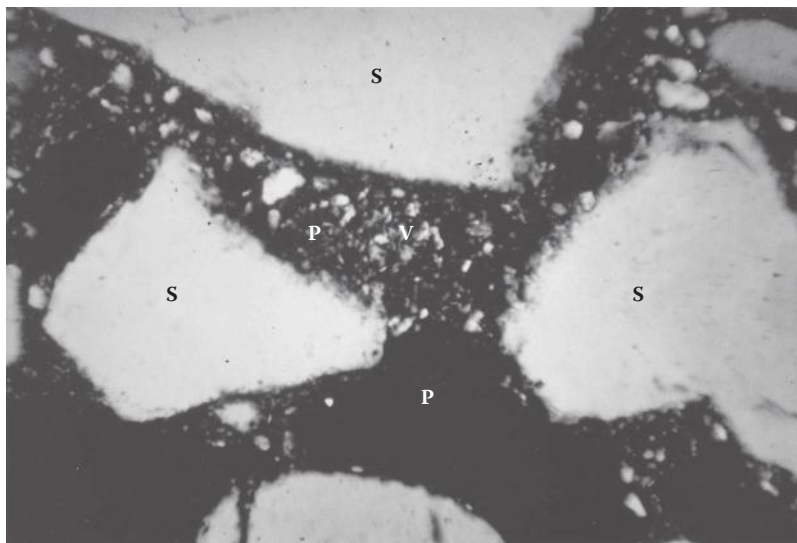
# 3 Soil Composition and Electrochemical Potentials

## 3.1 SOIL COMPOSITION

The soil system is composed of three phases: solid, liquid, and gas. The solid phase is a mixture of mineral and organic material and provides the skeletal framework of the soil. Enclosed within this framework is a system of pores, shared jointly by the liquid and gaseous phases. The spatial arrangement of the solid particles and associated pores, or voids (Figure 3.1), is, in *micromorphological* terms, the *soil fabric* (Brewer and Sleeman, 1960; Kubiena, 1938). *Micromorphology* is today considered part of *micropedology* (Chesworth, 2008; Wilding and Lin, 2006). The nature of the soil constituents, the activity of soil organisms, and other soil-forming processes lead to the creation of a series of features with specific soil fabrics. Although the traditional concept indicates that soil fabric is comparable with rock fabric, which depends on the shape and arrangement of minerals, it is perhaps more appropriate to compare soil fabric with the fabric of plant and animal tissue. The components of the soil fabric include water and organic substances, containing humus and organisms, and a series of organic and inorganic compounds. The organic materials are also of importance in plant and animal tissue, but they are generally absent in rocks. The coarse fabric components ( $\leq 2$  mm) are called *skeleton grains*. They can be divided into inorganic (e.g., primary minerals) and organic (e.g., fragments of dead roots and other organisms) skeleton grains. On the other hand, the fine material ( $< 0.002$  mm) in the soil fabric is called *plasma* and includes the clay (*inorganic plasma*) and humus fraction (*organic plasma*). The name *soil matrix* refers to the soil plasma (Osmond, 1958). Attempts have been made lately to identify or relate specific soil fabrics with specific soil horizons. It appears that argillic, cambic, oxic, and spodic horizons can be differentiated by differences in soil fabric (Wilding and Flach, 1985).

The way in which the skeleton grains and the plasma are arranged determines the shapes and sizes of voids, which are integral parts of the soil fabric. The skeleton grains are considered relatively immobile, and therefore, not readily translocated, except for washing down the cracks. They will decompose to produce plasma, and in the process the coarse organic matter is transformed into humic acids, whereas the inorganic skeleton grains will be converted into clays. Formation of humic acids is discussed in Chapter 6, and weathering of primary minerals into clays is a major topic of Chapter 10. In contrast, the plasma is the mobile, chemically active part of the soil and can be translocated and accumulated by soil formation processes, as noticed in the cracks of the bottom sand grain (see Figure 3.1). The plasma is called *cutan* when deposited on the surfaces of skeleton grains, on the walls of voids, or on the boundaries of structural units. These cutans are called *argillans* or *clay skins* if they are composed dominantly of clay minerals.

In summary, it can be stated that the soil is composed of air, water, and inorganic and organic matter. These four major soil constituents are distributed in space to form the soil fabric. Though only that part of the soil fabric, called plasma—clay and humus—is considered the *seat of soil chemical activity*, most if not all of the soil chemical reactions take place in the liquid phase. Simply called *soil water* or more commonly *soil moisture*, it nourishes plants and microbial life. It contains the dissolved substances, ions and solutes, creating a *soil–water–root system*, closely resembling an *electrochemical cell*, where ion and water movement, dissolution, dissociation, availability of



**FIGURE 3.1** A soil thin section showing the spatial arrangement of soil constituents and associated pores (voids), called *soil fabric*. The pores contain water and air. S is the mineral grain or sand (2 to 0.05 mm); P is the plasma (<0.002 mm, clay and humus), and V is void or pore.

plant nutrients to roots, and reduction and oxidation of elements are controlled by electrochemical potentials. Because these potentials are one of the most important parameters in soil chemistry, it is perhaps necessary to provide first the basic concepts of electrochemical potentials before addressing soil air and soil water. The components and properties of the soil gas and liquid phases will be dealt with in more detail in Chapter 4, whereas the two solid soil constituents in the soil plasma—organic matter and clays—are addressed in Chapters 5 and 6.

### 3.2 THE CONCEPT OF ELECTROCHEMICAL POTENTIALS

The term *electrochemical potential* is derived from combining the terms *electric* and *chemical potentials*. In electrochemistry—the science of electrical and chemical energy—the chemical potential is ascribed to the free energy content of a soil chemical substance and applies to noncharged as well as to charged particles or, more specifically, *soil solutes*. Though Gibbs was often credited for the use of this term, Baierlein (2001) believed it was W. D. Brancroft who introduced the name *chemical potential*. However, the electric potential is defined as the potential energy per unit charge within a static electric field (Bockris et al., 2008; Hamann et al., 2007) and is developed by the electrical charges of soil constituents, such as ions. Because ions possess both electric charges and free energy contents, their status and behavior in general are affected by *electrochemical potentials*. A third potential is the *electrode potential*, which develops on the tips of electrodes, causing separation of charged ions. This potential, discussed in detail below, is closely related to the *redox potential* that describes the state of oxidation and reduction of elements, affecting their mobilization and immobilization in soils. Based on the basic principles of electrochemical potentials above, the concept of potentials was developed further during the years to meet the demand of pedologic and edaphologic processes in soil science. Built on the older system, a new generation of soil potentials evolved. *Aluminum potential*, *gibbsite potential*, *phosphate potential*, and *silica potential*, to name just a few, were created to determine, describe, or predict dissolution, stability, and weathering of soil compounds and minerals. They are, therefore, carrying messages in addition to changes in free energy. This idea appears to be unique for soil science, because no mention is made, for example, of a gibbsite potential in other branches of science. More will be discussed in the following sections and chapters of this book.



### 3.2.1 ELECTROCHEMICAL CELLS AND ELECTRODE POTENTIALS

The soil system is the reservoir of most plant nutrients and also contains the active surfaces that determine the concentration of ions in the soil solution. As indicated above, ion movement, accumulation, availability of elements and uptake by plants, changes in element oxidation and reduction state, and many other chemical reactions in soils are reactions that, to a certain extent, show some resemblance to those occurring in an electrochemical cell. In pure chemistry two types of *electrochemical cells* are distinguished: *galvanic* or *voltaic cells* and *electrolytic cells* (Bagotsky, 2006). A *galvanic cell* consists of two electrodes and one or more solutions (usually two half-cells). It is capable of spontaneously converting chemical energy from the solutions into electrical energy and supplying this energy to an external source. An oxidation reaction at one electrode and a reduction reaction at the other electrode are responsible for the production of this electrical current. The automobile battery is an example of this kind of chemical cell. When one of the chemical components responsible for the reaction is depleted, the cell is considered dead. In an *electrolytic cell*, electrical energy is supplied from an external source. Electrochemical changes are produced at the electrode–solution interfaces (Figure 3.2), and concentration changes are developed in the bulk of the system. If the external current is turned off, the system tends to produce current in the opposite direction. The lowest external electromotive force (emf) that must be applied to bring about the continuous separation of cations and anions (electrolysis) is called the *decomposition voltage* or the *back emf*. At the exact point where the galvanic emf is opposed by an equal emf, no current flows in either direction. In this static condition, the potential generated at the interface of an indicator electrode reflects the composition of the solution phase. Now that we know what electrochemical cells are, let us assume that we have a pure metal electrode dipping into a solution containing its ions. To be more specific, let us use a Cu-electrode in a solution of cupric,  $\text{Cu}^{2+}$ , ions (Figure 3.2). At the interface copper tries to dissolve from the metal, increasing the  $\text{Cu}^{2+}$  ion concentration in the solution. This process creates a concentration difference in  $\text{Cu}^{2+}$  ions between the interface and the bulk solution, which also translates into a concentration difference in electrical charges. Therefore, a potential difference develops on the surface of the Cu electrode, between the metal and the solution. This potential difference is simply called the *electrode potential* and cannot be measured but can be calculated with the *Nernst equation*. It is not possible to measure the potential of a single electrode, and the only possibility is to measure the potential of one electrode relative to another, the *reference electrode* (Newman and Thomas-Alyea, 2004). A *standard reference electrode* is the *hydrogen*

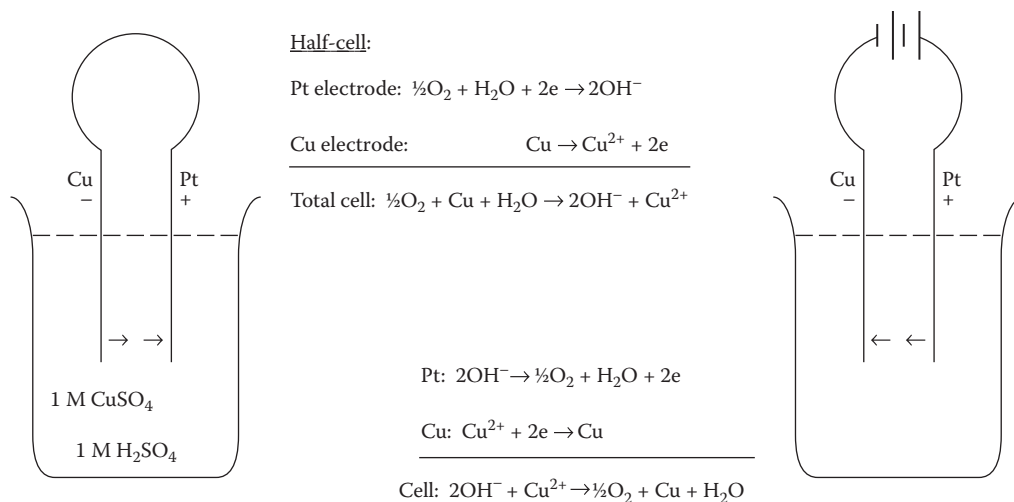


FIGURE 3.2 Half-cell and total cell reactions in an electrolytic cell.

*electrode* (Pt electrode dipping in a solution at unit activity of hydrogen ions). The potential of the standard hydrogen electrode is by convention set to 0.00 volt. If the two electrodes are connected and an external emf is applied, electrons will flow through the system. At standard state—meaning at solution concentrations of 1 mol/kg and at 100 kPa (= 1 atm) pressures—the electrode potential is called *the standard electrode potential*.

### 3.3 THE NERNST EQUATION

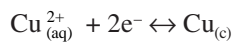
The *Nernst equation* was formulated by Walther Hermann Nernst (1864–1941), a German physical chemist (Wahl, 2005). Known also for his *Nernst–Thompson rule*, explaining the ionization process, and for the *Heat Theorem* as reflected in the *Third Law of Thermodynamics*, for these and many other contributions Nernst was awarded the Nobel Prize for electrochemistry in 1920. The electrode potential of a single electrode in an electrochemical cell, as explained in the preceding section, was formulated by Nernst into the now famous *Nernst equation*. This provides a means for the determination of the redox potential of a half-cell reaction and can also be used to calculate the electromotive force of the whole electrochemical cell. The general equation can be written as follows:

$$E = (RT/nF) \ln (K/M^n) \quad (3.1)$$

where  $E$  is the potential difference,  $R$  is the gas constant,  $T$  is the absolute temperature,  $n$  is the valence of the ion,  $F$  is the Faraday constant,  $K$  is the impulse (or constant) of metal to dissolve, and  $M$  is the metal ion activity. This equation is not only valuable for the determination of the equilibrium redox potential of a half-cell in electrochemical cells, but it can also be used to determine the voltage or electromotive force of the whole cell. The formula has now been applied in different forms to many other reactions in soil chemistry, such as in the law of equilibrium, the concept of solubility products, and more. Next to the Law of Equilibrium it is one of the most extensively used equations in soil chemistry. In plant nutrition, it is used for finding the electrochemical potential of cell membranes in plant roots which determines nutrient uptake. This will be discussed below in more detail.

### 3.4 ELECTRODE POTENTIALS IN REDOX REACTIONS

The reactions occurring at the interfaces of the electrodes in the electrochemical cell discussed above are reduction and oxidation reactions. Using again the Cu electrode (Figure 3.2) as an example, the following reactions then occur in the cell. Copper will be deposited on the Cu electrode:



At the hydrogen electrode, hydrogen will release electrons to become  $\text{H}^+$ :



Either of these reactions is called a *half-cell reaction*. The overall reaction is as follows:



According to Equation 3.2, the potential of the Cu electrode measured against the reference electrode can then be formulated according to the *Nernst equation* as follows:

$$E_h = E^\circ + (RT/nF) \ln (\text{Cu}^{2+}/\text{Cu}) \quad (3.3)$$

At 25°C and 1 atm, this equation can be written as follows:

$$E_h = E^\circ + (0.0592/n) \log (\text{Cu}^{2+}/\text{Cu}) \quad (3.4)$$

$E_h$  is then the *electrode potential*, whereas  $E^\circ$  is the standard potential of the cell in which the reactants and products have unit activity. The symbols  $E_H$  or  $E_h$ , instead of  $E$ , are preferred by a majority of scientists and are used to indicate that the potential was measured against the *standard hydrogen electrode* rather than to one of the other types of reference electrodes. The standard potential of a cell when the other electrode is a standard hydrogen electrode is, by definition, called the *standard electrode potential*. Equation 3.4 also indicates that the electrode potential will change by 59.2 millivolts with a 10-fold change in concentration of monovalent ions ( $n = 1$ ) and by 29.6 millivolts with divalent ions ( $n = 2$ ).

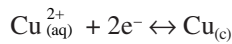
The formula of  $E_h$  can be generalized as follows:

$$E_h = E^\circ + (RT/nF) \ln (M^{n+}/M^{(n-1)}) \quad (3.5)$$

where  $M$  is the metal ion activity, and  $n$  is the valence. Because the reactions are oxidation and reduction reactions, Equation 3.4 can also take the form of a generalized *redox potential* as follows:

$$E_h = E^\circ + (RT/nF) \ln (\text{oxidation/reduction}) \quad (3.6)$$

However, depending on the way the reaction is written, electrode potentials are *oxidation* or *reduction potentials*. If the reaction is written as a *reduction reaction*,



the standard potential is called a *reduction potential*. Both electrode and reduction potentials of  $\text{Cu}$  are then positive in sign. If, however, the reaction is written as an *oxidation reaction*,



the standard potential equals an oxidation potential and is negative in sign. As indicated before, the standard potential of the hydrogen electrode is by convention zero. The difference of two standard potentials gives the standard potential of the desired reaction. Several selected standard potentials are given in Table 3.1.

From the discussions above, it is perhaps clear that  $E_h$ , considered by many scientists a master variable, determines the distribution of the various oxidation states of elements. The electrode potential,  $E_h$ , was defined by the International Union of Pure and Applied Chemistry (IUPAC, 1960) as the electron availability of the electrochemical potential of the electron at equilibrium. *Electron availability*, or *redox potential*, is an indication of the reduction–oxidation status of soils. It affects the oxidation and reduction states of H, C, N, O, S, Fe, Mn, Cu, Zn, and many other elements and, as such, controls solubility and availability of many nutrient elements to plants. But for the oxidation–reduction limits imposed by the stability of water, this list would include all the elements of the periodic table. As will be discussed, the limit of oxidizing conditions in aqueous systems is the oxidation of water to molecular oxygen. On the other hand, the limit of reducing conditions is the reduction of the hydrogen ion to molecular hydrogen. In natural systems, redox potentials have often been treated as equilibrium potentials. At equilibrium,

**TABLE 3.1**  
**Selected Electrode Potentials of Half-Cell Reactions**

Half-Cell Reaction <sup>a</sup>	Electrode Potential (V)
$3\text{N}_2 + 2\text{H}^+ + 2\text{e}^- \rightleftharpoons 2\text{NH}_3$	-3.100
$\text{Li}^+ + \text{e}^- \rightleftharpoons \text{Li}$	-3.045
$\text{K}^+ + \text{e}^- \rightleftharpoons \text{K}$	-2.924
$\text{Ba}^{2+} + 2\text{e}^- \rightleftharpoons \text{Ba}$	-2.900
$\text{Na}^+ + \text{e}^- \rightleftharpoons \text{Na}$	-2.710
$\text{Mg}^{2+} + 2\text{e}^- \rightleftharpoons \text{Mg}$	-2.375
$\text{ZnO}^{2-} + 2\text{H}_2\text{O} + 2\text{e}^- \rightleftharpoons \text{Zn} + 4\text{OH}^-$	-1.216
$\text{Mn}^{2+} + 2\text{e}^- \rightleftharpoons \text{Mn}$	-1.029
$\text{Fe}^{2+} + 2\text{e}^- \rightleftharpoons \text{Fe}$	-0.409
$\text{Fe}^{3+} + 3\text{e}^- \rightleftharpoons \text{Fe}$	-0.036
$2\text{H}^+ + 2\text{e}^- \rightleftharpoons \text{H}_2$	0.000
$\text{Cu}^{2+} + \text{e}^- \rightleftharpoons \text{Cu}^+$	+0.158
$\text{AgCl} + \text{e}^- \rightleftharpoons \text{Ag} + \text{Cl}^-$ (silver–silver chloride electrode)	+0.222
Calomel electrode, 1N KCl	+0.280
$\text{Cu}^{2+} + 2\text{e}^- \rightleftharpoons \text{Cu}$	+0.340
$\text{Fe}^{3+} + \text{e}^- \rightleftharpoons \text{Fe}^{2+}$	+0.770
$\text{Hg}_2^{2+} + 2\text{e}^- \rightleftharpoons 2\text{Hg}$	+0.789
$\text{Ag}^+ + \text{e}^- \rightleftharpoons \text{Ag}$	+0.799
$\text{MnO}_2 + 4\text{H}^+ + 2\text{e}^- \rightleftharpoons \text{Mn}^{2+} + 2\text{H}_2\text{O}$	+1.208
$\text{O}_2 + 4\text{H}^+ + 4\text{e}^- \rightleftharpoons 2\text{H}_2\text{O}$	+1.229
$\text{Cr}_2\text{O}_7^{2-} + 14\text{H}^+ + 6\text{e}^- \rightleftharpoons 2\text{Cr}^{3+} + 7\text{H}_2\text{O}$	+1.330
$\text{MnO}_4^- + 8\text{H}^+ + 5\text{e}^- \rightleftharpoons \text{Mn}^{2+} + 4\text{H}_2\text{O}$	+1.510
$\text{H}_2\text{O}_2 + 2\text{H}^+ + 2\text{e}^- \rightleftharpoons 2\text{H}_2\text{O}$	+1.770

<sup>a</sup> In accordance with the International Union of Pure and Applied Chemistry (IUPAC) conventions, the reactions above are written as reduction reactions. The signs of electrode potentials may perhaps be opposite in other books if written as oxidation reactions.

Source: Weast, R. C., ed. *Handbook of Chemistry and Physics*, The Chemical Rubber Co., Cleveland, OH, 1972.

a mixture of redox couples reacts until the net donation and acceptance of electrons are zero. The electron's escaping tendency or the  $E_h$  of each redox couple is the same, and their reduction/oxidation ratios have adjusted to that defined by the Nernst equation. However, natural soil systems rarely reach oxidation–reduction equilibrium because of the continuous addition of electron donors (i.e., oxidizable organic compounds). The oxidation of these compounds is often very slow, even when the major electron acceptor, oxygen, is available. Redox conditions in living systems are nonhomogeneous, even within a single cell. In photosynthesis, for example, water is split into a strongly reducing form of hydrogen and the strongly oxidizing agent oxygen within a chloroplast.

It must be emphasized that the above is about the derivation of the *concept* of redox potential from the theories of electrode potentials. It is by no means a duplicate discussion on redox potential in soils, as in Chapter 10, which was claimed erroneously by a reviewer. Most, if not all, soil chemical processes are based on electron transfer that is intimately related to reduction and oxidation reactions. Hence, the basics of redox potentials and related concepts are provided above

and in other sections of this chapter for increasing comprehension on the chemistry of the many reactions and their effects on soil formation and soil properties discussed in subsequent chapters in this book.

### 3.5 ELECTRON ACTIVITY

The derivation of formulas for the redox potential, as discussed in the preceding section, does not include the electrons. As noticed from the reactions, the electrons are vital participants in the reaction process. The problem is that free electrons, as such, do not exist in the soil solution, but neither do hydrogen ions. Both electrons and protons (hydrogen ions) can exist only in close association with the solvent or a solute species. The analogy between electrons and protons can further be illustrated as follows. The activity of  $H^+$  ions is used to indicate the acid–base condition of soil, as expressed in terms of pH. The soil is called acidic if the  $H^+$  ion activity is high, in other words  $H^+ > OH^-$  concentration. The soil is considered to be basic in reaction if the  $H^+$  ion activity is low, or  $H^+ < OH^-$  concentration. By analogy then, soil with a high electron activity is considered to be in a reduced condition, whereas soil with a low electron activity is in a highly oxidized state. This can be further explained by using a generalized redox equation as follows:



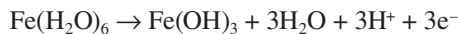
If electron activity increases, reduction increases (the reaction shifts to the right). When, on the other hand, electron activity decreases, oxidation processes prevail (the reaction shifts to the left). Application of the concept of electrode potential to the foregoing reaction yields an equation similar to Equation 3.6:

$$E_h = E^\circ + [(RT)/nF] \ln (\text{oxidation/reduction}) \quad (3.8)$$

Because  $R$  is the gas constant,  $T$  is the absolute temperature, and  $F$  is the Faraday constant—all constants— $RT/F$  equals 0.059, and Equation 3.8 can also be written in log form as follows:

$$E_h = E^\circ + [(0.059)/n] \log (\text{oxidation/reduction}) \quad (3.9)$$

Many times, electron transfer in redox reaction is accompanied by a proton transfer. The following reactions serve as examples:



From these reactions, it is now evident that electrons can also be considered as the reactants or products in a reaction process. Because  $H^+$  activity can be expressed in terms of pH, electron activity can also be represented by pe. In a way similar as to how pH is defined as:

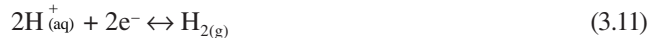
$$pH = -\log H^+$$

pe can be defined as:

$$pe = -\log (a_e) \quad (3.10)$$

In Equation 3.10,  $a_e$  equals the activity of the electrons. Many books use the symbol  $pE$  (Manahan, 1975, 2009; Sposito, 1989; Stumm and Morgan, 1981), whereas other books prefer the use of  $P_e$  (Paul and Clark, 1989) for the negative log of electron activity. However, the symbol  $E$  is universally used for electric potential; hence,  $pE$  can refer to the negative log of the electrode potential or redox potential,  $E$  or  $E_h$ , respectively. On the other hand, the symbol  $P$  ordinarily is used for *pressure* or *potential*. It is an established fact, in chemistry, thermodynamics, and the pH concept, that the symbol  $p$  is meant to indicate *negative log* or *-log*. Therefore, to avoid confusion and to preserve consistency, the symbol  $pe$  is preferred in this book over the use of  $pE$  or  $P_e$ .

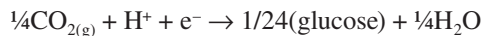
The application of the  $pe$  concept is based on the reaction:



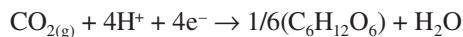
This reaction is used for defining the free energy changes,  $\Delta G$ , in redox processes in soil. When all the components of the foregoing reaction are at unity,  $\Delta G$  for this reaction equals zero. Therefore, when both the  $H^+$  ion and the  $H_2$  gas are at unit activity, the activity of the electron is also 1 (or unity); hence, the  $pe = -\log 1 = 0$ . The electrode potential for Equation 3.11 then also equals zero (see Table 3.1). If the electron activity were to increase to 10, the  $pe$  would become  $-1$ . If the electron activity were to decrease to  $-10$ , the  $pe$  would become  $+1$ . This means that low  $pe$  values indicate reduction, whereas high  $pe$  values refer to oxidation, or in more scientific language, a system with low  $pe$  is an *electron donor*, whereas that with high  $pe$  is an *electron acceptor*. Because, as stated above, free electrons do not exist alone, oxidation reactions are, therefore, accompanied by reduction reactions or vice versa. Consequently, an oxidant is a compound that affects oxidation but is being reduced itself during the process.

### 3.5.1 ELECTRON ACTIVITY IN THE BIOCHEMICAL CYCLE

A parameter,  $pe$ , is now available representing the electron activity that can be used to measure the capacity of compounds or solutions to accept or donate electrons. This enables us to study and understand the biochemical cycle and many other cycles affected by redox reactions in nature. One of the biochemical cycles, vital for continuation of life, starts when  $CO_2$  is absorbed by green plants and converted into carbohydrates by a process called *photosynthesis*. The products of photosynthesis, called *photosynthates*, are later recycled into  $CO_2$  through decomposition and mineralization (Stevenson, 1986; Tan, 1994). These photosynthates are in essence reservoirs of energy captured from the sun, and exhibit, therefore, highly negative  $pe$  values. According to Stumm and Morgan (1981), the transformation of  $CO_2$  into glucose, represented by the reaction:



or



requires a  $pe^0 = -0.20$ . Therefore, photosynthesis is considered a process that produces substances of highly negative  $pe$ . These high-energy-containing substances are required for growth and maintenance of life. The photosynthates are consumed by the organisms and broken down by respiration and other metabolic processes. Such nonphotosynthetic processes are releasing the stored energy, and hence are increasing the  $pe$  levels again. In summary we can say that photosynthesis reduces  $pe$  and causes the development of a nonequilibrium condition. Respiration, fermentation, and formation of methane, on the other hand, increase  $pe$  to restore the equilibrium condition in nature.

**TABLE 3.2**  
**pe Values of Selected Redox Reactions of Importance in the Biochemical Cycle (25°C and pH = 7)**

Reaction	pe°	pe <sub>w</sub> <sup>o,a</sup>
Oxidized ferredoxin + e <sup>-</sup> ↔ reduced ferredoxin	-7.1	-7.1
CO <sub>2(g)</sub> + H <sup>+</sup> + 2e <sup>-</sup> ↔ HCOO <sup>-</sup>	-4.83	-8.33
CO <sub>2(g)</sub> + 4H <sup>+</sup> + 4e <sup>-</sup> ↔ CH <sub>2</sub> O + H <sub>2</sub> O	-1.20	-8.20
(NADP <sup>+</sup> ) <sup>b</sup> + H <sup>+</sup> + e <sup>-</sup> ↔ (NADPH)	-2.0	-5.5
H <sup>+</sup> + e <sup>-</sup> ↔ H <sub>2(g)</sub>	-0.0	-0.0
CO <sub>2(g)</sub> + 8H <sup>+</sup> + 8e <sup>-</sup> ↔ CH <sub>4(g)</sub> + 2H <sub>2</sub> O	+2.87	-4.13
6N <sub>2(g)</sub> + 8H <sup>+</sup> + 6e <sup>-</sup> ↔ 2NH <sub>4</sub> <sup>+</sup>	+4.68	-4.68
CH <sub>2</sub> O + 4H <sup>+</sup> + 4e <sup>-</sup> ↔ CH <sub>4(g)</sub> + H <sub>2</sub> O	+6.94	-0.06

<sup>a</sup>  $pe_w^o = pe^o + (1/20)\log K_w$ ; 0 = moles of protons exchanged per moles of electrons.

<sup>b</sup> NADP, nicotinamide adenine dinucleotide phosphate.

Sources: Calvin, M., and J. A. Bassham. *The Photosynthesis of Carbon Compounds*, Benjamin, Menlo Park, CA, 1962; Stumm, W., and J. J. Morgan. *Aquatic Chemistry: An Introduction Emphasizing Chemical Equilibria in Natural Waters*, 2nd ed., Wiley, New York, 1981.

Examples of pe values associated with nonphotosynthetic and photosynthetic related reactions are listed in Table 3.2. The data show that from a low negative pe for the assimilation of CO<sub>2</sub> gas into an organic compound, CH<sub>2</sub>O, the pe value increases again with the decomposition of CH<sub>2</sub>O into CH<sub>4</sub> (methane).

### 3.5.2 THE RELATIONSHIP BETWEEN ELECTRON ACTIVITY AND ELECTRODE POTENTIAL

As will be explained in Chapter 4, the electrode potential  $E_h$  is related to the negative log of the electron activity, pe, by the following equation:

$$E_h = [(2.3RT)/(F)]pe \quad (3.12)$$

where R is the gas constant, T is the absolute temperature (kelvin, K), and F is the Faraday constant. Because these constants are known (see Appendix A), at T = 298 K (or 25°C), the equation may be changed to the following:

$$E_h = 0.059 pe \quad (3.13)$$

or

$$pe = E_h/0.059 \quad (3.14)$$

In this equation,  $E_h$  is in volts (V). A similar relationship can be found for the standard electrode potential:  $E^o = 0.059 pe^o$ . The electrode potential can, therefore, be expressed also in terms of pe, and conversion of  $E_h$  into pe (or  $E^o$  into  $pe^o$ ) can be easily accomplished by using Equation 3.13 and Equation 3.14. A partial list of half-cell reactions and their standard electrode potentials from Table 3.1 is presented in Table 3.3 to illustrate the conversion of  $E^o$  into  $pe^o$ . The more positive the value of  $E^o$  or  $pe^o$ , the greater the tendency for these reactions to proceed to the left (oxidation). The



**TABLE 3.3**  
**Relationship between  $E^\circ$  and  $pe^\circ$**

Half-Cell Reaction	$E^\circ$	$pe^\circ$
$Mn^{2+} + 2e^- \leftrightarrow Mn$	-1.029 V	-17.44
$Fe^{2+} + 2e^- \leftrightarrow Fe$	-0.409 V	-6.93
$2H^+ + 2e^- \leftrightarrow H_2$	0.000 V	0.00
$Cu^{2+} + 2e^- \leftrightarrow Cu$	+0.340 V	+ 5.76
$Fe^{3+} + e^- \leftrightarrow Fe^{2+}$	+0.770 V	+13.05

smaller are the values of  $E^\circ$  and  $pe^\circ$ , the greater is the tendency for the reactions to go to the right (reduction). Other authors prefer the use of the name of *electron-poor* species for the oxidized substance, and *electron-rich* species for the substance in the reduced state (Sposito, 1989).

### 3.6 THE RH CONCEPT

The concept of  $rH$  was advanced and promoted by Bray and White (1966) and Kennedy (1992) for the reduction potential of various reduction reactions in soils. As discussed in the foregoing sections, in reactions where the reactant or the product is in gas form, the partial pressure, instead of the concentration, of the gas can be used for formulating the redox potential. At equilibrium, the chemical potential of a substance in solution equals that of its vapor phase. Therefore, for the redox reaction of hydrogen gas according to the following reaction:



the concentration of  $H_2$  gas in solution is related to the partial pressure of hydrogen in the gas phase. The greater is the partial pressure of the  $H_2$  gas,  $P_{H_2}$ , the stronger is the reducing power of the half-cell reaction. In analogy to the definition of  $pH = -\log(H^+)$ , this reducing power of the redox reaction can be formulated similarly as follows:

$$rH = -\log(P_{H_2}) \quad (3.16)$$

where  $rH$  is the reduction intensity or reducing power of hydrogen, and  $P_{H_2}$  is the partial pressure of  $H_2$  gas (in atm) in equilibrium with the redox system. Under standard condition,  $rH = rH^\circ$ . The value of  $rH$  decreases (becomes more negative) when the concentration of the reduced species increases. At  $P_{H_2} = 1$  atm,  $rH = 0$ . In analogy with the definition of  $pH = pK$  when half of the electrolyte is dissociated (see Section 4.11),  $rH = pK$  too, when the concentration of the reduced species equals the concentration of the oxidized species.

Examples of numerical values of  $rH$  for selected redox reactions are listed in Table 3.4. The  $rH$  for the decomposition of water into oxygen and hydrogen shows that  $P_{H_2} = 10^{-41.6}$  atm. This extremely low partial pressure of  $H_2$  gas is in equilibrium with water and oxygen and has little, if any, reducing power on water. The  $rH$  value for the nitrite/nitrate reduction couple indicates that the  $P_{H_2} = 10^{-28.6}$  atm. This is also a very low partial pressure of  $H_2$  at equilibrium with the redox system and indicates that the nitrite/nitrate reduction couple is not strongly reducing. On the other hand, the malate/pyruvate redox couple has an  $rH$  value that supports a  $P_{H_2} = 10^{-2.8}$  atm. This moderate amount of pressure indicates a moderate reducing reaction status.

Kennedy (1992), therefore, indicates that  $rH$  represents the relative redox intensity better than the  $pe-pH$  or  $E_h-pH$  relation, and it also provides a simpler method by eliminating electrode

**TABLE 3.4**  
**Standard rH Values<sup>a</sup> for Selected Redox Reactions**

Reaction	rH <sup>o</sup>
$\text{H}_2\text{O} \leftrightarrow \frac{1}{2}\text{O}_2 + \text{H}_2$	41.6
$\text{NO}_2^- + \text{H}_2\text{O} \leftrightarrow \text{NO}_3^- + \text{H}_2$	28.6
$\text{S} + 3/2\text{H}_2\text{O} \leftrightarrow \frac{1}{2}\text{S}_2\text{O}_3^{2-} + \text{H}^+ + \text{H}_2$	10.4
$\frac{1}{2}\text{H}_2\text{S} + \frac{3}{4}\text{H}_2\text{O} \leftrightarrow \frac{1}{4}\text{S}_2\text{O}_3^{2-} + \frac{1}{2}\text{H}^+ + \text{H}_2$	8.1
$\frac{2}{3}\text{NH}_4^+ \leftrightarrow \frac{1}{3}\text{N}_2 + \frac{2}{3}\text{H}^+ + \text{H}_2$	4.6
$\text{Malate}^{2-} + \text{H}^+ \leftrightarrow \text{Pyruvate}^- + \text{H}_2 + \text{CO}_2$	2.8
$\frac{1}{2}\text{C}_6\text{H}_{12}\text{O}_6 + \frac{1}{2}\text{H}_2\text{O} \leftrightarrow \text{H}_2 + \frac{1}{2}\text{CO}_2$	-0.4
$\text{Pyruvate}^- + \text{H}_2\text{O} \leftrightarrow \text{Acetate}^- + \text{H}_2 + \text{CO}_2$	-0.9

<sup>a</sup> Standard rH is rH at pH = 7, and 25°C.

Sources: From Bray, H. G., and K. White. *Kinetics and Thermodynamics in Biochemistry*, Churchill Ltd., London, 1966; Kennedy, I. R. *Acid Soil and Acid Rain*, 2nd ed., Research Studies Press, Taunton, Somerset, England, 1992. (With permission.)

potential measurements. However, it should be realized that determination of redox or electrode potentials is a much simpler and easier method than the determination of partial pressures of  $\text{H}_2$  gas. Extremely small values of  $P_{\text{H}_2}$  are almost impossible to measure with accuracy and precision.

### 3.6.1 THE RELATIONSHIP BETWEEN rH AND pe + pH

rH is used to indicate the reduction status of soils. It is related to the pe–pH concept and, especially, to the reduction potential representing the lowest limit for stability of water. This reduction potential can be rewritten as:

$$E_h = E^o + (0.059) \log (\text{H}^+) - \frac{1}{2}(0.059) \log (P_{\text{H}_2}) \quad (3.17)$$

or

$$E_h = E^o - (0.059)\text{pH} - \frac{1}{2}(0.059) \log (P_{\text{H}_2}) \quad (3.18)$$

The value of  $E^o$ , calculated from the relation  $E^o = \Delta G_r^o / nF$  (see Section 4.17), equals zero; hence, Equation 3.18 changes to:

$$E_h = -(0.059)\text{pH} - \frac{1}{2}(0.059) \log (P_{\text{H}_2}) \quad (3.19)$$

Because  $E_h = 0.059\text{pe}$ , and  $\text{rH} = -\log (P_{\text{H}_2})$ , Equation 3.19 can be converted into:

$$0.059\text{pe} = -(0.059)\text{pH} + \frac{1}{2}(0.059)\text{rH} \quad (3.20)$$

Rearranging and division by 0.059 V gives:

$$\frac{1}{2}rH = pe + pH$$

or

$$rH = 2(pe + pH) \quad (3.21)$$

This final equation can predict the reduction intensity in soils in relation to rH, pe or  $E_h$ , and pH.

### 3.7 CHEMICAL POTENTIAL

The concept of chemical potential is very complex (Job and Hermann, 2006; Kaplan, 2006). Two different definitions, the Helmholtz and Gibbs, are adding to the confusion, whereas the use of high-level integral and differential equations is making it more difficult to understand. Therefore, the present author tries to translate the difficult theory into a simple, less-confusing concept. The chemical potential,  $\mu$ , as followed in chemistry was introduced by J. Willard Gibbs (1839–1903), who defined it as a free energy (G) change of the mass divided by the amount of added substance (n) as expressed by the differential equation as follows:

$$\mu = dG = \delta G / \delta n \quad (3.22)$$

However, in physical science, the chemical potential is formulated on the basis of the Helmholtz definition of free energy, A:

$$\mu = \delta A / \delta n$$

The *Gibbs free energy*, as used in chemistry, is the amount of energy in a system that can be converted into work at constant temperature and pressure. In contrast, the *Helmholtz free energy*, a much earlier concept used in physics, is the energy that can be converted into work at constant temperature and volume. Nevertheless, the two concepts are based on a similar principle, called *internal energy*. The latter is the kinetic energy due to vibrations of molecules and potential energy of the atoms in the molecules because of electrical and vibrational forces. The internal energy is increased by adding heat (energy) and is decreased when the species or system performs work. A certain amount of such free energy can be ascribed to each chemical species in a reaction mixture. This amount of energy, expressed per unit amount of ion species, is called here *chemical potential*. In line of the Gibbs concept, this entity, indicated by the symbol  $\mu$ , depends on the pressure P, the temperature T, the chemical nature of the ion species, and on its mixing ratio with other species. For ideal solutions, the chemical potential can be formulated as follows:

$$\mu = \mu^\circ + RT \ln m \quad (3.23)$$

where  $\mu$  is the chemical potential of an ion species;  $\mu^\circ$  is the chemical potential of the ion species at standard state; R is the gas constant; T is the absolute temperature (K); and m is the moles of ion species in the mixture (mol/L).

In some books, the chemical potential is defined as:

$$\mu = \mu^\circ + RT \ln m/m^\circ \quad (3.24)$$

In this equation,  $m^\circ$  is considered a hypothetical molality in which all interactions leading to deviations from ideal conditions have been canceled. Consequently, at standard state  $m^\circ = 1$ , and

Equation 3.24 converts automatically into Equation 3.23. For nonideal conditions, Equation 3.23 changes into:

$$\mu = \mu^{\circ} + RT \ln a \quad (3.25)$$

in which  $a$  is the activity of ion species. At infinite dilution (or very dilute) conditions, Equation 3.25 can be changed into:

$$\mu = \mu^{\circ} + RT \ln c \quad (3.26)$$

In this equation,  $c$  denotes the concentration of the ion species (mol/L). Because  $\mu^{\circ}$  is considered a constant, the chemical potential can be written as  $\mu = RT \ln m$  (ideal),  $\mu = RT \ln a$  (nonideal), and  $\mu = RT \ln c$  (very dilute condition) plus a constant. For practical purposes, the equations for the foregoing chemical potentials can be converted into  $\log_{10}$  format, and Equation 3.26, for example, can be changed into:

$$\mu = \mu^{\circ} + 2.3RT \log c \quad (3.27)$$

Because  $R$  is a known constant, at  $T = 25^{\circ}\text{C} = 298 \text{ K}$ , Equation 3.27 converts automatically into:

$$\mu = \mu^{\circ} + 1.364 \log c \quad (3.28)$$

or

$$\mu = 1.364 \log c + \text{constant} \quad (3.29)$$

The chemical potential as formulated above indicates the state of potential energy of the chemical species or component in soils, and its value is independent of external force fields, such as gravity or centrifugal force. Hence, it remains constant at any distance from the soil surface. It is also constant at equilibrium conditions, characterized by constant concentrations, temperatures, and pressures. Differences may occur at nonequilibrium conditions, owing to differences in concentrations, temperatures, and pressures. They are the driving force in nature for the fluxes of solvents and solutes. Therefore, differences in chemical potentials of a species in various locations in soils tend to induce spontaneous movement of the species in the directions of points from higher to lower potentials until equilibrium is attained. At equilibrium the chemical potentials at any respective location become similar in value.

### 3.8 ELECTROCHEMICAL POTENTIAL

In contrast to the *chemical potentials* described above which apply to charged as well as to non-charged soil solutes, *electrochemical potentials* are properties exhibited only by electrically charged solutes or ions. They are formulated by combining the chemical potential with the electrical potential, also called *electrostatic potential* by Friedman (2008), as follows:

$$E = \mu + zF\Psi \quad (3.30)$$

in which  $E$  is the electrochemical potential,  $\mu$  is the chemical potential,  $z$  is the valence of the ion,  $F$  is the Faraday constant, and  $\Psi$  is the electrical or electrostatic potential. For uncharged substances,  $z = 0$ , and hence,

$$E = \mu + 0 \quad (3.31)$$

In other words, the electrochemical potential is (equals) the chemical potential. This is then the reason why the electrochemical potential applies only to charged solutes as indicated above.

The electrochemical potential, as formulated above, is often applied to describing ion transport, movement, and adsorption in soil. In addition, it is particularly useful in predicting ion uptake by plant roots and ion transport from cell to cell in the plant body, which is a major topic below.

### 3.9 MEMBRANE OR DONNAN POTENTIAL

The *membrane potential*, also called *transcellular membrane potential* or *transmembrane potential*, is the potential difference across living cells. It is created by the actions of ion pumps and ion carriers in ion channels located in life biological membranes (Sten-Knudson, 2007). Frederick George Donnan (1870–1956), an Irish electrochemist, made a career in studying electrochemical potentials developed at semipermeable membranes between two electrolytes. His discovery for the now famous *Donnan Equilibrium principle* is the reason for also calling the membrane potential the *Donnan potential*. The concept of membrane potentials is used for the investigation and determination of nutrient uptake by plant roots and ion transport from cell to cell in the plant body.

The selective uptake of chemical compounds by the root system is an outstanding process of living systems. Cell compartments in the plant tissue are separated by biological membranes representing barriers for chemical compounds. The transport through these barriers and processes mediating this transport can be studied and described using chemical potentials. Although not clearly understood, it is currently accepted that plant cells behaving as biological membranes have pores acting as sieves, favoring penetration of small particles only. This kind of passive transport (diffusion and mass flow) of small hydrophilic particles obeys physical and chemical laws. The net ion flux in either direction will stop as soon as a state of equilibrium is reached. At equilibrium, the system conforms to the *Donnan principle*. With compounds that are not electrically charged (e.g., sucrose), the equilibrium is attained when the *chemical potentials* are equal on both sides of the membrane—in simple language, when equal sucrose concentrations exist on either side of the membrane, which is illustrated as follows:

$$\mu_i = \mu_o \quad (3.32)$$

$$RT \ln a_i = RT \ln a_o$$

$$a_i = a_o \quad (3.33)$$

where  $\mu$  is the chemical potential;  $i$  is the inside, and  $o$  is the outside;  $R$  is the gas constant;  $T$  is the absolute temperature in degrees K; and  $a$  is activity. Because  $a = yc$  ( $y$  is the activity coefficient as discussed in Chapter 4) and  $c$  is the concentration (mol/L), Equation 3.33 becomes:

$$(yc)_i = (yc)_o$$

At infinite dilution,  $y = 1$ ; hence,

$$c_i = c_o \quad (3.34)$$

However, with ions possessing electrical charges, the *electrochemical potential* must be equal on both sides of the membrane; hence:

$$\mu_i + zF\Psi_i = \mu_o + zF\Psi_o \quad (3.35)$$

where  $z$  is the valence,  $F$  is the Faraday constant,  $\Psi$  is the electrical or electrostatic potential, and the other symbols are as defined above.

Again substituting  $RT \ln a$  for  $\mu$ , Equation 3.35 becomes:

$$(RT \ln a)_i + zF\Psi_i = (RT \ln a)_o + zF\Psi_o \quad (3.36)$$

$$zF\Psi_o - zF\Psi_i = (RT \ln a)_i - (RT \ln a)_o$$

$$\Psi_o - \Psi_i = (RT/zF) \ln (a_i/a_o) \quad (3.37)$$

$\Psi_o - \Psi_i$  is called the *membrane* or *Donnan potential*, as indicated earlier. It is also known as the *Donnan law*, *Gibbs–Donnan*, or *Donnan equilibrium*, names given in honor of *Donnan*, who discovered the behavior of charged particles moving through semipermeable membranes to fail distributing evenly on both sides of the membrane. By changing  $(\Psi_o - \Psi_i)$  into symbol  $E$ , Equation 3.37 takes the form of the Nernst equation:

$$E = (RT/zF) \ln (a_i/a_o) \quad (3.38)$$

Because  $\Psi_o - \Psi_i$  or  $E$  is a positive figure, we have  $a_i > a_o$  for cations,  $a_i < a_o$  for anions, and  $z$  is negative.

At equilibrium, the chemical potential of cations also equals the chemical potential of anions. This is necessary to maintain electroneutrality. Therefore:

$$E_c = (RT/zF) \ln (a_i/a_o)_c \text{ equals } E_{an} = (RT/zF) \ln (a_o/a_i)_{an}$$

where  $c$  is cations and  $an$  is anions. Consequently:

$$(a_i/a_o)_c = (a_o/a_i)_{an} = \text{constant} \quad (3.39)$$

The latter means that the ion product on either side of the membrane is constant. If  $KCl$  or  $CaCl_2$  is present in the system, then according to the Donnan equilibrium principle, the following is valid:

$$[(K^+)(Cl^-)]_{inside} = [(K^+)(Cl^-)]_{outside}$$

or

$$[(\sqrt{Ca^{2+}})(Cl^-)]_{inside} = [(\sqrt{Ca^{2+}})(Cl^-)]_{outside}$$

Once again, one needs to remember that the foregoing hypothesis has been developed for equilibrium condition. One must also take into consideration that in most metabolically active living cells, no equilibrium will exist between the two sides of the membrane. Metabolism is continuously consuming ions on the inside, and thereby, it is constantly disrupting the equilibrium condition favoring passage of ions from the outside.





---

# 4 Soil Gas and Liquid Phases

## 4.1 THE GASEOUS PHASE

As discussed before, the soil gas and liquid phases are located in the pore spaces or voids. Depending upon the conditions, the total pore space may vary from approximately 25% (Manahan, 1975, 2009) to 50% by volume in loam surface soils optimum for plant growth. At this condition, these voids are filled with 50% air and 50% water (Brady and Weil, 2008). Generally, a dynamic equilibrium exists between the air and water content. When water enters the soil, it displaces air from the pore spaces. When the water evaporates from the soil or is taken up by plant roots, air is moving into the pores. The composition and chemical behavior of the gas and liquid phases are determined by the interaction with the solid phase.

## 4.2 COMPOSITION OF SOIL AIR

The gaseous phase, or *soil air*, is a mixture of gases, and its content and composition are determined by soil–water–plant relationships. Whereas atmospheric air contains 20% oxygen, 0.03% carbon dioxide, and 78% nitrogen by volume, soil air tends to be lower in oxygen (<20%) and higher in carbon dioxide, CO<sub>2</sub>, content (>0.03%). In soil air, the CO<sub>2</sub> content may be 10 times or considerably higher than that in atmospheric air. It can reach levels of 5% but can be as low as 0.3%. Soil air in direct contact with plant roots, generally in the form of *films*, often contains ≥90% CO<sub>2</sub>. The concentration of CO<sub>2</sub> in the atmosphere, as indicated by the *Mauna Loa data set* (Keeling et al., 2008), has increased steadily from 0.0316% in 1958 to 0.0384% in 2007, because of the industrial revolution and other anthropogenic activities. This CO<sub>2</sub> content is reported to also fluctuate during the year corresponding to the growing season in the northern hemisphere, where CO<sub>2</sub> content increases by 3 ppm (0.0003%) in spring to 9 ppm (0.0009%) in May and decreases again to minimum levels in October. Ironically, high CO<sub>2</sub> levels in the atmosphere may cause the soil to lose significant amounts of CO<sub>2</sub>. Agricultural practices also increase the release of CO<sub>2</sub> from soils (Roberson et al., 2008; Sainju et al., 2008). The soils in temperate regions have been reported to release about 300 times the amount of carbon a year than burning fossil fuels (Graff and Reaney, 2005). Soil air is also higher in moisture content with relative humidities often reaching levels of 100%. Generally, the relative humidity of soil air is not as variable as that in atmospheric air. Under restricted aeration, because of waterlogging, soil air may also contain methane, CH<sub>4</sub>, and some H<sub>2</sub>S gas, formed by anaerobic fermentation of organic matter. Swampy conditions and high organic matter content contribute to the formation of appreciable amounts of CH<sub>4</sub>.

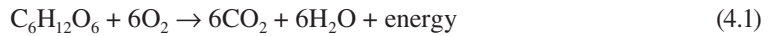
The differences in composition between soil and atmospheric air are the result of plant respiration and decomposition of soil organic matter, which can take place in *aerobic* and *anaerobic* or *anoxic* conditions. The processes will be discussed in more detail in the sections below.

### 4.2.1 AEROBIC RESPIRATION AND DECOMPOSITION

In well-aerated typical soils, the major gases in soil air are N<sub>2</sub>, O<sub>2</sub>, and CO<sub>2</sub>. As discussed above, the oxygen content in soil air tends to decrease below 20%, whereas that of CO<sub>2</sub> tends to increase above 0.03%. Two biological reactions are responsible for the imbalance in O<sub>2</sub> and CO<sub>2</sub> contents in soil air. They are *respiration* and *decomposition* reactions.

#### 4.2.1.1 Aerobic Respiration of Plant Roots and Soil Organisms

Plant roots and soil organisms absorb oxygen and give off carbon dioxide. This exchange of gases (Martin et al., 1976; Rich, 2003), by a process called *cellular respiration* or just *respiration*, involves the breakdown of sugars by oxidation; hence, the term *oxidative respiration* is sometimes also used. The reaction can be represented as follows:



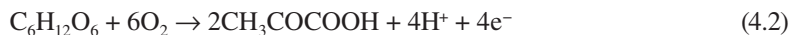
The energy released is needed by the plants and microorganisms to perform work and growth. The process, an important part of the metabolism in plants and animals, is often called *catabolism* (Campbell et al., 2006).

#### 4.2.1.2 Aerobic Decomposition of Organic Matter

Decomposition is an essential part of the carbon cycle. This reaction, occurring outside the plant body, also consumes  $\text{O}_2$  and produces  $\text{CO}_2$ . In this process, soil organic matter is broken down into  $\text{CO}_2$  and  $\text{H}_2\text{O}$  by an oxidation reaction similar to Equation 4.1. The energy, released in the form of heat, is usually noticed by the increase in temperature underneath a composting pile of organic matter.

### 4.2.2 ANAEROBIC RESPIRATION AND DECOMPOSITION

In poorly aerated soils, *anaerobic respiration* is the process by which energy needed for performing work is generated. Soils can become waterlogged, especially when poorly permeable subsoils are present. Soil compaction as a result of the use of heavy tractors can also restrict aeration. Swamps in wetland areas, flood plains inundated by overflowing rivers and streams, and deliberately flooded soils for paddy rice culture are additional examples. Under very low supply of oxygen, a condition may develop that is sometimes referred to as *anaerobiosis*, meaning life in the presence of extremely low oxygen content or, better, *life in anaerobic environments*. Under normal conditions, one of the first steps in *aerobic catabolism* is the release of electrons as shown by the following reaction:



With oxygen in sufficient supply, oxygen is the terminal acceptor for the electrons released above:



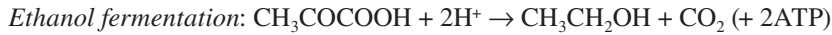
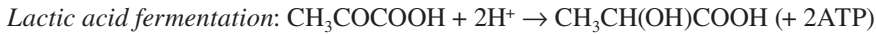
#### 4.2.2.1 Anaerobic Respiration

In anaerobic conditions, other substances are used by anaerobic organisms as electron acceptors, as illustrated by the reactions below:



Many other types of bound oxygen, such as  $\text{FeO}$ ,  $\text{Fe}_2\text{O}_3$ , and  $\text{MnO}$ , can also be used by anaerobic organisms in the absence of sufficient amounts of free oxygen. This type of respiration is called *anaerobic respiration* or *fermentation*, and in the initial reaction, glucose is broken down into two *pyruvic acid* or *pyruvate*— $\text{CH}_3\text{COCO}(\text{OH})$ —molecules as illustrated by Equation 4.2. The pyruvate

is further broken down in the absence of oxygen into either lactic acid or ethanol by fermentation as follows:



Therefore, at low levels of free oxygen contents, respiration processes of anaerobic organisms turn to fermentative pathways, processes carried down from the metabolism of prehistoric organisms in the days when earth's atmosphere did not contain oxygen (Wächtershäuser, 2000; see also Section 4.3). Some people distinguish between *anaerobic respiration* and *fermentation*. *Fermentation* is an *extracellular reaction* occurring outside the plant or microbial cells, such as the breakdown of organic matter outside the living body of microorganisms. In contrast, *anaerobic respiration* is a *cellular process* using similar reaction principles but occurring within the body of living organisms.

#### 4.2.2.2 Anaerobic Decomposition

From the discussion above, it is perhaps clear that organic matter attacked by the anaerobic organisms in search of energy and food are broken down without free (gaseous) oxygen. The process, called *anaerobic decomposition*, is mainly a *reduction* instead of an *oxidation* process. As indicated above, it is also called *fermentation* and produces biogas and other by-products. The organic nitrogen is generally reduced into ammonia,  $\text{NH}_3$ , gas, and organic sulfur into hydrogen sulfide,  $\text{H}_2\text{S}$ , gas. The carbon not used for food or production of cells by the microorganisms is left to accumulate in the organic matter residue as humus, which is a very valuable soil constituent. The fermentation product can also be determined by the presence of the dominant microbial decomposers. When yeast is present, sugars are usually broken down into alcohol as illustrated by the following reaction:



In the presence of *methanogenic bacteria* or *methanogens*, the organic matter is reduced into methane ( $\text{CH}_4$ ), a biogas. In intensive reduction of organic matter, called *putrefaction*, foul-smelling products, such as mercaptans, are produced.

Hence, *aerobic* respiration and decomposition reactions consume oxygen and produce carbon dioxide, depleting the  $\text{O}_2$  and increasing the  $\text{CO}_2$  contents in soil air. On the other hand, *anaerobic* respiration and decomposition do not affect the amount of  $\text{O}_2$  in soil air but produce some  $\text{CO}_2$ , whereas *anaerobic decomposition* may deposit lots of humus in the soil. Unfortunately no biochemical reactions are present in the soil which can replenish the depleted  $\text{O}_2$  content in soil air or correct the  $\text{O}_2$  and  $\text{CO}_2$  balance. Photosynthesis is the only biological reaction known to produce oxygen and to consume carbon dioxide. However, photosynthesis occurs in plant parts growing above the soil. The green plants are even capable of absorbing excess  $\text{CO}_2$  from pollution and releasing  $\text{O}_2$  in the atmosphere. Hence, they act as a cleaner for polluted air, and their destruction, as occurs by large-scale deforestation, for example, may decrease the quality of air that we breathe. Therefore, the  $\text{O}_2$  and  $\text{CO}_2$  content in soil air can be corrected only by exchange of soil air for atmospheric air, a process called *aeration*.

### 4.3 THE OXYGEN REVOLUTION

From the discussion above, it is perhaps clear that oxygen is a key constituent of soil air. The oxygen that life depends on today was generated for the first time some 2.5 billion years ago in the *Proterozoic era* by the most primitive organisms, presumably *cyanobacteria* living in the sea. This started what we call today the *Oxygen Revolution*. According to Keddy (2007), the oxygen

revolution has brought three types of drastic changes on earth: (1) changes in ocean chemistry, (2) changes in composition of the atmosphere, and (3) formation of the ozone shield. Before the Proterozoic time, earth's atmosphere was of a very different composition, perhaps containing  $\text{NH}_3$ ,  $\text{CO}_2$ ,  $\text{CH}_4$ , and other toxic gases, making life as we know it today impossible. Once oxygen started to accumulate, the toxic gases were oxidized. For example, ammonia was oxidized into nitrates and washed down by rains onto the surface of the earth. Because oxygen at that time was toxic to anaerobic life on earth, drastic ecological changes occurred in the biosphere. To prevent an ecological disaster from happening, biochemical methods had to evolve for rendering oxygen harmless. Plants learn to assimilate two types of nitrogen, ammonium and nitrates. New pathways of respiration, called *oxidative respiration*, developed over time from the older systems that used fermentation principles. Cell walls developed to provide protection to the inner cell's tissue and constituents from oxidation. The oxygen in the atmosphere is attacked by ultraviolet radiation from the sun, resulting in the production of *ozone*,  $\text{O}_3$ . As oxygen levels continued to rise, an ozone layer started to develop shielding earth's surface from the harmful effect of the sun's ultraviolet radiation, which has now made present-day life possible.

#### 4.4 SOIL AERATION OR AERIFICATION

The term *aeration* has different meanings for a number of people. For example, in the soft drink industry, it is adding  $\text{CO}_2$  gas, like in the manufacture of cola drinks, whereas in ponds and sewage treatment plants, it is exposing essentially to  $\text{O}_2$  by spraying the liquid into the air as a fountain spray. In soil science, aeration means replacing soil air for atmospheric air, which can be achieved by several mechanical methods. It is believed to be an empirical parameter, because the result is determined by plant performance and  $\text{O}_2$  status in soil air (Cook and Knight, 2003). The soil surface, in particular, can be crumbled by plowing and raking, like in seedbeds, or the soil can be punctured by spikes, which is known as *spike aeration*, or by removing small cores, which is called *core aeration*. The latter two methods are called *aerification* in the turf and golf business. A common purpose of all these mechanical manipulations is to increase the *macropores* and the *gas-filled proportion* of the total soil pores, facilitating movement of atmospheric air into the soil. The macropores are the main channels for air transport and storage, whereas the gas-filled proportion allows for easy entry of  $\text{O}_2$  into and removal of  $\text{CO}_2$  from the soil (Cook and Knight, 2003). The mechanisms of exchange involve both *mass flow* and *diffusion*. However, many soil scientists consider diffusion as the major process contributing to soil aeration (Brady and Weil, 2008; Stolzy, 1974), though at the initial stage after plowing and raking, mass flow is expected to play a major role.

The exchange of soil air for atmospheric air, called *aeration*, is essential when  $\text{O}_2$  deficiency occurs and excessive amounts of  $\text{CO}_2$  are present in soil air. Carbon dioxide production per day of approximately  $7 \text{ L/m}^2$  is considered normal (Taylor and Ashcroft, 1972), and at this rate, the amount of  $\text{CO}_2$  produced has to be totally replaced with fresh air to a depth of 20 cm every hour. This type of aeration is called by Taylor and Ashcroft (1972) the *normal aeration*, which can be used as a standard for comparative studies in soil aeration.

##### 4.4.1 MASS FLOW

Movement of soil air by mass flow is considered of importance perhaps only at or near the surface soils. As indicated above, it is facilitated by crumbling the soil through plowing and raking, such as in the creation of seedbeds. The major factor is a gradient of total gas pressure causing the entire mass of atmospheric air to flow into the soil or vice versa. It is mainly due to the differences in pressures between soil air and the atmosphere, and is affected by barometric pressures, temperatures, and wind gust. Changes in barometric pressures and temperatures may result in expansion or contraction of soil air, whereas wind action may force masses of air into the soil. Deeper in the soil,

mass flow is caused by gas pressure gradients in soil air, forcing the entire bulk of gas to move from high- to low-pressure regions.

#### 4.4.2 DIFFUSION

Movement of soil air by diffusion occurs when a gradient in partial pressures occurs of the gaseous components. Such concentration differences are common in healthy soils due to the biological consumption of O<sub>2</sub> and simultaneous production of CO<sub>2</sub>. Each of the gas types in question moves by its own partial pressure gradient even when the bulk of air mass as a whole is stationary. Taylor and Ashcroft (1972) recognize two types of diffusion: (1) diffusion of gas type in the soil air spaces and (2) diffusion of gas in solution through the liquid phase to plant roots. The diffusion through the soil air space at constant temperature conforms to *Fick's law* that is represented by the following differential equation:

$$J_g = -D (\partial C/\partial x) \quad (4.5)$$

where  $J_g$  is the diffusion flux density of gas component  $g$  (in mg/cm<sup>2</sup>/s), in our case of oxygen;  $D$  is the oxygen diffusion coefficient;  $C$  is the oxygen concentration in soil air (in g/m<sup>3</sup>);  $x$  is the distance in soil (in m); and  $\partial C/\partial x$  is the oxygen concentration gradient.

The value of  $D$  in soil air is about 10,000 greater than that in soil water and is reported to be affected by the (1) continuity of air-filled pores, which decreases with increasing water content, and (2) amount of air-filled porosity, which also decreases with increasing soil water content.

### 4.5 CHARACTERIZATION OF SOIL AIR QUALITY

A wide variety of methods were reported for the characterization of O<sub>2</sub> and CO<sub>2</sub> content of soil air within the pores of soils. Generally, O<sub>2</sub> content is very low during late fall, winter, and early spring (<1%), whereas CO<sub>2</sub> content can reach a maximum of 12% in summer, when moisture conditions and soil temperature are favorable for biological activities (Stolzy, 1974). Though a high concentration of CO<sub>2</sub> may cause toxicity, generally, it is deficiency of O<sub>2</sub> that is believed to be more harmful to plant growth by inhibiting root respiration (Cook and Knight, 2003). An O<sub>2</sub> content <15% will show a progressive decrease in nutrient uptake, although values of 5% to 10% O<sub>2</sub> in soil air have been reported to sustain growth of existing root tips. Several methods have been proposed for the determination of the quality of soil air, for example, through (1) measurement of O<sub>2</sub> content in soil air, (2) determination of the oxygen diffusion rate or ODR value, and (3) determination of the redox potential.

#### 4.5.1 DETERMINATION OF O<sub>2</sub> CONCENTRATION

The determination of O<sub>2</sub> content as a means of characterizing soil air quality has received mixed reactions. The O<sub>2</sub> content is often only slightly lower than 20% in the upper layers of friable, well-drained soils. It can decrease to 5% or even <1% in the subsoil, but most roots seldom grow into subsoils. When O<sub>2</sub> content is low in soil air, frequently a significant amount of O<sub>2</sub> is still present as dissolved oxygen in soil moisture. More attention has been given to the determination of ODR values.

#### 4.5.2 DETERMINATION OF THE OXYGEN DIFFUSION RATE (ODR)

As the name *oxygen diffusion rate* implies, this method determines the rate at which O<sub>2</sub> diffuses into the soil. It is, in essence, determined by an electrochemical method using Pt electrodes placed in soils. The amount of oxygen measured, expressed in units of μg m<sup>-2</sup> s<sup>-1</sup> (Stepniewski, 2006), or in the more common way of μg cm<sup>-2</sup> min<sup>-1</sup> (Kirkham, 2005), is often assessed as soil oxygen available to plant roots. The analysis is affected by a number of soil factors, including soil moisture content,

air-filled pore spaces, and any other interactions in soils. Frequently, *electrode poisoning* is the major factor in the determination, which is caused by chemical deposition on the Pt electrode surface. Calcium bicarbonate and micaceous clay have been deposited on the microelectrode surfaces when left in place for a period of time. This tends to reduce the measurement of the ODR values by 50% (Kirkham, 2005). Generally, values of ODR in soils vary from 0 to  $2 \mu\text{g cm}^{-2} \text{min}^{-1}$ , with the highest values measured mostly in surface soils and lowest values in subsoils. The values tend to increase with soil moisture tension, air-filled porosity, and  $\text{O}_2$  content in soil air. A proportion of the soil pore space needs to be gas filled for influx of  $\text{O}_2$  into and outflux of  $\text{CO}_2$  from soil air. It is believed that oxygen is transported from the atmosphere first by diffusion through the gas-filled pores to the depth of plant roots and then through a *liquid-filled film*, surrounding the roots (Cook and Knight, 2003). The *critical ODR value* or *minimum ODR value* of soils in which root growth stops is  $0.20 \mu\text{g cm}^{-2}$  per minute, and at this value the soil is considered at a *hypoxic level* (see Section 4.8.4 for *hypoxia*). The low ODR values with depth should be interpreted with caution, because a value of  $0.04 \mu\text{g cm}^{-2} \text{min}^{-1}$  at 30 cm (12 inches) soil depth is often considered normal by many authors. However, an ODR equal to  $0.060 \mu\text{g cm}^{-2} \text{min}^{-1}$  has often been noted critical for many grass species, like lowland rice (Cook and Knight, 2003). Generally, the  $\text{O}_2$  status is at a sufficient level when the ODR value is  $1.5 \mu\text{g cm}^{-2} \text{min}^{-1}$  (Kirkham, 2005; Wilkinson, 2000). Root growth of many plants will be inhibited at an ODR between  $0.20 \mu\text{g}$  and  $0.30 \mu\text{g cm}^{-2}$  per minute (Stolzy and Letey, 1964). Naturally, tolerance to low ODR varies from plant to plant, and the following decreasing order of tolerance is reported: rice > corn > Bermuda grass > barley > Newport bluegrass (Stolzy, 1974).

### 4.5.3 DETERMINATION OF THE REDOX POTENTIAL

The third method, by determination of the redox potential, is perhaps a simpler method than the determination of ODR values. The analysis is also conducted by means of inserting electrodes in soils, and the readings are in mV or volts, with negative values generally indicating soils with poor aeration and positive values signifying soils with proper aeration. Redox potentials are especially useful in the characterization of aeration status of soils where ODR values have no meaning, such as in poorly drained and waterlogged soils (Ponnampereuma et al., 1966). The redox potential above a certain value has been found to indicate that the soil is sufficiently aerated so that nitrates are stable and remain available to plants. A value of 350 mV was stated by several authors to be the *threshold value* for the start of reduction of nitrate–nitrogen, and denitrification may occur below this value (McBride, 1994; Wafer et al., 2004). More will be discussed on the application of redox potentials in soils in Chapter 10.

## 4.6 HUMIDITY OF SOIL AIR

In addition to the gases discussed in previous sections, soil air contains varying amounts of water vapor as indicated in Section 4.1.1, and its presence must be taken into account in many chemical and biochemical reactions in soils. For example, the dissolution of  $\text{O}_2$  and  $\text{CO}_2$  gas in soil water, as explained in Section 4.3.2, is influenced to a large degree by the presence of water vapor in soils.

As is the case with atmospheric air, the amount of water vapor in soil air can also be expressed in terms of relative humidity, absolute humidity, and specific humidity (Van Wijk and De Vries, 1963).

### 4.6.1 RELATIVE HUMIDITY

The *relative humidity* is defined as “the ratio of the partial pressure of water vapor,  $P_w$ , to the saturation pressure,  $P_w^s$ , at temperature  $t$ .” This definition can be represented by the following equation:



$$\text{Relative humidity} = (P_w)/(P_w^s) \quad (4.6)$$

Therefore, the use of the term *low relative humidity* indicates only that  $P_w$  is smaller with respect to  $P_w^s$ , and *high relative humidity* is when  $P_w$  approaches  $P_w^s$ , at temperature  $t$ . The value for relative humidity is usually expressed as a percentage, and Equation 4.6 can be changed accordingly into:

$$\text{Relative humidity} = [(P_w)/(P_w^s)] \times 100\% \quad (4.7)$$

This means that at saturation,  $P_w = P_w^s$ , and the relative humidity of soil air is 100%. The temperature at which  $P_w = P_w^s$  is called the *dew point temperature*. If the air is cooled below its dew point, dew formation (condensation) occurs. In weather forecasting, a dew point temperature of  $\geq 12.5^\circ\text{C}$  is considered indicative of formation of a thunderstorm, but dew point temperatures should be  $\geq 18.3^\circ\text{C}$  before much rainfall can be expected from the thunderstorms. Dew point temperatures of  $24^\circ\text{C}$  are called *oppressive dew points*. Not much is known in the literature as to whether these limits can be applied in soil air for increasing soil moisture contents by condensation. One article published by Ravi et al. (2004) stated that only the variations in surface soil moisture content in aridisols were affected by atmospheric humidity.

#### 4.6.2 ABSOLUTE HUMIDITY

The absolute humidity is the density of water vapor in soil air (g/mL). Because the density of a perfect gas (at temperature  $t$ ) is proportional to its partial pressure, the absolute humidity can be expressed in terms of partial pressure. For practical purposes, water vapor is considered a perfect gas; hence, Henry's rule applies:

$$P_w V_w = RT \quad (4.8)$$

where  $P_w$  is the partial pressure of water vapor,  $V_w$  is the volume of water vapor (mL),  $R$  is the gas constant, and  $T$  is the absolute temperature (K). Because  $R$  is constant (see Appendix A),  $V_w = m_w/D_w$ , and the mass of 1 mol of  $\text{H}_2\text{O}$ ,  $m_w = 18$  g, Equation 4.8 changes into:

$$(18/D_w)/P_w = RT \quad (4.9)$$

or

$$D_w = (2.19 \times 10^{-4})P_w/T \quad (4.10)$$

where  $D_w$  is the density of water vapor,  $P_w$  is the partial pressure of water vapor in mbars, and  $T$  is the absolute temperature in degrees K.

#### 4.6.3 SPECIFIC HUMIDITY

The specific humidity is the mass of water vapor per unit mass of moist air; thus:

$$\text{Specific humidity} = (m_w P_w)/(m_t P_t) \quad (4.11)$$

In this equation,  $m_w = 18$  g (molecular weight of water),  $P_w$  is the partial pressure of water vapor,  $m_t$  is the molecular weight of total moist air, and  $P_t$  is the total pressure. For practical purposes,  $m_t = m$  of dry air = 29 (Van Wijk and De Vries, 1963).



## 4.7 HYDROTROPISM

*Hydrotropism* is a phenomenon in which plant roots are responding to a gradient in relative humidity in soil air (Eapen et al., 2005), though some people define it as a root response to a gradient in soil moisture content. Plant roots tend to grow in soil toward the direction of higher levels of relative humidity (or moisture contents). It is very difficult to observe the effect above without disturbing the soil, but it can perhaps be studied without disturbing the soil in *rhizotrons*. Hydrotropism may be an important factor for growing plants in space. It was noted that on earth hydrotropism was effective only over short distances of a few millimeters (Takashi et al., 2003). In space, it may perhaps be affected or subject to interactions by *gravitropism* or *hypogravity*, conditions with zero gravity (Tan, 2009). The force of gravitropism in space was believed to be stronger than that of hydrotropism (Takashi et al., 2003).

## 4.8 THE LIQUID PHASE

The liquid phase is also called the *soil solution*. In chemistry, a *solution* is defined as a homogeneous mixture of two components, the *solvent* and the *solute*. Gases, liquids, or even solids can act as a solvent. Solutes are defined as the dissolved substances generally in ionic forms, but they can also be in the form of gas, liquid, or solid. For example, air is a gaseous solution, because it fits the definition of solutions being a homogeneous mixture of oxygen, nitrogen, CO<sub>2</sub>, and other gases present in the atmosphere. By such a definition, two types of solutions can then be recognized in soils: (1) a *gaseous solution* or *soil air* that was discussed in Section 4.1 and (2) a *soil solution*, which is the topic of this section. The soil is not dissolved, but the term is used to refer to the solution present in the soil macro- and micropores.

### 4.8.1 THE CONCEPT AND IMPORTANCE OF THE SOIL SOLUTION

In soils, the solvent is always water, and many people become so used to it that terms such as *soil water* and *soil moisture* become common for referring to the *soil solution*. The solutes consist of truly dissolved substances (ions), free salts, CO<sub>2</sub>, O<sub>2</sub>, and other gases and inorganic and organic compounds in a dispersed state, called *colloids*. The organic colloids are, for example, carbohydrates, lignin, and humic substances, whereas the inorganic colloids are mainly the clays (particles  $\leq 2 \mu\text{m}$  in diameter). The dissolved materials are usually attracted or attached to clays, to other inorganic and organic solutes, or to a combination thereof. Depending upon the forces acting upon soil water, the water may be free to move, but the movement of solutes may be more or less constrained or may also affect some constraint on the movement of water. Soil water also contains several gases, although the solubility of these gases is relatively small. *Henry's rule* indicates that the solubility of a gas in a liquid is proportional to the partial pressure of the gas in contact with the liquid. Water vapor possesses a partial pressure that influences gas solubility. Two important types of gases, which may dissolve in soil water, are oxygen and carbon dioxide. Whereas the oxygen content in soil water is vital for the growth of many organisms, such as aerobic bacteria, carbon dioxide may react with water to form H<sub>2</sub>CO<sub>3</sub>. As a weak acid, H<sub>2</sub>CO<sub>3</sub> may affect the soil pH. The soil solution as described is the medium in which most soil chemical and biochemical reactions occur. It bathes the plant roots and forms the source from which the roots and other organisms obtain their inorganic nutrients and water. Therefore, the soil solution provides the chemical environment of plant roots, and defining plant–soil–water interrelations in quantitative terms requires a complete and accurate knowledge of soil solution chemistry and the laws governing it.

### 4.8.2 APPROXIMATIONS OF SOIL SOLUTIONS

A number of methods have been proposed to isolate the soil solution from the solid part of soils. These methods can be grouped into five categories: (1) suction method, (2) displacement method, (3)

compaction method, (4) centrifugation method, and (5) molecular adsorption method. The displacement method, used for the first time in France by Schloessing in 1886, appears to be the preferred method for isolating soil solutions (Adams, 1974; Parker, 1921; Richards, 1941). The displacing liquid, a liquid that does not mix with water (hence the name *immiscible displacing liquid*), is usually forced into a moist soil column using a pressure-plate apparatus. Ethanol appears to be the most efficient reagent for displacing soil moisture in the soil, and at one time KCNS solutions or  $\text{CaSO}_4 + \text{KCNS}$  were also used. However, more recently a displacement–centrifugation technique was used by Gollany et al. (1997) with fluorocarbon as the immiscible displacing liquid for collection of rhizosphere soil–water, whereas Levine (2000) used hydrofluoroether for collection of limestone dissolution products in soil water. The issue of *gravity segregation* was brought up in horizontal displacement of liquids with different densities, which would result in considerable errors of measurement (Rose et al., 2007). Water collected from a saturated paste extract, called *water extract*, is also considered by some as an approximation of the soil solution, though it should be cautioned that the saturated soil extract is not synonymous with a soil solution (Adams, 1974).

#### 4.8.3 THE EFFECT OF THE GAS PHASE ON THE SOIL SOLUTION

As indicated in the previous section, the soil solution may contain dissolved  $\text{CO}_2$  and  $\text{O}_2$  gas. *Henry's law* dictates that the solubility of these gases in soil water is proportional to the partial pressure of the gases in contact with the soil solution, as expressed by

$$C_{\text{aq}} = kP_t \quad (4.12)$$

where  $C_{\text{aq}}$  is the concentration of dissolved gas in moles/L,  $k$  is Henry's law constant, and  $P$  is the partial pressure of gas (in atm) at temperature  $t$ . The  $k$  values for the two gases above are very small:

	$k$ (mol/L/atm)
$\text{CO}_2$	$3.38 \times 10^{-2}$
$\text{O}_2$	$1.28 \times 10^{-3}$

Since the medium, water, in which the gas dissolves also exhibits a vapor pressure, both the water vapor pressure and the partial pressure of the gas then determine the amount of gas dissolved. The vapor pressure of water at  $25^\circ\text{C}$  is 0.0313 atm. Using these parameters, the amount of gas dissolved can be calculated. An example of the calculation for the amount of  $\text{CO}_2$  dissolved is given below. Because soil air in equilibrium with atmospheric air has a pressure of 1 atm, and atmospheric air contains 0.03%  $\text{CO}_2$  gas at  $25^\circ\text{C}$ , the following is valid:

$$\begin{aligned} P_{\text{CO}_2} &= (\text{atmospheric pressure} - \text{water vapor pressure}) \times 0.0003 \\ &= (1 - 0.0313) \times 0.0003 = 2.9 \times 10^{-4} \text{ atm} \end{aligned}$$

Using Henry's law, the concentration of  $\text{CO}_2$  dissolved in the soil solution is as follows:

$$\begin{aligned} C_{\text{aq}} &= kP_t \quad t = 25^\circ\text{C} \\ &= (3.38 \times 10^{-2}) \times (2.9 \times 10^{-4}) \\ &= 9.8 \times 10^{-6} \text{ mol/L} \end{aligned}$$

Because 1 mol of  $\text{CO}_2 = 44$  g, the concentration of dissolved  $\text{CO}_2$  in grams is:

$$\begin{aligned} C &= (9.8 \times 10^{-6}) \times 44 \\ &= 4.3 \times 10^{-4} \text{ g/L or } 0.43 \text{ mg/L} \end{aligned}$$

The calculated amount above represents the  $\text{CO}_2$  concentration in water of high quality, which is in equilibrium with nonpolluted atmospheric air. The solubility usually decreases as the temperature increases. The amount of  $\text{O}_2$  dissolved in soil water can be calculated in a similar fashion and amounts to  $0.26 \times 10^{-3}$  mol/L or 8.33 mg/L.

#### 4.8.4 HYPOXIA

The term *hypoxia* is used often for conditions of *oxygen depletion*, but perhaps it is better to state it as *low oxygen availability*. It is not exactly an environmental problem only, but it can also be a medical issue; hence, the terms *environmental* and *medical hypoxia* are used to differentiate between the two. Mountain climbers, reaching high altitudes, frequently suffer from a type of medical hypoxia, due to low  $\text{O}_2$  content in the thin air at the mountain summits. Another example is strenuous physical exercise that causes athletes to be deprived of adequate  $\text{O}_2$  supply. Environmentally, hypoxia develops when the amount of dissolved oxygen is reduced to a level detrimental to aquatic life, a condition referred to as *environmental hypoxia* (Richards et al., 2009).

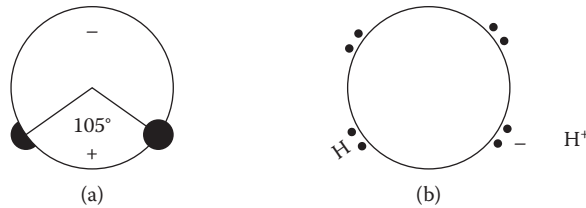
Generally, the amount of  $\text{O}_2$  dissolved in water is expressed in terms of percentages (%) within a range of 0% to 100%, keeping in mind that at maximum saturation water can only contain 8.33 mg of  $\text{O}_2$  per L (at 1 atmospheric pressure and 25°C). At 0% saturation, the aquatic system is called *anoxic* or *anaerobic*, where reducing conditions prevail. In the range of 1% to 30% saturation, the aquatic system is called *hypoxic*. This is generally the range in which fish will be killed by the low availability of oxygen, and the value of 30% saturation is considered the *threshold value*, above which fish will survive. Generally, the minimum requirement for an aquatic environment full of life is 80%.

In aquatic systems, periods of low oxygen availability are common due to diurnal oscillations in respiration of aquatic weeds and algal bloom, ice cover, seasonal flooding, anthropogenic activities, and several other natural causes. One of the major anthropogenic reasons for hypoxia is *eutrophication*, in which the excessive growth of aquatic weeds and plankton will use and deplete rapidly the dissolved oxygen content (Tan, 2009). Though a great variety of aquatic life tends to be killed, fish have been reported to be most tolerant to environmental hypoxia by development of adaptive strategies for allowing them to function at low oxygen levels (Richards et al., 2009). Catfish especially appear to be a hypoxia-tolerant species.

### 4.9 CHEMISTRY OF SOIL WATER

Water is a renewable resource that belongs to a gigantic cycle, the *hydrologic cycle*. It is evaporated from the earth and the sea into the atmosphere. The energy required for evaporation is supplied by the sun. In the atmosphere, water is transported by the wind in the form of vapor, until it finally returns to the earth in some form of precipitation. Part of this soaks into the soil, and that part not used by plants percolates further to reach underground reservoirs called *aquifers*. Another part of the precipitation is lost in the form of *surface run-off* accumulating in rivers and lakes to finally end up in the oceans, where the sun's energy begins the process of evaporation again.

Until late in the 19th century, water was thought to be an element. It was Cavendish in 1871 who showed that water could be formed by burning  $\text{H}_2$  in the air. A few years later, Lavoisier determined the composition of water as  $\text{H}_2\text{O}$ .



**FIGURE 4.1** (a) A water molecule composed of 2H atoms attached at a  $105^\circ$  angle to an O atom; and (b) ionization of water into a hydroxyl ( $\text{OH}^-$ ) and a proton ( $\text{H}^+$ ) or hydrogen ion. Dots are unshared electron pairs, except where H is linked to O.

In its common state, water is a colorless, odorless, and tasteless liquid. It may also exist in a vapor or solid state, and often all three phases can occur at the same time. Some of the properties are peculiar to its liquid state, whereas other properties may be more common to the vapor and solid states. A single water molecule is very small, generally in the dimension of  $3 \text{ \AA}$  ( $3 \times 10^{-8} \text{ cm}$  or  $0.3 \text{ nm}$ ) in diameter. The unit mass of  $\text{H}_2\text{O}$  is the mass of 1 mL of  $\text{H}_2\text{O}$ , which equals 1 g ( $4^\circ\text{C}$ ). One mole of water (18 mL) contains  $6.02 \times 10^{23}$  individual molecules. Water participates directly in many soil and plant reactions and, indirectly, affects many others. Its ability to react is determined by its chemical structure. An individual water molecule is composed of one atom of oxygen attached to two atoms of hydrogen. The hydrogen atoms are at an angle of about  $105^\circ$  from each other (Figure 4.1). This arrangement causes an imbalance of charges, with the center of the positive charge being at one end and the center of the negative charge at the other end. Such molecules are called *dipolar* because of their behavior in electrical fields according to the imbalanced charges. When water crystallizes, the molecules arrange themselves so that a hydrogen atom of one water molecule is located close to an oxygen atom of another molecule of water. The bond by which a hydrogen atom acts as the connecting linkage is called a *hydrogen bond*. As a result of crystallization, water forms a hexagonal structure with many empty spaces. Consequently, ice is less dense than liquid water and will float in water. The formation of empty spaces causes a volume expansion of about 9%, and the forces developed by the latter are approximately  $150 \text{ kg/cm}^2$ . Therefore, when water freezes in soils and plants, the expansion causes the soil structure to change and the plant cells to rupture.

The presence of dipoles in the water molecules accounts for a number of other important reactions. Cations (e.g.,  $\text{Na}^+$ ,  $\text{K}^+$ ,  $\text{Ca}^{2+}$ ) become hydrated through their attraction to the negative pole of water molecules. Likewise, negatively charged clay particles attract water through the positive pole of the water molecule. Polarity of water also encourages dissolution of salts, as the ionic components of salts have greater affinity for water molecules than for each other. When water molecules become attracted to clay surfaces or ions, they do so in packed clusters. In clusters, the free energy of water is lower than in *free water*, meaning the molecules are less free to move. Free water has greater internal energy than ice or clusters of water. The latter is indicated by the release of 80 cal (334 J) of energy in the form of heat as water freezes into ice. The International System of Units (SI) unit of heat is the quantity of heat required to raise the temperature of 1 g of water from  $14.5$  to  $15.5^\circ\text{C}$  (1 calorie = 4.18 Joules). In scientific terms, the energy differences mean that the entropy of water is lower in the solid than in the liquid state. When compounds dissolve, the energy is released, a phenomenon called *heat of solution*. The ions are then hydrated and the corresponding release of energy is called *heat of hydration*. In thermodynamic language, it is the *increase in enthalpy* due to formation of a hydrate. In contrast, when clay particles are hydrated, the energy released is called *heat of wetting*.

*Surface tension* is another important property of water that influences its behavior in soils. This property occurs only at the liquid–air interfaces and is the result of a greater attraction between water molecules for each other than for the air above. The net effect is an inward force of water

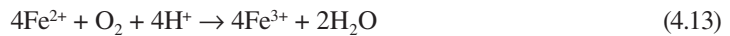
molecules at the surface, causing water to behave as if its surface were covered with an elastic membrane. Surface tension plays an important role in soil water movement, called *capillarity*.

#### 4.10 OXYGEN DEMAND OF WATER

As indicated earlier, oxygen dissolves in water and is an important substance for the growth of many organisms. It is often considered the key substance for the existence of many kinds of life in water. Oxygen deficiency is fatal to fish and many types of aerobic bacteria.

The solubility of oxygen in water is affected by the water temperature, the partial pressure of oxygen in the atmosphere (or in soil air), and the salt content of water. The amount dissolved is, therefore, very small, and water at 25°C and 1 atmosphere pressure contains only 8.32 mg dissolved O<sub>2</sub>/L (for calculations see Section 4.8.3). This amount of dissolved oxygen may be depleted very rapidly unless some mechanism for aeration is present. The latter can be achieved naturally by waterfalls and turbulent flow in streams, or artificially, by pumping air in water such as in aquariums and sewage treatment plants. Several processes are responsible for the depletion of dissolved oxygen content. Oxygen can be consumed rapidly in the oxidation process of organic matter as illustrated by Equation 4.1. Other microorganism-mediated processes depleting the dissolved oxygen content are the *biochemical oxidation* of:

1. Iron compounds:



2. Sulfur compounds:



3. Ammonium:



The oxidation of ammonium into nitrate, NO<sub>3</sub><sup>-</sup>, which occurs in two steps, is called *nitrification*. The rate by which oxygen is consumed or depleted by the foregoing processes is called *oxygen demand* (OD). Three types of ODs are distinguished:

1. *Biological oxygen demand (BOD)*—This is defined as the amount of oxygen consumed by microorganisms in the process of decomposition of organic matter during a 5-day incubation period. The test was developed in England, where it was believed that dissolved organic matter not decomposed within 5 days would be transported into the sea.
2. *Chemical oxygen demand (COD)*—This is defined as the amount of oxygen consumed in the chemical oxidation of organic matter by potassium dichromate in the presence of sulfuric acid. The analysis for oxidation of organic C is known today as the *Walkley–Black method*.
3. *Total oxygen demand (TOD)*—This is the amount of oxygen consumed in the catalytic oxidation of carbon. The amount of CO<sub>2</sub> produced in the reaction is measured.

#### 4.10.1 THE IMPORTANCE OF OXYGEN DEMAND IN THE ENVIRONMENT

Of the three types of ODs, the BOD is the best known. It is also called *biochemical oxygen demand*, which according to U.S. Geological Survey scientists occurs in two stages. The first stage is called the *carbonaceous stage* in which organic carbon is converted into carbon dioxide. This is then followed by the second stage, called the *nitrogenous stage*, representing a combined carbonaceous plus nitrogenous demand, during which organic nitrogen, ammonia, and nitrites are oxidized into nitrates. In sewage treatment plants utilizing biological treatment processes, nitrification can occur in less than 5 days if nitrifying bacteria are present. If the intent is to measure only the first stage—the carbonaceous demand—a nitrification inhibitor is applied and the results are reported as *carbonaceous BOD (CBOD)* (Delzer and McKenzie, 2003).

Although the determination of BOD is more difficult than that of COD, whereas the 5-day incubation period is in addition subject to many arguments, many scientists prefer the use of BOD for determining the quality of stream and lake water or the amount of pollution in soils and the environment. The BOD or, in general, the OD is a measure of the amount of oxidizable pollutants in aquatic systems which can lower dissolved oxygen (DO) contents. The lower the BOD values, the better will be the water quality. A BOD value of 1 ppm (which means 1 ppm, or 1 mg/L, of oxygen consumed in the decomposition of waste during a 5-day incubation period) indicates the presence of low amounts of oxidizable organic contaminants, in other words, water of high quality. On the other hand, high BOD values (5 to 20 ppm) indicate the presence of water with high amounts of organic contaminants, or water of low quality (Manahan, 1975, 2009; Stevenson, 1986). Wastes from farmyards and feedlots are reported to have BOD values of 10,000 ppm or more. Effluent from food-processing industries is also notorious for its high BOD values. These products may find their way to rivers and lakes, and their extremely high BODs will decrease the oxygen content of the water. As indicated earlier, the maximum amount of dissolved O<sub>2</sub> is 8.32 mg/L (at 25°C and 1 atm), and as soon as this level is reduced to ≤5 mg/L, the condition becomes life threatening for fish and many other aquatic organisms. This is the reason for setting the lowest limit of high BOD at 5 ppm (= 5 mg/L). However, runoff discharging its load with BOD values of 5 ppm, though objectionable, does not necessarily create pollution, because the maximum amount of dissolved oxygen, 8.32 ppm, naturally available, is high enough to destroy 5 ppm of contaminants. Only when the depleted amount is not replenished by turbulent flows will such a load create serious damage to the environment.

In many highly polluted waters, it is not so much the waste products that will kill the organisms, but it is more the deficiency in oxygen that limits their survival. Frequently, life is still present in waters troubled by high pollution whenever the dissolved oxygen content is maintained at a sufficiently high level by turbulent water movement. For more details on the concept and environmental significance of oxygen demand reference is made to Tan (2009).

#### 4.11 SOIL WATER ENERGY CONCEPTS

Water in soils may possess different kinds and quantities of energy. Differences in energy content of water at various locations in soils cause it to flow. Retention of water in soils, its uptake and transport in plants, and the loss of water to the atmosphere, all are processes that are related to changes in the energy status of soil water. Several kinds of energy are usually involved: potential, kinetic, and electrical (Brady, 1974; Brady and Weil, 2008). However, Hillel (1972) indicated that only potential and kinetic energy were traditionally recognized as the two principal forms of energy in physical science. Of the two, potential energy is considered of more importance in determining the state and movement of water in soils. Differences in potential energy from one to another point in the soil tend to create movement of soil water. The water flow is in the direction of decreasing potential energy. The force causing this flow of water is called *water potential difference* (because of a difference between two points). In contrast, a water potential gradient is a continuously chang-



ing function of potential in a flow medium. The flow of water continues until the water potential difference between the two points is zero, and an equilibrium condition is attained.

#### 4.11.1 WATER POTENTIAL ( $\Psi_w$ )

In 1907, Edgar Buckingham, a soil physicist at the United States Department of Agriculture (USDA), Bureau of Soils, introduced the concept of forces arising from interactions between water and soil. Central to his concept was the *capillary potential* (Buckingham, 1907), which according to Hillel (1972) is a synonym for *water potential*. This is now known as the *matric potential*, *water* or *moisture potential* (Narasimhan, 2007; Nimmo and Landa, 2005). Buckingham's theory, predicting transient soil water content as a function of time and space, is still valid today. Currently, Buckingham's concept is applied to describe water's energy status or ability to work. Work is considered performed as water moves from one to another location in soils. At equilibrium condition, water has the potential to do this work, and the energy associated with it is called *potential energy* or, briefly, *potential*. This water potential is the net effect of several components. It is the sum of the contributions of the various forces acting on soil water, such as matric, osmotic, and solute forces. For isothermal conditions, the water potential ( $\Psi_w$ ) can be formulated as follows:

$$\Psi_w = \Psi_m + \Psi_p + \Psi_s \quad (4.17)$$

where  $\Psi_m$  is the matric potential,  $\Psi_p$  is the pressure potential, and  $\Psi_s$  is the solute potential.

This water potential can assume a positive or a negative value depending on the forces acting on soil water. The presence of solutes and matrix components decreases the capacity of water to perform work; hence, under normal field conditions, the soil water potential is negative. However, under conditions for which the hydrostatic pressure is greater than the atmospheric pressure (in pressure plates), the water potential will be positive. The *matric potential* is perhaps the most important component in unsaturated soils, whereas the *solute* or *osmotic potential* is a significant force in saline soils and in soils amended with fertilizers and organic waste. Water will move by diffusion from a diluted to a concentrated solution, which is *osmosis*, and the pressure ( $p$ ) affecting soil water tends to cause movement from a high to a low pressurized system.

#### 4.11.2 THE RELATIONSHIP OF WATER POTENTIAL AND CHEMICAL POTENTIAL OF WATER

From the previous discussion, it is apparent that the relative level of energy of water at different locations in soils is of more value to the behavior of soil water than the absolute amount of energy that soil water contains. As indicated earlier, the term *water potential* is used as a measure to express this energy level of soil water relative to that of water at standard state. If external force fields are excluded, this concept of water potential shows considerable analogy with the concept of chemical potentials. As discussed before, differences in chemical potentials of a component between two points in the soil also govern the direction of movement of the component (here the movement of soil water). Not surprisingly, several authors have tried to apply thermodynamic concepts of chemical potentials in soil–water problems, although several arguments questioning its applicability were frequently reported (Hillel, 1972; Taylor and Ashcroft, 1972; Taylor and Slatyer, 1960). From thermodynamic principles, the water potential is considered to be equal to the difference between the chemical potential of soil water at an arbitrary equilibrium state and that of soil water at standard state (Taylor and Ashcroft, 1972). The relationship can be expressed as follows:

$$\Psi_w = \Delta\mu_w = \mu_w - \mu_w^o \quad (4.18)$$



where  $\Delta\mu_w$  is the difference in chemical potential of soil water,  $\mu_w$  is the chemical potential of soil water at an arbitrary equilibrium condition, and  $\mu_w^o$  is the chemical potential of soil water at standard state (see Section 3.7, and Thomson, 2008).

Formerly,  $\Delta\mu_w$  was called the *moisture potential* (Taylor and Slatyer, 1960), but a few years later, Slatyer (1967) revised this definition by presenting his version for the relationship of the water potential,  $\Psi_w$ , with the free energy content of water as follows:

$$\Psi_w = (\Delta\mu)/V_m \quad (4.19)$$

where  $V_m$  is the molal volume of water (18 mL/mol at 4°C).

Today, such a definition applies to the *volumetric water potential*.

### 4.11.3 TOTAL SOIL WATER POTENTIAL ( $\Psi_t$ )

The *total soil water potential* is defined by the International Soil Science Society, Soil Physics Terminology Committee (Aslyng, 1963) as the amount of work required to transport reversibly and isothermally an infinitesimal amount of water from a pool of pure water at a specified elevation at atmospheric pressure to the point under consideration. This potential includes the water potential and potentials arising from external force fields. It is generally formulated as follows:

$$\Psi_t = \Psi_w + \Psi_g + \Psi_z + \dots$$

where  $\Psi_w$  is the water potential,  $\Psi_g$  is the gravitational potential, and  $\Psi_z$  stands for any other potentials arising from external force fields.

In soils, gravity is often the only external force field of importance, and the total water potential  $\Psi_t$  is usually expressed as follows:

$$\Psi_t = \Psi_w + \Psi_g \quad (4.20)$$

However, Papendick and Campbell (1981) are of the opinion that an *overburden potential*,  $\Psi_\Omega$ , may also be present in soils. This potential is caused by weight from overlying matter pressing on soil water. Hence, the total soil water potential is then given by:

$$\Psi_t = \Psi_w + \Psi_g + \Psi_\Omega \quad (4.21)$$

Depending on the forces acting on soil water, the total water potential can also assume positive or negative values. In soils, the matric and osmotic (solute) components of the water potential contribute more significantly to  $\Psi_t$  than all the other components. They exert the greatest influence on water flow and availability for plants.

### 4.11.4 MATRIC POTENTIAL ( $\Psi_m$ )

The attraction of soil solids (matrix) for water provides a matrix force, and that part of the water potential attributed to the matrix force is called *matric potential*. Taylor and Ashcroft (1972) reported that the matric potential is similar to the capillary potential and replaces terms such as soil moisture tension, soil moisture suction, or matric suction. The matrix force reduces the free energy of the adsorbed water. In the presence of solid particles (*matrix*), water is subject to adsorption on the particle surfaces, by electrostatic forces, surface tension, and capillarity. The adsorbed water is less subject to diffusion and cannot move as freely as free water. Therefore, the matric potential tends to be negative in value. It can often be determined with a tensiometer.

#### 4.11.5 PRESSURE POTENTIAL ( $\Psi_p$ )

Pressure differences in soils, resulting from air or pneumatic pressures of the atmosphere on soil water, are the reasons for the development of pressure potentials. In a saturated soil, the pressure potential has a positive value because the hydrostatic pressure is greater than the atmospheric pressure. In a water-unsaturated soil, the pressure potential equals zero, because the liquid (water) pressure can be neglected, whereas the soil air pressure can be considered equal to the atmosphere. A negative pressure potential occurs only when soil water is subjected to a pressure lower than atmospheric pressure. Taylor and Ashcroft (1972) stated that negative pressures were normally observed under laboratory conditions. However, Hillel (1972) indicated that the negative pressure potential was synonymous with capillary and matric potential, and he was of the opinion that both capillary and adsorptive forces were responsible for the negative pressure potential. Thus, the matric potential, or the negative pressure potential, is a reflection of the total effect resulting from the retention of water in soil pores (capillary forces) and on the surfaces of soil particles (adsorption).

#### 4.11.6 OSMOTIC POTENTIAL ( $\Psi_o$ )

The portion of the water potential attributed to the attraction of solutes (ions or other molecules) for water by osmotic forces is called *osmotic potential*, sometimes also known as *solute potential*. The osmotic potential becomes of importance only if a semipermeable membrane is present. The latter acts as a barrier for movement of the solutes, but water can flow freely through the membrane. In the absence of a membrane, the solutes will flow with the water, instead of the solutes attracting water. Often, the symbols  $\Psi_s$  ( $s$  stands for solutes) or  $\Psi_\pi$  ( $\pi$  is osmotic pressure) are used interchangeably with  $\Psi_o$ . However, the osmotic potential,  $\Psi_o = \Psi_\pi$ , is negative, whereas the osmotic pressure,  $\pi$ , is positive in value. Pure water that does not contain solutes has a  $\Psi_\pi = 0$ . The osmotic potential should be negative, because a solution (water-containing solutes) always contains less water than pure water (water without solutes) of equal volume.

#### 4.11.7 GRAVITATIONAL POTENTIAL ( $\Psi_g$ )

The *gravitational potential* is the portion of the total water potential attributed to the downward pull of water by gravity. Gravity is the force pulling water downwards, like “water flowing downhill.” By moving water against the gravitational force, work is performed. The amount of work needed is stored in the water in the form of potential energy. The gravitational potential is independent of the chemical potential but depends on the vertical location and the density of soil water.

#### 4.11.8 UNITS OF SOIL WATER POTENTIAL

The units for soil water potential can be expressed in several ways (Table 4.1). Traditionally, the water potential is expressed in “units of contained energy per unit mass of water (ergs per gram of water, or joules per kg of water).” Sometimes, the water potential is stated in units of energy per mole of water (ergs per mole). The latter is also known as *molar water potential*. Another way to express soil water potential is in units of energy per volume of water (ergs per cubic centimeter, ergs/mL), which is then called *volumetric water potential*. The latter unit is equivalent to the unit of pressure in physics, *dynes per cm<sup>2</sup>* (1 erg = 1 dyne/cm<sup>2</sup>). Hence, the units of the volumetric water potential in bars (Table 4.1) are often used by a number of scientists, which allows for easy conversion into soil moisture constants (soil water suction in Table 4.1). Therefore, the water potential of soils at field capacity is expressed in terms of  $-0.3$  bars for loams and silt loams, and  $-0.1$  bar for

**TABLE 4.1**  
**Units of Soil Water Potentials and Their Equivalents**

Energy/Unit Mass		Volumetric Potential (bars) <sup>a</sup>	Soil Water Suction (bars)	Relative Humidity (%)
(erg/g)	(J/kg)			
0	0	0	0	100.00
$-1 \times 10^4$	-1	-0.01	0.01	100.00
$-5 \times 10^4$	-5	-0.05	0.05	99.99
$-1 \times 10^5$	-10	-0.10	0.10	99.99
$-3 \times 10^5$	-30	-0.30	0.30	99.97
$-5 \times 10^5$	-50	-0.50	0.50	99.96
$-1 \times 10^6$	-100	-1.00	1.00	99.92
$-5 \times 10^6$	-500	-5.00	5.00	99.63
$-1 \times 10^7$	-1000	-10.00	10.00	

<sup>a</sup> Energy/mass is dimensionally equivalent to pressure. The bar is commonly used as the standard unit for the volumetric potential, though the SI system prefers the use of Pascal (Joule m<sup>-3</sup> = Newton m<sup>-2</sup>; 1 bar = 1 × 10<sup>5</sup> N m<sup>-2</sup>; 1 Pascal = 1 N m<sup>-2</sup>).

Sources: Hillel, D. *Soil and Water: Physical Principles and Processes*, Academic Press, New York, 1972; Taylor, S. A., and G. L. Ashcroft. *Physical Edaphology*, Freeman, San Francisco, CA, 1972; Weast, R. C., ed. *Handbook of Chemistry and Physics*, The Chemical Rubber Co., Cleveland, OH, 1972.

sands, instead of  $-30$  J/kg and  $-10$  J/kg, respectively. The wilting point is then referred to as having a water potential of  $-15$  bars, instead of  $-1500$  J/kg.

With the introduction of the SI system, the preferred unit of the soil water potential is MPa (mega Pascal or 10<sup>6</sup> Pa), though some suggest kPa (kilo Pascal or 10<sup>3</sup> Pa) (ASA-CSSA-SSSA, 1998; Cohen et al., 2007). As indicated earlier, soil water will flow spontaneously from regions with high potential to those with low potential. As in thermodynamics, where reactions occur spontaneously when  $\Delta G$  is negative, soil water tends to move when  $\Delta\Psi_w$  is negative. As explained above, water potentials are usually negative; hence, water will flow, for example, from a  $\Psi_w = -1$  to a  $\Psi_w = -5$  MPa (Kirkham, 2005; Ott and Boerio-Goates, 2000). Conversion of the bar or atmosphere unit into MPa is by using the factor  $\times 0.1$  or  $\times 0.101$ , respectively (see Appendix F). The corresponding values of  $-1$  to  $-5$  MPa are then  $-10$  to  $-50$  bars.

#### 4.11.9 THE RELATIONSHIP BETWEEN $\Psi_w$ , WATER CONTENT, AND RELATIVE HUMIDITY

As discussed in the preceding section, the water potentials can be related to soil moisture constants. Although these constants are very useful for calculating water budgets in crop production, a number of microbiologists believe that the water constants and potentials are insufficient in predicting microbial activity, because the organisms can remain active at very low values of  $\Psi_w$  where, by definition, no available water is present. Microbial activity has been reported at a water potential of  $-500$  bars or  $-50$  MPa, an unbelievably low value. However, this extremely low value corresponds to a relative humidity of 70%. According to Papendick and Campbell (1981), the growth of soil microorganisms may respond to changes in  $\Psi_w$  of even a fraction of a bar, which relates to minute changes of relative humidities (changes of  $\leq 0.1\%$ ). Therefore, microbiologists believe that it is more relevant to relate the water potential to water content or relative humidity than to soil moisture constants. They require both water potentials and water content (or relative humidity) to be stated. Selected values for relative humidities versus its corresponding water potentials are shown in Table 4.1.

The conversion of water potential into water content can be conducted in several ways. One method is the application of thermodynamics or the adaptation of the Nernst equation into relating the water potential for equilibrium conditions with the liquid and vapor phase of soil water (Papendick and Campbell, 1981):

$$\Psi_w = [(RT)/V_m] \ln h = [(RT)/V_m] \ln a_w \quad (4.22)$$

where R is the gas constant, T is absolute temperature (K),  $V_m$  is the molal volume of water (18 mL/mol at 4°C), h is relative humidity, and  $a_w$  is water activity.

Because R is a known constant and  $\ln = 2.3 \log$ , at  $T = 25^\circ\text{C}$  (298 K), Equation 4.22 can be changed for practical purposes into:

$$\Psi_w = (1.364/V_m) \log h = (1.364/V_m) \log a_w \quad (4.23)$$

At infinite dilution (or in soil water)  $a_w$  is the concentration.

Another method for relating the water potential to water content is to use the empirical equation (Hillel, 1972; Osmond, 1958):

$$\Psi_w = a\theta^{-b} \quad (4.24)$$

In this equation, a and b are constants and  $\theta$  is the water content in soils. By taking the logarithm on both sides, Equation 4.24 changes into:

$$\log \Psi_w = \log a + (-b \log \theta)$$

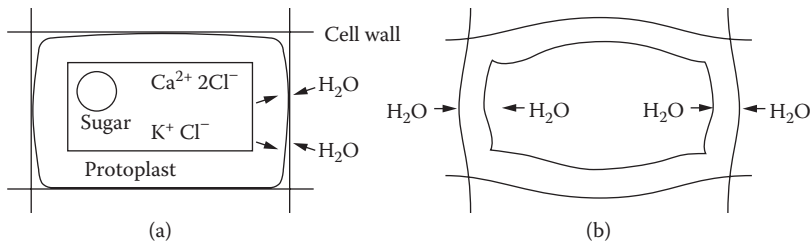
or

$$\log \Psi_w = \log a - b \log \theta \quad (4.25)$$

This is a linear regression equation in which  $\log a$  is the intercept, and  $-b$  is the regression coefficient (slope). By plotting the values for  $\log \Psi_w$  and  $\log \theta$  on graph paper, the constants a and b can be calculated. This equation is valid only within a limited range of matric potentials, and  $\Psi_w$  is taken here as positive (Papendick and Campbell, 1981).

## 4.12 THE PLANT–SOIL–WATER ENERGY RELATION

The theories of soil water potentials are well established and have proven useful in describing the conditions of water in plant tissue and its movement through the plant body. Soil water can enter the root through the cell walls, which are hydrophilic and also exhibit even more negative matric potentials than the soil system outside. Once inside, water can travel in the root along or between the cell walls, called the *free diffusional space*. This process is known as the *apoplast pathway* (Taiz and Zeiger, 2002). However, the solution is prevented from entering the inner cells, because it cannot pass the *Casparian strip* of the endodermis, composed of *suberin*, a waxy substance. Suberin is highly hydrophobic, and its presence provides the Casparian strip with control over water and nutrient uptake. By forcing the solution to pass through a semipermeable membrane, a process known as the *symplast pathway*, the Casparian strip or band allows the plant to select the nutrients and at the same time provides a barrier for protection against harmful solutes from entering the inner cell spaces. Mangrove plants and other halophytes were cited as examples to use suberin in controlling salt intake (Khan and Weber, 2009). A third pathway, the *transcellular transport*, has also been recognized (Holbrook and Zwieniecki, 2005), but the two mentioned above are believed to be the most important. In the



**FIGURE 4.2** (a) A plant cell showing vacuole filled with cell sap, sugar,  $\text{Ca}^{2+}$ ,  $\text{K}^+$ , and  $\text{Cl}^-$  ions. Water moves freely into the cell. (From Taylor, S. A., and G. L. Ashcroft. *Physical Edaphology*, Freeman, San Francisco, CA, 1972. With permission.) (b) Inflated cell with increased turgor potential exerting pressure on water within the cell. Movement of water into and out of the cell stops when turgor equals osmotic potential.

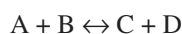
plant cells, water is retained by adsorptive and osmotic forces. The cells consist of (1) cell walls that are rigid but exhibit a capability for elastic expansion; (2) protoplasm, acting as a semipermeable membrane through which water can move freely, and in contrast with the flow of solutes, which is somewhat restricted; and (3) vacuoles, filled with solute-rich cell sap and some colloidal material (glucose). The solute and colloidal concentration reduce the activity of water inside the cell. The higher solute and colloidal concentration results in attraction of water, and water outside the membrane will move into the cell more rapidly than the solutes can diffuse out. The attraction of the cell for water from solute concentration in the vacuole is called *solute potential*,  $\Psi_s$ . If the attraction arises from the adsorption of water by colloidal material in the cell, or by protoplasmic colloids, it is called *matric potential*,  $\Psi_m$ . The combination of solute and matric potential is the *osmotic potential*,  $\Psi_o$ . The turgor pressure accompanying the adsorption of water by the cell is called *turgor* or *pressure potential*,  $\Psi_p$ . This is the potential forcing of water out of the cell as a result of inflated conditions of the cell. When water moves into a cell, the cell volume increases (Figure 4.2), and the protoplast is forced against the cell wall, which, being elastic, expands. The greater is the expansion of the cell, the greater will be the pressure exerted on water within the cell, and the turgor pressure increases accordingly. Consequently, the flow of water into the cell decreases gradually as the turgor potential  $\Psi_p$  within the cell increases. At one point, the pressure (turgor) potential can become numerically equal, but opposite in sign, to the combined solute and matric potentials. At the point of equal pressure, the sum of potentials  $\Psi_p + \Psi_s + \Psi_m$  is then equal to zero, and the net flux of water into the cell becomes zero. Flux refers to the rate of flow. The sum of the solute, matric, and pressure (turgor) potentials is called the *water potential*,  $\Psi_w$ :

$$\Psi_w = \Psi_s + \Psi_m + \Psi_p \quad (4.26)$$

There is also a tendency for water to move through the cell membrane into the soil. This movement can be prevented by increasing the pressure or decreasing the tension on the soil side of the membrane. This concept of water potential in plants is applied by crop scientists and plant physiologists. Often the terms *leaf water potential* and *root water potential* are used by these scientists for the *water potential* as defined by Equation 4.26.

### 4.13 THE LAW OF MASS ACTION AND EQUILIBRIUM CONSTANT

Almost all chemical and biochemical reactions occur in aqueous solutions. The processes will be governed by basic chemical laws, one of which is the law of mass action. Consider the reaction:



in which A and B are the reactants, and C and D are the reaction products. The rate of reaction from left to right ( $R_1$ ) is proportional to the product of the concentrations of A and B:

$$R_1 = k_1(C_A \times C_B)$$

Similarly the rate of reaction from right to left ( $R_2$ ) can be written as

$$R_2 = k_2(C_C \times C_D)$$

in which  $k_1$  and  $k_2$  are proportionality constants. At equilibrium,  $R_1$  must equal  $R_2$ :

$$R_1 = R_2$$

$$k_1(C_A \times C_B) = k_2(C_C \times C_D)$$

$$(C_C \times C_D)/(C_A \times C_B) = k_1/k_2 = K_{eq} \quad (4.27)$$

$K_{eq}$  is called the *equilibrium constant*. This equation is the formulation of the *mass action law* as first reported by Guldberg and Waage in 1865, which allegedly was rewritten into a final form in 1867. A revised definition was, however, provided 10 years later by van't Hoff in 1877, a Dutch chemist who independently developed the same concept. For his work on chemical solutions, Jacobus Henricus van 't Hoff was awarded the first Nobel Prize in chemistry in 1901. Because of its importance as one of the basic foundations of modern chemistry, this law has been applied to various systems (Koudriavtsev et al., 2001; Levinovitz and Ringertz, 2001). The law of mass action says that at equilibrium the product of the concentrations of the reaction products divided by the product of the concentrations of the reactants is constant in any chemical reaction. In a concentrated solution, the concentrations in Equation 4.27 must be replaced by activities. However, for a first approximation, activities may be replaced by concentrations in moles per liter. The equilibrium constant  $K_{eq}$  depends on the temperature of the solution, not on the pressure of the air or the composition of the system. It is fixed for any given temperature. The larger the numerical value of  $K_{eq}$ , the greater is the tendency for the reaction to proceed in the direction of the reaction products (to the right).

The law of mass action applies more particularly to reactions occurring in solutions. In a reaction process where a solid yields a gas, an adaptation to this law is used. If a single gas is produced, and the reaction reaches equilibrium according to the following process:



the equilibrium constant can be formulated by replacing the concentration of the gas by its partial pressure,  $P_{CO_2}$ :

$$K = [(CaO)(P_{CO_2})]/(CaCO_3) \quad (4.29)$$

Because the activity of CaO and  $CaCO_3$  as pure solids (crystals) is unity (equals 1) at standard state, Equation 4.29 changes into:

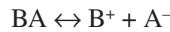
$$K = P_{CO_2} \quad (4.30)$$

The *equilibrium constant* then equals the *partial pressure* of the  $CO_2$  gas, and in the reaction above, it is sometimes called the *dissociation constant* of  $CaCO_3$ .

As stated earlier, the aforementioned law of equilibrium finds extensive application in many ionic solution phenomena, and the equilibrium constant assumes different kinds of expressions (e.g., solubility product constant, dissociation constant, ion product constant of water, ionization constant of electrolytes, cation exchange constant, or ion exchange constant).

#### 4.14 SOLUBILITY PRODUCTS

The *solubility product* is the product of ion concentrations in the saturated solution of a difficult soluble salt. Consider the dissociation of BA occurring as follows:



Because the activity of pure solids is unity at equilibrium ( $BA = 1$ ), application of the mass action law gives:

$$K_{eq} = K_{sp} = (B^+) (A^-) \quad (4.31)$$

In this type of reaction,  $K_{eq}$  is called the *solubility product constant*, and the symbol  $K_{sp}$  replaces  $K_{eq}$ . The negative log of  $K_{sp}$  is  $pK_{sp}$ :

$$pK_{sp} = -\log K_{sp} \quad (4.32)$$

The smaller the  $pK_{sp}$ , the more soluble the substance. However, if two solutions, each containing one of the ions of a difficult soluble salt, are mixed, no precipitation will take place unless the product of the ion concentration in the mixture is greater than the solubility product. In saturated solution, the concentration of  $B^+$  ions is equal to that of the  $A^-$  ions. Because the salt is completely ionized, the *solubility*,  $S$ , of the salt can be represented by the individual ion concentration:

$$S = (B^+) = (A^-)$$

By substituting this in Equation 4.31,  $K_{sp}$  can be rewritten as:

$$K_{sp} = (B^+)(B^+) = (B^+)^2$$

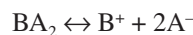
or

$$K_{sp} = (A^-)(A^-) = (A^-)^2$$

Therefore,

$$(B^+) = (A^-) = \sqrt{K_{sp}} \text{ or } S = \sqrt{K_{sp}} \quad (4.33)$$

Equation 4.33 is valid only for monovalent ion salt. For a difficult soluble salt with the formula  $BA_2$ , where the dissociation produces one cation and two anions:



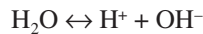
the solubility  $S$ , derived in a similar way, is:

$$S = \sqrt[3]{(1/4K_{sp})} \quad (4.34)$$

Solubility and solubility products are of significance in systems in which a solid is in equilibrium with its solution. Such systems are common systems in soils. Dissolution of primary minerals or formation and dissolution of clay minerals are a few examples. In the decomposition of kaolinite, formation of gibbsite obeys solubility laws. The dissolution of liming materials and fertilizers are additional examples. The amount of  $\text{Ca}^{2+}$  released from the liming material is governed by the solubility product of the component ions. Predictions can be made for the concentration of  $\text{Ca}^{2+}$  liberated, and made available to plant growth, by the use of the laws of solubility.

#### 4.15 THE DISSOCIATION OF WATER

Water molecules have a slight tendency to break up (dissociate) into hydroxyl ( $\text{OH}^-$ ) and hydrogen ( $\text{H}^+$ ) ions. The dissociation is so slight that only one in  $10^7$  molecules of water is ionized at any one time. However, without this slight ionization, many of the processes and reactions in water would not be possible:



By applying the mass action law, the following relationship is obtained:

$$K_{\text{eq}} = (\text{C}_{\text{H}^+} \times \text{C}_{\text{OH}^-})/\text{C}_{\text{H}_2\text{O}} = 1.8 \times 10^{-16} \quad (4.35)$$

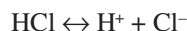
$K_{\text{eq}}$  is now called the *dissociation constant* of water. The concentration of pure water is 55.5 mol/L. By substituting this for  $\text{C}_{\text{H}_2\text{O}}$ , Equation 4.35 changes into:

$$\begin{aligned} K_{\text{eq}} &= \text{C}_{\text{H}^+} \times \text{C}_{\text{OH}^-} = 1.8 \times 10^{-16} \times 55.5 \\ K_w &= 1.01 \times 10^{-14} \quad \text{at } 25^\circ\text{C} = 298 \text{ K} \end{aligned} \quad (4.36)$$

In this reaction, the symbol  $K_{\text{eq}}$  is changed into  $K_w$ , which is called the *ion product constant* of water. This product is the basis for the formulation of pH (see Chapter 9 for a discussion).

#### 4.16 THE DISSOCIATION OF STRONG ELECTROLYTES

Strong electrolytes are dissociated in water completely into their ionic components. NaCl even in solid form exists as  $\text{Na}^+$  and  $\text{Cl}^-$  ions. The HCl in water is usually completely dissociated into  $\text{H}^+$  and  $\text{Cl}^-$  ions. It is common practice to present the dissociation of HCl as:



However, the reaction is more accurate as follows:



$\text{H}_3\text{O}^+$  is called a *hydronium ion*.

Now that we have seen how a strong electrolyte behaves, let us consider again the reactions using a hypothetical compound HA. The dissociation of HA can then be represented as follows:





Applying the mass action, the equilibrium constant,  $K_{\text{eq}}$ , of the reaction is:

$$K_{\text{eq}} = K_a = \frac{[\text{H}^+](\text{A}^-)}{(\text{HA})} \quad (4.39)$$

Here,  $K_{\text{eq}}$  is also called  $K_a$ , or the *ionization constant*. If  $(\text{H}^+)(\text{A}^-) = (\text{HA})$ , then  $K_a = 1$ . *Strong electrolytes* can then be defined as electrolytes with  $K_a > 1$ . The stronger the electrolyte, the more complete the dissociation, and hence, the larger will be the value of  $(\text{H}^+)(\text{A}^-)$ . As the  $K_a$  value becomes smaller, the rate of dissociation of the electrolytes decreases, and the smaller will be the value of  $(\text{H}^+)(\text{A}^-)$ . A *weak electrolyte*, therefore, is defined as an electrolyte with  $K_a < 1$ .

When in the foregoing equation  $(\text{A}^-) = (\text{HA})$ , then:

$$K_a = (\text{H}^+)$$

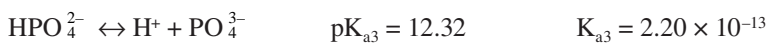
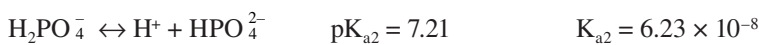
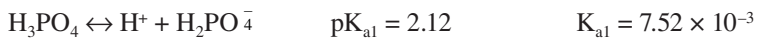
Multiplying this equation with  $-\log$  gives:

$$-\log K_a = -\log (\text{H}^+)$$

or

$$\text{p}K_a = \text{pH} \quad (4.40)$$

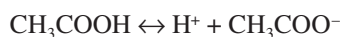
Hence, the  $\text{p}K_a$  can be defined as “the pH at which the electrolyte dissociates and produces equal concentrations of anions and undissociated molecules.” The  $\text{p}K_a$  value is an important property of chemical compounds, because it indicates their ionization capability. Monoprotic acids have one  $\text{p}K_a$  value, whereas polyprotic acids (acids capable of dissociating more than one proton per molecule) are characterized by more than one  $\text{p}K_a$  value. The latter depends on the stage or type of dissociation reaction as illustrated below:



Consequently, at pH 2.12 ( $= \text{p}K_{a1}$ ) the first dissociation is only half complete. At this stage, the acid behaves as a strong acid. At pH 7.21 ( $= \text{p}K_{a2}$ ), the second proton will be dissociated, and equal concentrations of  $\text{HPO}_4^{2-}$  and  $\text{H}_2\text{PO}_4^-$  ions will be present. The pH must be 12.32 ( $= \text{p}K_{a3}$ ) before the third and final dissociation of *orthophosphoric acid* is 50% completed. At this final stage,  $\text{H}_3\text{PO}_4$  is considered a weak acid. Therefore, under normal soil conditions, the two predominant ionic species of phosphoric acid will be  $\text{H}_2\text{PO}_4^-$  and  $\text{HPO}_4^{2-}$ , because soils with a pH = 12.32 are exceptions and do not constitute good agricultural soils.

#### 4.17 THE DISSOCIATION OF WEAK ELECTROLYTES

Weak acids and bases exhibit only a slight dissociation. Acetic acid in water theoretically dissociates into:



By applying the mass action law the extent of dissociation can be written as:

$$K_{\text{eq}} = \frac{[(\text{H}^+)(\text{CH}_3\text{COO}^-)]}{(\text{CH}_3\text{COOH})}$$

In this type of reaction,  $K_{\text{eq}}$  is called the *ionization constant* or  $K_a$ . At 25°C the ionization constant is:

$$K_a = 1.8 \times 10^{-5}$$

When the concentration of the anion is equal to that of nonionized acid,  $K_a = (\text{H}^+)$ . This is, for example, attained by mixing 0.1 mol sodium acetate with 0.1 mol acetic acid. Under this condition  $(\text{CH}_3\text{COO}^-) = (\text{CH}_3\text{COOH}) = 0.1$  mol. Therefore:

$$\begin{aligned} K_a &= \frac{[(\text{H}^+)(\text{CH}_3\text{COO}^-)]}{(\text{CH}_3\text{COOH})} = 1.8 \times 10^{-5} \\ &= \frac{[(\text{H}^+)(0.1)]}{(0.1)} = 1.8 \times 10^{-5} \\ &= (\text{H}^+) = 1.8 \times 10^{-5} \end{aligned}$$

or

$$\text{p}K_a = 5 - \log 1.8 = 4.74$$

#### 4.18 THE HENDERSON–HASSELBALCH EQUATION

The previous discussion is applied for describing ionic properties of amino acids by the mass action law, called the *Henderson–Hasselbalch equation*. If we consider a weak acid HA, then according to the foregoing, the ionization constant is as follows:

$$K_a = \frac{[(\text{H}^+)(\text{A}^-)]}{(\text{HA})} \quad (4.41)$$

Rearranging the equation above gives:

$$(\text{H}^+) = K_a \frac{[(\text{HA})]}{[(\text{A}^-)]}$$

By taking the  $-\log$ , the equation is transformed into:

$$\begin{aligned} -\log(\text{H}^+) &= -\log K_a - \log \frac{[(\text{HA})]}{[(\text{A}^-)]} \\ \text{pH} &= \text{p}K_a + \log \frac{[(\text{A}^-)]}{[(\text{HA})]} \end{aligned} \quad (4.42)$$

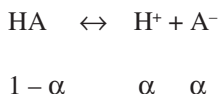
Equation 4.42 is called the *Henderson–Hasselbalch equation* and is erroneously argued as not being a mass action law formulated in logarithmic form (De Levie, 2003). The fundamental basis (Equation 4.41) is purely the law of mass action and is converted into the log-equation (Equation 4.42). Using this fundamental law in “log-form,” the Henderson–Hasselbalch equation is now applied to predict the behavior of ampholytes, such as amino acids and protein, in solution. All amino acids contain ionizable groups that act as weak acids or bases and give or take protons with change in pH. The ionization of such amphoteric compounds follows the Henderson–Hasselbalch equation, which can be written in the following generalized form:

$$\text{pH} = \text{p}K_a + \log \frac{[\text{Unprotonated Form (base)}]}{[\text{Protonated Form (acid)}]}$$

When the ratio of the concentration of the unprotonated form to that of the protonated form equals 1, the entire log expression becomes zero. Hence,  $\text{pH} = \text{pK}_a$ , as shown earlier for weak acids. Consequently,  $\text{pK}_a$  can be defined (considered synonymous) as the pH when the concentrations of unprotonated and protonated species are equal. The  $\text{pK}_a$  also equals pH when the ionizable group is at its best buffering capacity.

#### 4.18.1 APPLICATION OF THE HENDERSON–HASSELBALCH CONCEPT

Assume again the dissociation of a hypothetical organic acid, HA:



where  $\alpha$  stands for the fractional amounts in cations and anions dissociated, and  $1 - \alpha$  are the remaining amounts of undissociated molecules at equilibrium.

Application of the mass action law gives:

$$K_a = \frac{[\text{H}^+](\text{A}^-)}{(1 - \alpha)} \quad (4.43)$$

Rearranging of Equation 4.43 yields:

$$\text{H}^+ = K_a [(1 - \alpha)/(\text{A}^-)]$$

Because  $(\text{A}^-) = \alpha$ , the equation can be written as:

$$\text{H}^+ = K_a [(1 - \alpha)/(\alpha)]$$

By taking the  $-\log$ , the equation is transformed into:

$$-\log \text{H}^+ = -\log K_a - \log [(1 - \alpha)/(\alpha)]$$

or

$$\text{pH} = \text{pK}_a + \log [(\alpha)/(1 - \alpha)] \quad (4.44)$$

Equation 4.44 is valid for the dissociation of *monoprotic acids*, as indicated by the foregoing dissociation reaction. For *polyprotic acids* for which the dissociation yields a number of  $n$  anions, the equation is formulated as:

$$\text{pH} = \text{pK}_a + n \log [(\alpha)/(1 - \alpha)] \quad (4.45)$$

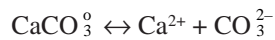
If  $n = 1$ , Equation 4.45 returns to Equation 4.44. For polyprotic acids,  $n = 2$  or more. Equation 4.45 is sometimes called the *modified Henderson–Hasselbalch equation*. It represents a linear regression curve, in which  $\text{pK}_a$  is the intercept and  $n$  is the slope of the curve.

### 4.19 THE EQUILIBRIUM CONSTANT AND ION PAIRS

*Ion pairs* are defined as pairs of oppositely charged ions that behave as a thermodynamic entity (Davies, 1962). The neutral molecule has gained sufficient energy to cause one constituent atom to become positively and the other negatively charged without the molecule breaking apart. Today the concept is more complex and perhaps somewhat ambiguous by recognizing several types of ion pairs.

Wright (2005) distinguishes three types of ion pairs defined as (1) ion pairs formed with no disruption of the *solvation sheaths* around the individual ions so that these sheaths are in contact in an ion pair. The present author believes that the name *outersphere ion pair*, as also stated by Wright, applies to this type of ion pairs; (2) ion pairs with total disruption of the solvation sheaths so that bare ions are in contact with no solvent in between. This is then the *innersphere ion pair type* as mentioned by Wright; and (3) ion pairs with partial disruption of the solvation sheaths and some solvent still left between the individual ions. In soil systems, the solvation sheaths are composed mainly of water and, hence, are equivalent to hydration sheaths or *hydration shells*, the more common term in soil science.

Strong electrolytes often will not dissociate completely into their component ions. Because of short-range interactions between closely adjacent cations and anions, these ions remain strongly attracted to each other. Therefore, a considerable portion may behave as if they were not ionized. The pairing of ions can be illustrated as follows with  $\text{Ca}^{2+}$  and  $\text{CO}_3^{2-}$ :



in which  $\text{CaCO}_3^{\circ}$  is the  $\text{Ca}^{2+} - \text{CO}_3^{2-}$  pair. The equilibrium constant for such a reaction is:

$$K_{\text{eq}} = [(\text{Ca}^{2+})(\text{CO}_3^{2-})]/(\text{CaCO}_3^{\circ})$$

Although  $K_{\text{eq}}$  is formulated in a similar way to that of weak electrolytes, the dissociation of ion pairs is affected by forces different from those in weak electrolytes. The attraction in ion pairs is caused by coulombic forces, whereas in weak electrolytes, covalent bonds are the reasons for a weak dissociation.

Soil cations and anions that have been reported to pair extensively are  $\text{H}^+$ ,  $\text{K}^+$ ,  $\text{Na}^+$ ,  $\text{Ca}^{2+}$ ,  $\text{OH}^-$ ,  $\text{HCO}_3^-$ ,  $\text{CO}_3^{2-}$ , and  $\text{SO}_4^{2-}$ . Chloride ions,  $\text{Cl}^-$ , do not form ion pairs with other cations to any measurable amounts (Davies, 1962; Garrels and Christ, 1965). Selected ion pairs commonly found in the soil solution and their equilibrium constants are listed in Table 4.2.

---

**TABLE 4.2**  
**Selected Ion Pair Reactions and Their**  
**Equilibrium Constants**

Ion Pairs	$K_{\text{eq}}$
$\text{CaCO}_3^{\circ} \leftrightarrow \text{Ca}^{2+} + \text{CO}_3^{2-}$	$6.3 \times 10^{-4}$
$\text{CaNO}_3^{\circ} \leftrightarrow \text{Ca}^{2+} + \text{NO}_3^-$	$5.25 \times 10^{-1}$
$\text{CaSO}_4^{\circ} \leftrightarrow \text{Ca}^{2+} + \text{SO}_4^{2-}$	$5.25 \times 10^{-3}$
$\text{MgSO}_4^{\circ} \leftrightarrow \text{Mg}^{2+} + \text{SO}_4^{2-}$	$5.88 \times 10^{-3}$
$\text{NaSO}_4^- \leftrightarrow \text{Na}^+ + \text{SO}_4^{2-}$	$2.4 \times 10^{-1}$
$\text{NaCO}_3^- \leftrightarrow \text{Na}^+ + \text{CO}_3^{2-}$	$5.35 \times 10^{-2}$
$\text{NaHCO}_3^{\circ} \leftrightarrow \text{Na}^+ + \text{HCO}_3^-$	$0.178 \times 10^{-1}$

*Sources:* Davies, C. W. *Ion Association*, Butterworth, Washington, DC, 1962; Garrels, R. M., and C. L. Christ. *Solutions, Minerals, and Equilibria*, Harper & Row, New York, 1965.

---

## 4.20 THE EXCHANGE CONSTANT AND ION EXCHANGE

Negatively charged organic and inorganic colloids have the capacity to adsorb and exchange cations, a topic that will be discussed in detail in Chapter 7 on cation exchange. An example of an exchange reaction involving monovalent ions can be illustrated as follows.



Application of the mass action law gives:

$$K_{\text{eq}} = K_{\text{ex}} = \frac{\{(\text{A}^+)[\text{B}^+]\}}{\{[\text{A}^+](\text{B}^+)\}} \quad (4.46)$$

where  $K_{\text{ex}}$  is the exchange constant, ( ) are free ion activities, and [ ] are adsorbed ion activities. The term *exchange constant*,  $K_{\text{ex}}$ , is chosen here to replace the name equilibrium constant,  $K_{\text{eq}}$ , to indicate that this constant pertains to the equilibrium condition of cation exchange reactions.

Rearranging Equation 4.46 gives the following relation:

$$(\text{A}^+)/(\text{B}^+) = K_{\text{ex}} \{[\text{A}^+]/[\text{B}^+]\} \quad (4.47)$$

For monovalent cation exchange, the *exchange constant*  $K_{\text{ex}}$  is considered a measure of the selectivity of the exchanger or the micelle (clay particle). Therefore, in many books  $K_{\text{ex}}$  is also considered as a *selectivity coefficient* (Sposito, 2008). Objections were also leveled that  $K_{\text{ex}}$  was not a constant but would change with conditions; hence, the name selectivity coefficient was preferable (Sparks, 2003). However, the name exchange constant ( $K_{\text{ex}}$ ) is in fact only another name for equilibrium constant (see Equation 4.46), and its value will change at different equilibrium stages. To make it more complex, several types of selectivity coefficients are recognized, such as the *Vanselow*,  $K_{\text{V}}$ , and the *Gapon selectivity coefficients*,  $K_{\text{G}}$ . Though both the Vanselow and Gapon coefficients have been derived from mono-divalent exchange reactions, they are in essence conveying the same message as the  $K_{\text{ex}}$ . Basically, the term ion selectivity only indicates the tendency to adsorb one ion more strongly than another. Suppose  $K_{\text{ex}} = 5$ , and the ratio  $(\text{A}^+)/(\text{B}^+)$  of the ion activities in solution equals 1, then one of the ions will be adsorbed in larger amounts and more strongly by the micelle than the other. Equal rates of adsorption of  $(\text{A}^+)$  and  $(\text{B}^+)$  ions take place only if the activity ratio of the ions in solution has the same value as the exchange constant.

## 4.21 THE RELATIONSHIP BETWEEN THE EQUILIBRIUM CONSTANT AND CELL OR ELECTRODE POTENTIAL

If the equilibrium reaction  $\text{A} + \text{B} \leftrightarrow \text{C} + \text{D} + ne$  is considered, then in accordance to the concepts of the oxidation potentials the following relationship is valid:

$$E_{\text{h}} = E^{\circ} + (RT/nF) \ln [(C)(D)/(A)(B)]$$

Because

$$\ln [(C)(D)/(A)(B)] = \ln K_{\text{eq}}$$

and therefore,

$$E_{\text{h}} = E^{\circ} + (RT/nF) \ln K_{\text{eq}} \quad (4.48)$$

where  $E_h$  is the oxidation potential,  $E^\circ$  is the standard oxidation potential,  $R$  is the gas constant,  $T$  is absolute temperature (K),  $n$  is valence,  $F$  is the Faraday constant, and  $K_{eq}$  is the equilibrium constant.

Changing from the natural to the common logarithm ( $\ln = 2.303 \log$ ),  $E_h$  assumes the following formula:

$$E_h = E^\circ + (0.059/n) \log K_{eq} \quad (4.49)$$

## 4.22 THE EQUILIBRIUM CONSTANT AND FREE ENERGY RELATIONSHIP

The derivation of the laws governing equilibrium constants comes from thermodynamics. Chemical thermodynamics is the science of energy relations within chemical systems. In any chemical reaction, energy changes are occurring. A system that is not in equilibrium will spontaneously undergo changes by releasing energy. At equilibrium, the energy changes of the reactants must equal the energy changes of the products, and the following relationship is valid:

$$\Delta G_r = \Delta \text{Free Energy Products} - \Delta \text{Free Energy Reactants} = 0 \quad (4.50)$$

$\Delta G_r$  is the free energy change of reaction. The use of the symbol  $G$  is preferred by many authors over the symbol  $F$  because  $G$  denotes the Gibbs free energy. Equation 4.50 expresses the *first law of thermodynamics*.

For a general reaction  $A + B \leftrightarrow C + D$ , the free energy change of reaction in thermodynamics is written as:

$$\Delta G_r = \Delta G_r^\circ + RT \ln [(C)(D)/(A)(B)]$$

or

$$\Delta G_r = \Delta G_r^\circ + RT \ln K \quad (4.51)$$

where  $K$  is the activity ratio, and  $\Delta G_r^\circ$  is the standard free energy change of reaction.

If  $\Delta G_r$  has a negative value, the reaction will go spontaneously to the right. However, if  $\Delta G_r$  is positive, the reaction will occur in the reverse direction or to the left. If, on the other hand,  $\Delta G_r = 0$ , then in accordance with the first law of thermodynamics, the reaction is at equilibrium and the activity ratio,  $K$ , in Equation 4.51 becomes automatically the equilibrium constant,  $K_{eq}$ . Consequently, at equilibrium condition, the following relationship is valid:

$$\Delta G_r = 0 = \Delta G_r^\circ + RT \ln K_{eq}$$

Therefore,

$$\Delta G_r^\circ = -RT \ln K_{eq} \quad (4.52)$$

or

$$\Delta G_r^\circ = -1.364 \log K_{eq} \quad (\text{at } 25^\circ\text{C} = 298 \text{ K})$$

Hence, at equilibrium, the activity ratio  $K$  equals the equilibrium constant  $K_{eq}$ , and  $K_{eq}$  is now called the *thermodynamic equilibrium constant*. It is not similar to the Gapon and Vanselow equilibrium constants,  $K_G$  and  $K_V$ , respectively, as some authors wanted them to be, because both  $K_G$  and  $K_V$  do not include a thermodynamic parameter, such as  $\Delta G$ .

### 4.23 THE EQUILIBRIUM CONSTANT AND ELECTRON ACTIVITY

As discussed earlier, electrons are active components in a reaction, as with  $H^+$  ions. Consequently, the number of electrons transferred in a reaction can be included in the derivation of the equilibrium constant  $K_{eq}$ . Consider again the generalized half-cell redox reaction:



This equation indicates that analogous to the *acid–base concept of Brønsted* (see Chapter 9), compounds capable of performing oxidation are then *electron acceptors*, whereas those causing reduction are *electron donors*. At standard state, the equilibrium constant of Equation 4.53 is:

$$K_{eq}^{\circ} = (\text{Reduction})/[(\text{Oxidation})(e^-)^n] \quad (4.54)$$

By taking the log, the equation is transformed into:

$$\log K_{eq}^{\circ} = \log (\text{Reduction})/[(\text{Oxidation})(e^-)^n]$$

or

$$\log K_{eq}^{\circ} = \log [(\text{Reduction})/(\text{Oxidation})] + npe \quad (4.55)$$

The redox potential of Equation 4.53 is:

$$E_h = E^{\circ} - [(RT)/(nF)] \ln (\text{Reduction})/(\text{Oxidation})$$

or

$$E_h = E^{\circ} - (0.059)/n \log (\text{Reduction})/(\text{Oxidation}) \quad (4.56)$$

From Equation 4.55:

$$\log (\text{Reduction})/(\text{Oxidation}) = \log K_{eq}^{\circ} - npe$$

Substituting this in Equation 4.56 gives:

$$E_h = E^{\circ} - [(0.059)/n] (\log K_{eq}^{\circ} - npe) \quad (4.57)$$

From thermodynamics:

$$nFE^{\circ} = (RT) \ln K_{eq}^{\circ}$$

$$E^{\circ} = [(RT)/(nF)] \ln K_{eq}^{\circ}$$

or

$$E^{\circ} = [(0.059)/n] \log K_{eq}^{\circ}$$

Substituting this in Equation 4.57 gives:

$$E_h = [(0.059)/n] \log K_{eq}^{\circ} - [(0.059)/n](\log K_{eq}^{\circ} - npe)$$



or

$$E_h = 0.059pe \quad (4.58)$$

In the Equation 4.58,  $E_h$  is in volts. As discussed earlier, Equation 4.58 indicates that the redox potential can be expressed either as  $E_h$  or  $pe$ , because  $pe$  can be converted into  $E_h$ , or vice versa. It is sometimes suggested to express redox conditions in terms of  $pe$  rather than in terms of  $E_h$ , because low  $pe$  values indicate the presence of reducing conditions or the tendency of the compound to be an electron donor. It then goes without saying that high  $pe$  values suggest the presence of oxidation conditions or electron acceptors.

#### 4.24 ACTIVITY AND STANDARD STATE

*Activity* is a measure of the effective concentration of a reactant or product in a chemical reaction. The concentration of a substance does not always accurately describe its reactivity in a chemical reaction. The activity or effective concentration differs from the actual concentration because of interionic attraction and repulsion. The difference between activity and concentration becomes substantially large when the concentration of the reactants is large. At high concentrations, the individual particles of the reactants may exert a mutual attraction to each other or exhibit interactions with the solvent in which the reaction takes place. On the other hand, in very dilute condition, interactions are less, if not negligible. To correct for the difference between actual and effective concentration, the *activity coefficient* ( $\gamma$ ) is introduced. The activity coefficient expresses the ratio of activity to concentration:

$$(a_A)/(c_A) = \gamma \text{ or } a_A = \gamma c_A \quad (4.59)$$

where  $\gamma$  is the activity coefficient,  $a_A$  is the activity of species A, and  $c_A$  is the concentration of species A. To avoid possible confusions, the symbol  $\gamma$  (gamma) is used here instead of “f” as recommended by several others, including the International Union of Pure and Applied Chemistry (IUPAC) (Boyes, 2002; Cohen et al., 2007), because the symbol “f” is usually used to refer to “function.”

The activity coefficient is not a fixed quantity but varies in value depending on the conditions. In very dilute (infinite dilution) conditions, the activity coefficient approaches unity. The value of  $\gamma \sim 1$ ; hence, activity equals concentration:

$$a_A = c_A$$

Activity coefficients apply to cations as well as to anions:

$$\text{Cations: } \gamma_+ = (a^+)/(m^+)$$

$$\text{Anions: } \gamma_- = (a^-)/(m^-)$$

where  $m^+$  is the concentration of cations, and  $m^-$  is the concentration of anions.

The mean activity coefficient is then:

$$\gamma_{\pm} = \{[(a^+)/(m^+)][(a^-)/(m^-)]\}^{1/2} \text{ or } \gamma_{\pm} = [(\gamma_+)(\gamma_-)]^{1/2}$$

The mean ionic activity formulated above is valid only for monoprotic (1 – 1) electrolytes, such as HCl and NaCl. For polyprotic electrolytes, the formula for the mean activity coefficient of the ions changes into:

$$\gamma_{\pm} = [(\gamma_+)(\gamma_-)^2]^{1/3} \text{ for compounds such as CaCl}_2$$

or

$$\gamma_{\pm} = [(\gamma_{+})^2(\gamma_{-})]^{1/3} \text{ for compounds such as H}_2\text{SO}_4$$

Consequently, the mean activity coefficient of the ions in (1 – 3) and (3 – 1) electrolytes (e.g.,  $\text{AlCl}_3$ ) is then:

$$\gamma_{\pm} = [(\gamma_{+})(\gamma_{-})^3]^{1/4} \text{ for compounds such as AlCl}_3$$

or

$$\gamma_{\pm} = [(\gamma_{+})^3(\gamma_{-})]^{1/4} \text{ for compounds such as H}_3\text{PO}_4$$

The activity coefficient in the standard state is indicated by  $\gamma^{\circ}$ . A *standard state* is defined for each substance in terms of a set of reference conditions. Each pure substance in its standard state is assigned an activity of unity. The standard state of solids and liquids is usually chosen as the pure substances under standard conditions of 1 atm pressure and a specified temperature. Because 298.15 K, equivalent to 25°C, is a commonly used temperature, it is called the *reference temperature*. The standard state of gas is a perfect gas, obeying  $PV = nRT$ , at 1 atm pressure and a specified temperature.

#### 4.25 THE DEBYE–HÜCKEL THEORY AND ACTIVITY COEFFICIENTS

The *Debye–Hückel theory*, developed by Peter Debye and Eric Hückel in 1923, is simply a concept conveying the behavior of ionic solutions, in which electrical potential fluctuations due to ions are practically very small (Debye and Hückel, 1923). The solutions are considered dilute solutions composed of structureless solvents and a mixture of ions of valences  $z$  and radii  $a$ . The theory provides an equation, the famous *Debye–Hückel equation*, for determination of individual ion activity coefficient (Cohen et al., 2007; Kirkwood and Salsburg, 2001):

$$-\log \gamma_i = \left( A z_i^2 \sqrt{I} \right) / \left( 1 + a_i' B \sqrt{I} \right) \quad (4.60)$$

where  $A$  and  $B$  are constants of the solvents at a specified temperature and pressure,  $z$  is the valence,  $i$  is the ion species,  $I$  is the ionic strength, and  $a_i'$  is the effective diameter of the ion.

Values of  $A$  and  $B$  as a function of temperature at 1 atm are given in Table 4.3. When the ionic strength becomes very small—in other words, in very dilute solutions— $(1 + a_i' B \sqrt{I}) = 1$ , and Equation 4.60 changes into:

$$\log \gamma_i = A (z_+ z_-) \sqrt{I}$$

because  $z_+ = z_-$ ; hence,

$$\log \gamma_i = A z_i^2 \sqrt{I} \quad (4.61)$$

Equation 4.61 is often called the *limiting Debye–Hückel law* (Kirkwood and Salsburg, 2001). The value of  $A$  at 25°C and 1 atm pressure equals 0.509 (see Table 4.3), and the Debye–Hückel limiting law can then be written as follows:

$$\log \gamma_i = 0.509 z_i^2 \sqrt{I} \quad (4.62)$$

**TABLE 4.3**  
**Selected Values of A and B as a**  
**Function of Temperature at 1 atm for**  
**Use in the Debye–Hückel Equation**

Temperature		A	B( $\times 10^{-8}$ cm)
$^{\circ}\text{C}$	K		
0	273	0.4883	0.3241
5	278	0.4921	0.3249
10	283	0.4960	0.3258
15	288	0.5000	0.3262
20	293	0.5042	0.3273
25	298	0.5085	0.3281
30	303	0.5130	0.3290
35	308	0.5175	0.3297
40	313	0.5221	0.3305
45	318	0.5271	0.3314
50	323	0.5319	0.3321

*Sources:* Garrels, R. M., and C. L. Christ. *Solutions, Minerals, and Equilibria*, Harper & Row, New York, 1965; Manov, G. G. et al. *J. Am. Chem. Soc.*, 65, 1765, 1943. Values for  $a^{\text{i}}$  can be found in Klotz, I. M. *Chemical Thermodynamics*, Prentice Hall, Englewood Cliffs, NJ, 1950. See also footnote in Table 4.4.

## 4.26 IONIC STRENGTH

The term *ionic strength* is used as a measure of the strength of ionic concentrations in the solution (Cohen et al., 2007). The concept was introduced by Lewis and Randall (1921) to assess the combined effect of the activities of several electrolytes in solution on a given electrolyte. The sphere of influence for interactions between ionic charges is called the *Debye sphere*, and its radius is then the distance over which charge separation can occur. This radius, called the *Debye length* or *radius*,  $\tau_{\text{D}}$ , was named after the Dutch physical chemist Peter Debye (Kirkwood and Salsburg, 2001). It is considered the effective range for interactions between ionic charges. These charges are screened outside the Debye–Hückel influence sphere. The concept of ionic strength is a useful relation in comparing solutions of diverse composition, as in soil water, river water, lake water, and ocean water. It is also a fundamental parameter of the Debye–Hückel equation. The *ionic strength* is usually defined as follows:

$$I = \frac{1}{2} \sum m_i z_i^2 \quad (4.63)$$

where  $m$  stands for the moles of ions  $\text{L}^{-1}$ ,  $z_i$  is the charge of the cations and anions, and  $I$  is the ionic strength.

The summation is taken over all ions, positive and negative. For example, the ionic strength of a 1 M CaCl<sub>2</sub> solution is:

$$I = \frac{1}{2} \sum [(m_{\text{Ca}} \times 2^2) + (m_{\text{Cl}} \times 1^2) + (m_{\text{Cl}} \times 1^2)] \\ = \frac{1}{2} \sum [(1 \times 4) + 2(1 \times 1)] = 3$$

That of a 1/2 M NaCl solution is then:

$$I = \frac{1}{2} \sum [(m_{\text{Na}} \times 1^2) + (m_{\text{Cl}} \times 1^2)] \\ = \frac{1}{2} \sum [(1/2 \times 1) + (1/2 \times 1)] = 1/2$$

In some of the physical chemistry books, the formula for the ionic strength is written as:

$$I = \frac{1}{2} \sum (m_+ z_+ + m_- z_-) / m^\circ \quad (4.64)$$

where  $m^\circ$  = moles at standard state = unity or 1. Consequently, Equation 4.64 can be changed into:

$$I = \frac{1}{2} \sum (m_+ z_+ + m_- z_-)$$

In practice, this definition is similar to that expressed in Equation 4.64.

#### PRACTICE

Try to calculate the ionic strength of the following soil solution, for which chemical analysis revealed ion concentrations as listed:

Ion	ppm (mg/L)	mol/L	$m_i z_i^2$
Na <sup>+</sup>	2300	(2300)/(23 × 10 <sup>3</sup> ) = 0.100	0.100 × 1 <sup>2</sup> = 0.100
Ca <sup>2+</sup>	80	(80)/(40 × 10 <sup>3</sup> ) = 0.002	0.002 × 2 <sup>2</sup> = 0.008
Mg <sup>2+</sup>	48	(48)/(24 × 10 <sup>3</sup> ) = 0.002	0.002 × 2 <sup>2</sup> = 0.008
SO <sub>4</sub> <sup>2-</sup>	0288	(288)/(96 × 10 <sup>3</sup> ) = 0.003	0.003 × 2 <sup>2</sup> = 0.012
Cl <sup>-</sup>	1750	(1750)/(35 × 10 <sup>3</sup> ) = 0.050	0.050 × 1 <sup>2</sup> = 0.050
CO <sub>3</sub> <sup>2-</sup>	60	(60)/(60 × 10 <sup>3</sup> ) = 0.001	0.001 × 2 <sup>2</sup> = 0.004
HCO <sub>3</sub> <sup>-</sup>	2745	(2745)/(61 × 10 <sup>3</sup> ) = 0.045	0.045 × 1 <sup>2</sup> = 0.045

$$I = \frac{1}{2}(0.100 + 0.008 + 0.008 + 0.012 + 0.050 + 0.004 + 0.045) = 0.114.$$

The average ionic strength for water in rocks is about 0.100, whereas streams and lakes have ionic strengths of about 0.010. The ionic strength of ocean water is approximately 1 (Garrels and Christ, 1965). The higher is the ionic strength, the lower will be the ion activity (lower  $\gamma$ ), as illustrated by the data in Table 4.4.

**TABLE 4.4**  
**Effect of Ionic Strength on Single-Ion Activity**  
**Coefficient**

a <sup>a</sup>	Ionic Strength of Solution				
	0.001	0.005	0.010	0.050	0.100
<b>Monovalent Ion Activity</b>					
3	0.964	0.925	0.899	0.805	0.755
4	0.964	0.927	0.901	0.815	0.770
9	0.967	0.933	0.914	0.860	0.830
<b>Divalent Ion Activity</b>					
5	0.868	0.744	0.670	0.465	0.380
6	0.870	0.749	0.675	0.485	0.405
8	0.872	0.755	0.690	0.520	0.450
<b>Trivalent Ion Activity</b>					
4	0.725	0.505	0.395	0.160	0.095
9	0.738	0.540	0.445	0.245	0.180

<sup>a</sup> *a* is the effective diameter of ions.

Monovalent, *a* = 3: K<sup>+</sup>, Cl<sup>-</sup>, Br<sup>-</sup>, I<sup>-</sup>, NO<sub>3</sub><sup>-</sup>; *a* = 4: Na<sup>+</sup>; *a* = 9: H<sup>+</sup>;

Divalent, *a* = 5: Sr<sup>2+</sup>, Ba<sup>2+</sup>, Ra<sup>2+</sup>, Cd<sup>2+</sup>; *a* = 6: Ca<sup>2+</sup>, Cu<sup>2+</sup>, Zn<sup>2+</sup>,

Mn<sup>2+</sup>, Fe<sup>2+</sup>; *a* = 8: Mg<sup>2+</sup>; Trivalent, *a* = 4: PO<sub>4</sub><sup>3-</sup>; *a* = 9: Al<sup>3+</sup>, Fe<sup>3+</sup>, Cr<sup>3+</sup>.

Source: Klotz, I. M. *Chemical Thermodynamics*, Prentice-Hall, Englewood Cliffs, NJ, 1950.

---

# 5 Colloidal Chemistry of Organic Soil Constituents

## 5.1 THE COLLOIDAL SYSTEM

The definition of colloids varies somewhat from author to author (Cosgrove, 2005; Levine, 2000). Some define *colloids* as very small particles, whereas others refer to them as *mixtures* of dispersion media and the homogeneously dispersed minute particles in the media. Wikipedia, the free encyclopedia on the Internet, defines a colloid as a *type of chemical mixture* where one substance is dispersed evenly throughout another (<http://Wikipedia.org/wiki/Colloid>, accessed February 3, 2009). Such a definition is subject to arguments. Solids, liquids, or gases can be dispersed in solid, liquid, and gas dispersion media. For example, a solid dispersed in a gas produces an *aerosol*, such as smoke, but when dispersed in a liquid it is called a *sol*, such as ink or muddy water. When a liquid is dispersed in a gas medium, it also forms an *aerosol*, like spray and fog, but when it is dispersed in a liquid it is called an *emulsion*, like milk, and when it is dispersed in a solid medium it produces a *gel*, like jellies and cheese. From the examples above, it is perhaps clear that aerosols, fogs, ink, milk, jellies, and the like are in fact *colloidal systems*, whereas the solid particles within the systems are the *colloids*. Muddy water is in fact clay particles suspended in water. It is very difficult to consider water as a colloid, because H<sub>2</sub>O is a molecule. The colloids are the finely divided clay particles. Therefore, this book uses a college chemistry textbook definition stating that a *colloid* is “a state of matter consisting of very fine particles that approach, but never reach molecular sizes.” The upper size limit of colloids is 0.2 μm, and the lower size limit is approximately 50 Å (5 nm = 0.005 μm), the size of a molecule. Defining upper and lower size limits of colloidal particles is arbitrary, because the size of colloids represents a continuum, ranging from 1 μm to 0.001 μm (= 1 nm), the original limits suggested by Thomas Graham (1805–1869), who discovered the presence of colloids. Though a size limit of 0.45 μm is most widely accepted, many scientists believe that the range of 2 to 5 μm would better describe the hydrodynamic behavior of large colloids, a size range that coincides with the usual clay–silt boundary in soil science (Ranville and Schmiermund, 1998; Tan, 2003). In pure chemistry and biological science, colloidal sizes can be expressed in terms of *linear dimensions* (μm or nm) or in terms of *mass* using molecular weights or *daltons* (see Section 2.7.1; McGraw-Hill, 2005). The choice depends on the purpose of study, and no direct statistical conversion of linear units into mass units is available, though a few daltons are usually considered equivalent to a diameter of 1 nm (= 0.001 μm or 10<sup>-9</sup> m).

The colloids can be divided into two groups. They are considered *lyophobic* (solute hating) if the dispersed phase does not interact with the dispersion medium. They are called *lyophilic* if they do interact. If the dispersion medium is water, often the terms *hydrophobic* and *hydrophilic* may be used. A hydrophobic colloid can be flocculated, but a hydrophilic usually cannot. Many organic compounds exhibit both hydrophobic and hydrophilic characteristics in the same molecule. Such compounds or molecules are called *amphiphilic*, such as phospholipids and many amino acids. Detergents are examples of synthetic amphiphilics. In some of the amphiphilics, one end of the molecule is hydrophobic, whereas the other end is hydrophilic. These compounds are good *surfactants*.

As indicated above, colloidal systems can exist as gels or sols. A *gel* is defined as a colloidal system that exhibits the properties of a solid. Two types of gels are recognized: (1) *true gels*, which

are formed by coagulation of lyophilic colloids—fruit jellies and gelatins are good examples of true gels—and (2) *gels*, which are precipitates formed by the coagulation of lyophobic colloids. They are sometimes referred to as *coagula*. *Sols*, on the other hand, are colloidal systems that behave as liquids. A sol exists as a fluid, and to the eye it is homogeneous and looks like a solution. If the dispersion medium is water, the terms *hydrosols* and *hydrogels* are often used.

Plants and soils contain large amounts of solid material that is in a colloidal state. Such material exhibits chemical and physical properties that depend upon the colloidal condition. The inorganic material in the soil is made up of boulders, rocks, gravel, sand, silt, and clay. Boulders, rocks, and gravel are not considered soil constituents, but they will form sand, silt, and clay upon weathering, the three major inorganic constituents of soils. Sand and silt are too big to be classified as soil colloids, but clay, which comprises all inorganic solids smaller than 0.002 mm (<2  $\mu\text{m}$ ) in effective diameter, is considered a soil colloid, though theoretically only the fine clay fraction meets the requirement of the upper size limit (0.2  $\mu\text{m}$ ) of pure colloids. Soil organic matter and plant solids also occur in the colloidal state. Humus, protoplasm, and cell walls exhibit many properties of colloidal systems.

Many chemical and biological reactions occur at the colloid solid–liquid interfaces. *Adsorption* takes place at the interface. This refers to the concentration of materials at the colloidal surface. In contrast, *absorption* indicates the uptake and retention of one material within another. Sometimes, it is difficult to distinguish between adsorption and absorption, and in such a case the term *sorption* is proposed. *Desorption* is used to indicate the release or removal of materials that were sorbed or adsorbed. The substance sorbed is called the *sorbate*, and the material as the vehicle for sorption is called the *sorbent*.

## 5.2 THE ORGANIC COMPONENTS

The organic fraction of soils originates from the biomass that is characteristic for an active soil. Although, strictly speaking, both living organisms and the dead organic components are included in the term *soil organic matter* (SOM) as used widely today soil organic matter refers confusingly only to the nonliving fraction produced by the degradation and decomposition of plants and animals (Manley et al., 2007). This dead material can be divided into (1) degraded materials in which the anatomy of the plant substance is still visible and (2) completely decomposed material. All the macro- and microbial life within the soil (e.g., bacteria, fungi, ants, and more) are commonly ignored, though they control many important biochemical reactions. The first group—the degraded materials—is of significance in soil physics (e.g., protection of soils by leaf mulch, decreasing bulk density and affecting soil structure). However, from the standpoint of soil chemistry, this nondecomposed organic fraction is chemically of minor importance because its intact structure exhibits a relatively small surface area, rendering it inactive as an adsorbent. The term *litter* is often used for this type of organic matter when it lies on the soil surface. In forest and grassland soils, litter is particularly important in the process of nutrient cycling. The second group—the decomposed fraction—called *humus* in this book, is composed of nonhumified and humified substances, which will be discussed in more detail in Section 5.3. It is of major importance in soil chemistry, although its nature and accumulation in soils depend on types and quantity of the original plant material.

The plant tissue is composed of C, H, O, N, S, P, and a number of other elements. The inorganic ions make up the ash content that sometimes accounts for as much as 10% of the dry weight of the tissue. The organic part of the plant tissue is composed of numerous organic compounds, including 15% to 60% cellulose, 10% to 30% hemicellulose, 2% to 15% protein, and 5% to 30% lignin (Paul and Clark, 1989), among many others. Some of them are present in detectable amounts in soils after decomposition, whereas others are present only in minute amounts. The organic compounds, present in detectable amounts in soils, are primarily (1) carbohydrates, (2) amino acids and proteins, (3) lipids, (4) nucleic acids, (5) lignins, and (6) humic compounds. Humic compounds are not exactly constituents of plant tissue, but they have been synthesized in soils from lignin, amino acids, and carbohydrates by a process called *humification*.



### 5.3 SOIL HUMUS

The term *soil humus* refers to a mixture of the organic compounds produced by decomposition of the plant tissue as discussed above. The name is not related to *hummus* or *humous*, an Arabic term for a Middle Eastern dip or spread of *mashed chickpeas*. The term humus means *soil* or *earth*, but was then interpreted as a “precursor of soil organic matter” (Manley et al., 2007). Humus was defined by Stevenson (1994) as the total organic fraction in soils, exclusive of nondecomposed plant and animal material, their partial decomposition products, and the soil biomass. At present, many other scientists consider humus also to be the amorphous dark colloidal soil material composed of complex organic fractions of microbial, plant, and animal origin (Whitehead and Tinsley, 2006). Though these authors indicated that humus is resistant to further weathering and will remain the same for centuries, the fact is that humus is subject to further oxidation processes. As the main source of food and energy of soil microorganisms, humus will disappear quickly, but in the process new humus will be formed. The presence of humus promotes the development of plant, animal, and microbial biodiversity as suggested by Ponge (2003). As indicated above, soil humus is a mixture of organic residues that have lost their original structures due to the decomposition processes, and also includes synthesized substances and by-products of microorganisms, such as *humic substances*. Humic compounds (e.g., humic acids and fulvic acids) make up the bulk of humus, though lignin can also be substantial in amount. However, Stevenson (1994) believes that carbohydrates are the second most abundant component of humus. The carbohydrate concentration has been estimated to range from 5% to 25% in soil humus. Soils rich in nondecomposed litter may contain small amounts of simple sugars but high amounts of cellulose, which is the main form of carbohydrate in higher plants. Next to carbohydrates are the lipids, which amount to 2% to 6% of soil humus. They are a diverse group of organic compounds ranging from fatty acids, waxes, and resins, to sterols, terpenes, and chlorophyll. The distribution of free amino acids, though a very important soil organic constituent of humus, is very difficult to determine due to analytical problems (e.g., incomplete extraction) and losses during hydrolysis. These compounds are also rapidly decomposed by microorganisms, and Stevenson (1994) indicated that their concentrations in soils represented the balance between microbial formation and decomposition. The amount of free amino acid in soils is estimated to be 2 mg/kg of soil but may be sevenfold higher in the soil rhizosphere. Rovira and McDougall (1967) believe that live plant roots are contributing factors by being able to secrete free amino acids in the soil rhizosphere. The term *free amino acids* refers to amino acids in soils that are not linked together into peptides or other compounds. Amino acids in soils can also be present in the cell walls of microorganisms and as essential structural constituents of humic and fulvic acids. Much of the amino acids accumulated in soils are regarded as being derived from microbial cells other than from decomposition of higher plant tissue. The concentration of these *bound* amino acids, though variable from soil to soil, can be more substantial than that of free amino acids in soil humus. In addition to these compounds, soil humus may contain an assortment of water-soluble organics and soil enzymes. However, recovery of these materials produced mixed results because of limitations in extraction procedures. Soil enzymes, which are proteinaceous compounds, are extremely difficult to determine directly but can be analyzed indirectly through their capacity to transform one compound into another. The problem of determination of enzymes becomes even more difficult because of the fact that some enzymes are produced by plant cells, which are called *constitutive*, whereas others are formed only when a susceptible compound is present and are, therefore, called *induced* enzymes. Urease is an example of a constitutive and cellulase is an example of an induced enzyme. Free enzymes, enzymes not associated with the microbial biomass, are reported to be accumulated in soils by entrapment (fixation) by inorganic and organic soil colloids (Paul and Clark, 1989), though the opinion in clay mineralogy is that most enzymes are too large to penetrate the intermicellar spaces of clay minerals. Complex formation and interactions between enzymes and soil colloids are perhaps better reasons for the presence of free enzymes in soils. In this way, perhaps the compound ATP (adenosine triphosphate), a coenzyme required in all

biosynthetic and catabolic cell reactions, can be present in soils. ATP has not yet been isolated from soils, because it is believed that it cannot persist in soils in a free state. The water-soluble organics, which include organic acids, received considerable research attention because of their importance in plant nutrition and in environmental issues due to the complexing and chelation capacity of toxic metals and xenobiotics.

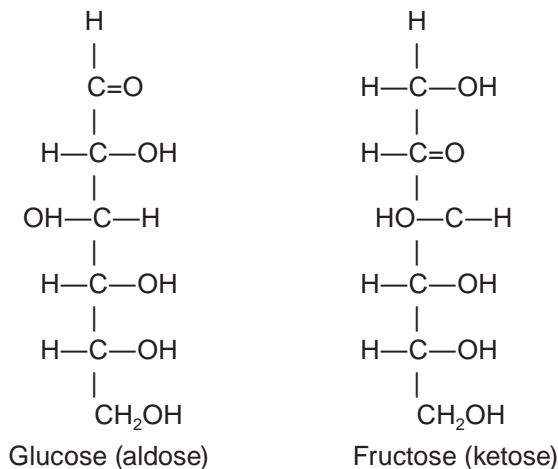
### 5.3.1 THE ISSUE OF GLOMALIN IN HUMUS

In 1996 Sarah Wright discovered the presence of *glomalin* in soils, a glycoprotein produced by arbuscular mycorrhizal fungi. Scientists from the U.S. Department of Agriculture, Agricultural Research Service (USDA-ARS) claim that its benefit as a carbon storage place is far better than humus and necessitates a reexamination of the concept of soil organic matter (Comis, 2002). Glomalin was also heralded as the “superglue” of the century in soil structure formation, and several scientists scrambled to consider reevaluation of fungal contribution to soil organic matter and aggregation (Magdoff and Weil, 2004). However, only mixed information on glomalin is available, making the issue more confusing than complex. Glomalin is reported to be found in abundance only where the particular mycorrhizal fungus is abundant, and it is speculated that it allocates carbon to the fungus (Treseder and Turner, 2007). The latter raises questions as to its origin as a true fungal metabolic product. It is also reported that glomalin is not produced by “noninfected” plant roots (Magdoff and Weil, 2004), while it must be realized that plant roots are the major contributors of soil organic matter, especially in “grassland soils,” or the soils in the Great Plains. Moreover, with a reported carbon content of 30% to 40%, glomalin is only second to humic acid’s 45% to 57% carbon content in effectiveness of organic carbon sequestration (Tan, 2009). Of interest is that Hayes and Clapp (2001) placed glomalin in the nonhumified group of humus. Many also believe soil humus to be the most persistent pool of soil organic carbon. Because soil humus possesses a mean residence time of several hundred years, Fiorentino et al. (2006) indicate it to be the major sink of soil organic carbon, hence controlling carbon dioxide emission to the atmosphere. Therefore, pending future information, glomalin as a glycoprotein can perhaps be considered as one important type among many others in the total soil protein fraction that makes up the soil humus.

## 5.4 CARBOHYDRATES

Carbohydrates are perhaps the most important substance for life on earth. They are considered the building blocks of life and allow many biological processes to take place. Today, carbohydrates present a new dimension in the production and design of drugs for the benefit of mankind (Stick and Spencer, 2008).

By scientific definition, *carbohydrates* are *polyhydroxyaldehydes*, *ketones*, or substances that yield one of these compounds on hydrolysis. Glucose ( $C_6H_{12}O_6$ ) and fructose ( $C_6H_{12}O_6$ ) are examples of an aldose and a ketose, respectively, as shown below. The *aldose group* is characterized by a *terminal carbonyl*,  $C=O$ , group, whereas the *ketose group* has its carbonyl group in the carbon chain. The foregoing structure is called an *open-chain structure*. Originally, all sugars were considered as open-chain-structured compounds. However, to explain mutarotation (decreased rotation of polarized light by a sugar solution), a *ring (cyclic) structure*, as proposed by Tollens in 1883, must be present in sugar molecules. The formation of a ring structure is illustrated in Figure 5.1. It is known that in aqueous sugar solutions, the two forms of structures are present, and an equilibrium exists between the forms with cyclic and open-chain structures.



The term *carbohydrate* indicates that these compounds are hydrates of carbon, represented by the formula:  $\text{C}_x(\text{H}_2\text{O})_y$ . However, it was found that this definition was not suitable, because several compounds exist with the properties of carbohydrates but do not have the required ratio of hydrogen to oxygen of 2:1. The sugar deoxyribose ( $\text{C}_5\text{H}_{10}\text{O}_4$ ), which is a constituent of deoxyribonucleic acid, DNA, a component of every plant cell, is an example. Some of the carbohydrates may also contain N and S, but their formulas do not agree with  $\text{C}_x(\text{H}_2\text{O})_y$ .

Carbohydrates can be divided into three groups: (1) monosaccharides, (2) oligosaccharides, and (3) polysaccharides. *Monosaccharides* are simple sugars that cannot be hydrolyzed into smaller molecules under reasonably mild conditions. According to the number of carbon atoms, monosaccharides may be trioses ( $\text{C}_3\text{H}_6\text{O}_3$ ), tetroses ( $\text{C}_4\text{H}_8\text{O}_4$ ), and so on up to octoses or nonoses. *Oligosaccharides* are compound sugars that, upon hydrolysis, yield two to six molecules of simple sugars. A disaccharide, for example, hydrolyzes into two monosaccharides, and upon hydrolysis, pentosaccharides yield five monosaccharides. *Polysaccharides* are groups of compounds that yield many different monosaccharides upon hydrolysis. They are also known today under the name *complex carbohydrates*. Hemicellulose and cellulose are polysaccharides. Some of the monosaccharides bonded together by glucosidic bonds to form polysaccharides are glucose, xylose, and arabinose. Polysaccharides are sometimes divided into *homo-* and *heteropolysaccharides*. Homopolysaccharides are composed of a repeating monosaccharide, whereas heteropolysaccharides are made up of two or more

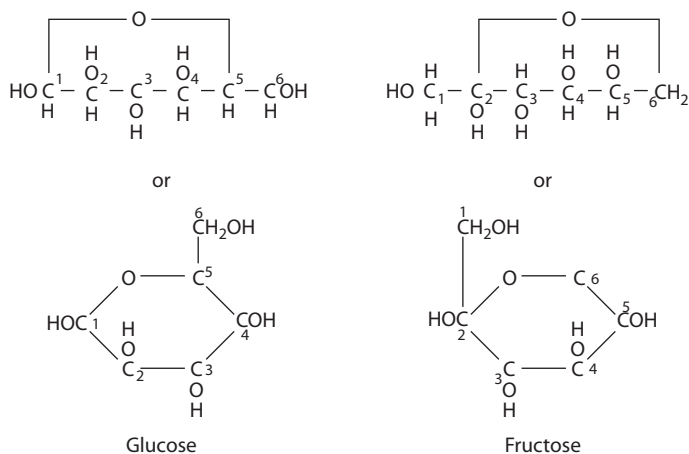
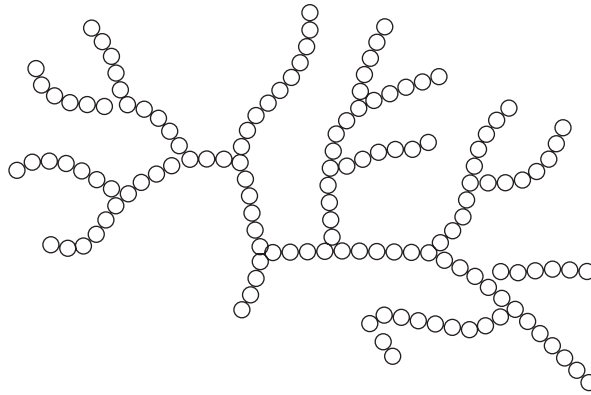


FIGURE 5.1 Types of ring structures of glucose and fructose.



**FIGURE 5.2** Glycogen, a branch-structured polysaccharide from animal tissue. Each circle represents a glucose molecule in the chain.

different monosaccharides. The monosaccharide molecules can be bonded in a straight chain, or they can form branchlike structures (Figure 5.2). Hydrolysis in an acid medium is usually employed to release the monosaccharides. The sugars released are identified by either gas chromatography or paper chromatography.

#### 5.4.1 PROPERTIES OF CARBOHYDRATES AND THEIR ACCUMULATION IN SOILS

The properties of these carbohydrates change significantly with increasing molecular complexity. The simple sugars are readily soluble in water. The oligosaccharides are crystalline compounds, readily soluble in water, and are usually sweet in taste. Polysaccharides are frequently tasteless, insoluble in water, and amorphous. They have high molecular weights. Cellulose, the most important constituent in plant residue, is insoluble in water. It is frequently associated with hemicellulose and lignin, is semicrystalline in nature, and has a molecular weight between 200,000 and 2 million. Plant starches and animal glycogens are other important examples of polysaccharides. In water they exhibit *imbibition* or become dispersed, but they are not strictly soluble. Soil polysaccharides may be different from the original plant polysaccharides. These compounds can also be produced by microorganisms, and it has been suggested that polysaccharides in soils are a recombination of monomeric units derived from plants and microbial polysaccharides (Stevenson, 1994). As indicated earlier, these soil recombinants are more highly branched and, consequently, more complex in structure than the plant polysaccharides. The soil polysaccharides are subject to decomposition by microbial attack, because they are still valuable sources of food and energy. Enzymatic attack involves transformation through *glycosyl transfer*. Two broad types of enzymes have been reported: *endo-* and *exoenzymes*. The endoenzymes affect the catalytic cleavage of the *glucosidic bonds*, whereas the exoenzymes induce the cleavage of terminal residues. The greater the different types of linkages and the greater the branching of the polysaccharide structure, the greater will be the resistance to enzymatic degradation of soil polysaccharides. This resistance is perhaps why these compounds can accumulate in soils, although the amounts rarely account for more than 20% in the soil.

Soil polysaccharides can also be protected against degradation by interaction with soil constituents, such as clay and metal cations. The intimate association with soil clays has been reported to slow chemical degradation, whereas adsorption of polysaccharides, especially by expanding clays (e.g., montmorillonite or smectite) (Olness and Clapp, 1973, 1975) in intermicellar spaces, renders them inaccessible to enzymatic or to other microbial attack. Evidence has also been presented that complex reaction with metal cations (e.g., Al, Cu, Fe, Mn, and Zn) may inhibit enzymatic decomposition of soil polysaccharides (Martin et al., 1966).

### 5.4.2 THE EFFECT OF CARBOHYDRATES ON SOIL PROPERTIES

Carbohydrates influence soil physical conditions, chemical conditions, carbon metabolism, biological activity, and complex reactions of metals. From the standpoint of soil physics, mention has been made in the literature that interaction of soil polysaccharides with soil particles encourages soil aggregation, with the consequent formation of granular to crumb structures (Baver, 1963; Greenland et al., 1961, 1962). Baver (1963) also indicated that the oxidative destruction of soil polysaccharides resulted in a 30% to 90% reduction of stability of soil aggregates. This stabilizing effect on soil structure is attributed to an increase in cementing effect. By interaction with soil clays, the polysaccharide is thought to change the properties of the clay surfaces with respect to adsorption of water. The organic compounds compete with water molecules for adsorption sites, and by replacing the adsorbed water, they reduce wetting and swelling, thereby increasing cementation. The stabilization effect of soil aggregates by fungal mycelia, as frequently postulated by a number of authors, is considered a temporary effect by Baver (1963), because mycelia and cells die rapidly and undergo further microbial decomposition.

Chemically, carbohydrates, and especially polysaccharides, affect cation exchange reaction and complex formation with metal ions, which are attributed to their functional groups, such as hydroxyl, carbonyl, and carboxyl (COOH) groups in uronic acids. They also exhibit some anion exchange capacity, because several of the carbohydrates may also contain amino,  $\text{NH}_2$ , groups (e.g., amino sugars). Carbohydrates are important for the biological activity and microbial carbon metabolism in soils, because they are the main source of food and energy for microorganisms. Mineralization of amino sugars will enrich the soil with nitrogen compounds needed for plant growth. According to Stevenson (1994), some sugars may stimulate root elongation and seed germination. Sucrose is known to serve as a carbon source for the *asymbiotic propagation* of orchids from seed in tissue cultures (Tan, 1994). Soil polysaccharides also serve as building materials for the synthesis of humic compounds. They react with lignin and amino acids and, therefore, contribute toward the formation of humic acids and related compounds. However, carbohydrates are not considered an integral part of the humic molecule core, because they are attached as peripheral side chains. Fulvic acids are reported to be humo-polysaccharide esters (Tan and Clark, 1968; Tan and McCreery, 1970b). Aside from the beneficial effect, reports of harmful effects of soil polysaccharides have recently surfaced in the literature. The *acquired soil hydrophobicity* in golf greens is related to formation of polysaccharide coatings around sand grains, as discussed in more detail in Section 7.5.2, on water adsorbed by organic matter. This phenomenon is called *waterproofing* by Stevenson (1994). Stevenson (1994) is also of the opinion that production of microbial mucilage and gums, which are rich in polysaccharides, may cause clogging of soil pores, with the consequent reduction in soil permeability. Poorly drained soils, with anaerobic conditions, are especially prone to this harmful effect.

### 5.4.3 THE ISSUE OF CARBOHYDRATES IN SOIL HYDROPHOBICITY OR WATER REPELLENCY

*Soil hydrophobicity* or *water repellency* stated above needs to be addressed in somewhat more detail, because it seems not to be an isolated issue of polysaccharides on golf greens only. The symptoms manifested as *dry patches* can also be induced by wildfires or deliberate burning of forest or vegetative cover in agricultural operations. Oil spills may also create localized areas of water repellency in soils, and lately, fungi have been implicated to cause the characteristic dry patches, called *fairy rings* in forests, grasslands, and on golf greens (Farrar, 2002). This acquired water repellency in soils is an age-old problem that has only now attracted attention due to its occurrence in a wide range of agricultural as well as natural ecosystems (Ritsema and Dekker, 2003). The dry patches allegedly created serious problems in crop and pasture production over thousands of hectares in Australia and New Zealand. Similar dry patches caused by acquired soil water repellency were also noted to occur in noncultivated soils under natural stands of trees, shrubs, and grass, and are very serious, especially in the eucalyptus forests of Australia and South Africa. Such a widespread occurrence of hydrophobicity in soils has stimulated a lot of investigations in controlling the

problem. Wetting agents have been used as one of the remedial treatments. Drilling, wide furrow sowing, soil claying (adding clay to top soil), and application of fertilizers to stimulate microbial breakdown of water repellants are additional methods and have been tested in Australia and New Zealand with mixed results. Karnok et al. (1993) reported success with high-pH soil treatments in amelioration of soil hydrophobicity in golf greens.

#### 5.4.4 THE IMPORTANCE OF CARBOHYDRATES IN HUMAN NUTRITION

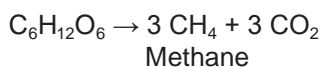
Carbohydrates are perhaps the most important constituents of plants. They belong to the three major groups of food substances, *carbohydrates*, *proteins*, and *oil*, that plants produce. In fact, carbohydrates are synthesized first by a process called *photosynthesis*, and the production of the other substances then begins. Accordingly, carbohydrates are the direct link between the radiant energy of the sun and the energy exhibited by living organisms. They are the principal foodstuffs and the most important sources of energy for animals and human beings. Much has been heralded today through the news media about the importance of complex carbohydrates in human nutrition and human health. Ascorbic acid, vitamin C, and inositol are related to carbohydrates (Gortner and Gortner, 1949).

##### 5.4.4.1 The Issue of the Glycemic Index

Issues about carbohydrates being unhealthy have also made headlines (Su, 2009). Nonetheless, the *Atkins diet* or *low-carb diet*, sensationalized by the U.S. media, faded away in 2005 after it made headlines. It appears that not all carbohydrates behave equally after consumption. Several will be digested rapidly, whereas other carbohydrates break down more slowly. The glycemic index (GI) is used to rank the carbohydrates on the basis of the different behavior in digestion. *High-GI carbs* are releasing glucose rapidly in our bloodstream, whereas *low-GI carbs* are breaking down more slowly and accordingly have little effect on blood glucose and insulin levels in our body. By definition, glucose is the reference material assigned a GI = 100. Other books use white bread as the reference with a GI = 100. High-GI carbs (GI ≥ 70) are suitable for recovery of energy after, for example, high-endurance exercise or for diabetic persons suffering from *hypoglycemia*. Among the low-GI carbs (GI ≤ 55) are listed pasta, whole grain bread, brown rice, fish, and eggs. Criticisms have been leveled that the glycemic index may differ substantially from person to person and that it may also be altered during preparation and cooking of food.

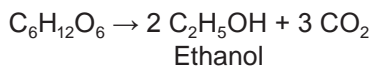
#### 5.4.5 CARBOHYDRATES FOR BIOFUEL PRODUCTION

Carbohydrates are renewable resources for raw materials in the pulp, paper, plastic, and rayon industries and, in addition, are used in the production of ethanol, butanol, glycerol, citric acid, acetic acid, and many other chemicals with the assistance of fermentation processes brought about by several microorganisms. In living plants, carbohydrates serve as a source of energy for many biological functions, and play an important role in the synthesis of nucleic acids, lignin, and other structural components in plant tissue. This will be discussed in other sections of the book. Sugars are the preferred source of materials and are subject to anaerobic and/or aerobic decomposition processes. In the aerobic process, the sugar is broken down completely into CO<sub>2</sub> and H<sub>2</sub>O. In the anaerobic microbial process, the sugar is broken down into methane, CH<sub>4</sub>, and CO<sub>2</sub>. The reaction is usually represented as follows:



A partial decomposition is also possible by microbial fermentation, resulting in the production of ethyl alcohol or methyl alcohol. This process can be illustrated with the following reaction:

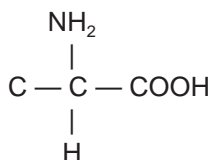




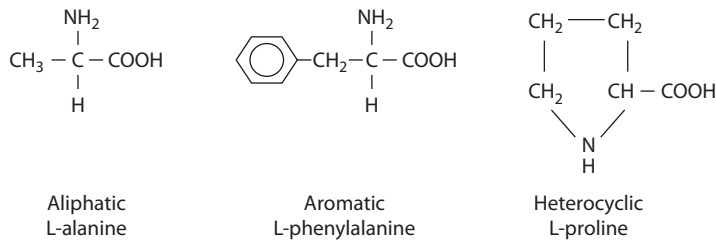
This reaction forms the basis for the production of alternative sources of fuel, called *biofuel*, today. In practice, sugars from sugar cane, or starches from corn and potato, ( $\text{C}_6\text{H}_{10}\text{O}_5$ )<sub>n</sub>, fermented with yeast, are the more common sources for the production of ethanol today. Most of the 1 billion gallons of ethanol produced annually in the United States are reported to come from corn, a very important crop in the midwestern and eastern states of the United States, grown originally for food and animal feed. Critics indicated that if most of the corn is taken away from food production for the production of ethanol, it may create havoc in the U.S. economy by raising the prices of food and animal feed. The prediction—that the use of corn for the production of ethanol exceeding 3 billion gallons per year may increase considerably the cost of food and animal feed—has now become a reality (Tan, 2009). Though selling corn for fuel production is a bonus to many corn farmers, gasoline prices increased in 2009 to \$0.66/L (= \$2.50/gallon) for an E10 blend sold at several gas stations in the United States. The price for nonblended gasoline was only \$0.44/L (= \$1.50/gallon) 2 years ago. Diverting corn and soybean from food to biofuel production has increased dramatically the prices of cooking oil, eggs, milk, and other food commodities, adding more burden to the pockets of ordinary folks already suffocating from high fuel prices. Major brands of U.S. cooking oil, like Wesson, Crisco, and Mazola, were selling in 2008 at \$3.50 per bottle of 3.75 L (= 40 fluid ounces) and in 2009 fluctuated at \$3.80 to \$4.00/bottle at major U.S. supermarkets, with a tendency to increase further. The rumor in the media is that one tankful of ethanol-gas equals the amount of corn useful for food for a whole year. Therefore, the search for other and cheaper sources of raw material for the production of ethanol has currently been intensified, and researchers are pursuing ways to harvest fuel from crops of U.S. farmlands that in the foreseeable future can power cars and airplanes and furnish energy to power stations cheaply. Carbohydrates from grasses and straw are viable alternatives, and rapidly growing bushes and trees can also be planted for the needed cellulose, as is done now for the paper, pulp, and rayon industry. The technology to squeeze out ethanol from hay, rice straw, wheat straw, and wood pulp would lower the cost of biofuel even more. The possibilities are unlimited, because all kinds of farm refuse (e.g., chaff, corncobs, stalk, and even brewery grain) are valuable sources of cellulose or carbohydrate that can be fermented to yield ethanol. In all cases, the production of methane and ethanol is always accompanied with a release of  $\text{CO}_2$ . The latter may cause some concern about decreasing the quality of the air in the atmosphere. However, in the presence of abundant plant growth, excess  $\text{CO}_2$  will be “filtered” from the atmosphere through absorption by green plants that use it again in photosynthesis for the production of carbohydrates.

## 5.5 AMINO ACIDS, PEPTIDES, AND PROTEINS

Amino acids are the fundamental structural units of peptides and proteins (Hughes, 2009). The nitrogen in amino acids occurs as an amino ( $\text{NH}_2$ ) group attached to the C chain. The acid part consists of a terminal C linked to an O atom and an OH group, often written as  $-\text{COOH}$ . The latter, called a *carboxyl group*, exhibits acidic properties, because the H in the OH radical can be dissociated, making the remaining radical capable of reacting with bases. The general formula of amino acids may be written as:



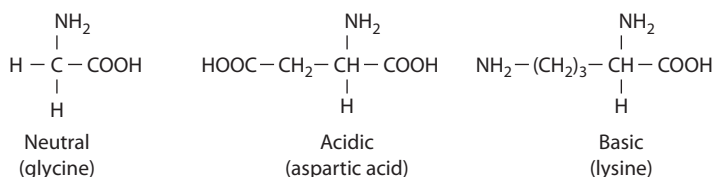




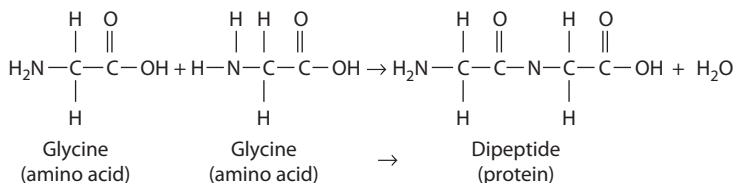
**FIGURE 5.3** Structural formulas of aliphatic, aromatic, and heterocyclic amino acids.

Because the amino group is on the carbon adjacent to the carboxyl group (the  $\alpha$ -carbon), amino acids with this general formula are called  $\alpha$ -amino acids. The amino acids obtained by hydrolysis of proteins are  $\alpha$ -amino acids and can be classified into (1) aliphatic, (2) aromatic, and (3) heterocyclic amino acids. Examples of each of these groups are shown in Figure 5.3. In addition to the division into three groups, amino acids from protein are also distinguished into *neutral*, *acidic*, and *basic* amino acids. Neutral amino acids are characterized by one  $\text{NH}_2$  and one  $\text{COOH}$  group in their structure, whereas the acidic types of amino acids have two  $\text{COOH}$  groups versus one  $\text{NH}_2$  group in their molecule. On the other hand, basic amino acids possess more than one  $\text{NH}_2$  group versus one  $\text{COOH}$  group in their structure, as illustrated in Figure 5.4. The neutral types of amino acids appear to be present in equally dominating amounts in soils of the temperate and tropical regions (Stevenson, 1994). However, conflicting information was presented concerning the distribution of acid and basic amino acids in soils. A number of scientists reported that the concentrations of basic amino acids are higher than those of acid amino acids in soils of the subtropical and tropical regions. On the other hand, many other scientists believe that acid amino acids are the prevalent types found in tropical and subtropical soils (Paul and Clark, 1989; Sowden et al., 1977). The very difficult nature of extraction procedures yielding poor recovery of amino acids was presented as the reason for such a disagreement. However, a better reason will be provided in the next section of this chapter on colloidal chemistry of amino acids. These types of amino acids are also important structural constituents of humic compounds. Humic acids tend to be higher in neutral and basic amino acids, whereas fulvic acids contain more of the acidic type of amino acids (Stevenson, 1994).

Proteins are complex combinations of amino acids. Under refluxing with 6 *N* HCl for 18 to 24 hr, the protein may be hydrolyzed into its constituent amino acids. Twenty-one amino acids are usually found as protein constituents, but in soils many other types of amino acids have been detected which do not belong to proteins (Stevenson, 1994). The protein is formed by the linkage of amino acid molecules through the amino and carboxyl groups (Figure 5.5). When only a small or short polymer is produced, the substance is called by convention a *peptide*, but when lots of amino acids are linked together to form a long or big polymer, or *polypeptide*, it is called a *protein*. However, the use of the terms *peptide* and *protein* remains inconsistent. Insulin—a short polypeptide—is classified as a protein, whereas amyloid  $\beta$ -peptide, the suspected cause of Alzheimer's disease—a very long or large polypeptide—is confusingly called a *peptide* (Sewald and Jakube, 2009). Because the N content of most proteins is about 16% and this element is easily analyzed as  $\text{NH}_3$  by the Kjeldahl



**FIGURE 5.4** Examples of neutral, acidic, and basic amino acids.

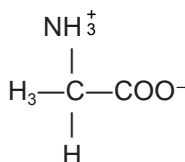


**FIGURE 5.5** The reaction between two amino acids to form a dipeptide. The bond linking the amino acids together is called a peptide bond.

procedure, the protein content can be estimated by determining the N content and multiplying %N by 6.25 (100/16).

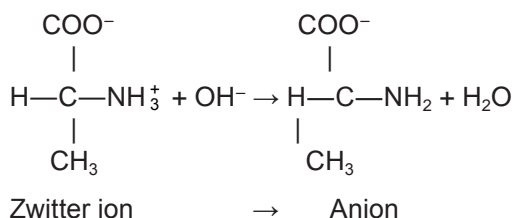
### 5.5.1 THE COLLOIDAL CHEMISTRY OF AMINO ACIDS

The amino acids, with certain exceptions, are generally soluble in water and are insoluble in non-polar organic solvents such as ether, chloroform, and acetone. Because amino acids contain both a carboxyl and an amino group, these compounds will react with bases and acids. Such compounds are said to be *amphoteric*. If, for example, alanine is dissolved in H<sub>2</sub>O, the pH is 7. If electrodes are placed in the solution and a potential difference is placed across the electrodes, the amino acid will not migrate in the electrical field. It is as if the amino acid molecule is neutral. However, when alkali is added to the solution, alanine becomes negatively charged and migrates to the positive anode. Similarly, when acid is added, alanine becomes positively charged and migrates to the negative cathode. This behavior can be explained by considering alanine a *zwitter ion*, a name originally introduced by Bjerrum (1923) for amphoteric molecules carrying both positive and negative charges (Patrick, 2004):

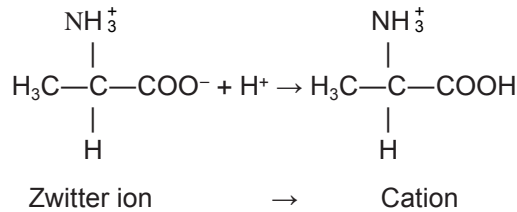


Zwitter ion (double-charged ion or dipolar ion)

The presence of equal amounts of positive and negative charges, causing the molecule to behave neutral, can occur only at the *isoelectric point pH*, often designated as *pI*. As noted above, at pH (= pI) 7, the amino group is protonated, causing it to be positively charged. When alkali is added, the excess proton on the amino group is neutralized ( $\text{pK}_a = 9.7$ ), and the zwitter ion is transformed into an anion. This explains its migration to the anode. The transformation reaction can be illustrated as follows:



When acid is added, the dissociated carboxyl group accepts the proton, and the zwitter ion is converted into a cation that migrates to the cathode. The transformation process can be illustrated by the following reaction:



At a pH of 2.3, the carboxyl group is half protonated. It then follows that in acid soils, most of the amino acids will be present as positively charged compounds (cations) and will be attracted by clays and organic anions. On the other hand, in basic soils, the amino acids will behave as anions, and hence can undergo reactions with metal cations and organic cations. These reactions with clay and metal ions contribute toward accumulation of amino acids in soils. Similar reactions can also occur between the different types of amino acids and other soil colloids. Basic amino acids with more than one positively charged amino group interact more readily with negatively charged soil inorganic and organic colloids (clay and reducing sugars and quinones) than do the neutral and acid amino acids. In contrast, acid amino acids with more than one negatively charged carboxyl group will then be very active in complex reactions with metal ions and positively charged organic colloids than the neutral and basic amino acids. Oxisols and Ultisols in tropical and subtropical regions are known to be acid soils; hence, their amino acids are most likely positively charged and will undergo interactions with negatively charged clays and organics only. Of the three types of amino acids, the basic types, with more than one positively charged amino group as indicated above, will be the most effective. These soils are also characterized by high contents of Al, Fe, and Mn, and by a clay fraction dominated by gibbsite or goethite. However, because of their positive charges, neither one of these metals or clay minerals is expected to react extensively with basic, acid, or neutral amino acids, unless the soils are limed to higher pH values. On the other hand, Mollisols and Aridisols in the temperate regions are more neutral to slightly basic in reaction and contain high amounts of Ca or Na. Their clay fractions usually include high amounts of negatively charged 2:1 clay minerals. Here, the three types of amino acids will be negatively charged, and, therefore, will not be able to interact with clays, but will react with Ca ions. However, in these soils, the acidic amino acids, with more than one negatively charged carboxyl group, will be more effective in reacting with Ca and Na ions than the basic or neutral amino acids. These then are in the author's opinion the reasons for the high content of basic amino acids in tropical and subtropical region soils, as postulated by Stevenson (1994). In these soils, the basic amino acids are accumulated because of their interaction with clays. The chemical principles discussed above prohibit the accumulation of acidic amino acids in the soils of the tropics, and scientifically cannot confirm the data summarized by Sowden et al. (1977). Instead, the chemical conditions created by the zwitter ion reactions are conducive for accumulation of acidic amino acids only in the Mollisols and Aridisols of the temperate region by precipitation after their reaction with Ca ions.

### 5.5.2 THE ISSUE OF AMINO ACIDS IN HUMAN HEALTH

Amino acids and protein are popular nutritional supplements taken especially by athletes for enhanced performances. Some amino acids and peptides are also applied in alternative and preventive medicine, because they are believed capable of acting, for example, as *neurotransmitters* in the brain. As such, they will affect our mental health and are especially noted to be beneficial against Parkinson's disease and the like (Pies and Rogers, 2005; Stephenson and Turner, 1997).

The *anabolic effect* of diets high in amino acids, however, has attracted a great deal more public and media attention. A variety of amino acids and protein supplements can be seen offered across the nation by many health stores in the United States. Many paperbacks have also been published exalting the value of additional protein or amino acids, suggested to be taken especially by athletes in intensive training exercises (Di Pasquale, 2007). It is the subject of many discussions and controversies. Many believe that a protein diet, often combined with carbohydrates, affects exercise-induced hormone responses leading to increased skeletal muscle mass (Volk and Forsythe, 2006). However, an older review in *Sportscience* (Kreider, 1999) indicated that concrete evidence is absent for enhancing athletic performance.

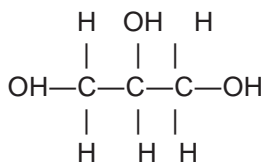
## 5.6 LIPIDS

Lipids are heterogeneous compounds of fatty acids, waxes, and oils. The term *lipid* does not imply a particular chemical structure, as with amino acids. The name is used to describe substances that are soluble in fat solvents such as ether, chloroform, or benzene. Lipids are usually classified into three groups:

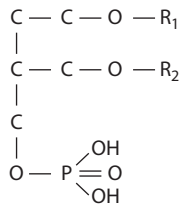
1. *Simple lipids*—These include neutral lipids, fats, oils, and waxes.
2. *Compound lipids*—Phosphatides, glycolipids, sulfolipids, and terpenoid lipids, including carotenoids, belong to this group.
3. *Derived lipids*—These are lipids derived from hydrolysis of simple and compound lipids. They include fatty acids, alcohols, sterols, and cholesterol.

The fatty acids can be unsaturated fatty acids (e.g., oleic acids,  $C_{18}H_{34}O_2$ ) and saturated fatty acids (e.g., palmitic acid,  $C_{16}H_{32}O_2$ ). Palm oil, or coconut oil, is rich in palmitic acids. Cholesterol is an example of a sterol, which upon ultraviolet (UV) radiation will form vitamin D. In 2005, lipids were reclassified into eight categories, each divided again into classes and subclasses. The eight categories are fatty acyls (generic for fatty acids), glycerolipids, glycerophospholipids, sphingolipids, sterol lipids, prenol lipids, saccharolipids, and polyketides (Fahy et al., 2005). *Glycerolipids* are derived from glycerol, whereas the *glycerophospholipids* are the phospholipids of the past. Sphingolipids contain *sphingosine* (Greek *sphingos* or *sphinx*), an unsaturated amino alcohol,  $C_{18}H_{37}NO_2$ , found in nerve and brain tissue. *Sterol lipids* are the group of lipids to which sterols are attached, including cholesterol. *Prenol lipids* have *isoprenoid* substances, such as terpenes, quinones, hydroquinones, and carotenoids, known as antioxidants and as the precursor of vitamin A. *Saccharolipids* contain monosaccharides, and a most familiar one today is *glucosamine*. *Polyketides* are a group of lipids containing acetyl and propionyl polymer units. They are often applied as anticancer and antiparasitic agents.

The basic component of lipids is glycerol,  $C_3H_8O_3$ , or other alcohols. Glycerol is a trihydroxy alcohol with the following structure:



Hydrolysis of fats, by saponification with alkalis, yields glycerol and the salts of fatty acids. The metallic salts of the higher fatty acids are known as soap. Neutral lipids are esters of fatty acids and glycerol, and are composed of one molecule of glycerol and three molecules of fatty acids. They are liquid at room temperature. Waxes are esters of fatty acids and other alcohols. Phosphatides contain



**FIGURE 5.6** A simplified structure of a phosphatide.

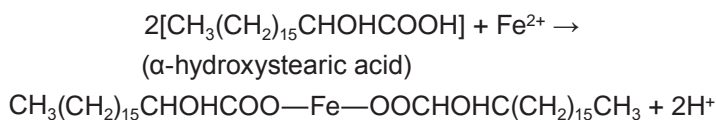
P, and upon hydrolysis will yield glycerol. Lecithin is a phosphatide. The P-containing lipids are also called *phospholipids*. The molecular structure of phosphatides is shown in Figure 5.6.

Lipids have limited solubility in water and exhibit a hydrophobic character. Many of the lipids in plants and animals are associated with proteins and carbohydrates (e.g., glycolipids, today called saccharolipids). Membrane lipids are amphiphilic because of the presence of hydrophobic and hydrophilic groups in the same molecule.

### 5.6.1 COLLOIDAL CHEMISTRY AND THE IMPORTANCE OF LIPIDS IN SOILS

Accumulation of lipids varies considerably from soils to soils, with the highest concentrations observed in the humus fraction of Spodosols, and the lowest in Mollisols. As is the case with amino acids, some of the soil lipids find their origin from higher plants, but many have also been derived from microbial tissue. Bacterial cells contain 5% to 10% lipids, whereas fungi may contain 10% to 25% (Stevenson, 1994). These microbial products are the main sources of the glycerides and phosphatides in soil lipids. Waxes, covering leaves and fruits of higher plants, are also important sources of soil lipids, whereas terpenoids are contributed by conifer plants. Leaves of green plants are important sources of chlorophyll. Resistance to decomposition may also vary considerably. Many of the lipids will decompose rapidly in well-drained soils, such as fatty acids, whereas others are relatively resistant, like the waxes, terpenoids, and sterols. However, it is generally assumed that in most soils sufficient amounts of microorganisms are present for a complete decomposition of even the strongest lipid. Soil microorganisms are even available that can attack oil spills, which are lipid-like compounds.

Lipids are known to affect physical properties of soils, but not much information is present on this topic. These compounds are hydrophobic in nature, and, therefore, will reduce the degree of wetting of soils. A high content of wax in soil humus is expected to make the soil *water repellent*, but no data are available to confirm this scientifically. Induced hydrophobicity in golf greens was discussed in the previous section as the harmful effect of formation of polysaccharide coatings around sand grains. Relatively more is known of the chemical properties of some of the soil lipids. Many of the high molecular weight organic acids in the lipid group contain hydroxyl and carboxyl groups (e.g., palmitic acid and stearic acid). Organic acids of these kinds can also be present in small quantities in the soil rhizosphere. Depending upon soil pH, their functional groups (OH and COOH) can dissociate the H<sup>+</sup> ions; hence, the compounds can contribute toward cation exchange reaction, complex formation, or chelation reactions with metal cations, as follows:



These *lipoidic acids* are, therefore, important agents in the weathering of rocks and minerals, in the dissolution of plant nutrients, and in the mobilization and transportation of elements critical in plant nutrition and soil formation (Tan, 1986). Some of the lipids are harmful to plant growth, and

others may induce a growth hormonal effect. A high concentration of stearic acid is reported to be toxic to many crops and has been implicated in causing *soil fatigue* or low productivity of *worn-out* soils (Stevenson, 1994). Vitamin B and phytochelates related to lipids are known to stimulate plant growth, whereas phosphatides are potential P sources in soils.

### 5.6.2 THE SIGNIFICANCE OF FATTY ACIDS IN HUMAN HEALTH

Aside from the harmful effect of cholesterol, several of the fatty acids appear to be essential in human nutrition (Chow, 2007). Linoleic acid, an omega fatty acid, in safflower oil, sunflower oil, and soybean and corn oils, is known to provide positive benefits in cardiovascular diseases. Green leaves, seeds, canola, and walnuts and other types of nuts are rich in  $\alpha$ -linoleic acids. Fish oil contains omega-3 fatty acids or, as scientifically called, *icosapentaenoic acid* (EPA), a well-known agent in the prevention of heart disease. Finally worth mentioning is a saccharolipid, which is a *precursor of glucosamine*, a substance used as a popular—but scientifically unsupported—over-the-counter health supplement for the treatment of arthritic joint ailments.

## 5.7 NUCLEIC ACIDS

Each plant and animal cell contains a discrete rounded or spherical body, called the *nucleus*, which contains nucleic acids. *Nucleic acids*, first isolated in 1869 by F. Miescher, are polymers with high molecular weights (Rapley, 2000). Their repeating unit is a mononucleotide, rather than an amino acid. Nucleic acids control the synthesis of enzymes and proteins and are also responsible for the genetic transfer in cell division. Two types of nucleic acids are generally recognized: (1) *deoxyribonucleic acid* (DNA), a constituent of cell nuclei; and (2) *ribonucleic acid* (RNA), located in the nucleolus and in the cytoplasmic nuclear membrane, called endoplasmic reticulum. Both DNA and RNA consist of long chains of alternating sugar and phosphate residues. In RNA, the sugar is d-ribose. The sugar in DNA, as the name implies, is 2-deoxyribose (Figure 5.7). In most cells, these nucleic acids are conjugated with proteins to form nucleoproteins. Nucleoproteins containing DNA, a major component of chromosomes, determine genetic heredity. On the other hand, nucleoproteins containing RNA, known as *ribosomes*, are important in protein synthesis. Three groups of ribosomal RNA are identified: (1) rRNA (ribosomal RNA), which is the predominant group, amounting frequently to 80% of the total RNA content; (2) soluble RNA (sRNA), sometimes also called transfer RNA (tRNA); and (3) messenger RNA (mRNA), which usually occurs in low concentration. Soluble RNA carries amino acids to their specific sites on the protein template and, therefore, is considered an amino acid carrier or amino acid adaptor, whereas mRNA acts as the messenger of DNA. During the formation of protein, mRNA directs the linkage of amino acids with tRNA.

As the name implies, a nucleic acid is a component of the cell nucleus. However, it is now established that nucleic acids can also originate in other plant parts. It is common for the plant cell to contain a nucleus and several mitochondria and chloroplasts. Nucleic acids can also be produced by the latter two plant organelles. However, the largest percentage of nucleic acid is produced in the

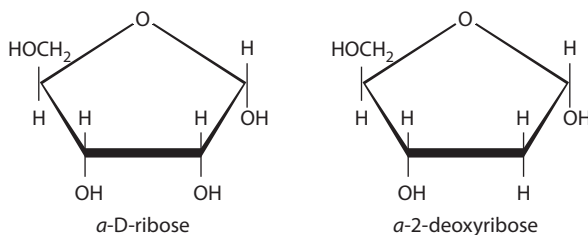


FIGURE 5.7 The sugars (d-ribose) in RNA and 2-deoxyribose in DNA.



nucleus, and only approximately 10% to 40% DNA and RNA are formed in the chloroplast, whereas 1% is formed in the mitochondria. These nucleic acids are not only smaller in size, but their genetic capability is less than those in the nucleus.

### 5.7.1 COLLOIDAL PROPERTIES AND THE IMPORTANCE OF NUCLEIC ACIDS IN SOIL

Not much is known about accumulation and reactions of nucleic acids in soils. This is one of the organic compounds from living cells which is apparently decomposed rapidly in soils. However, because nucleic acids contain N and P, they are expected to be important sources for soil N and P. Humus and especially humic substances contain a considerable amount of N that cannot be accounted for in analysis. This unaccounted N content, called HUN for hydrolyzable unknown nitrogen or just plain *unknown N*, is believed to be derived from nucleic acids or their derivatives (Schnitzer and Hindle, 1980; Stevenson, 1994).

#### 5.7.1.1 Cation Exchange Reactions of Nucleic Acids

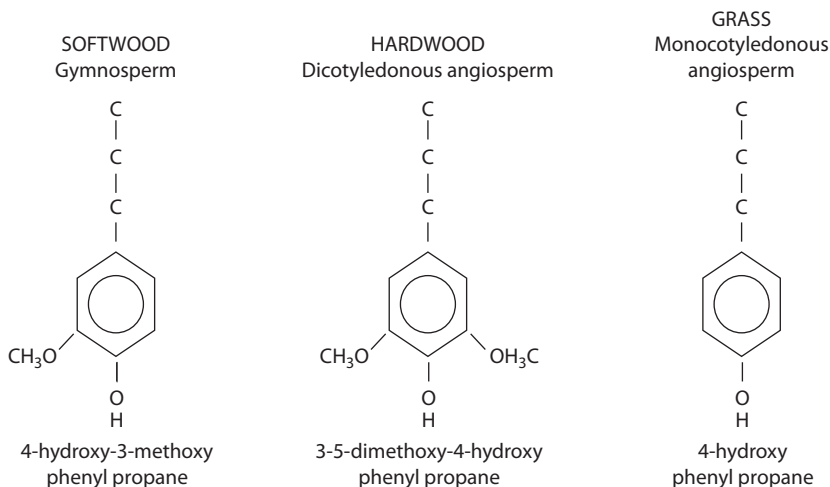
The presence of phosphates as essential constituents for linking the sugars together in the RNA and DNA strands has raised speculations for a possible role of nucleic acids in cation exchange reactions. It was recently reported in medical science that because of their polyanion nature, the phosphate groups in both RNA and DNA are capable of reacting with cations, such as  $Mg^{2+}$ , an interaction of utmost importance in medicine and disease control. These counterions are sequestered in a *diffusive cloud* around the polymeric DNA or RNA (Hud, 2008), which is perhaps equivalent to what we call the *double-layer counterion sphere* in soil science. If or when nucleic acid or part of it is available in soils, it may then contribute to the soil cation exchange reaction. The phosphate residue, linked to the OH of  $\alpha$ -2-deoxyribose (DNA) in the form of  $HPO_4^{2-}$ , is capable of attracting  $Ca^{2+}$ ,  $Mg^{2+}$ , and any other mono- or polyvalent cations. The adsorbed cations are usually interchangeable with other cations free in the soil. An example of such a sorption of a cation is as follows:



## 5.8 LIGNINS

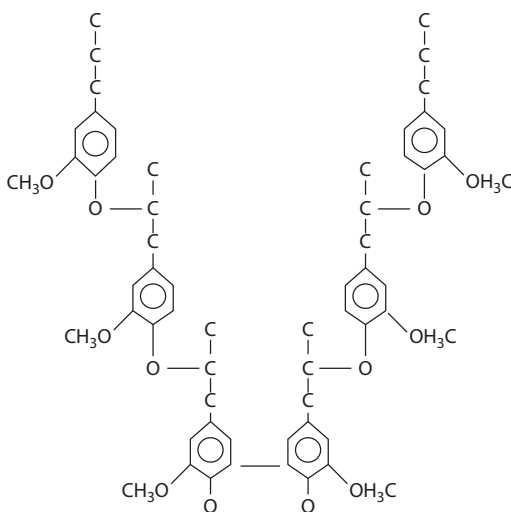
*Lignin* is considered, second to cellulose, the most abundant biopolymer in nature. It is a system of thermoplastic, highly aromatic compounds, derived from coniferyl alcohol or guaiacyl propane monomers (Hu, 2002; Heitner et al., 2009). Plant lignin can be divided into three types of basic monomers: (1) lignin from softwood; (2) lignin from hardwood; and (3) lignin from grasses, bamboo and palm, or grass lignin (Figure 5.8). The monomer of the softwood lignin, possessing one methoxyl ( $-OCH_3$ ) group, is known under the name of *coniferyl alcohol*, because of its dominant presence in coniferous (*gymnosperm*) wood. Polymerization of the coniferyl alcohol forms *guaiacyl polymers*; hence, several authors tend to name this type of lignin also *guaiacyl lignin* instead of *coniferyl lignin*. In contrast, the hardwood lignin monomer is characterized by two methoxyl groups in its molecule and is called *sinapyl alcohol*. Confusingly, however, several authors call this hardwood lignin *syringyl-guaiacyl lignin* (Rowell, 2005). In view of sinapyl alcohol as the basic unit, to avoid confusion the present author believes that it is better to call it *sinapyl lignin*. Moreover, syringic alcohol and syringic acid are reported not to exist in nature (Bland and Logan, 1965). The bamboo-grass (gramineae) lignin is composed of predominantly methoxyl-free basic units, called in basic organic chemistry *coumaryl alcohols*. Coumarylated units have been detected as major constituents in bamboo and maize lignin (Lu and Ralph, 1999). Therefore, the present author proposes the name *coumaryl lignin* for the bamboo-grass group. At one time, this type of lignin was also found in *moss lignin* (Bland and Logan, 1965).



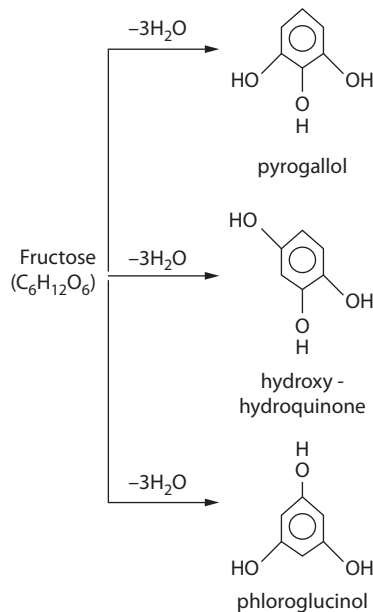


**FIGURE 5.8** Chemical structures of building constituents of lignin from softwood, hardwood, and grass.

These three basic monomers form large, complex polymeric molecules, and it is common to find a haphazard structure of lignin in many organic chemistry books. The consensus is that lignin has no simple structural units as do, for example, cellulose and protein. In addition, the extreme difficulties in breaking the carbon linkages in the polymers have made it impossible to isolate all parts of lignin from the plants without change. The *Björckman method* yields lignin with minimal chemical changes, but the yields are reported to be only 50% of the *Klasons procedure*. However, the latter produces the most chemical and structural changes in its isolates (Rowell, 2005; Sakakibara, 1980). A hypothesis is presented here to show that a systematic arrangement of the basic monomers into lignin is possible. Many of the C atoms are connected to the OH radicals (phenolic hydroxyl groups) in which the behavior of the H is much the same as that in the carboxyl groups of organic acids. An example of a systematic linkage of softwood lignin monomers to form polymeric lignin is shown in Figure 5.9. Such a combination can also take place with the other types of monomers, whereas the linkages can continue in many directions.



**FIGURE 5.9** Author's hypothesis of a simplified chemical structure of softwood lignin by linkage of coniferyl alcohol monomers. Such a systematic combination is endless.



**FIGURE 5.10** Aromatization of carbohydrates (fructose) through a dehydration ( $-3H_2O$ ) process.

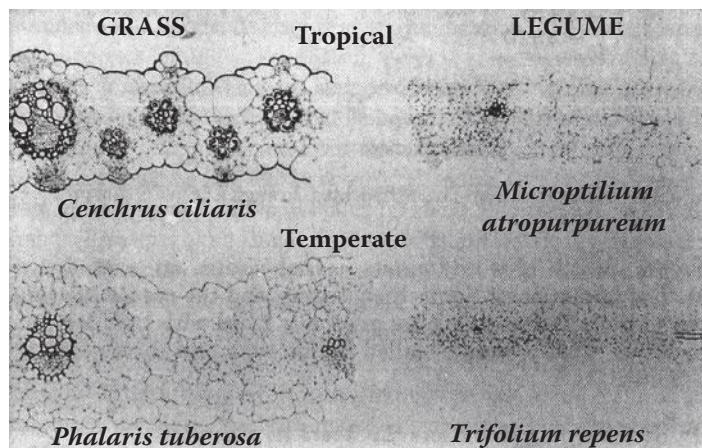
The ultimate source for formation of lignin is carbohydrates or intermediate products of photosynthesis related to carbohydrates. The process of conversion of the nonaromatic carbohydrates into substances containing phenolic groups characteristic of lignin is called *aromatization*. The end products of the aromatization process are pyrogallol, hydroxyhydroquinone, phloroglucinol, or a combination thereof (Figure 5.10). In the growth of woody plants, carbohydrates are synthesized first. The formation of lignin then begins, and the spaces existing between the cellulose fibers are gradually filled with lignified carbohydrates. This process is called *lignification* and it serves several functions:

1. It cements and anchors the fibers together.
2. It increases the resistance of the fibers against physical and chemical breakdown.
3. It increases rigidity and strength of cell walls.

It is believed that after lignification, the lignified tissue then no longer plays an active role in the life of plants, but serves only as a supporting structure. Nonlignified plant parts contain more moisture, are soft, and break more easily.

### 5.8.1 COLLOIDAL CHEMISTRY AND THE IMPORTANCE OF LIGNINS IN SOIL

The bulk of lignin occurs in the secondary cell walls where it is associated with cellulose and hemicellulose in stems. The quantity of lignin increases with plant age and stem content. It is a very important constituent of woody tissue, and it contains the major portion of the methoxyl content of the wood. A large amount of lignin is also detected in the vascular bundles of plant tissue. The purpose is perhaps to strengthen and make the xylem vessels more water resistant. By virtue of the presence of larger amounts of vascular bundles, the lignin content of tropical grasses is considerably larger than that of temperate region grasses (Figure 5.11). Consequently, soils under tropical grasses are expected to have higher lignin contents than soils under temperate region grasses. These differences may have some influence on the nature of humic matter formed.



**FIGURE 5.11** Micrograph of leaf thin sections from tropical and temperate region plants showing different amounts of lignified vascular bundles. Characteristic coloration of lignin was developed by treatment with phenol. *Cenchrus ciliaris* = sandbun grass; *Phalaris tuberosa* = canary, Harding, or Toowoomba grass; *Microptilium atropurpureum* = siratro twining legume; *Trifolium repens* = white clover. (Adapted from Minson, D. J., and J. R. Wilson, *J. Austr. Inst. Agric. Sci.*, 46, 247, 1980. Courtesy of *J. Austr. Inst. Agri. Sci.*)

Lignin is insoluble in water, in most organic solvents, and in strong sulfuric acid. It has a characteristic UV absorption spectrum and gives characteristic color reactions upon staining with phenols and aromatic amines. It hydrolyzes into simple products, as do the complex carbohydrates and proteins. When oxidized with alkaline benzene, it yields up to 25% vanillin. Lignin is considered an important source for the formation of soil humus, and especially humic matter. The high resistance of lignin to microbial decomposition is perhaps the reason why it accumulates in soil. It is believed that, depending upon the conditions, this could result in the formation of peat, which in time can be converted into lignite, coal, and ultimately oil (fossil fuel) deposits. Nevertheless, lignin can be attacked by special microorganisms. Several forms of *lignolytic fungi* have been reported as the major organisms responsible for the partial decomposition of lignin (e.g., white-rot, brown-rot, and soft-rot fungi) (Kim, 2008; Paul and Clark, 1989). In well-aerated soils, the *white-rot fungi* are reported to be capable of decomposing wood containing lignin into  $\text{CO}_2$  and  $\text{H}_2\text{O}$ . On the other hand, the *brown-rot fungi* are useful for the removal of the methoxyl,  $-\text{OCH}_3$ , group from lignin, leaving the hydroxyphenols behind which upon oxidation in the air produce brown colors. The *soft-rot fungi* are most active in wet soils and are specifically adapted to decomposing hardwood lignin. The hydroxyphenol units resulting from demethylation of lignin by white-rot fungi can be oxidized to form quinones, which are capable of reacting with amino acids to form humic substances (Flaig et al., 1975).

### 5.8.2 THE SIGNIFICANCE OF LIGNINS IN INDUSTRY AND PHARMACOLOGY

Lignin has the capacity to react with  $\text{NH}_3$ . This process, called *ammonia fixation*, has been applied in industry for the production of nitrogen fertilizers by treatment of lignin and other materials rich in lignin (e.g., peat, sawdust) with  $\text{NH}_3$  gas. The exact mechanism of fixation is still not known, but it is believed that the  $\text{NH}_3$  reacts with the phenolic functional groups in lignin. It was reported that the paper and pulp industry produces approximately 45 metric tons of lignin annually as a by-product. This huge amount of lignin is used internally as a low-grade fuel for the pulp factory to operate. The pulp, still rich in lignin, is usually applied in the production of short-life paper products, such as paper for newspapers and telephone directories. Where forest resources are less abundant, straw

and bamboo have been used for centuries for the production of paper (Hu, 2002). Finally, lignin has been reported to be beneficial in human health. Bamboo lignin is allegedly capable of suppressing *apoptosis* induced by oxidative stress in humans. It is reportedly also a very potent *neuroprotective agent* because of its antioxidant reaction. However, lignin should not be confused with *lignan* (Heitner et al., 2009). Lignan is a *phytoestrogen-like* compound found in flax and sesame seeds and can also act as an antioxidant. It is also found in rye, wheat, oats, barley, soybean, broccoli, brassica vegetables, pumpkin seeds, and red wine.

## 5.9 HUMIC MATTER

### 5.9.1 THE OLD AND NEW LOOK OF HUMIC MATTER

The concept of humic matter has changed rapidly from the traditional ideas loaded with skepticisms of the 1970s to the 1980s. Two important changes can be noticed: (1) a drastic reversal from the operational concept of humic substances and (2) the emergence of a new pseudomicelle and supramolecular association concept, spearheaded by Piccolo (2002) opposing the traditional polymer theory of humic matter (Von Wandruszka et al., 1999; Wershaw, 1992, 1999). Whether these changes have improved and advanced the science of humic matter to a higher level is up to future development. Many people admit that more research providing more concrete evidence is needed to replace the old for the new look of the science of humic substances (Sutton and Sposito, 2005).

#### 5.9.1.1 The Issue of the Operational Concept of Humic Substances

The older, traditional, idea suggests that humic substances were created in the laboratory by extraction. At that time, many believed that humic acid, fulvic acid, and the like were “operational substances” only. The names are used to indicate their solubility in base and acid systems (Aiken et al., 1985). However, because of their abundance and ubiquitous nature in terrestrial and aquatic ecosystems, supported by the increase of compelling evidence accumulated during the years of research, many scientists feel a need now to review the operational definition (Hayes and Clapp, 2001). In this respect, the International Humic Substances Society (IHSS), founded in Denver, Colorado, on September 11, 1981, has contributed tremendously toward the recognition of humic matter as natural substances in nature through its activities in increasing public awareness on humic substances. Changing its original operational concept, the IHSS’s official statement in 2009 is that “humic substances are major components of natural organic matter (NOM) in soil and water as well as in geological organic deposits” (<http://ihss.gatech.edu/ihss2/whatarehs.html>, accessed June 9, 2009). Today, most of the prominent scientists have accepted the idea of humic and fulvic acids as natural compounds (Bogoslovskiy and Levinskiy, 2006; Ghabbour and Davies, 2005; Huang et al., 2005; Piccolo, 2002; Steinberg, 2003), and only the “diehards” are clinging toward the traditional concept of them being operationally defined (Qualls et al., 2003).

As it stands now, soil organic matter (SOM) is divided into decomposed and dead nondecomposed organic fractions, or litter. The decomposed fraction is subdivided again into nonhumified and humified materials. The nonhumified substances are the compounds derived from the decomposition of plants and other organisms with definite characteristics, as discussed previously (e.g., carbohydrates, amino acids, proteins, lipids, nucleic acids, and lignins). These compounds are usually subject to further degradation and decomposition reactions. But sometimes they can be adsorbed by inorganic soil components, such as clay, or they may occur in anaerobic conditions. Under such conditions, the foregoing compounds will be relatively protected against decomposition. The *humified* fraction is known currently as *humic compounds* or *humic matter*. It is a new product in soils, synthesized during the decomposition of plant and animal residue with or without the assistance of microorganisms. Like clay, humic substances are building constituents of soils. The process of formation of humic substances is called *humification*.

The term *humic acid* originated with Berzelius in 1830, who classified the soil humic fraction into (1) humic acid, the fraction soluble in bases; (2) crenic and apocrenic acids, the fraction soluble in water; and (3) humin, the insoluble and inert part. Humic acid was also referred to as ulmic acid, whereas humin was also called ulmin by Mulder in 1840. It was Oden in 1912 who first proposed the use of the name *fulvic acid*, replacing the terms *crenic* and *apocrenic acids*, and not Carl Sprengel as stated in some publications. In the German and Russian literature, humic acid, fulvic acid, and other humic fractions are collectively called *humus acid* (Orlov, 1985; Scharpenseel, 1966). Most of the terms above have not been changed and are still in use today.

### 5.9.1.2 The Emergence of the Supramolecular Association Concept

Failure to find an accepted molecular structure for humic substances was perhaps the reason for attempts to turn humic acid science from a polymer into a supramolecular concept (Piccolo, 2002). At first glance, it looks like a novel idea, but the theory of supramolecules, started with van der Waals in 1873 and established as a science by Herman Emil Fisher in 1890, is perhaps as old as the polymer theory. Supramolecular chemistry has played a fundamental role in probing the structural issue of protein, which in a sense shows some similarities with the problems of humic acids, as indicated several times by the current author (Tan, 2003). Invoking the concept of supramolecular chemistry, including molecular self-assembly, hydrogen bonding, electrostatic and hydrophobic and van der Waals forces,  $\pi$ - $\pi$  interactions, and metal coordination (Lehn, 1995), solely on the basis of deduction is very risky without proper testing and investigation with humic substances. It has taken many scientists by surprise.

Today, *humic compounds* are unfortunately still defined as amorphous, colloidal polydispersed substances with yellow to brown–black color. They are hydrophilic, acidic, and high in molecular weight, ranging from several hundreds to thousands of atomic units. As explained in Section 5.1, colloidal sizes can be expressed in terms of mass units or daltons (Da) and molecular weights or in terms of linear dimensions ( $\mu\text{m}$  or  $\text{nm}$ ) used in electron microscopy. The choice depends on the authors' preference, and no precise statistical conversion of size from linear to mass units is available. By comparing with known compounds (standards) in x-ray scattering analyses, Thurman et al. (1982) found a radius varying from 4.7 to  $33\text{\AA}$  (0.47 to 3.3 nm) for aquatic humic substances that corresponded to a molecular weight range of approximately 500 to 10,000 or larger. Steinberg (2003) modified Thurman's data above and presented a more detailed correlation between diameter and mass of aquatic humic compounds. In his opinion, fulvic acid—the smallest of the humic compounds—has a diameter of  $10^{-9}$  m which corresponds to a molecular weight of  $10^3$ . Humic acid has a diameter varying between  $10^{-9}$  and  $10^{-8}$  m, which corresponds to a molecular weight of 10,000 and slightly larger. Humin is reported to be the largest in size with a diameter of approximately  $10^{-7}$  m which corresponds to a molecular weight of  $10^7$ . Using molecular weights for size differentiation, Bogoslovskiy and Levinskiy (2006) presented slightly different figures than the above. In their opinion, fulvic acids have molecular weights ranging from  $10^3$  to  $10^4$ , whereas those of humic acids are between  $10^4$  and  $10^5$  with humin exhibiting the largest molecular weights of  $10^7$ . However, Piccolo (2002) strongly opposes the concept of humic substances being high molecular weight polydisperse polymers. He quoted size ranges of humic substances from a great number of authors varying from 500 to 1,360,000 Da, a variation he believes too large for it to be possible for any of the values to be the characteristic mass or size of humic substances. This failure of finding and assigning a molecular weight to humic substances, as stated earlier, still confronts the science of humic substances in the new century.

In Piccolo's opinion, the literature data try to convey that humic substances are not high molecular weight polymers but are groups of small heterogeneous chemical substances of biological origin, held together by noncovalent weak dispersive forces, hydrophobic and hydrogen bonds. In the author's opinion, *water and metal bridging* may also play equally important roles in keeping the assemblages together. In essence, a water bridge works like a hydrogen bond and is more common

in soils as most scientists would expect. The principles of these forces of attraction will be discussed in more detail in Chapter 12.

In aqueous ecosystems, such assemblages tend to organize into micellar structures as proposed earlier by Wershaw (1992, 1999) and von Wandruszka et al. (1999). Wershaw (1993) shows his *membrane-micelle humus model* to form coatings only on positively charged surfaces of sesquioxides. However, the current author believes that these coatings can also form on negatively charged clay surfaces because of metal and water bridging. Water bridging is perhaps the most common mechanism of attraction most scientists seem to ignore or forget.

Therefore, to some scientists, a humic molecule is only a collection of small and diverse chemical compounds. Piccolo (2002) calls such an association of small molecules a *supramolecular association*, a concept quoted from elements of supramolecular chemistry (Lehn, 1995) without adequate testing. As indicated above, the issue is related to the theory of the *membrane-micelle humus concept* proposed earlier by Wershaw and von Wandruszka and coworkers. It was Wershaw who suspected that hydrophobic and hydrogen bonds were mainly responsible for the apparent stability of the “deceptively” large molecular sizes of humic compounds. In this respect, Conte et al. (2006) are of the opinion that the pH plays a definite role in holding together the aggregates of small heterogeneous molecules. At neutral soil reactions, van der Waals and dispersive forces are the most important, whereas at lower pHs, hydrogen bonds are believed to be the main forces. However, in contrast to the above, reports are also available in the literature on the relevance of esterification and cross-linkages of the organic bioesters during the formation of humic compounds (Fiorentino et al., 2006). But several people would have liked to exclude some specific biomolecular fractions from the humic molecule. Interesting as it sounds, many are awaiting more evidence to embrace wholly this new idea of Piccolo (Sutton and Sposito, 2005).

Awaiting future development, it appears that the polymerization concept and heterogeneous nature of humic substances (Felbeck, 1965) are the traditional concepts still followed today by a majority of humic scientists. They were the reasons why in the past the terms *humic* and *fulvic acids* were not considered by several U.S. soil and water experts to indicate definite compounds in nature. Nonetheless, several European scientists already believed at that time that the names humic and fulvic acids referred to identifiable high molecular weight organic compounds that are complex in structure (Flaig, 1975; Kononova, 1966; Orlov, 1985), but intermediate forms may be present between these two fractions. Stevenson (1994) is of the opinion that C and O contents, acidity, and degree of polymerization may change with increasing or decreasing molecular weight of humic acids. More recent evidence presented by Lobartini et al. (1997) also indicates that humic acids may possess a composition more homogeneous than previously expected. The elemental composition, infrared spectra, and electron micrographs show that their humic acid fractions, separated by molecular weights, contain essentially similar compounds. Based on solubility in acids and alkalis, the humic compounds are conventionally distinguished into several humic fractions:

Fractions	Alkali	Acid	Alcohol
Fulvic acid	Soluble	Soluble	
Humic acid	Soluble	Insoluble	Insoluble
Hymatomelanic acid	Soluble	Insoluble	Soluble
Humin	Insoluble	Insoluble	Insoluble

According to the German workers, humic acid can be further separated with neutral salt solutions into *brown humic acid* (soluble in NaCl) and *gray humic acid* (insoluble in NaCl). In addition to the major fractions, several authors reported the isolation of a *green humic acid* fraction (Kumada and Hurst, 1967). Based on absorption spectra and increasing values for  $\log K$  ( $= K_{400} - K_{600}$ , in which  $K$  = extinction), Kumada (1987) reported to be able to distinguish different types of humic acids in Japan (e.g., types A, B, R<sub>p</sub>, and P). This will be discussed in more detail in Section 5.9.9 on



spectral characteristics of humic compounds. The P types of humic acids can be further separated by gel filtration and column chromatography, employing cellulose powder or Sephadex, into a P<sub>b</sub> (brown) and P<sub>g</sub> (green) fraction. The P<sub>g</sub> fraction was called *green humic acid* in the past. Because of its green color, the present author believes that green humic acid is perhaps related to *glomalin*—a glycoprotein recently discovered by USDA-ARS scientists to replace humus as a carbon storage place (Nichols et al., 2002)—and not to humin as speculated by the USDA-ARS workers. Glomalin has been described to also exhibit a green color (see Section 5.3.1 for more on glomalin). On the other hand, humin is dark to black in color, and according to Bogoslovskiy and Levinskiy (2006), it is very high in molecular weight (m.w. ~10,000,000), features uncommon for glomalin.

## 5.9.2 TYPES OF HUMIC MATTER

Humic compounds, or humic matter, exist not only in soils, but also in streams, rivers, lakes, oceans, and their sediments (Steinberg, 2003). They can also occur in lignite or leonardite, coal, oil shale, and other geologic deposits. These deposits are the sources for the production of commercial humates (Burdick, 1965; Lobartini et al., 1992) that are used as soil amendments. Consequently, three categories of humic matter are distinguished by the present author:

1. *Terrestrial or terrigenous humic matter*—This is humic matter in soils which consists mainly of lignoprotein complexes. Humic and fulvic acids are major constituents. Based on the type of the lignin monomer, the group can perhaps be subdivided into:
  - a. *Softwood terrestrial humic matter*—Is structurally characterized by coniferyl alcohol.
  - b. *Hardwood terrestrial humic matter*—Is composed of sinapyl alcohol.
  - c. *Grass or bamboo terrestrial humic matter*—Consists of coumaryl alcohol.
2. *Aquatic humic matter*—This is humic matter found in streams, lakes, and oceans, and their sediments, and is composed mostly of fulvic acids. Humic acid is only a minor constituent. The group can be subdivided into:
  - a. *Allochthonous aquatic humic matter*—Humic matter brought from the outside in water. The humic matter is formed in soils, and after formation is leached or eroded into rivers, lakes, and oceans. Although physical and chemical changes may have been induced by the aquatic environment, the nature of the humic matter is still related to soil humic matter, which consists of lignoprotein complexes.
  - b. *Autochthonous aquatic humic matter*—Humic matter formed from cellular constituents of indigenous aquatic organisms. In marine sediments, this kind of humic matter consists of carbohydrate–protein complexes (Degens and Mopper, 1975; Jackson, 1975; Steinberg, 2003). The source is organic debris from plankton, seaweed, and kelp.
3. *Geologic humic matter*—Humic matter in lignite or leonardite, oil shale, and other geologic deposits. It is composed mostly of humic acids. Because of the aging process, most if not all of the fulvic acids have apparently polymerized into humic acids.

## 5.9.3 EXTRACTION AND ISOLATION OF HUMIC SUBSTANCES FROM SOILS AND WATER

### 5.9.3.1 Extraction of Soil Humic Matter

The methods available for the extraction and isolation of humic substances from soils have not changed from those of the 1970s and 1980s. One of the most popular isolation procedures today is still the NaOH extraction procedure, such as, for example, that suggested by the IHSS (<http://www.ihss.gatech.edu/soilhafa.html>, accessed June 9, 2009). The selection of a suitable extractant is still based on two conditions: (1) The reagent should have no effect on changing the physical and chemical nature of the substances extracted, and (2) the reagent should be able to quantitatively remove the humic substances from soils. Over the years, many inorganic and organic



solvents have been evaluated for their effectiveness in extracting humic compounds (Schnitzer et al., 1959; Stevenson, 1965), usually with mixed results in meeting the two foregoing conditions. Some of the reagents (e.g., dilute bases) can meet the condition set for quantitative removal of humic fractions. However, all of them are suspected to have some influence on modifying the physical or chemical properties of the extracted substances (Flaig et al., 1975), and the possibility of creating artifacts still confronts the investigator today. Some of the reported inorganic reagents used in extraction are listed in Table 5.1. Among these reagents, NaOH and  $\text{Na}_4\text{P}_2\text{O}_7$  are most widely employed in extraction. Introduced for the first time in 1919 in a generally accepted procedure by Oden, NaOH appears to be the most effective in quantitative removal of humic substances in soils. Because the use of this reagent may induce autoxidation of humic acids, it is usually suggested to conduct extraction with NaOH under a  $\text{N}_2$  gas atmosphere. A solution of 0.1 *N* NaOH is preferred because of its milder nature for extraction than 0.5 *N* NaOH (Pierce and Felbeck, 1975; Tan, 1996). Some have used 1 *M* (= 1 *N*) NaOH (Fiorentino et al., 2006), but higher NaOH solution strengths usually increase the danger of creating artifacts. Although not as effective as NaOH, sodium pyrophosphate,  $\text{Na}_4\text{P}_2\text{O}_7$ , is often used for extraction of humic fractions from soils high in sesquioxides content (Kononova, 1961). A combination of NaOH and  $\text{Na}_4\text{P}_2\text{O}_7$  has been used by Fiorentino et al. (2006). To increase effectiveness of extraction with  $\text{Na}_4\text{P}_2\text{O}_7$ , a solution with pH 9 to 10 is often recommended. Although occasional reports to the contrary have been noted, the use of 0.1 *M*  $\text{Na}_4\text{P}_2\text{O}_7$  often eliminates the need to decalcify soil samples before extraction by pretreatment with HCl. This is sometimes required with the NaOH procedure, for example, when using the IHSS isolation method. In some instances, it has been reported that humic fractions isolated with  $\text{Na}_4\text{P}_2\text{O}_7$  exhibited infrared spectra with better resolutions than those obtained by NaOH extraction (Tan, 1978c). However, a comparative study on the effectiveness of NaOH and  $\text{Na}_4\text{P}_2\text{O}_7$  extraction of humic acids by Orioli and Curvetto (1980) yielded indications that with the pyrophosphate method three high molecular weight fractions of humic acids were not extracted.

Extraction with acids as proposed by Schnitzer et al. (1959) technically yields only fulvic acids, because, by definition, only fulvic acids are soluble in acids. Humic acid is insoluble in acid condition.

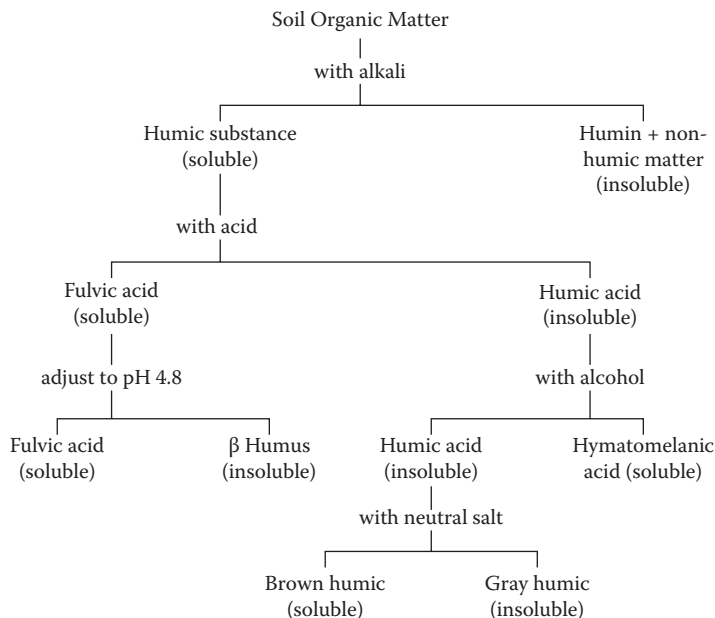
The organic solvents used for extraction of humic substances were oxalic acid, formic acid, phenol, benzene, chloroform, or a mixture of these, acetyl-acetone, hexamethylenetetramine, dodecylsulfate, and urea (Schnitzer and Khan, 1972). Thus far, none of these has been satisfactory. By using 0.5 *M* and 0.1 *M* hydroxymethylamine, Orioli and Curvetto (1980) obtained humic acids with carboxyl contents different from those extracted with NaOH. However, no differences were noted in the electrophoretograms of both the humic acids.

---

**TABLE 5.1**  
**Inorganic Reagents for Extraction of Soil Humic Acids**

Acids	Bases and Salts
0.1 <i>N</i> HCl	0.1 <i>N</i> NaOH
0.025 <i>N</i> HF	0.5 <i>N</i> NaOH
1% $\text{H}_3\text{BO}_3$	0.1 <i>M</i> $\text{Na}_2\text{CO}_3$
	0.1 <i>M</i> NaF
	0.1 <i>M</i> $\text{Na}_4\text{P}_2\text{O}_7$ , pH 7
	0.1 <i>M</i> $\text{Na}_4\text{P}_2\text{O}_7$ , pH 9 to 10
	0.2 <i>M</i> $\text{Na}_2\text{-EDTA}$
	0.1 <i>M</i> $\text{Na}_2\text{B}_4\text{O}_7$

---



**FIGURE 5.12** Flow chart for the separation of humic matter into the different humic fractions.

A flow chart showing the most common procedure for extraction and fractionation of humic matter with NaOH is presented in Figure 5.12 (Tan, 1996). This procedure forms the basis of the IHSS and the SSSA (Soil Science Society of America) methods.

### 5.9.3.2 Extraction of Aquatic Humic Matter

As discussed earlier, humic matter exists not only in soils, but also in streams, lakes, swamps, and oceans. Many of the Coastal Plain streams and swamps of the southeastern United States and other parts of the world carry dark-colored water (e.g., the Rio Negro in Brazil) called *black water*. The dark color is generally attributed to humic matter in solution, which is composed mostly of fulvic acid. Scientists of the U.S. Geological Survey are of the opinion that humic acid in black water exists as colloids, whereas the truly dissolved fraction is fulvic acid (Thurman et al., 1982). The isolation of aquatic humic matter from black water requires a somewhat different procedure than the extraction of humic matter from soils. The most accepted procedure is by passing acidified black water through a column containing an *amberlite XAD resin*, which is capable of adsorbing only humic matter, leaving other soluble organic contaminants free to be washed out. The adsorbed humic matter is then eluted from the column with a dilute NaOH solution. For a complete procedure, reference is made to Tan (1996, 2005) and Thurman and Malcolm (1981). Criticisms expressed occasionally to the XAD method are based on the concept of DOM (dissolved organic matter) that does not separate DOM into hydrophobic and hydrophilic components (Steinberg, 2003).

## 5.9.4 CHEMICAL CHARACTERIZATION AND COMPOSITION

### 5.9.4.1 Elemental Composition

An example of analytical data of humic and fulvic acids is shown in Table 5.2. Only very few of more recent data on the chemical composition are available. Steinberg (2003) quoted data from M. Schnitzer of 1978, which are not different from the data presented in Table 5.2. Humic acid is usually rich in carbon, which ranges from 41% to 57%. The lower ranges are exhibited by fulvic acids and humic acids in tropical soils. Fulvic acid distinguishes itself from humic acid by a higher oxygen

**TABLE 5.2**  
**Chemical Composition of Fulvic (FA) and Humic Acids (HA) from Tropical and Temperate Region Soils**

	C (%)	H (%)	O (%)	N (%)	S (%)	Total			Alcoholic	
						Acidity (mEq/g)	Carboxyl (mEq/g)	Hydroxyl (mEq/g)	Hydroxyl (mEq/g)	Carbonyl (mEq/g)
HA-Alfisol (temp.)	56.8	5.3	33.3	4.6	nd <sup>a</sup>	6.8	3.9	2.8	nd	nd
HA-Alfisol (trop.)	52.3	5.2	37.2	3.6	nd	nd	nd	nd	nd	nd
HA-Inceptisol (temp.)	51.4	5.8	38.7	4.1	nd	6.0	2.4	3.6	nd	nd
HA-Oxisol (trop.)	44.3	7.7	38.0	2.1	nd	nd	nd	nd	nd	nd
HA-Spodosol (temp.)	56.7	5.2	35.4	2.4	0.4	5.7	1.5	4.2	2.7	0.9
HA-Spodosol (temp.)	49.0	4.6	45.7	0.7	nd	12.0	9.2	2.8	nd	nd
HA-Ultisol (temp.)	48.7	4.8	42.7	3.8	nd	8.7	2.7	6.0	nd	nd
HA-Ultisol (trop.)	44.8	6.3	36.7	2.8	nd	nd	nd	nd	nd	nd
FA-Inceptisol (temp.)	47.9	5.2	44.3	2.6	nd	nd	nd	nd	nd	nd
FA-Spodosol (temp.)	50.9	3.3	44.7	0.7	0.3	12.4	9.1	3.3	3.6	3.1
FA-Spodosol (temp.)	50.2	4.6	43.4	1.8	nd	12.1	7.9	4.2	nd	nd
FA-Ultisol (temp.)	40.6	4.1	53.9	1.4	nd	10.2	8.8	1.4	nd	nd

<sup>a</sup> nd, not determined.

Sources: Cranwell, P. A., and R. D. Haworth. In *Humic Substances, Their Structure and Function in the Biosphere*, D. Povoledo and H. L. Gollerma (eds.), Centre for Agric. Publ. Doc., Wageningen, The Netherlands, 1975, pp. 13–18; Martin, F., C. Saiz-Jimenes, and A. Cert, *Soil Sci. Soc. Am. J.*, 41, 1114, 1977; Schnitzer, M. In *Humic Substances, Their Structure and Function in the Biosphere*, D. Povoledo and H. L. Gollerma (eds.), Centre Agric. Publ. Doc., Wageningen, The Netherlands, 1975, pp. 293–310; Schnitzer, M., and S. U. Khan. *Humic Substances in the Environment*, Marcel Dekker, New York, 1972; Tan, K. H. In *Handbook of Processes and Modeling in the Soil-Plant System*, Food Product Press, The Haworth Reference Press, Binghamton, NY, 2003, pp. 27–56; Tan, K. H., and J. Van Schuylenborgh, *Neth. J. Agric. Sci.*, 7, 1, 1959.

content, and by lower hydrogen and nitrogen contents. The oxygen content was 44% to 54% in fulvic acids versus 33% to 46% in humic acids. Li et al. (2003) reported C and H percentages, ranging from 54.1% to 60% for C and 4.8% to 7.6% for H contents in humic substances extracted from peat. Their higher molecular weight fractions exhibit generally lower %C than the lower molecular weight fractions. However, from the data presented, it is very difficult to exactly determine whether the high and low molecular weight fractions correspond to humic acids and fulvic acids, respectively. The nitrogen content (Table 5.2) in fulvic acid shows a range of 0.7% to 2.6% in contrast with humic acids, which contain 2% to 5% N. For humic acids, Flaig (1975) reported that the brown humic acid fraction of Chernozemic soils (Mollisols) was usually higher in N content than was the gray humic acid fraction. By mild degradation of humic compounds with peracetic acid oxidation, Schnitzer and Hindle (1980) succeeded in differentiating the N-containing components in the humic molecule. Different types of N components were detected (e.g.,  $\text{NH}_4^+\text{-N}$ ,  $\text{NO}_2^- + \text{NO}_3^-\text{-N}$ , amino-N, amino sugar-N, and by difference from total N, *unknown N*). These authors reported that 16.6% to 59.1% of the unknown N could be converted into  $\text{NH}_3$  and  $\text{N}_2$  gas. The amount of N detected in humic acids indicates the necessary participation of N-containing compounds, e.g., amino acids, amino sugars, in the formation of humic matter. Electron spin resonance (ESR) analysis reveals that humic acids have an aromatic core, containing physically or chemically bonded proteins, polysaccharides, simple phenols, and metals (Cranwell and Haworth, 1975), and according to Ghosh and Schnitzer (1980a), semiquinones also. The linkage to the core renders considerable stability to amino acids, protein, and polysaccharides toward biochemical attack.

From the data, Kononova (1961) reported that the humus nitrogen content in Chernozems (Mollisols) amounted to 7 to 10 t/ha in the top 20 cm. This value decreased toward the Spodosols and Aridisols, where 2 to 3 t/ha of humic-N was reported in the top 20 cm of Sierozems. These figures suggest that humic acid may contribute significantly toward the N supply of soils for plant growth.

#### 5.9.4.2 Total Acidity

The total acidity or exchange capacity of humic compounds is attributed to the presence of dissociable protons or  $\text{H}^+$  ions in aromatic, aliphatic carboxyl and phenolic hydroxyl groups. The contribution of carbohydrate or alcoholic hydroxyl groups has been suspected (Cook and Langford, 1998; Reddy and DeLaune, 2008), but the consensus is that the carboxyl (COOH) groups contribute more to the total acidity than the other functional groups. Humic acids are characterized by a lower total acidity and lower carboxyl content than fulvic acids (see Table 5.2). The total acidity of humic acids amounts generally to 5 to 6 mEq/g (=  $\text{cmol}(\text{p}^+)\text{kg}^{-1}$ ), with the exception being in humic acids of Spodosols and Ultisols. Spodosols are very acidic soils containing humic acids that occasionally exhibit a relatively high total acidity and high carboxyl content. In contrast with humic acids, fulvic acids have a total acidity of 10 to 12 mEq/g, which is approximately two times that of humic acids. The carboxyl content of fulvic acid is two to three times higher than that of humic acids, but the phenolic hydroxyl group concentration does not seem to differ significantly from that of humic acids. Therefore, it can be concluded that the higher acidity of fulvic acid is perhaps attributed to the higher carboxyl content. With the exception noted for one of the Spodosols, the data in Table 5.2 also indicate that the variation observed in total acidity of humic compounds is not affected by the variation in soils, but rather by type of organic acid. The data presented above do not differ much from those reported in 2008 by Reddy and DeLaune (2008), who quoted figures of Stevenson (1994).

The current author notices that the value for total acidity is also dependent on the method of analysis. It is usually measured by the  $\text{Ba}(\text{OH})_2$  adsorption method, which yields higher values than other methods. As can be noticed from Table 5.3, total acidity measurements using KOH, NaOH, or Ba acetate procedures generally yield lower values (Felbeck, 1965).

Another factor affecting total acidity or exchange capacity of humic substances is the pH. With titration procedures, Tan (1978a) obtained in his chelation studies exchange capacities of humic acids ranging from 2.26 to 4.48 mEq/g. As can be seen from the data in Table 5.4, the total acidity of humic acid was 2.26 to 2.83 mEq/g at pH 7, but increased to 4.43 to 4.48 mEq/g at pH 11.5.

**TABLE 5.3**  
**Total Acidity of Humic Substances Measured by Different Methods**

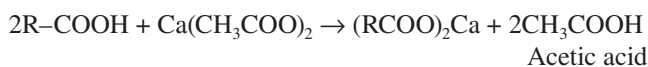
Material	Total Acidity (mEq/g) by			
	Ba(OH) <sub>2</sub>	KOH	NaOH	Ba Acetate
Peat	3.8	2.96	2.54	1.83
Pine forest soil	6.9	—	—	—
Dunkirk soil (Ontario)	4.3	—	—	—

These values were in agreement with those reported by Tiurin and Kononova (1962) and Orlov and Erosiceva (1967). The recovery values for Al<sup>3+</sup>, Fe<sup>3+</sup>, and Cu<sup>2+</sup> of 4.4 to 4.5 mEq/g HA (pH 11.5) compared favorably with acidity values of humic acids found by Butler (J. H. A. Butler, unpublished Ph.D. thesis, University of Illinois, 1966; see also Stevenson, 1976a).

### 5.9.4.3 Carboxyl Groups

Humic acid is generally characterized by a lower carboxyl group content than fulvic acid. The data in Table 5.2 show a carboxyl group concentration in humic acids ranging from 1.5 to 2.7 mEq/g HA, in contrast to FA with a range of 7.9 to 9.1 mEq/g FA. The exception is the carboxyl group content of humic acid in one of the Spodosols where a value of 9.2 mEq/g HA was detected. As reported earlier, Spodosols are very acidic soils containing acid humus.

Several methods are available for determination of the amounts of carboxyl groups in humic and fulvic acids (e.g., methods using ion exchange, decarboxylation, iodometry, esterification, and the Ca acetate procedure). Many scientists are using the esterification and Ca acetate methods. Depending on the procedures used, different values are obtained. With esterification, employing diazomethane and dimethylsulfate (Schnitzer, 1974; Stevenson and Goh, 1972; Tan, 1975) to esterify the COOH groups, Felbeck (1965) noted that 54% of the exchange capacity of humic acids was attributed to COOH groups. The Ca acetate method makes use of the reaction in which acetic acid is formed and released according to the following reaction:



**TABLE 5.4**  
**Effect of pH on Amounts of Metal Ions (mEq/g) Chelated by Humic Acids**

Titration Product	Metal Ion Recovery (mEq/100 mg)	pH	
		Before Titration	After Titration
HA-Al <sup>3+</sup>	0.445	11.5	7.05
HA-Al <sup>3+</sup>	0.226	07.0	5.12
HA-Fe <sup>3+</sup>	0.443	11.5	6.42
HA-Fe <sup>3+</sup>	0.255	07.0	4.38
HA-Cu <sup>2+</sup>	0.448	11.5	6.82
HA-Cu <sup>2+</sup>	0.283	07.0	6.03

Source: Tan, K. H., *Soil Biol. Biochem.*, 10, 123, 1978.

The COOH content is then determined by titration of the acetic acid with a standard base. With this procedure, Schnitzer and Khan (1972) reported a carboxyl content of 1.5 mEq/g of humic acid. As indicated earlier, fulvic acid distinguishes itself from humic acid by containing a higher carboxyl content amounting to 9.1 mEq/g of fulvic acid.

#### 5.9.4.4 Hydroxyl Groups

Humic substances contain a variety of hydroxyl groups, but for characterization of humic acids generally three types of OH groups are distinguished:

1. *Total hydroxyls*, measured by acetylation, are the hydroxyl groups associated with all functional groups, such as phenols, alcohols, and hydroquinones. However, in many cases, the term “total hydroxyls” refers only to the sum of phenolic- and alcoholic-OH groups.
2. *Phenolic-hydroxyl groups* are OH attached to phenolic (benzene) rings. The amount can be calculated by difference as follows:

$$\text{mEq phenolic-OH} = \text{mEq total acidity} - \text{mEq COOH}$$

3. *Alcoholic-OH groups* are OH associated with alcoholic groups. The amount can also be determined by difference as follows:

$$\text{mEq alcoholic-OH} = \text{mEq total OH} - \text{mEq phenolic-OH}$$

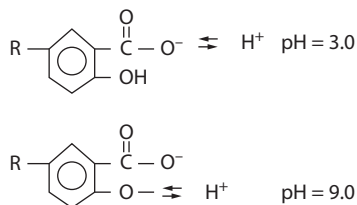
The amount of phenolic and alcoholic hydroxyl groups does not differ significantly between humic and fulvic acids (see Table 5.2), whereas the reactivity of alcoholic-OH groups is usually considered lower than that of phenolic-OH groups. As indicated earlier, Cook and Langford (1998) suggested that these groups should perhaps be considered more important than the phenolic-OH groups in determining the chemical structure of, especially, fulvic acids.

In addition to total acidity, carboxyl, and hydroxyl groups, as discussed above, humic compounds contain carbonyl (C=O) groups, either as ketonic C=O or as quinoid C=O groups. Each of these groups amounts to approximately only 1 mEq/g of humic or fulvic acid (Schnitzer, 1975). Recently, a report has surfaced that one-third of the aromatic C-O groups was detected as methoxyl, C-OCH<sub>3</sub>, groups and was not present as wholly phenolic-OH (Mao et al., 2001). Nonetheless, it can perhaps be stated that fulvic acid, in general, is more acidic and possesses more carboxyl groups than humic acids. Regardless of these facts, for some reason, the overall reactivity in practice is always greater for humic acids than for fulvic acids.

Sposito and Holtzclaw (1977) reported that fulvic acid extracted from sewage sludge was a heterogeneous polynuclear polyacid. It contains functional groups that can behave very strongly or weakly acidic. The strongly acidic groups ionize at pH < 2 and perhaps are attributable to sulfonic acid groups. The more weakly acidic groups ionize, according to the previous authors, at pH > 10 and are caused by carboxyls, phenolic-OH, SH-, and N-containing groups. This polyacid nature is considered the reason for fulvic acids to form “weak ion pairs” with protons.

#### 5.9.5 COLLOIDAL CHEMISTRY AND REACTIONS

The chemical behavior of humic matter is controlled by the two functional groups, the carboxyl and phenolic-OH groups, whereas the contribution of the alcoholic-OHs has yet to be established. Reddy and DeLaune (2008) agree that the carboxyl, COOH, groups contribute most to the reactions. This carboxyl group starts to dissociate its proton at pH 3 (Posner, 1964), and the humic molecule becomes electronegatively charged (Figure 5.13). At pH < 3.0, the charge is very small, or sometimes even zero. At pH 9, the phenolic-OH group also starts to dissociate, and because both functional groups are then dissociated, the humic molecule attains a high negative charge. Because

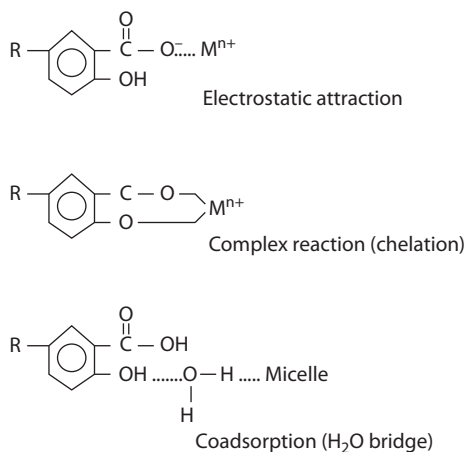


**FIGURE 5.13** Development of variable negative charges in a humic molecule by dissociation of protons from carboxyl groups at pH 3, and from phenolic-OH groups at pH 9.

the development of negative charges is pH dependent, this charge is called *pH-dependent charge* or *variable charge*. A number of reactions or interactions can take place because of the presence of these charges. At low pH values, the humic molecule is capable of attracting cations, which leads to cation exchange reactions. The cation exchange capacity (CEC) of humic substances can be estimated from their total acidity values. From the data in Table 5.2, it can be noticed that the CEC of humic acids in terms of total acidity ranges from 500 to 1200 me/100 g. Fulvic acids exhibited even higher CEC values. At high pH values, when the phenolic-OH groups are also dissociated, complex reactions and chelation between metals and the humic molecule are of importance for the metal bridging process (Figure 5.14). This is the case in interaction reactions between humic matter and clay. In the latter case, a water molecule, or the metal, acts as a bridge between the organic ligand (humic molecule) and the clay micelle. The principles of colloidal chemistry explain the reactions taking place in potentiometric titrations of humic acid, a topic discussed in the next section.

### 5.9.6 COLLOIDAL PROPERTIES AND POTENTIOMETRIC TITRATIONS OF HUMIC ACID

Potentiometric titration has been used extensively to characterize the acid–base properties of humic substances (Posner, 1964). The curves are usually presented as sigmoidal, whereas titration was carried out mostly with a base. The result leads to the belief that humic substances have a monobasic character (Schnitzer and Khan, 1972). Cooke et al. (2007) noticed a hysteresis effect in titrations of humic acid with bases and acids at the low pH ranges, resulting in them concluding that the older titration data were incorrect and could also have overestimated the acid buffering capacity of humic compounds. Humic acids are, in fact, amphoteric and polybasic. Depending on the soil condition, they can be neutral, negatively charged, or positively charged. The negative charges are attributed



**FIGURE 5.14** Examples of interactions between humic acid and a metal cation, and humic acid and a clay micelle.  $\text{M}^{n+}$  is a cation with charge  $n$ ; R is the remainder of the humic acid molecule.



to the presence of phenolic-OH and carboxyl groups, as indicated in the previous section. The dissociation of  $H^+$  ions from the carboxyl group for the development of the negative charges can be illustrated again as follows:



for which the pK value according to the Henderson–Hasselbalch equation is:

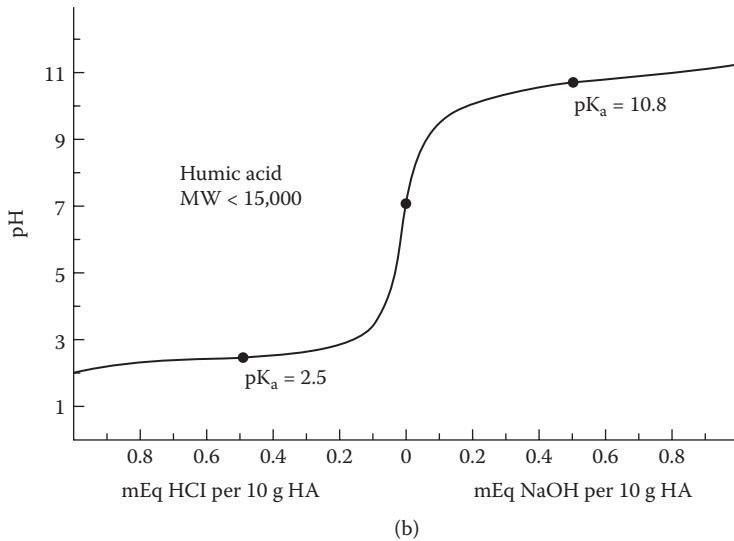
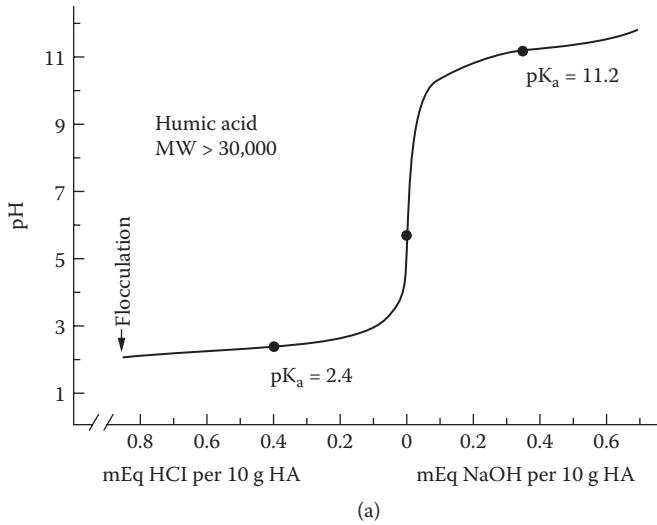
$$pK = pH - \log (COO^-)/(COOH)$$

For pK values in the acid and basic range, and the corresponding titration curves, reference will be made later. Not only do humic acids possess two different types of oxygen-containing functional groups, they also contain dissociable  $H^+$  ions from amino groups. Although several investigators believe that humic substances should be free of N (Burges, 1960), elemental analysis revealing significant amounts of N (see Table 5.2) suggests that N-containing compounds, such as amino acids, must be present in the humic molecule. Because amino acids are amphoteric and, depending on conditions, can behave as an acid or a base, the latter necessitates continuation of titration in the acid range. Titration curves obtained by acid and base titration of humic acids are shown in Figure 5.15a,b. The curves indicate that at pH 7 the carboxyl groups of humic acids are unprotonated, whereas the OH or amino groups, or both, appear to be protonated. The latter may produce substituted hydronium ions or substituted amino ions ( $-NH_2-H^+$ ). Addition of acid to the solution lowers the pH rapidly at first and then more slowly as the buffering action of the carboxyl groups is activated. At pH 2.4, the  $pK_a$  is reached, at which half of the carboxyl groups of humic acid (high molecular weight) are considered ionized, conforming to the Henderson–Hasselbalch equation. Further addition of acid results in a slight decrease, and finally at pH 2, the high molecular weight humic acid starts to flocculate. Titration of the substituted OH and amino acids with a base follows an opposite trend in the alkaline region. According to the inflection point, the  $pK_a$  is reached at pH 11.2.

### 5.9.7 CHROMATOGRAPHY OF HUMIC SUBSTANCES

Two types of chromatographic methods have been used in the characterization of humic material—gel chromatography and gas–liquid chromatography—for quite different purposes. Gel chromatography is proposed for purification processes or for fractionation of the humic compounds into different components or into fractions of different molecular sizes. The latter has been extended to measurements of molecular weights (Holty and Heilman, 1971; Mehta et al., 1963; Orlov et al., 1975; Swift et al., 1970). Very sophisticated methods, such as high-performance size-exclusion chromatography (HPSEC), have been developed today for this purpose (Conte et al., 2006; Piccolo, 2002). With this new, more modern method, the humic substance is allegedly detected to be composed of two subunits: (1) an aliphatic group or subunit, possessing low molecular weights, and (2) a second group or subunit composed of mainly aromatic constituents exhibiting the largest molecular dimension, which disagree with an earlier report in 2003. In contrast, Li et al. (2003) indicated that the aliphatic subunits exhibited large molecular weights ( $M_w$ ), whereas the aromatic subunits were the lowest in terms of  $M_w$ . Their average molecular size ( $M_w$ ) increases from 7.7 to 22.1 kDa depending on the extent of fractionation or extraction. Conte and coworkers reported a substantially higher range of molecular sizes in the order of >100 kDa for the larger units, and <100 kDa for the smaller HPSEC fractions.

Gas–liquid chromatography, on the other hand, is used primarily for fractionation of humic material into its component molecules. However, both methods can also be applied in the characterization of humic substances by using the chromatograms as fingerprints. Unfortunately, the advantages of the latter (fingerprinting) have not been fully exploited. Nevertheless, the use of

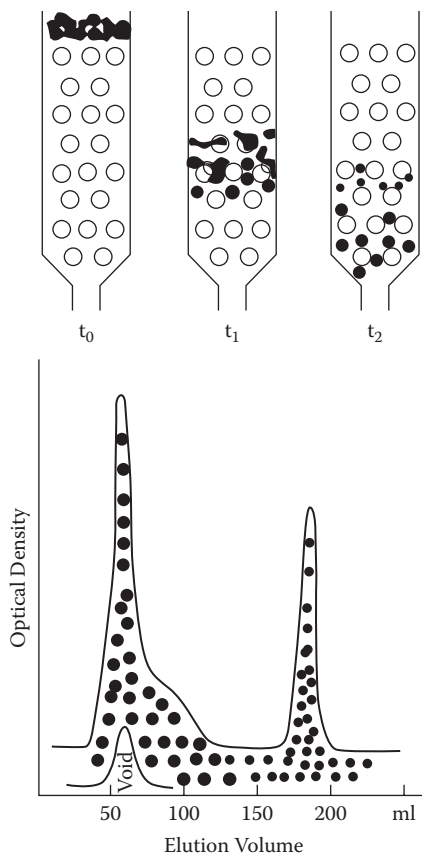


**FIGURE 5.15** Titration curves of (a) high (>30,000) and (b) low (<15,000) molecular weight fractions of humic acid from a Cecil soil (Ultisols). Molecular weight fractionation was done by gel chromatography using Sephadex G-50. (Reprinted from Tan, K. H., and J. E. Giddens, *Geoderma*, 8, 221–229. Copyright 1972, with permission from Elsevier.)

gas chromatography together with mass spectrometry is considered today a powerful tool for the identification and structural analysis of humic acids (Schnitzer, 1976; Trubetskoi et al., 2005).

### 5.9.7.1 Gel Chromatography

Gel chromatography is a simple and relatively effective method in achieving molecular fractionation. A variety of materials have been used as the gel substance (e.g., polysaccharides, polystyrene, polyamides, aluminum oxides, cellulose, agar, and glass beads). The most widely used gel materials are the cross-linked polymers of polysaccharides, polystyrene, polyamides, and the like, distributed under names such as Sephadex, Sephagel, Biogel, and Cellogel. A column of swollen gel beads is prepared, and a solution of humic acid is eluted (filtered) through the column at a controlled flow



**FIGURE 5.16** Sephadex G-50 gel filtration of humic acid from a Cecil soil (Ultisols): (●) high molecular weight HA; (◐) low molecular weight HA; (○) Sephadex beads.

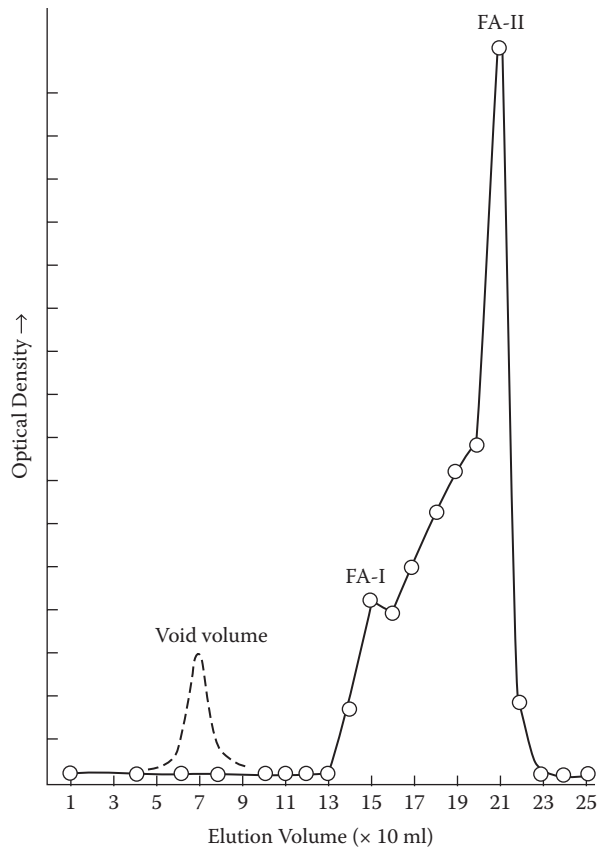
rate. The filtration is diagrammatically illustrated in Figure 5.16. The pores between and within the gel beads enable the gel column to act as a chromatographic medium. The large open circles in the figure are the Sephadex beads. The small and large black dots represent a mixture of small and large molecules of humic acids. As the mixture of molecules passes through the column, the larger molecules are eluted first, and depending on conditions, the elution curve may be represented by two peaks as shown in Figure 5.16. The first peak is attributable to the larger molecules and the second peak to the smaller molecules. If the mixture is composed of only small molecules, such as fulvic acids, the elution curve may be characterized by only one major peak (Figure 5.17). A similar principle holds with HPSEC, where large molecular size humic fractions are eluted first, followed usually by progressively smaller molecular size humic fractions (Conte et al., 2006).

The behavior of the solute in Sephadex-gel filtration can be measured by its elution volume, whereas the elution peak is determined by the partition coefficients  $K_{av}$  and  $K_d$ , which are defined as:

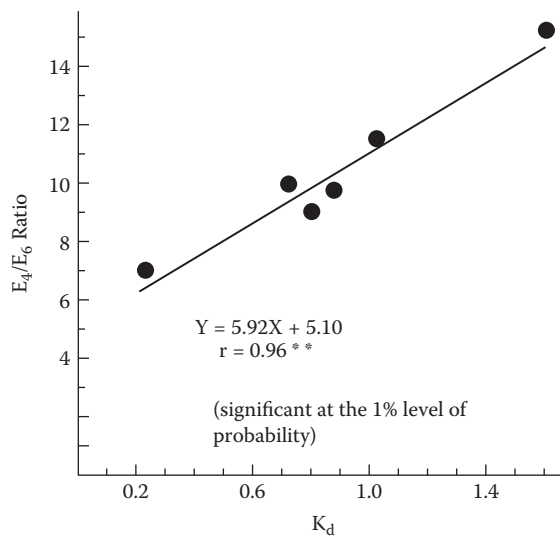
$$K_{av} = (V_e - V_o)/(V_t - V_o) \quad K_d = (V_e - V_o)/V_i$$

where  $V_e$  is the elution volume;  $V_o$  is the void volume;  $V_t$  is the total volume of the gel bed;  $V_i$  is the inner volume of the gel (*Handbook of Sephadex-Gel Filtration in Theory and Practice*, Pharmacia Fine Chemicals, Uppsala, Sweden, 1969).

Tan and Giddens (1972) reported that the partition coefficients  $K_d$  were higher for the small molecules of humic material, and a positive correlation was obtained between  $K_d$  values of humic



**FIGURE 5.17** Gel filtration of fulvic acid using Sephadex G-50. FA-I has larger-sized molecules than FA-II.



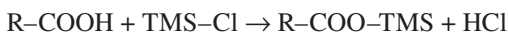
**FIGURE 5.18** The relationship between color ratios  $E_4/E_6$  of fulvic acids and partition coefficients  $K_d$ . (Reprinted from Tan, K. H., and J. E. Giddens, *Geoderma*, 8, 221–229. Copyright 1972, with permission from Elsevier.)

fractions separated by Sephadex and color ratios  $E_4/E_6$ . As can be noted from Figure 5.18, humic fractions with higher partition coefficients exhibit larger  $E_4/E_6$  ratios. This corresponds to the observation indicating that the smaller molecules, eluted last, also have lower molecular weights, whereas the larger molecules, eluted first, are of higher molecular weight.

### 5.9.7.2 Gas-Liquid Chromatography

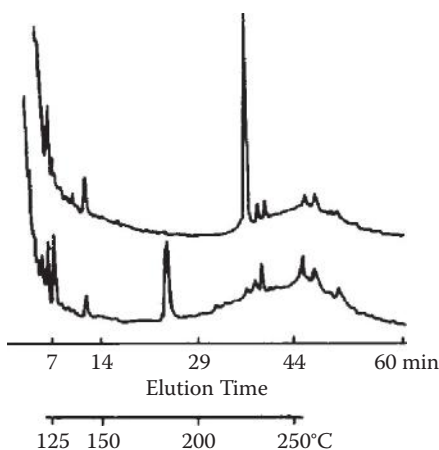
Gas-liquid chromatography (GLC) is a complex method that is not as versatile as gel chromatography. Gas chromatography requires that the material to be analyzed be easily transformed into the gas phase, which is a major obstacle with humic acids. Humic compounds are generally nonvolatile, and no method has yet been reported in the literature for making them volatile without decomposing the humic material into smaller components first. Schnitzer and Khan (1972) reported the senior author's efforts in gas chromatography using degradation products of fulvic acids, obtained by oxidation with strong acids or by reduction with Na-amalgam. The degradation products identified were mostly benzene derivatives (e.g., benzene di-, tri-, tetra-, penta-, and hexacarboxylic acids). The extent to which organic artifacts that no longer resemble the real structural units of the original humic material may be produced during the oxidation or reduction processes is unclear.

Success has been obtained in gas chromatography of carbohydrates and related polyhydroxy compounds with the use of trimethylsilyl (TMS) (Tan and McCreery, 1970a). The TMS group  $\text{Si}(\text{CH}_3)_3$  is introduced (by shaking) into humic substances through their functional groups that have exposed protons or active  $\text{H}^+$  ions:



Silylated humic acid from different kinds of soils exhibited gas chromatograms (Figure 5.19) with almost the same number of components appearing at similar retention times (Tan and McCreery, 1970b). However, the concentration varied considerably between some of the components of the two humic acids, as can be seen from the differences in peak heights.

As indicated above, the complexity and the difficulties in making humic substances volatile have shielded many people from applying this method. Nonetheless, pyrolytic gas chromatography in conjunction with mass spectrometry has proven to be a very powerful tool in the search for the elusive molecular structure of humic substances (De La Rosa et al., 2008; Trubetskoi et al., 2005).



**FIGURE 5.19** Gas chromatograms of humic acids silylated for 36 h. Top: Methylated HA from a Cecil soil (Ultisols). Bottom: Methylated HA from a Greenville soil (Ultisols). (From Tan, K. H., and R. A. McCreery, *Commun. Soil Sci. Plant Anal.*, 1, 75–84, 1970b. With permission from Taylor & Francis Group. <http://www.informaworld.com>.)

### 5.9.8 MOLECULAR WEIGHTS OF HUMIC COMPOUNDS

As discussed earlier, the use of molecular weights in the characterization of humic substances encounters many problems because of different concepts. Especially the new supramolecular association concept (see Section 5.9.1.2), created by the deduction of existing data, is critically opposed to assigning a specific molecular weight to humic matter. Traditionally, a great number of scientists believe these compounds to be polymers and polydisperse in nature. They possess, therefore, a wide spread of molecular weight, causing the humic materials to be very heterogeneous in nature (Felbeck, 1965; Reddy and DeLaune, 2008). The degree of polydispersity may vary considerably depending on the contributing components of the humic molecule with different molecular weights. In addition, the emergence of the new concept of humic substances, being just clusters of small heterogeneous molecules derived from decomposition of biological material, makes the issue more confusing and complex than it already is.

Physically, molecular weights can be expressed as follows:

1. The *number-average molecular weight*  $\bar{M}_n$  is defined as:

$$\bar{M}_n = (\sum nM)/n$$

where  $n$  is the number of component molecules, and  $\bar{M}$  is the molecular weight of component molecules. The methods used to determine  $\bar{M}_n$  are osmometry, diffusion, and isothermal and cryoscopic distillation. Osmometry is considered the best method, but it appears not to be applicable to analysis of molecular weights >200,000.

2. The *weight-average molecular weight*  $\bar{M}_w$  is defined as:

$$\bar{M}_w = (\sum nM^2)/(\sum nM)$$

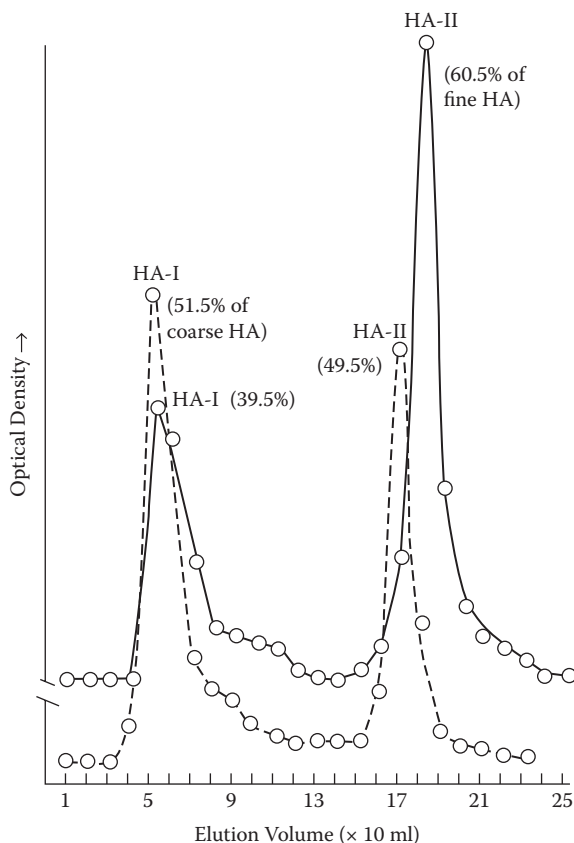
The weight-average molecular weight is usually measured using viscosity analyses and gel filtration. Of the two, gel filtration is the simplest method, as discussed earlier.

3. The *Z-average molecular weight*  $\bar{M}_z$  is defined as:

$$\bar{M}_z = (\sum nM^3)/(\sum nM^2)$$

The method used to measure  $\bar{M}_z$  is the sedimentation method employing the ultracentrifuge. It yields many problems with humic compounds. Humic acid carries a negative charge balanced by cations, thereby creating a diffuse double-layer system. Because of the latter, the molecules tend to repel each other, offsetting the sedimentation process. Intermolecular repulsion yields high-diffusion and low-sedimentation coefficients owing to faster sedimentation of the larger molecules than the counterions, resulting in an electrostatic drag. In addition, the polydisperse nature makes it difficult to achieve well-defined sediment boundaries with humic material.

For a heterogeneous, or polydisperse, system,  $\bar{M}_n < \bar{M}_w < \bar{M}_z$ , but for a homogeneous, or mono-disperse system,  $\bar{M}_n = \bar{M}_w = \bar{M}_z$ . Values reported for weight-average molecular weight  $\bar{M}_w$  of humic matter may vary from 1000 to 30,000. Flaig and Beutelspacher (1951) stated molecular weights of >100,000, and values of 2 million have been reported occasionally. Apparently, any number within these ranges can be obtained, depending on the isolation procedures and analysis employed, with fulvic acids usually exhibiting the lower and humic acids the higher molecular weight values. This is supported by more current data using the more modern HPSEC method. Notwithstanding the more advanced method, any number of fractions can apparently also be produced. Eight fractions have been obtained by Li et al. (2003), whereas Conte et al. (2006) divided the chromatograms arbitrarily into 11 fractions. From their studies, Li and coworkers reported the average molecular size ( $\bar{M}_w$ ) to



**FIGURE 5.20** Sephadex G-50 gel filtration of humic acids. HA-I = high molecular weight fraction; HA-II = low molecular weight fraction. Broken line represents humic acid that has been dialyzed with a membrane having a molecular weight cutoff of 10,000. The solid line represents humic acid that has been dialyzed with a cellulose membrane with a molecular weight cutoff of 3500.

increase from 7.7 to 22.1 kDa, depending on the extent of extraction. Conte and coworkers were less specific and only stated that the larger-size fractions were in the order of >100 kDa, whereas the smaller-size fractions of humic substances were <100 kDa. Ultrafiltration by Lobartini et al. (1997), with an *Amicon cell*, employing a membrane with a 10,000 Dalton exclusion limit at the start, also indicates that humic acid would yield molecular weight fractions as imposed by any exclusion limits used in the analysis. However, the elemental composition, infrared spectra, and electron micrographs show that the different fractions contain essentially the same components. This suggests that humic acids may possess a composition more homogeneous in nature than previously expected, which is in agreement with a more recent statement by Piccolo (2002).

Molecular weight values of humic substances, discussed in Section 5.9.1, were noted to vary widely from a few thousand to 10,000,000 or more. However, Thurman et al. (1982) indicated that the range of molecular weights is only between 500 to 10,000 for aquatic humic matter, with the smallest values of 500 to 2000 recorded for aquatic fulvic acids.

Tan and Giddens (1972) reported that with Sephadex G-50 filtration, humic acid was separated only into two fractions: a high (>30,000) and a low (<15,000) molecular weight fraction (Figure 5.20). The high molecular weight fraction made up 50% of the humic acid isolate, whereas the remaining 50% was the low molecular weight humic components. From these and other results of similar gel filtration analyses, Tan and McCreery (1975) noted that the degree of polymerization or the size of the molecules isolated affected molecular weights. By making the assumption that humic molecules



**TABLE 5.5**  
**Molecular Weights and Size (in Å and nm) of Humic Fractions Obtained by Sephadex-Gel Filtration**

Molecular Weight	Molecular Volume Å <sup>3</sup>	Radius	
		Å	nm
30,000	23,622	17.8	1.78
5,000	3,937	9.8	0.98
1,500	1,181	6.6	0.66
1,000	787	5.7	0.57

are round or spherocolloids, they managed to calculate the molecular volume and radius. The data in Table 5.5 demonstrate the relation between the linear sizes (radius) of spherical humic molecules and their molecular weights. The larger the sizes of the molecules of the humic fraction isolated by Sephadex-gel filtration, the larger will be the numerical value of the molecular weight of humic acid. It is of course true that many other factors (e.g., density and shape) will spoil this relationship, while many scientists may also disagree with the spherical shape, though Flaig and Beutelspacher (1951) and more recently Stevenson and Schnitzer (1982) have shown round particles by electron microscopy. Flexible linear to ellipsoidal and randomly folding chains and coils of humic molecules have also been proposed at one time or another, which then do not apply to the data in Table 5.5. However, until a better concept can be advanced, the suggested hypothesis by the current author provides a temporary solution to the issue of converting statistically mass or molecular volumes into linear sizes.

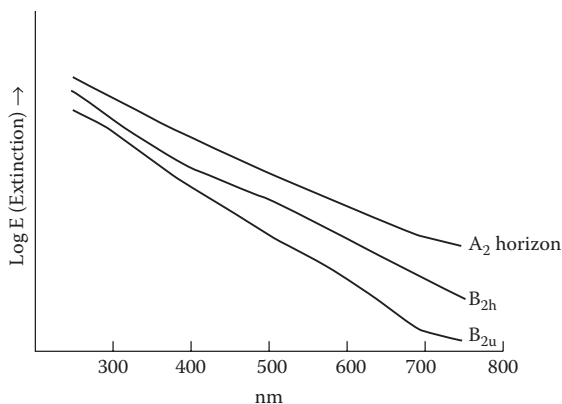
## 5.9.9 SPECTRAL CHARACTERISTICS OF HUMIC COMPOUNDS

### 5.9.9.1 Ultraviolet and Visible Light Spectrophotometry

The color of humic substances is a physical property that has attracted the attention of many scientists who attempted to use it for characterization of humic fractions in soils (Flaig et al., 1975; Kononova, 1966; Schnitzer, 1971; Tan and Giddens, 1972; Tan and Van Schuylenborgh, 1961), though Piccolo (2002) is very skeptical about its usefulness in the study of humic compounds. In Germany, especially, color properties of humic substances have attracted a number of investigators. They reported that the intensity of light absorption was characteristic for the type or molecular weight of humic substances. In UV-visible light spectrophotometry, humic solutions are scanned and the absorbance recorded at various wavelengths between 300 and 800 nm. By plotting the logarithm of the absorbance against the wavelengths, a straight line regression is obtained. The slope of such a line has been used for differentiation of humic substances. Fulvic acids are considered to yield spectra with a steep slope, in contrast to humic acids (Figure 5.21). The slope of the spectral curve can be expressed as a ratio or quotient of the absorbance at two arbitrarily selected wavelengths (e.g., absorbance or extinction at 400 and 600 nm), called the *color ratio*  $E_4/E_6$  or  $Q_{4/6}$ :

$$E_4/E_6 \text{ or } Q_{4/6} = (\text{absorbance at 400 nm})/(\text{absorbance at 600 nm})$$

This color ratio is then used as an index for the rate of light absorption in the visible range. A high color ratio, 7 to 8 or higher, corresponds with curves with steep slopes and is usually observed for fulvic acids or humic acid fractions of relatively low molecular weights. On the other hand, a low color ratio, 3 to 5, corresponds to curves that are less steep. These curves are exhibited by humic acids and other related compounds with high molecular weights. The data in Table 5.6 show some  $E_4/E_6$  ratios



**FIGURE 5.21** Light absorption of humic acids of A and B horizons of a Spodosol in tropical regions. (From Tan, K. H., and J. Van Schuylenborgh, *Neth. J. Agric. Sci.*, 9, 174–180, 1961. With permission.)

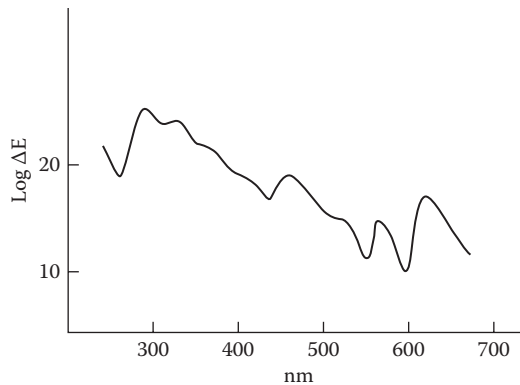
of humic substances extracted from temperate region soils. It can be noticed that humic acids with high molecular weights ( $MW > 30,000$ ) have lower  $E_4/E_6$  values (4.32 to 4.45) than humic acids with lower molecular weights ( $MW = 15,000$ ). The lower molecular weight fractions exhibit  $E_4/E_6$  values of 5.47 to 5.49. As indicated above, Piccolo (2002) seems to be very critical about the issue above and indicated that  $E_4/E_6$  ratios have been shown to not hold to the relationship with molecular weight.

**TABLE 5.6**  
**Color Ratio  $E_4/E_6$  of Humic Substances Isolated from Soils in Temperate Region**

Soil Order	Great Group	$E_4/E_6$
<b>Humic Acid, <math>MW &gt; 30,000^a</math></b>		
Ultisols	Hapludults (Cecil soil)	4.32
Ultisols	Paleudults (Greenville soil)	4.45
<b>Humic Acids, <math>MW = 15,000^a</math></b>		
Ultisols	Hapludults (Cecil soil)	5.49
Ultisols	Paleudults (Greenville soil)	5.47
<b>Humic acids<sup>b</sup></b>		
Spodosols	Podzol	5.0
Alfisols	Dark Gray Forest soil	3.5
Mollisols	Chernozem	3.3
Mollisols	Chestnut soil	3.9
Aridisols	Sierozem	4.3
<b>Fulvic acids</b>		
Ultisols <sup>a</sup>	Hapludults (Cecil soil)	8.0
Unknown (Canada) <sup>b</sup>	C	6.0 to 8.0

<sup>a</sup> Tan, K. H., and J. E. Giddens, *Geoderma*, 8, 221, 1972.

<sup>b</sup> Schnitzer, M., and S. U. Khan. *Humic Substances in the Environment*. Marcel Dekker, New York, 1972; Kononova, M. M. *Soil Organic Matter*. Pergamon, Oxford, 1966.



**FIGURE 5.22** Derivative spectrum of humic acid from a Spodosol. (From Salfeld, J. C. In *Humic Substances, Their Structure and Function in the Biosphere*, D. Povoledo and H. L. Golterman (eds.), Centre Agric. Publ. Doc., Wageningen, The Netherlands, 1975, pp. 269–280.)

**TABLE 5.7**  
**Occurrence and  $\Delta\log K$  Values of A, B,  $R_p$ , and P Humic Acids**

Type of Humic Acid	$\Delta\log K$	Occurrence
A	<0.6	A horizons of volcanic ash soils
B	0.6 to 0.8	Brown forest soils, red-yellow soils, and paddy soils
$R_p$	0.8 to 1.1	Peat, decomposed grasses, stable manure
P	—	Exhibits absorption bands near 615, 570, and 540 nm; This type can be distinguished again in $P_g$ (green) and $P_b$ (brown) fractions; occurs mainly in Spodosols (Podzols)

Nonetheless, after comparing  $E_4/E_6$  ratios of various humic substances, Piccolo indicates that the relationship is justifiable only with the use of thoroughly purified humic substances.

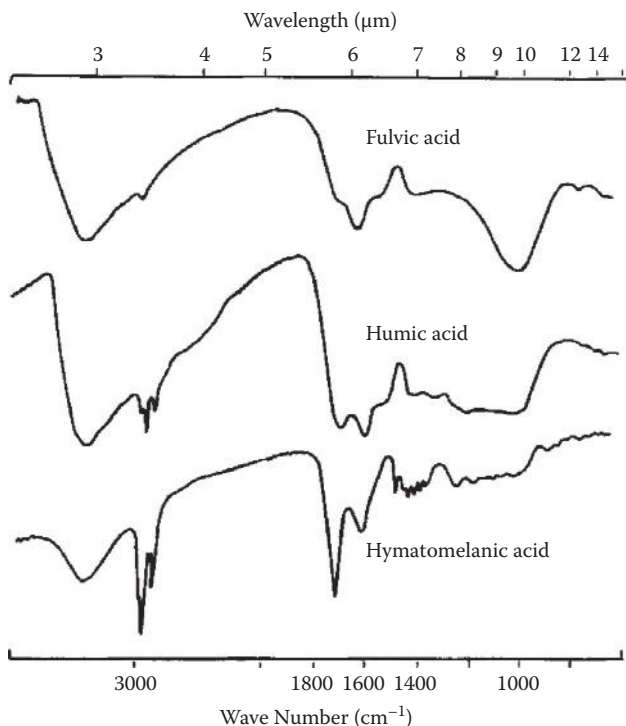
Because UV-visible light spectra of humic compounds are generally featureless lines, Salfeld (1975) proposed the use of differences between two adjacent absorbances. By plotting the logarithms of these differences ( $\Delta E$ ) against the wavelengths, a curve was obtained with several peaks (Figure 5.22), called the *derivative spectrum*.

Although the absorption spectra of humic acids in the visible range have the form of straight lines, the inclination or angle of the curves, as expressed by  $\Delta\log K = \log K_{400} - \log K_{600}$ , has been used in Japan for characterization and distinction of four major types of humic acids (Kumada, 1965, 1987; Kumada and Miyara, 1973; Yoshida et al., 1978) (Table 5.7).

Finally, it should also be mentioned that humic compounds may exhibit fluorescence spectra. By using fluorescence excitation spectroscopy, Ghosh and Schnitzer (1980b) indicated that both fulvic and humic acids showed curves with distinct bands at 465 nm. However, fulvic acid appeared to distinguish itself from humic acid by displaying an additional band at 360 nm.

### 5.9.9.2 Infrared Spectroscopy

Infrared spectroscopy has been used extensively in the past to characterize humic substances, although some doubt exists on the usefulness of infrared spectra. The latter is perhaps caused in part by the complexity of the infrared spectra of humic preparations and by questions arising from the purity of samples (Tan, 1976b). In addition, the indiscriminate publication of poorly resolved spectra has aggravated the problem immensely (Goh and Stevenson, 1971; Schnitzer, 1971; Stevenson and Goh, 1971, 1972). In spite of the problems stated above, infrared (IR) spectra have



**FIGURE 5.23** Diagnostic infrared features of three major humic fractions.

been very useful and can positively differentiate the types of humic fractions. When used as “fingerprints,” the properly resolved IR spectra of fulvic acid, humic acid, and hymatomelanic acid are quite different from each other (Figure 5.23). Fulvic acid has a strong absorption band at  $3400\text{ cm}^{-1}$ , a weak band between  $2980$  and  $2920\text{ cm}^{-1}$ , and a shoulder at  $1720\text{ cm}^{-1}$ , followed by a relatively strong band at  $1650\text{ cm}^{-1}$ , attributed to vibration of OH, aliphatic C–H, carbonyl (C=O), and carboxyl groups in  $\text{COO}^-$  form, respectively. These IR features are confirmed by more recent IR analyses (Li et al., 2003). The strong band at  $1000\text{ cm}^{-1}$  is not necessarily caused by contamination with silica gel (Tan, 1976a,b), but many other functional groups will absorb in this region, such as ethyl, vinyl,  $-\text{CH}=\text{CH}_2$ , aromatic aldehyde, amine, and SH groups. The infrared features of fulvic acid as described above resemble closely those of polysaccharides (Mortenson, 1961). In contrast to fulvic acid, humic acid exhibits a strong absorption for C–H vibrations at  $2980$  to  $2920\text{ cm}^{-1}$ , and a stronger absorption for both carbonyl and carboxyl vibrations in  $\text{COO}^-$  form at  $1720$  and  $1650\text{ cm}^{-1}$ , respectively. Humic acid spectra have, in addition, no absorption bands at  $1000\text{ cm}^{-1}$ . Hymatomelanic acid, in turn, differs from both fulvic and humic acids by showing an infrared spectrum with very strong bands for aliphatic C–H at  $2980$  to  $2920\text{ cm}^{-1}$ , and carbonyl vibrations at  $1720\text{ cm}^{-1}$ . In addition to the functional groups just discussed for humic compounds, a number of other characteristic infrared group frequency vibrations have been detected in organic compounds. This knowledge contributes toward solving the structural chemistry of humic acids, as will be discussed in a later section. The main absorption bands of humic compounds, with their characteristic wave numbers and wavelengths, summarized in Table 5.8, can serve in identification of the respective humic fractions.

### 5.9.9.3 Magnetic Resonance Spectroscopy

Two types of spectroscopy can be distinguished in this category: (1) electron paramagnetic resonance (EPR), which analyzes electron spin resonance of large free radicals in large polymers of

**TABLE 5.8**  
**Infrared Absorption Bands of Functional Groups in Humic Compounds and Related Organic Substances**

Wave Number cm <sup>-1</sup>	Wavelength		Proposed Assignments
	μm	nm	
3400	2.94	2940	O–H and N–H stretch
3300	3.03	3030	O–H and N–H stretch
3380	2.95	2950	Hydrogen-bonded OH
3100	3.25	3250	NH <sub>3</sub> stretch
2985	3.35	3350	CH <sub>3</sub> and CH <sub>2</sub> stretch
2940	3.40	3400	C–H stretch
2920	3.42	3420	C–H stretch of CH <sub>3</sub>
2900	3.44	3440	Aliphatic C–H stretch
2820	3.55	3550	CH <sub>3</sub> and CH <sub>2</sub> stretch
2740	3.65	3650	Hydrogen-bonded OH
2610	3.83	3830	Hydrogen-bonded OH
2260	4.42	4420	Hydrogen-bonded OH
1840	5.43	5430	C=O stretch of cyclic anhydrides and mixed anhydrides
1815	5.51	5510	C=O stretch of cyclic anhydrides and mixed anhydrides
1785	5.60	5600	C=O stretch of phenols and cyclic anhydrides
1750	5.71	5710	COOH and C=O
1725	5.79	5790	C=O of carboxyl and C=O of ketonic carbonyl
1720	5.81	5810	C=O stretch of carbonyl groups
1695	5.90	5900	COOH vibrations
1680	5.95	5950	COO <sup>-</sup> antisymmetric stretch
1665	6.00	6000	Olefinic C=C
1650	6.0 to 6.2		C=O stretch (amide I)
1630	6.10	6100	Aromatic C=C, hydrogen-bonded C=O, double bond conjugated with carbonyl and COO vibrations
1613	6.19	6190	C=C and COO <sup>-</sup>
1610	6.20	6200	Conjugated C=C in ring with C=C, or C=O of open chains
1600	6.27	62700	Aromatic C=C
1590	6.29	6290	Multinuclear aromatic C=C or aromatic C=C
1575	6.35	6350	Salts of COOH
1570–1515	6.5 to 6.6		N–H deformation and C=N stretch (amide II)
1550	6.45	6450	COO <sup>-</sup> antisymmetric stretch
1510	6.62	6620	Aromatic C=C
1470	6.80	6800	Aromatic C=C
1460	6.85	6850	CC–H <sub>3</sub>
1440	6.95	6950	C–H stretch of methyl groups
1435	6.97	6970	C–H bending
1400	7.14	7140	COO <sup>-</sup> antisymmetric stretch
1390	7.20	7200	Salts of COOH
1300	7.70	7700	C=N stretch and N–H deformation (amide III)
1280	7.80	7800	C–O stretch
1267	7.89	7890	Aromatic C–O
1230	8.10	8100	C–O ester linkage and phenolic C–OH

(continued)

**TABLE 5.8 (CONTINUED)**  
**Infrared Absorption Bands of Functional Groups in Humic Compounds and Related Organic Substances**

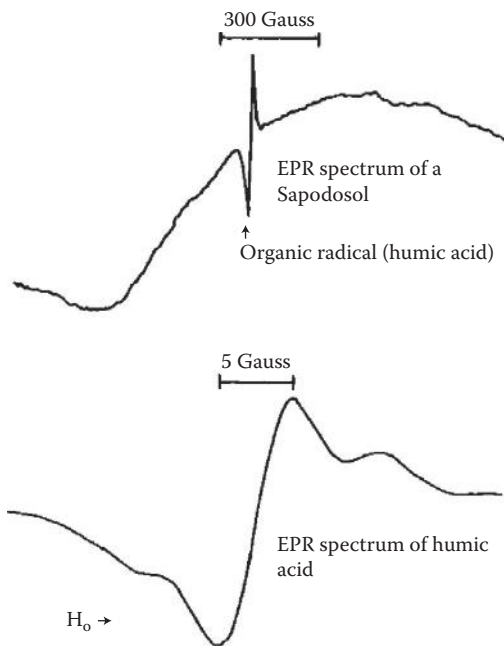
Wave Number cm <sup>-1</sup>	Wavelength		Proposed Assignments
	μm	nm	
1170-950	8.50-10.5	8500- 10500	C-C, C-OH, C-O-C typical of glucosidic linkages, polymeric substances, and Si-O impurities in humic compounds
1035	9.67	9670	O-CH <sub>3</sub> vibrations
840	11.9	11900	Aromatic C-H vibrations

Sources: Mortenson, J. L., D. M. Anderson, and J. L. White. In *Methods of Soil Analysis, Part 1*, C. A. Black, D. D. Evans, J. L. White, L. E. Ensminger, and F. E. Clark (eds.), Agronomy Series No. 9., Am. Soc. Agron., Madison, WI, 1965, pp. 743-770; Felbeck, Jr., G. T., *Adv. Agron.*, 17, 327, 1965; Schnitzer, M., and S. U. Khan. *Humic Substances in the Environment*, Marcel Dekker, New York, 1972.

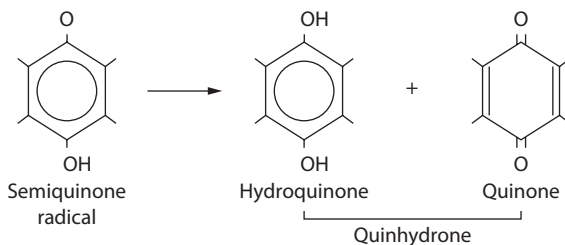
soil organic compounds, and (2) nuclear magnetic resonance (NMR), used in the beginning for determination of proton resonance in relatively small organic compounds. Both methods are based on similar principles—sample excitation by applied magnetic fields—with the difference that electron spins are excited in EPR, whereas nuclear spins are excited in NMR analysis. For a number of technical reasons and complexity, EPR methods are less widely used than NMR techniques (Weil and Bolton, 2007).

#### 5.9.9.3.1 Electron Paramagnetic Resonance (EPR)

Better known as electron spin resonance (ESR), EPR analyzes unpaired electron spins in paramagnetic organic materials. This is considered a major limitation in ESR analysis, because all electrons are paired in stable compounds (Weil and Bolton, 2007). The theory and technique are mind boggling; hence, the author tries to keep it brief and simple by stating only what is necessary for reading an ESR spectrum. Usually a sample, containing free radicals, is radiated by an external (applied) magnetic field at a fixed frequency. The spectrum, called the *first derivative*, shows only a hill and a valley with a resonance position expressed in gauss, G, or tesla, T, (1000 G = 0.1 T). Reference is made to Tan (2005) for details about these units of magnetic force. By increasing the magnetic field, the resolution is increased and the spectrum shows several lines or peaks positioned close together. This spectrum is called the *second derivative*, and a *third derivative spectrum* can also be produced with more peaks or details. The latter technique is called *high-field and high-frequency ESR analysis*, and the creation of many lines or peaks is known as *hyperfine coupling* or, more commonly, *hyperfine splitting* (Cheshire and McPhail, 2005). An ESR spectrum of a Spodosol (Podzol) and of humic acid extracted from the Spodosol is shown in Figure 5.24 as examples of a first derivative (5G) and second derivative (300G) spectrum, respectively. From these results, Steelink and Tollin (1967) and Steelink (1964) believed that humic acids exhibit paramagnetism owing to the presence of semiquinones and hydroquinones. The peak in the Spodosol curve was identified as the organic radical in the humic acid molecule, which was supported by the spectrum of humic acid. Therefore, the ESR spectra of humic acids consist of single lines with hyperfine splitting and G values ranging from 2.0031 to 2.0045, with line widths from 2 to 3.6 G (Ghosh and Schnitzer, 1980a; Riffaldi and Schnitzer, 1972). Eltantawy (1980) reported that an enhanced ESR signal (G = 2.0024) indicated the presence of larger free radical contents, but similar G values indicated that the free radicals in humic and fulvic acids were of similar structure. Schnitzer and Khan (1972) suggested that if semiquinone is present, this compound can then be made to enter in a reaction yielding hydroquinone and quinone according to the reaction as illustrated in Figure 5.25. The quinone released can be easily detected. However, chemical and spectroscopic analysis by



**FIGURE 5.24** Electron paramagnetic resonance (EPR) spectra of a Spodosol, presumably a second derivative spectrum (top), and a first derivative spectrum of humic acid extracted from the Spodosol (bottom). (From Steelink, C., and G. Tollin. In *Soil Biochemistry*, A. D. McLaren and G. H. Peterson (eds.), Marcel Dekker, New York, 1967, pp. 147–173. With permission.)

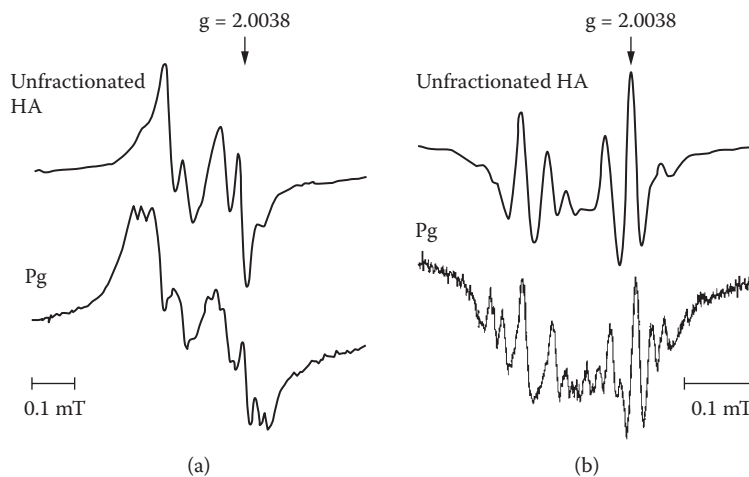


**FIGURE 5.25** The chemical reaction of semiquinone producing hydroquinone and quinone.

the latter authors failed to show any measurable quantities of quinone in solutions of degradation products of humic material. This led Schnitzer and Khan (1972) to believe that evidence presented by Steelink and Tollin (1967) for the presence of quinone groups in humic molecules was not convincing. However, Ghosh and Schnitzer (1980a) confirmed later by ESR analysis the presence of semiquinone radicals in humic substances. The free radical content in humic and fulvic acids was estimated to range from  $1.4 \times 10^{-17}$  to  $37.4 \times 10^{-17}$  spins/G (Ghosh and Schnitzer, 1980a; Senesi and Schnitzer, 1977).

Better examples of first and second derivative high-field ESR spectra of humic acids are presented by Watanabe et al. (2005), especially where the hyperfine splitting has produced spectra with excellent resolutions (Figure 5.26). The differences in spectra between the bulk (unfractionated) HA and its  $P_g$  fraction (green humic acid fraction) are quite obvious. The authors believe that the additional hyperfine components in the  $P_g$  fraction are caused by more or different radicals in the green humic acid fraction.





**FIGURE 5.26** (a) First derivative and (b) second derivative ESR spectra of bulk (unfractionated) humic acid and its  $P_g$  (green humic acid) fraction from Andosols in Japan. Note the increased resolution from (a) to (b). (From Watanabe, A., D. B. McPail, N. Maie, S. Kawasaki, H. A. Anderson, and M. V. Chesire, *Organic Chemistry*, 36(7), 981–990. Copyright 2005, with permission from Elsevier.)

#### 5.9.9.3.2 Nuclear Magnetic Resonance (NMR)

This is the second method in the category of magnetic resonance spectroscopy. It is based on the principle of placing a sample in a high magnetic field, causing the nuclei in the sample to absorb the energy—in scientific language this is called *excitation of the nuclei*. The absorbed or excess energy is radiated back at a specific resonance (vibration) frequency—hence, the name *nuclear magnetic resonance*—and is captured and detected in a graph. For more details explained in easy language, reference is made to Tan (2005). In medical science, NMR analysis is called MRI or magnetic resonance imaging, because tissue images are produced instead of the resonance frequency graphs in NMR of soils.

In its early development, NMR is capable of analyzing only the proton resonance of the humic molecules or in simpler language “analyze the hydrogen atoms.” The usefulness of such analysis in humic acid research is often questioned by several authors, because of the lack of success in obtaining  $^1\text{H}$ -NMR spectra of humic substances. However, with the rapid development in technique, new and more powerful NMR instruments are available (e.g.,  $^{13}\text{C}$ - and  $^{31}\text{P}$ -NMR) that can be used not only for humic acid research, but also for analysis of other compounds in soils. With  $^{13}\text{C}$ -NMR spectroscopy, direct measurement of the carbon signal yields a better resolution than with proton-NMR, and the chemical shifts obtained are one order of magnitude larger than those of  $^1\text{H}$ -NMR (Hatcher et al., 1980; Webb, 2003).

In the early days, the main problem was that NMR analysis required the sample to be dissolved in a suitable solvent. The solvents frequently used were  $\text{CCl}_4$  (chloroform) and  $\text{CDCl}_3$ . Humic acid, however, is usually not soluble in these reagents and must first be methylated or broken down into smaller molecules by degradation procedures. An aqueous medium (water), needed for  $^1\text{H}$ -NMR, is unsuitable for  $^{13}\text{C}$ -NMR analysis, whereas organic solvents working well for  $^{13}\text{C}$ -NMR are inappropriate for  $^1\text{H}$ -NMR. Solid samples at that time could not be used, because they interfered with magnetic interaction. Another possible solvent is  $\text{D}_2\text{O}$ , which finds application with analysis of fulvic acids. Today the use of  $\text{NaOD}$  apparently eliminated this obstacle. In addition to the foregoing problems, difficulties also arise because NMR analysis makes use of radio waves, which are low energetic forms of electromagnetic radiation. The level of energy was considered very small, but large enough to affect the nuclear spin of atoms in the nuclei of the poorly defined complex

polymers of humic acid molecules. This makes an analysis by NMR very time consuming, and even with today's machines, one analysis may take 24 hours of scanning time.

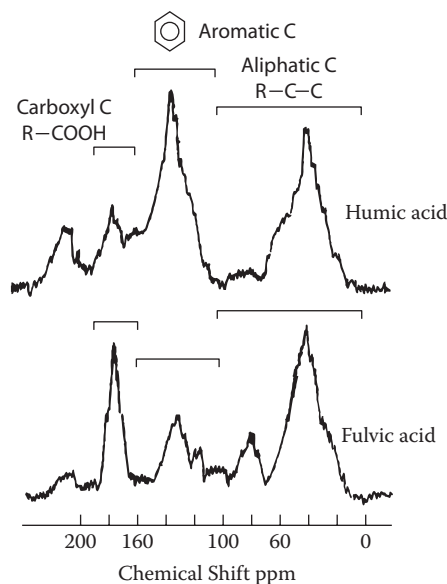
Notwithstanding these drawbacks, a great deal has been achieved in humic acid chemistry by the old NMR analyses. With the use of methylated fulvic acid dissolved in  $\text{CCl}_4$  and  $\text{CDCl}_3$ , results of NMR analysis showed the presence of functional groups, such as aliphatic C–H, O– $\text{CH}_3$ ,  $\text{CO}_2\text{CH}_3$ , phenolic–OH, and COOH (Schnitzer and Khan, 1972). These functional groups can also be analyzed easily with infrared spectroscopy and other methods. Felbeck (1965) is of the opinion that the use of NMR should be limited to organic compounds that have been defined rather completely by other techniques. Ogner (1979) succeeded in quantifying the functional groups by NMR. With methylated humic acids dissolved in chloroform and  $^{13}\text{C}$ -NMR spectroscopy, Ogner estimated that 21% of the C was aromatic, 35% in methylene chains and in methyl groups, 3% as carbonyl-C of methyl esters, and 13% of the C as methoxyl-C of methylated phenols and alcohols. The remaining 28% was not accounted for; it was suggested to be mostly C bonded to O as polysaccharides or peptides. Ogner also indicated that the  $^{13}\text{C}$ -NMR spectrum of methylated humic acid was different from those of lignin and its derivatives. More recently, Ruggiero et al. (1980) succeeded in obtaining evidence for the presence of exchangeable aromatic protons in fulvic and humic acids in their analysis using  $^1\text{H}$ -NMR spectroscopy. According to these authors, the protons in the aromatic structure of humic substances could be exchanged with deuterium. The  $^1\text{H}$ -NMR spectra enabled the proportion of exchangeable protons, expressed as percentage of total aromatic protons, to be measured. The estimated exchangeable proton concentrations were  $18 \pm 7\%$  in humic acid and  $35 \pm 10\%$  in fulvic acid.

Currently, NMR spectroscopy is considered an essential tool in the analysis of humic matter. It is capable in differentiating different types of humic matter or humic matter derived from different origins. The disadvantage of NMR spectroscopy is that the instruments are expensive. Nuclear magnetic resonance analyses can be performed with both liquid and solid samples of humic matter. With the very powerful instruments available today, *cross-polarization magic-angle-spinning carbon-13 NMR*, better known as *CP-MAS  $^{13}\text{C}$ -NMR*, spectroscopy, produces better spectra with solid than with liquid samples of humic acids. Magic-angle spinning is a technique by which a sample is rapidly rotated at an angle of  $54.7^\circ$ , known as the *magic angle*, in order to decrease line broadening of the spectrum. For the detection of small amounts of low-sensitivity nuclei cross-polarization together with MAS is now the preferred method. However, others believe that the use of *hyperpolarization* in the modern high-field spectrometers can increase further the effectiveness of NMR analysis. In addition to CP MAS, RAMP CP (ramped amplitude cross-polarization) and CP TOSS (cross-polarization total side band suppression) are used. The latter two are reported to give better results for analyses in the solid state (Aliev and Law, 2003; Cook and Langford, 1998; Dria et al., 2002).

Soil samples can be used in the undisturbed state, provided the sample contains sufficient amounts of organic matter. The NMR spectrum of humic matter is commonly divided into three major regions (Hatcher et al., 1980; Li et al., 2003):

1. Aliphatic C region, at 0 to 105 ppm chemical shift; a polysaccharide subregion is often distinguished from 65 to 105 ppm.
2. Aromatic C region, at 105 to 165 ppm chemical shift.
3. Carboxyl C region, at 165 to 185 ppm chemical shift.

An example of NMR spectrograms with the major divisions above is shown in Figure 5.27. Humic acid in the solid state, extracted from lignite and soil, yield signals that are very sharp in intensity. The intensity of the signals for aliphatic, aromatic, and carboxyl C may vary considerably, depending on origin (differences in soils) and type of humic matter analyzed. Fulvic acid exhibits a spectrum dominated by the signals for aliphatic C, whereas the signals for aromatic C are often manifested as very weak signals (see Figure 5.27). The composition of fulvic acid from aquatic humic matter is



**FIGURE 5.27** Solid-state cross-polarization magic-angle-spinning carbon-13 nuclear magnetic resonance (CP-MAS  $^{13}\text{C}$ -NMR) spectra of humic acid and fulvic acid extracted from lignite.

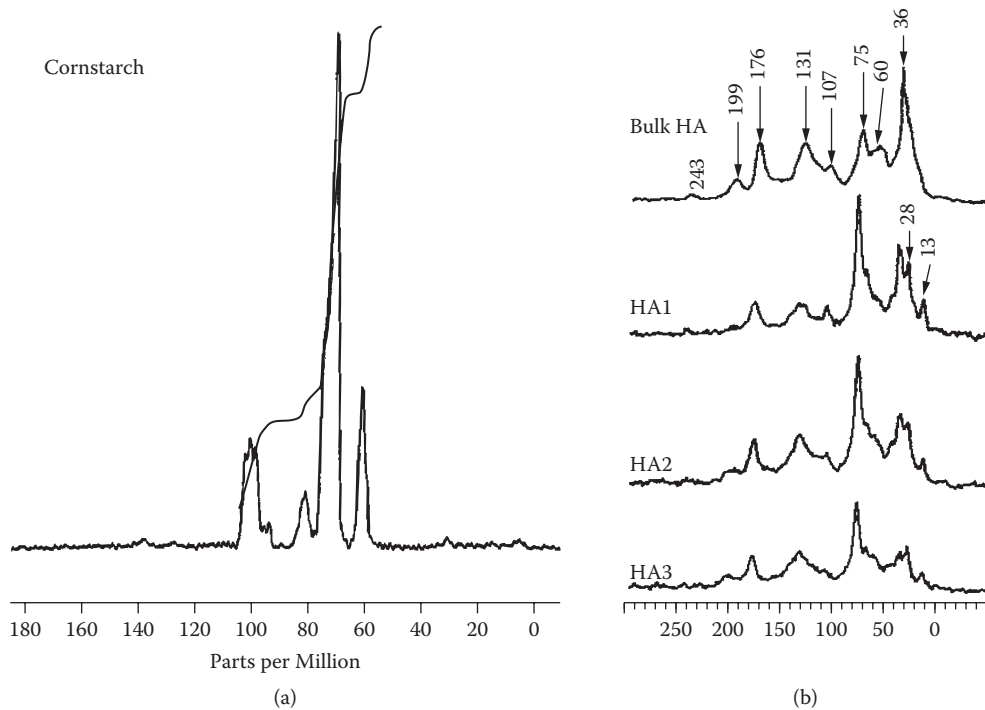
especially dominated by the aliphatic groups (Tan, 2005). This carbohydrate-like feature of fulvic acid is supported by the NMR analysis of a humic substance from a volcanic soil in Italy, identified by Conte et al. (2006) as humic acid. Their spectra of bulk humic acid and its HPSEC fractions 1 to 11 show the carbohydrate signals progressively dominating from fraction 1 through 11 (Figure 5.28). Apparently, what Conte et al. (2006) call humic acid was most likely fulvic acid.

The peak resolution forms the basis for calculating the group composition in percentages by integration of the spectrum. The data in Table 5.9 show that lignite is more aliphatic in nature than its extracted humic acid fraction, which is high in aromatics. In general it is noted that geologic humic acid is more aromatic in nature than aquatic or terrestrial humic acids. Fulvic acid is highly aliphatic, and the data also testify that the composition of soil fulvic acid resembles closely that of aquatic (black water) fulvic acid. This suggests that fulvic acid in black water, streams, and swamps of the southeastern United States are allochthonous in nature (Tan et al., 1990).

In addition, NMR spectra can serve as fingerprints in the study of humic compounds. The present authors used this concept in NMR (Figure 5.29) to study adsorption of fulvic acids by soils. Fulvic acid, extracted from poultry litter, exhibits an NMR spectrum composed of at least four peaks (Figure 5.29, top). After shaking the fulvic acid solution with soil, the remaining supernatant is sampled and analyzed again. The NMR spectrum is shown at the bottom part of the figure. It can be noticed that peaks 1, 2, and 3 have decreased sharply in intensity, whereas peak 4 has disappeared. This result suggests that the concentration of some of the fulvic acid components in solution has been decreased because of adsorption by soil.

### 5.9.10 ELECTRON MICROSCOPY OF HUMIC MATTER

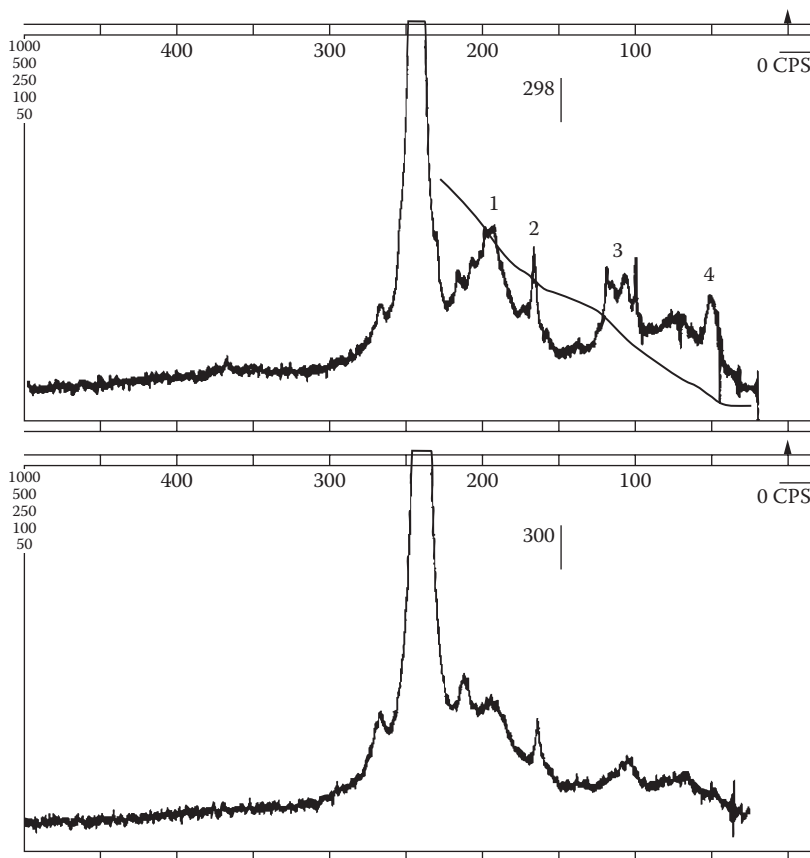
Flaig and Beutelspacher (1951) were perhaps among the first who tried electron microscopy in the study of humic acids. This method, which enjoyed considerable success in clay mineralogy, was used to analyze the morphology and dimension of humic particles. Employing transmission electron microscopy, Flaig and Beutelspacher found that humic acids occurred as very small spherical particles, of the order of 100 to 150 Å (10 to 15 nm) in diameter. The spheres frequently joined together in



**FIGURE 5.28** Evidence of the presence of polysaccharides in the humic acid fractions of Conte et al. (2006). (a) Solid-state cross-polarization magic-angle-spinning carbon-13 nuclear magnetic resonance (CP-MAS  $^{13}\text{C}$ -NMR) spectrum of polysaccharide (cornstarch), analysis. (D. Himmelsbach, U.S. Department of Agriculture Agricultural Research Service, Athens, GA.) (b) Solid-state CP-MAS  $^{13}\text{C}$ -NMR of bulk HA (humic acid) and its eluted high-performance size-exclusion chromatography (HPSEC) fractions HA1, 2, and 3 from Conte and coworkers. Only three of the 11 fractions are shown here. The main NMR signal at 60 to 80 ppm was shown to increase in intensity from HA3 to HA1 and was the dominant signal of the spectra. (From Conte, P., R. Spaccini, and A. Piccolo, *Anal. Bioanal. Chem.* 386(2), 382–390, 2006. With permission.)

**TABLE 5.9**  
**Aliphatic, Aromatic, and Carboxyl C Content of Lignite, Its Humic Acid Fraction, and Humic Acid Extracted from Soils and Black Water from Streams in the Southeastern United States**

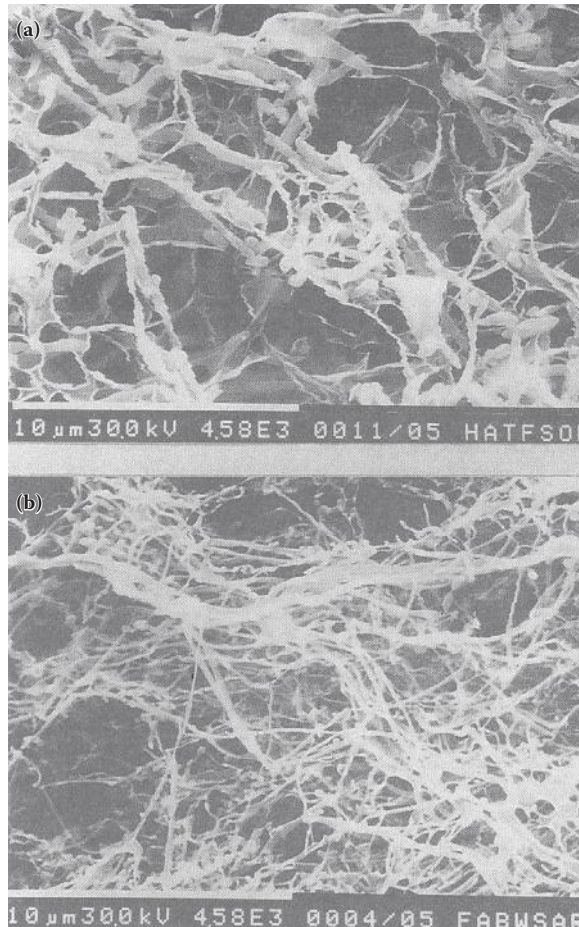
Materials	Aliphatic C (%)	Aromatic C (%)	Carboxyl C (%)	Aromaticity (%)	Aliphaticity (%)
Lignite	63.3	30.6	6.1	32.6	67.4
<b>Humic Acid</b>					
From lignite	27.2	63.8	9.0	70.1	29.9
From soil	37.3	51.6	11.1	58.0	42.0
<b>Fulvic Acid</b>					
From lignite	45.7	34.9	19.4	43.4	56.6
From soil	61.6	20.7	17.7	25.2	74.8
Black water	61.6	22.3	16.1	26.6	73.4



**FIGURE 5.29** Nuclear magnetic resonance (NMR) analysis of fulvic acid extracted from chicken manure, before (top) and after (bottom) adsorption by Cecil (Ultisols) surface soil.

racemic chains. A more recent report on transmission electron microscopy (TEM) studies of HA and FA indicated that in dilute aqueous solutions, humic acids form small spheroids 9 to 12 nm in diameter, connected by long multibranching fibers, 20 to 100 nm in width (Stevenson and Schnitzer, 1982).

Scanning electron microscopy (SEM) has also become an important tool for the investigation of shape, size, and degree of aggregation of fulvic and humic acids and their complexes (Chen and Schnitzer, 1976; Dormaar, 1974). This method has the advantage over the standard TEM by furnishing a three-dimensional picture with a resolution depth of 5 to 10  $\mu\text{m}$ . In addition, humic particle surfaces and orientation can be observed. Several methods have been proposed for sample preparation to avoid altering or damaging the original structure of humic molecules. Chen and Schnitzer (1976) used a freon-liquid  $\text{N}_2$  freezing technique for their SEM analysis. Humic solutions were first frozen on mica sheets or glass slides and then transferred to a sample holder for scanning. Their SEM micrographs showed that protonated fulvic acid (adjusted to pH 2 to 3) exhibited an open structure, formed from elongated fulvic acid strands or fibers with rounded or spherical tips. The structure changed into a sponge-like structure if the pH of fulvic acid was adjusted to 7, whereas at pH 9, fulvic acid revealed homogeneous sheets in which grains were visible. A few years later, Gosh and Schnitzer (1980c) reported that not only the pH, but also the ionic strength and sample concentration may influence the macromolecular structures of humic acids. They believe that at high concentration and low pH, or at medium pH with high ionic strength, humic acids behave as rigid spherocolloids but were otherwise flexible linear colloids. A revised procedure for SEM preparation of samples by rapid freeze-drying in liquid  $\text{N}_2$  was introduced by Tan (1985). To make



**FIGURE 5.30** Scanning electron micrographs of humic and fulvic acids prepared by the revised rapid liquid  $N_2$  freeze-drying method of the current author: (a) humic acid extracted by the NaOH method from a Tifton soil (Ultisol) in south Georgia; and (b) fulvic acid isolated by the XAD-8 resin method from black water of the Satilla River in south Georgia.

the procedure simpler and faster, the use of freon gas and prior preparation on glass slides or mica strips were deleted. The liquid HA sample was immediately placed on a SEM sample stub (holder) and frozen quickly in liquid  $N_2$ . The frozen sample was dried in a vacuum evaporator at room temperature, and a high vacuum ( $6.5 \times 10^{-10}$  MPa) was maintained for 12 h. This method was adapted from preparation of animal tissue for surface SEM and seemed to be less affected by pH or ionic strength. The results (Figure 5.30) of the modified rapid liquid  $N_2$  technique were similar, if not substantially better, than the fibrous-like structure obtained by the freon–liquid  $N_2$  method by Chen and Schnitzer (1976).

### 5.9.11 STRUCTURAL CHEMISTRY OF HUMIC ACIDS

Several hypotheses were reported on the structural chemistry of humic acids, but apparently the hypotheses lack desirable uniformity and a lot of disagreement still exists.



### 5.9.11.1 The Hypothesis of Schnitzer and Khan (1972)

This hypothesis is based on information obtained from chemical degradation of fulvic acids. Degradation reactions do not ensure that artifacts may not have been produced. Depending on the severity or mildness of the reactions applied, any breakdown product can be obtained, ranging from elemental C, H, O, and benzene rings to heterocyclic rings. Schnitzer and Khan are of the opinion that humic substances must be broken down into smaller subunits to study their structural chemistry. Thus far, four basic types of degradation procedures have been used:

1. Oxidation with alkaline permanganate, nitric acid,  $H_2O_2$ , or  $CuO-NaOH$  mixture. The degradation products were invariably benzene carboxylic acids.
2. Reduction with Na amalgam or with Zn dust. Fulvic acid also yielded benzene derivatives with this method.
3. Hydrolysis with hot water, with acids or bases. Fulvic acid yielded benzene derivatives, such as hydroxybenzoic and vanillic acids.
4. Biological degradation. This is a method by which fulvic acid is decomposed with the aid of microorganisms (e.g., *Penicillum* sp., *Aspergillus* sp., *Trichoderma* sp.). The compounds produced from fulvic acid by biological degradation were also identified as benzene derivatives.

On the basis of the predominant findings of benzene derivatives (Figure 5.31), Schnitzer and Khan (1972) assume that fulvic acid is composed of phenolic and benzene carboxylic acids, joined together by hydrogen bonds to form a polymeric structure. The latter contains many voids or openings in which other organic compounds can be trapped, such as amino acids and carbohydrates.

### 5.9.11.2 The Hypothesis of Kononova (1961)

Kononova is of the opinion that at least three basic steps are involved in formation of humic acids: (1) formation of structural units from the decomposition of plant tissues, (2) condensation of these units, and (3) polymerization of the condensation products. The result is a multicomponent system, called humic or fulvic acids. They show similar structural patterns but may differ in details of structural and chemical composition; for example, fulvic acid has a less condensed aromatic nucleus but has more highly developed peripheral components. In Kononova's opinion fulvic acid can be both the predecessor and the decomposition product of humic acid.

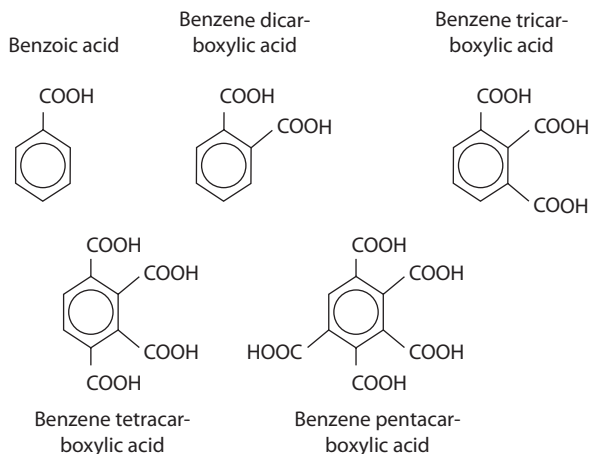
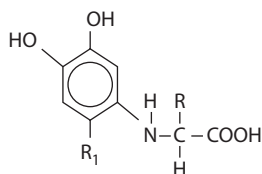


FIGURE 5.31 Benzene carboxylic derivatives produced by degradation of fulvic acids.





**FIGURE 5.32** Structural hypothesis of Kononova.

The basic structural units of humic compounds are considered to be phenolic or quinoid, bonded to nitrogen-containing compounds and carbohydrates, the latter chiefly polyuronides. The inclusion of N-containing compounds and carbohydrates as fundamental units of the humic molecule is a matter of much controversy at that time. Several investigators regarded the latter as accidental contaminants trapped in the maze work of the humic structure (Burges, 1960; Schnitzer and Khan, 1972), but others supported Kononova's theory for the necessary participation of carbohydrates and N compounds in the formation of humic acid (Flaig et al., 1975). Kononova (1961) suggests that the following reaction occurs for the inclusion of N in the humic molecule (Figure 5.32). Such a combination produces a stable condensation product of phenols and  $\alpha$ -amino acids, which increases the stability of N in acid hydrolysis.

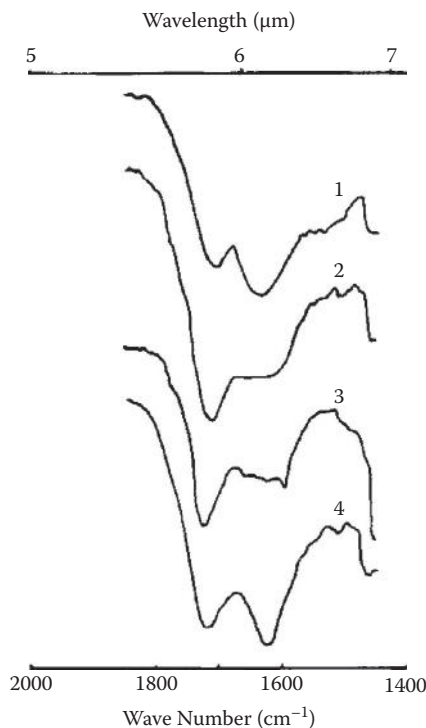
Several authors disagree on including carbohydrates in the humic molecule. They are of the opinion that carbohydrates are contaminants that can be removed by adequate purification methods. Notwithstanding these arguments, various research reports (Clark and Tan, 1969; Tan, 1975; Tan and Clark, 1968) point to the discovery of polysaccharides as an integral part of the humic molecule. Fulvic acid appears to be composed of large amounts of polysaccharides, whereas humatomelanic acids have been identified as polysaccharide esters. Infrared spectroscopy of humatomelanic acid shows a characteristic strong absorption between 3000 and 2800, and at  $1720\text{ cm}^{-1}$ , the latter is usually accompanied by a weak shoulder at  $1620\text{ cm}^{-1}$  (Figure 5.33). These absorption features can be reproduced artificially, or closely simulated by methylation of humic acid. In addition, the infrared absorption of humatomelanic acid at  $1620\text{ cm}^{-1}$  can be increased considerably in intensity by separation of the ester group through hydrolysis of the compound with  $2\text{ N NaOH}$ . The latter procedure removes the blocking effect of the ester group on the carboxyl vibration in  $\text{COO}^-$  form. Identification of the ester fraction reveals a compound with infrared features similar to that of a soil polysaccharide (Mortenson, 1961). Ogner indicated that polysaccharides in humic compounds were highly branched and complex in composition. They contained at least 34 different aldose building units, in addition to *o*-methyl, di-*o*-methyl, amino derivatives, ketones, and uronic acids. Generally, polysaccharides of fulvic acids were comparatively less branched than those of humic acids.

### 5.9.11.3 The Hypothesis of Flaig (1975)

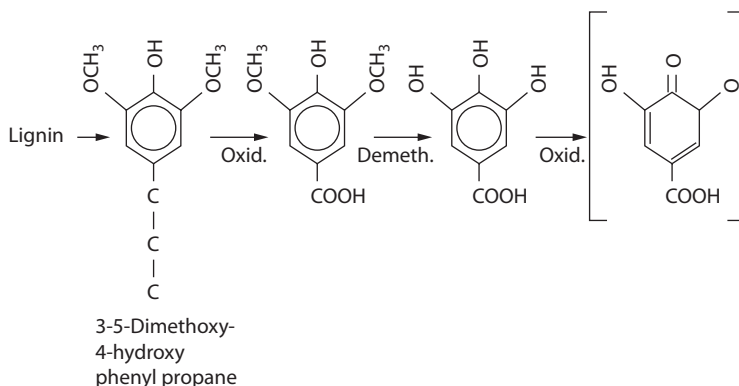
Flaig and coworkers (Flaig et al., 1975) suggest lignin to be the source, or starting point, for the formation of humic and fulvic acids. Lignin is assumed to be broken down by degradation or decomposition reactions into its basic units (i.e., coniferyl alcohol or guaiacyl monomers). These lignin basic units are subject to oxidation, followed by demethylation to substituted polyphenols and further oxidation to quinone derivatives (Figure 5.34). Condensation of the quinone groups with amino acids and polysaccharides may then yield humic acid-like substances. Lignin degradation products have been detected in hydrolysates of humic acids. This theory is known as the *lignoprotein theory*.

### 5.9.11.4 The Dimer Concept of Stevenson (1994)

Stevenson (1994) is of the opinion that humic substances can be formed by all the mechanisms discussed in the previous sections. The lignoprotein theory, the polyphenol theory, or benzene carboxylic and the sugar-amine condensation theory, all contributed to building up the complex structure of a humic molecule. A large number of precursor molecules take part in the condensation reaction,



**FIGURE 5.33** Infrared spectra of humic fractions, showing absorption attributed to carbonyl ( $\text{C}=\text{O}$ ,  $1720\text{ cm}^{-1}$ ) and carboxyl ( $\text{COO}^-$ ,  $1625\text{ cm}^{-1}$ ) groups: (1) purified humic acid; (2) hyatomelanic acid; (3) methylated humic acid; and (4) hyatomelanic acid, after removal of the ester group. (From Tan, K. H., and R. A. McCreery, *Commun. Soil Sci. Plant Anal.*, 1, 75–84, 1970b. With permission from Taylor & Francis Group. <http://www.informaworld.com>.)



**FIGURE 5.34** The ligno-protein theory of Flaig.

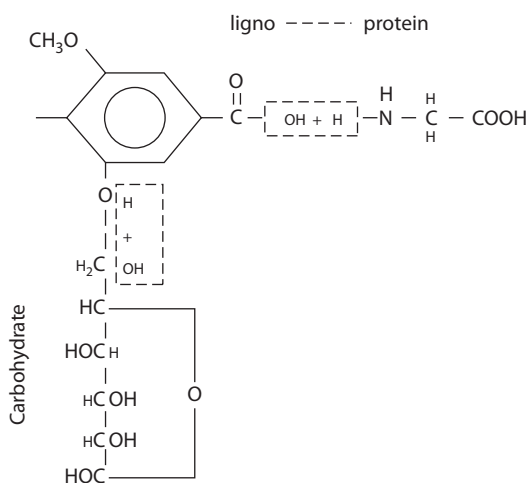
which can result in a variety of combinations. To simplify this extremely complex structural problem, Stevenson proposes the *dimer concept*. According to this concept, the core of a humic molecule consists of four building blocks: (1) a dimer, formed by coupling of two lignin monomers; (2) a phenol–amino acid complex; (3) a hydroxyquinone; and (4) a  $\text{C}_6\text{--C}_3$  unit of lignin. These building blocks have the roles of cards from a *deck* of structural units, and their combination leads to a great

variety of core structures of humic matter. Stevenson's humic acid structure quoted in many books does not show specifically the dimer concept described above.

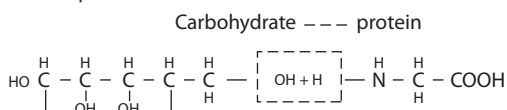
### 5.9.11.5 The Author's Hypothesis

Among the different opinions existing on the origin and structure of humic matter, there is agreement that phenolic (benzene-like) groups and nitrogen compounds are the building blocks of humic matter. This concept is reflected in the lignoprotein theory, which differs only slightly from the hypothesis derived from oxidation and degradation research on humic compounds. Oxidation of humic acids yields phenols and a series of phenol-carboxylic acids, which form humic acids by condensation and polymerization (Schnitzer and Khan, 1972). The general opinion is that humic acid cannot be described in definite chemical terms, though current research data indicate otherwise. Results of  $^{13}\text{C}$ -NMR analyses suggest the presence of a consistent structural composition, including (1) aliphatic, (2) aromatic, and (3) carboxyl compounds. Infrared spectroscopy also provides evidence for only one basic structure related to the presence of aliphatic C–H, carboxyl, and phenolic–OH functional groups. In addition, the elemental composition is fairly consistent with C content varying only from 40% to 60%, H from 4% to 5%, N from 1% to 5%, and S from 0.2% to 0.3%. For all the above reasons, the present author proposes the following basic structure for the smallest possible molecule of terrestrial and aquatic humic acids (Figure 5.35). The aromatic nucleus can vary depending on the type of the lignin monomer. The figure also shows the possibility of adding a carbohydrate molecule to the aromatic nucleus. The latter is of importance for the structure of fulvic acids, because fulvic acids contain less N and more carbohydrates, as noticed from both NMR and infrared analysis. Because the basic structure of a humic molecule, as just outlined, can repeat itself in any direction, it is, therefore, comparable to a *unit cell* in clay mineral structures. A more complex structure can then be built by combining several units of the basic molecule, or by

Terrestrial humic matter



Aquatic humic matter



**FIGURE 5.35** Proposed basic structure, or *unit cell*, of a humic molecule. Top: ligno-protein structural unit of terrestrial humic substances. Bottom: carbohydrate-protein structural unit of aquatic humic substances.

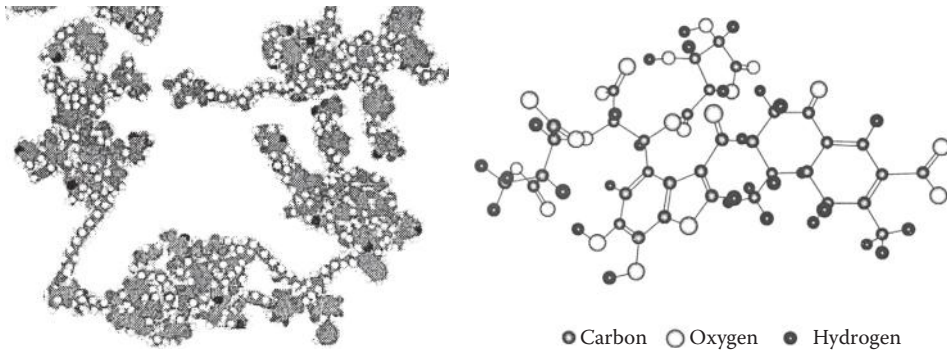
adding other compounds to the aromatic nucleus. In the formation of a more complex structure, two aromatic units (nuclei) can combine together, and this then is comparable with the dimer structure as proposed by Stevenson (1994). When three or more aromatic units are assembled together by any process in soils, the assemblage can be called a trimer or polymer or even aggregate for coping with the new theory of supramolecular structures.

#### 5.9.11.6 The Supramolecular Assemblage of Piccolo (2002)

This concept evolved from the study and deduction of literature data by Piccolo and coworkers, as discussed in Section 5.9.11.2. In a court of law, such reasoning is called “inferences based on *circumstantial evidence*.” Results of experimentations and laboratory analyses backing up or justifying the reasoning, when presented, will be more than compelling to appease many opponents. As stated before, the concept of *supramolecular complexes* has been known for some time and is also applied in metal–ligand interactions (see Section 5.9.1.2). In addition, formation of clusters, aggregates, or assemblages in a natural setting is more common than many soil scientists would have expected. For example, this is the self-assembling mechanism of soil structure, known in soil science as aggregation of soil components. In soil structure formation, all or any soil components can participate in creating a soil structural unit or assemblage. Therefore, as indicated properly by Sutton and Sposito (2005), any biomolecular fragment from the decomposition of plant materials—be it carbohydrate, polysaccharide, or peptide—must be included in assembling the humic molecule association. They believe that such an inclusion does not conflict with the refractory nature of humic substances. It may even support the hypothesis that one part of the humic components is stable, whereas the other part is transient.

#### 5.9.11.7 The Issue of Pseudostructures and Molecular Modeling of Humic Matter Structures

In the sections above, it is indicated that a number of scientists believe that at the current stage many factors make it impossible to create a molecular structure that truly defines a humic substance (Piccolo, 2002). Nevertheless, a great number of scientists presented a variety of structural concepts that have been criticized for not representing an accurate molecular structure. They are just structural models showing only molecular components thought to be present in humic substances. But, the fact is that a range of well-established and tested chemical units or blocks are available to build up a molecular structure. Simple structural units are, for example, polyphenols, bi- and triphenyls, alkyl chains, and many other biologically derived units. Nonetheless, several critics suggest to name the derived structure *pseudostructures* (Essington, 2003), which they define as hypothetical structures containing elemental and chemical components and functional group features consistent with the observed composition, mass, and other properties obtained from pyrolyses, NMR, and mass spectrometry. This idea was first presented perhaps by Hatcher et al. (1981, 1994), who created simple two-dimensional (2D) diagrams of structures of humic substances. This was followed later by a more sophisticated computer-enhanced three-dimensional (3D) structural modeling by Schulten and Schnitzer (1993, 1995). Schulten and coworkers at the Institute of Soil Science, University of Rostock, Germany, contributed since then series of 3D computer-enhanced structures (Schulten and Leinweber, 2000; Tan, 2003). The latter are very elaborate and state-of-the-art structural models as shown in Figure 5.36, where a simpler model by Kubicki and Apitz (1999) is included for comparison. The model of Professor Peter Leinweber on the left is composed of three humic acid molecules linked together by aliphatic C–H chains. The molecule has a formula composition of  $C_{6932}H_{7662}O_{1970}N_{110}$  (Schulten and Leinweber, 2000). The one shown by Kubicki and Apitz (1999) as comparison on the right is less complex and is also a smaller molecule, because it is supposed to be a pseudostructure of fulvic acid.



**FIGURE 5.36** Computer-enhanced 3D (three-dimensional) models of the structures of humic substances. (Left) Humic acid structure—white balls = H, gray balls = C, and black balls = N—according to the concept of Schulten and Leinweber. (From Schulten, H. -R., and P. Leinweber, *Biol. Fertil. Soils*, 30, 399–432, 2000. With kind permission from Springer Science.) (Right) Fulvic acid pseudostructure according to Kubicki and Apitz. (From Kubicki, J. D., and S. Apitz, *Org. Geochem.*, 30, 911–927. Copyright 1999, with permission from Elsevier.)

### 5.9.12 THE AGRICULTURAL, INDUSTRIAL, AND ENVIRONMENTAL IMPORTANCE OF HUMIC ACIDS

Humus and humic substances are very important soil constituents. Depending on climatic conditions and cultural practices, the humus content of soils often stabilizes at a fairly definite amount. In the southern region of the United States, with a prevailing subtropical climate, soil humus content seldom exceeds 3.5% (Tan et al., 1975b), and the carbon/nitrogen (C/N) ratio usually narrows down in a humification process from a value in excess of 20 for fresh material to a value of 8 to 20 for humus. In the semihumid regions of the Mollisols, the humus content stabilizes at values between 6% and 10%. This is the amount in balance with the environmental factors contributing to formation and decomposition of soil humus.

The effect of soil organic matter on plant growth has been known for some time, but only recently has this effect been credited to humic compounds. Together with soil clays, the humic substances are responsible for many chemical activities in soils. They enter into complex reactions and may influence the growth of plants indirectly and directly. Indirectly, they are known to improve soil fertility by modifying physical, chemical, and biological conditions in soils. In soil physics, the indirect effects of humic acids are noted for increasing soil aggregation and water-holding capacity, and in improvement of aeration and permeability. Chemically, humic acids increase the cation exchange capacity in soils, providing in this way to the soil a stronger buffer capacity for resisting sudden drastic chemical changes. The latter is very important also from an environmental standpoint. A lot of material may be added to soils by agricultural, industrial, and domestic operations. Several of the compounds are hazardous to humans and animals. They may leach with the percolating waters and may pollute the groundwater. The presence of humic acids with their huge cation exchange capacity will intercept a variety of pollutants trickling down the soil with the percolating water before they reach the groundwater.

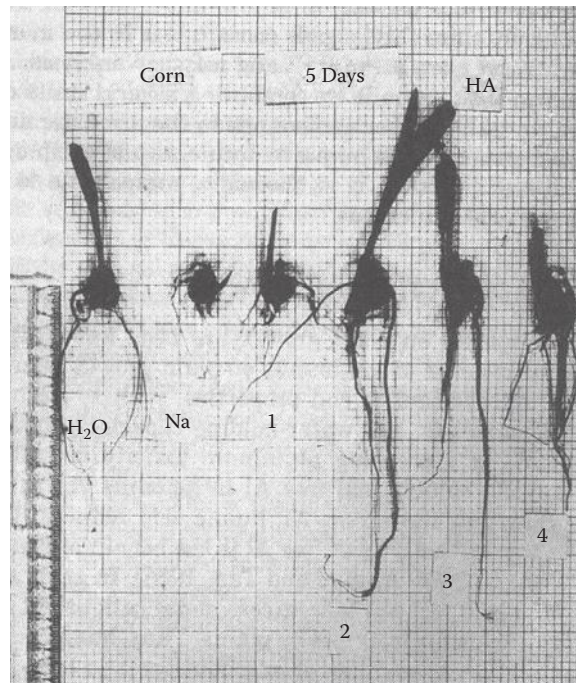
Humic acids are also capable of decreasing metal toxicity in soils. Acidic soils may contain soluble and free Al ions in amounts toxic for plant growth. By chelating the excess Al, humic acid reduces the concentration and chemical activity of free Al ions to the benefit of plant growth (Ahmad and Tan, 1986; Tan and Binger, 1986). In general, adding humic acids to acid soils can take excess metal cations out of the solution and store them in chelate form for later use by plants. Thus, humic acid prevents the buildup of excessive amounts of micronutrients in the soil, and, at the same time, releases them back in amounts suitable for plant growth.

With the increased knowledge of soil organic matter, and in particular, of humic acid chemistry, starting a few decades ago, increasing amounts of information have been accumulated on the direct

influence of soil organic matter and humic acids on plant growth. Unconfirmed reports mention that nucleic acids, protein, and small degradation products of humic acids can be taken up by plants (Flaig, 1975). Organic compounds, such as acetic, propionic, butyric, and valeric acids, are believed to increase root growth only when they are present in combination. Alone, they have no effect, as studied by Wallace and Whitehand (1980) with root elongation of wheat seedlings on agar media. Humic acid molecules are reported to penetrate the root membranes by way of *depolymerization* or *depolycondensation* (Burns, 1986; Dell'Agnola and Nardi, 1986). Roots have been noted to cause a considerable reduction in pH of the soil rhizosphere by releasing organic acids. These root exudates, such as oxalic, fumaric, malic, citric, and succinic acids, act as depolycondensation agents on humic acids. Evidence is presented by Dell'Agnola and Nardi (1986) that the addition of acetic acid to pH 2.5 causes the transformation of high molecular weight humic acid into humic acid fractions with molecular weights <5000. However, it is also noted that depolycondensation reactions are reversible and that the transformation is strictly dependent on the presence of organic acids and low pH values. The direct effect of humic compounds on improving plant growth is almost endless, and the space is too limited to discuss that in this section. Almost any important aspect in plant growth seems to be affected beneficially, though in a few instances harmfully. In summary, it can be stated that humic compounds and the like can improve plant growth directly by accelerating *respiration*, by its effect on *proteosynthesis*, and by increasing water and nutrient uptake and yields of plants. Humic acids are also assumed to increase the chlorophyll content of green plants, and hence, can be used to control chlorosis and improve photosynthesis. Humic acids can provide protection against growth-inhibiting (toxic) substances introduced in the soil (Visser, 1986). Most of the investigations with humic acids, limited to studying seed germination, shoot growth, and elongation of very young seedlings or elongation of excised roots *in vitro*, show the presence of a hormonal growth effect (Poapst et al., 1970, 1971). On the other hand, work done on nutrient uptake by Guminski and others in East Europe (Guminski, 1957; Guminski et al., 1977) and by Dormaar (1975) in Canada reveals the physiological influence of humic acids on plant growth. From studies on the growth and nutrient uptake of corn plants (*Zea mays* L.), Tan and Nopamornbodi (1979) came to the conclusion that humic acid affected plant growth through a combination of the aforementioned processes. As can be noticed from Figure 5.37, moderate amounts of humic acid were generally beneficial for root and shoot growth of corn plants. At the same time, a significant increase in N content of shoots of corn seedlings was obtained. Dry matter production also appeared to be stimulated by moderate amounts of humic acids. Information presented by Visser (1986) supported the observation that humic acids increased N content of plants. In the presence of humic acids, uptake of N by plants increased, even up to concentrations normally considered toxic to plant growth. Humic acids were also credited to enable plants to utilize nitrogen present at concentrations normally too low for optimum growth and yield.

In contrast to the above, few studies have been completed on the effect of humic acids on the biological properties of soils. Humus and humic acids are always considered the main source of food and energy for soil microorganisms, but not much is known of the interaction between humic acids and microbial life in soils. This is perhaps caused by the biochemical heterogeneity and complexity of the system. Some information is available on the interaction of clay minerals with microbial cells (Burns, 1986). Clay minerals are negatively charged, but so are microbial cells; hence, they would repel each other. However, Burns believes that at very close range, *van der Waals forces* will be more effective than the repulsive force created between the clay surfaces and microbial cells. Strong adsorption can also be assisted by extracellular protrusions of the microorganisms, such as pili or flagella. These organisms may form more or less permanent bonds with the clay surface by the production of sticky extracellular compounds, such as polysaccharides and peptides. Humic acids, on the other hand, have charges determined by the dissociation of their functional groups, as discussed in previous sections. These charges are pH dependent and are better suited for attracting microorganisms. The enzymes produced by microorganisms are very important in the depolymerization of high molecular weight compounds, such as humic acids. To function properly, the enzyme must be present in an active state, and this is achieved by getting adsorbed through chelation and





**FIGURE 5.37** Germination and growth of 5-day-old corn seedlings, as affected by humic acid: (H<sub>2</sub>O) 0 ppm HA, (Na) blank + 0.66 mEq NaOH, (1) 320 ppm HA, (2) 640 ppm HA, (3) 1600 ppm HA, (4) 3200 ppm HA. The corn was grown in a modified Hoagland solution to which the HA treatments were applied. (Adapted from Tan, 1978b; Tan, K. H., and V. Nopamornbodi, *Plant Soil*, 51, 283, 1979.)

interactions with humic acids. Adsorption of enzymes by humic acids leading to their accumulation in soils was discussed earlier. Once secreted in the soil solution, enzymes are generally unstable due to rapid degradation and denaturation. However, in the forms of chelates, the humo-enzymes are resistant to proteolytic attack and high temperatures, and hence retain their enzyme activity. The depolymerization process of humic acids is considered an essential process for releasing much of the nutrient elements, contained in the humic molecule, into the soil solution for microbial and plant uptake. As such, this process is then a form, or a precursor, of the decomposition process of soil organic matter.

Humic compounds also participate in soil formation and play an important role, especially in the translocation or mobilization of clays, aluminum, and iron, giving rise to the development of argillic and spodic horizons. This will be discussed in more detail in Chapter 10 on soil chemistry and soil formation. In industry, humic acids and related compounds find application for use as drilling muds for oil wells and as emulsifiers. Because of the importance in industry and in soil fertility, humic acids are produced on a large scale for use as a soil amendment, soil conditioner, emulsifier, or as a carrier of micronutrients. Extensive deposits of lignites, also called leonardites, in Texas, New Mexico, North Dakota, and Idaho, form the sources for the commercial production of *humates*, the name used for humic acid products in the U.S. market (Lobartini et al., 1992).



---

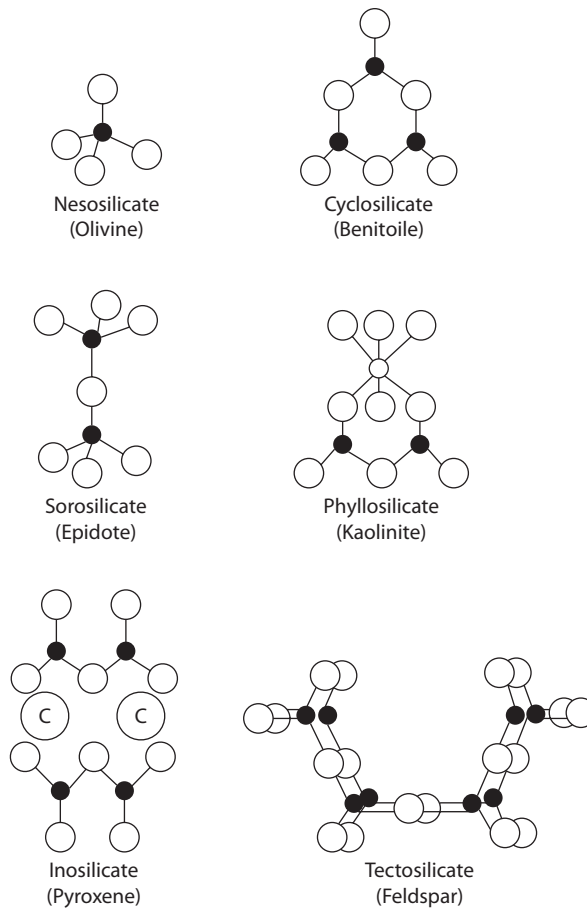
# 6 The Colloidal Chemistry of Inorganic Soil Constituents

## 6.1 THE CLAY FRACTION OF SOILS

The inorganic fraction of soils is composed of rock fragments and minerals of varying size and composition. They are sometimes distinguished into primary and secondary minerals. *Primary minerals* are, by definition, rock-forming minerals that are present in soils chemically unchanged, whereas *secondary minerals* are minerals that have been formed by weathering of primary minerals. But this distinction creates problems, because secondary minerals may well be regarded as primary on a pedological basis. On the basis of size, three major inorganic soil fractions are usually recognized: (1) the coarse fraction (2 to 0.050 mm) called *sand*, (2) the fine fraction (0.050 to 0.002 mm) called *silt*, and (3) the very fine fraction (<0.002 mm) referred to as *clay* (Soil Survey Staff, 1975, 2006). In soil science, we are used to considering clay as a colloid, although strictly speaking only the fine clay fraction <0.2  $\mu\text{m}$  is colloidal clay. Materials coarser than sand, like rocks and gravel, may also be present in soils, but they are usually not considered soil constituents, except iron concretions. However, they may form sand, silt, and clay upon weathering. Despite the variability in composition, the inorganic fractions are predominantly silicates and oxides. Six types of soil silicates are usually recognized on the basis of the arrangement of the  $\text{SiO}_4$  tetrahedra in their structure:

1. Cyclosilicates—Closed rings or double rings of tetrahedra ( $\text{SiO}_3$ ,  $\text{Si}_2\text{O}_5$ )
2. Inosilicates—Single or double chains of tetrahedra ( $\text{SiO}_3$ ,  $\text{Si}_4\text{O}_{11}$ )
3. Nesosilicates—Separate  $\text{SiO}_4$  tetrahedra
4. Phyllosilicates—Sheets of tetrahedra ( $\text{Si}_2\text{O}_5$ )
5. Sorosilicates—Two or more linked tetrahedra ( $\text{Si}_2\text{O}_7$ ,  $\text{Si}_5\text{O}_{16}$ )
6. Tectosilicates—Framework of tetrahedra ( $\text{SiO}_2$ )

The minerals are listed above by alphabetical order, but on the basis of molecular structure, nesosilicates, composed of single tetrahedra, are the simplest in structure, followed by sorosilicates, where two or more tetrahedra are linked together to form the mineral. The structure becomes increasingly more complex in cyclo-, phyllo-, and tectosilicates (Figure 6.1). Examples of mineral species belonging to the six groups of silicates are listed in Table 6.1. The sand and a major part of the silt fraction belong to the cyclo-, ino-, neso-, soro-, or tectosilicates. They consist of primary minerals and make up the skeletal framework of the soil. Because they are coarse in size, they have low specific surface area and do not exhibit colloidal properties. Although not really chemically active in chemical reactions, they participate in a number of reactions and exhibit some adsorption. They play an important role in soil texture and soil permeability. Many of the sand and silt minerals are also of importance for formation of clays. Most of the clays are phyllosilicates. Clays are of special importance in soil chemistry, because they have a surface chemistry different from that of the larger mineral grains. Clays also exhibit bulk physical properties different from gravel, sand, or silt. Many of the minerals in soil clays are crystalline in structure, whereas others may poorly exhibit crystals or are structurally disordered. Some of the clays may be *amorphous* (e.g., allophane,



**FIGURE 6.1** The molecular structure of soil silicates distinguished by the different arrangement of  $\text{SiO}_4$  tetrahedra.

**TABLE 6.1**  
**Examples of Mineral Species Classified**  
**According to the Six Types of Soil Silicates**

Soil Silicate	Mineral Species
Cyclosilicates	Tourmaline, benitoite
Inosilicates	Amphibole, pyroxene, hornblende
Nesosilicates	Garnet, olivine, zircon, topaz
Phyllosilicates	Chlorite, vermiculite, illite, kaolinite, smectite
Sorosilicates	Epidote
Tectosilicates	Feldspars, quartz, zeolite

silica, alumina, and iron oxide). Many prefer to call them *noncrystalline* or *paracrystalline clays*. The name *short-range-order* (SRO) minerals is becoming popular. They were formed by rapid pedogenic processes, are unstable, and may eventually crystallize in time. The crystalline clays are then sometimes referred to as *long-range-order* minerals (Chesworth, 2008; Huang et al., 2005; Lal, 2006; Tan, 2003). Silica, alumina, and iron oxide may occur in soils as discrete, independent minerals, or as coatings around crystalline clay particles and other inorganic soil constituents. Not

**TABLE 6.2**  
**Major Phyllosilicate Minerals in Soils**

Layer Type	Group Name	Charge per Unit Formula	Common Minerals
1:1	Kaolinite-serpentine	-0	Kaolinite, halloysite, chrysotile, lizardite, antigorite
2:1	Pyrophyllite-talc	-0	Pyrophyllite and talc
	Smectite or montmorillonite	0.25 to 0.6	Montmorillonite (smectite), beidellite nontronite, saponite, hectorite, saunconite
	Mica	-1	Muscovite, paragonite, biotite, phlogopite
	Brittle mica	-2	Margarite, clintonite
	Illite	2	Illite
	Vermiculite	0.6 to 1.9	Vermiculite
2:1:1	Chlorite	Variable	Chlorite
Chain	Palygorskite-sepiolite	—	Palygorskite, sepiolite

Sources: Mackenzie, R. C. In *Soil Components, Vol. 2, Inorganic Components*, J. E. Gieseking (ed.), Springer-Verlag, New York, 1975, pp. 1–25; Brindley, G. W., S. W. Bailey, G. T. Faust, S. A. Forman, and C. I. Rich, *Clays Clay Miner.*, 16, 322, 1968; Rossman, F. G., and C. J. van Oss., *Colloid and Surface Properties of Clays and Related Minerals*, Taylor & Francis/CRC Press, Boca Raton, FL, 2002.

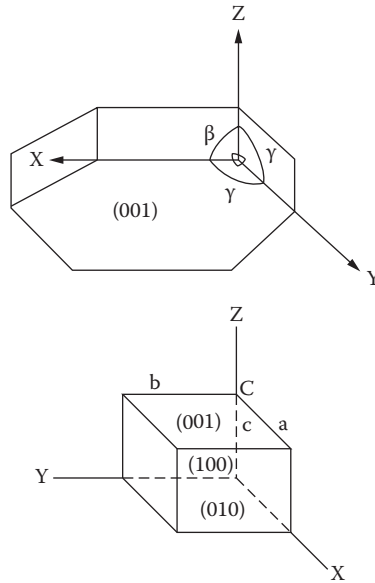
all of the clays belong to the phyllosilicate group, or layer–lattice silicates. The soil’s clay fraction also contains other minerals, such as the palygorskite-sepiolite minerals, quartz in particle sizes of  $<2\ \mu\text{m}$ , sesquioxides, titanium oxides, pyrophyllite, talc, sulfides, sulfates, and phosphates. The major types of phyllosilicates are listed in Table 6.2.

## 6.2 THE STRUCTURAL CHEMISTRY OF CLAY MATERIALS

### 6.2.1 THE UNIT CELL AND CRYSTAL LATTICE

As indicated earlier, soil clays can exist in crystalline, structurally disordered, or amorphous form. The amorphous state generally has no recognizable shape or geometric internal arrangement of atoms. Depending on the degree of sophistication in methods for analysis, a sharp distinction does not exist between crystalline and amorphous states. In soil science, clay is considered amorphous if it is amorphous to x-ray diffraction analysis (i.e., it lacks regularity in internal atomic arrangement as reflected by a featureless diffractogram). In crystals, the atomic arrangement may be repeated in a regular three-dimensional pattern. However, in amorphous materials, such as glass, the chemical bonding of the component atoms is, perhaps, the only unit repeating itself. The spatial arrangement of atoms producing the building unit of a crystal is called the *unit cell*. The latter exhibits a complete group pattern of atoms that repeats itself in three directions in space according to the  $x$ ,  $y$ , and  $z$  axes, respectively (Figure 6.2). The  $z$  axis is sometimes called the  $c$  axis. The size or length of the edges of the unit cell in each direction is expressed in terms of  $a$ ,  $b$ , and  $c$ , each of which represents a discrete unit length for a specific crystal, measured along the  $x$ ,  $y$ , and  $z$  axes. In a cubic crystal,  $a$ ,  $b$ , and  $c$  are of equal length, and the angles  $\alpha$ ,  $\beta$ , and  $\gamma$  are  $90^\circ$ . In clay minerals, these angles may vary according to the structure. By placing several unit cells together, the crystal arrangement produced is then called a *lattice structure*. A perfect crystal may be composed of unit cells, each of which has a volume of approximately  $1\ \mu\text{m}^3$ .

The atomic groups in a crystal lattice can be arranged in planes at equal spacing along the crystallographic direction. Several types of atomic planes can be drawn in the crystal with interplanar spacings called *d spacings*. The plane delineated, or bordered, by  $a$  and  $b$  parallel to the  $x$  and  $y$  axes (see Figure 6.2) cuts the  $z$  axis at  $C$ , but does not cut the  $x$  and  $y$  axes. According to the *Miller indices*

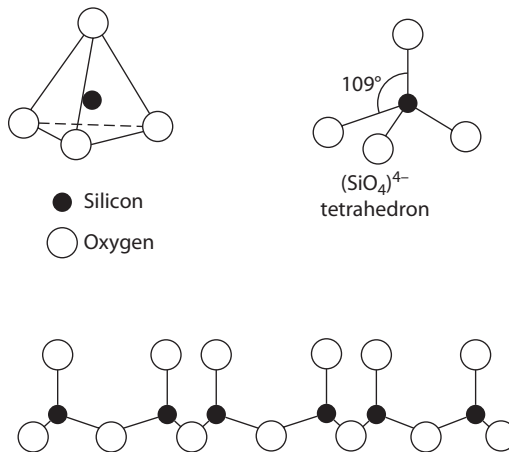


**FIGURE 6.2** Top: Crystal structure, exhibiting a group pattern of atoms, repeating itself in three directions in space, according to the x, y, and z axes, respectively. Bottom: Close-up of a unit cell, showing discrete unit lengths a, b, and c, measured along the x, y, and z axes in a cubic crystal.

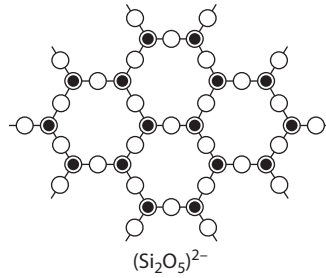
system (Grimshaw, 1971; Tiley, 2004), this plane is given the number 001. The basal (001) spacing plays a fundamental role in the identification of clay mineral species by x-ray diffraction analysis. These indices, created by W. H. Miller (Allaby and Allaby, 1999) for showing the intercepts of crystal planes on crystallographic axes, originally used the symbols h, k, and l.

### 6.2.2 THE STRUCTURE OF SILICATE CLAYS

Silicates are built around a silica tetrahedron, in which each oxygen atom receives one valency from the silicon atom. To satisfy its divalent requirement, the oxygen atoms can be linked to other cations or to a silicon atom of an adjacent silica tetrahedron (Figure 6.3). The linkage of silica tetrahedra

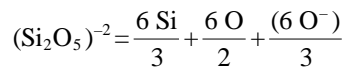


**FIGURE 6.3** Top: Schematic structure of a single silica tetrahedron. Bottom: The arrangement of several silica tetrahedra into a sheet by mutually sharing oxygen atoms.



**FIGURE 6.4** Hexagonal arrangement of silica tetrahedra.

yields five groups of structural arrangements of silicate: islands, isolated group, chain, sheet, and framework structure. Silicate clay minerals are characterized by a sheet structure. In contrast with the other silicates, the structure of clay is not a three-dimensional network of simple linkages of silicon–oxygen units, but it is built up of stacked layers of silica tetrahedra and Al(Mg) octahedral sheets. The sheets are developed by the linkage of three oxygens in each tetrahedron with adjacent tetrahedra units, as discussed earlier. The silica tetrahedra are arranged in hexagonal rings, and the sheet can extend indefinitely in a two-dimensional direction according to the planes *a* and *b*, or parallel to the plane of the paper in this book, which is the reason for the plate-like nature of clays. Figure 6.4 illustrates a sheet of hexagonal rings. The composition of each ring, or the smallest unit of the sheets, is:



In such a network of silica tetrahedra, one oxygen in each tetrahedron remains electrically unbalanced. To satisfy the divalent requirement, the latter is linked to Al in octahedral coordination. By such a packing of silica tetrahedron and aluminum octahedron sheets, a layered clay structure is formed. Several layers of silica tetrahedron and aluminum octahedron sheets can be stacked one above another. However, each layer is an independent unit and is considered the crystal unit. The bonds between the layers can be relatively strong, as in kaolinite, or can be relatively weak, as in montmorillonite (smectite). Within each layer a certain atomic grouping repeats itself in lateral direction. This group or unit layer is referred to as the *unit cell*, whereas the total assembly of a layer plus interlayer material is called a *unit structure*. Illustrations of the packing of silica tetrahedra and aluminum octahedra will be given in the sections on the major types of clay minerals.

On the basis of the number of tetrahedral to octahedral sheets in one layer, the following types are recognized: 1:1 or dimorphic, 2:1 or trimorphic, and 2:2 or 2:1:1 or tetramorphic types. The kaolinite group represents 1:1 layer structures, because of its composition of one tetrahedral to one octahedral sheet. The smectite group represents the 2:1 type, because its structure is built of two tetrahedral sheets to one octahedral sheet. The chlorite group is an example of a 2:2 type, whereas palygorskite and sepiolite belong to the 2:1:1 type.

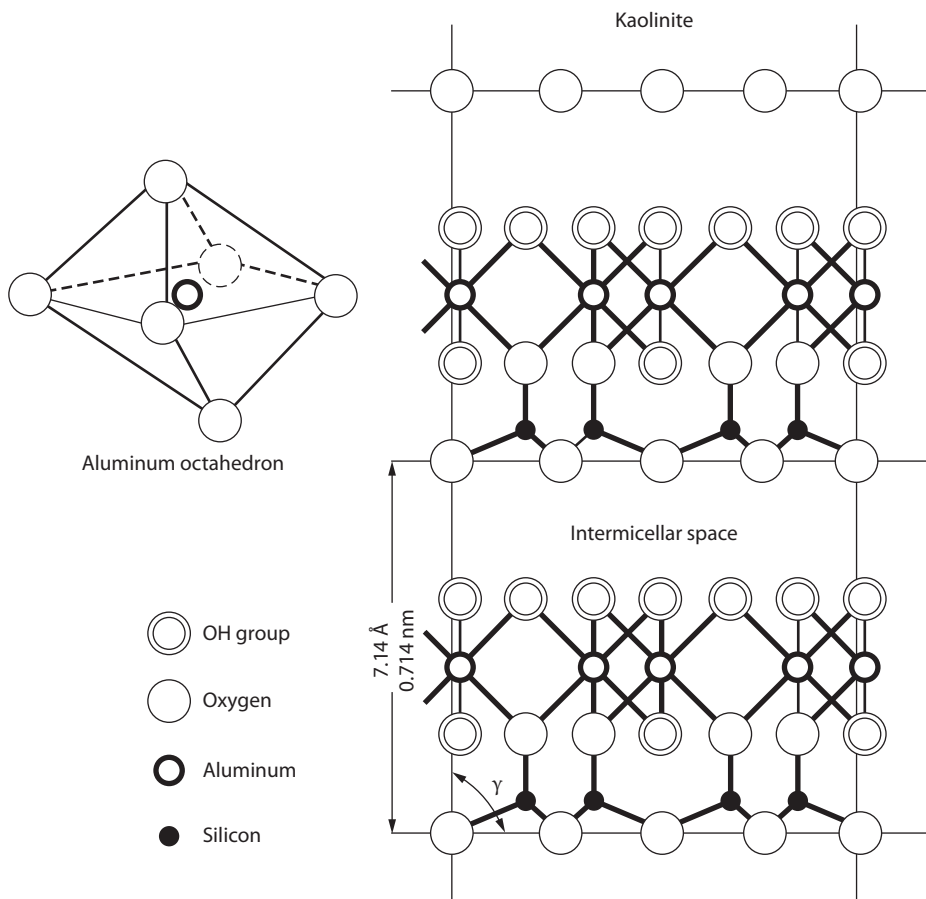
Each clay mineral group can be subdivided again into two subgroups: *dioctahedral* and *trioctahedral*. If two of the three octahedral positions are occupied by Al<sup>3+</sup>, for example, it is dioctahedral. If all octahedral positions are occupied by Mg<sup>2+</sup>, it is a trioctahedral group.

In addition to the structural arrangement as just discussed, stacking of the layers can occur by different types of unit layers in a regular or irregular pattern. The latter yields the *interstratified* group of clay minerals. The structure of these minerals may vary widely, because two or more different types of unit layers may be stacked together (e.g., vermiculite with chlorite units, chlorite with smectite units, mica with smectite units, and kaolinite with smectite units).

### 6.2.3 THE KAOLINITE GROUP (1:1 LAYER CLAYS)

Kaolinite minerals are hydrated aluminosilicates, with a general chemical composition  $\text{Al}_2\text{O}_3:\text{SiO}_2:\text{H}_2\text{O} = 1:2:2$ , or  $2\text{SiO}_2 \cdot \text{Al}_2\text{O}_3 \cdot 2\text{H}_2\text{O}$  per unit cell. However, White (2005) presented a unit cell of the following composition:  $\text{Si}_2\text{O}_5\text{Al}_2\text{OH}_4$ .

Structurally they are 1:1-type phyllosilicates, meaning that the crystal is composed of aluminum octahedra sheets stacked above silica tetrahedron sheets (Figure 6.5). The sheets extend continuously in the *a* and *b* directions and are stacked one above the other in the *z* or *c* direction. The unit cell is nonsymmetrical with a silica tetrahedra sheet on one side and an aluminum octahedra sheet on the other. Consequently, the basal plane of oxygen atoms in one crystal unit is opposite the basal plane composed of OH ions of the next layer. The latter gives the mineral two types of surfaces. The two sheets forming a unit layer are held together by oxygen atoms that are mutually shared by the silicon and aluminum atoms in the respective sheets. The unit layers, in turn, are held together by hydrogen bonding. The basal (001) spacing of kaolinite is, therefore, 7.14 Å. There is little isomorphous substitution, and the permanent charge per unit cell, if not zero, is very small. However, owing to the presence of exposed hydroxyl groups, kaolinite has a variable, or pH-dependent, negative charge. As can be noticed from its structure, the position of OH groups opens possibilities for dissociation of  $\text{H}^+$  ions, which is the reason for the development of the variable charges, especially



**FIGURE 6.5** The structure of kaolinite, composed of silica tetrahedron and aluminum octahedron sheets looking down the (*b*) direction. Unit cell formula is  $[\text{Al}_2(\text{OH})_4(\text{Si}_2\text{O}_3)]_2$ ;  $a = 5.14 \text{ \AA}$ ,  $b = 8.93 \text{ \AA}$ ,  $c = 7.37 \text{ \AA}$ ;  $\alpha = 91.8^\circ$ ,  $\beta = 104.5^\circ$ ,  $\gamma = 90^\circ$ .

at the plane of hydroxyl groups on the exposed surface of the octahedral site. Another plane of hydroxyls is also present, but the latter is located as a subsurface plane of the octahedrons, covered by a network of oxygen atoms. The possibility for dissociation of  $H^+$  ions through such a network of oxygens is still unknown. The cation exchange capacity of kaolinite is, therefore, very small and may change with pH. Usually, it is in the range of 1 to 10 mEq/100 g.

Because of the tightness of the structural bonds, kaolinite particles are not easily broken down. This is also the cause for low plasticity and shrinkage and swelling properties. Its restricted surface area limits the adsorption capacity for cations. The specific surface area is approximately 7 to 30  $m^2/g$ . The crystals may range in thickness from 0.05 to 2  $\mu m$ , with the larger sizes usually occurring in kaolinite deposits or China clay used for the production of high-quality ceramics or pottery.

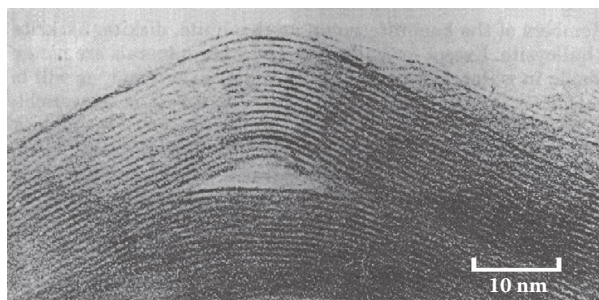
The presence of kaolinite can be identified by a (001) d spacing of 7.14  $\text{\AA}$  x-ray diffraction, and by a second-order 3.57  $\text{\AA}$  diffraction in oriented samples. These diffraction peaks will disappear after heating kaolinite to 500 to 550°C.

Members of the kaolinite group are kaolinite, dickite, nacrite, and halloysite. Except for halloysite, the other minerals are nonexpandable in water. Halloysite contains interlayer water, as will be discussed in the following pages. Upon heating, it is irreversibly dehydrated, and the mineral is then called metahalloysite. Of the mineral species listed previously, kaolinite is perhaps the most widely distributed in soils. It is an important fraction of the clay of Oxisols and Ultisols and is also detected as accessory minerals in Alfisols and Vertisols in the tropics.

#### 6.2.4 HALLOYSITE (1:1 LAYER CLAY)

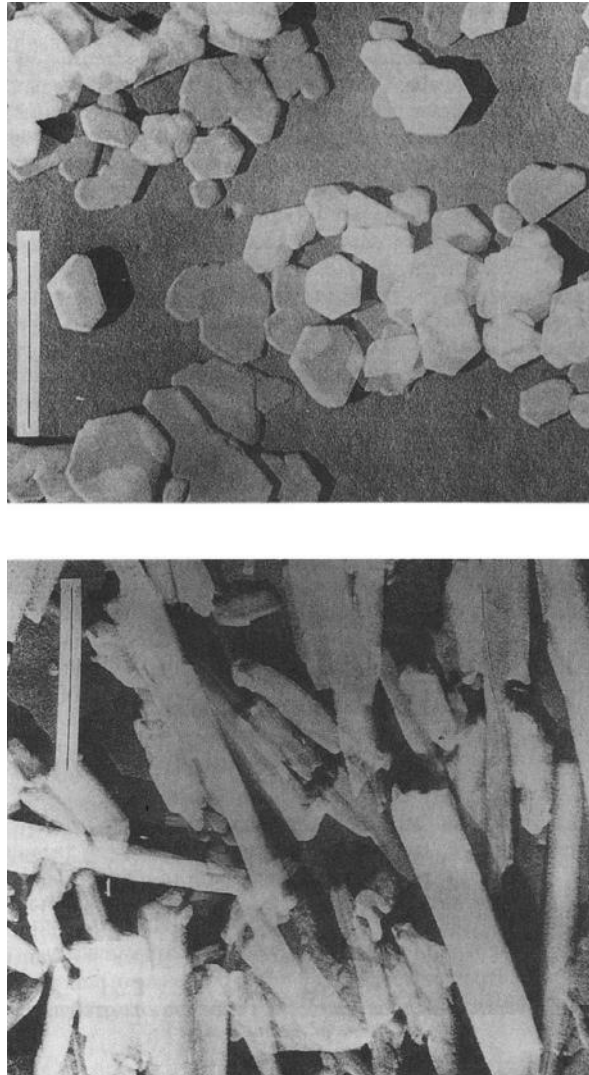
Halloysite has a general composition  $Al_2O_3 \cdot 2SiO_2 \cdot 4H_2O$  and is similar in structure to kaolinite. The differences lie in the disordered stacking of layers and in the presence of two or more interlayers of water, as noted earlier for this mineral. The water molecules are linked together in a hexagonal pattern. In turn, they are bonded to the crystal layers by hydrogen bonding. Because of the presence of interlayer water, halloysite exhibits a basal (001) spacing of 10.1  $\text{\AA}$ , which upon heating can be reduced to 7.2  $\text{\AA}$  (Figure 6.6). The dehydrated species is called metahalloysite. Halloysite is reported to convert rapidly into metahalloysite at 50°C, but the basal d spacing will collapse only after heating at 400°C. Although heating reduces the d spacing, it does not affect the random stacking of layers.

Halloysite, in general, is tubular in form, as shown by electron microscopy (Figure 6.7). This is in contrast to kaolinite, which is hexagonal. The tubular crystal form is considered to be a rolled-up sheet. Because of the presence of interlayer water, the normal  $z$ -axis bonding of O–OH groups



**FIGURE 6.6** Transmission electron micrograph of halloysite showing lines, corresponding to basal unit layers, repeating at distances of approximately 7.2  $\text{\AA}$  (0.72 nm). (From *Clays and Clay Minerals* by Sudo, T., and H. Yotsumoto. Copyright 1977 by The Clay Minerals Society. Reproduced with permission of The Clay Minerals Society in the format other book via Copyright Clearance Center.)





**FIGURE 6.7** Transmission electron micrographs of (top) kaolinite and (bottom) halloysite minerals. (From Egawa, T., and Y. Watanabe, *Bull. Natl. Inst. Agric. Sci. (Japan) Series, B14*, 1964. With permission.)

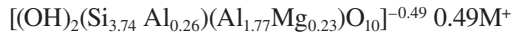
is prevented, causing a distortion of the crystal structure with the consequent curling of layers. However, in 1964, sheet-like halloysite, called *tabular* halloysite, was detected in some of the soils in Texas (Kunze and Bradley, 1964), which was soon disclaimed by several authors as a misinterpretation of an interstratified kaolinite–smectite mineral for halloysite (Ahmad and Mermut, 1996; Joussein et al., 2005).

The x-ray diffraction pattern of halloysite, dried at 105°C, is almost similar to kaolinite. However, the basal (001) diffraction peak of halloysite is usually broad or less sharp, owing to the disordered stacking of layers. Partially dehydrated halloysite may exhibit x-ray diffraction patterns between the two end members stated earlier (between 10.1 and 7.2 Å).

Formation and stability of halloysite in soils appear to be influenced by soil moisture. A moist condition is considered to be required for the development of this mineral. There are indications that halloysite can be considered a precursor of kaolinite, because formation of the mineral follows the weathering sequence: igneous rock → smectite → halloysite → metahalloysite → kaolinite.

### 6.2.5 THE SMECTITE GROUP (EXPANDING 2:1 LAYER CLAYS)

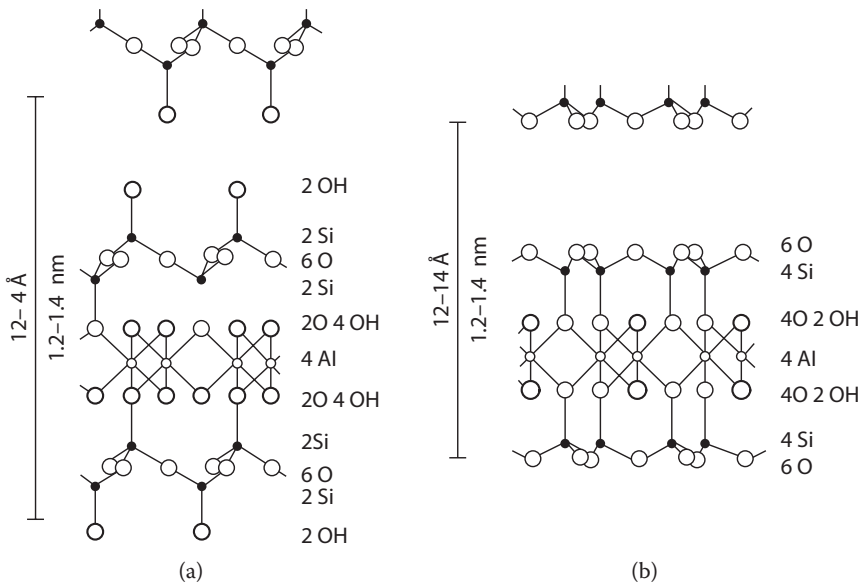
Minerals in this group were formerly called *montmorillonites* and have a variable composition. Though the formula is often expressed as  $Al_2O_3 \cdot 4SiO_2 \cdot H_2O + xH_2O$ , White (2005) presented a very complex unit cell formula as follows:



where  $M^+$  is the interlayer cation, neutralizing the negative charge of the mineral.

The name smectite is reserved for the hydrated aluminosilicate species with little substitution and in White's opinion still carries the name *montmorillonite*. Many clay deposits in the United States contain large amounts of smectite. This type of clay is frequently called *bentonite*, and commercial-grade smectite or montmorillonite is often referred to as bentonite. A wide range of minerals exist within the smectite group, and the principal end members in the dioctahedral subgroup are *beidellite* and *nontronite*. Smectite or montmorillonite has Mg and ferric ions in octahedral positions, whereas beidellite ideally contains no Mg or Fe in the octahedral sheet. Beidellite is characterized by a high Al content. The silicate layer charge is derived entirely by substitution of  $Al^{3+}$  for  $Si^{4+}$ . Nontronite is like smectite, but with all the  $Al^{3+}$  replaced by  $Fe^{3+}$ . In the trioctahedral subgroup, only two end members are recognized: *hectorite* and *saponite*.

Two types of structure have been proposed for smectite: the structure according to (1) Hofmann and Endell and (2) that of Edelman and Favajee. Both hypotheses show similarity in the fact that the unit cell structure is considered symmetrical, as opposed to that of kaolinite. One aluminum octahedral sheet is sandwiched between two silica tetrahedra sheets. The crystal layers are reported to be stacked together in random fashion, and some of the minerals may even be fibrous, such as hectorite. The bonds holding the layers together are relatively weak, developing intermolecular spaces that will expand with increasing moisture content. However, the difference between the structure of Hofmann and Endell and that of Edelman and Favajee is in the arrangement of the silica tetrahedra network, as shown in Figure 6.8. Edelman and Favajee are of the opinion that

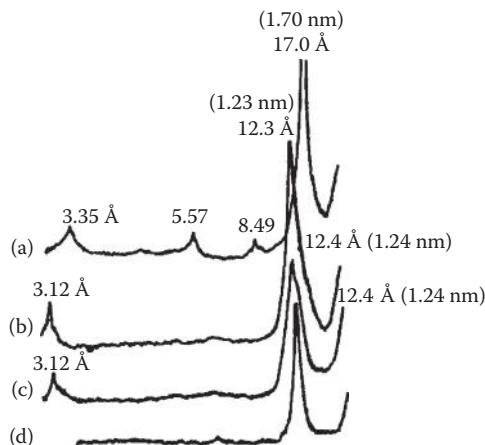


**FIGURE 6.8** Structural model of smectite according to (a) Edelman and Favajee, and (b) Hofmann and Endell. (Adapted from M. W. Wisaksono, and K. H. Tan, *Ilmu Tanah. Djilid II*. Pradnjaparamita II Publishers, Jakarta, Indonesia, 1964.)

an alternative arrangement of silica tetrahedra exists with Si–O–Si bond angle =  $180^\circ$ , with basal planes composed of OH groups bonded by the silica in the tetrahedrons.

The negative charge of smectite arises mainly from isomorphous substitution. Only a small variable charge is present, because all the disposable hydroxyl groups are located in subsurface planes covered by a network of oxygen atoms. Van Olphen (1977) mentioned a negative charge equivalent to a cation exchange capacity of 70 mEq/100 g for a typical smectite. However, White (2005) believes that because the excess of negative charges are distributed over 10 surface oxygen atoms, the field strength is then relatively weak. The interlayer planar surfaces together with the external planar surfaces account for a very large total surface area. The specific surface area is approximately 700 to 800 m<sup>2</sup>/g, which is exposed on dispersion in water. Because of free movement of water in and out of the interlayers, causing weak interlayer bonding, the plates or layers can slide in opposite directions, which is the reason for the strong plasticity and stickiness exhibited by smectite when wet. The minerals are generally very fine grained, whereas the component layers are not bonded strongly, as noted earlier. In contact with water, the mineral also exhibits interlayer swelling, causing the volume of the clay to double. Indications are available that the basal spacing of smectite increases uniformly with adsorption of water. Several authors noted that the increase in basal spacing can occur step-wise, suggesting formation of hydration shells around interlayer cations. The high swell–shrink potential is why the mineral can admit and fix metal ions and organic compounds. The adsorption of organic compounds leads to formation of organomineral compounds. Organic ions are believed to be able to replace inorganic cations in the interlayer position. Monolayers, sometimes double layers, of organic molecules are adsorbed, depending on the size of the cations and the charge deficit of the layers. Adsorption of organic compounds, such as glycerol and ethylene glycol, is used as a positive (diagnostic) identification of smectite by x-ray diffraction analysis. Oven-dry (105°C) smectite is usually characterized by a basal (001) spacing diffraction peak at 10 Å. In air-dry conditions, the mineral has some interlayer water, and the characteristic spacing is approximately 12.4 to 14 Å (Figure 6.9). After solvation, or intercalation with ethylene glycol or glycerol, the basal (001) d spacing expands to 17 Å. Reports are present in the literature that suggest that the spacings can be expanded indefinitely. However, here the mineral exists only as platelets or as unit cells, whereas the intermicellar spaces cease to exist.

Among the several species of clays in soils, the mineral smectite is perhaps the most widely distributed member. Most soil smectites (montmorillonites) are dioctahedral. They are characteristic constituents of clays of Vertisols, Mollisols, and Alfisols, and are also found in some



**FIGURE 6.9** X-ray diffractograms of smectite: (a) after solvation, (b–d) air dried. (Adapted from Tan, K. H., and R. A. McCreery, In *Proc. 1974 Int. Clay Conf.*, Mexico City, Mexico, Applied Publ., Wilmette, IL, 1975, pp. 629–641.)

Entisols. The high plasticity and swell–shrink potential of the mineral make these soils plastic when wet and hard when dry, whereas wide cracks will form as soils dry out. The dry soil is difficult to till.

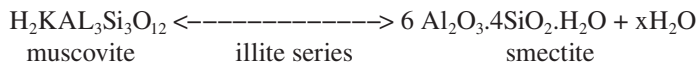
### 6.2.6 ILLITES (NONEXPANDING 2:1 LAYER CLAYS)

The illite minerals are micaceous types of clay. However, in contrast with the true micas, which are primary minerals or primary formation, illites are of secondary origin. They are also known under the names *hydrous mica* or *soil mica*. The term *illite* is suggested for the fine-grained minerals in this group, whereas the coarser particles are frequently called *hydrous mica*. Several authors object to classifying illite as clay, and White (2005) placed it in the mica group. Some indicate that, strictly speaking, illite is clay-sized mica, and, therefore, cannot be regarded as a clay mineral (Fanning and Keramidas, 1977; Theng, 1974). However, illitic clay mineralogy is recognized by the U.S. soil taxonomy system (Soil Survey Staff, 1975, 2006). Van Olphen (1977) considers mica, especially muscovite, the prototype of illite. Its close relation with mica was the reason for naming this mineral hydrous mica or soil mica.

The mineral has a chemical composition almost similar to muscovite, but it contains more SiO<sub>2</sub> and less K. Alteration, associated with weathering processes of muscovite and subsequent formation into clays, are the reasons for the observed differences. In contrast to micas, illite exhibits some isomorphous substitution of Al<sup>3+</sup> for Si<sup>4+</sup> in the tetrahedral sheets and some substitution of Al<sup>3+</sup> for Mg and Fe in the octahedral sheet. The following unit cell formula is proposed by White (2005):



Primarily K, but sometimes NH<sub>4</sub>, cations are occupying the trigonal cavities formed by adjacent siloxane surfaces. Several authors are of the opinion that a continuous series of illite species exists between muscovite and smectite as the end members:



Mixed layering of illite–smectite often occurs. Because illite contains interlayer potassium, the unit layers are bonded more strongly than those in smectite. Therefore, the intermicellar spaces of illite do not expand upon addition of water. Because of the electrostatic bonds exerted by K<sup>+</sup> ions linking the unit layers together, the basal (001) spacing is 10 Å. The cation exchange capacity is about 30 mEq/100 g, and plasticity, swelling, and shrink–swell capacity are less intense in illite than in smectite. Fine-grain illites have been found concentrated in the coarse clay fraction (2 to 0.2 μm) of soils. As indicated earlier, the physical properties are closer to kaolinite than to smectite. However, the ease of parallel alignment of the particles and their presence in the coarse clay fraction are considered to have a detrimental effect on soil stability.

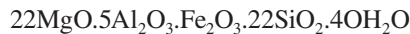
Identification of illite can easily be made by x-ray diffraction analysis. These minerals are characterized by a basal (001) spacing of 10 Å. This peak does not shift or collapse after heating the mineral at 500°C or after solvation with glycerol or ethylene glycol. In many instances, elemental analysis of K concentration was also used for the detection of illites in soil clays. Although the theoretical concentration is approximately 9% to 10% K, a potassium content of 5% to 8% is frequently found for illitic clays, with a value of 7% K as the diagnostic percentage for illite.

Illite is an important constituent of clays in Mollisols, Alfisols, Spodosols, Aridisols, Inceptisols, and Entisols. In soils affected by high precipitation, the mineral tends to be altered into smectite, whereas under the influence of warmer climates or higher temperatures, the structure of illite is reported to become more disordered, and kaolinite is formed.

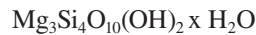
### 6.2.7 VERMICULITES

The vermiculite group of minerals also forms mica-like flakes as illites. It is also a mica alteration product. However, the mineral called *hydrobiotite*, formed from weathering of biotite, is not vermiculite; it belongs to the illite group. Vermiculite can be divided into two categories: *true vermiculite* and *clay vermiculite*. True vermiculite is not considered a clay mineral but a rock-forming mineral (Douglas, 1977; Walker, 1975). The name is derived from *vermiculare* or *vermicularis* (Latin: “wormlike,” or “to breed worms”), because upon heating, the mineral becomes elongated, twisted, and curled. After heating, it usually expands to 20 to 30 times its original size. Commercial vermiculite is often interlayered biotite and vermiculite. The clay-sized vermiculite found in soils is considered *clay vermiculite* or *soil vermiculite*. Its existence in the clay fraction of soils was first demonstrated in 1947 in the soils of Scotland, but Walker (1975) indicated that it has not yet been isolated as monomineral particles. The detection in soils is based on its x-ray diffraction peak at 14 Å. This is why it is often called 14 Å mineral.

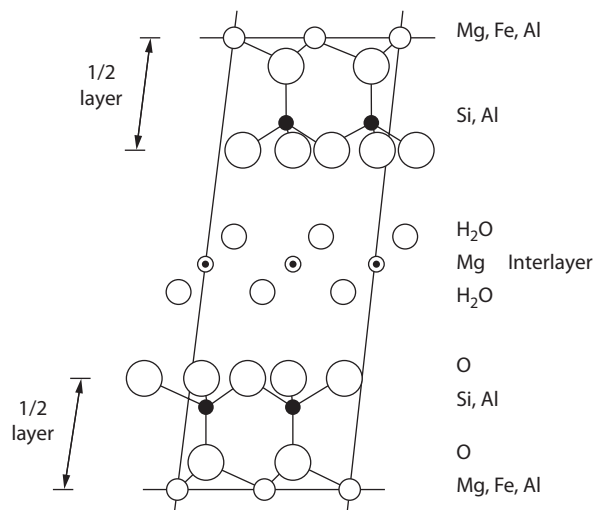
Clay vermiculite is a magnesium aluminum silicate, with Mg occupying the octahedral positions between two silica tetrahedra sheets. Some iron may also be present. The chemical formula can be generalized as:



or



The structure (Figure 6.10) shows similarities to that of chlorite, with the difference that instead of brucite, water molecules of about 5 Å layers are occupying the intermicellar spaces. In many cases, interlayering with hydroxy-Al also occurs. In the tetrahedral layer considerable substitution of Al for Si takes place. This is the reason for the high negative charge present in vermiculite. Vermiculite is one of the clay minerals with the largest cation exchange capacity (CEC) among the inorganic colloids. The CEC is approximately 150 mEq/100 g and exceeds that of smectite. According to Douglas (1977), the CEC of dioctahedral vermiculite is 1.05 times



**FIGURE 6.10** The structure of vermiculite, showing the brucite  $[\text{Mg}(\text{OH})_2]$  interlayer. In chlorite the intermicellar space is also occupied by brucite.

the CEC of trioctahedral vermiculite, and values of CEC between 144 and 207 mEq/100 g have been reported. The presence of hydroxy-Al interlayers usually reduces the CEC of the mineral. Vermiculite with hydroxy-Al in intermicellar spaces is presently called *hydroxyaluminum inter-layer vermiculite* (HIV). In the older literature, this type of vermiculite is known as *interstratified vermiculite*, because of the presence of -Al(OH)<sub>3</sub>, hydroxy-Al, or gibbsitic-Al, in interlayer position. The more common name used in the literature is *hydroxy-interlayered minerals* (HIM) (Schaetzl and Anderson, 2005). These minerals are defined as a series of HIMs between pure smectite (or vermiculite) at one end and pure chlorite at the other end (Barnhisel, 1977; Meunier, 2007). In between the pure end members exist many HIMs, and *hydroxy-interlayered smectite* (HIS) is one of them, while HIV is another one. Soils of the southern region in the United States, often characterized by low CECs, exhibit higher CEC values by small admixtures of vermiculite, or HIVs, in their clay fraction.

Most soil vermiculites are probably dioctahedral. The mineral is reported to have wedge zones with high selectivity for fixation of K<sup>+</sup>, NH<sub>4</sub><sup>+</sup>, and other cations. The high potassium and ammonium fixation values in many soils are attributed more to the presence of vermiculite than to smectite or illitic types of clays.

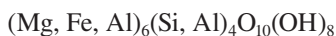
Identification of clay vermiculites is done mostly by x-ray diffraction analysis and differential thermal analysis (DTA). For oriented samples, the basal (001) x-ray diffraction peak is at 14 Å. This peak will not shift or collapse upon solvation, but after heating to 700°C, the basal d spacing usually collapses to 11.8 or 9.3 Å. The common occurrence of vermiculite as mixed layers with smectite, chlorite, illite, and biotite yields many difficulties in the positive identification of vermiculite. Many clay vermiculites may have been identified in the past as smectite. In some instances, treatment of vermiculite with KCl solutions can produce a mineral with a mica structure.

Vermiculite usually occurs as accessory minerals in the clay fraction of Ultisols, Mollisols, and Aridisols. It is formed more in well-drained soils, in contrast with smectite, which requires a gley condition for formation.

### 6.2.8 CHLORITES (2:2 LAYER CLAYS)

Chlorites are hydrated magnesium and aluminum silicates, which are related to mica minerals in appearance. The name comes from the green color of many chlorite specimens. Structurally chlorite is related to talc, or 2:1 layer clays, and shows close relationship with vermiculite. However, a number of authors prefer to use the term *2:2 layer* for chlorite. Octahedral sheets, composed of Mg(OH)<sub>2</sub>, are sandwiched between the two silica tetrahedral sheets. The Mg(OH)<sub>2</sub> sheet was formerly called the *brucite* sheet. The intermicellar spaces are occupied by brucite sheets, and hence, the term 2:2 layer clays (Figure 6.10).

The mineral is variable in composition, but the general composition is reported as follows:



Isomorphous substitutions occur in both the tetrahedral and octahedral layers. The silicon may be replaced by Al, whereas Fe or Al may replace Mg in octahedral positions. The degree of substitution is expressed by Foster (1962) as Fe<sup>2+</sup>/R<sup>2+</sup> ratios, and on the basis of this ratio, three groups of chlorites are recognized:

1. Fe chlorites, containing relatively high amounts of Fe (high Fe<sup>2+</sup>/R<sup>2+</sup> ratios)
2. Intermediates
3. Mg chlorites, which contain smaller amounts of Fe (low or small Fe<sup>2+</sup>/R<sup>2+</sup> ratios)

The Fe-rich chlorite is called today *chamosite*, and Mg-rich chlorite is known as *clinocllore*. Other types of chloritic minerals have also been recognized (e.g., *pennatite* [Mn-rich], *nimite*



[Ni-rich], *cookeite* [Li-rich], and swelling chlorites or *corrensite*). The latter swells when wet and is supposed to be more mixed-layer minerals composed of chlorite–smectite and vermiculite than normal chlorite.

The replacement of Mg by Al occurring in the brucite sheets accounts for the development of a positive charge. This positive charge practically neutralizes the negative charge of the *mica* layer. Therefore, chlorite has only a very small negative charge, perhaps the smallest charge of the clay minerals and, consequently, a small CEC. The hydroxy interlayers are sites for anion retention. Phosphorus is reported to be fixed by interlayer hydroxides of chlorites. On the other hand, the presence of these interlayers reduces fixation of  $K^+$  or  $NH_4^+$  ions.

Depending on the species, the characteristic *d* spacing (001) of chlorite is 14.0 Å, as determined by x-ray diffraction analysis using oriented specimens. This peak does not shift or collapse by treatments of the sample with glycerol or ethylene glycol or by heating to 500°C. Swelling chlorite may have a basal spacing of 28 Å, which increases to 32 Å by solvation.

Abundance and frequency of occurrence of chlorite are considered low (Barnhisel, 1977). Chlorite is usually detected as accessory minerals in clays of Alfisols, Mollisols, and Aridisols. Most of the chlorite minerals are trioctahedral, but recently dioctahedral chlorite has been detected in Virginia from soils derived from muscovite-schist and in soils from British Columbia.

### 6.2.9 MIXED-LAYER CLAYS

Soil clays exist in nature as a mixture of several species. Many believe that pure clay minerals—characterized by one type of unit cell—are rare in soils (Srodon, 2007). Several of the different types of clay minerals may be stacked together as a packet. This process is called *interstratification* and such clays are referred to as *interstratified* clays or mixed-layer clays. Interstratified clays cannot be separated by physical means, as can an ordinary physical mixture of clays. Interstratification can occur in a (1) *regular* fashion or (2) *random* fashion. It may also be the result of a segregation process within a crystal in zones within another mineral. Another process of formation of mixed-layer clays is precipitation, formation, or crystal growth in interlayers. For example, gibbsite sheets may develop from precipitation and crystallization in intermicellar spaces, owing to replacement of exchangeable cations and change in chemical environment. Some also are of the opinion that interstratification is limited to the mixing of only two clay minerals, such as illite and smectite. The regularly interstratified illite–smectite mineral is called *rectorite* by Murray (2007).

The identification of regular mixed-layer clays follows the same principles as used with monomineral clays. X-ray analysis also produces a regular sequence of x-ray diffractions with regular mixed clays. They are usually identified by an integral sequence of the basal (001) diffraction peaks, which corresponds to the sum of the thickness of the component layers. For example, two layers of 14 Å vermiculite clay will produce a basal *d* spacing of  $2 \times 14 = 28$  Å. Corrensite, earlier identified as a regularly interstratified chlorite–smectite clay, exhibits its basal (001) diffraction peak as either  $14 + 17 = 31$  Å (for an expanded smectite component) or  $14 + 12.4 = 26.4$  Å (for an air-dry smectite component), assuming that the structure has not been changed.

The random mixed-layer clays are more difficult to identify and do not exhibit integral series of basal (001) diffraction patterns. The sequence of diffractions is relatively short, compared to regular mixtures. Pretreatments, such as solvation, potassium saturation, and heating, may then be required to solve the problem. On the other hand, physically mixed clays can be readily identified, because the diffraction of the basal (001) spacings of the major planes will all appear in the x-ray analysis. Each of the diffraction peaks can be identified in the usual manner.

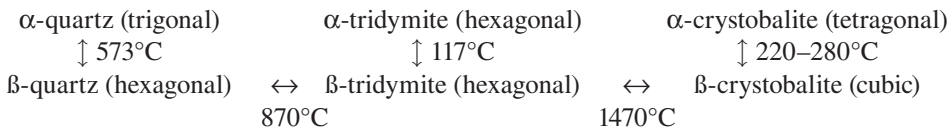
Interstratified clays have been detected in a large variety of soils in temperate, cold, and tropical regions. McEwan and Ruiz-Amil (1975) are of the opinion that mixed layering is less common in tropical conditions. In the soils of the humid temperate regions, interstratification occurs often in the sequence smectite–chlorite–mica, or mica–illite. However, smectite–kaolinite or vermiculite–kaolinite has also been observed, especially in the subtropical regions of the United States. In the



humid tropics, interstratification has been noted in the sequence smectite–halloysite–kaolinite. In the United States, chlorite and vermiculite are the most common components of interstratified clays in Alfisols and some Ultisols.

### 6.2.10 SILICA MINERALS

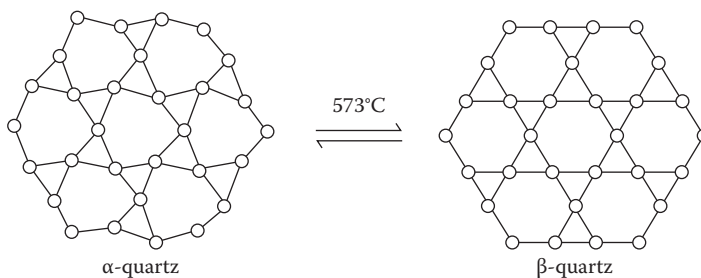
Silica minerals are composed entirely of silica or constructed of  $\text{SiO}_4$  tetrahedra only (Rossman and van Oss, 2002). They occur extensively in nature and are frequently an important constituent of the clay fractions of soils. By virtue of their size ( $>2 \mu\text{m}$ ), the fine silica particles are classified as clays. However, the coarse silica particles are found mostly in the silt and sand fractions. Structurally, these minerals do not belong to the *phyllosilicates* characterized by sheet structures, but they are distinguished as minerals with framework structures or *tectosilicates*. The four oxygen atoms of the silica tetrahedron are linked directly to neighboring silicon atoms, yielding a fourfold coordination that is electrically balanced. The formula of these minerals is generalized as  $n(\text{SiO}_2)$ . Three types of crystalline minerals are distinguished in the category of silica minerals: quartz, tridymite, and cristobalite. Depending on the temperature, each of them can exist in an  $\alpha$  and  $\beta$  form:



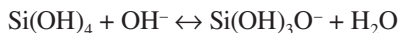
The  $\alpha$  form is the low-temperature form variety, whereas the  $\beta$  modification is the high-temperature form. The transformation, called *conversion*, is normally instantaneous, reversible, and without breaking any structural bonds, but it is accompanied by structural changes (Figure 6.11). An increase in symmetry and density were also noted by Rossman and van Oss (2002), who added that the change from quartz into tridymite involves breaking the strong siloxane bonds.

The silica minerals are generally considered inert, or chemically inactive, materials. They have only a slight effect on physicochemical properties of soils, and because of their low chemical activity, they are perhaps of importance only as diluents to the more reactive clay and humic material. The surface area is very small, and amounts to only 2 to 3  $\text{m}^2/\text{g}$ , depending on the shape of the particles. Soils with clay fractions dominated by silica minerals are usually nonplastic and have a small shrink–swell capacity, as well as a small water-holding capacity. The surface charge is also very small, if not negligible, whereas the correspondingly small cation and anion exchanges are more attributable to the Si–O broken bonds and Si–OH groups on particle edges.

Silica minerals are insoluble at low pH. Their solubility does not increase if pH is increased, for example, from pH 3 to pH 9 (Krauskopf, 1956). Only above soil pH 9 will silica dissolve according to the following reaction:



**FIGURE 6.11** Structural changes associated with the conversion of  $\alpha$ - to  $\beta$ -quartz. Note the perfect hexagonal structures in  $\beta$ -quartz.



In general, solubility of silica minerals is related to the packing density of the silica tetrahedra. Of the three types of minerals stated, solubility increases in the following order:

Quartz < crystobalite < opal < amorphous silica

The sequence suggests that quartz is the least soluble, whereas amorphous silica is the most soluble. Opal, a silica mineral of plant origin often called *biogenic silica*, is relatively less soluble than amorphous silica.

Identification of silica minerals is usually done by x-ray diffraction and DTA. With x-ray analysis, quartz yields a d(100) spacing of 4.26 Å (0.426 nm) and a d(101) spacing of 3.34 Å (0.344 nm). Frequently, the d(100) diffraction peak at 4.26 Å is very weak in intensity, leaving the usually strong 3.34 Å x-ray diffraction peak for use in diagnosis of quartz. With DTA, quartz exhibits a small but sharp endothermic peak at 573°C. Because the temperature at which this endothermic peak occurs is sharp at 573°C, quartz is often used as a stable reference material for calibration of the DTA instrument. The identification of crystobalite is more difficult than quartz, because crystobalite gives a series of d spacings by x-ray analysis (e.g., 4.04, 3.14, and 2.84 Å), which overlap the d spacings of orthoclase minerals. Generally, a strong 4.04 Å (0.404 nm) peak, accompanied by a relatively weak 3.14 Å peak, suggests the presence of crystobalite.

The silica minerals occur in a wide variety of soils. Their concentrations appear to be related to parent material and to degree of weathering. Soils derived from acidic parent materials (e.g., granite) are generally rich in quartz. Quartz is an important mineral in Spodosols because of the origin of these soils from highly siliceous materials. Inceptisols may be rich in quartz, but this is also a reflection of the parent material. In Mollisols, moderately weathered Alfisols, and highly weathered Ultisols, quartz may accumulate in the eluvial (E) horizons. On the other hand, quartz may be absent in the clay fraction of the highly weathered Oxisols derived from basic and intermediate rocks or volcanic materials (Tan, 2008). Crystobalite is often volcanic in origin, and its presence is considered of importance in many volcanic ash soils.

### 6.2.11 IRON AND ALUMINUM HYDROUS OXIDE CLAYS

These groups of clays are currently becoming increasingly important, especially the iron oxides. Not only have new minerals been discovered, but the iron oxides appear to find applications in soil science, biology, industry, and corrosive technology (Cornell and Schwertmann, 2004). Both the Fe and Al hydrous oxide clays do not belong to the phyllosilicates but are oxides of iron and aluminum, containing associated water.

Two major forms of crystalline monohydrates of ferric oxide are known—*goethite* and *lepidocrocite*—and two crystalline anhydrous ferric oxides have also been found in soils—*hematite* and *maghemite*. Plus, several new iron oxide minerals have been discovered. The composition of these and other hydrous oxide minerals are listed in Table 6.3. The iron hydrous oxide mineral, *ferrihydrite*, was erroneously called *amorphous ferric hydroxide* in the past (Schwertmann and Taylor, 1977). Today the mineral is classified as a short-range-order (SRO) mineral (Chorover, 2006). It was first found as a major component of iron ocher sediments in drainage ditches and was suspected to also occur widely in soils. It has now been reported that the B<sub>s</sub> horizons of Spodosols contain clay fractions with ferrihydrite. *Akaganeite*, one of the new minerals added to the list, has been named after the mine *Akaganè*, where it was discovered. According to Cornell and Schwertmann (2004), it exhibits a cubic structure, with Fe<sup>III</sup> on octahedral sites, and is less dense than alpha (α) and gamma (γ) FeOOH. When sulfate enters the akaganeite structure, a new mineral, *schwertmannite*, is formed. This mineral was discovered for the first time in Finland in 1994 and named for a well-known scientist, Udo Schwertmann. Schwertmannite is often transformed

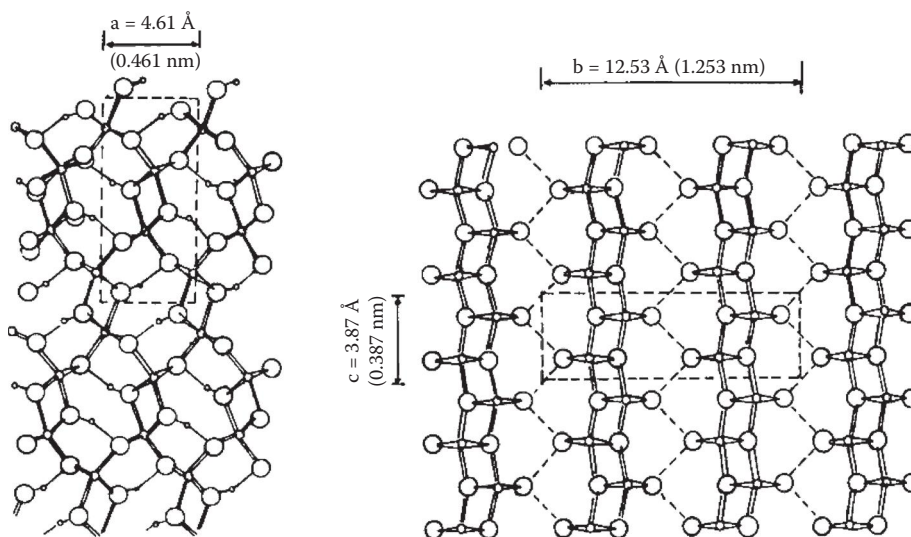
**TABLE 6.3**  
**Iron and Aluminum Oxide Minerals Frequently Found in Soils**

Iron Oxide Minerals		Aluminum Oxide Minerals	
Goethite	$\alpha$ -FeOOH	Diaspore	$\alpha$ -AlOOH
Lepidocrocite	$\gamma$ -FeOOH	Boehmite	$\gamma$ -AlOOH
Ferroxhyte	$\delta$ -FeOOH	Gibbsite	Al(OH) <sub>3</sub>
Hematite	$\alpha$ -Fe <sub>2</sub> O <sub>3</sub>		
Maghemite	$\gamma$ -Fe <sub>2</sub> O <sub>3</sub>		
Ferrihydrite	Fe <sub>5</sub> HO <sub>8</sub> ·4H <sub>2</sub> O or Fe <sub>5</sub> (O <sub>4</sub> H <sub>3</sub> ) <sub>3</sub>		
Akaganeite	KFe <sub>3</sub> (SO <sub>4</sub> ) <sub>2</sub> (OH) <sub>6</sub>		
Schwertmannite	Fe <sub>16</sub> O <sub>16</sub> (OH) <sub>5</sub> (SO <sub>4</sub> ) <sub>2</sub> nH <sub>2</sub> O		

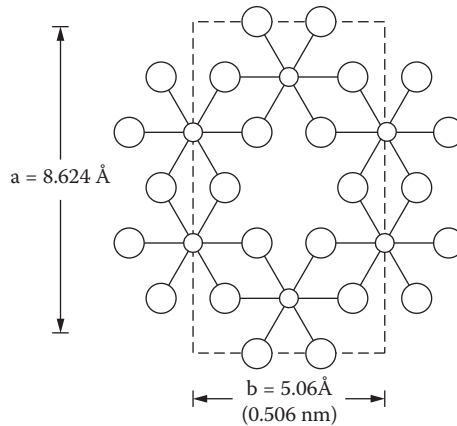
into goethite at pH 4 to 7.2 and is often reported to also be present in mine tailings or spoils. A third new Fe mineral is *ferroxhyte*, which according to Cornell and Schwertmann (2004), exhibits hexagonal unit cells.

Limonite is frequently mentioned in the older literature as an important rusty oxide mineral. However, it is currently no longer considered a soil mineral.

Structurally, goethite is formed by close-packed oxygen atoms in a hexagonal pattern (Figure 6.12). On the other hand, lepidocrocite has a more complicated structural pattern. Isomorphic substitution of Al or Mn for some of the Fe frequently occurs. The most common aluminum hydrous oxide in soils is gibbsite. Gibbsite is sometimes also called *hidrargillite*. Less common aluminum hydrous oxide species are bayerite, boehmite, and diaspore. The composition of gibbsite is usually formulated as Al(OH)<sub>3</sub>, with a structure made up of layers composed of two close-packed hydroxyl sheets with aluminum located in a sixfold coordination (Figure 6.13). The hydroxyl groups are arranged in a slightly polar position in the structure. The Al<sup>3+</sup> ions occupy two-thirds of the possible vacant octahedral interstices. The hydroxyl groups of one layer are almost directly opposite the hydroxyl groups of the adjacent layer. The layers are held together by hydrogen bonds between opposite OH groups.



**FIGURE 6.12** Structure of goethite along the c axis. (Adapted from Greenland, D. J., and M. H. B. Hayes, eds., *The Chemistry of Soil Constituents*. Wiley-Interscience, New York, 1978.)



**FIGURE 6.13** Structure of gibbsite. (Adapted from Grimshaw, R. W. *The Chemistry and Physics of Clays*, Wiley-Interscience, New York, 1971.)

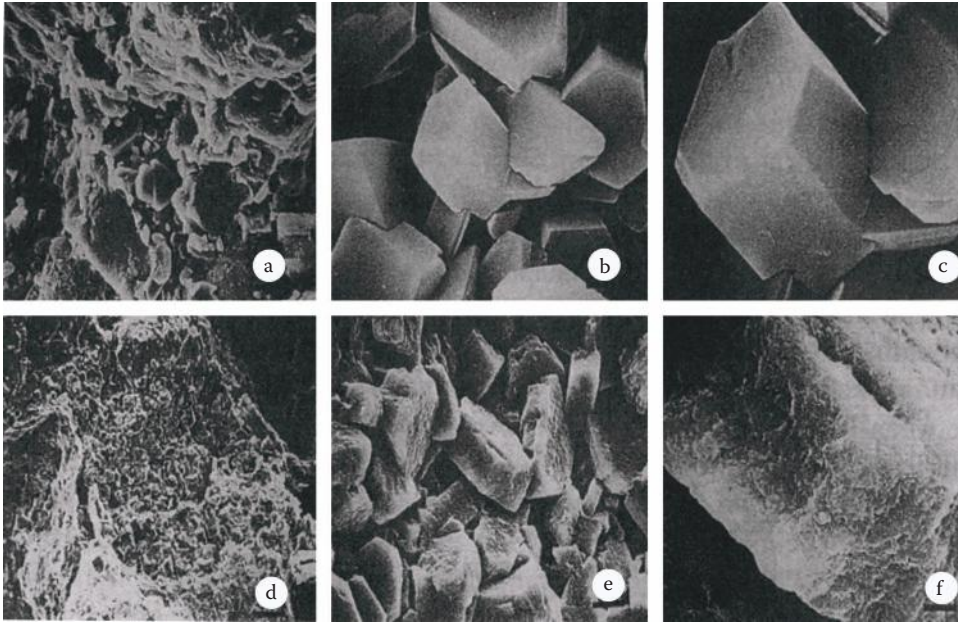
The iron and aluminum oxide minerals are amphoteric. In acid condition, they may have a weak electronegative charge, and in alkaline soil condition, they may develop an electropositive charge. At certain pH values, the minerals can also be neutral (no charge). The pH value at which the mineral has no charge is called the *zero point charge (ZPC)*. This will be discussed more in detail in Section 6.7.

The adsorption capacity of iron minerals ranges from 30 to 300  $\mu\text{mol/g}$ , and according to Schwertmann and Taylor (1977), this compares favorably with cation exchange capacities of silicate minerals. These authors distinguish between *nonspecific* and *specific* adsorption or *chemisorption* of ions by iron minerals. *Nonspecific adsorption* is defined as an electrostatic adsorption, whereas *specific adsorption* is related to a covalent-type ion bonding. Specific adsorption occurs with phosphate ions and heavy metal cations, such as Cu, Zn, Mn, and Pb, leading to a reaction called *retention* or *fixation*. It has been reported that adsorption of  $\text{HPO}_4^{-2}$  increases the negative charge of the mineral and, consequently, the CEC will also increase.

The iron oxide minerals have also been noted to influence the physical properties of soils. Indications are available that iron oxides are adsorbed on kaolinite surfaces, inducing a cementation effect, leading to the consequent development of strong aggregation of soil particles and to concretions and crust formation (Baver, 1963).

The identification of the iron and aluminum oxide minerals is done by x-ray diffraction analysis and DTA. X-ray analysis yields strong diffraction peaks at  $4.18 \text{ \AA}$  and at  $4.82 \text{ \AA}$  for goethite and gibbsite, respectively. Differential thermal analysis reveals a strong endothermic peak at approximately 290 to  $350^\circ\text{C}$  for goethite, gibbsite, and the other minerals. This problem is usually solved by differential dissolution with NaOH of the clay mixture. Such a treatment will dissolve the gibbsite components, and an endothermic peak at the temperature range, as indicated in DTA curves of the residue, is then indicative for the presence of goethite or other iron minerals. Scanning electron microscopy shows gibbsite to be rhombohedral (Figure 6.14).

Goethite, hematite, and gibbsite are probably the most frequently found forms of iron and aluminum oxides in soils. They may occur in considerable amounts in the clay fraction, especially, of tropical and subtropical soils. Many authors consider their presence to be an indication of the effect of drastic weathering processes. The red and yellow colors of highly weathered soils are attributed to these minerals. Because these minerals can change charges, from electronegative, to zero, and to electropositive charges, or vice versa, they are frequently called *clays with variable charges*. The soils then are called *variable charged soils*.



**FIGURE 6.14** Scanning electron micrographs of gibbsite crystals: (a) Magnification  $\times 500$ , (b)  $\times 5000$ , (c)  $\times 10,000$ , (d)  $\times 100$ , (e)  $\times 1000$ , and (f)  $\times 5000$ . (From Eswaran, H., G. Stoops, and C. Sys, *European J. Soil Sci.*, 28, 136–143, 1977. Courtesy of G. Stoops, Laboratory of Soil Science, Ghent University, Belgium. With permission from John Wiley & Sons.)

Goethite is the most important iron oxide mineral in many soils and is responsible for the yellow to yellowish-brown colors. Hematite, on the other hand, is of less importance, but it may occur in tropical and subtropical soils. This mineral is the reason for the red colors of many tropical soils. Gibbsite is a major mineral in highly weathered Ultisols and Oxisols of the humid tropical and subtropical regions. Bauxite deposits in tropical regions contain mostly gibbsite. The U.S. Soil Taxonomy (Goenadi and Tan, 1988; Soil Survey Staff, 1975, 2006) uses the gibbsite content in soils as an indication for highly weathered condition. This is expressed in terms of oxidic ratio, which is defined as:

$$\text{Oxidic ratio} = (\% \text{ extractable } \text{Fe}_2\text{O}_3 + \% \text{ gibbsite}) / (\% \text{ clay})$$

If the value of the oxidic ratio is  $\geq 0.2$ , the soil is placed in the oxidic class, meaning that the soil has been subjected to drastic weathering (oxidation) processes.

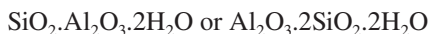
### 6.2.12 AMORPHOUS CLAYS, ALLOPHANE, AND IMOGOLITE

With the recent progress in clay mineralogy, it is currently known that many soils also contain amorphous clays. These clays are noncrystalline and include a wide variety of materials (e.g., silica gel, sesquioxide gels, silicates, and phosphates). They are amorphous to x-ray diffraction analysis. This means that they exhibit a featureless x-ray diffraction pattern. Udo Schwertmann (personal communications) is of the opinion that the term *amorphous* is used erroneously in soil science. It is perhaps the methods of analysis that are inadequate to detect crystallinity in the amorphous clays, because most of these clays occur as very fine, microcrystal forms. Wada (1977) prefers the use of the term *noncrystalline* over the term *amorphous*, whereas now the names *paracrystalline*, and especially *short-range order* are more common (Huang et al., 2008; White, 2005).

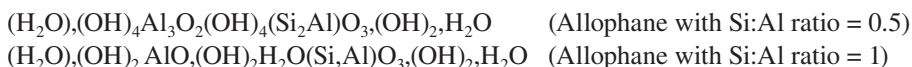


The most important type of clay in this group is perhaps allophane. It is found especially in volcanic ash soils. The name *allophane* was first introduced by Stromeyer and Hausmann in 1861 for hydrous aluminosilicates occurring in nature. Since then, the name *allophane* has been generally accepted for a wide variety of clay materials amorphous to x-ray diffraction analysis (Ross and Kerr, 1934). Allophane was at one time classified as kaolin clay because it has a sheet structure similar to kaolinite. Many definitions for allophane are present today (Parfitt, 1992):

1. Ross and Kerr (1934) define *allophane* as an amorphous material that is commonly associated with halloysite. It has no crystal structure and no definite composition and is a mutual solution of silica, alumina, water, and minor amounts of bases. Allophane associated with halloysite is frequently called *halloysite-like allophane*, with a hypothetical formula of  $0.5\text{Al}_2\text{O}_3 \cdot \text{SiO}_2 \cdot 1.4\text{H}_2\text{O}$ . The aluminum in allophane-like halloysite is in octahedral form.
2. Van Olphen (1977) defines *allophane* as a series of naturally occurring minerals that are short-range-order hydrous aluminum silicates of various chemical composition, characterized by Si–O–Al bonds. They exhibit DTA curves with a strong low-temperature endothermic peak and a high-temperature exothermic peak, with no intermediate thermal features.
3. Wada (1977) reported that allophane is a group name for hydrous aluminosilicates with a composition characterized by a molar Si/Al ratio of 1:2 to 1:1. The formula is proposed to be:



The mineral consists of hollow irregular spherical particles with a diameter of 3.5 to 5 nm, which is quoted by White (2005), who suggests different types of very complex unit cell formulas for different types of allophane:

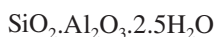


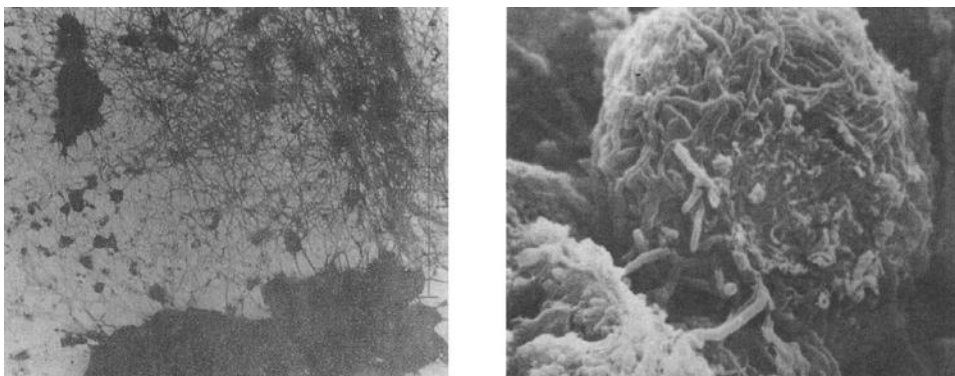
4. Farmer et al. (1985) indicate that allophane is a group name for noncrystalline clay minerals consisting of silica, alumina, and water in chemical combination.
5. Parfitt (1992) is of the opinion that allophane is a group name of clay-size minerals with short-range-order structures. It contains silica, alumina, and water in chemical combination.

Both Van Olphen and Parfitt suggest that allophane is a clay-sized mineral of *short-range order*. Minerals with short-range order have usually long-range disorder, such as glass. X-ray diffraction and electron diffraction analysis show no repeat of structural units in any spatial direction. Hence, Parfitt believes that the term *noncrystalline* is more appropriate than the term *short-range order* for allophane.

Another important type of clay in this group is *imogolite*. This clay mineral was reported for the first time in 1962. It was found in weathered volcanic ash or pumice beds, called *imogo* (Yoshinaga and Aomine, 1962). Since then, it has been detected in many volcanic ash soils in Japan, South America, and in the islands of the Pacific.

The composition formula of imogolite is assumed to be:





**FIGURE 6.15** Electron micrographs of imogolite. Left: From volcanic ash soils in Chile (black bar = 1  $\mu\text{m}$ ). (Reprinted from Besoin, E., *Geoderma*, 2, 151–169, 1968. Copyright 1968. With kind permission from Elsevier.) Right: From Kodonbaru soil, Japan (magnification  $\times 862$ ). (Reproduced with the kind permission of the Mineralogical Society of Great Britain and Ireland from Eswaran, H., *Clay Minerals*, 9, 281–285, 1972.)

In many respects, imogolite has chemical characteristics similar to allophane. Several authors believe that allophane is a precursor of imogolite. However, in contrast with allophane, imogolite has a better-defined crystal shape. Electron microscopy shows evidence of the presence of hair-like or spaghetti-like crystal forms. (See Figure 6.15.) The term *paracrystalline* has been suggested for the structure of imogolite. The intermediate phase between allophane and imogolite, or imogolite-like allophane, is called *protoimogolite*. This is allophane with a structure close to that of imogolite but which lacks the crystal order of imogolite. The suggested chemical formula is:



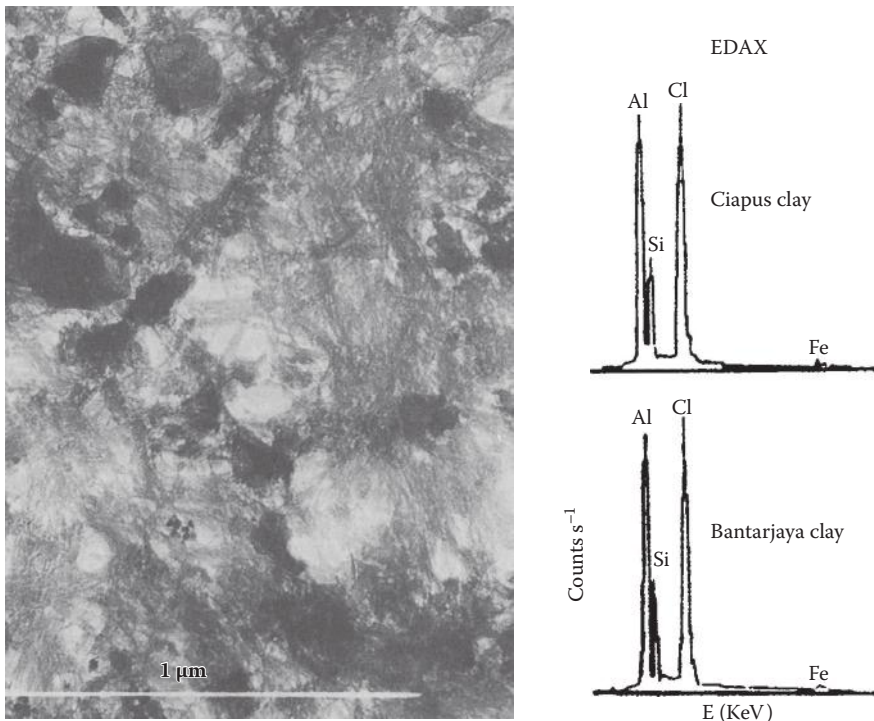
It has a morphology of hollow spherules with an outside diameter of 3.5 to 5 nm. The micrograph of the clay in the volcanic ash soil in Chile (Figure 6.15, left) is protoimogolite, because it is still associated with large amounts of allophane. *True* imogolite often exhibits a dominant hair-like structure as shown in Figure 6.16.

The presence of allophane gives the soil unique properties. Allophane has a large variable charge. It also behaves amphotericly and is reported to fix considerable amounts of phosphates. The CEC is approximately between 20 and 50 mEq/100 g, whereas the AEC ranges from 5 to 30 mEq/100 g. Imogolite has a larger CEC value than allophane. Wada (1977) estimated the CEC of imogolite to be 135 mEq/100 g clay. The hollow structures of both allophane and imogolite provide for the existence of very large specific surfaces for sorption of ions. As with the iron and aluminum oxide minerals, anion adsorption by allophane is also divided into nonspecific and specific adsorption. *Nonspecific adsorption* also refers to electrostatic adsorption, whereas specific adsorption is the adsorption of ions by covalent bonding in the coordination shells of the Al or Fe atoms. The amount of ions adsorbed nonspecifically increases with lower pH. Ions adsorbed by the specific process are considered to be fixed, or, in other words, they can be replaced only with difficulty by other ions. This fixation process is of special importance in phosphate fixation.

The presence of allophane also has an important effect on several soil physical properties. Soils high in allophanic clays are characterized by low bulk density values and high plasticity, although they are not sticky when wet. The water-holding capacity appears to be increased substantially by allophane.

It is assumed that allophane and imogolite will also undergo interaction processes with soil organic compounds, such as humic and fulvic acids. Such an interaction process is called *complex formation* or *chelation*. Most soils containing allophane are known to have black A horizons,





**FIGURE 6.16** Transmission electron micrograph showing the characteristic thin hair-like structure of imogolite and its Al and Si content (right) determined by energy dispersive analysis by x-rays (EDAX). Imogolite was extracted by the method of Yoshinaga and Aomine (1962) from a Ciapus-Andosol, derived from dacitic-andesitic volcanic ash, West Java, Indonesia. The Cl detected by EDAX came from NaCl used in the extraction. (From personal files of the author, University of Georgia.)

extremely high in soil organic matter content. Formerly, these soils were called *andosols* or *ando soils* (from Japanese: *ando* = “black”).

Identification of allophane cannot be done by x-ray diffraction analysis. Because of its amorphous structure, the mineral yields featureless curves. Imogolite exhibits broad x-ray diffraction peaks at 12 Å, at 7.8 to 8 Å, and at 5.5 Å in oriented specimens (Yoshinaga and Aomine, 1962), but the positive identification of imogolite is done by electron microscopy. As shown earlier (Figures 6.15 and 6.16), imogolite has a characteristic hair-like or spaghetti-like structure. Another common method for the detection of allophane is differential thermal analysis (DTA). The DTA curve of allophane is generally characterized by a large and sharp endothermic peak between 50 and 200°C (323 and 473 K), attributed to loss of adsorbed water, and a sharp exothermic peak at 900 to 1000°C (1173 to 1273 K), due to formation of  $\gamma$ -alumina or mullite. Imogolite yields by DTA an endothermic peak at 390 to 420°C (663 to 693 K) because of dehydroxylation (Yoshinaga and Aomine, 1962; Wada, 1977), whereas by infrared spectroscopy, imogolite produces an absorption band at 348 cm<sup>-1</sup> (Farmer et al., 1977; Inoue and Huang, 1990). The importance of acid oxalate and extractable Al and Si has been stressed lately in the characterization of imogolite (Parfitt and Kimble, 1989). It is believed that imogolite exhibits a composition with a characteristic atomic Al/Si ratio of 2 (see EDAX data in Figure 6.16). However, in Si-rich soil, the Al/Si ratio could be <0.2, whereas in Al-rich soil, minerals with Al/Si ratio >2 have also been reported (Farmer et al., 1985; Goenadi and Tan, 1991). This suggests that acid oxalate extraction is a relatively unreliable method for the identification of imogolite. The best method is still electron microscopy, which can show the thread-like or fibrous nature of imogolite. The results of other methods are useful as supporting information.

Allophane and imogolite occur mostly in soils of volcanic origin. These soils have been classified under different names in the past, for example, Andosols, humic allophane soils, Trumao soils, and Kuroboku soils (Tan, 1964). The soils occur extensively in the continents and islands around the Pacific Ocean and have also been found, to a lesser extent, in the West Indies, Africa, Italy, and Australia. In the United States, soils containing allophane are classified first as the Andepts (Inceptisols), but this name was dropped in 1990 in favor of Andisols.

The presence of imogolite was first reported by Yoshinaga and Aomine (1962) in layers of imogo or pumice beds in Japan. Since then, this mineral was detected in many other soils of other countries as discussed above. Although the existence of imogolite was first believed to be associated with volcanic ash soils, the mineral was also detected in spodic horizons of Spodosols derived from nonvolcanic materials (Tait et al., 1978), which seems to be confirmed lately by White (2005). The mineral has also been detected in Ultisols, derived from volcanic ash, in the humid tropics of Indonesia (Goenadi and Tan, 1991). It has also been synthesized in laboratory conditions (Inoue and Huang, 1990).

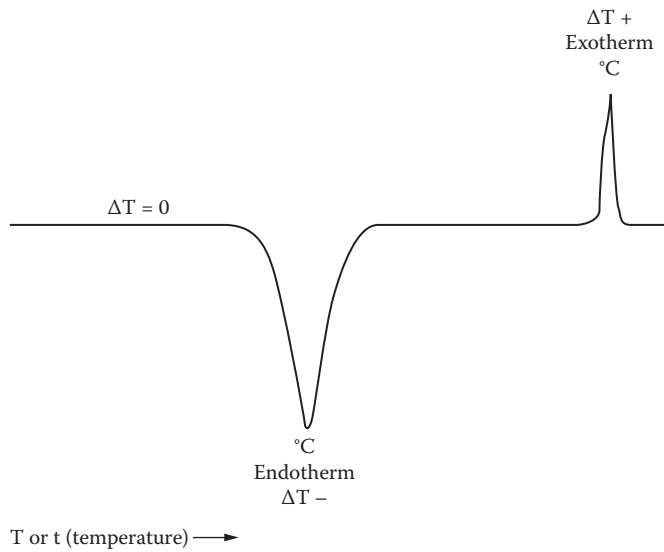
### 6.3 THE IDENTIFICATION OF CLAY MINERALS

In the preceding sections, some of the methods for the identification of clays were mentioned briefly without going into detail on the techniques and physicochemical reactions involved. For better comprehension, it is perhaps necessary to discuss in a little bit more detail three of the major methods often used (e.g., differential thermal analysis [DTA], x-ray diffraction [XRD] analysis, and infrared [IR] spectroscopy). Only the basics and aspects enabling the reader to read, understand, and interpret DTA, XRD, and IR spectra will be addressed in this section. For more details on the respective analyses, refer to Tan (2005).

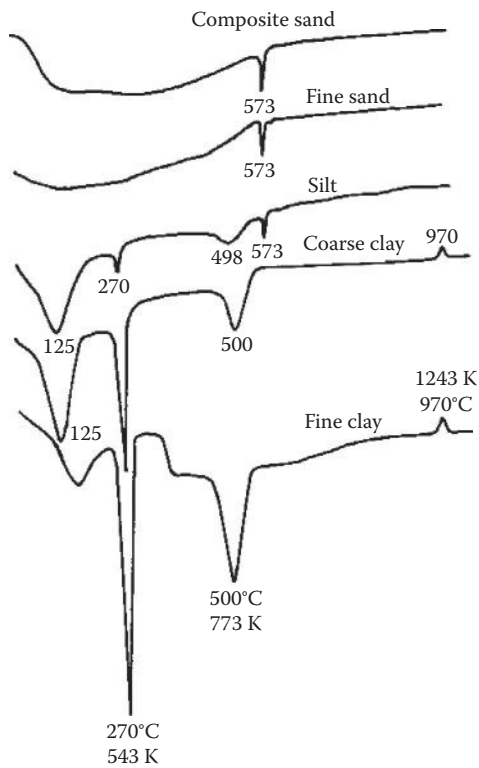
#### 6.3.1 DIFFERENTIAL THERMAL ANALYSIS (DTA)

The differential thermal analysis method, commonly referred to as DTA, is a widely used technique and is particularly useful especially in the identification of amorphous material when x-ray diffraction analysis yields only featureless curves (Tan, 1996, 2005; Tan and Hajek, 1977). It found application first in geology and later was extended to analysis in ceramics, glass, polymer, cement, plaster, and in studies of organic matter, explosives, and radioisotopes.

Differential thermal analysis measures the differences in temperature developed between an unknown and a reference sample, as the two are heated side by side at a controlled heating rate from 0 to 1000°C. The *reference material*, also called *standard material*, is a substance that is thermally inert over the temperature range of the analysis. Heating rates may vary from 0.1 to 2000°C/min. For most purposes, a heating rate of 20°C is used. During the heating process, the unknown sample undergoes a thermal reaction and transformation. The latter is reflected by a difference in temperature between the unknown and reference samples. This difference in temperature is recorded by a set of thermocouples and plotted in a graph, usually against the temperature at which the difference occurs (Figure 6.17). If the temperature of the unknown sample becomes lower than that of the reference material,  $\Delta T$  is negative, and an endothermic peak is produced. When the temperature of the sample becomes higher than that of the reference material,  $\Delta T$  is positive, and an exothermic peak develops. The portion of the curve for which  $\Delta T = 0$  (no difference in temperature between unknown and reference sample) is considered the baseline. Ideally, the baseline is a straight line. Upon analysis by DTA, the mineral may undergo several thermal reactions, culminating in one or a series of endo- and exothermic peaks. The curve with the peaks serves as a fingerprint, and the specific temperatures at which the peaks develop are diagnostic for the identification of the mineral. In addition, the peak height or peak area of the main endothermic reaction can be used for quantitative determination (Tan, 1996, 2005).



**FIGURE 6.17** Idealized differential thermal analysis (DTA) curve.



**FIGURE 6.18** Differential thermal analysis curves of composite sand (2 to 0.05 mm), fine sand (0.25 to 0.10 mm), silt (0.05 to 0.002 mm), coarse clay (0.002 to 0.0002 mm), and fine clay fractions (<0.2  $\mu\text{m}$ ) of a Cecil soil (Ultisols).

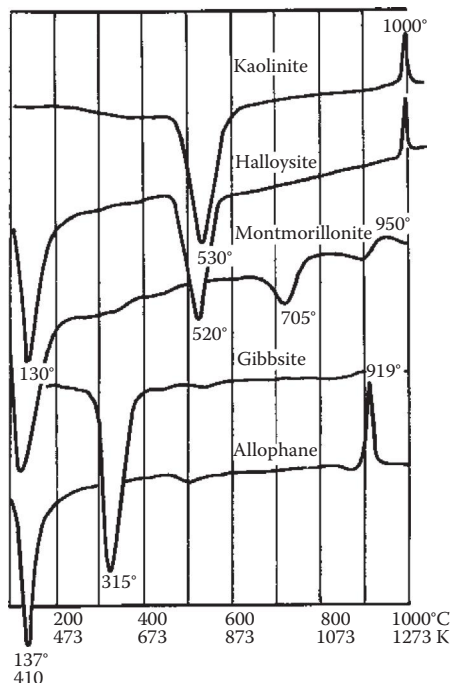
Generally, DTA can be performed with liquid or solid samples. With soil samples, whole soil, sand, silt, or clay fractions can be used. When whole soils are analyzed, the <2 mm fraction should be treated first with 30% H<sub>2</sub>O<sub>2</sub> to remove organic matter, which may interfere by giving strong exothermic reactions. In general, analysis of whole soils gives only peaks of low intensities. These same peaks are very large and intense if the clay fractions are analyzed (Figure 6.18). However, the quartz inversion peak at 573°C (864 K) is often absent in DTA curves of clays. The sand can be analyzed using the total sand fraction (2 to 0.05 mm) or one of the following sand fractions:

Very coarse sand:	2.00 to 1.00 mm
Coarse sand:	1.00 to 0.50 mm
Medium sand:	0.50 to 0.25 mm
Fine sand:	0.25 to 0.10 mm
Very fine sand:	0.10 to 0.05 mm

DTA of sand in U.S. soils shows mostly a strong endothermic peak of quartz at 573°C (846 K), and of primary minerals. Therefore, it is of importance only in the investigation of primary minerals or iron–manganese concretions.

DTA of silt yields curves with peak resolutions between those of sand and whole soils and clays (Figure 6.18). Usually, the thermogram of silt shows more details or complexity than that of sand. The clay fraction of soils (<2 μm) can be used directly or can be separated first, before analysis, into coarse clay (2 to 0.2 μm) and fine clay (<0.2 μm) fractions. For general purposes, the clay fraction <2 μm gives satisfactory results for qualitative and quantitative interpretations. The amount of clay to be used depends on the instruments used. Instruments equipped with well holders need approximately 10 to 100 mg, whereas those equipped with Pt cups placed on ring-type thermocouples need only 1 to 10 mg. In qualitative analysis, it is often unnecessary to weigh the sample for DTA, although comparison of curves should be made with curves obtained from identical amounts of samples. On the other hand, in quantitative analysis, the amount of sample must be weighed accurately, because the height or area of the main endothermic peak increases or decreases proportionally with sample size.

Qualitative identification of minerals can be achieved by using the DTA curves as fingerprints and comparing or matching them with DTA curves of standard minerals or with curves of well-known established minerals. Each mineral exhibits specific thermal reaction features (Figure 6.19). The DTA curve of kaolinite is characterized by a strong endothermic peak at 450 to 600°C and by a strong exothermic peak at 900 to 1000°C. The endothermic peak is caused by dehydroxylation, whereas the exothermic peak is attributed to formation of γ-alumina or mullite or both. The curve of halloysite is almost similar to that of kaolinite but has, in addition, a low-temperature (100 to 200°C) endothermic peak of medium to strong intensity for loss of adsorbed interlayer water. Smectite (montmorillonite) exhibits a DTA curve characterized by a low-temperature (100 to 200°C) endothermic peak, an endothermic peak between 600 and 750°C, and a small dip between 800 and 900°C, followed by a weak exothermic peak between 900 and 1000°C. Gibbsite and goethite are usually characterized by a strong endothermic peak only between 290 and 350°C. Often goethite and the other iron oxide minerals have their endothermic reactions at a higher temperature than gibbsite. Allophane exhibits DTA features with a strong low-temperature (50 to 150°C) endothermic peak, and a strong exothermic peak at 900 to 1000°C. The low-temperature endothermic reaction is attributed to loss of adsorbed water, whereas the main exothermic reaction is caused by γ-alumina formation. For more examples and a complete list of characteristic endo- and exothermic peaks and their temperatures used for identifying the major clay minerals in soils, reference is made to Tan (2005).



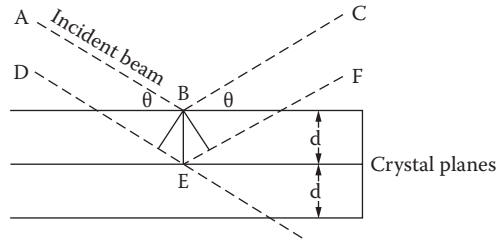
**FIGURE 6.19** Characteristic differential thermal analysis (DTA) thermograms of selected standard clay minerals.

### 6.3.2 X-RAY DIFFRACTION ANALYSIS

The x-ray diffraction (XRD) method is perhaps the most widely used technique in the identification of clays. It is mainly for qualitative analysis, although frequently semiquantitative determination of clays has been carried out. X-ray diffraction analysis is a nondestructive method, meaning that the sample is not affected by the analysis and can be used for other analyses. The unit cells of clays will display a sequence of basal (001) x-ray diffractions with broadening of diffraction signals due to crystal imperfections and thickness (Srodon, 2007). However, the method is not applicable to analysis of amorphous or noncrystalline materials.

The basis for the use of x-rays in the investigation of soil clays is the systematic arrangement of atoms or ions in crystal planes. Each mineral species is characterized by a specific atomic arrangement, creating characteristic atomic planes that can diffract (reflect) x-rays. X-rays are electromagnetic radiation of short wavelength. In most crystals, the atomic spacings, or crystal planes, have almost the same dimension as the wavelength of x-rays. Laue was perhaps the first to discover, in 1912, that x-rays can be diffracted by the atoms in a crystal plane, producing characteristic patterns when recorded. This diffraction pattern is used as a fingerprint in the identification of mineral species.

X-rays are produced in an x-ray tube by fast-moving electrons hitting a metal target. The excited atoms in the target emit radiation with a wavelength between 0.01 and 100 Å, the wavelength of  $K\alpha$  and  $K\beta$  radiation. Most metals emit wide bands of  $K\alpha$  and  $K\beta$  radiation (e.g., Cu target). By using a nickel filter, the Cu  $K\beta$  radiation can be blocked or adsorbed, and the Cu  $K\alpha$  radiation is then isolated for use in the analysis. If a beam of Cu  $K\alpha$  radiation hits a crystal plane of a mineral (Figure 6.20), the x-rays are scattered by the atoms of the crystals. To have diffraction occur, reinforcement of the scattered x-rays must take place in a definite direction. Reinforcement of scattered x-rays becomes quantitative only if *Bragg's law* is obeyed. Bragg's law is defined as follows:



**FIGURE 6.20** An incident x-ray beam diffracting from crystal planes, obeying Bragg's law:  $n\lambda = 2d \sin \theta$ .

$$n\lambda = 2d \sin \theta$$

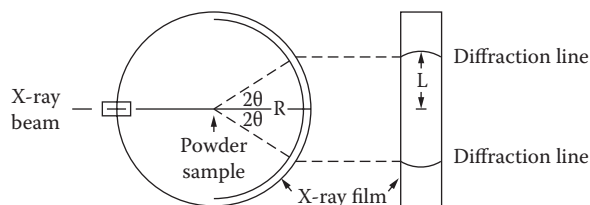
where  $d$  stands for the spacings between atomic planes,  $\lambda$  is the wavelength,  $\theta$  is the glancing angle of diffraction, and  $n$  is the order of diffraction.

The true lattice spacing for the (001) basal plane is the  $d(001)$  or the  $d(hkl)$  spacing. Bragg's law predicts that all planes in a crystal diffract x-rays when the crystal is inclined at certain angles to the incident beam. The angles  $\theta$  depend on the wavelength  $\lambda$  and on  $d$ . If Figure 6.20 is studied, the incident beam DEF has traveled several integral numbers of wavelength ( $n\lambda$ ) farther than incident beam ABC. Diffraction from a succession of equally spaced atomic planes yields a diffraction maximum. If these diffractions are received by a photographic film, a series of spots or lines (bands) are produced. The position of the lines is related directly to the  $d$  spacings.

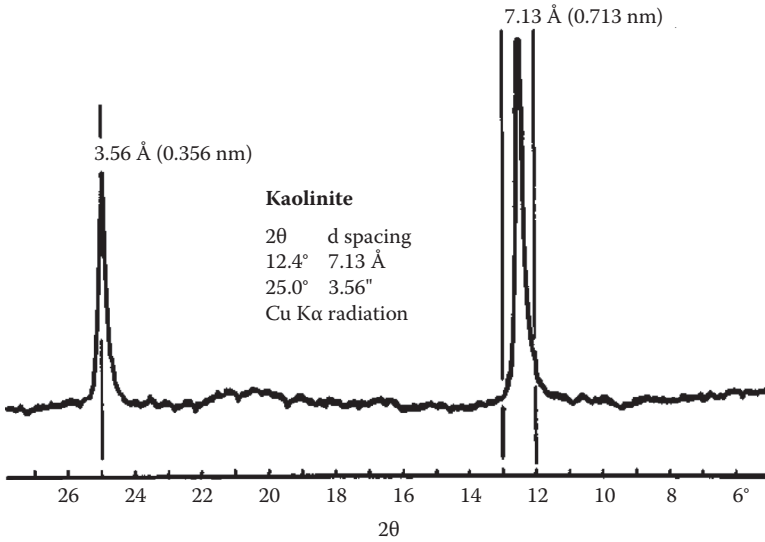
The value  $d(001)/n$ , called *lattice spacing*, can be measured from results of x-ray diffraction analysis. If  $n = 1$ , then  $d(001)/1$  represents the first-order diffraction spacing. If  $n = 2$ , then  $d(001)/2$  represents the second-order diffraction spacing. The series of  $d/n$  values obtained, together with the intensity of the x-ray diffraction peaks, are diagnostic for identification of mineral species.

The accepted unit for lattice spacing is the *angstrom unit* ( $1 \text{ \AA} = 1 \times 10^{-10} \text{ m}$ ), which corresponds to the unit of x-ray wavelength. In some books, the *nanometer* ( $1 \text{ \AA} = 0.1 \text{ nm}$ ) is preferred, whereas in older books, the *kX* unit is used. The *kX* unit is based on the effective spacing of cleavage planes of calcite ( $= 3.0290 \text{ kX}$ ). Conversion of *kX* units into  $\text{\AA}$  units is easily done by multiplying with 1.0020.

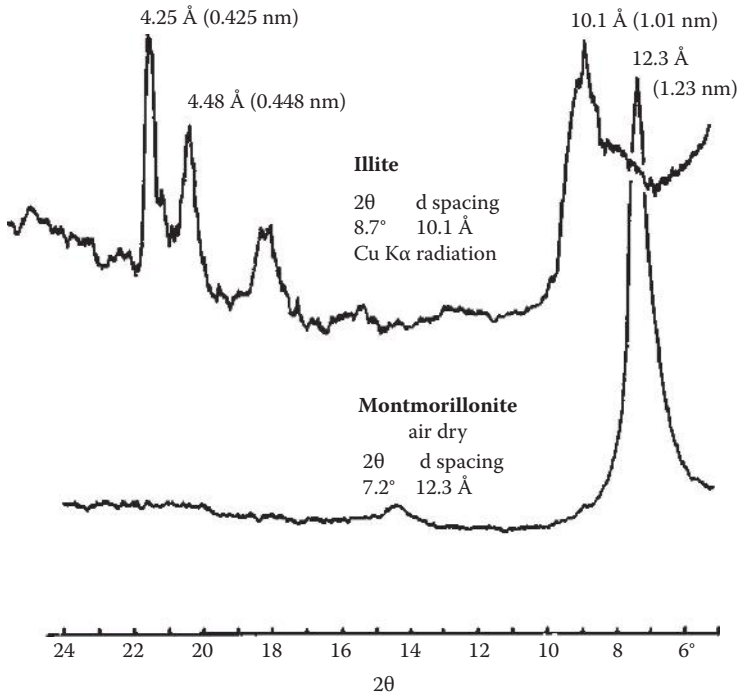
The samples for x-ray diffraction analysis can be prepared as a random powder sample or as an oriented sample. In a random powder sample, the crystals lie in a random position to each other. The powdered sample can be placed in a capillary tube, or with the aid of glycerol or gum tragacanth, the sample is made into a paste and rolled into a rod of 0.3 to 0.5 mm thickness. In the *wedge method*, the paste is pressed into specially designed wedge holders. These random powder samples are usually analyzed by a powder camera x-ray unit (Figure 6.21). As indicated previously, the diffracted x-rays produce lines or bands on a photographic film. The position of the lines corresponds to the  $d$  spacings of the crystal planes of the mineral. With the more modern instruments of today,



**FIGURE 6.21** Random powder x-ray diffraction camera.  $R$  is the radius of the camera, and  $L$  is the distance between the location of the primary beam and the diffraction maximum.  $L$  is calculated using the formula:  $L/2\pi R = 2\theta/360^\circ$ .



**FIGURE 6.22** Interpretation and identification of kaolinite using its x-ray diffraction pattern. A first-order diffraction peak at 7.13 Å (0.713 nm), together with a second-order peak at 3.56 (= 7.13/2) Å, is diagnostic for the presence of kaolinite.



**FIGURE 6.23** Interpretation and identification of illite and smectite (montmorillonite) using their x-ray diffraction (XRD) patterns. Top: A first-order diffraction peak of 10.1 Å is diagnostic for illite. Bottom: A first-order diffraction peak of 12.3 Å points to the presence of smectite (air-dry).



the most convenient method, in mounting powder samples, is to fill the hole of a specimen holder with dry clay, and analyze it immediately, without the use of a camera.

Another popular method of mounting samples for x-ray analysis is to prepare oriented samples on microscopic glass slides or on porous ceramic plates. A clay suspension is made properly and pipetted onto the slide, so that approximately 15 to 25 mg of clay is transferred per 10 cm<sup>2</sup>. After the sample has been allowed to dry at room temperature, it is ready for analysis with a direct recording x-ray spectrometer, in which x-ray patterns are printed on charts. The results are typically shown in terms of  $2\theta$  values. However, a number of tables are available to convert the  $2\theta$  values into d-spacing units (see Appendix D). Generally, clay minerals exhibit d spacings in the range of 3 to 30 Å, which corresponds to 2 to 30°  $2\theta$  angles. The highest intensity of diffraction maxima is obtained from d(001) planes. The first-order d(001) diffraction peak, usually together with the second-order diffraction peak, is diagnostic for the identification of the mineral species. The following illustrations serve as examples.

Kaolinite (Figure 6.22) exhibits a characteristic first-order diffraction peak at an angle of  $2\theta = 12.4^\circ$ . This corresponds after conversion to a d(001) spacing of 7.13 Å (see Appendix D). The second-order diffraction is at  $2\theta = 25^\circ$  angle, which corresponds to a d spacing of 3.56 Å.

Illite exhibits a first-order diffraction peak at an angle of  $2\theta = 8.7^\circ$ , which corresponds to a d spacing of 10.1 Å (Figure 6.23, top). Smectite, or montmorillonite (air dry), is characterized by a first-order x-ray diffraction peak at an angle of  $2\theta = 7.2^\circ$ , which corresponds to a d spacing of 12.3 Å. This peak will shift to 17.7 Å after solvation of the sample. The second-order diffraction peak is usually absent (Figure 6.23, bottom). Gibbsite is identified by the dominant diffraction peak at approximately  $2\theta = 18.4^\circ$ , corresponding to a d spacing of 4.82 Å (Figure 6.24).

Goethite is easily recognized from the dominant peak at approximately  $2\theta = 21.6^\circ$ , corresponding to a d spacing of 4.12 Å.

For additional characteristic d spacing values of other clay minerals, Table 6.4 can be used as a reference. As can be noticed from the d spacings, as listed in Table 6.4, several of the minerals have similar, or overlapping, diffraction peaks. In such cases, pretreatments of samples are required to distinguish these minerals. Four major methods frequently used for pretreating the samples prior to analysis are (1) K saturation, (2) Mg saturation, (3) solvation of Mg-saturated samples, and (4) heating at 500°C. The first three methods stated have the purpose of distinguishing between expanding and nonexpanding minerals (Table 6.5). Potassium saturation will normally effect a collapse of intermicellar spacings, and d spacings of 20 to 17 Å, as exhibited by expanding smectites, may collapse to 10 Å. Reconstitution of the d spacing to 17 Å can be achieved by solvation of Mg-saturated samples. None of these treatments will have any effect on the d spacings of nonexpanding minerals (e.g., kaolinite). Heating at 500°C is usually done to distinguish among vermiculite, chlorite, and kaolinite. Vermiculite may have interlayer hydroxy alumina complexes in its structure. These interlayers will be destroyed by heating at 500°C, with the consequent collapse of the d spacing of vermiculite from 14 Å to 10 Å. On the other hand, heating at 500°C will show no effect on chlorite, though it may produce a second-order peak at 7.2 Å. This peak can be confused for kaolinite. However, heating at 500°C will make kaolinite amorphous to x-ray diffraction analysis, and both the 7.13 Å and 3.56 Å peaks of kaolinite will disappear.

### 6.3.3 INFRARED SPECTROSCOPY

Recently, infrared spectroscopy has found extensive application in clay mineralogical studies. Amorphous as well as crystalline clays absorb infrared radiation, and the method can be used when x-ray analysis makes identification difficult. The infrared absorption spectrum of a mineral has a characteristic pattern that not only permits the identification of the mineral, but also reveals the presence of major functional groups within the structure of the particular compound under investigation.

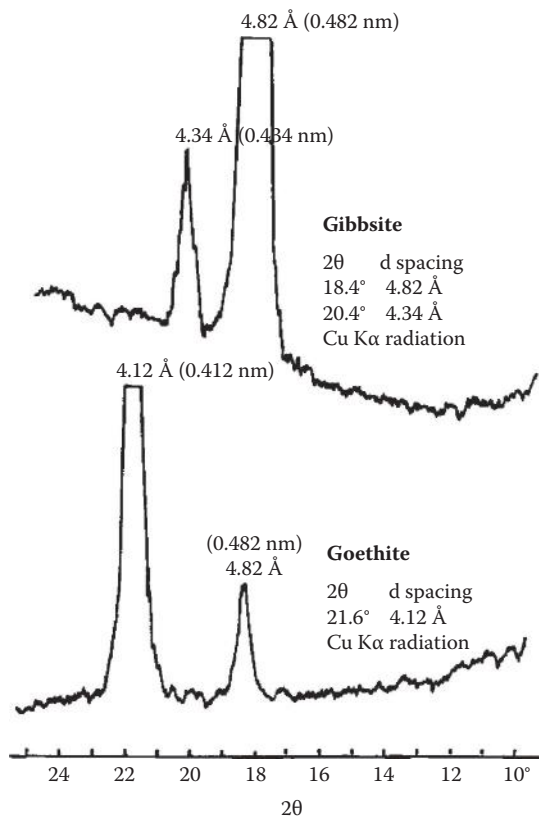
Infrared absorption is related to molecular or atomic vibrations, and only radiation with a similar frequency as that of the vibration will be absorbed. Atoms and molecules within a compound oscillate or vibrate with frequencies of approximately  $10^{13}$  to  $10^{14}$  cps. These frequencies correspond to the frequencies of infrared radiation, and infrared radiation can, therefore, be absorbed by molecular vibrations when the interaction is accompanied by a change in dipole moment. A rapid vibration of atoms yields a rapid change in dipole moment, and absorption of infrared radiation is intense. On the other hand, a weak vibration of atoms produces a slow change in dipole, and consequently, absorption of infrared radiation is relatively weak. Symmetric molecules will also often not absorb infrared radiation.

Molecular or atomic vibrations cause the interatomic distance to change, because the atomic movement, called oscillation, subjects the atoms to a periodic displacement relative to one another. The frequency of vibration obeys the *law of simple harmonic motion*, which is formulated as follows:

$$V=1/(2\pi c)\sqrt{k/m}$$

where  $V$  is the frequency of vibration in  $\text{cm}^{-1}$ ,  $c$  is the velocity of light in vacuum,  $m$  is the reduced mass of the vibrating atoms, and  $k$  is the force constant in dynes/cm.

Two types of vibrations are distinguished: (1) stretching vibrations or deformation, in which the atoms are oscillating in the direction of the bond axis without changing bond angles; and (2)



**FIGURE 6.24** Interpretation and identification of gibbsite and goethite using their x-ray diffraction (XRD) patterns. Top: Gibbsite is identified by a major diffraction peak of  $4.82 \text{ \AA}$  ( $0.482 \text{ nm}$ ). Bottom: A diffraction peak of  $4.12 \text{ \AA}$  ( $0.412 \text{ nm}$ ) indicates the presence of goethite.

**TABLE 6.4**  
**Characteristic d Spacings of Selected Minerals (Cu K $\alpha$  Radiation)**

d Spacing		Intensity <sup>a</sup>	Mineral
Å	nm		
<b>Clay Minerals</b>			
17.7–17.0	1.77–1.70	(10)	Smectite (montmorillonite), solvated
12.0–15.0	1.20–1.50	(8)–(10)	Smectite (montmorillonite), air dry
14.0–15.0	1.40–1.50	(1)	Vermiculite
13.0–14.0	1.30–1.40	(3)–(8)	Chlorite
12.2	1.22		Vermiculite, air dry
11.4–11.7	1.14–1.17	(10)	Hydrobiotite
10.7	1.07		Vermiculite, air dry
10.0–14.0	1.00–1.40		Hydrous mica
10.8	1.08	(10)	Halloysite, hydrated
9.0–10.0	0.90–1.00	(10)	Illite and mica
7.2–7.5	0.72–0.75	(8)	Metahalloysite
7.1–7.2	0.71–0.72	(10)	Kaolinite, dickite, nacrite
6.44	0.644	(6)	Palygorskite
5.90	0.590	(0)–(3)	Smectite (montmorillonite), solvated
5.42	0.542	(5)	Palygorskite
5.00	0.500	(9)	Muscovite
4.7–4.8	0.47–0.48	(9)	Chlorite
4.6	0.46	(5)	Vermiculite
4.6	0.46	(10)	Sepiolite
4.4–4.5	0.44–0.45	(9)	Illite, muscovite
4.49	0.449	(8)	Palygorskite
4.45–4.46	0.445–0.446	(4)–(8)	Kaolinite, dickite, fireclay
4.43	0.443	(6)	Dickite
4.42	0.442	(10)	Metahalloysite
4.40	0.440	(8)	Nacrite
4.35–4.36	0.435–0.436	(6)	Kaolinite, dickite
4.26	0.426	(4)	Dickite
4.20–4.30	0.420–0.430	(5)	Palygorskite
4.17	0.417	(6)	Kaolinite
4.13	0.413	(6)	Dickite
4.12	0.412	(3)	Kaolinite
3.84	0.384	(4)	Kaolinite
3.82	0.382	(5)	Sepiolite
3.78	0.378	(6)	Dickite
3.69	0.369	(5)	Palygorskite
3.56–3.58	0.356–0.358	(10)–(8)	Kaolinite, dickite, nacrite, metahalloysite
<b>Silicates</b>			
9.20–9.40	0.920–0.940	(9)	Talc
9.10–9.20	0.910–0.920	(6)	Pyrophyllite
7.10–7.20	0.710–0.720	(6)	Antigorite
7.10–7.20	0.710–0.720	(6)	Chrysotile
6.30–6.45	0.630–0.645	(4)–(6)	Feldspar
5.40	0.540	(7)	Mullite
4.60–4.70	0.460–0.470	(6)	Talc

(continued)

**TABLE 6.4 (CONTINUED)**  
**Characteristic d Spacings of Selected Minerals (Cu K $\alpha$  Radiation)**

d Spacing		Intensity <sup>a</sup>	Mineral
Å	nm		
4.57	0.457	(5)	Pyrophyllite
4.00–4.20	0.400–0.420	(8)	Feldspar
3.80–3.90	0.380–0.390	(2)–(7)	Feldspar
3.73–3.75	0.373–0.375	(4)–(8)	Feldspar
3.64–3.67	0.364–0.367	(3)–(8)	Feldspar
3.59–3.60	0.359–0.360	(7)	Antigorite
3.59–3.60	0.359–0.360	(6)	Chrysotile
3.44–3.48	0.344–0.348	(3)–(6)	Feldspar
3.39	0.339	(10)	Mullite
3.36	0.336	(3)	Pyrophyllite
3.10–3.25	0.310–0.325	(7)–(10)	Feldspar
<b>Oxides and Hydroxides</b>			
6.25	0.625	(10)	Lepidocrocite
6.23	0.623	(10)	Boehmite
4.96	0.496	(3)	Goethite
4.85	0.485	(3)	Magnetite
4.83	0.483	(10)	Gibbsite
4.72	0.472	(10)	Bayerite
4.62	0.462	(8)	Spinel
4.36	0.436	(8)	Bayerite
4.34	0.434	(6)	Gibbsite
4.29	0.429	(10)	Gypsum
4.21	0.421	(7)	Quartz
4.15	0.415	(10)	Goethite
4.05	0.405	(10)	Crystobalite
3.98	0.398	(10)	Diaspore
3.84	0.384	(6)	Calcite
3.73	0.373	(7)	Ilmenite
3.72	0.372	(3)	Maghemite
3.67	0.367	(7)	Hematite
3.36	0.336	(3)	Goethite
3.35	0.335	(10)	Quartz
3.30	0.330	(3)	Gibbsite
3.30	0.330	(10)	Calcite
3.28	0.328	(9)	Lepidocrocite
3.20	0.320	(6)	Bayerite
3.16	0.316	(10)	Boehmite
3.15	0.315	(4)	Crystobalite
3.06	0.306	(7)	Gypsum

<sup>a</sup> Numbers in parentheses refer to intensity on a scale of 1 to 10, with 1 equaling weak.

**TABLE 6.5**  
**Effect of Pretreatments on d Spacings of Clay Minerals**

d Spacings		Minerals (Air Dry)
Å	nm	
<b>K-Saturated Samples</b>		
14	1.4	Vermiculite, chlorite
10–12	1.0–1.2	Smectite, illite
7.2–7.5	0.72–0.75	Halloysite, metahalloysite
7.15	0.715	Kaolinite, chlorite
<b>Mg-Saturated Samples</b>		
14	1.40	Vermiculite, chlorite, smectite, and illite
10–12	0.10–0.12	Illite, halloysite
7.2–7.5	0.72–0.75	Kaolinite, chlorite
<b>Solvated Mg-Saturated Samples</b>		
17–18	0.17–0.18	Smectite
14	1.40	Vermiculite, chlorite
10–12	0.10–0.12	Illite, halloysite
7.15	0.715	Kaolinite
<b>Heated at 500°C (773 K)</b>		
14	1.40	Chlorite
10	1.00	Vermiculite
7.0	0.700	Chlorite (kaolinite becomes amorphous)

bending vibrations, in which the movement of atoms produces a change in bond angles. The restoring force acting on stretching vibrations is usually greater than that required to restore bending vibrations. Therefore, stretching vibrations occur at higher frequencies than bending vibrations. The highest frequencies observed in minerals are those stretching vibrations of hydroxyl, OH, groups that occur between 3700 and 2000  $\text{cm}^{-1}$ . Bending vibrations occur at lower frequencies, from 1630 to 400  $\text{cm}^{-1}$ .

Liquid, gas, and solid samples can be used in infrared spectroscopy. Liquid samples are usually pipetted or injected into infrared cells provided with a NaCl or KBr crystal window. Gas samples are also introduced into cells, similar to the cells mentioned above. Infrared gas cells are larger than cells for liquid samples and ensure better interaction between infrared radiation and the gas by providing a longer path length. Both NaCl and KBr are infrared inactive and will not interfere in the analysis.

Solid samples should be ground to approximately  $<2 \mu\text{m}$ , because coarse particles tend to produce scattering of infrared radiation. Clay fractions ( $<2 \mu\text{m}$ ) separated by particle size distribution analysis can be used directly or can be separated first by centrifugation into coarse (2 to 0.2  $\mu\text{m}$ ) and fine ( $<0.2 \mu\text{m}$ ) clay fractions. If grinding is necessary, it should be carried out with care, because vigorous grinding tends to destroy the mineral structures (become amorphous) and tends to increase the hygroscopic nature of the sample.

Several methods were proposed for mounting solid samples in infrared analysis: the (1) mull method, and (2) KBr pellet technique, by which a weighted sample (1 to 10 mg) is carefully ground with 100 mg KBr and pressed into a transparent pellet. Sodium chloride also appears to be suitable for use in the pellet method. The use of clay films has recently attracted considerable attention. The present author notices that clay films prepared on infrared cells, such as Irtran-II (ZnS crystal), or NaCl crystals, give better infrared resolutions than clay samples mounted by the KBr pellet

technique (Figure 6.25). However, one disadvantage of the clay film technique is that it takes more time to prepare a clay film than to make a pellet.

In the clay film mounting technique, clay or soil samples are made into a suspension by sonification. They are then pipetted onto Irtran-II window cells, so that 1 mg/cm<sup>2</sup> or 5 mg clay/cm<sup>2</sup> are transferred onto the cells. After air drying at room temperature, the cells are scanned from 4000 to 600 cm<sup>-1</sup> or lower.

Band positions in infrared analysis are indicated in units of frequencies, expressed in terms of centimeters. The frequency  $\nu$ , also known as the *wave number*, is defined as the number of waves, or wavelengths, per centimeter (cm<sup>-1</sup>). It is related to the wavelength  $\lambda$  as follows:

$$\nu = 10^4/\lambda$$

in which  $\nu$  is expressed per centimeter (cm<sup>-1</sup>) and  $\lambda$  in micrometers ( $\mu\text{m}$ ). The region often analyzed by infrared spectroscopy is in the range of 4000 to 600 cm<sup>-1</sup> (equivalent to 2.5 to 25  $\mu\text{m}$ ) or lower. In many instances, the results of infrared analysis are recorded in the transmittance mode. The latter yields curves that have an upside-down appearance when compared with absorption curves (Tan et al., 1978). Two groups of frequency regions usually characterize the infrared curves of most clay minerals:

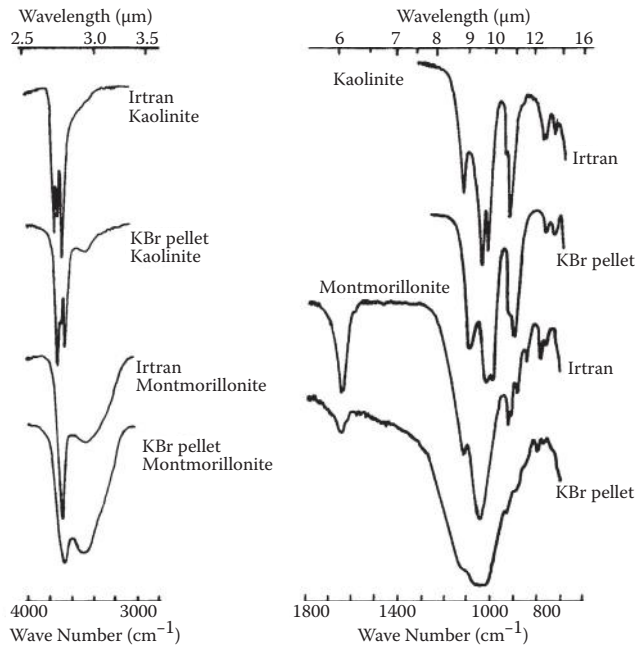
1. Region between 4000 and 3000 cm<sup>-1</sup> attributed to stretching vibrations of adsorbed water or octahedral OH groups, called the *functional group region*.
2. Region between 1400 and 800 cm<sup>-1</sup>, attributed to Al–OH or Si–O vibrations, called the *fingerprint region*.

The infrared curves of kaolinite, smectite, and gibbsite, shown in Figures 6.25 and 6.26, serve as illustrations.

The infrared curve of kaolinite is usually characterized by two strong bands for octahedral OH-stretching vibrations between 3800 and 3600 cm<sup>-1</sup> when the sample is mounted by the KBr pellet technique. An additional third and very sharp band is present at 3670 cm<sup>-1</sup> when the samples are mounted as films on Irtran-II cells. The fingerprint region, or lower-frequency region, exhibits sharp bands for kaolinite at 1150, and 1080 cm<sup>-1</sup> for O–Al–OH vibrations using clay films on Irtran windows. In addition, a sharp 1020 cm<sup>-1</sup> band for Si–O and sharp bands at 910 to 920 cm<sup>-1</sup> for Al–OH vibrations are present. When using KBr pellets, the bands at 1080 and 1020 cm<sup>-1</sup> appear only as a weakly segregated doublet in most analyses reported for kaolinite.

Smectite also exhibits a better-resolved curve with the clay film technique on Irtran-II. The KBr curve is characterized by one broad band followed by a water band, and one additional dominant broad band at 3640, 3420, and 1050 cm<sup>-1</sup>, respectively. However, if one uses clay films on Irtran-II, the bands at 3640 cm<sup>-1</sup> for OH-stretching vibrations and at 1050 cm<sup>-1</sup> for Si–O vibration become very strong and sharp. In addition, bands at 1150, 910, 880, and 850 cm<sup>-1</sup> increase sharply in intensity in clay film samples.

Standard reference gibbsite (purchased from the Wards Scientific Establishment Co.) is characterized by an absorption band at 3620 cm<sup>-1</sup>, and by a doublet at 3540 and at 3480 cm<sup>-1</sup>. In the low-frequency region, gibbsite shows only one dominant peak at 1030 cm<sup>-1</sup> for O–Al–OH vibration. This peak is the reason for determining the kaolinite band at 1080 cm<sup>-1</sup> as a separate independent band, rather than calling it a doublet together with the 1020 cm<sup>-1</sup> band. On the other hand, soil gibbsite (see Figure 6.25, Hayesville B<sub>21t</sub> soil) exhibits an infrared curve characterized by a triplet between 3600 and 3400 cm<sup>-1</sup>, instead of the doublet observed for the reference gibbsite. The 3620 cm<sup>-1</sup> band overlaps with that of the octahedral OH band of kaolinite in the Hayesville clay fraction. Apparently, the different infrared pattern suggests the presence of a different type of gibbsite in the Hayesville soil.



**FIGURE 6.25** Characteristic infrared features of kaolinite and smectite: (left) in the group frequency region, and (right) in the fingerprint region.

#### 6.4 THE SURFACE CHEMISTRY OF SOIL CLAYS

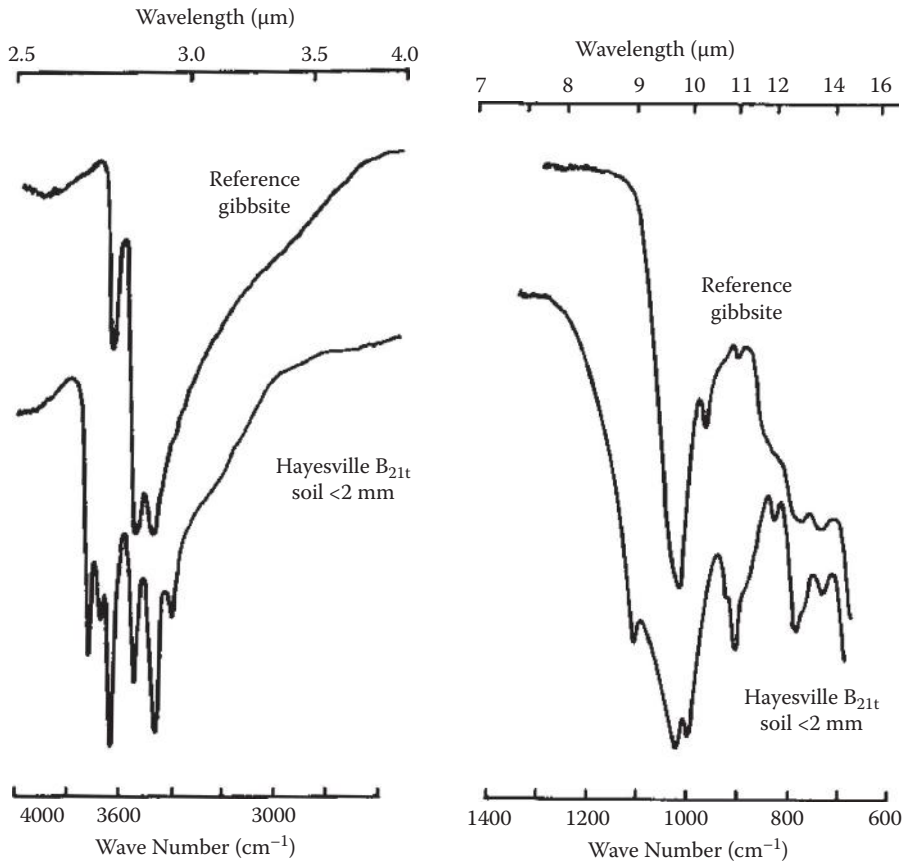
Many, if not all, of the chemical reactions of soil clays are surface phenomena (e.g., cation exchange and adsorption of water). From the preceding section on clay mineral structure, it follows that clay surfaces can be divided into at least three categories:

1. Surfaces formed mainly by Si–O–Si linkages of silica tetrahedrons.
2. Surfaces formed by O–Al–OH linkages of alumina octahedrons.
3. Surfaces formed by –Si–OH, –Al–OH, and –Fe–OH of amorphous compounds.

The first category of surfaces is characterized by surface planes of oxygen atoms, underlaid by silicon atoms of the tetrahedrons. The Si–O–Si bond is called the *siloxane bond* by Sticher and Bach (1966), and because of this, the plane of oxygen atoms can conveniently be called the *siloxane surface*. This type of surface, typical of 2:1 types of clay, can be divided again into *innersphere* and *outersphere* surfaces (Sposito, 1989, 2008). Because the silica tetrahedrons are arranged in hexagonal rings (see Section 6.2.2), hexagonal cavities are developed in the siloxane surface, each of the size of approximately 2.6 Å in diameter. The surface in the siloxane cavity is called the *innersphere surface*, as opposed to the *outersphere surface* located on the exposed site of the siloxane surface. Because the size of a water molecule is 3 Å, water will not be able to penetrate the siloxane cavities, which otherwise would make clays very vulnerable to dissolution and decomposition by water. Therefore, complexing water by the innersphere surface, as reported by Sposito (1989, 2008), will not be possible, but adsorption of cations may be feasible due to their smaller sizes. The charge of a siloxane surface is mainly attributed to isomorphous substitution of the underlying silicon atoms of the tetrahedrons.

The second type of clay surface is characterized by planes of exposed hydroxyl, OH, groups, underlaid by Al, Fe, or Mg atoms in the center of the octahedrons. Because of the latter, the present author suggests it be called the *oxyhydroxy surface*. Kaolinite and other 1:1 types of clays usually



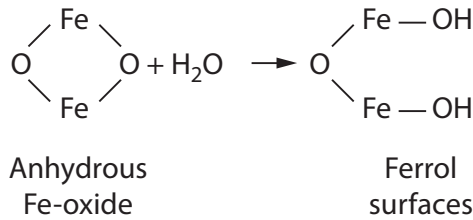


**FIGURE 6.26** Characteristic infrared features of reference gibbsite and soil gibbsite in a Hayesville B<sub>21t</sub> (Ultisols) sample: (left) in the group frequency region, and (right) in the fingerprint region.

have siloxane surfaces on one basal plane, and oxyhydroxy surfaces on the other basal planes. The exposed hydroxyl groups are subject to dissociation and, therefore, play an important role in the development of negative charges.

The third type of surface is formed by  $-\text{Si}-\text{OH}$ , called *silanol surfaces*,  $-\text{Al}-\text{OH}$ , called *aluminol surfaces*, and  $-\text{Fe}-\text{OH}$ , called *ferrol surfaces*. They are typically present in soils containing large amounts of silica gel, amorphous Al- and Fe-oxides, and allophane. However, Sposito (1989, 2008) indicates that aluminol and silanol surfaces can also be present at broken edges of kaolinite and other clay minerals. At the broken edge of the octahedral sheet, OH groups are coordinated to the Al in the octahedron, and at the broken edge of the tetrahedral sheet OH groups are attached to the Si. This type of silanol-OH is believed to behave differently than the OH in the aluminol surfaces at the broken edges. According to Sposito, the silanol-OH is capable only in dissociating its proton due to the larger valence of Si, whereas the aluminol-OH will dissociate its proton as well as adsorb an extra proton. Dissociation of a proton from the silanol-OH produces a negative charge on the broken edge. This may neutralize the positive charge created by protonation of the aluminol-OH, or may increase the negative charge in the event of dissociation of the aluminol-OH. Either way, the production of a zero charge or a negative charge on a broken edge of a mineral is in disagreement with the general idea that broken-edge surfaces of clay minerals are positively charged.

Anhydrous Al- or Fe-oxide surfaces can produce aluminol or ferrol surfaces upon contact with water. The hydration process can be illustrated by the reaction shown in Figure 6.27.



**FIGURE 6.27** Formation of ferrol surfaces by hydration of FeO minerals.

The behavior of these surfaces is expected to be quite different from the siloxane and oxyhydroxy types of surfaces mentioned above. Usually, compounds with silanol, aluminol, and ferrol surfaces have very large surface areas and variable charges, but all the hydroxyl groups are easily accessible.

### 6.5 SURFACE AREAS

In connection with the surfaces of clay minerals is the problem of surface areas, needed for quantitative interpretation of surface properties in relation to soils and clay behavior. The rate of adsorption and cation exchange are proportional to surface area. The surface area generally increases with decreased particle size. It can be measured by several methods, including calculation and adsorption analysis. By using the calculation method, the surface area can be measured in terms of (1) total surface area or (2) specific surface.

#### 6.5.1 TOTAL SURFACE AREAS

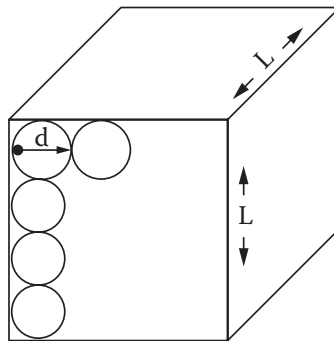
Assume that a cubical container, with side (width)  $L$ , is filled with spherical particles. If the dimension of each sphere is  $d$  (Figure 6.28),  $N$  is the number of spheres in the container, and  $A$  is the total surface area of all spheres, then:

$$N = (L/d)^3$$

because the surface area of one sphere equals  $\pi d^2$ ; hence,

$$A = N\pi d^2 \text{ or } A = (L/d)^3 \pi d^2$$

The *total surface area*,  $A = \pi L^3/d$  square units.



**FIGURE 6.28** Cubical container with sides  $L$ , filled with spheres (balls) with diameter  $d$ .

### 6.5.2 THE SPECIFIC SURFACE AREA

The *specific surface area*, or *specific surface*, is by definition the surface area per unit volume or unit mass of particles.

If the surface area of a sphere equals  $\pi d^2$ , and the volume of the same sphere with diameter  $d$  equals  $1/6\pi d^3$ , then by definition,

$$\begin{aligned} \text{Specific surface, } S &= \pi d^2 / (1/6\pi d^3) \text{ or} \\ S &= 6/d \text{ square units/cubic unit} \end{aligned}$$

If we assume that clay particles are spheres with  $d = 0.002$  mm, then the specific surface of clay is:

$$S = 6/0.002 = 3000 \text{ mm}^2/\text{mm}^3$$

Various types of colloids start to display colloidal properties at different specific surface values. Spangler and Handy (1982) believe that soil constituents begin to exhibit colloidal characteristics when their specific surface reaches values of 6000 to 10,000  $\text{mm}^2/\text{mm}^3$ . However, the value of the specific surface of 3000  $\text{mm}^2/\text{mm}^3$  for the lowest limit, at which the colloidal behavior starts to appear, conforms better with the definition of clays (soil constituents with a diameter  $<0.002$  mm). The specific surface of the fine clay fraction ( $<0.0002$  mm), which is considered the true colloidal clay, is:

$$S = 6/0.0002 = 30,000 \text{ mm}^2/\text{mm}^3$$

The above calculations and discussion are valid only for uniform particles in the form of perfect balls (spheres). In natural soils, clay is plate-like in shape, and its specific surface should be determined with other methods. Its surface area can, for example, be determined by electron microscopy, which is considered the simplest method. Another method is the group of adsorption methods, based on adsorption of compounds in the gas or vapor phase. Depending on the type of reagent used for adsorption by the particles, wide ranges of values are obtained for surface areas. The data in Table 6.6 show some of the variations in surface areas obtained according to adsorption of water, cetyl pyridinium bromide (CPB), or  $\text{N}_2$  gas.

**TABLE 6.6**  
**Specific Surface Areas of Selected Clay Minerals as Determined by Three Different Methods**

Clay Mineral	Total Surface Area ( $\text{m}^2/\text{g}$ )		
	$\text{H}_2\text{O}$ Method	CPB Method	$\text{N}_2$ Gas Method
Smectite	300	800	784
Mica-smectite (interstratified)	57	152	109
Kaolinite	17	15	32
Allophane	484	0	157

*Sources:* Greenland, D. J., and J. P. Quirk, *Trans. Int. Soil Sci. Conf. Commun.* IV and V, Palmerston North, New Zealand, 1962, pp. 79–87; Greenland, D. J., and J. P. Quirk, *J. Soil Sci.*, 15, 178–191, 1964; Dixon, J. B., in *Minerals in Soil Environment*, J. B. Dixon et al. (eds.), Soil Sci. Soc. Am., Madison, WI, 1977, pp. 357–403; Wada, K. In *Minerals in Soil Environments*, J. B. Dixon et al. (eds.), Soil Sci. Soc. Am., Madison, WI, 1977, pp. 603–639.

## 6.6 THE ORIGIN OF NEGATIVE CHARGES IN SOIL CLAYS

As indicated earlier, soil clays ordinarily carry an electronegative charge, which gives rise to cation exchange reactions. This charge is the result of one or more of several different reactions. Two major sources for the origin of negative charges are described in the following sections.

### 6.6.1 ISOMORPHOUS SUBSTITUTION

Isomorphous substitution is believed to be a major source of negative charges in 2:1 layer clays. Part of the silicon in the tetrahedral layer is subject to replacement by ions of similar size, usually  $\text{Al}^{3+}$ . In the same manner, part of the Al in the octahedral sheet may be replaced by  $\text{Mg}^{2+}$ , without disturbing the crystal structure. Such a process of replacement is called *isomorphous substitution*. The resulting negative charge is considered a *permanent charge*, because it will not change with changing pH. Several authors object to using the name *permanent charge*, because they believe that it cannot be used for soil systems in the presence of organic matter, intergrade minerals, and allophane. The Soil Science Society of America subcommittee on soil chemistry terminology drops the use of the term *permanent charge*, and redefines it as “the net negative (or positive) charge of clay particles inherent in the crystal lattice of the particle, and that is not affected by pH changes or by ion exchange reactions” (SSSA, 1997, p. 77; Mehlich, 1981). However, other authors fail to see the improvement in the definition, and feel that the definition is too wordy to be used as a name. Sposito (1989, 2008) used the term *permanent structural charge*,  $\sigma_p$ , which can be calculated by using the following formula:

$$\sigma_p = - (X/M_r)$$

where  $X$  is the layer charge/unit formula, and  $M_r$  is the relative molecular mass, which can be calculated using the formula weight. The symbol  $\sigma_p$  is used here by the author to indicate the permanent charge, instead of  $\sigma_o$  as used by Sposito (1989). Using a formula for smectite or montmorillonite of  $\text{Si}_8(\text{Al}_{3.33}\text{Mg}_{0.67}\text{O}_{20}(\text{OH})_4\text{nH}_2\text{O})$ , and a layer charge/unit formula of 0.50 Eq (Table 6.2), the permanent charge  $\sigma_p$  is then calculated as follows:

$$M_r = (8 \times 28.1) + (3.33 \times 27) + (0.67 \times 24.3) + (20 \times 16) + (4 \times 16) + (4 \times 1) = 719 \text{ g}$$

$$\sigma_p = - (0.50/719)$$

$$= - 0.0006954 \text{ Eq/g} = - 69.5 \text{ mEq/100 g} = - 69.5 \text{ cmol/kg} = - 0.695 \text{ mol/kg}$$

The unit *mol/kg* is in Sposito's opinion the unit for permanent structural charges, which is in fact the International System of Units (SI) unit for cation exchange capacity.

The ease with which isomorphous substitution takes place depends on the size and valence of the ions involved. It occurs only with ions of comparable size. The difference in dimension of substituted ions was reported to be no more than 15%, and the valency between those substituted ions should not differ more than one unit (Paton, 1978). In Figure 6.29, the relative dimensions of a few selected ions are given as illustrations. It can be observed that  $\text{Na}^+$  and  $\text{Ca}^{2+}$  are almost of equal size and can replace one another with relative ease, in spite of the larger valence of  $\text{Ca}^{2+}$ . Potassium is expected to be unable to replace  $\text{Na}^+$  or  $\text{Ca}^{2+}$ , because it is approximately 1.4 times larger than the latter two ions. Magnesium and the iron ions are also of almost equal sizes and may be substituted for each other, the sizes being within 15% difference of one another. Aluminum is between  $\text{Si}^{4+}$  and  $\text{Mg}^{2+}$  or  $\text{Fe}^{3+}$  in size and is capable of replacing, with varying degrees of ease, any of these (Paton, 1978).

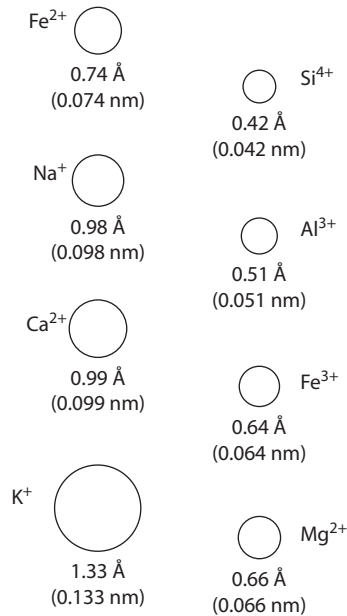


FIGURE 6.29 Relative dimensions of selected ions commonly found in soils.

### 6.6.2 THE DISSOCIATION OF EXPOSED HYDROXYL GROUPS

The appearance of OH groups on crystal edges or on exposed planes, as discussed earlier, can also give rise to negative charges. Especially at high pH, the hydrogen of these hydroxyls dissociates slightly, and the surface of the clay is left with the negative charge of the oxygen ions. This type of negative charge is called *variable charge* or *pH-dependent charge*. The magnitude of the variable charge varies with pH and type of colloid. It is an important type of charge for 1:1 layer, iron and aluminum oxide clays, and organic colloids. Kaolinite has also subbasal hydroxyl groups. Because the latter are surrounded by a network of oxygen atoms from the silica tetrahedrons, it is expected that the dissociation and consequent contribution to negative charges of subbasal hydroxyl groups may be relatively small.

According to Mehlich (1981) the use of the term *pH-dependent charge* is preferred over the term *variable charge*. However, Sposito (1989) retained the name *variable charge* and added a quantitative interpretation to it by formulating the variable charge in terms of *proton charge*  $\sigma_H$ :

$$\sigma_H = m_H - m_{OH}$$

where  $m_H$  = mol/L of H<sup>+</sup> ions, and  $m_{OH}$  = mol/L of OH<sup>-</sup> ions complexed by surface functional groups.

The sum of permanent charge  $\sigma_p$  and variable charge  $\sigma_H$  is called the *intrinsic surface charge*, or  $\sigma_i$ :

$$\sigma_i = \sigma_p + \sigma_H$$

When  $\sigma_H > \sigma_p$ , the soil has a variable charge, and the soils are called *variable-charged soils* by Sposito (1989). When, on the other hand,  $\sigma_H < \sigma_p$ , the soil has a permanent charge, and is called *permanent-charged soils*.

Not only can protons be dissociated from exposed OH groups, but the latter can also adsorb or gain protons, by a process called *protonation of exposed OH groups*. This process, important only in strongly acidic media, creates positive charges. The reactions for dissociation and association of protons can be summarized as follows:



The  $\text{H}^+$  and  $\text{OH}^-$  ions causing the development of surface charges are also responsible for the electric surface potential. Therefore, these two ions are called *potential-determining ions*. The net surface charge will become zero if the negative charge density equals the positive charge density. The pH, at which the net surface charge equals zero, is called the *isoelectric point* or the *zero point of charge* (ZPC) of the mineral.

## 6.7 POSITIVE CHARGES AND ZERO POINT OF CHARGE

Soil colloids may also exhibit positive charges as well as negative charges. The positive charges make possible anion exchange reactions and are very important in phosphate retention. These charges are thought to arise from the protonation or addition of  $\text{H}^+$  ions to hydroxyl groups. The mechanism depends on pH and the valence of the metal ions. It is usually of importance in Al and Fe oxide clays, but it is of less importance in Si-oxides. For example, gibbsite is positively charged at pH 7 or lower.

Gibbsite and other soil colloids may be characterized by a particular pH at which the surface charge is electrically neutral. Previously, this point, or pH value, was called *zero point of charge*, and it is given the symbols  $\text{pH}_0$ . At pH values above  $\text{pH}_0$ , the colloid is negatively charged. At pH values below  $\text{pH}_0$ , the colloid is positively charged.

Some authors recognize three types of ZPCs: (1) ZPC, (2) ZPPC, and (3) ZPNC (Sposito, 1989). The ZPC (zero point charge) is the general ZPC, as defined above. The surface charge at ZPC is then zero, or  $\sigma_p + \sigma_H = 0$ , as defined below. The ZPPC is the zero point proton charge, where  $\sigma_H = 0$ , and the ZPNC is the zero point net charge, where  $\sigma_e + \sigma_{os} + \sigma_{is} = 0$ . In this equation,  $\sigma_e$  is the effective surface charge influenced by diffuse double-layer ions,  $\sigma_{os}$  is the surface charge of the outersphere, and  $\sigma_{is}$  is the surface charge of the inner sphere. Because outer- and innersphere surfaces represent, in essence, the total surface plane of the clay mineral, the sum of outer- and innersphere charges must equal the intrinsic surface charge:

$$\sigma_i = \sigma_{os} + \sigma_{is}$$

because  $\sigma_i = \sigma_p + \sigma_H$ ; hence,

$$\sigma_p + \sigma_H = \sigma_{os} + \sigma_{is} \quad (= 0 \text{ at ZPNC})$$

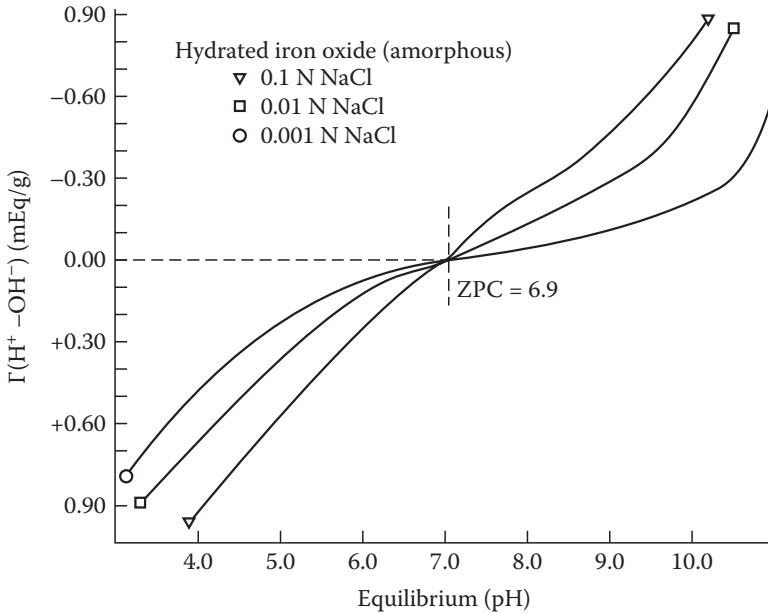
This means that at ZPNC the surface of the mineral has zero charge and will, therefore, not be able to attract a diffuse layer of counterions, making the use of  $\sigma_e$  obsolete.

The ZPC can be determined by either the titration method or by analysis of the amounts of adsorbed cations and anions as a function of pH and concentrations. If  $\text{H}^+$  and  $\text{OH}^-$  ions are the main potential-determining ions, ZPC is usually found by potentiometric titration and calculations using the formula:

$$\sigma = F(\Gamma_{\text{H}^+} - \Gamma_{\text{OH}^-})$$

where  $\sigma$  is the surface charge density,  $F$  is the Faraday constant, and  $\Gamma_{\text{H}^+}$  and  $\Gamma_{\text{OH}^-}$  are adsorption densities of  $\text{H}^+$  and  $\text{OH}^-$ , respectively, in mEq/g.

The titrations are conducted with an indifferent electrolyte using several concentrations. Figure 6.30 presents an example of the presentation of results.



**FIGURE 6.30** Potentiometric titration using NaCl at different strengths in the determination of zero point charge (ZPC) values of amorphous hydrated iron oxide. (From Gast, R. C. In *Minerals in Soil Environments*, J. B. Dixon et al. (eds.), Soil Sci. Soc. Am., Madison, WI, 1977, pp. 27–73. With permission. )

## 6.8 THE USE OF $\Delta\text{pH}$ IN THE DETERMINATION OF NEGATIVE OR POSITIVE CHARGES

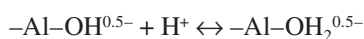
A relatively simple method to determine whether the net charge of the soil colloids is negative, zero, or positive, is the analysis of soil pH in 1 N KCl and in water. The difference between the two pH values is called  $\Delta\text{pH}$  and has been used in soil surveys for soil characterization:

$$\Delta\text{pH} = \text{pH}_{\text{H}_2\text{O}} - \text{pH}_{\text{KCl}}$$

The value for  $\Delta\text{pH}$  can be positive, zero, or negative, depending on the net surface charge at the time of sampling and analysis of the soil (USDA, Soil Survey Staff, 1960, 2006). A positive value for  $\Delta\text{pH}$  indicates the presence of negatively charged clay colloids. A negative value, on the other hand, stands for the presence of a positively charged clay colloid. The ZPC is reached when  $\Delta\text{pH}$  equals zero. This is generally true if only KCl is present in the system, because KCl is considered to be an indifferent electrolyte. If, however, other anions are present that are subject to specific adsorption, they may shift the ZPC value to lower pH regions, and, consequently, render the colloid surface more negative in charge (Mekaru and Uehara, 1972).

## 6.9 SURFACE POTENTIAL

From the above, it is clear that if the  $\text{H}^+$  and  $\text{OH}^-$  are the potential determining ions of reversible interfaces, adsorption of protons produces positive charges, whereas adsorption of  $\text{OH}^-$  ions yields negative charges. These reactions can be summarized by the following relationship (Gast, 1977; Van Raij and Peech, 1972):





This relationship is dependent on pH, whereas at  $\text{pH}_0$  (or ZPC), to maintain electroneutrality, the amount of positive charges must equal that of negative charges.

Because of the presence of opposite charges on the colloid surface and in the liquid phase, an electric potential develops at the solid–liquid interfaces, called the *surface potential*  $\psi$ . The magnitude of the surface potential is given by the Nernst equation:

$$\psi = [(RT)/(nF)] \ln (H^+)/(H^+)_{\text{ZPC}}$$

Changing into common log gives:

$$\psi = 0.059[\log (H^+) - \log (H^+)_{\text{ZPC}}]$$

or

$$\psi = 0.059(\text{ZPC} - \text{pH}) \text{ volts at } 25^\circ\text{C}$$

## 6.10 ELECTRIC DOUBLE LAYER

A double layer or electric double layer is formed when a body (solid, gas bubble, or liquid droplets) is placed in a liquid, forming a structure composed of two layers. The first layer is the surface charge, negative or positive, whereas the second layer consists of ions in the liquid opposite to the surface charges. Such interfacial double layers are common in nature, and especially in soil or clay suspensions. Because of the presence of an electronegative charge, clay in suspension can attract cations. These positively charged ions are not distributed uniformly throughout the dispersion medium. They are held on or near the clay surface. Some are free to exchange with other cations. The negative charge of the clay surface is thus screened by an equivalent swarm of counterions that are positive. The negative charge on the clay surface and the swarm of positive counterions are called the *electric double layer*. The first layer of the double layer is formed by the charge on the surface of the clay. Technically, the charge is a localized point charge; however, we customarily consider this charge to be distributed uniformly over the clay surface. The second layer of the double layer is in the liquid layer adjacent to the clay surface. The positive counterions in this zone are attracted to the clay surface, but at the same time, they are free to distribute themselves evenly throughout the solution phase. The two processes will come to equilibrium, and the resulting distribution zone varies according to the theories existing on electric double layers.

After the development of the earliest double-layer model by Helmholtz in 1879, the concept was modified by Gouy (1910), Chapman (1913), and Stern (1924) into the now classical Gouy–Chapman–Stern diffuse double-layer theory. The concept of Stern is a combination of the Helmholtz and the Gouy–Chapman diffuse double-layer theory. However, even the Gouy–Chapman–Stern double-layer theory is not free from criticism. White (2005) is of the opinion that this popular model apparently does not consider outersphere cation complexes.

### 6.10.1 THE HELMHOLTZ DOUBLE-LAYER THEORY

The Helmholtz double-layer theory is perhaps one of the simplest theories. The negative charge on the colloid is considered to be evenly distributed over the surface (charge density  $\sigma$ ). The total countercharge in the second layer is concentrated in a plane parallel to the surface at distance  $\chi$  (Figure 6.31). If the medium has a dielectric constant  $D$ , then the electrokinetic potential  $\zeta$  is the same as the total potential  $\psi$ :

$$\psi = (4\pi\sigma\chi)/D$$

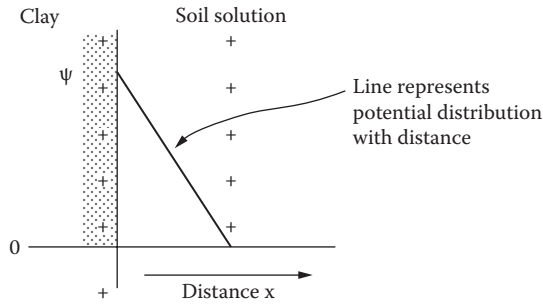


FIGURE 6.31 Helmholtz double layer.

The electrochemical potential is maximum at the colloid surface and drops linearly at locations with increasing distance ( $x$ ) from the surface within the double layer. This is because the value for  $\sigma$  is decreasing very fast with distance from the surface and reaches zero at the border of the double layer.

### 6.10.2 THE GOUY–CHAPMAN DOUBLE-LAYER THEORY

The negative charge is again considered distributed evenly over the colloid surface. However, the counterions are dispersed in the liquid layer, as are the gas molecules in earth's atmosphere. This theory is, therefore, called the *diffuse double-layer theory* of Gouy and Chapman. The concentration distribution in the liquid zone follows the *Boltzmann equation*:

$$C_x = C_x^0 \exp(-ze\psi/kT)$$

where  $C_x$  is the concentration of cations (mol/L) at distance  $x$  from the surface,  $C_x^0$  is the concentration of cations in the bulk solution (mol/L),  $z$  is the valence,  $e$  is the electronic charge,  $\psi$  is the electrical potential,  $k$  is the Boltzmann constant, and  $T$  is the absolute temperature.

Because of the attraction by the negatively charged surfaces, cations in the solution phase tend to distribute themselves over the colloid surface so that electroneutrality is maintained, and the tendency for these ions to diffuse away is counteracted by van der Waals attraction. A deficit of anions is usually present in the liquid interface, and the total charge of the surface is considered to be balanced by excess cations. The initial electric potential at the colloidal surface is maximum and decreases exponentially (Figure 6.32) with distance from the surface as follows:

$$\psi_x = \psi_0 \exp(-Kx)$$

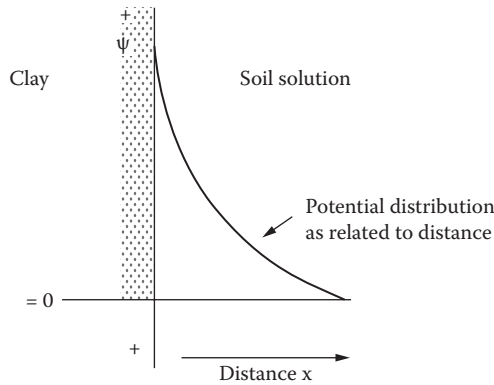
where  $\psi_x$  is the electric potential at distance  $x$ ,  $\psi_0$  is the surface potential, and  $K$  is the constant associated with concentration, valence of ions, dielectric constant, and temperature.

At room temperature:

$$K = 3 \times 10^7 z^{\pm} \sqrt{C}$$

where  $z$  is the valence of the ion, and  $C$  is the concentration of the bulk solution in moles per liter.

The value of  $1/K$  is usually used as a measure of the thickness of the double layer (Verwey and Overbeek, 1948). As indicated by the formula for  $K$ , the thickness of the double layer is suppressed by both  $z$  and  $C$ . If  $C$  increases with a factor of  $4x$ ,  $K$  increases with a factor of  $\sqrt{4} = 2$ . This means that the thickness of the double layer ( $1/K$ ) is decreased  $1/2x$  from the surface. A similar discussion can be given for the valence  $z$ . A more detailed discussion of the effect of valencies and concentration on the thickness of the diffuse double layer is given in Sections 6.10.3 and 6.10.4.



**FIGURE 6.32** Potential distribution in a diffuse double layer.

The Gouy–Chapman diffuse double-layer theory is equally valid for positively charged colloidal surfaces. For a positively charged surface, excess anions will be present in the liquid interface, and a deficit of cations is then expected to occur at the surface.

**6.10.3 THE EFFECT OF ELECTROLYTES ON THE THICKNESS OF THE DIFFUSE DOUBLE LAYER**

Chesworth (2008) indicates that for a typical soil system the thickness is between 1 to 10 nm. However, the thickness of the diffuse double layer is dependent on the electrolyte concentration of the bulk solution. It decreases as the valencies and concentrations of solution electrolytes increase (Table 6.7). In scientific language, it is stated that high concentrations of electrolytes will usually result in suppression of the double layer. By increasing the electrolyte concentration, the amount of cations is increased. The latter reduces the concentration gradient in the liquid interface between the colloidal surface and the surrounding liquid phase. Therefore, the tendency of cations to diffuse away from the surface of the colloids decreases, bringing about a decrease in thickness of the double layer.

**6.10.4 THE EFFECT OF VALENCE OF CATIONS ON THE THICKNESS OF THE DIFFUSE DOUBLE LAYER**

The thickness of the diffuse double layer is also affected by the valence of the exchangeable cations. Generally, it has been reported that at equivalent electrolyte concentrations, monovalent cations in exchange positions yield thicker diffuse double layers than divalent cations (see Table 6.7). Trivalent cations will decrease the thickness of the double layer more strongly than divalent ions.

**TABLE 6.7**  
**Effect of Concentration and Valencies of Ions on Thickness of the Diffuse Double Layer**

Electrolyte Concentration (mol/L)	Thickness of Diffuse Double Layer, 1/K (cm)	
	Monovalent Ions	Divalent Ions
$1 \times 10^{-5}$	$1 \times 10^{-5}$	$0.5 \times 10^{-5}$
$1 \times 10^{-3}$	$1 \times 10^{-6}$	$0.5 \times 10^{-6}$
$1 \times 10^{-1}$	$1 \times 10^{-7}$	$0.5 \times 10^{-7}$

Source: Adapted from Verwey, E. J. W., and J. T. G. Overbeek. *Theory of the Stability of Lyophobic Colloids*, Elsevier, New York, 1948.

This phenomenon is due to the tendency of ions to diffuse away from the colloidal surface (dissociate) in the following decreasing order:

Monovalent ions > divalent ions > trivalent ions

For example, Na and K ions are frequently reported to be responsible for relatively thicker double layers than Ca and Mg, whereas double layers formed by Al ions are comparatively the thinnest.

### 6.10.5 LIMITATIONS TO THE GOUY–CHAPMAN DIFFUSE DOUBLE-LAYER THEORY

The diffuse double-layer theory was developed independently by Gouy (1910) and Chapman (1913) for application on flat surfaces, but it may apply equally well to rounded or spherical surfaces (Verwey and Overbeek, 1948). The negative charge was considered to be evenly distributed over the surface. Because the counterions are assumed to be point charges and, therefore, occupy no spaces, they may reach excessively high concentrations at the liquid interface. White (2005) also believes that the Gouy–Chapman model takes into account only simple electrostatic forces by which cations with similar valence are adsorbed similarly. He indicates that in cation exchange reactions,  $\text{Li}^+$  and  $\text{K}^+$  or  $\text{Ca}^{2+}$  and  $\text{Ba}^{2+}$ , for example, are held or attracted by different forces of the clay surface. Modification to the Gouy–Chapman theory was later presented by Stern (1924), who stated that ions of finite sizes cannot approach the colloidal surface more closely than allowed by their effective radii. Stern's model is, in essence, a combination of the Helmholtz and the Gouy–Chapman concepts, as indicated above.

### 6.10.6 THE STERN DOUBLE-LAYER THEORY

Stern made corrections in the double-layer theory by taking into consideration the ionic dimensions. The influence of ionic dimension is greatest near the colloidal surface. In the Stern theory, the first layer is similar to that of the previous theories. However, the second layer is divided into (1) a sublayer nearest the colloidal surface and (2) a diffuse layer (Figure 6.33). The first sublayer is tightly packed with cations and is called the *Stern layer*. This is the *Helmholtz layer* and should have been named accordingly. The potential distribution appears to be a combination of the Helmholtz and the Gouy–Chapman diffuse double layer. The decrease in potential is also divided into two parts. In the Stern layer, the potential decreases with distance from the surface according to the Helmholtz theory. From here on (in the diffuse layer), the decrease in potential with distance follows the Gouy–Chapman theory.

### 6.10.7 THE TRIPLE-LAYER THEORY

The double-layer theory was developed for studying adsorption, ion exchange, and other surface reactions on silicate clay surfaces. The negative charge on the clay surface, which is by definition the first layer of the double layer, originates from isomorphous substitution within the crystal structure.

However, the surface properties of sesquioxides and other types of clays, exhibiting oxyhydroxy surfaces, are somewhat different from those of silicate clays. The permanent charge in the oxide clays are complemented or *shielded* on the clay surfaces by charges attributed to adsorption of potential-determining ions, which are primarily  $\text{H}^+$  and  $\text{OH}^-$  ions. Because of the presence of a layer of potential-determining ions, adsorption of the traditional counterions is located in a zone further outward of the mineral surface. This model, called the *triple-layer model* (Figure 6.34), was introduced by Yates et al. (1974). Different types of triple-layer models have been presented (Kleijn and Oster, 1983; Bowden et al., 1977). Kleijn and Oster considered the layer of adsorbed potential-

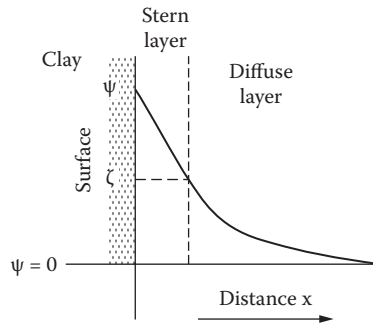


FIGURE 6.33 Stern double layer.

determining ions as an integral part of the solid clay surface. This layer, in fact, is located in the liquid phase. It can perhaps be called the *effective* first layer of the double layer. The next layer, also located in the liquid phase, is divided into two sublayers. They are called *inner* and *outer Helmholtz layers*. The inner Helmholtz layer is the zone for specific adsorption of the traditional counterions, whereas the outer Helmholtz layer represents a zone with a gradual change into a diffuse layer. The Al ions in the figure can be replaced by Fe ions or any other metal ions. In essence, the triple-layer model has some similarities to a Stern double-layer model, and according to the authors above, a triple layer will not develop if adsorption of potential-determining ions is absent. In this case, the Stern double-layer theory must be applied.

### 6.11 THE ZETA ( $\zeta$ ) POTENTIAL

When a colloidal suspension is placed in an electrical field, the colloidal particles move in one direction (toward the positive pole). The counterions move in another direction (toward the negative pole). The electric potential developed at the solid–liquid interface is called the *zeta ( $\zeta$ ) potential*. The seat of the  $\zeta$  potential is the *shearing plane* or *slipping plane* between the bulk liquid and an envelope of water moving with the particle (Figure 6.35). Because the position of the shearing plane is unknown, the  $\zeta$  potential represents the electric potential at an unknown distance from the colloidal surface. Van Olphen (1977) stated that the  $\zeta$  potential is not equal to the surface potential. It is less than the electrochemical potential on the colloid. Perhaps it is comparable with the Stern potential.

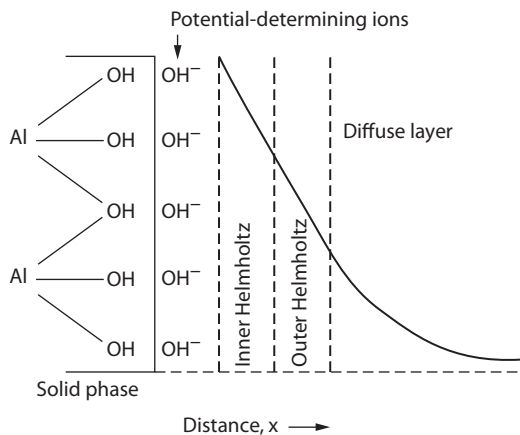


FIGURE 6.34 Triple-layer theory of Yates.

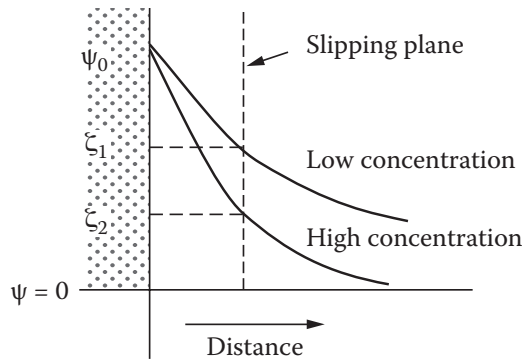


FIGURE 6.35 The zeta ( $\zeta$ ) potential.

### 6.11.1 THE EFFECT OF ELECTROLYTES ON THE ZETA ( $\zeta$ ) POTENTIAL

The thickness of the double layer affects the magnitude of the  $\zeta$  potential. Increasing the electrolyte concentration in the solution usually results in decreasing the thickness of the double layer. Compression of the double layer will also occur by increasing the valence of the ions in the solution.

The  $\zeta$  potential may, therefore, be expected to decrease with increasing electrolyte concentration. It reaches a critical value at the point at which the  $\zeta$  potential equals zero. This point is called the *isoelectric point*. At the isoelectric point, the double layer is very thin and particle-repulsive forces are at a minimum. At and below this point repulsion would no longer be strong enough to prevent flocculation of particles. The  $\zeta$  potential is not a unique property of the colloid, but it depends on the surface potential ( $\psi$ ) of the clay particle. It is determined from the electrophoretic mobility of the suspension using the following formula:

$$V_e = (D\zeta E)/(4\pi\eta)$$

where  $V_e$  is the electrokinetic velocity,  $D$  is the dielectric constant,  $E$  is the applied emf, and  $\eta$  is the viscosity of the fluid.

The  $\zeta$  potential, in fact, is the electrokinetic potential at the slipping plane surface. The surface potential of the colloid is  $\psi_0$ . In dilute solution, the electrokinetic potential has a value represented by  $\zeta_1$ . By adding salt to the solution, the diffuse layer is suppressed and more counterions are forced to the colloid surface within the slipping plane. The slipping plane is considered to be at a fixed distance. Hence, at high salt concentration, a change occurs in the total potential distribution as related to distance from the colloid. The potential distribution at high salt concentration is represented by the bottom curve in the figure. The electrokinetic potential  $\zeta_2$  is, therefore, smaller than  $\zeta_1$ .

## 6.12 THE ELECTRIC DOUBLE LAYER AND STABILITY OF CLAYS

As discussed previously, clays carry negative charges, which are ordinarily balanced by exchangeable cations adsorbed on their surfaces. In suspension, the cations tend to diffuse away from the clay surface into the bulk solution to balance the concentration difference occurring between the interface and the bulk liquid phase. However, a large portion of these ions, especially those in the immediate vicinity of the clay surface, cannot move very far away because of the strong attraction from the negative charge on the clay surface. The cations aggregate in the interface, thereby forming an electric double layer, which may vary in thickness from 50 to 300 Å. Whenever such clay particles approach each other, repulsion between the particles occurs because the outer parts of the double layers have the same type of charges (positive). The suspension is then considered stable, and

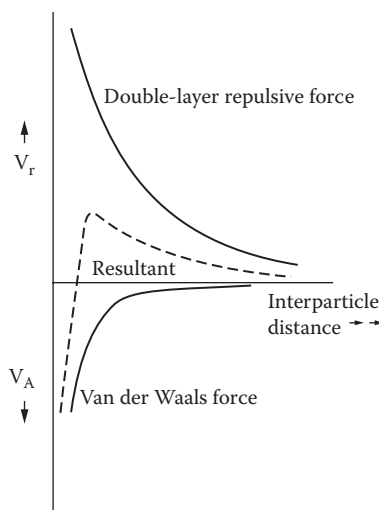
the clay is considered to be dispersed. Because of this approach, the diffuse counterion atmospheres of the two particles interfere with each other. This leads to a rearrangement of the ion distribution in the double layers of both particles. Work must be performed to bring about these changes. The amount of work to bring about the changes is called *repulsive energy* or *repulsive potential*  $V_r$  at the given distance. The range and effectiveness of the repulsive potential depends on the thickness of the double layer. The repulsive force decreases, usually, exponentially with increasing distance between the particles (Figure 6.36). Opposite to the repulsive forces, the clay suspension is also subjected to interparticle attraction. These forces of attraction are usually called the *van der Waals attraction* ( $V_A$ ). The van der Waals attraction is only effective at very close distance, and it decays rapidly with distance. However, because it is additive between atom pairs, the total attraction between particles containing many atoms is equal to the sum of all attractive forces between every atom of one particle and every atom of the other particle. When the interparticle distance decreases to about 20 Å or less, van der Waals forces will become dominant, and the clay particles will flocculate. At interparticle distance of  $>20$  Å, repulsive forces are dominant, creating a stable clay suspension. An illustration of the resultant repulsive and van der Waals forces is shown in Figure 6.36 by the broken line curve.

Repulsion will dominate at low electrolyte concentration. The clay particles are shielded by relatively thick double layers, decreasing the possibility of mutual approach. At high electrolyte concentration, the chances of close approach are made possible by compression of the double layers. In this condition, van der Waals attraction may overcome the repulsive forces and coagulation or flocculation of colloidal particles occurs rapidly.

### 6.13 THE EFFECT OF FLOCCULATION AND DISPERSION ON PLANT GROWTH

The problem of flocculation and stability of soil suspension is very important in soils. Stable aggregates can be formed only in soils containing clay that will flocculate. If clays remain dispersed, the soil is puddled. Puddled soils are sticky when wet and hard when dry.

Root growth and soil aeration require a porous condition in soils. If percolating rainwater leaches out electrolytes from the soil, clay particles may become dispersed. As the soil becomes dry, caking or soil compaction may occur. The latter reduces the pore spaces, which inhibits soil aeration



**FIGURE 6.36** Double-layer repulsive and interparticle attraction (van der Waals) forces as a function of interparticle distance.



necessary for adequate root growth. Therefore, a flocculating concentration of electrolytes should be maintained in the soil. To reach such a condition, the soil should be limed, although acidic soils are usually flocculated because of their high content of Al, Fe, and Mn. However, high Al concentrations, though beneficial for flocculation of clay, are harmful for plant growth. Calcium and Mg are also known to have high flocculation powers on the negatively charged clay particles and will reduce the toxic effect of high Al concentrations.

---

# 7 Adsorption in Soils

The electrochemical properties discussed in the preceding sections find many practical applications in soils. In addition to the effect of flocculation on soil condition and plant growth, they are why soils develop the capacity to adsorb gas, liquid, and solid constituents. Cation exchange reactions, interactions between clay and organic compounds, complex reactions between metal ions, and inorganic and organic colloids are additional implications of the electrochemical behavior of soil colloids.

As can be seen from the preceding chapters, the physicochemical properties of soils are attributed to soil constituents with highly reactive surfaces and large surface areas (e.g., the soil organic and inorganic colloids). Therefore, this colloidal fraction will play a dominant role in adsorption phenomena discussed in this chapter.

Adsorption reactions take place at the surfaces of soil colloids. In the case of the organic colloids (e.g., humic matter), adsorption is related to reaction with their functional groups, such as carboxyl groups and phenolic hydroxyl groups. The principles and fundamental reaction processes of these functional groups were discussed in Chapter 5 on humic acids. Adsorption reactions by inorganic soil colloids are also surface reactions attributed to charged surfaces. Several types of surfaces have been recognized—siloxane, oxyhydroxy, silanol, aluminol, and ferrol, each possessing different types of charges depending on pH. As a result of interactions within the clay surface–ion–water system, or in other words within the interface, the chemical nature of the clay surfaces is modified even further. An example of such a modification was illustrated in Chapter 6 with the development of an electric triple layer.

## 7.1 TYPES OF ADSORPTION

### 7.1.1 POSITIVE AND NEGATIVE ADSORPTION

The process of concentrating materials at the interface is called *adsorption*. Several new books have been published on adsorption, but most of them are rewrites in different styles of established concepts (Inglezakis and Pouloupoulos, 2006), resulting in a lot of noise often confusing the topics.

Adsorption is one of the reactions attributed to the surface chemistry of soil colloids. Materials that decrease surface energy will be concentrated at the liquid–vapor interface, whereas materials that decrease interfacial energy will concentrate more in the liquid–solid interface (Gortner and Gortner, 1949). Adsorption in soils is more like the type of concentrating material found with solid–liquid interfaces. This type of adsorption can be distinguished into positive and negative adsorption. *Positive adsorption* is the concentration of the solute on the colloidal surfaces. It is also referred to as *specific adsorption*. The solute usually decreases surface tension. On the other hand, *negative adsorption* is the concentration of the solvent on the clay surface. The solute is then concentrated in the bulk solution. In this case, surface tension is increased. The soil pH and  $pK_a$  of organic adsorbates have been reported to affect the extent of negative and positive adsorption by soil colloids. In general, it is noted that negative adsorption is dominant at soil  $pH > 4$ , whereas positive adsorption starts to occur at soil  $pH \leq 4$ . Therefore, negative adsorption of organic acids, such as 2,4-D, and 2,4,5-T, seems to occur first until the pH in the soil approaches the  $pK_a$  of the adsorbate, after which positive adsorption takes place and increases as the soil pH decreases (Frissel, 1961). According to Bailey and White (1970), positive adsorption takes place when the soil pH is approximately 1 to 1.5 pH units higher than the dissociation constant of organic acids, and the surface acidity of

smectite is 3 to 4 pH units lower than the pH of the bulk soil. Bailey and White (1970) believe that perhaps the *surface acidity* of the adsorbent may play an important role in the rate and degree of negative or positive adsorption. The term *surface acidity* refers to the  $H^+$  ion concentration (acidity) in the interface. From their research on adsorption of 2,4-D, and 3,4,5-T by smectite, these authors noted that the organic compounds were negatively adsorbed by Na-smectite (pH 6.8) but positively adsorbed by H-smectite (pH 3.35). The difference in adsorption appears to be the result of differences in surface acidity.

### 7.1.2 SPECIFIC AND NONSPECIFIC ADSORPTION

In contrast to the straightforward definitions of positive and negative adsorption, it is a very confused matter with specific and nonspecific adsorption. The issue is that a great number of opinions exist, several somewhat clear, but many others mind boggling at the least. True or false, it appears that many scientists have their own opinions, and a proper, generally agreed upon definition is needed. The term *specific adsorption* was referred to above as positive adsorption and was defined earlier as a type of covalent bonding of solutes by the sorbents. This type of adsorption is also called *chemisorption* by Schwertmann and Taylor (1977). On the other hand, adsorption reaction related to electrostatic bonding of solutes by clay is known as *nonspecific adsorption*. Sposito (1989, 2008) refers specific adsorption to complexation of solutes by innersphere surfaces of clay minerals, whereas nonspecific adsorption is related to complexation of solutes by outersphere surfaces of clay minerals. If a solute does not form a complex with the charged surface of clay, Sposito indicates that it is adsorbed in the *diffuse-ion swarm*. The readers are left to wonder what inner- and outersphere complexes are in simple adsorption of ions to clay surfaces. Section 7.3 may perhaps give some answers. White (2005) added more confusion by spelling out a definition that specific adsorption is “a process caused by an attractive force *over and above* the simple electrostatic force” (p. 137). He recognizes two groups of ions affected by specific adsorption (e.g., group I and II). Group I is composed of monovalent cations listed in increasing order of adsorption as follows:  $Li^+ < Na^+ < K^+ < Rb^+ < Cs^+$ . These cations are believed to form mostly innersphere complexes. A different reason is presented by White than normally held in soil chemistry for the lyotropic series above. White believes that the smaller size Li remains hydrated, whereas Cs is dehydrated at the surface, and hence becomes strongly adsorbed. However, it will take drastic measures—oxidation and hydrolysis—to destroy a hydration shell in aqueous solutions. Hydrophobic bonding and protonation of water molecules are other issues, but generally, when confronted by the negative charge of the clay surface, the  $H_2O$  molecules in the hydration shell of the ion are most likely to become polarized, initiating an adsorption process known as *water bridging*. More information can be found throughout this chapter, especially in Sections 7.2, 7.5, and 7.5.1. Group II, composed of the divalent cations, listed in increasing order of adsorption, is as follows:  $Mg^{2+} < Ca^{2+} < Sr^{2+} < Ba^{2+} < Ra^{2+}$ . It is also reasoned out differently from the traditional concept in the literature on adsorption of divalent cations. In White’s opinion, these divalent cations tend to form outersphere complexes, because they retain upon adsorption their hydration water, apparently in amounts varying according to the lyotropic series. Hence, some of that water or one layer of water molecules may be present between the surface and the cation upon adsorption. This hydration water surrounding Ba is also used by White for explaining why Ba is less adsorbed than K, which is similar in size to Ba. Potassium, K, is claimed to be adsorbed without any hydration water. However, the prevailing concept in the literature is that the hydrated radius of  $K^+$  is much smaller than that of  $Ba^{2+}$ . It is a big difference between *no hydration water* and *thin hydration shell*. Also of interest is the fact that in cation exchange analysis, Ca is used to exchange Ba as easily as Ba is exchanging for Ca. Although Ba, Ca, and Mg are different in crystalline radius, these ions are not much different in hydrated radius (see Table 2.2, Section 2.12); hence, they are expected to be adsorbed or exchanged at equal strength.

## 7.2 ADSORPTION CHARACTERISTICS

Adsorption is dependent not only on the surface charge, but also on the surface area. The amount of material adsorbed is directly proportional to the specific surface. Adsorption is small if the surface area is small, and increases with increased surface areas. The 1:1 layer lattice minerals are known to exhibit low surface areas. The surface area of kaolinite is estimated to be 7 to 30 m<sup>2</sup>/g. This low surface area, together with its low cation exchange capacity, are the reasons for a low adsorption capacity of kaolinite minerals. On the other hand, smectite and vermiculite, with surface areas ranging from 600 to 800 m<sup>2</sup>/g and high cation exchange capacities, are expected to have high adsorption capacities. The adsorption capacity of illite (surface area = 60 to 100 m<sup>2</sup>/g) is intermediate between kaolinite and smectite.

Because cation exchange capacities are related to negative charges, several studies have been conducted to investigate the relation of negative charges to adsorption and cation exchange reactions. The charges of clay minerals can be expressed in terms of total charges or in terms of surface charge densities. The total charges on clay surfaces are attributed to isomorphous substitution and dissociation of exposed hydroxyl groups. As discussed in Chapter 5, isomorphous substitution may occur in the octahedral layers as well as in the tetrahedral sheets. Bailey and White (1970) are of the opinion that the electrical field at the surface, inducing adsorption, may be affected by the location where isomorphous substitution occurs. They believe that charges from tetrahedral positions exert stronger attractive forces than charges originating from octahedral sites. These authors show that ammonium ions are adsorbed more strongly at the surface of clay minerals having a higher tetrahedral charge. The magnitude of the electrical field on clay surfaces, attributable to dissociation of exposed hydroxyls, is pH dependent. It is expected to be low at low pH, but high at high pH; hence, low adsorption may occur at low pH, whereas high adsorption of cations may take place at high pH.

The surface charge density is defined as the number of charges per formula weight divided by the specific surface area:

$$\sigma_0 = e/S$$

in which  $\sigma_0$  is the surface charge density (esu/m $\mu^2$ ; 1 m $\mu^2$  = 100 Å<sup>2</sup>),  $e$  is the number of charges per unit formula, and  $S$  is the specific surface (Fripiat, 1965).

Due to its small specific surface, the surface charge density of kaolinite may be larger than smectite; hence, kaolinite would be expected to have a larger adsorption capacity than smectite. However, Bailey and White (1970) believe that the total charge is more important than the surface charge density in adsorption processes.

Adsorption reactions are *reversible* and *equilibrium reactions*. Sometimes an adsorption process results in chemical changes of the adsorbed material. The changes are of such a nature that desorption is inhibited; hence, the process is neither reversible nor in equilibrium. This type of adsorption is called *pseudo-adsorption*.

Adsorption is characterized by a *positive heat of adsorption*, meaning that energy is released during the adsorption process. The amount of heat produced because of adsorption of gas by solid surfaces can be expressed by the following equation (Gortner and Gortner, 1949):

$$\log h = \log a + b \log x$$

in which  $h$  is the total heat released,  $x$  is the amount of gas adsorbed in cm<sup>3</sup>, and  $a$  and  $b$  are constants. This type of equation represents a linear regression, for which  $\log a$  is the intercept, and  $b$  is the regression coefficient or slope of the regression line, indicating rate (kinetics) of the adsorption process.

Adsorption generally decreases as temperature increases; in other words, adsorption is less at elevated temperatures. This is caused by an increased kinetic energy of the molecules at higher

temperature, which interferes with the concentrating process. In contrast, the rate of a real chemical reaction increases as temperature is increased. Therefore, these differences can be used to distinguish an adsorption process from a true chemical reaction, although a similar equilibrium can be reached.

### 7.3 FORCES OF ADSORPTION

Forces responsible for adsorption reactions include (1) physical forces, (2) chemical forces, (3) hydrogen bonding, (4) hydrophobic bonding, (5) electrostatic bonding, (6) coordination reactions, and (7) ligand exchange. Such a listing, though often reported in many textbooks, is subject to many arguments. Several authors question the significance in regard to physical adsorption, chemical adsorption, and hydrogen bonding as separate, discrete categories. They believe that hydrogen bonding can qualify either as a chemical or as a physical process. On the other hand, protonation, electrostatic bonding, ion exchange, and coordination reactions are, in essence, chemical adsorption processes. In many instances, protonation is closely related to hydrogen bonding.

#### 7.3.1 PHYSICAL FORCES

The most important physical force is the *van der Waals force*. This force is a result of short-range dipole–dipole interactions. Its role is only of importance at close distances, because this type of force decreases rapidly with distance. Because van der Waals forces decay rapidly with distance from the colloidal surface, their effect on adsorption is greatest for ions in close contact with the colloid surface. The less intimate the contact between the solute and the colloid surface, the smaller is the rate of adsorption. Hence, the small and spherically shaped ions will be in closer contact with the surface than the larger ions.

Van der Waals forces are also involved in adsorption of organic cations, anions, and neutral polar and nonpolar organic ions. The adsorption of ethylene glycol and glycerol (neutral organic compounds) in intermicellar spaces of expanding 2:1 minerals is attributed to van der Waals forces. Some organic compounds can be present in soils as neutral compounds or as cations (e.g., 4-phenylpropylpiperidine). When adsorbed in the intermicellar space of expanding lattice clays in the neutral forms, they develop a double-layer complex. However, when these neutral compounds are converted into the cationic forms, the cations develop a single-layer complex. Because of this, the  $d(001)$  spacing of the mineral decreases 0.15 to 0.35 Å in thickness (Brindley and Thompson, 1966). Other examples are adsorption of neutral amines and their subsequent conversion into cationic forms. The neutral amines will also form double-layer complexes, but after conversion into cationic forms, single-layer complexes are formed in the intermicellar spaces of expanding 2:1 minerals.

Adsorption of organic anions or basic organic compounds by van der Waals forces has been reported to occur when the surface acidity of the adsorbents is more than two pH units lower than the dissociation constant of the adsorbates (Bailey and White, 1970). As indicated earlier, the term *surface acidity* as applied here refers to the  $H^+$  ion concentration (or acidity) in the interface.

#### 7.3.2 CHEMICAL FORCES

The chemical force discussed in this section is mainly protonation. Electrostatic bonding and coordination reactions will be discussed separately in Sections 7.3.5 and 7.3.6.

Protonation can occur at the colloid surface, and in the solution phase, as well as in the hydration shells of cations. It is an important force for adsorption of anions and organic compounds basic in nature because of the development of positive charges. Ammonia,  $NH_3$ , is noted to be chemisorbed by clays in the form of  $NH_4^+$ , which, according to Mortland et al. (1963), is a protonated form of  $NH_3$ . The protons are provided by the dissociation of water in the hydration shell of cations or from water in the interlamellar silicate surfaces. Such a dissociation reaction, which occurs especially

with water in the first coordination sphere of interlayer cations, will be discussed in detail in Section 7.5.1.

Protonation of basic organic compounds has been noted to occur by clays saturated with H or Al, and the acquired positive charge will cause the attraction to the negatively charged clay surface. In general, evidence in the literature indicates that protonation of organic compounds in the interface is affected by several factors, such as the basicity of the adsorbate, the nature of the exchangeable cation, the negative charge of the clay mineral, the soil water content, and the surface acidity. The surface acidity is perhaps the most important factor in providing the protons necessary for protonation of anions and basic organic compounds. The surface acidity has been estimated to be approximately two to three pH units lower than the bulk pH, which means a  $H^+$  ion concentration in the interface of 100 to 1000 times larger than in the bulk soil solution (Bailey and White, 1970).

### 7.3.3 HYDROGEN BONDING

As defined earlier, the bond by which a hydrogen atom acts as the connecting linkage is called a *hydrogen bond*. It is believed that hydrogen bonding is related to protonation. Whereas protonation involves a full charge transfer from the electron donor (base) to the electron acceptor (acid), hydrogen bonding is a partial charge transfer (Hadzi et al., 1968). Water, which is dipolar, may become adsorbed at the clay surface through its linkage with hydrogen bonding. Organic compounds, containing functional groups, such as N-H,  $-NH_2$ , OH, and COOH groups, will be adsorbed by formation of hydrogen bonds between the functional groups and the oxygen on the clay surface.

### 7.3.4 HYDROPHOBIC BONDING

This type of bonding is associated with adsorption of nonpolar compounds. The compounds compete with water molecules for adsorption sites, and in the process, adsorbed water is exchanged or expelled by the substance, which is the reason for calling this process hydrophobic. Polysaccharides, for example, can be adsorbed in this way. This is discussed in more detail in Section 12.7.1. The expulsion of water from clay surfaces, especially from intermicellar spaces, reduces swelling.

### 7.3.5 ELECTROSTATIC BONDING

Another type of force in adsorption is electrostatic attraction of substances, which is the result of the electrical charge on the colloid surface. This is the reason for (1) adsorption of water, (2) adsorption of cations, which leads to cation exchange reactions, and (3) adsorption of organic compounds. This may develop into complex reactions.

Both organic compounds and clay minerals are negatively charged and are expected to repel each other. However, protonation of the organic substances may convert them into positively charged ions. The protonation process is made possible by hydronium ions on the exchange sites, or dissociation of adsorbed water, or by proton transfer from water in the hydration shell of adsorbed cations.

An exchange of the adsorbed organic ligand for an inorganic cation is called *ligand exchange*.

### 7.3.6 COORDINATION REACTIONS

The reaction involves coordinate covalent bonding. The latter occurs when the ligand donates electron pairs to a metal ion, usually a *transition metal*. The ligand, therefore, fits the definition of a *Lewis base*, and the metal is then the *Lewis acid*. The compound formed is called a *coordination compound*, *complex compound*, or *organometal complex*. In cases where it involves a reaction between an organic ligand and a metal ion only, the distinction between adsorbate and adsorbent may become obscured. Coordination compounds or organometal complexes are substances containing a central atom, usually a metal, surrounded by a cluster of organic ligands. The total amount

of ligands that can be complexed is dependent on the coordination number of the metal. The terms *innersphere* and *outersphere complex reactions* have been used occasionally to indicate adsorption processes by coordination reaction. Innersphere complexation refers to a direct coordination reaction between the ligand and the metal. As discussed previously, this kind of reaction is called specific adsorption (Bailey and White, 1970; Sposito, 1989, 2008). On the other hand, outersphere complexation refers to bonding of the ligand by water in the hydration shell of the metal (Sposito, 2008; White, 2005). The name of nonspecific adsorption was previously used for this kind of coordination reaction.

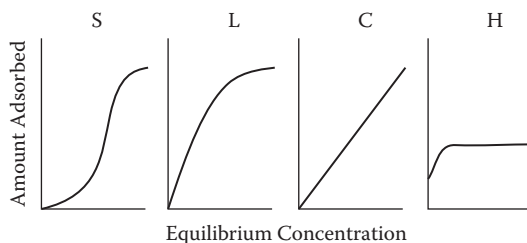
The interaction between humic acids and clay is made possible by coordination reaction. Both compounds are negatively charged and would repel each other. However, cations on exchange sites of the clay surface are capable of forming complexes with humic acids in the solution. In this way, the organic acids are hooked up (adsorbed) to the clay. This will be discussed in more detail in Section 7.7.

### 7.3.7 LIGAND EXCHANGES

This entails the replacement of a ligand by an adsorbate molecule. The adsorbate must have a stronger chelation capacity than the ligand. An example is presented above in Section 7.3.5 in relation to replacement of adsorbed organic compounds by cations. The replacement is not limited to expulsion by cations, but the adsorbed organic ligand can be replaced by other organic substances.

## 7.4 ADSORPTION ISOTHERMS

Adsorption was defined earlier as the concentration of constituents at the colloidal surfaces. The curve relating the concentrations of adsorbed materials at a fixed temperature is called the *adsorption isotherm*. Two methods are available in the use of adsorption isotherms to study the behavior of adsorption reactions: (1) identification of shape and curvature of adsorption isotherms, and (2) statistical formulation, known today as *statistical modeling*, of adsorption isotherms. In the first method, four basic types of adsorption isotherms have been recognized and used to identify the nature of adsorption of solutes from aqueous solutions (Figure 7.1). The S-type represents adsorption reactions when the solid has a high affinity for the solvent, whereas the L-type suggests that the solid has a high affinity for the solute. Both S- and L-type adsorption curves are considered to predict similar things as the Langmuir adsorption isotherm (Choudhry, 1983). The C-type curve is also known as the *constant partition* isotherm. The adsorption process is characterized by a constant partitioning of solute between the solution and adsorbent. According to Weber (1970), this type of adsorption is common when new adsorption sites become available as the solute is adsorbed from the solution. The H-type curve, also called *high-affinity curve*, represents adsorption reactions



**FIGURE 7.1** The four major types of adsorption isotherms on the basis of shape and curvature. (Adapted from Weber, J. B. In *Residue Reviews*, Vol. 32, F. A. Gunther, and J. D. Gunther (eds.), Springer-Verlag, New York, 1970, pp. 90–130; Giles, C. H. et al., *J. Chem. Soc.*, 3973, 1960.)



when the solute has a high affinity for the solid. This type of curve is considered a special type of the L-curve. In dilute solution, the solute is often completely adsorbed and no measurable amount is left in the solution.

The second method of studying adsorption processes is through statistical formulation of adsorption reactions, known today as *statistical modeling*. Four major types of equations have been formulated and are used today to describe adsorption processes: (1) the Freundlich equation, (2) the Langmuir equation, (3) the BET (Brunauer, Emmett, and Teller) equation, and (4) the Gibbs equation.

#### 7.4.1 THE FREUNDLICH EQUATION

A great number of people have reported that the Freundlich equation was actually formulated by *J. M. van Bemmelen* in 1888 (van Bemmelen, 1910). However, Freundlich (1926) greatly popularized its applications, and his name was used for the equation in honor of his efforts (Inglezakis and Pouloupoulos, 2006). Perhaps this is the equation that in all fairness should be called the *van Bemmelen–Freundlich equation*. The adsorption isotherm in many dilute solutions now famous under the name of the *Freundlich equation* is conventionally written as:

$$x/m = kC^{1/n} \quad (7.1)$$

where  $x$  is the amount of material adsorbed,  $m$  is the amount of adsorbents,  $C$  is the concentration of the equilibrium solution,  $k$  is the Freundlich adsorption constant, and  $n$  or, better,  $1/n$  is the Freundlich exponent.

The Freundlich equation has no theoretical foundation and is empirical in nature.

The value of  $1/n$  is usually between 0.2 and 0.7 (Kruyt, 1944). For many pesticides at dilute concentrations  $1/n = 1$  (R. A. Leonard, USDA-ARS, Tifton, Georgia, personal communication). However, if  $1/n = 1$ , the equation becomes a linear equation:  $x/m = kC$ . The curve according to Equation 7.1 is usually parabolic (exponential) and exhibits the following characteristic features: (1) There is no single point indicating that the process is completed, and (2) there is no region of discontinuity.

By replacing concentration  $C$  for pressure  $P$ , the Freundlich equation can also be used to describe adsorption of gases by solids:

$$x/m = kP^{1/n}$$

where  $P$  is the equilibrium gas pressure.

By taking the logarithm, Equation 7.1 changes into

$$\log (x/m) = \log k + (1/n) \log C \quad (7.2)$$

The log equation gives a straight-line, or linear, curve.  $\log k$  is the intercept, and  $1/n$  represents the slope of the curve or the regression coefficient.

Another version of the Freundlich equation is:

$$S = k_d C^n \quad (7.3)$$

where  $S$  is the amount of solute retained/unit mass of soil (mg/kg),  $k_d$  is the distribution coefficient,  $C$  is the solute concentration (mg/kg), and  $n$  is a dimensionless parameter.

Typically,  $n = 1$ , and this is the reason why most of Freundlich's adsorption curves are linear in appearance. The distribution coefficient describes the partitioning of the solute between solid and liquid phases and is considered analogous to the equilibrium constant in the mass action law equation. Strongly adsorbed heavy metals, such as Cu, Hg, Pb, and V, exhibit high  $k_d$  values. The  $k_d$  value

is also affected by pH and the cation exchange capacity (CEC). Soils with high pH and CEC values adsorb larger amounts of the heavy metals.

A third version of the Freundlich equation, called the *van Bemmelen–Freundlich equation* by Sposito (1980, 2008), is formulated as follows:

$$\Gamma = Ac^{\beta} \quad (7.4)$$

where  $\Gamma$  is the amount adsorbed,  $c$  is the concentration of trace metal cations in the aqueous solution bathing the adsorbent, and  $A$  and  $\beta$  are empirical parameters, with  $0 < \beta < 1$ . Therefore,  $\beta$  is positive, but always lower than 1. This equation is in essence not different from Equations 7.1 and 7.3, except for the use of different symbols. By changing  $x/m$  for  $\Gamma$ ,  $k$  for  $A$ , and  $1/n$  for  $\beta$ , a *van Bemmelen–Freundlich equation* is born. It is as if science is shortchanged by playing with symbols to the innocents, and it is quite confusing why the name should only apply to Equation 7.4. Sposito (1980) allegedly used it to describe adsorption of trace metals at constant temperature by clay minerals and sesquioxides in soils, though no data or more info were presented. It is an equation without chemical foundation, but it has the ability to describe adsorption data obtained at constant temperature (Sposito, 1980, 2008), but so do Equations 7.1 and 7.3. The equation has often been associated with adsorption by heterogeneous surfaces. A homogeneous or uniform surface will adsorb ions according to the Langmuir equation, but that was also the concept for Equations 7.1 and 7.3. In general it is noted that the Freundlich equation is obeyed by systems that do not obey the Langmuir equation, which is discussed next.

#### 7.4.2 THE LANGMUIR EQUATION

Another method of statistical formulation of adsorption reactions is given by Langmuir (1918). The Langmuir equation, originally derived for adsorption of gases by solids, is formulated as follows:

$$\theta = (bP)/(1 + bP) \quad (7.5)$$

where  $\theta$  is the amount of gas adsorbed per unit area,  $b$  is a constant related to the free energy of adsorption, and  $P$  is the equilibrium gas pressure.

For adsorption of solutes in solutions,  $P$  can be replaced by  $C$  (equilibrium concentration), and the equation assumes the following formula:

$$x/m = (k_1C)/(1 + k_2C) \quad (7.6)$$

where  $x$  is the amount adsorbed,  $m$  is the amount of adsorbents,  $k_1$  and  $k_2$  are constants, and  $C$  is the concentration of equilibrium solution.

The above is the equation most scientists call the *Langmuir equation* (Sparks, 2002). However, recently this equation was raised to the power of  $\beta$ ,  $\alpha$ , or  $x$ , which was then written as follows:

$$x/m = k_1C^{\alpha}/(1 + k_2C^{\alpha})$$

and Sposito (2008) calls this the *Langmuir–Freundlich equation*.

If  $\alpha = 1$ , the Langmuir–Freundlich equation reverts to the plain Langmuir equation as shown by Equation 7.6.

The difference of the Langmuir from the Freundlich equation is the following. At very high concentrations, the value of  $k_2C$  in Equation 7.6 reaches such a high value that the factor 1 can be neglected, so that the formula changes into:

$$x/m = k_1/k_2$$

This formula states that  $x/m$  becomes constant at high concentrations. In other words, at high values of  $C$ , the surface of the adsorbents becomes saturated, and adsorption reaches a maximum.

On the other hand, at very low concentrations, the value of  $k_2C$  becomes so low compared to the factor 1 that it can be neglected. The equation then changes into:

$$x/m = k_1C$$

This equation is the Freundlich equation in which  $1/n = 1$ . In the author's opinion, even such reasoning is perhaps not sufficient to justify the creation of a new name, unless a new concept of adsorption different from the established *Langmuir's* is introduced.

According to Bailey and White (1970), the Langmuir equation is useful only for monolayer adsorption, which is generally the case for chemisorption, adsorption from solution, and physical adsorption of gases. Bailey and White are of the opinion that the use of the Langmuir equation should give a linear or straight-line curve in order to be considered applicable for a given set of data. As indicated earlier, in those cases when the Langmuir equation is not obeyed by the system, the Freundlich equation should be used.

Recently, questions arise about possible reassessment on the use of the Freundlich and Langmuir equations in describing adsorption processes in soils (Harter and Smith, 1981; Weber, 1970). Adsorption of solutes by solid surfaces in soils is not exactly a simple reaction, but with the increased knowledge in soil chemistry, adsorption appears to be a very complex process. Weber (1970) believes that the adsorption by solid surfaces is a preferential or selective adsorption process. In the preceding chapters, it is indicated that in the soil solution, water molecules are adsorbed on the clay surfaces. It was thought that this adsorbed water must be displaced first if the solute is to be adsorbed. In a system such as the soil solution, many different types of solutes may compete with each other and with adsorbed water for adsorption sites. The problem will become very complex when it is realized that the soil contains a variety of organic and inorganic ions in various stages of hydration participating in the adsorption reaction. Such a complex situation is then the reason, according to Weber (1970) and Harter and Smith (1981), that the Freundlich and Langmuir equations are often not adequate to describe complex adsorption reactions. These authors suggest other methods in describing adsorption, and in particular, using methods or equations that can differentiate between the possible different adsorption reactions occurring in soils.

### 7.4.3 BET AND GAB EQUATIONS

The Langmuir adsorption equation is useful only for simple adsorption reactions involving monolayer adsorption. For multilayer adsorption, the use of the BET equation is suggested. In this respect, the BET equation is considered an extension of the Langmuir equation.

The *BET equation* was developed by Stephen Brunauer, Paul Hugh Emmett, and Edward Teller in 1938 for the adsorption of multilayers of nonpolar gases (Brunauer et al., 1938). This equation was revised in 1946 by Brunauer, Deming, Deming, and Teller (Bailey and White, 1970). The BET-BDDT equation at low pressure is formulated as follows:

$$P/[V(P_0 - P)] = 1/(V_m C) + [(C - 1)/(V_m C)](P/P_0) \quad (7.7)$$

where  $P$  is the equilibrium vapor pressure,  $P_0$  is the saturation vapor pressure,  $V$  is the volume of gas adsorbed,  $V_m$  is the volume of gas adsorbed when the solid is covered with a monolayer, and  $C$  is the constant related to heat of adsorption.

It is assumed that the first layer of gas is attracted (adsorbed) firmly to the surface, perhaps by van der Waals forces. The second and subsequent layers are held by gradually weaker forces. As  $P/P_0$  increases, the layers of gases are building up in an unrestricted way. The number of layers becomes infinite when  $P/P_0$  is unity ( $= 1$ , because  $P = P_0$ ). If  $P/[V(P_0 - P)]$  is plotted against  $P/P_0$  (as the abscissa), a straight-line, or linear, curve should be obtained. The slope (regression coefficient)

is characterized by the factor  $(C - 1)/(V_m C)$ , and the intercept is at  $1/(V_m C)$ . From the slope and intercept values, the factors  $V_m$  and  $C$  can be calculated.

According to Bailey and White (1970), the BET equation can be used to describe five types of adsorption reactions: (1) monolayer adsorption (which is, in essence, the Langmuir type of adsorption), (2) sigmoid-shape monolayer adsorption, (3) monolayer adsorption plus capillary condensation, (4) multilayer adsorption, and (5) multilayer adsorption plus capillary condensation.

Recently, an extension of the BET model was developed called the *Guggenheim–Anderson–de Boer* (GAB) equation. This equation has been presented in many forms (Agrawal et al., 2003; Caurie, 2006), and below is one of them:

$$W = W_m C_g k (P/P_o) / [1 - k (P/P_o)] [1 - k (P/P_o) + C_g k (P/P_o)] \quad (7.8)$$

in which  $W$  is the weight in grams of adsorbed water/g solid,  $W_m$  is the weight in grams of a monolayer of adsorbed water, and  $C_g$  and  $k$  are parameters related to heat of adsorption of the monolayer and intermediate layer, respectively.

The molecules in the intermediate layer are considered to interact with the solid surface, but it is a weak interaction compared with that between the solid and the monolayer. The GAB equation has been successfully applied to sorption of water by food, cellulose, and other materials, and seems to be popular especially in food and pharmaceutical sciences.

#### 7.4.4 THE GIBBS EQUATION

The Gibbs equation describes processes in relation to surface tension and is formulated as follows:

$$\Gamma = -(a/RT)(\partial\gamma/\partial a)_T \quad (7.9)$$

where  $\Gamma$  is the surface concentration of adsorbed material (moles/cm<sup>2</sup>),  $a$  is the activity of solute in moles,  $R$  is the gas constant,  $T$  is the absolute temperature (K), and  $\gamma$  is the surface tension in dynes/cm.

The solute is adsorbed on the surface of the adsorbents if  $\partial\gamma/\partial a$  is negative ( $\Gamma =$  positive). This type of adsorption is called *positive adsorption*. Therefore, positive adsorption occurs when the solute decreases surface tension. If  $\partial\gamma/\partial a$  is positive ( $\Gamma =$  negative), the solute is more concentrated in the bulk solution than in the interface region. The latter is sometimes called *negative adsorption*. In this case, the solute increases surface tension. The Gibbs equation finds primary application in adsorption at liquid–gas interfaces. It is very difficult to use this equation in adsorption reactions at solid–liquid interfaces, because it is impossible to measure the surface tension of solid surfaces.

In many other books, the Gibbs adsorption equation is written as:

$$-d\gamma = \sum \Gamma_i d\mu_i \quad (7.10)$$

in which  $\mu$  is the chemical potential of species  $i$ . Because  $\mu = \mu^o + RT \ln a$ , Equation 7.10 can be changed into:

$$-d\gamma = \Gamma d(RT \ln a)$$

Rearranging gives:

$$\Gamma = -(1/RT)d\gamma/d \ln a$$

or

$$\Gamma = -(a/RT)d\gamma/da$$

(for more details of derivation, see Rao et al., 2005), which is the Gibbs formula given as Equation 7.9. Norde (2003) calls the Gibbs equation also the *Gibbs–Duhem* model. Because this book is about principles only, to those interested in seeing the relationship of the Gibbs–Duhem model, reference is made to Norde above.

## 7.5 ADSORPTION OF WATER

Water is held in the soil in the pore spaces by forces of attraction at the colloid surfaces, by surface tension in the capillaries, and by attraction to the ions. In a wet condition, all the pores of the soil are filled with water. The soil is considered to be at its *maximum retentive capacity*. In this condition, the matrix potential  $\psi_m$  is zero. The excess water is free to move in the soil by gravity. The movement, called *drainage*, usually results in several undesirable effects, such as waterlogging and leaching of nutrients.

As soon as excess water has drained away by gravity, water occurs in the macropores as thin layers (films) on the surfaces of soil particles and as wedges at the points of contacts between the particles. The micropores, on the other hand, are still filled with water. Such a condition is called *field capacity*. The force holding this water is approximately 0.2 to 0.3 bars. Living plants must satisfy their water need from field capacity water, by applying suction forces that can overcome the forces of adhesion, cohesion, and osmosis. As the water is taken up by the roots, the water films on soil particle surfaces become thinner. Hence, the forces of adsorption and retention become larger. A point will eventually be reached at which the attraction of water by soil particles becomes so large that the plants can no longer extract enough water to satisfy their needs. This point is called the *permanent wilting point*. The amount of water at this point is called the *permanent wilting percentage*. The force holding this water to the soil particles is estimated to be 15 bars.

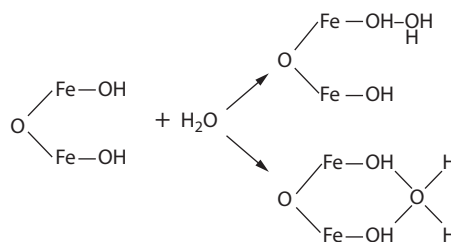
The solid particles of importance in adsorption of water are (1) silicate clays, (2) hydrous oxide clays, and (3) soil organic matter.

### 7.5.1 ADSORPTION OF WATER BY SILICATE AND HYDROUS OXIDE CLAYS

The adsorption of water by silicate clays is attributed to electrostatic forces and takes place at external surfaces and in intermicellar spaces. As discussed earlier, the dimension of the *innersphere surfaces* is too small for the penetration of water; hence, the inner surfaces are unavailable for adsorption of water.

Adsorption of water by hydrous oxide clays is attributed to (1) electrostatic forces and (2) hydrogen bonding by structural protons on the surfaces of iron and aluminum hydrous oxides. The latter can be illustrated as in Figure 7.2.

Upon adsorption, orientation of water takes place by the electrical field on the surface of the clays, and the water molecules lose some of their freedom of movement. In terms of thermodynamics, it



**FIGURE 7.2** Adsorption of water by hydrogen bonding on structural protons of Fe oxides.

is said that the free energy of water has been decreased upon adsorption. This part of the energy is lost in the form of heat, as noticed by an increase in temperature at the wetting front as water reacts with soil. According to the BET adsorption theory, the heat of adsorption of the first layer of water is given by the constant  $C$  in Equation 7.7.

The constant  $C$  can be found from the following relation:

$$C = a \exp [(Q_1 - Q_L)/(RT)] \quad (7.11)$$

where  $a$  is the proportionality constant,  $Q_1$  is the heat of the first adsorbed layer of water,  $Q_L$  is the heat of liquefaction (becoming liquid, or condensation of vapor),  $R$  is the gas constant, and  $T$  is the absolute temperature (K)

For practical purposes,  $a = 1$  (Taylor and Ashcroft, 1972) and Equation 7.11 can be changed into:

$$C = e \exp [(Q_1 - Q_L)/(RT)]$$

In ln form, this equation becomes:

$$\ln C = [(Q_1 - Q_L)/(RT)] \ln e$$

Because,  $\ln e = 1.0$ , and hence,

$$\ln C = (Q_1 - Q_L)/(RT)$$

Conversion into log ( $2.303 \log = \ln$ ) gives:

$$2.303 \log C = (Q_1 - Q_L)/(RT) \quad (7.12)$$

The heat of adsorption, or the difference in energy of adsorption at the interface,  $Q_1 - Q_L$ , varies with the type of clay minerals. Taylor and Ashcroft (1972) reported that it was low for illites and other 2:1 types of minerals, but that it was comparatively higher for kaolinite and other 1:1 types of clays.

Clays with large internal surfaces are also capable of adsorbing water in the intermicellar regions, and interlayer hydrates can be formed. The degree of stability and the structure and characteristics of interlayer water are dependent on the presence of interlayer cations and on the composition of the interlayer clay surfaces. Interlayer water reacts both with the oxygens of the siloxane surface and with cations present in the intermicellar spaces. In the event that only one to three layers of water are adsorbed, some degree of water stability has been noted. Because of the strong bonding of this water, the behavior of the adsorbed interlayer water is relatively static. On the other hand, when more water layers are adsorbed in internal spaces, this water behaves more like liquid, and a higher degree of mobility is then exhibited. Interlayer water can form a link between cations and the negatively charged clay surface. They also are capable of donating protons to bases in interlayer positions and can donate or accept electrons from two neighboring ions. These processes were discussed in the preceding sections as an important reaction in protonation of compounds enabling them to be adsorbed by clay surfaces. Proton transfer from water to anions and bases often takes place more readily in the intermicellar spaces than in the free soil solution. Formation of protonated bases in interlayer solutions is considered the result of increased acidity and ionization of interlayer water.

The adsorption of water in intermicellar spaces of expanding 2:1 lattice-type clays (e.g., smectite) usually results in an increase in basal spacings, as determined by x-ray diffraction analysis. The data in Table 7.1 seem to confirm that the amount of water present and the nature of the interlayer cation both have an influence on adsorption. However, increased humidity appears to expand the lattice space more than the type of cation.

**TABLE 7.1**  
**Basal,  $d(001)$ , Spacings ( $\text{\AA}$ ) of Smectite Saturated with**  
**Different Cations, as Affected by Interlayering with**  
**Adsorbed Moisture**

	Interlayer Cations					
	Li <sup>+</sup>	Na <sup>+</sup>	K <sup>+</sup>	Ca <sup>2+</sup>	Mg <sup>2+</sup>	Ba <sup>2+</sup>
Increasing	09.5	09.5	10.0	09.5	0.95	09.8
humidity	15.4	15.4	15.0	15.4	15.4	15.5
↓	19.0	19.0		18.9	19.2	18.9
	22.0					

Source: Norrish, K., *Disc. Faraday Soc.*, 18, 120–134, 1954.

Two types of interlayer water can be distinguished: (1) water in the first (inner) hydration shell coordinated around the interlayer cation, and (2) water in the secondary (outer) coordination sphere of the cation. The latter is more mobile than water in the first coordination sphere. The presence of these two types of interlayer water was discovered by x-ray analysis and infrared spectroscopy. With infrared analysis, water in the two coordination spheres is distinguished by differences in intensities of infrared absorption at 3600 to 3400 and at 1620  $\text{cm}^{-1}$ , for OH-stretching and OH-bending vibrations, respectively, of the water molecule. Water in the first coordination sphere has an infrared absorption at 3600  $\text{cm}^{-1}$  and a very strong absorption at 1620  $\text{cm}^{-1}$ , perhaps because of the weaker hydrogen bonding involved in the adsorption process. In contrast, water in the second coordination sphere, or the more mobile water, exhibits a spectrum similar to that of free water, with absorption bands between 3600 and 3400  $\text{cm}^{-1}$  and a relatively weak band at 1620  $\text{cm}^{-1}$ . The OH-stretching vibration of interlayer water between 3600 and 3400  $\text{cm}^{-1}$  is usually difficult to observe, because structural OH groups of smectite may also absorb at or near 3600  $\text{cm}^{-1}$ .

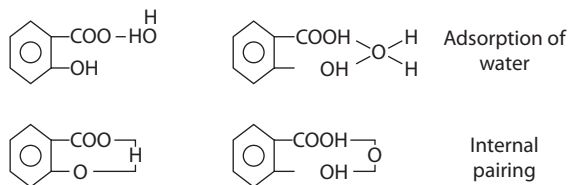
Interlayer water can be displaced by other polar compounds. Generally, water adsorbed in the second coordination sphere is more easily displaceable than water held in the first coordination shell. Several polar compounds, such as pyridine and nitrobenzene, are capable of displacing the mobile interlayer water from the outer shell. Removal of water from the first coordination shell takes place only by treatments that effect dehydration of the cation. This displacement of water from the primary shell causes the cation to polarize the residual water, with the consequent dissociation of the water molecules. The protons produced by the dissociation reaction may be used for protonation of other organic compounds.

### 7.5.2 ADSORPTION OF WATER BY ORGANIC MATTER

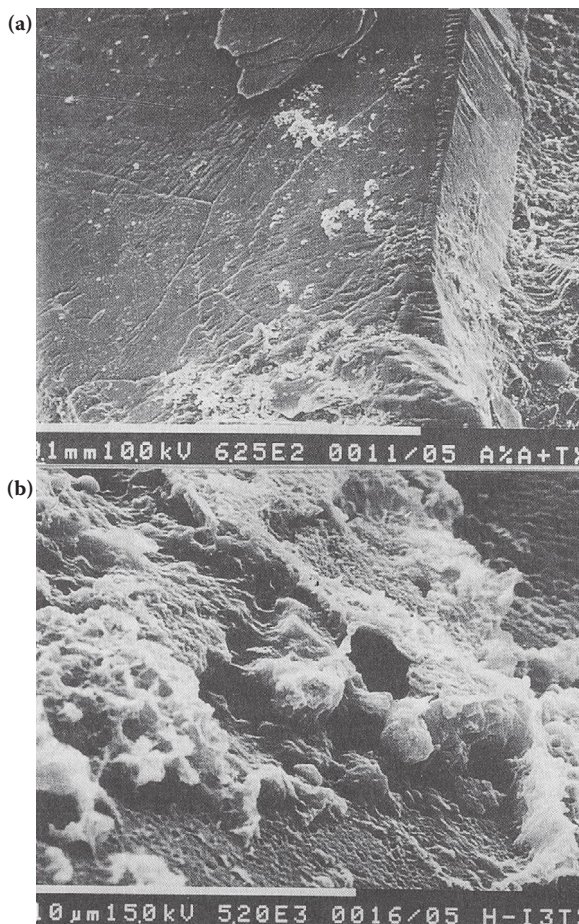
Organic matter is known to contain several functional groups, such as carboxylic groups, phenolic and alcoholic hydroxyl groups, amino acid groups, amides, ketones, and aldehydes. Among these many groups, perhaps the most important sites for adsorption of water are provided by the carboxyl groups. Ionized carboxylic groups possess high affinity for water, although the other functional groups may also exhibit some degree of adsorption.

Water can be held by a single hydrogen bond or by multiple bonds or coordination bonds. Coordinated water is usually held more strongly by organic matter than water held by a single bond. Upon drying and exposure of polar sites of organic matter, an internal pairing of proton donor groups (OH) and proton acceptor groups (C=O) may occur. Adsorption of water by the functional groups and internal pairing upon drying of organic matter is illustrated in Figure 7.3.





**FIGURE 7.3** Adsorption of water by the functional groups of organic matter and internal pairing.



**FIGURE 7.4** Scanning electron micrographs of a sand particle from a normal and localized dry spot in a golf green. (a) Normal or healthy area. Note the absence of coatings on the sand particle surface; (b) localized dry spot. The sand particle surface is covered by a fulvic acid coating. (Courtesy of K. J. Karnok, unpublished personal files, University of Georgia.)

Internal pairing of functional groups can produce stable sites, so that the organic compound will not rehydrate upon wetting. The latter may be part of the reason for the irreversible behavior of organic matter in rehydration upon wetting and drying.

This phenomenon of irreversible drying of organic matter causes many problems in a number of soils, and it is especially harmful for the establishment of golf greens (Miller and Wilkinson, 1979; Tucker et al., 1990). The *acquired soil hydrophobicity* is related to formation of fulvic acid coatings around soil particles (Figure 7.4). The dry fulvic acid coatings repel water and create the *localized dry spots* in golf greens. It is believed that the fulvic acid coating is a metabolic product of soil

microorganisms. Wilkinson and Miller (1978) isolated the fungi *Helminthosporium* sp., *Alternaria* sp., and *Culvularia* sp. in humic matter from localized dry spots.

## 7.6 THE PLANT–SOIL–WATER ENERGY RELATION

As discussed previously, the water potential of plant cells is defined as:

$$\Psi_{w(\text{plant})} = \Psi_p + \Psi_s + \Psi_m$$

When a plant root is immersed in the soil solution, water moves into or out of the plant cells until equilibrium is reached. At equilibrium, the water potential of the plant cells equals the water potential of the soil solution:

$$\Psi_{w(\text{plant})} = \Psi_{w(\text{soil})}$$

Substituting this relation in the above equation gives:

$$\Psi_{w(\text{soil})} = \Psi_p + \Psi_o$$

where  $\Psi_o = \Psi_s + \Psi_m =$  osmotic potential.

By rearranging the equation, we find:

$$\Psi_p = \Psi_{w(\text{soil})} - \Psi_o \quad (7.13)$$

The permanent wilting point occurs at  $\Psi_p = 0$  (Slatyer, 1957); therefore:

$$\Psi_{w(\text{soil})} - \Psi_o = 0$$

or

$$\Psi_{w(\text{soil})} = \Psi_o$$

If the soil–water potential decreases, soil–water content also decreases. The latter may cause water to move out of the cell, ultimately producing a phenomenon called *cytoplasmolysis*.

It is generally believed that at the *permanent wilting point* most plants will not be able to take up water and eventually die because of lack of water. However, some plants may respond differently to prolonged conditions of lack of water. In conditions of water stress, the plants need to conserve water, but at the same time they need to continue to produce photosynthates to maintain their metabolic activities. With many plants, the level of their metabolic activities is reduced. This can be accomplished by reducing their biomass through shedding their leaves, or by going into a dormant stage. Other plants, especially plants in semiarid and arid regions, respond differently. They have acquired a mechanism by which the uptake of  $\text{CO}_2$  for photosynthesis can temporarily be disengaged during periods of severe water stress. The plants adapt to the harmful condition by regulating their stomatal openings to enable the entrance of small, but sufficient amounts of  $\text{CO}_2$  for maintaining a minimum level of metabolic activity, but not so much that water loss becomes harmful (Fisher et al., 1981; Turner and Kramer, 1980). Therefore, plant life below the permanent wilting point is made possible by regulating stomatal aperture and other metabolic activities that are associated with changes in plant water potentials. As water content in plant tissue decreases, the osmotic potential in some plants is lowered due to net accumulation of solutes. This lowering of the osmotic potential is called *osmotic adjustment*. It usually contributes to a partial or full maintenance of turgor pressure.

The rate of change in osmotic potential, as a result of passive changes in solute concentration, can be expressed by the following equation (Turner and Jones, 1980):

$$\psi_o = (\Phi_o - V_o)/V \quad (7.14)$$

in which  $\psi_o$  is the osmotic potential;  $\Phi_o$  is the osmotic potential at full turgor, or at zero turgor;  $V$  is osmotic volume; and  $V_o$  is osmotic volume at full turgor, or at zero turgor.

The equation is not valid for determining osmotic adjustment owing to active accumulation of solutes in plant cells. Active accumulation of solutes will yield a decrease in osmotic potential far greater than can be predicted from the previous equation.

## 7.7 ADSORPTION OF ORGANIC COMPOUNDS

Adsorption of organic compounds by soil components during the years has received increasing attention, especially the adsorption of pesticides (insecticides and herbicides). Physical forces, chemical forces, electrostatic and coordination bonding are involved in the process. Physical bonding, from the London–van der Waals attraction, is limited to external surface reactions only. Chemical bonding, through the aid of protonation, may take place on external and intermicellar surfaces. Outersphere and intermicellar surfaces are perhaps more important in adsorption reactions through protonation of organic anions than innersphere surfaces. Adsorbed water, which is the major proton donor, is expected to be absent, because it is too large to penetrate the innersphere region of the siloxane surface as discussed before. In contrast, interlayer water and water in the hydration shell of interlayer cations tend to be dissociated very rapidly, and the protons produced may be used for protonation of organic compounds, resulting in their adsorption. Hydrogen bonding may occur if the compound has an N–H or OH group that can be linked to the O on the clay surface. From a chemical standpoint, adsorption, through water bridging between an organic molecule and the clay surface, is a form of hydrogen bonding. Electrostatic bonding takes place between organic cations and anions and clays. The organic cations are mostly adsorbed on the negative clay surfaces, whereas organic anions are more attracted to the positively charged edge surfaces of clays (Van Olphen, 1977). Sposito (1989) suggested calling this kind of adsorption a *diffuse-ion swarm adsorption*. Such a concept may be valid for inorganic ions, but it raises many questions if organic compounds are involved. In addition, the distribution of counterions in the double layer varies depending on the theories as discussed previously. Sposito (1989, 2008) believes that the mechanism by which organic matter is bound to soil minerals involves mainly surface complexation. Coordination bonding results in formation of complex compounds. It is formed by the organic ligand donating electron pairs to a metal or an ion. The metal takes the central position and is surrounded by a group of ligands. The metal ion, complexing the organic substance, can also be attached to a clay particle in the form of an exchangeable cation. Inorganic cations adsorbed both on the outer- and innersphere surfaces may aid in the adsorption process by acting as *bridges*. Cations small enough to penetrate the innersphere regions of the siloxane surface may attract an organic anion. The metal then forms a

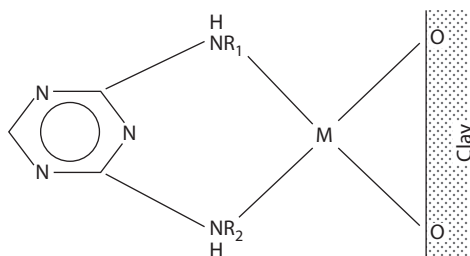


FIGURE 7.5 Cation bridging. M = cation.

bridge between the organic compound and the clay surface, a reaction formerly called *coadsorption* or *cation bridging* (Figure 7.5).

Intermicellar adsorption between the clay layers is limited to low molecular weight organic compounds (Tan and McCreery, 1975). The presence of organic compounds in intermicellar positions results in an expansion of the basal spacings. For example, smectite treated with ethylene glycol or glycerol gives a basal spacing of 17 Å, in contrast to 9.2 to 9.5 Å, its ordinary spacing in the presence of water or exchangeable cations. In the adsorption process, the organic molecule may displace adsorbed water from the clay surfaces. In turn, the adsorbed organic compound can often be removed by washing with water, except perhaps for those in the intermicellar spaces.

Uncharged organic compounds are also now known to be subject to adsorption by clay minerals. The adsorption can be direct or indirect, and physical forces (e.g., van der Waals forces) are mainly responsible for such an attraction. For the physical force to become effective, the uncharged organic molecule has to be relatively large in size or chain length. A maximum chain length of five units has been reported to affect adsorption significantly (Theng, 1974). Molecules of larger sizes, or with more than five units in chain length, can be adsorbed in the presence of excess water. The increase in adsorption of molecules with longer chain length is attributed to van de Waals forces becoming more effective as the size of the molecules is increased for close contact.

Indirectly, uncharged organic compounds are adsorbed by the silicate surface through linkage to the exchangeable cations as discussed above. Evidence for the latter came from infrared spectroscopy. Competition for ligand sites usually occurs between the organic compounds and water molecules around the exchangeable cations. The organic compound can either react directly with the cation, or it can be indirectly coordinated to the cation by linkage with water molecules in the hydration shell. This type of reaction, called *ion-dipole reaction*, depends on the polarizing power of the cation, the basicity of the organic compound, and the nature of packing when adsorbed in intermicellar spaces.

Another adsorption mechanism reported in the literature is the adsorption caused by the presence of activated C–H groups. Activation of methylene groups by adjacent electron acceptors makes it possible for the activated methylene groups to form hydrogen bonds with the oxygens of the siloxane surface of clay minerals. However, in later studies, many arguments were presented on the possibility for formation of a C–H···O type of bonding.

### 7.7.1 PHYSICOCHEMICAL PROPERTIES OF ORGANIC SUBSTANCES THAT INFLUENCE ADSORPTION

Adsorption of organic compounds by clay surfaces is affected by several physicochemical characteristics of the organic compounds. Some, such as (1) chemical nature, (2) solubility in water, (3) dissociation capacity, (4) surface charge density, and (5) polarity, will be discussed in more detail below.

The chemical nature of organic compounds is determined by the reactivity of their functional groups. The dissociation of the functional groups determines whether the organics will behave as acidic, basic, or amphoteric compounds. The tendency for hydrogen bonding is dependent on the presence of specific dissociation of functional groups, whereas coordination bonding requires the functional groups to behave as electron-pair donors.

The relationship between water solubility of organic compounds and their adsorption is not clear because of mixed information present in the literature. Bailey and White (1970) are of the opinion that within a chemical family of organic compounds (e.g., s-atrazines and urea), the magnitude of their adsorption by soil minerals is related to and influenced by the degree of water solubility. The more soluble the organics, the more they will be adsorbed. However, other scientists reported that the degree of adsorption of herbicides and ureas was inversely related to their water solubility (Wolf et al., 1958; Yuen and Hilton, 1962).

The dissociation capacity of organic compounds can be expressed in terms of  $pK_a$  values. The  $pK_a$  value is an important property, because it indicates the ionization capability of the organics. Organic acids capable of dissociating more than one proton per molecule, called polyprotic acids,

have more than one  $pK_a$  value. The higher the  $pK_a$  value of polyprotic acids, the less acidic is the behavior of the organic acid. On the other hand, organic acids, capable of dissociating only one proton, are called monoprotic acids. They behave as strong acids when their  $pK_a > 0$  ( $K_a > 1$ ). With amphoteric compounds, the  $pK_a$  equals the pH at which the ionizable group is at its maximum buffering capacity (see Chapter 3). Such a behavior, indicating the degree of acidity or basicity, will determine the rate and ease of adsorption by soil minerals.

Indications were also presented that proton transfer will occur only at a critical  $\Delta pK_a$ . The latter is defined as the difference between the  $pK_a$  of the base and that of the acid (Johnson and Rumon, 1965).

The charge density or distribution of electrostatic charge on organics will influence their adsorption by clay minerals. It has been noted that some organics are preferentially adsorbed over others. This difference in adsorption is attributed to differences in the separation of the electrostatic charges between the organic compounds (Bailey and White, 1970). In organic substances with lower surface charge densities, the electrostatic charge centers are more widely spaced than in organic compounds possessing higher surface charge densities. The compounds with the more closely spaced charge centers are believed to be adsorbed more readily than those with the widely spaced charge centers. Because in expanding types of clays the major surface areas available for adsorption are the intermicellar surfaces, their total adsorption capacity is determined by the extent of the internal surface area only. The force binding the clay platelets together is a function of surface charge density. Therefore, the amount of intermicellar adsorption of organics depends on their ability to produce sufficient energy as a result of complex reaction to overcome this binding force holding the platelets together. Because of this, not all organics can be adsorbed on internal surfaces.

Polarity is another property of organic substances that may influence their adsorption, especially in intermicellar surfaces of expanding clays. The presence of polar groups in an organic molecule is believed to enhance the separation of the clay sheets, increasing in this way the dimension of the intermicellar space. This process decreases the clay mineral exchangeable ion electric field, or the *electrical potential* of the internal clay surface, which results in an increased adsorption. Bailey and White (1970) assume that if the organic substance is nonpolar, and the clay mineral is less polar than the solvent, the organic solute will have a greater affinity for the clay than for the solvent.

## 7.7.2 INTERLAYER ADSORPTION AND MOLECULAR ORIENTATION OF ORGANIC COMPOUNDS

As indicated in the previous sections, adsorption of organic compounds by clay surfaces can occur not only on the outer surfaces, but x-ray diffraction analysis of basal spacings of clays has shown that considerable amounts of the organic molecules can penetrate the intermicellar regions of 2:1 expanding types of clays especially. The placement of organic compounds in interlayer spaces of silicate minerals is called *intercalation* or *solvation*. Intercalation occurs more frequently with the 2:1 than with the 1:1 types of minerals.

Because of the strong bonds between the layers of 1:1 types of minerals (e.g., kaolinite), penetration of intermicellar spaces by organic compounds is very difficult, although intercalation, in some instances, can be achieved with certain inorganic salts and polar substances. Therefore, adsorption of organic compounds is, in general, confined to the outer surfaces and to the edges of kaolinite, where the unsatisfied valencies by broken bonds have been estimated to amount to approximately 10% to 20% of the crystal area. In contrast with kaolinite, smectite has both active outer- and interlayer surfaces. Of the two, the interlayer surface accounts for the major portion of the total surface area. Only 10% of the total surface area is made up of active crystal edges, thereby reducing the importance of edge effects in adsorption.

Interlayer adsorption is affected by molecular size, polarity, and polarizability of the organic substances. In addition, it appears from previous discussions that water molecules and inorganic cations in intermicellar positions may also play an important role in adsorption of the organics. For the substance to be adsorbed on the intermicellar surfaces, sufficient energy must be available, as indicated before, to exceed, or at least equal, the energy forces holding the layers together. The



presence of polar molecules, such as water, may serve as an aid to the latter, because interlayer water is capable of keeping the layers apart, in this way decreasing the electric potential at the interface. Evidence for this was obtained with benzene, which can be adsorbed by smectite only when interlayer water is present (Bailey and White, 1970).

*Polarizability*, another factor affecting adsorption of organics, is defined as the ease with which negative and positive charges in a molecule can be displaced relative to one another in the presence of an electric field. From the definition, it is perhaps clear that the greater the ease of polarizability of the molecule, the greater will be its adsorption in the intermicellar spaces. The nature of the exchangeable cations also plays an important role in polarizing the organic molecule. The greater the polarizing power of the exchangeable cation, the greater will be the adsorption of organics on intermicellar surfaces. According to Bailey and White (1970), cations with higher valencies exhibit higher polarizing powers. However, the bigger the cations, the smaller their polarizing capacities.

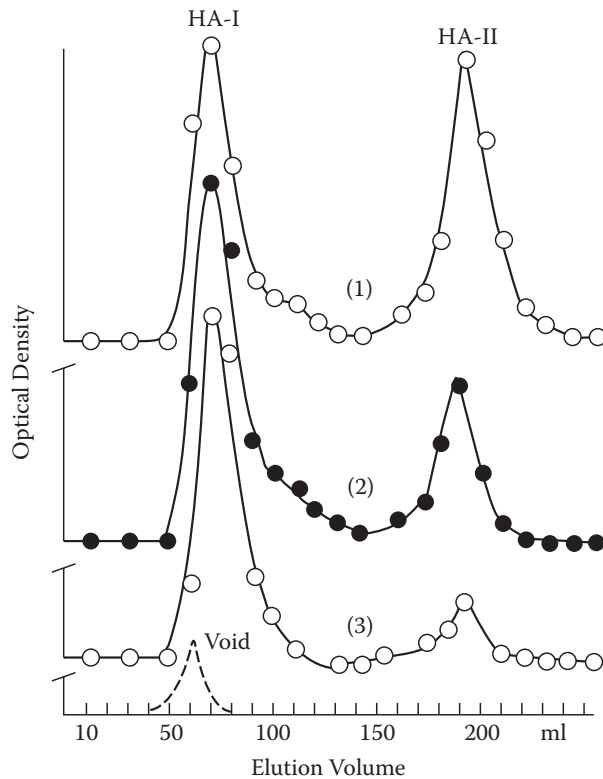
X-ray diffraction analysis of expanding silicate clays solvated with ethylene glycol reveals that polarity and polarizability play an important role in orientation and spatial arrangement of interlayer organic molecules. Two kinds of orientation were reported for aliphatic chain molecules adsorbed with their axes perpendicular to the silicate surface: (1) an interlayer arrangement in which the plane of carbon zig-zag is perpendicular to the silicate layer, and (2) an interlayer arrangement in which the zig-zag carbon plane is parallel to the silicate surface (Theng, 1974). Strongly polar compounds will favor orientation according to arrangement (2), whereas nonpolar compounds tend to arrange themselves according to orientation type (1).

### 7.7.3 THE EFFECT OF MOLECULAR SIZE ON ADSORPTION

The size of the organic molecule is considered to play an important role in its rate of adsorption. This has been mentioned in the previous sections and will be discussed below in more detail. Bailey and White (1970) summarize the effect of molecular size as follows:

1. The adsorption of nonelectrolytes by nonpolar adsorbents increases as molecular weights of the substances increase.
2. The van der Waals forces of adsorption increase with increasing molecular size.
3. The adsorption decreases because of steric hindrance.

The evidence currently available also shows the presence of a maximum limit in molecular size in adsorption of organic compounds. As stated earlier, appreciable adsorption is noticed with compounds having a chain length of five units, whereas larger molecules (chain length greater than five units) may be adsorbed only in the presence of excess water. However, very large molecules can experience difficulties in adsorption owing to adverse molecular configuration. Inoue and Wada (1973) succeeded in determining the molecular size limit for adsorption. They reported that humic molecules with molecular weights between 1500 and 10,000 are preferentially adsorbed over the smaller or larger molecules. These size limits have been confirmed by Tan (1976a) in his studies with Sephadex-gel filtration. To study complex formation, humic acid was shaken with kaolinite or smectite, and the remaining humic acid in solution was fractionated with Sephadex G-50 gel filtration. The results (Figure 7.6) showed that mainly the fraction with a molecular weight of 1500 (HA-II) was adsorbed. Before treatment with kaolinite or smectite, the original humic acid was composed of equal amounts of high (HA-I: >30,000) and low molecular weight (HA-II: <1500) fractions. After interaction with the clay minerals, only the elution peak of the low molecular weight fraction was decreased in intensity, meaning that the equilibrium humic acid solution lost some of the low molecular weight humic acid. The amounts of humic acid lost had apparently been adsorbed by kaolinite or smectite. The elution curves also provide indications that smectite has a larger adsorption capacity than kaolinite. The elution peak of HA-II was significantly smaller after treatment with smectite than with kaolinite. This difference in adsorption owing to the type of clays



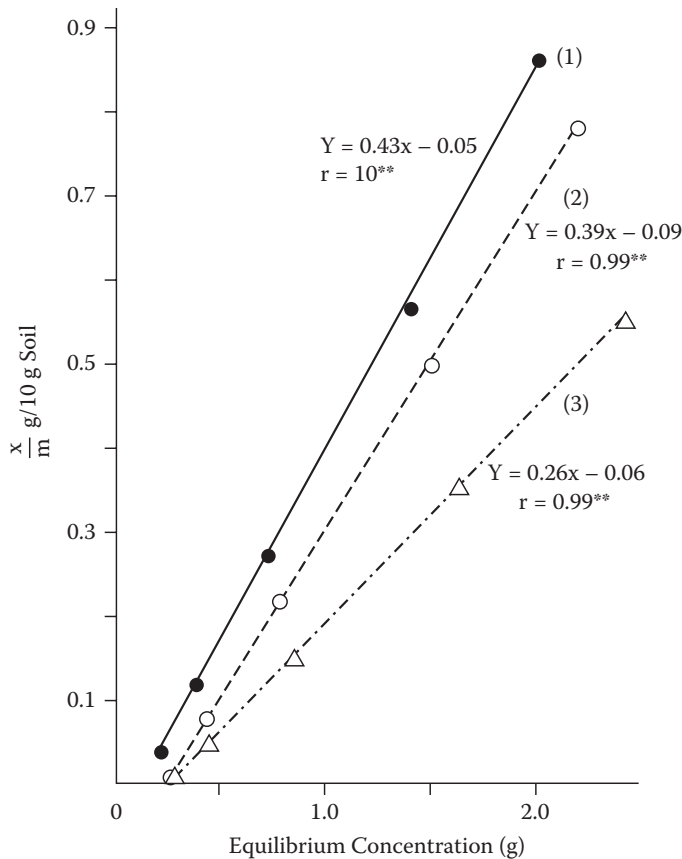
**FIGURE 7.6** HA-I is high molecular weight humic acid (MW > 30,000), and HA-II is low molecular weight humic acid fractions (MW < 1500) separated by Sephadex G-50 gel filtration: (1) original humic acid, (2) humic acid after interaction with kaolinite, and (3) humic acid after interaction with smectite. (From Tan, K. H., *Soil Biol. Biochem.*, 8, 235–239, 1976. Copyright 1976, with permission from Elsevier.)

has been expected. The expanding 2:1 minerals have properties, such as high CEC and large surface areas, which give rise to large Coulombic and van der Waals forces. On the other hand, the nonexpanding 1:1 type of clays have low CEC and low surface areas, all properties that will not contribute to considerable adsorption.

#### 7.7.4 THE NATURE OF ADSORPTION ISOTHERMS

There is no general agreement in the literature on the nature of adsorption isotherms. Bailey and White (1970) are of the opinion that adsorption of organic matter can be better described with the Freundlich equation, but Weber (1970) reported that adsorption of organic matter follows the Langmuir equation. According to the Freundlich equation, theoretically, adsorption increases indefinitely with increasing concentration. On the other hand, the Langmuir equation indicates that adsorption of organic matter on the clay surface tends to reach a maximum limit. The latter is compatible with the fact that soil and clay do not have an infinite capacity to adsorb but will sooner or later be saturated. Adsorption of organic compounds, such as humic acid and the like, following the Langmuir-type equation was reported by Inoue and Wada (1973) and Tan et al. (1975a). In their studies with poultry litter extracts adsorbed by kaolinite and smectite minerals, Tan et al. (1975a) showed that the slope of the adsorption isotherms decreases with increasing temperature from 25, to 35, to 50°C (Figure 7.7). This agrees with the basic principle of adsorption processes discussed in Section 7.2, that adsorption generally decreases as temperature increases, due to an increase in





**FIGURE 7.7** Adsorption of water extracts of broiler litter by Cecil topsoil at (1) 25°C, (2) 35°C, and (3) 50°C. (Reprinted from Tan, K. H., V. G. Mudgal, and R. A. Leonard, *Environ. Sci. Technol.*, 9, 132–135, 1975. Copyright 1975 American Chemical Society.)

kinetic energy of the molecules disrupting the adsorption process. Tan and coworkers also indicate that infrared analysis confirms that protonated compounds are adsorbed in larger amounts than  $\text{Na}^+$ -saturated extracts. The latter may suggest that ionic bonding has been involved in the adsorption reaction.

## 7.8 INTERPARTICLE ATTRACTION

Interaction between charged colloidal particles occurs frequently in soils. As discussed previously, the presence of a double layer creates repulsive forces between particles. The colloids also possess London–van der Waals forces responsible for attraction of particles to each other. The latter can be significant at close range only, but will be of no importance at large interparticle distances. The net balance between the repulsive force and attractive forces determines interparticle attraction. For most soils,  $\text{Al}^{3+}$ ,  $\text{H}^+$ , or  $\text{Ca}^{2+}$ , and  $\text{Mg}^{2+}$  ions are dominant in the double layers. These ions, except  $\text{H}^+$ , tend to reduce the repulsive forces of the double layer. The van der Waals forces will then be effective and the soil particles interact and form aggregates. In contrast with the those ions,  $\text{Na}^+$  ions have a different effect. Because of its large hydration shell,  $\text{Na}^+$  ions tend to increase the double-layer repulsive forces. Therefore, in the presence of  $\text{Na}^+$  ions, the soil particles are not aggregated and when wet remain in a dispersed condition. Soils in which  $\text{Na}^+$  ions are dominant, such as the saline soils, may exhibit poor physical conditions.

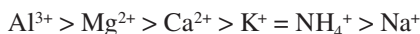


---

# 8 Cation Exchange

## 8.1 ADSORPTION OF CATIONS BY SOIL COLLOIDS

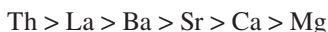
Because clay colloids carry negative charges, cations are attracted to the clay particles. This is Mother Nature's condition to maintain electroneutrality in soils. These cations are held electrostatically on the surface of the clay. Most of them are free to distribute themselves through the liquid phase by diffusion. The density of ion population is greatest at or near the surface. These cations are called *adsorbed cations*. Different rates and orders of adsorption are known among the cations, because the adsorption reaction depends on the surface potential, valence, and hydrodynamic radius. As surface potential increases, more of the divalent ions will be adsorbed. Trivalent cations, exhibiting high surface potential values, would be even more strongly concentrated on the clay surface. When a mixture of monovalent and divalent ions is present in a soil solution, adsorption is usually shifted in favor of the divalent ions. Specific adsorption of cations is also affected by the hydrodynamic radius. Generally, ions with smaller hydrated sizes are preferably adsorbed as compared to ions with larger hydrated sizes. The crystalline radius, on the other hand, plays only a minor role. The relative strength of cation adsorption, reflecting surface potentials, valence, and hydrated size, is usually indicated by listing the cations in increasing or decreasing order of adsorption, what is called in soil science the *lyotropic series* in adsorption. There are many versions of these lyotropic series; some of them agree with each other, whereas others are in conflict with the others, such as presented by White (2005), which is addressed in Section 7.1.2. Below is an example of a lyotropic series presented by Troeh and Thompson (2005), which generally agrees with several others:



Another example is the following decreasing order of preference for adsorption of monovalent cations by clays as reported by Gast (1977) and apparently is also supported by the lyotropic series as presented by Essington (2003):



The rate of adsorption for Cs is the highest, because Cs is the smallest in hydrated size. The ion has a thin hydration shell, which makes a close approach to the clay surface possible. Lithium, on the other hand, has the largest hydrodynamic radius. Its thick hydration shell increases the distance from the ion to the clay surface. A lyotropic series for divalent cations was also reported in the literature (Taylor and Ashcroft, 1972):



Evidence is present that different lyotropic series exist for different types of clays, and an example that has not been corroborated by more detailed scientific evidence is shown below for goethite:



This series indicates that Cu is preferentially adsorbed by goethite minerals as compared to Mn.

Preferential adsorption as explained above can be broken by mass action when an ion is present in much more concentrated form than the others in the soil solution (Troeh and Thompson, 2005). Troeh and Thompson also properly indicate that flocculation and dispersion of clays are affected by the lyotropic series.  $\text{Al}^{3+}$  and  $\text{Ca}^{2+}$  listed first in their lyotropic series will flocculate clays, whereas  $\text{Na}^+$  ions listed at the end have a tendency to cause dispersion.

It is believed that the difference in preferential adsorption above is determined, in fact, by the *Law of Coulomb*:

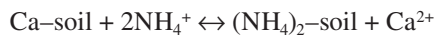
$$F = k (e_1 e_2) / kd^2$$

in which  $F$  is the force of attraction,  $e$  is the magnitude of electric charge of an ion (in  $C = \text{coulomb}$ ),  $k$  is the proportionality constant, and  $d$  is the distance of charge separation (in  $m$ ).

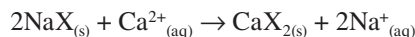
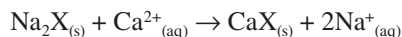
## 8.2 CATION EXCHANGE REACTIONS

The history of ion exchange dates back to 3000 B.C., when Moses produced drinking water in the desert oasis of Marah. By throwing a dead log into the saline water of the spring Marah, Moses made the *miracle* of transferring this salty water into water suitable for drinking. Apparently, the partly decomposed organic material in the dead tree log removed all the salts by an adsorption and ion exchange reaction (Rieman and Walton, 1970). However, the earliest scientific record on ion exchange was from H. S. Thompson in 1850, an agricultural chemist. From his experiments by leaching ammonium sulfate solutions through a soil column, Thompson discovered that  $\text{NH}_4^+$  was removed and exchanged by  $\text{Ca}^{2+}$ , a reaction called *base exchange* at that time. Also in 1850, J. T. Way published a more comprehensive report under the title "On the power of soils to absorb manure." Way conducted similar leaching experiments with  $\text{NH}_4$ -sulfate and other salt solutions, and he concluded that the soil had the capacity to adsorb the bases of the salts of ammonia, potash, magnesia, and soda. Way's research also provided indications of the presence of a chemically active soil constituent responsible for this exchange reaction because his experiments with pure sand yielded negative results. To test his hypothesis, Way produced for the first time a zeolite-like material with an approximate composition of  $\text{Na}_2\text{O} \cdot \text{Al}_2\text{O}_3 \cdot 3\text{SiO}_2 \cdot 2\text{H}_2\text{O}$ , by mixing solutions of sodium aluminate and sodium silicate. This zeolite-like compound had the capacity to adsorb cations. Although Way's theory on base exchange was seriously attacked by Justus Von Liebig, it was later supported and revived by Wiegner, another German chemist.

The term *cation exchange* is preferred over the term *base exchange*, because the reaction also involves  $\text{H}^+$  ions. The hydrogen ion is a cation, but not a base. The adsorbed cations can be exchanged by other cations; hence, the cations are also called *exchangeable cations*. The process of replacement is called *cation exchange*. The rate of reaction is virtually instantaneous. To maintain electroneutrality in the soil, exchange reactions are stoichiometric reactions as illustrated by the classic experiment of Way (1850):



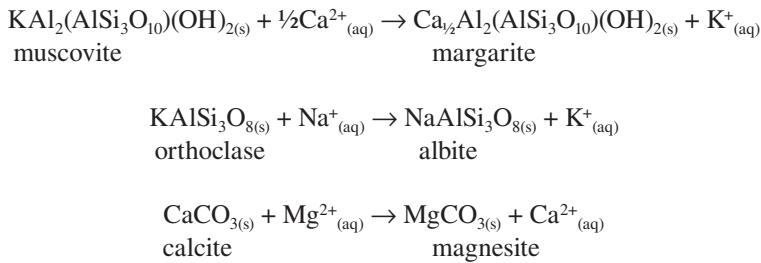
This reaction is an oversimplification of a cation exchange reaction, and serves only as an example of an exchange process. The reaction does not entail the connotation that because  $\text{Ca}$  is adsorbed, the soil has only two negative ( $2-$ ) charges as stated by Sposito (1989, 2008) with his concept of exchange reactions:



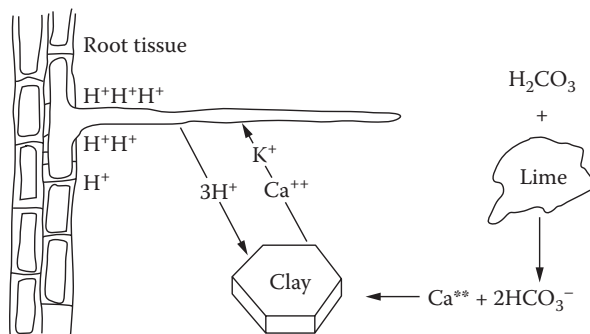
where  $X$  is the exchange complex.

In the first reaction, the exchange complex X was described as having two negative charges ( $X^{2-}$ ), whereas in the second reaction, the exchange complex X exhibited only one negative charge ( $X^{1-}$ ). However, the soil exchange complexes have neither only one ( $X^{1-}$ ) nor only two ( $X^{2-}$ ) intrinsic negative charges, but the colloidal surface exhibits a certain amount of charge density, caused by the total charge created by structural permanent and variable charges. The use of a “one-lane” arrow ( $\rightarrow$ ) is also incorrect, because exchange reactions are reversible reactions. The relationship between cation exchange and surface charge density will be discussed in Section 8.3. Because of the presence of a certain amount of charges per surface area, an assortment of mono-, di-, and other polyvalent cations can be adsorbed together and, consequently, can be exchanged also by a mixture of mono-, di-, and other polyvalent cations. A simplified reaction of its complexity is illustrated in Figure 8.1.

Sposito (1989) also claimed that in the strict sense of the term *cation exchange*, the following reactions are also cation exchange reactions:



Unfortunately, these reactions, in the sense of exchange reactions, have not been noticed to occur in nature as well as under laboratory conditions, and such a theory sends an improper message on the principles of cation exchange reactions. The examples above are primary minerals, not clay minerals, and the conversion of one type of primary mineral into another type requires some geologic action (e.g., metamorphism or the like). Conversion of primary minerals from one into another species has not been known to occur by cation exchange. Primary minerals can weather and be transformed into secondary minerals. Hence, the conversion of orthoclase into albite by merely exchanging the structural  $K^+$  for  $Na^+$  in solution is an impossible dream. Orthoclase is insoluble in water. If such an exchange reaction is possible, gemologists all over the world would rejoice in producing albite or orthoclase by just shaking the primary minerals with a Na or a K solution. The same is true for the conversion of muscovite into margarite, another primary mineral, whereas the transformation of calcite into magnesite would provide a bonanza for the fertilizer and liming industry if the exchange reaction could take place as easily as suggested. Calcite is also known to be

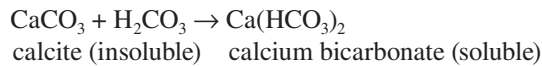


**FIGURE 8.1** Cation exchange involving a mixture of mono- and polyvalent ions by a soil colloid with a certain amount of charges:  $Ca^{2+}$  and  $K^+$  on the clay surface are exchanged for  $3 H^+$  by plant roots.

insoluble in water. As indicated above, exchange reactions are instantaneous and reversible, which is not the case in the conversion of one primary mineral into another.

Adsorption and cation exchange are of great practical significance in nutrient uptake by plants, soil fertility, nutrient retention, and fertilizer application. Its importance has increased considerably today by an increased awareness of its beneficial effect in environmental issues. It is realized now that cation exchange has the capacity to intercept toxic metals and organic compounds reaching the groundwater and prevent pollution of streams and lakes.

Adsorbed cations are generally available to plants by exchange with  $H^+$  ions generated by the respiration of plant roots. Nutrients added to the soil, in the form of fertilizers, will be retained by the colloidal surfaces and are temporarily prevented from leaching. Cations that may pollute the groundwater may be filtered by the adsorptive action of the soil colloids. As such, the adsorption complex is considered to give to the soil a storage and buffering capacity for cations. In addition, it may play a role in making liming materials available to plant growth. Calcitic limestone, or  $CaCO_3$  (calcite), is insoluble in water and will not play a role in cation exchange reactions as indicated earlier. However, when added to acid soil (Al-soil), limestone may react with  $H_2O$  containing  $CO_2$ . This reaction can be illustrated as follows:



The calcium bicarbonate formed is soluble in water, and calcium,  $Ca^{2+}$ , that is dissociated off can then be adsorbed by the soil in exchange for adsorbed  $Al^{3+}$  according to the following reaction:



Thomas (1974) considered these processes a neutralization and precipitation type of cation exchange reaction.

### 8.3 CATION EXCHANGE CAPACITY

The *cation exchange capacity* (CEC) of soils is defined as the capacity of soils to adsorb and exchange cations. Scientifically, it is related to the surface area and surface charge of the clay. This relation is expressed by the following equation:

$$CEC = S \times \sigma \quad (8.1)$$

where  $S$  is the specific surface, and  $\sigma$  is the surface charge density.

The surface charge density can be calculated using the following equation:

$$\sigma = \sqrt{2\epsilon nkT} / \pi \sinh(z\psi_0 / 2kT) \quad (8.2)$$

where  $\epsilon$  is the dielectric constant,  $n$  is the electrolyte concentration in number of ions/mL,  $k$  is the Boltzmann constant,  $T$  is the absolute temperature (K),  $z$  is the valence,  $e$  is the electron charge in esu, and  $\psi_0$  is the surface potential in StatVolts.

However, CEC is commonly determined by extraction of the cations from soils with a solution containing a known cation for exchange. The results, expressed in milliequivalents per 100 grams of soils ( $= \text{cmol (+) kg}^{-1}$ ), are taken as the CEC of soils. The U.S. Department of Agriculture (USDA), Soil Survey Division, uses as a unit milliequivalents per 100 grams of clay (Soil Survey Staff, 2006). The values for CEC may vary considerably depending on the (1) concept of CEC

**TABLE 8.1**  
**Cation Exchange Capacity (CEC) of Humus**  
**and Selected Clays**

Soil Colloids	CEC (mEq/100 g)
Humus (humic matter)	200
Vermiculite	100–150
Smectite	70–95
Illite	10–40
Kaolinite	3–15
Sesquioxides	2–4

used, (2) methods of analysis, (3) type of colloids, and (4) amount of colloids. It is common practice in the determination of CEC to analyze all exchangeable cations. The CEC is then:

$$\text{CEC} = \Sigma \text{mEq of exchangeable cations per 100 g soil}$$

As stated above, the value for soil CEC varies according to types and amounts of colloids present in soils. On average, the CEC of the major soil colloids is as shown in Table 8.1.

Bolt et al. (1976) are of the opinion that a certain correction is needed to the above procedure. They stated that the real adsorbed cations are not accompanied by anions. But *free* cations may have slipped in carrying with them their counterions as *stowaways*. These ions may have been analyzed together with the *true* exchangeable cations. Hence, the ions of these free salts must be subtracted to obtain the correct CEC.

#### EXAMPLE

Determination of Exchangeable Cations and Anions Gives the Following Results

Cations (mEq/100 g)	Anions (mEq/100 g)
Na <sup>+</sup> = 5	Cl <sup>-</sup> = 0.8
K <sup>+</sup> = 5	HCO <sub>3</sub> <sup>-</sup> = 0.2
Ca <sup>2+</sup> = 10	Σanions = 1.0
Mg <sup>2+</sup> = 10	
H <sup>+</sup> = 5	
Σcations = 35	

The CEC, according to Bolt et al. (1976) is then:

$$\begin{aligned} \text{CEC} &= \Sigma \text{exchangeable cations} - \Sigma \text{exchangeable anions} \\ &= 35 - 1 = 34 \text{ mEq/100 g} \end{aligned}$$

Another method to determine CEC is to calculate from the formula weight of the particular clay mineral. In this case, the charge per formula weight (FW) should be known (see Table 6.2) or first determined. An example of a calculation is given below for smectite:

Mineral	Formula	Charge/FW
Smectite	(Si <sub>8</sub> )(Al <sub>3.33</sub> Mg <sub>0.67</sub> Na <sub>0.67</sub> ) O <sub>20</sub> (OH) <sub>4</sub> nH <sub>2</sub> O	0.50 Eq



The formula weight of smectite is:

$$(8 \times 28.1) + (3.33 \times 27) + (0.67 \times 24.3) + (0.67 \times 23) + (20 \times 16) + (4 \times 16) + (4 \times 1) = 734.4 \text{ grams}$$

$$\text{CEC of smectite} = 0.50/734.4 = 0.0006808 \text{ Eq/g or } 68.1 \text{ meq/100 g}$$

### 8.3.1 TYPES OF CATION EXCHANGE CAPACITY

Depending upon the type of charges—permanent or variable—three types of CECs can be distinguished (Mehlich, 1981), whereas the Soil Survey Staff (2006) added another type, *ECEC*, to include extractable  $\text{Al}^{3+}$  content in soils:

1.  $\text{CEC}_p$ —This is the CEC attributed to permanent charges and is of importance in, especially, 2:1 layer types of minerals.
2.  $\text{CEC}_t$ —This is the total CEC, or the CEC produced by both permanent and variable negative charges.
3.  $\text{CEC}_v$ —This is called the variable charge CEC, or the CEC caused by the variable negative charges. It is in fact  $\text{CEC}_t - \text{CEC}_p$ .  $\text{CEC}_v$  is common in soils high in organic matter content, including sesquioxides, amorphous, and 1:1 layer types of clays.
4. *ECEC*—Effective CEC, which equals  $\Sigma\text{NH}_4$ -acetate exchangeable bases + 1 *N* KCl extractable Al.

## 8.4 THE EXCHANGING POWERS OF CATIONS

Different cations may have different abilities to exchange adsorbed cations. The amount adsorbed is often not equivalent to the amount exchanged. Divalent ions are usually held more strongly than monovalent ions. They will be exchanged with more difficulty than the monovalent ions. It is sometimes noticed that if  $\text{Ba}^{2+}$  is used as the exchange cation, the exchange does not occur in equivalent amounts. Barium is strongly adsorbed by the clay but appears to have low penetrating power. Therefore, it exchanges less than would be expected from the amount of Ba adsorbed. On the other hand, cation exchange using  $\text{NH}_4^+$  ions may often yield higher exchange results than is expected from amounts of  $\text{NH}_4^+$  ions adsorbed. Ammonium as a monovalent ion will be attracted less strongly than  $\text{Ba}^{2+}$  ions, but  $\text{NH}_4^+$  has high penetrating power.

An exception to this is perhaps the use of  $\text{H}^+$  ions. Hydrogen ions are adsorbed more strongly than the other monovalent or divalent ions. Hydrogen clays prepared by exchange reactions initially contain large amounts of exchangeable  $\text{H}^+$  ions and small amounts of  $\text{Al}^{3+}$  ions. However, the concentration of exchangeable  $\text{Al}^{3+}$  ions builds up rapidly. The exchangeable  $\text{H}^+$  ions cause partial decomposition, and Al released from the clay becomes exchangeable.

## 8.5 THE IONIC COMPOSITION OF THE EXCHANGE COMPLEX

The soil contains a mixture of cations. All of them are subject to attraction to clay surfaces. In the preceding sections, we have seen that the adsorption and exchange of cations depend on the concentration and nature of replacing (added) cations. The nature and the composition of the soil solution will change accordingly, depending on the type and amounts of cations being replaced, and on the concentration of the end product, as determined by solubility and dissociation. Understanding the changes that can occur in ionic composition is very important in practice. We can then manipulate the composition through fertilizers and lime addition in favor of plant growth. To be able to study this problem, we must have the means to formulate the ionic composition in the soil in the presence of charged colloids. Several equations have been reported for this purpose, and two general

activity–composition models among them are the *van Laar* and *Rothmund–Kornfeld models*. The *van Laar equation* is presented in the literature (Polianin, 2007) as:

$$\Delta\sigma = \sigma_0 - \sigma = RT \Gamma_0 \ln 1 - \Gamma/\Gamma_0 \quad (8.3)$$

where  $\sigma_0$  is the surface tension of pure solvent,  $\sigma$  is the surface tension of the solution,  $R$  is the gas constant,  $T$  is the absolute temperature,  $\Gamma_0$  is the specific adsorption of solute for the limit filling of the adsorption layer, and  $\Gamma$  is the mass of solutes per unit area of the surface or interface. When  $\Gamma \leq \Gamma_0$ , the van Laar equation becomes the equation for ideal gas.

However, the van Laar equation is formulated by Sposito (1989) as an *exponential equation* as follows:

$$(MX_z) = x_1 \exp [a_1 a_2^2 x_2^2 / (a_1 x_1 + a_2 x_2)^2] \quad (8.4)$$

where  $M$  is a cation with valence  $z$ ,  $X$  is the exchange complex with charge  $z$ ,  $x_1$  and  $x_2$  are empirical parameters related to the charge fraction of an adsorbed ion, and  $a_1$  and  $a_2$  are empirical parameters characterizing a binary-cation adsorption reaction.

By assuming  $a_1 = a_2 = 0$ , the van Laar equation changes into:

$$(MX_z) = x_1 \quad (8.5)$$

According to Sposito (1989), this formula is similar to *Vanselow's* equation for mono-divalent cation exchange reactions. As will be discussed in Section 8.7, *Vanselow's* equation, more commonly used to describe mono-divalent cation exchange reactions, does not carry in its formula the exchange complex ( $X_z$ ). The question also arises whether  $x_1$  in van Laar's formula above can be equated to the proportion of cations adsorbed relative to the total amounts of cations occupying the exchange sites, because this mole fraction forms the basis in the formulation of the *Vanselow's* equation.

The *Rothmund–Kornfeld* equation is expressed according to Sposito (1989) by the following formula:

$$(MX_z) = E^{z/\beta} \quad (8.6)$$

where  $M$  is the cation with charge  $z$ ,  $X$  is the exchange complex with charge  $z$ ,  $E$  is the charge fraction, and  $\beta$  is the adjustable empirical parameter.

However, the *Rothmund–Kornfeld* model for mono-divalent exchange is usually presented as follows (see Essington, 2003):

$$k = [E_{Ca}^{1/\beta} / E_K^{1/\beta}] [(K^+)^2 (Ca^{2+})] \quad (8.7)$$

where  $k$  equals  $k_{RK}$  is the *Rothmund–Kornfeld* selectivity coefficient,  $E$  is the equivalent fraction of mono and divalent ions,  $K^+$  and  $Ca^{2+}$  are ions occupying the exchange phase,  $\beta$  is the adjustable exponential parameter of  $E$ , and  $( )$  is ion activity in solution.

Nevertheless, if  $z/\beta = 1$ , Sposito's Equation 8.6 shows no significant differences from the van Laar equation (Equation 8.5), other than playing with symbols and confusing many people on the principles of CEC. Application of Sposito's version of the *Rothmund–Kornfeld* model for adsorption of  $Na^+$  and  $Ca^{2+}$  ions, respectively, yields the following activity relations:

$$(NaX) = E_1^{1/\beta}$$

and

$$(CaX_2) = E_2^{2/\beta}$$

These equations show that adsorption of a cation by an exchange complex yields a certain amount of charge fraction ( $E$ ). The charge is  $1/\beta$  for monovalent cation adsorption, whereas the charge is  $2/\beta$  for a divalent cation adsorption. According to Sposito (1989), application of the Rothmund–Kornfeld model in cation exchange reactions yields then the following equation:

$$K_{\text{ex (Kerr)}} = [E_2^{2/\beta}(\text{Na}^+)^2]/[E_1^{2/\beta}(\text{Ca}^{2+})] \quad (8.8)$$

This equation exhibits some similarities with Kerr's equation. However, it raises many questions as to the validity to relate activity relations to cation exchange reactions. In addition, the use of the parameters  $E_1$  and  $E_2$ , defined as the charge fractions, is very puzzling, because  $(E_1^{1/\beta})^2(\text{Ca}^{2+})$  would conform more to Kerr's theory than Sposito's  $E_1^{2/\beta}(\text{Ca}^{2+})$ . When  $\beta = 1$ , Sposito assumes the Kerr's equation (Equation 8.8) to change into the *Gapon equation*, but this is only true after taking the square root, as stated properly by Essington (2003):

$$\sqrt{K_{\text{ex(Kerr)}}} = K_{\text{ex(Gapon)}} = [E_2(\text{Na}^+)]/E_1(\sqrt{\text{Ca}^{2+}}) \quad (8.9)$$

The Rothmund–Kornfeld equation and its application, as shown above, only demonstrate that the amount of Na or Ca adsorbed by the exchange complex X equals the charge fraction of the respective cations, and no exchange phenomenon is included. Hence, it is very difficult to consider the charge fractions  $E_1$  and  $E_2$ , as formulated by Sposito above, to assume the free ion activities commonly used to formulate either the Kerr's or the Gapon equation. Other sources indicate that the Rothmund–Kornfeld model is good for use in distinguishing between ionic and other types of adsorption (Connell and Miller, 1984). Nonexchange adsorption is noted by Burns et al. (2006) to follow the Rothmund–Kornfeld equation.

## 8.6 EMPIRICAL EQUATIONS OF CATION EXCHANGE

### 8.6.1 THE FREUNDLICH EQUATION

The adsorption equation of Freundlich is one method to express ionic composition in the soil solution. It is adaptable to adsorption reactions in a narrow range. The equation is as follows:

$$x = kC^{1/n} \quad (8.10)$$

and was addressed in Section 7.4.1 in detail. The Freundlich equation is not exactly a formulation of cation exchange reactions, but some people try to apply it, because adsorbed cations are exchangeable ions. However, Freundlich's equation pertains more to formulation of adsorption of cations, and no exchange parameter is included in the equation.

### 8.6.2 THE LANGMUIR–VAGELER EQUATION

The Langmuir–Vageler equation is usually formulated as follows:

$$x/x^0 = kC/(1 + kC) \quad (8.11)$$

This equation was discussed in detail in Section 7.4.2, where it was identified as Langmuir's equation. However, several people indicated that the *Vageler equation* was an earlier model and was similar in form to the Langmuir equation as shown by Shukla and Nayar (1941) below:

$$x = aC/(k + C) \quad (8.12)$$

Because the Langmuir or the Vageler equation is believed not to be capable of representing adsorption from cation exchange reactions, the authors above presented a revised equation as follows:

$$x = (k_1 + CB)/(k_2 + C) \quad (8.13)$$

where  $x$  is the amount of cations exchanged,  $k$  is constant,  $C$  is the initial concentration of exchanger ion, and  $B$  is the base exchange capacity of soils.

Equation 8.13 is called the *Langmuir–Vageler equation* by Shukla and Nayar (1941), who claim that it is applicable within certain limits to ion adsorption due to exchange reactions.

The constant  $k$  in the Langmuir equation above can be determined as follows (Thomas, 1974). Rearranging Equation 8.9 gives:

$$\begin{aligned} x(1 + kC) &= x^0kC \\ x + xkC &= x^0kC \\ x &= x^0kC - xkC \\ x &= kC(x^0 - x) \\ kC &= x/(x^0 - x) \\ \text{Therefore, } k &= x/[C(x^0 - x)] \end{aligned} \quad (8.14)$$

## 8.7 MASS ACTION LAW EQUATIONS OF CATION EXCHANGE

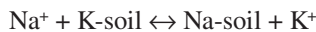
These equation models are grouped as *empirical equations* by Sparks (2003). However, because they are derived from the law of mass action, the present author believes that the name *mass action law equations* is more appropriate.

### 8.7.1 THE KERR AND GAPON EQUATION

The equation can apply for a (1) mono-monovalent ion exchange or (2) mono-divalent cation exchange reactions.

#### 8.7.1.1 The Mono-Monovalent Cation Exchange Reaction

Assume that we have the following exchange reaction:



Application of the Mass Action Law gives:

$$[\text{Na}^+](\text{K}^+)/(\text{Na}^+)[\text{K}^+] = k_{\text{eq}} = k_{\text{ex}} \quad (8.15)$$

or

$$(\text{K}^+)/(\text{Na}^+) = k_{\text{ex}}\{[\text{K}^+]/[\text{Na}^+]\}$$

The sign  $[ ]$  denotes adsorbed ions, whereas  $( )$  denotes free ions in solution. The equilibrium constant  $k_{\text{eq}}$  becomes the exchange constant  $k_{\text{ex}}$ , which is often called the *selectivity coefficient*. The value of  $k_{\text{ex}}$  indicates the tendency that one cation is adsorbed more over the other. When

$$k_{\text{ex}} = (\text{K}^+)/(\text{Na}^+)$$

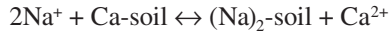
then

$$[\text{K}^+]/[\text{Na}^+] = 1$$

This means that equal amounts of  $\text{K}^+$  and  $\text{Na}^+$  ions are adsorbed.

### 8.7.1.2 The Mono-Divalent Cation Exchange Reaction

Assume the following exchange reaction:



Kerr indicates that at equilibrium, the reaction—following the mass action law—can be described by the following equation:

$$\{[\text{Na}^+]^2(\text{Ca}^{2+})\}/\{[\text{Ca}^{2+}](\text{Na}^+)^2\} = k_{\text{ex}} \quad (8.16)$$

The signs [ ] and ( ) denote again adsorbed and free ions, respectively. This is the original Kerr's equation. Conforming to the mass action law, the equation says that the ratio of the activity product of reaction products and that of the reactants is constant. By taking the square root, Equation 8.14 changes into:

$$[\text{Na}^+](\sqrt{\text{Ca}^{2+}})/[\sqrt{\text{Ca}^{2+}}](\text{Na}^+) = \sqrt{k_{\text{ex(Kerr)}}} = k_{\text{ex}} \quad (8.17)$$

This equation is also known as the *Gapon equation*.

### 8.7.2 THE VANSELOW EQUATION

Vanselow considers the activity of adsorbed cations proportional to the mole fraction of total occupying cations present. In a mono-divalent cation exchange involving again  $\text{Na}^+$  and  $\text{Ca}^{2+}$ , Vanselow considers:

$$\text{Proportion of Na adsorbed} = [\text{Na}^+]/[\text{Na}^+ + \text{Ca}^{2+}]$$

$$\text{Proportion of Ca adsorbed} = [\text{Ca}^{2+}]/[\text{Na}^+ + \text{Ca}^{2+}]$$

The two above conditions are the basis for creating Vanselow's equation, which was discussed as a big issue for Sposito's opinion in relating the van Laar equation with Vanselow's equation (see Equation 8.4).

By substituting the above in Equation 8.14, the following model is obtained:

$$\{([\text{Na}^+]/[\text{Na}^+ + \text{Ca}^{2+}])^2(\text{Ca}^{2+})\}/\{([\text{Ca}^{2+}]/[\text{Na}^+ + \text{Ca}^{2+}])(\text{Na}^+)^2\} = k$$

Rearranging this gives Vanselow's equation:

$$\{[\text{Na}^+]^2(\text{Ca}^{2+})\}/\{[\text{Ca}^{2+}][\text{Na}^+ + \text{Ca}^{2+}](\text{Na}^+)^2\} = k \quad (8.18)$$

Again, [ ] denotes adsorbed cations, and ( ) refers to ions free in solution. Krishnamoorthy and Overstreet (1949) developed a similar equation that tends to be classified by some scientists in the category of kinetic equations.

## 8.8 KINETIC EQUATIONS OF CATION EXCHANGE

The kinetic type of formulation was developed by Gapon (1933), Jenny (1936), and Davis (1945). They are in essence the same formulas as expressed by Equation 8.15. Gaines and Thomas (1955) also developed a similar cation exchange equation as the formulas reported by Krishnamoorthy and Overstreet, Jenny, and Davies:

$$[\text{Na}^+]^2(\text{Ca}^{2+})/[\text{Ca}^{2+}](\text{Na}^+)^2 = k[\text{Na}^+ + \text{Ca}^{2+}]$$

Rearranging the *Gaines and Thomas model* above gives:

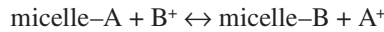
$$[\text{Na}^+]^2(\text{Ca}^{2+})/\{[\text{Ca}^{2+}](\text{Na}^+)^2[\text{Na}^+ + \text{Ca}^{2+}]\} = k \quad (8.19)$$

Equation 8.19 shows no fundamental differences in comparison with Equation 8.18.

## 8.9 THERMODYNAMIC EQUATIONS OF CATION EXCHANGE

Gaines and Thomas (1955) claim that their equation, as shown above in Equation 8.19, has been developed from thermodynamic concepts. As indicated earlier in Section 4.22, *chemical thermodynamics* is the science related to energy changes within chemical systems. At equilibrium, the energy changes of reactants must equal the energy changes of the products, as formulated by Equation 4.50. If thermodynamic concepts are to be applied to cation exchange equations, an energy change parameter, such as  $\Delta G$ , should be provided in the formula.

For a general exchange reaction involving monovalent cations,  $A^+$  and  $B^+$ , the equation at equilibrium can be illustrated as follows:



Application of the mass action law gives again:

$$K_{\text{eq}} = K_{\text{ex}} = [\text{B}^+](A^+)/[A^+](B^+)$$

The free energy change of the exchange reaction above in thermodynamic concepts is then written as:

$$\Delta G_r = \Delta G_r^\circ + RT \ln [\text{B}^+](A^+)/[A^+](B^+)$$

or

$$\Delta G_r = \Delta G_r^\circ + RT \ln K_{\text{ex}}$$

At equilibrium condition,  $\Delta G_r = 0$ , and the following relationship is then valid:

$$\Delta G_r = 0 = \Delta G_r^\circ + RT \ln K_{\text{ex}}$$

Therefore,

$$\Delta G_r^\circ = -RT \ln [\text{B}^+](A^+)/[A^+](B^+) \quad (8.20)$$

or

$$\Delta G_r^\circ = -1.364 \log K_{\text{ex}} \quad \text{at } 25^\circ\text{C} = 298\text{K}$$

The selectivity coefficient,  $K_{\text{ex}}$ , called *activity coefficient* by Sparks (2003), is addressed in detail by Sparks, who presented methods for calculating the activity coefficient of the exchanger phase and the thermodynamic equilibrium constant. His high-powered statistics elevated his book to a different level of audience, assumed to be well versed in the principles of soil chemistry. Hence, Sparks' 2003 book, quite different in approach than this book emphasizing "principles," is understood as targeting highly specialized scientists and qualified doctoral students capable of reading such complex formulas.

### 8.9.1 THE QUANTITY/INTENSITY (Q/I) RELATION

The thermodynamic concept in describing cation exchange reactions can be applied to predict the cation status in soils. Relative abundance and availability of free and exchangeable cations to plants in relation to the amount of cations adsorbed by soil colloids can be estimated. Such a relationship was presented originally by Beckett (1964a,b) for studying the rate of exchange of K in soils by Ca, or by Ca and Mg, in his famous concept of *quantity/intensity* (Q/I) relation. The factor *quantity* refers to the concentration of K in soils, liberated by exchange with Ca, whereas the *intensity factor* is the activity ratio of the free ions K/Ca or K/(Ca+Mg). Therefore, the Q/I ratio relates the change in K concentration in soils as affected by the activity ratio of K/(Ca+Mg), and is usually formulated as follows:

$$Q/I = a_K / \sqrt{a_{(Ca+Mg)}} \quad (8.21)$$

where  $a$  is the activity.

By applying thermodynamic concepts, Equation 8.21 assumes the following form:

$$RT \ln Q/I = a_K / \sqrt{a_{(Ca+Mg)}} \quad (8.22)$$

Equation 8.22 is considered to represent the free energy change of an exchange reaction between K and (Ca + Mg) ions in soils, and it is believed that this Q/I ratio can be used as a measure of availability of K to plant growth (Sparks and Liebhardt, 1981). Properly used, the formula for free energy change of the exchange reaction between K and (Ca + Mg) ions should carry a negative sign as follows:

$$\Delta G_r^\circ = -RT \ln Q/I = a_K / \sqrt{a_{(Ca+Mg)}} = -RT \ln Q/I$$

But, because both the activity and Q/I ratios carry negative signs, it is perhaps justifiable to cancel the negative sign when only the Q/I relation is to be considered. According to Wang et al. (2004), this Q/I relation is considered useful for the study of short-term K-dynamics in soil solutions, which involves also the release of K from nonexchangeable sites.

The activity ratio in Equation 8.22 is not a new concept but is the progeny of the mass action equations of Kerr and Gapon for a mono-divalent cation exchange reaction (see Equations 8.16 and 8.17). In the mass action equation, the term *activity ratio* is not used, because (1) the exchange reaction is considered to have reached equilibrium condition, and (2) the units of concentration in the ratio

$$(K^+) / (\sqrt{Ca^{2+}})$$

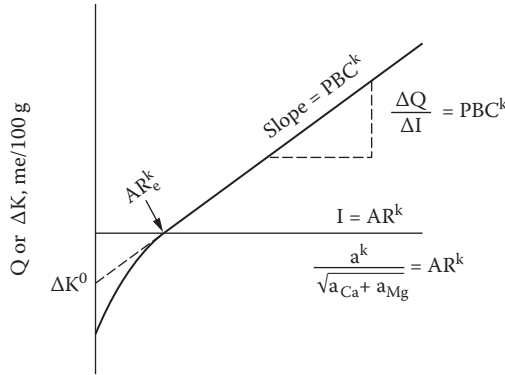
are in moles/L. By multiplying both the nominator and the denominator with the activity coefficient,  $\gamma$ , the values for concentrations change into activities, and the ratio assumes the following form:

$$\text{Activity ratio} = [(K^+)_{r_K}] / [(\sqrt{Ca^{2+}})_{(r_{Ca})}^{1/2}] \quad (8.23)$$

The activity coefficient  $\gamma$  can be calculated using the Debye–Hückel formula as discussed in Chapter 3. By using the concept of activity, Equation 8.21 changes into the equation as presented by Beckett (1964a,b) and is then called the activity ratio,  $AR^K$ :

$$AR^K = a_K / \sqrt{a_{Ca^{2+}}}$$





**FIGURE 8.2** An example of a quantity/intensity relation curve, in which the Q (quantity) factor is the Y-axis, and the I (intensity) factor is the abscissa.

The Q/I relation can be expressed in a curve, in which the factor *quantity* is represented by  $\Delta K$  on the Y axis, relating the change or difference ( $\Delta$ ) in concentration of K in the soil solution, whereas the *intensity factor* is recorded on the abscissa representing the activity ratio (Figure 8.2).

The Q/I curve is very characteristic, because its upper part is linear, whereas the bottom part is curvilinear in regression. The linear portion is considered to be a special case of the Gapon equation and is attributed to nonspecific sites for K related to planar surfaces. The curvilinear portion is caused by specific sites with a high affinity for K, such as edges of clay crystals and wedge sites of vermiculites, hydroxyaluminum interlayer vermiculite (HIV), and weathered micas.

The  $AR_e^k$  value, or the equilibrium (e), activity ratio of K, is a measure of availability (intensity) of labile K in soils. The value of  $AR_e^k$  increases as a result of K fertilization, and is noticed to decrease with liming. Van Schouwenburg and Schuffelen (1963) are of the opinion that if:

$$AR_e^k < 0.001 \rightarrow K \text{ is adsorbed on edge positions}$$

$$AR_e^k > 0.001 \rightarrow K \text{ is adsorbed on planar surfaces}$$

The intersect of the linear curve with the Y axis, obtained by extrapolation, is called  $\Delta K^0$ , which together with  $\Delta K$ , represents the exchangeable K or labile K pool. This relationship can be expressed as follows:

$$[K] = \Delta K + \Delta K^0 \tag{8.24}$$

where  $[K]$  is the amount of K adsorbed on exchange sites.

This labile pool of K increases with K fertilization and liming soils. The value of  $\Delta K^0$  is found to become more negative with increased addition of lime or increased K fertilization, indicating more K is released into the soil solution. When adsorption of K occurs on planar surfaces, the value of  $\Delta K^0$  compares favorably to the amount of K extracted by the  $NH_4OAc$  method. On the other hand, when adsorption occurs mainly on specific sites, the value of  $\Delta K^0$  is found to be smaller than the amount of K extracted by  $NH_4OAc$  (Sparks and Liebhardt, 1981).

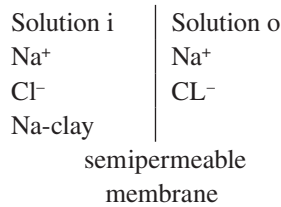
The slope of the linear portion of the curve is represented by the ratio  $\Delta K/\Delta AR^k$ . This ratio is called  $PBC^k$  or *potential buffering capacity* for potassium. It is related to the CEC of the soil and is considered as a measure of the soil's capacity to maintain the concentration of K (intensity) at a constant value in the soil. A high  $PBC^k$  value indicates that K availability in the soil is excellent. On the other hand, a low  $PBC^k$  value suggests the need for K fertilization. Values for  $PBC^k$  are also noted to increase with lime addition, which is believed caused by an increase in pH-dependent

charges. In adsorption and desorption studies with soils in Florida, Wang (2000) noted that the PBC<sup>K</sup> of sandy soils, in the range of 0.26 to 3.9 cmol kg<sup>-1</sup> M<sup>-1/2</sup>, was much lower than that for clay and silt loam soils.

## 8.10 THE CATION EXCHANGE EQUATION BASED ON THE DONNAN THEORY

### 8.10.1 THE DONNAN EQUILIBRIUM LAW

A Donnan system is a system composed of solution i and o, separated by a semipermeable membrane (i = inside solution, o = outside solution). Solution i contains Na<sup>+</sup>, Cl<sup>-</sup>, and Na-clay, whereas solution o contains only Na<sup>+</sup> and Cl<sup>-</sup> ions of different concentrations from those in solution i.



The membrane is permeable only to Na<sup>+</sup> and Cl<sup>-</sup> ions; therefore, only these ions will move and distribute themselves in solutions i and o until equilibrium is reached. At equilibrium, the following relation holds:

$$(\text{Na}^+)_i(\text{Cl}^-)_i = (\text{Na}^+)_o(\text{Cl}^-)_o \quad (8.25)$$

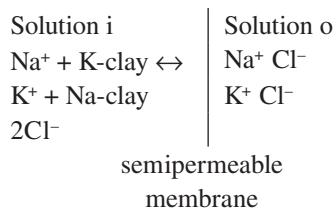
or

$$(\text{Na}^+)_i / (\text{Na}^+)_o = (\text{Cl}^-)_o / (\text{Cl}^-)_i$$

Equation 8.25 is called the *Donnan equilibrium law*. Donnan systems are present in soils and are of special importance in soil solution–plant root relationships. They have been extended to cation exchange phenomena and predict essentially the same as the mass action law equation of Kerr.

### 8.10.2 THE DONNAN EQUATION OF CATION EXCHANGE

Assume again the presence of a Donnan system composed of solution i and o, separated by a semipermeable membrane. In solution i a monovalent exchange reaction occurs involving Na<sup>+</sup> and K<sup>+</sup> in the presence of clay. The counterions for free Na<sup>+</sup> and K<sup>+</sup> are Cl<sup>-</sup> ions. The system can be illustrated by the diagram as follows:



At equilibrium, the Donnan rule states:

$$(\text{Na}^+)_i(\text{Cl}^-)_i = (\text{Na}^+)_o(\text{Cl}^-)_o \quad (8.26)$$

and

$$(K^+)_i(Cl^-)_i = (K^+)_o(Cl^-)_o \quad (8.27)$$

where

$$Na_i^+ = Na_{free}^+ + Na_{exch}$$

and

$$K_i^+ = K_{free}^+ + K_{exch}$$

Substituting these concentrations in Equation 8.26 and Equation 8.27, respectively, gives:

$$(Na^+ + Na_{exch})_i(Cl^-)_i = (Na^+)_o(Cl^-)_o \quad (8.28)$$

and

$$(K^+ + K_{exch})_i(Cl^-)_i = (K^+)_o(Cl^-)_o \quad (8.29)$$

Division of Equation 8.28 by Equation 8.29 produces:

$$(Na^+ + Na_{exch})_i / (K^+ + K_{exch})_i = (Na^+)_o / (K^+)_o \quad (8.30)$$

The assumption is made that  $Na_{exch} \gg Na^+$ , and  $K_{exch} \gg K^+$ ; therefore,

$$(Na^+ + Na_{exch}) = (Na_{exch}) \text{ and } (K^+ + K_{exch}) = (K_{exch})$$

Substituting these in Equation 8.30 gives:

$$(Na_{exch}) / (K_{exch}) = (Na^+)_o / (K^+)_o$$

or

$$[Na^+] / [K^+] = (Na^+) / (K^+)$$

Rearranging this equation gives:

$$[Na^+](K^+) = [K^+](Na^+)$$

Division by  $[K^+](Na^+)$  gives:

$$[Na^+](K^+) / [K^+](Na^+) = 1 \quad (8.31)$$

where [ ] and ( ) denote again exchangeable and free cations, respectively.

Equation 8.31 is called the *Donnan equation* in cation exchange. It is similar to Kerr's cation exchange equation, with the only difference that in the Donnan equation, the exchange constant  $k = 1$ .

Using NaOH and the electric potentials (E) of  $Na^+$  and  $OH^-$  ions inside (i) and outside (o) the membrane, Grot (2007) arrives at a similar Donnan equation. The electric potentials of the  $Na^+$  and  $OH^-$  are represented by Grot as follows:

$$E_{\text{Na}} = (RT/F)\ln(\text{Na}^{\circ}/(\text{Na}^+)^i)$$

$$E_{\text{OH}} = (RT/F)\ln(\text{OH}^-)^i/(\text{OH}^-)^{\circ}$$

At equilibrium,  $E_{\text{Na}} = E_{\text{OH}}$ ; therefore,

$$(RT/F)\ln(\text{Na}^{\circ}/(\text{Na}^+)^i) = (RT/F)\ln(\text{OH}^-)^i/(\text{OH}^-)^{\circ}$$

$$(\text{Na}^{\circ}/(\text{Na}^+)^i) = (\text{OH}^-)^i/(\text{OH}^-)^{\circ}$$

$$(\text{Na}^+)^i(\text{OH}^-)^i = (\text{Na}^{\circ})(\text{OH}^-)^{\circ}$$

The above are then the Donnan equilibrium equations by Grot (2007).

### 8.11 THE CATION EXCHANGE EQUATION OF ERIKSSON

Eriksson combined the Donnan and Vanselow theories and found:

$$\{[\text{Na}^+]^2(\text{Ca}^{2+})(C)\}/\{(\text{Na}^+)^2[\text{Ca}^{2+}][\text{Na}^+ + \text{Ca}^{2+}]\} = k \quad (8.32)$$

where C is the cation exchange capacity of the colloid.

### 8.12 THE CATION EXCHANGE EQUATION ACCORDING TO THE DIFFUSE DOUBLE-LAYER THEORY

Although considered by many to be the most realistic approach to describing ion exchange equilibria, the diffuse double-layer formula developed by Eriksson (1952) is far from simple. The equation is too complex to be of any practical importance. It has limited application and works well for cation exchange equilibrium between Na and Ca but not between other ions. Therefore, for those who are in need of the diffuse double-layer equation, reference is made to Eriksson (1952) and Lagerwerff and Bolt (1959). However, for completeness, the double-layer cation exchange equation is given below. It is believed that this diffuse double-layer equation can be reduced to a Gapon equation.

$$\frac{[\text{Na}^+]}{[\text{Ca}^{2+}]} = \frac{[1/\beta/\text{arc sinh}(b)^{1/2}\Gamma / [(\text{Ca}^{2+})^{1/2} + 4VC(\text{Ca}^{2+})^{1/2}]}{\Gamma - [\text{Na}^+]/(\text{Ca}^{2+})^{1/2}(\beta)^{1/2}]\text{arc sinh}(\beta)^{1/2}\Gamma / [\text{Na}^+]/(\text{Ca}^{2+})^{1/2}} R$$

$$R = \frac{(\text{Na}^+)}{(\text{Ca}^{2+})^{1/2}}$$

$$\beta = 8 / 100RT$$

$$VC = 1$$

$$\Gamma = \text{charge density (mEq/cm}^2\text{) and arc sinh} = \text{sinh}^{-1}$$

### 8.13 SCHOFIELD'S RATIO LAW

From the preceding discussion, it is apparent that although many equations are available to describe cation exchange phenomena, almost all of them have one thing in common. They all state that the

ratios of the products of adsorbed cations and cations free in solution are constant. This can be illustrated by the mass action law and the Gapon equations. Both use the formula:

$$[\text{Na}^+](\sqrt{\text{Ca}^{2+}})/[\sqrt{\text{Ca}^{2+}}](\text{Na}^+) = k$$

in which [ ] denotes adsorbed cations, and ( ) denotes cations free in solution. Rearranging the equation gives:

$$[\text{Na}^+](\sqrt{\text{Ca}^{2+}}) = k[\sqrt{\text{Ca}^{2+}}](\text{Na}^+)$$

or

$$[\text{Na}^+]/(\sqrt{\text{Ca}^{2+}}) = (1/k)\{[\text{Na}^+]/[\sqrt{\text{Ca}^{2+}}]\} \quad (8.33)$$

The latter means that in equilibrium, the ratio of cations in solution depends on the ratio of cations adsorbed on the colloid surface. If the amount of cations adsorbed does not change significantly, or in other words, the ratio of adsorbed cations  $[\text{Na}^+]/[\sqrt{\text{Ca}^{2+}}]$  remains constant, the ratio of cations in solution  $[\text{Na}^+]/[\sqrt{\text{Ca}^{2+}}]$  is also constant. This activity ratio is interpreted as the *ratio law of Schofield* (1947). However, Chesworth (2008) claims that as originally written by Schofield the law reads somewhat differently, and he quoted it as follows: “when cations in a solution are in equilibrium with a larger number of exchangeable ions, a change in concentration of the solution will not change the equilibrium, if the concentration of monovalent ions is changed in one ratio, of that of the divalent in the square root, and that of trivalent ions in the cube root of that ratio” (p. 26). The sentence is somewhat cumbersome, but it still supports the meaning of Equation 8.33. The activity ratios as derived above are generally accepted as Schofield’s ratio law. They are noted to remain constant with changes in solution concentration, and hence are stable parameters for studying the cation status in soil solutions. This ratio law is used to predict the soil solution concentration as affected by fertilizers, lime application, or dilution by irrigation or rain. When upon dilution the  $\text{Na}^+$  concentration decreases five times, the value of  $(\sqrt{\text{Ca}^{2+}})$  must also decrease five times in order to obey the ratio law. This means that the absolute  $\text{Ca}^{2+}$  concentration then decreases  $5^2$  times. Hence, dilution favors a decrease in Ca content. If, on the other hand,  $\text{Na}^+$  increases five times because of drying of the soil in summertime, to maintain a constant ratio,  $(\sqrt{\text{Ca}^{2+}})$  must also increase five times. Therefore,  $\text{Ca}^{2+}$  concentration increases  $5^2$  times. Thomas (1974), quoting data from D. E. Kissel’s 1969 Ph.D. dissertation (University of Kentucky), states that Schofield’s ratio law can also be applied to mono-trivalent cation exchange. In the case of an exchange reaction involving  $\text{Na}^+$  and  $\text{Al}^{3+}$  ions, the ratio law can be written as follows:

$$(\text{Na}^+)/(\text{Al}^{3+})^{1/3} = (1/k)\{[\text{Na}^+]/[\text{Al}^{3+}]^{1/3}\} \quad (8.34)$$

This also suggests that upon dilution by rain or irrigation, the  $\text{Al}^{3+}$  ion concentration will decrease faster (a decrease of a value to the third power) than that of  $\text{Na}^+$  ions. For example, if  $\text{Na}^+$  ions were to decrease again five times, Schofield’s ratio law will be obeyed if  $(\text{Al}^{3+})^{1/3}$  also decreases five times. This means that the absolute concentration of  $\text{Al}^{3+}$  ions decreases then  $5^3$  or 125 times. Upon drying of the soil, the  $\text{Al}^{3+}$  concentration, therefore, also increases faster (with a value raised to the third power) than the  $\text{Na}^+$  ions. The substantially faster decrease or increase in  $\text{Al}^{3+}$  ions in the soil solution may cause changes in soil acidity. Upon dilution of the soil, soil acidity is expected to decrease because of a substantial loss of  $\text{Al}^{3+}$  ions from the soil solution. On the other hand, upon drying of

the soil in summer, soil acidity may increase due to a substantial gain in  $\text{Al}^{3+}$  ions. However, not much data are available and more research is needed to confirm the hypothesis above.

## 8.14 FIXATION OF CATIONS

Under certain conditions, the adsorbed cations are held so strongly by clays that they cannot be recovered by exchange reactions. These cations are called *fixed cations*. Although fixation can occur with almost any cation, the most important fixation reaction is with  $\text{K}^+$  and  $\text{NH}_4^+$  ions. Fixation of  $\text{K}^+$  and  $\text{NH}_4^+$  occurs by a similar mechanism. Among the several reasons reported for fixation, the most important is the entrapment of the ions in the intermicellar regions of the clays. Expanding lattice clays have octahedral holes of 1.40 Å in their intermicellar surfaces. When  $\text{K}^+$  or  $\text{NH}_4^+$  penetrates the intermicellar space, it will fit snugly into the holes. Upon closure of the space, the  $\text{K}^+$  or  $\text{NH}_4^+$  ions are trapped between the clay layers. They become, then, relatively nonexchangeable and are called *fixed* (Bolt et al., 1976; Rich, 1968; Van der Marel, 1959).

Many soil minerals were reported to contribute to  $\text{K}^+$  and  $\text{NH}_4^+$  fixation (e.g., micas, illites, smectites, and vermiculites). Van der Marel (1959) stated that permutites, zeolites, feldspars, and glauconites had the capacity to fix potassium. Rich (1968) was of the opinion that especially those minerals with strong *interlayer charges* and *wedge zones* exhibited sites for high potassium selectivity—in other words, exhibited high potassium fixation. One of the clay minerals known for possessing wedge zones and high interlayer charges is the HIV mineral or hydroxy-interlayer vermiculite. These wedge zones postulated to be attributed to marginal curling on mineral surfaces provide enlarged interlayer spacings for entrapment of cations and humic acids (Tan, 2009). Sparks (2003) indicated that the position of the wedge zones is important. If it is located at the edges, K selectivity is less as compared to when it is deep within the interlayer space. Sparks also claimed that hydroxyl–Al polymers present in interlayer spaces reduce CEC and may keep these spaces open, enhancing exchange of fixed  $\text{K}^+$  and  $\text{NH}_4^+$  by other ions of similar size. As indicated above, the interlayer charge is the other factor affecting fixation of cations. An increase in interlayer charges will increase fixation of cations. It is believed that such an increase in interlayer charges can be caused by reduction of structural Fe(III) into Fe(II) or isomorphous substitution of structural Fe(III) (Stucki et al., 2002). Fixation of cations due to iron-reducing reactions may not only affect  $\text{K}^+$  and  $\text{NH}_4^+$ , but also  $\text{Ca}^{2+}$ ,  $\text{Cu}^{2+}$ , and  $\text{Zn}^{2+}$  (Bergaya et al., 2006). Though these authors indicate that reducing conditions are of particular importance in paddy soils, the present author wants to add also soils in the wetlands and soils in the flood plains, where constant or periodic flooding may affect the redox state of Fe present as structural iron in the clay mineral.

Although the quantity of K retained by fixation can assume high proportions, potassium fixation is currently considered more a disturbing than a harmful reaction. Depending on the conditions, significant amounts of the fixed K can be released and made available to plants. It is believed that equilibrium exists between the amount of K fixed, the amount of K adsorbed, and the concentration of  $\text{K}^+$  free in solution. The equilibrium can be illustrated as follows:



When the concentration of free  $\text{K}^+$  ions decreases because of plant uptake or loss by leaching, the equilibrium above is broken, and K from the adsorption sites will be released to restore the equilibrium. This release of adsorbed-K will in turn cause the fixed-K to be released also to fix the equilibrium between fixed-K and adsorbed-K. The presence of humic and fulvic acids has been found to accelerate the release of fixed potassium (Tan, 1978b). Tisdale and Nelson (1975) are of the opinion that potassium fixation is a process of conserving potassium in nature. Fixation is of practical importance in sandy soils, where K is more likely to be lost rapidly by leaching. Continued application of  $\text{K}^+$  or  $\text{NH}_4^+$  fertilizers will decrease K fixation. The addition of K will fill the vacant positions in the clay lattice, in this way satisfying the fixation capacity of soils.

## 8.15 BASE SATURATION

The *base saturation* is a property closely related to CEC. It is defined as:

$$\% \text{Base saturation} = \{[\sum \text{Exchangeable bases (in mEq/100 g)}/\text{CEC}] \times 100\%$$

The most common exchangeable bases in soils used for calculation of the %base saturation are Na, K, Ca, and Mg. They are usually extracted by the neutral 1 N NH<sub>4</sub>-acetate procedure. An illustration of the calculation of % base saturation is provided.

### EXAMPLE OF CALCULATION

Cation Exchange Analysis Yields the Following Results

Exchangeable Cations (mEq/100 g)							
Soil	Horizon	Ca	Mg	K	Na	H	Al
Cecil	A	0.75	0.40	0.20	0.09	1.2	1.6

$$\text{CEC} = 0.75 + 0.40 + 0.20 + 0.09 + 1.2 + 1.6 = 4.24 \text{ mEq/100 g.}$$

$$\% \text{Base saturation} = [(0.75 + 0.40 + 0.20 + 0.09)/4.24] \times 100\% = 33.9\%$$

$$\% \text{Ca saturation} = (0.75/4.24) \times 100\% = 17.7\%$$

$$\% \text{Mg saturation} = (0.40/4.24) \times 100\% = 9.4\%$$

$$\% \text{K saturation} = (0.20/4.24) \times 100\% = 4.7\%$$

$$\% \text{Na saturation} = (0.09/4.24) \times 100\% = 2.1\%$$

$$\% \text{H}^+ \text{ saturation} = (1.2/4.24) \times 100\% = 28.3\%$$

$$\% \text{Al saturation} = (1.6/4.24) \times 100\% = 37.7\%$$

Note that in the calculation of %base saturation, exchangeable Al is not included in the summation of exchangeable bases. In pure chemistry Al is a base, but in soils Al contributes to soil acidity.

A positive correlation exists between percentage base saturation and soil pH. Generally we can see that the %base saturation is high if soil pH is high. Consequently, arid region soils are usually higher in %base saturation than soils in humid regions. Low base saturations mean the presence of a lot of H<sup>+</sup> ions.

The base saturation is frequently considered to be an indication of soil fertility. The ease with which adsorbed cations are released to plants also depends on degree of base saturation. A soil is considered very fertile if the percentage base saturation is  $\geq 80\%$ , medium fertile if percentage base saturation is 80% to 50%, and nonfertile when percentage base saturation is  $\leq 50\%$ . In other words, a soil with a percentage base saturation of 80% has its cation exchange capacity saturated with 80% bases and 20% H<sup>+</sup> ions. The chances for the plant roots to obtain the bases by exchange reactions are, therefore, greatly improved. On the other hand, soils, with a percentage base saturation of 50%, will have their CEC saturated with 50% bases and 50% H<sup>+</sup> ions. Hence, the plant roots are offered a 50/50 chance to obtain bases or H<sup>+</sup> ions.

A soil with a percentage base saturation of 80% will also release the exchangeable bases more easily than the same soil with a percentage base saturation of 50%. Liming of acid soils is the common means by which the percentage base saturation can be increased.



### 8.16 ADSORPTION AND EXCHANGE OF CATIONS BY SOIL ORGANIC MATTER

Cations can also be adsorbed and exchanged by soil organic matter. With certain cations, and in particular with the transition metals, Al, Fe, Mn, Cu, and Zn, the organic compounds will form metal–organo complexes or chelates. Humic and fulvic acids are especially important in the formation of such complexes. These reactions to form complexes should be viewed as rather different from the regular Coulombic attraction of cations in a double-layer region of clay surfaces. The main difference is that the cation adsorbed to form a complex cannot be exchanged in the usual manner against, for example,  $\text{Na}^+$  ions. A  $\text{Na}^+$  ion will not be able to occupy the position of a  $\text{Cu}^{2+}$  or  $\text{Mn}^{2+}$  ion in the complex. The complexed ion must be regarded as part of the solid complex compound; hence, the binding of these cations by organic ligands should be taken out of the context of regular cation exchange phenomena. The exchange equations discussed earlier are not applicable to adsorption reaction between cations and soil organic matter. As will be discussed in Chapter 12, the relative preference of soil organic matter, especially humic compounds, to form complexes with transition metals should be specified in terms of *stability constants*. At  $\text{pH} > 7$ , these cations are generally complexed much more strongly than at low pH. The reason is that at high pH values, both the functional groups (e.g., carboxyl and phenolic–OH groups) are dissociated and chemically active in complex reactions. At low pH values, only the carboxyl groups are dissociated, whereas the phenolic–OH groups are usually still nondissociated, in other words are still present in protonated forms (see Section 5.9). Therefore, at  $\text{pH} > 7$ , the cations are held by multiple bonds contributing to chelation reaction. In contrast, at low pH the cations are held by single bonds, which produces, of course, weaker bonds than multiple bonds.

---

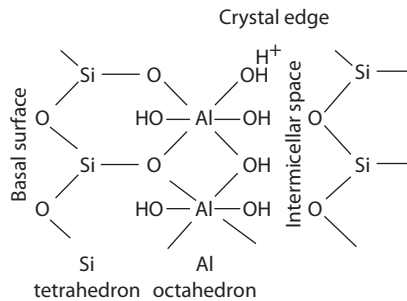
# 9 Anion Exchange

## 9.1 POSITIVE CHARGES

The adsorption of anions in soils has been known for some time. Early in the 1930s, Mattson (1931) reported that soils high in Al- and Fe-oxide clays were capable of holding large amounts of  $\text{Cl}^-$  and  $\text{SO}_4^{2-}$ . It was later believed that the anions were adsorbed because of displacement of OH in the hydrous oxide minerals and coatings (Mattson and Wiklander, 1940). The exact mechanism was still unknown at that time, though several scientists noted the influence of pH on the rate of anion adsorption. At low soil pH, when the hydroxyl ion concentration was low, the rate of  $\text{Cl}^-$  and  $\text{SO}_4^{2-}$  adsorption was high. Phosphate and fluoride anions behaved similarly at low pH, but they tended in addition to cause formation of insoluble compounds in the form of precipitates. Apparently, no dramatic advances have been achieved during the years, because the topics of anion exchange and positive charges have only been stated briefly in the current publications without any really new significant details (Sparks, 2003; Troeh and Thompson, 2005).

In Section 6.7, it was indicated that, under certain conditions, the soil colloids may also carry positive charges, which are the main reason today for their capacity to attract anions. It is especially true for the Fe- and Al-oxide minerals and amorphous soil colloids, although under suitable conditions, layer silicates can also develop positive charges. Iron oxide coatings, precipitated on kaolinite, illite, and smectite, have been noted to produce positive charges, and a change in surface properties (Parfitt, 1980). The charges of the various hydrous oxide minerals commonly found in soils are usually dependent on pH and on the electrolyte concentration of the surrounding medium. These pH-dependent charges arise from association and dissociation of potential-determining ions,  $\text{OH}^-$  and  $\text{H}^+$ , as discussed in Section 6.6. The pH at which the surface charge of the soil colloids equals zero is called the *zero point charge* (ZPC). It is also called PZC (point zero charge) by several other authors, who define it as the pH at which the summation of surface charges from all sources equals zero (Bowden et al., 1980). According to Bowden et al. (1980), the diffuse double-layer charge ( $\sigma_d$ ) then will also equal zero. Because in their opinion this is in conflict with the definition of the International Union of Pure and Applied Chemistry (IUPAC), these authors propose the use of *pristine point zero charge* (PPZC). They believe that the PPZC is a unique characteristic that does not depend on the nature of the electrolytes. The PPZC can be used as a reference point in the discussion of shifts in PZC or ZPC when specific adsorption of ions occurs. At a soil pH > ZPC, the mineral is usually negative in charge and exhibits attraction for cations. However, at a soil pH < ZPC, the surface of the mineral is positively charged and has the capacity to attract anions. According to Greenland and Hayes (1978), the theoretical maximum charge on the colloidal surface is determined by the density of the hydroxyl groups, which amounts to one OH group per  $0.20 \text{ nm}^2$ . However, this maximum charge can only be reached at pH levels far below the ZPC value and also in the presence of high electrolyte concentrations. Therefore, in the normal pH ranges in soils (pH 5 to 8), the charge density is always less than the calculated maximum charge.

The wide ranges reported for the ZPC values of the various oxides and hydrous oxide minerals are caused by differences in hydration state, effects of impurities, different coordination numbers for the cation, and by the influence of specific adsorption with certain cations (Greenland and Hayes, 1978). The hydrous oxides of iron and aluminum are known to enter rapidly in ligand exchange reactions with silicate, phosphate, molybdate, borate, and selenite anions. These reactions, also called chemisorption, alter the surface properties of the oxides so that their ZPCs are



**FIGURE 9.1** Protonation of structural aluminol groups.

reduced substantially. Because in most soils the soil solution is saturated with silica, the Fe- and Al-hydroxides in soils will have reacted with silica, causing a shift in their ZPC values toward that of silica. Greenland and Hayes (1978) believe that this is the reason for the very low ZPC values of naturally occurring hydrous oxides and several clay minerals reported by Van Schuylenborgh and Sanger (1949) and other authors. The ZPC of iron oxide minerals has also been reported to decrease as anion adsorption increases. When phosphate is adsorbed, the positive charge of the oxide mineral decreases. The net surface charge becomes highly negative with high amounts of P adsorbed, and accounts for an increase in cation exchange capacity (CEC) (Parfitt, 1980).

Positive charges can also occur at the edges of clay minerals, or at the broken surfaces of an octahedral sheet. This kind of charge is also significant only at pH values below the isoelectric point or zero point charge. Therefore, a broken-edged surface has a positively charged double layer at low soil pH. The double layer becomes increasingly more positive with decreasing soil pH. Kaolinite and other types of 1:1 minerals have been reported to exhibit small amounts of positive charges on their crystal edges (see also Troeh and Thompson, 2005). This is believed to be caused by an aluminol group adsorbing a proton, as can be illustrated by the reaction shown in Figure 9.1.

Because the negative charge due to isomorphous substitution will remain constant regardless of pH changes, the basal surfaces of kaolinite minerals will, therefore, be negatively charged, while at the same time the edges are positively charged. Consequently, kaolinite layers exhibit *amphoteric* characteristics and can react at the same time with both cations and anions. An interaction can also occur between positively charged edges of kaolinite particles and negatively charged basal surfaces of other kaolinite particles. This may cause *self-flocculation* of kaolinite clays.

## 9.2 ADSORPTION OF ANIONS BY SOIL COLLOIDS

Although the main force of attraction of anions is positive charges on the colloid surfaces, today a number of other reasons can be given for anion adsorption by soil colloids. When adsorption of anions is caused by electrostatic forces, it is called *nonspecific adsorption*. Two types of adsorption of anions can be recognized in this category: *negative* and *positive adsorption*. When the adsorption reaction is caused by nonelectrostatic forces, such as ligand exchange or complexation, it is called *specific adsorption* or *chemisorption*. A lack of agreement seems to exist in the use of the term *chemisorption* for defining anion adsorption, especially in phosphate adsorption by silicate and hydrous oxide clays (Stevenson, 1986). Several authors consider chemisorption to include (1) adsorption at protonated surface sites ( $-\text{OHH}^+$ ), which is a form of electrostatic adsorption; (2) adsorption by replacement of structural OH groups, which is the adsorption due to ligand exchange (see also FIFA, 2006; White, 2005); and (3) a physical sorption of phosphate as a potential-determining ion, which produces or increases the negative charge of the colloid surface.

Ions with  $\text{pK}_a$  values in the range of soil pH 3 to 10 are considered ions that will participate most likely in specific adsorption reactions. These ions include phosphate ions. On the other hand, anions

with extreme  $pK_a$  values ( $pK_a < 3$ ) are subject to nonspecific adsorption (e.g.,  $Cl^-$  and  $NO_3^-$ ). These strongly acid anions, called indifferent ions, are believed to have a very weak affinity for protons, and most likely they also will have a weak affinity for the electrophilic metal ions making up the surfaces of oxide and hydrous oxide minerals (Bowden et al., 1980). *Indifferent ions* were defined by Bowden et al. (1980) as ions that can be adsorbed only when the colloid surface is already charged. They are also called *noncharging* ions as opposed to *charging* ions, which are defined as ions that can be adsorbed when there is no charge on the colloid surface. They give to the surface the electrical charge. Two groups of charging ions recognized by these authors are (1) potential-determining ions ( $H^+$  and  $OH^-$  ions), and (2) specifically adsorbed ions that can also charge the surfaces. This second group includes superequivalent and contact adsorbed ions in the mercury–electrode system, and chemisorbed ions or ligand exchange ions in the oxide and hydrous oxide systems.

### 9.2.1 NONSPECIFIC ADSORPTION

Nonspecific adsorption is defined above as adsorption of anions by electrostatic forces on clay minerals and metals (Yong, 2000). In terms of Sposito's concept (see Section 7.1), this falls into his category of outersphere complexation. The clay fraction in soils is usually composed of a mixture of clay minerals. As indicated in Chapter 6, especially highly weathered soils may be characterized by high amounts of layer silicate, hydrous oxide, and some amorphous minerals. Most layer silicates are normally negatively charged and will cause repulsion of anions. However, some of the layer silicates can exhibit negatively charged surfaces, and positively charged edges, as discussed above for kaolinite. Such an amphoteric character may cause anions to be attracted to edge surfaces, and cations to be simultaneously adsorbed by the basal surfaces. Depending on soil pH, most of the hydrous oxide minerals are positive in charges, which may cause electrostatic adsorption of anions.

#### 9.2.1.1 Negative Adsorption

The repulsion of anions from colloidal surfaces possessing negative charges is called *negative adsorption*. Because of this, anions are expelled from the double layer formed by the negative charge surface. On the other hand, cations are attracted and concentrated at the colloidal surface. Therefore, the double layer formed, composed of cations, is positively charged. The exclusion of anions from the double layer causes the anions to concentrate in the *bulk solution*. The amount excluded is reported to be a small part of the CEC. Bolt (1976) shows that under conditions prevailing in most soils, negative adsorption of anions is approximately only 1% to 5% of the CEC. However, negative adsorption can amount to 15% of the CEC in saline soils. Negative adsorption of anions is affected by (1) soil pH, (2) negative charge density of soil colloids, (3) the valence of anions, and (4) the presence of exchangeable cations (Bohn et al., 1979; Parfitt, 1980). The effect of soil pH is important in soils with variable charges. Decreasing the pH in these soils will usually decrease the negative charges, which in turn will decrease negative adsorption of anions. The greater the negative charge density of the minerals, the greater will be the negative adsorption of anions. Consequently, because of its greater negative charge, smectite will display a larger negative adsorption of anions than kaolinitic minerals. This difference is especially pronounced at low pH values where kaolinite edges become positively charged. The valence charge of anions has been reported to affect negative adsorption. Anions with higher valencies have a tendency to be repelled more than anions with lower valence charges; in other words, negative adsorption increases with increased valence of the anions.

The presence of exchangeable cations has been reported to affect negative adsorption of anions. For example, negative adsorption of  $Cl^-$  is noted to decrease according to the sequence  $Na > K > Ca > Ba$ , meaning that the presence of Ba on exchange sites results in the smallest negative adsorption, whereas the presence of exchangeable Na will cause the highest repulsion of  $Cl^-$  ions. Wiklander (1964) explains the above by complex statistical calculations, which repeat only that

negative adsorption of anions decreases with increasing valence of the cations. In the author's opinion, the reason is more likely that the higher valence in Ba decreases the negative charge of clays more than the valence of Na. Wiklander also points out that negative adsorption of anions decreases with increasing salt concentration, because addition of salts suppresses the unequal ion distribution between the interface and the bulk solution.

From the environmental aspect, negative adsorption of anions is a harmful process. Instead of being attracted by the colloidal surfaces, repulsion of anions causes the anions to be pushed away from the interface solution into the bulk solution, where they are free to move with the percolating water. This increases the chances of leaching of anions, important as nutrient sources for growing plants. It also increases the chances for anions to be transported and contaminate our groundwater system. When anions, such as phosphates, are transported and accumulated in this way in streams and lakes, they may cause an excessive growth of unwanted aquatic weeds, an environmental degradation process called *eutrophication*.

### 9.2.1.2 Positive Adsorption

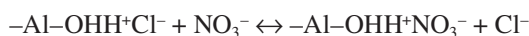
*Positive adsorption* of anions is the adsorption and concentration of anions on the positively charged surfaces or edges of soil colloids. Here, negative adsorption of cations (i.e., repulsion of cations by the positive charge surface) occurs.

A number of scientists believe that the mechanisms and factors affecting cation exchange reactions also apply to adsorption of anions. However, the anion exchange capacity (AEC) of soils is usually substantially smaller than the CEC. It is dependent on changes in electrolyte levels and on soil pH. It is also limited to special types of clays. In general, it can be noticed that the capacity of soils to adsorb anions increases with decreasing pH. Adsorption of anions is typically small in soils containing smectite clay, where variable charges are of minor importance. Small amounts of anions are likely to be adsorbed by smectite at low soil pH but none at all in slightly acid and neutral soil reactions. This is attributed to the dominant presence of permanent negative charges in smectite minerals. On the other hand, soils with variable charges and soils containing kaolinitic minerals may exhibit some anion adsorption at very low pH, but in general these soils will cause repulsion of anions at pH > 7, due to an increase in negative charges.

As with cations, lyotropic series of anions are also available in anion adsorption. Bolt (1976) reported a decreasing order of preferential adsorption among the following anions:

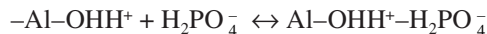


This lyotropic series is quoted also by Yong (2000), who stated that the adsorption process was a type of *physical adsorption* of anions. Bolt's lyotropic series indicates that  $\text{SiO}_4^{4-}$  and  $\text{PO}_4^{3-}$  ions are strongly adsorbed, whereas  $\text{SO}_4^{2-}$  and  $\text{NO}_3^-$  ions are adsorbed in considerably lower concentrations or are often not adsorbed. At a neutral soil reaction, or at pH > 6, positive adsorption of  $\text{SO}_4^{2-}$  and  $\text{Cl}^-$  ions is very small. These two ions are generally subject to negative adsorption. Nevertheless, some positive adsorption occurs at low pH values, where positive charges are developed by protonation of exposed hydroxyl groups at basal or edge surfaces. These truly electrostatically adsorbed anions are exchangeable with other anions in just the same manner as cations are exchanged. The exchange reaction can be illustrated as follows:



Such an exchange reaction is the reason for the development of an *anion exchange capacity* (AEC) in soils. In the older literature the anion exchange capacity is suggested to be defined as the amount of phosphate bound at pH 4 or pH 5.7 (Wiklander, 1964). In the more recent literature, the anion exchange capacity is measured by the amount of  $\text{Cl}^-$  or  $\text{NO}_3^-$  retention due to positive charges (Parfitt, 1980). However, most scientists agree that AEC determinations are less significant than

those of CEC, because not only are AEC values small, but only relatively few anions are adsorbed by true electrostatic forces. In the case of phosphate and sulfate ions, their adsorption, as will be discussed in more detail below, is more complex, and AEC is often not related to the amount of phosphate sorbed. Phosphate ions can also be adsorbed in a similar fashion by positive charges developed on the surfaces or edges of clay minerals by protonation of exposed OH groups:



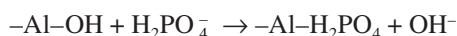
where  $-\text{Al}-\text{OH}$  represents structural Al on the clay surface.

The phosphate ion, held electrostatically in this way, is also subject to exchange. This type of reaction, prevalent in acid soils, is truly an exchangeable reaction, which is often ignored by the majority of soil scientists. In a true exchange concept, White (2005) believes that the exchange of phosphate for other anions will be controlled by the ratio law (see Section 8.10.2). He indicates in his example of exchange between phosphate and sulfate ions that the concentrations of  $\text{H}_2\text{PO}_4^-$  and  $\text{SO}_4^{2-}$  in solution will obey the activity ratio law of  $\text{H}_2\text{PO}_4^- / (\sqrt{\text{SO}_4^{2-}})$

### 9.2.2 SPECIFIC ADSORPTION

Adsorption of anions can also take place through an interaction process, which is especially important with oxide, hydrous oxide, amorphous, and other variable-charge clays. The anion adsorption capacity of these minerals is often greater than can be measured from the concentration of anions adsorbed to neutralize the positive charges. Such an adsorption of anions, called *specific adsorption*, is believed to be caused by displacement of lattice O or OH groups by anions. Because of its unique mechanism, this kind of an anion exchange reaction is also called *ligand exchange*, *chemisorption*, or *anion penetration* (Bohn et al., 1979; Bowden et al., 1980; Parfitt, 1980). Whereas in nonspecific adsorption the  $\text{Cl}^-$  or  $\text{NO}_3^-$  ions are attracted and held by electrostatic forces on the colloid surfaces, in specific adsorption the anion enters the crystal and the reaction takes place within the coordination sphere. The mechanisms of reactions involve ionic and especially covalent bonding. The terms of *diffuse ion swarm adsorption* and *innersphere surface complexation*, as defined by Sposito (1989, 2008), have been referred to as nonspecific and specific adsorption processes, respectively, in Chapter 6. Specific adsorption by covalent bonding can take place on colloid surfaces carrying negative, positive, or zero charge, and often renders the colloid surface more negative, which will be discussed below.

Anions involved in specific adsorption are mostly phosphate ions, and to a lesser extent also silicate, fluoride, and sulfate ions. The displacement reaction with phosphate can be illustrated as follows:



where  $-\text{Al}-\text{OH}$  represents structural Al in the octahedral layers of clays.

As can be noticed from the reaction above, as a result of the displacement process, free  $\text{OH}^-$  ions are released in the soil solution. The increase in  $\text{OH}^-$  ion concentration may cause an increase in soil pH, a phenomenon called *exchange alkalinity*. The exchange alkalinity is believed to increase with the replacement or displacement power of the anions (Wiklander, 1964).

Such an adsorption reaction is prevalent in acid soils. It results in a strong bond between the phosphate ion and the octahedral Al. Frequently, only part of this structurally bonded phosphate can be recovered by desorption analysis. However, the capability of other anions, such as fluoride, oxalate, citrate, and tartrate, in displacing the structurally sorbed phosphate ion cannot be considered as a true ion exchange according to the concept of cation exchange reactions. This displacement capability is attributed to formation of complexes, because fluoride and the organic acid anions have apparently a stronger affinity for Al and Fe than the phosphate ion. Humic acids



have also been reported currently for their capacity in releasing phosphate ions by complexing or chelating Al, Fe, or Ca from Al- and Fe-phosphate minerals and apatite, respectively (Lobartini et al., 1994, 1997).

In view of the above, it is deemed of importance in the concept of anion exchange reactions and AEC to make a distinction between the true anion exchange, as discussed above for pure electrostatic attraction of anions, and displacement reactions of structurally bonded anions.

Other anions, such as  $F^-$  ions, can also displace structural OH isomorphously from silicate clays and hydrous oxide minerals. Because this type of bonding can also take place above the isoelectric point or ZPC, it contributes to the cation exchange capacity, because it increases the negative charge of the colloid surface. The CEC of the clay mineral is reported to increase according to the valence of the sorbed phosphate ion in the direction of  $H_2PO_4^-$ ,  $HPO_4^{2-}$ , to  $PO_4^{3-}$  (Wiklander, 1964).

Phosphate can also be retained in soils by precipitation reaction, forming insoluble compounds with Fe and Al at low pH, and with Ca at high pH values.

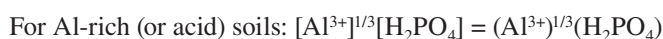
### 9.3 PHOSPHATE RETENTION AND FIXATION

Phosphate anions can be attracted to soil constituents with such a bond that they become insoluble and difficult to obtain by plants. This process is called *phosphate retention* and *phosphate fixation*, which can occur biologically or chemically. Some call it *chemical fixation of phosphate* (NIIR, 2004). Many authors use the terms *retention* and *fixation* interchangeably. However, Tisdale and Nelson (1975) are of the opinion that *retention* refers to that part of adsorbed phosphate that can be extracted with dilute acids. This fraction is relatively available to plants. The term *fixed*, on the other hand, is reserved for the portion of soil phosphate that is not extractable by dilute acids. This portion of phosphate is not readily available to plants. In this respect, reports have been surfacing lately that the soils contain a large number of *P-solubilizing microorganisms*. Many of them are reported to be located in the soil rhizosphere. *Pisolithus tinctorius* was cited by Tan (2009), whereas others, such as actinomycetes, cyanobacteria, and root nodule bacteria (e.g., Bradyrhizobium) have been recognized as efficient P-solubilizers, too (NIIR, 2004). Under certain conditions, the distinction between phosphate retention and fixation is rather obscure. However, most authors agree that retention involves adsorption due to electrostatic attraction or a process called *bridging* or *coadsorption*. On the other hand, fixation is caused more by the linkage of phosphate through replacement or displacement of structural OH groups. This type of mechanism is more significant in the 1:1 type of clays than in the 2:1 type of minerals, due to the higher content of exposed Al–OH groups in the 1:1 type of clays.

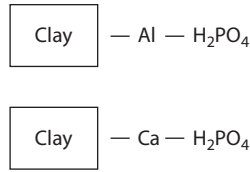
#### 9.3.1 PHOSPHATE RETENTION

Phosphate retention can occur in acid and basic condition. Acid soils usually contain significant amounts of soluble and exchangeable  $Al^{3+}$ ,  $Fe^{3+}$ , and  $Mn^{2+}$  ions. Phosphate, when present, may be adsorbed on the colloid surface with these metal ions serving as bridges. This adsorption phenomenon is called *metal bridging* or *coadsorption*. The phosphate retained in this way is still available to plants. Such an adsorption reaction can also take place with Ca-saturated clays. Evidence has been shown that Ca-clay adsorbs large amounts of phosphate. The  $Ca^{2+}$  ions form the linkage between the clay and the phosphate ion (Figure 9.2).

According to the mass action or Gapon equation, the ionic concentration at the surface of the clay is dependent on that of the bulk solution. This relationship can be written for phosphate retention as follows:





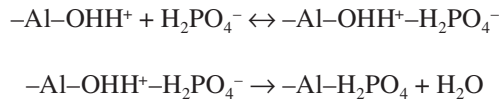


**FIGURE 9.2** Aluminum and calcium bridging in phosphate retention.

$$\text{For Ca-rich (or basic) soils: } [\text{Ca}^{2+}]^{1/2}[\text{H}_2\text{PO}_4] = (\text{Ca}^{2+})^{1/2}(\text{H}_2\text{PO}_4)$$

in which [ ] denotes adsorbed species, and ( ) again equals free species.

Retention of phosphate can also occur by clay minerals possessing oxihydroxy, aluminol, ferrol, and silanol surfaces, where protonation of exposed OH groups can develop positive charges (Hingston et al., 1968). The reaction is envisioned to proceed in two steps as follows:



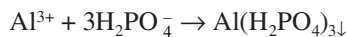
As can be noticed from these reactions, the initial step is an electrostatic adsorption of phosphate ions by protonated exposed OH groups, which is nonspecific adsorption of phosphate. However, with the passage of time, this is followed by penetration of the phosphate into the crystal structure, as illustrated by the second reaction. The proposed two-step reaction above is in agreement with that suggested by other authors. Bohn et al. (1979, 2001) assume that the initial stage is a rapid reaction involving a combination of nonspecific adsorption and ligand exchange, whereas the second stage is a very slow reaction that may continue for several weeks or even longer. The second reaction shown above, illustrating phosphate retention, is adapted from the reaction reported by Hingston et al. (1968), who hypothesize that the displaced structural OH reacts with the proton to form water, whereas ionization of the adsorbed phosphate ion may create a negative charge. As indicated previously, the negative charge of the clay mineral is believed to increase according to the valence of the sorbed phosphate ion in the direction of  $\text{H}_2\text{PO}_4^-$ ,  $\text{HPO}_4^{2-}$ , to  $\text{PO}_4^{3-}$  (Wiklander, 1964).

### 9.3.2 PHOSPHATE FIXATION IN ACID SOILS

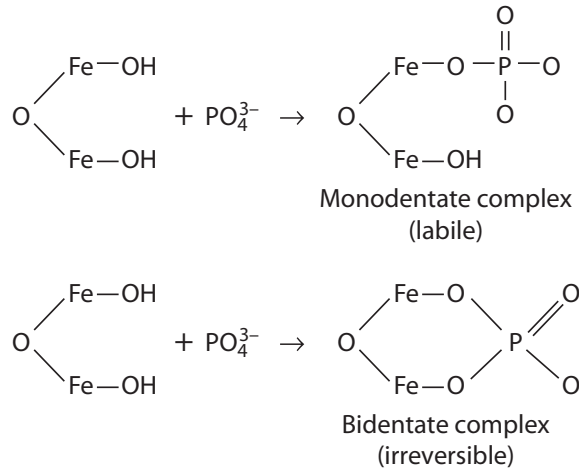
Fixation renders phosphate insoluble in water and relatively nonavailable to plants. The fixation reaction can occur between phosphate and Fe or Al ions and Fe or Al hydrous oxides or between phosphate and silicate minerals.

Many acid soils contain high amounts of free Fe and Al, and Fe and Al hydrous oxide clays, especially the highly weathered Ultisols in the United States and the Oxisols in the tropics. The free Fe and Al and sesquioxide clays react rapidly with phosphate, forming a series of difficultly soluble hydroxyphosphates.

The reaction between the free metal ions and phosphate ions can be illustrated as follows:



The product formed is difficultly soluble in water and precipitates from solution. With the passage of time, the Al-phosphate precipitate becomes less soluble and less available to plant growth. The lower the soil pH, the greater the concentration of soluble (free) Al, Fe, and Mn; consequently, the larger is the amount of phosphate fixed in this way.



**FIGURE 9.3** Fixation of phosphates as monodentate and bidentate Fe complexes.

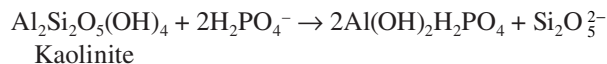
Fixation of phosphate by Fe or Al hydrous oxide clays takes place on the ferrol and aluminol surfaces by complex formation or chelation reaction. In this case, the surface hydroxyl groups are not displaced but contribute to formation of complexes or chelates as illustrated by the two reactions presented in Figure 9.3.

The bidentate complexes are by definition *chelates*. Phosphate fixed in the form of a bidentate complex is held more strongly than that fixed as a monodentate complex.

The amount of phosphate fixed by the reactions above usually exceeds that fixed by phosphate retention. Such a reaction is not limited to Al and Fe hydrous oxide clays, but Mn hydrous oxide clays and amorphous clays also have similar phosphate-fixing capacities. In contrast to phosphate retention that occurs mainly in acid soils, phosphate fixation by hydrous oxide clays can occur over a relatively wider pH range.

The products formed by both retention and fixation reactions are frequently not pure Al or pure Fe phosphates. The ultimate end product of the reaction between Al hydroxides and phosphates is called *variscite* (AlPO<sub>4</sub>·2H<sub>2</sub>O), and that of Fe hydroxides and phosphates is known as *strengite* (FePO<sub>4</sub>·2H<sub>2</sub>O). A series of intergrades between variscite and strengite is usually present in soils and is called the *variscite-strengite isomorphous series* (Lindsay et al., 1959).

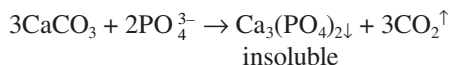
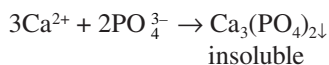
Another type of phosphate fixation is the reaction between phosphates and silicate clays. Silicate clays exhibiting exposed Al-OH groups, such as the kaolinitic groups, especially have a strong affinity for phosphate ions. The phosphate ions react rapidly with octahedral Al. Bohn et al. (1979), quoting Low and Black, indicate that the reaction is envisioned to take place as follows:



The release of silica shows a decomposition or dissolution of kaolinite as a result of phosphate fixation. This type of phosphate fixation is also prevalent in acid conditions. Generally, clays with low SiO<sub>2</sub>/R<sub>2</sub>O<sub>3</sub> (silica/sesquioxide) ratios have a higher phosphate-fixing capacity than clays with high SiO<sub>2</sub>/R<sub>2</sub>O<sub>3</sub> ratios. Therefore, smectite minerals are expected to be lower in phosphate-fixing capacity than kaolinite, because of their higher SiO<sub>2</sub>/R<sub>2</sub>O<sub>3</sub> ratios—in other words, because of their higher silica and lower Al and Fe contents. The intimate connection of Al and Fe with phosphate fixation is emphasized by the especially low phosphate-fixing capacity of hectorite, a mineral in the smectite group with mainly Mg rather than Al in octahedral position.

### 9.3.3 PHOSPHATE FIXATION IN ALKALINE SOILS

Fixation of phosphate is not limited to acidic conditions, but can also occur readily in alkaline soil reactions. Many alkaline soils contain high amounts of soluble and exchangeable  $\text{Ca}^{2+}$  ions, and frequently also calcium carbonate,  $\text{CaCO}_3$ . Phosphate is reported to react with both the ionic and the carbonate form of Ca. The reactions can be illustrated as follows:



The tricalciumphosphate formed is insoluble and precipitates out of the solution. Other forms of insoluble Ca phosphate can also be formed by this type of reaction between calcium and phosphate (e.g., Ca-fluorapatite  $[\text{Ca}_5(\text{PO}_4)_3\text{F}]$ , Ca-chlorapatite  $[\text{Ca}_5(\text{PO}_4)_3\text{Cl}]$ , and Ca-hydroxylapatite  $[\text{Ca}_5(\text{PO}_4)_3(\text{OH})]$ ). Of the three types of apatite minerals, Ca-fluorapatite is reported the most common mineral, whereas the other two are rare (Hurlbut and Klein, 1977). A complete isomorphous series of minerals is present between these three apatite minerals, because F, Cl, and OH can substitute for each other.  $\text{CO}_3$  and OH groups can also substitute for  $\text{PO}_4$ , giving the carbonate–apatite series with  $\text{CaCO}_3$  and Ca-hydroxylapatite making up the end members. Partial substitution of the  $\text{PO}_4$  group by  $\text{SO}_4$  or  $\text{SiO}_4$  groups is also possible.

Fixation of phosphates by calcium or calcium carbonate as discussed above is a serious problem in arid region soils of the western part of the United States. However, it can also become significant in the humid region soils of the eastern seaboard of the United States when the soils receive continuously high applications of lime. In these soils or under such conditions, application of P fertilizers generally gives low plant response, because of inactivation of the phosphate by the fixation process with Ca.

Phosphate fixation cannot be avoided entirely, but it can be reduced by the addition of competing ions for fixing sites. Organic anions from stable manure and silicates are reported to be very useful in reducing P fixation (Bolt, 1976). Currently, humic acids have been noticed to play an important role in preventing or decreasing P fixation by chelating the ions responsible for the reaction (Lobartini et al., 1994, 1997).

## 9.4 BIOLOGICAL FIXATION OF PHOSPHATE

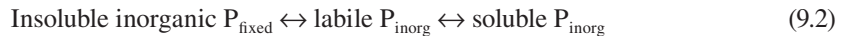
In the previous discussion, phosphate fixation is assessed as chemical reactions between phosphates and inorganic ions and clay minerals. However, *biological fixation* of phosphates has also been realized currently to occur as an important process in soils (NIIR, 2004). Though less is known about the latter, some advances have been achieved with the increased knowledge in the bio- and geochemistry of soil organic matter. Biological fixation of phosphates takes place as (1) immobilization of available phosphates by microorganisms into their cellular materials, and (2) interaction or chelation of phosphates by organic substances secreted by roots or by the decomposition products of soil organic matter, such as humic matter.

Although biologically fixed phosphate is considered biologically stable, it is less insoluble than the Al- and Fe-phosphate compounds. The phosphate fixed biologically can be released more easily than the inorganically fixed phosphate, because organic matter is always subject to decomposition and mineralization processes. Many of the organic phosphates also exist in soluble forms.

Most scientists agree that organic phosphates play a vital role in replenishing inorganic P in the soil solution, and the following equilibrium has been proposed between organic and inorganic P (Stevenson, 1986):

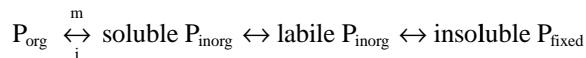


Mineralization of  $P_{\text{org}}$  (m, reaction to the right) will increase the soluble  $P_{\text{inorg}}$  concentration in the soil solution, whereas plant uptake of  $P_{\text{inorg}}$ , or biological immobilization of  $P_{\text{inorg}}$  (i, reaction to the left) causes a decrease in soluble  $P_{\text{inorg}}$  concentration in the soil solution. However, such an equilibrium reaction, controlling the concentration of soluble  $P_{\text{inorg}}$  in the soil solution, also occurs with insoluble phosphate compounds produced by inorganic phosphate fixation, as illustrated below:



Equation 9.2 indicates that if soluble  $P_{\text{inorg}}$  decreases in concentration, more will be produced to maintain the equilibrium by dissolving more of the labile and of the insoluble  $P_{\text{fixed}}$  (reactions to the right). When, on the other hand, the  $P_{\text{inorg}}$  content increases, P fixation is assumed to increase (reaction is going to the left). Equation 9.2 is expected to occur simultaneously with and complementary to Equation 9.1. If soluble  $P_{\text{inorg}}$  increases by mineralization of  $P_{\text{org}}$  according to Equation 9.1, then this is expected to result in more fixation of P according to Equation 9.2. When  $P_{\text{inorg}}$  content decreases by plant uptake, more labile and hence more insoluble  $P_{\text{fixed}}$  will be dissolved in order to maintain the equilibrium condition. Consequently, immobilization of P decreases P retention and fixation.

Equilibrium Equations 9.1 and 9.2 should not be combined as proposed by Stevenson (1986):



where m is mineralization, and i is immobilization.

Such a combined equation tends to give the wrong impression, though it indicates properly that increased mineralization, by virtue of increasing the soluble  $P_{\text{inorg}}$  content, increases phosphate fixation (reactions to the right). However, when the reactions going to the left are considered, the sequence in reactions says that an increase in P fixation causes an increase in retention (labile  $P_{\text{inorg}}$ ), followed by an increase in soluble  $P_{\text{inorg}}$  content, which in turn increases immobilization. The increase in soluble  $P_{\text{inorg}}$  content as a result of an increase in P fixation is an error in the link of reactions, and confuses the problem, and so does the increased immobilization.

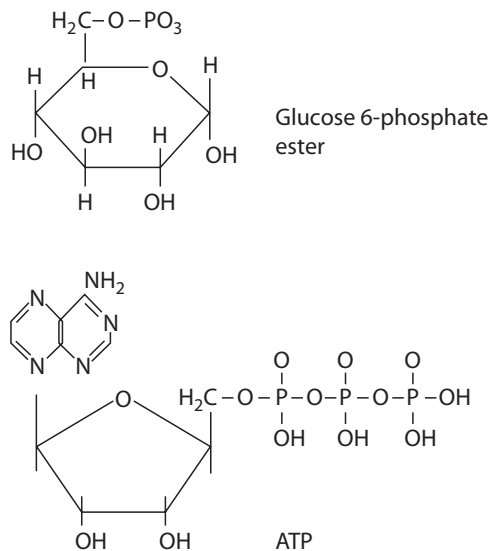
Because the vital link is the soluble  $P_{\text{inorg}}$  content, the argument can also be directed toward the fact that both increased immobilization and increased P fixation decrease the soluble  $P_{\text{inorg}}$  content of the soil solution. The question is then whether it is proper to conclude from the equilibrium sequence above that increased immobilization results in an increased fixation of phosphate, or vice versa.

The organic phosphate content seems to be closely related to organic carbon content in soils. A positive correlation has been reported, indicating that organic P will increase proportionally with an increase in organic carbon content in soils (Uriyo and Kesseba, 1975). A rapid accumulation of organic P is noted to occur also during the first years of soil development, and as soon as the soil reaches a state of equilibrium, the rate of accumulation tapers off to a steady state. This regression and leveling off in  $P_{\text{org}}$  content is in agreement with accumulation of organic matter in soils reaching a maximum content after soil development reaches an equilibrium with the environmental conditions (Beaty et al., 1976; Tan et al., 1975b). Values for total organic P content reported vary widely from soil to soil and from country to country. A summary presented by Stevenson (1986) from a literature study shows a range from 4  $\mu\text{g P/g}$  of soil to 1360  $\mu\text{g P/g}$  of soil, which corresponds to 3% to 77% of the total P content in soils.

### 9.4.1 IMMOBILIZATION OF PHOSPHATES

Very little is known yet of the nature and chemistry of the immobilization process of phosphates by plants and microorganisms. The phosphate taken up by plants is presumably esterified with OH groups of carbohydrates and other organic compounds derived from photosynthates. In cellular metabolism, simple carbohydrates are converted first into phosphate esters, which undergo a series of stepwise interactions with phosphopyruvic acid making up the end products of the immobilization process. Mills and Jones (1996) suggest that immobilization of phosphorus occurs either with the assistance of a *cotransport* or an *antiport system*. They believe that ATPases in the cotransport system are forcing  $H^+$  into the apoplast to protonate a phosphate carrier, enabling it to cross the plasmalemma. The pH in the apoplast controls the uptake of P. In the antiport system, Mills and Jones (1996) indicate that  $HCO_3^-$  is released while  $H_2PO_4^-$  is taken up. For each  $H_2PO_4^-$  ion absorbed, the equivalent of one  $OH^-$  ion is released into the soil. This tends to increase the pH of the soil rhizosphere. Within minutes after uptake, most of the inorganic phosphate ions are converted into organic phosphate compounds, notably into hexose-phosphates and uridine diphosphates, which are rapidly metabolized. Major plant organelles and substances containing P are nucleic acids, phospholipids, phytin, nicotinamide adenine-dinucleotide (NAD), nicotinamide dinucleotide phosphate (NADP), and adenosine triphosphate (ATP). Examples of biologically fixed phosphates are shown in Figure 9.4. Energy adsorbed during photosynthesis is believed to be used for the biological fixation of P in esterification and formation of pyrophosphate bonds in ATP. ATP is a coenzyme required in all biosynthetic and catabolic reactions in plant cells. It is a derivative of adenosine monophosphate formed by the addition of two phosphates by pyrophosphate bonding. The pyrophosphate linkage in ATP is energy rich, and by donating these phosphate groups to other photosynthetic derivatives, the latter are converted into active metabolites. The bond energy in ATP is used, for example, in the synthesis of protein, fat, lignin, and polysaccharides.

Not much is known on the nature of these organic P compounds after plant decay. Some of these biologically fixed phosphates may be released into the soil as phosphate esters during rupture of plant and microbial cells, whereas others may be converted into soluble inorganic P by the presence of phosphatase enzymes. A large part may be colloidal in nature and consist of cellular debris. According to Stevenson (1986), the major forms detected in soils, in decreasing order of abundance,



**FIGURE 9.4** Biological fixation of  $PO_3^{3-}$  through (1) esterification with glucose and (2) pyrophosphate bonding in ATP.

are inositolphosphates (10% to 50%), nucleic acids (1% to 5%), phospholipids (0.2% to 2.5%), phosphoproteins (trace), and metabolic phosphates (trace). The inherent instability of the high-energy pyrophosphate bonds prevents ATP from accumulating in soils, though ATP is considered an ideal substance for the determination of biomass in soils, sediments, or aquatic systems (Paul and Clark, 1989; Stevenson, 1986). ATP cannot remain in soil for an extended period of time, because of its high sensitivity to environmental and phosphatase attack.

#### 9.4.2 THE INTERACTION OF PHOSPHATES WITH HUMIC ACIDS AND OTHER ORGANIC ACIDS

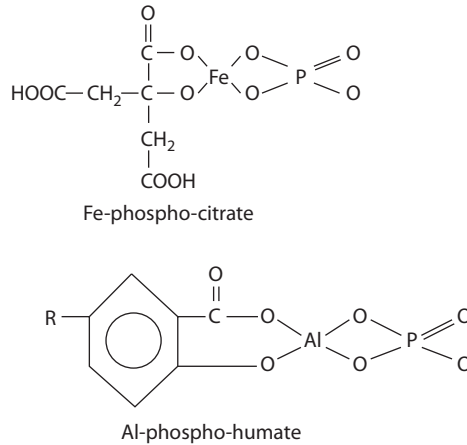
The interaction of phosphates and soil organic acids is a type of P-fixation process that can form both soluble and insoluble phosphohumate complexes or chelates. A complex is formed when water molecules, surrounding the ion in the hydration sphere, are replaced by other ions or molecules with the formation of a coordination compound. The substance that reacts with the ion is called the *ligand*. A chelate is formed when two or more coordinate positions around the metal are occupied by donor groups of a ligand to form a ring structure, a topic that will be discussed in more detail in Chapter 12.

Root secretions and excretions contain a great variety of simple to complex organic acids, many of which are capable of forming complexes (e.g., citric acid, oxalic acid, tartaric acids, and carboxylic acids). The soil rhizosphere has been reported to be an important habitat for acid-producing microorganisms. Fungi, bacteria, actinomycetes, and lichens are currently noted capable of producing special types of organic acids functioning as efficient chelators of cations and anions. Other chelating agents occurring naturally in soils are phytic acid, chlorophyll, simple sugars, auxins, and humic and fulvic acids.

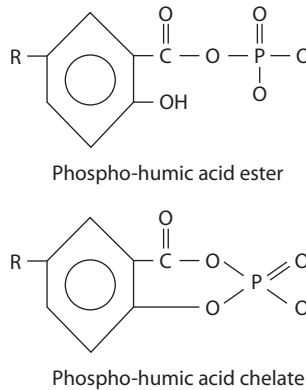
However, most of the research attention on these organic acids is focused on chelating metal ions for solubilizing micronutrient elements from rock and minerals. Only some of the studies have been directed toward obtaining more information on the interaction of the organic acids and anions, especially phosphate ions. The early research on interactions between humic acids and phosphate ions indicates that humic matter was unable to complex phosphates because of the anionic nature of both substances (Levesque and Schnitzer, 1967; Sinha, 1971, 1972). Formation of phosphohumate complexes is believed to be possible only in the presence of metal ions serving as bridges between the humic molecules and the phosphate ions. Such an interaction, called *bridging* or *coadsorption*, was reported earlier by Weir and Soper (1963). Retention of phosphate by metal–humic acid complexes appears to be pH dependent, because the amount of P held by the metal–humate complexes increases at low soil pH and decreases at high soil pH. Depending upon saturation of the metal–humate ligand with phosphate ions, the phospho-metal–humate formed can become insoluble or remain in solution as a soluble complex. A substantial amount of the total soluble P in soils is reported to occur in organic form (Stevenson, 1986). The reaction for formation of phospho-metal–humates is illustrated in Figure 9.5. As shown in Figure 9.5, organophosphate complexes can also be formed by other soil organic acids, such as citric acids. Citric acid is reported to be an effective chelator of metals, and in the form of a metal citrate, it can form a complex with phosphate ions as shown above.

Lately evidence has been provided that humic acid can react directly with phosphate ions without the process of metal bridging or coadsorption. Phosphate esters of humic acids and phosphohumic acid chelates have been detected by  $^{31}\text{P}$ -NMR analysis (Lobartini et al., 1994, 1997; Newman and Tate, 1980; Ogner, 1983). Because phosphates will react rapidly with exposed OH groups of clay minerals, as discussed previously (see Section 9.3.2), it is more than conceivable to expect the phosphate to also react directly with hydroxyls (OH) present in the functional groups of humic matter. The esterification and chelation reactions are illustrated in Figure 9.6.

The stability of the phospho-organic acid complexes is dependent on a number of factors. In addition to pH and saturation of the ligand, as indicated previously, it is also dependent on the number of rings formed.



**FIGURE 9.5** Complex reaction between a phosphate ion and organic acids. Top: Metal bridging between phosphate and citric acid. Bottom: Metal bridging between phosphate and humic acid.



**FIGURE 9.6** Formation of phospho-humic acid esters and phospho-humic acid chelates.

## 9.5 SOIL REACTION AND AVAILABILITY OF INORGANIC PHOSPHATES

As discussed, in acid soils, phosphate is precipitated as highly insoluble Fe- and Al-phosphates or adsorbed to the oxyhydroxy surfaces of minerals. This is particularly true for Oxisols and Ultisols of tropical and subtropical regions. Adsorption of phosphate by silicate clays and hydrous oxide surfaces appears to be either a form of coadsorption or a replacement of structural OH or H<sub>2</sub>O, which is considered a ligand-binding mechanism. Phosphate fixation by these minerals is believed to decrease in the sequence:

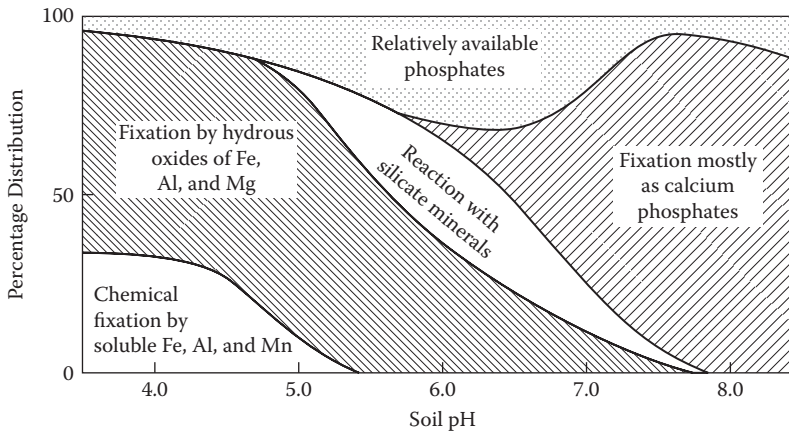


Variations as to the availability of such phosphates to plants are attributed to formation of monodentates or bidentates. Phosphate fixed by a single coordinated linkage (monodentate) is more labile than phosphate bonded through a chelate ring (bidentate).

In the calcareous soils of arid and semiarid regions, phosphate is precipitated by Ca into the nonsoluble dicalciumphosphate, Ca<sub>2</sub>(HPO<sub>4</sub>)<sub>2</sub>, and tricalciumphosphate, Ca<sub>3</sub>(PO<sub>4</sub>)<sub>2</sub>.

Therefore, insoluble Al and Fe hydroxyphosphates are stable in acid conditions, whereas Ca phosphates are stable in alkaline conditions. At pH 3 to 4, solubility of the Al- and Fe-hydroxyphosphates

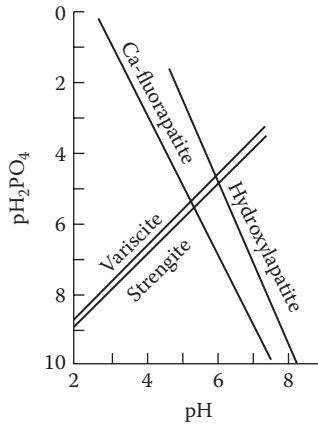




**FIGURE 9.7** Phosphate availability and fixation as related to soil pH. (From Brady, N. C., *The Nature and Properties of Soils*, 8th ed., MacMillan, New York, 1974. Reprinted and electronically reproduced by permission of Pearson Education, Inc., Upper Saddle River, NJ.)

is considered very low. However, with increasing pH levels, solubility of these phosphate compounds increases and reaches a maximum at approximately pH 6.5. Above this pH level, the Al- and Fe-hydroxyphosphate compounds decrease again in solubility (Figure 9.7). On the extreme alkaline range (pH 8), Ca-phosphate is in an insoluble form. By decreasing the pH, this compound also becomes slightly soluble, and maximum solubility is reached at pH 6.5. Therefore, it appears that at pH 6.5, the soil may contain the maximum amounts of phosphate ions that can be solubilized from all the insoluble inorganic phosphate forms present in soils. For most soils, maximum amounts of available P would be expected in the slightly acid to neutral range of soil reaction. The forms of phosphate ions present also depend on soil pH. It is known that in acid conditions the  $\text{H}_2\text{PO}_4^-$  ions prevail, whereas in alkaline conditions the  $\text{HPO}_4^{2-}$  ions are dominant. At pH 6.5, all the types of phosphate ions ( $\text{H}_2\text{PO}_4^-$ ,  $\text{HPO}_4^{2-}$ , and  $\text{PO}_4^{3-}$ ) can exist together in the soil solution.

A stability diagram was presented by Lindsay and Moreno (1960) for a soil system containing variscite, strengite, fluorapatite, hydroxylapatite, octacalcium phosphate,  $\text{Ca}_4\text{H}(\text{PO}_4)_3$ , and dicalcium phosphate,  $\text{CaHPO}_4 \cdot 2\text{H}_2\text{O}$ , to outline the relative stability regions of the compounds on the basis of pH and the phosphate potential,  $\text{pH}_2\text{PO}_4 = -\log(\text{H}_2\text{PO}_4^-)$ , where  $(\text{H}_2\text{PO}_4^-)$  is the concentration of  $\text{H}_2\text{PO}_4^-$  in mol/L. Therefore, the phosphate potential is just another way to express phosphate concentrations in soils. A revised version of this diagram is shown in Figure 9.8 for the purpose of demonstrating the effect of pH and phosphate concentration in the soil solution on the dissolution of the respective compounds. Dicalcium phosphate and octacalcium phosphate are rare minerals in soils and have been left out of the diagram. The curves (lines), also called isotherms, represent conditions at which the respective minerals can exist in equilibrium with their constituent components in solution (e.g., at the variscite isotherm, variscite exists in equilibrium with  $\text{Al}^{3+}$  and  $\text{H}_2\text{PO}_4^-$  ions released by variscite). The region above the isotherm represents conditions at which *supersaturation* occurs with respect to  $\text{H}_2\text{PO}_4^-$  ions, causing precipitation of the compound. It can be noticed from the diagram that this region is characterized by decreasing values of  $\text{pH}_2\text{PO}_4$ , or in plain language by increasing concentration of  $\text{H}_2\text{PO}_4^-$  ions producing the oversaturation. On the other hand, the region below the respective isotherm represents conditions of *undersaturation* with respect to phosphate ions. The value for the phosphate potential increases, which means that the phosphate concentration decreases. This undersaturation causes the mineral, when present in this region, to release more phosphate to establish an equilibrium condition. The mineral dissolves until an equilibrium state is attained.



**FIGURE 9.8** Stability diagram for variscite, strengite, and apatite minerals. (Adapted from Lindsay, W. L., and E. C. Moreno, *Soil Sci. Soc. Am. Proc.*, 24, 177–182, 1960.)

In view of the discussion above, Lindsay and Moreno’s diagram then indicates that variscite and strengite will dissolve at any soil pH (pH 2 to 9) as long as pH<sub>2</sub>PO<sub>4</sub> is <9. However, the apatite minerals will dissolve only at pH <7, regardless of the pH<sub>2</sub>PO<sub>4</sub> value.

**9.6 PREDICTION OF PHOSPHATE ION CONCENTRATION ACCORDING TO SCHOFIELD’S RATIO LAW**

From the discussion above, it is apparent that the concentration of phosphate ions in the soil solution depends upon several factors. It is usually affected by soil pH, by some member of the variscite–strengite isomorphous series, and by a member of the Ca–hydroxyphosphate, or apatite, series. According to Schofield’s ratio law, the following relations are valid:

$$(H^+) = K_w / (OH^-) \tag{9.3}$$

$$[\sqrt{Ca^{2+}}] / [H^+] = (\sqrt{Ca^{2+}}) / (H^+) = k_1 \tag{9.4}$$

$$(Al^{3+})^{1/3} / (Ca^{2+})^{1/2} = k_2 \tag{9.5}$$

where [ ] denotes again adsorbed species, and ( ) refers to free ions in solution.

Lindsay et al. (1959) assume that if variscite, Al(OH)<sub>2</sub>H<sub>2</sub>PO<sub>4</sub>, will dissociate completely into its component ions, we can write the solubility product (K<sub>sp</sub>) of variscite as follows:

$$K_{sp} = (Al^{3+})(OH^-)^2 (H_2PO_4^-)$$

By using Equations 9.3, 9.4, and 9.5 for substitution into the equation for K<sub>sp</sub>, Lindsay et al. (1959) stated that:

$$(\sqrt{Ca^{2+}})(H_2PO_4^-) = \text{constant}$$

$$(H^+)(H_2PO_4^-) = \text{constant}$$

$$(Al^{3+})^{1/3}(H_2PO_4^-) = \text{constant}$$

## 9.7 THE PHOSPHATE POTENTIAL

Three types of phosphate potentials can be distinguished: chemical potential of phosphate, electrochemical potential of phosphate, and Schofield's phosphate potential.

### 9.7.1 THE CHEMICAL POTENTIAL OF PHOSPHATE

As discussed earlier, each chemical species carries a certain amount of energy. The unit amount of free energy per unit amount of chemical species was defined earlier as the *chemical potential*. If this concept is applied with a phosphate ion,  $\text{H}_2\text{PO}_4^-$ , the chemical potential of this phosphate ion can be formulated as:

$$\mu = \mu^\circ + RT \ln a \quad (9.6)$$

where  $\mu$  is the chemical potential of  $\text{H}_2\text{PO}_4^-$ ,  $\mu^\circ$  is the standard chemical potential of  $\text{H}_2\text{PO}_4^-$ ,  $R$  is the gas constant,  $T$  is the absolute temperature in degrees Kelvin, and  $a$  is the activity of  $\text{H}_2\text{PO}_4^-$ .

Conversion in log form gives:

$$\mu = \mu^\circ + 1.364 \log a$$

According to this concept, movement of phosphate ions from one to another location in soils is always in the direction of lower chemical potentials. Therefore, phosphate ions are taken up by plant roots if the chemical potential of phosphate ions in soils is larger than the chemical potential of phosphate ions in plants:

$$\mu_{\text{P(plants)}} < \mu_{\text{P(soil)}}$$

### 9.7.2 THE ELECTROCHEMICAL POTENTIAL OF PHOSPHATE

By definition, the *electrochemical potential of phosphate* is the sum of the chemical potential and electrical potential of phosphate, which can be formulated as follows:

$$\Phi = \mu + zF\Psi \quad (9.7)$$

in which  $\Phi$  is the electrochemical potential of a phosphate ion,  $\mu$  is the chemical potential of the phosphate ion,  $z$  is the valence,  $F$  is the Faraday constant, and  $\Psi$  is the electrical potential.

When phosphate uptake by plant roots reaches equilibrium, movement of phosphate ions will stop. At equilibrium, the system obeys the *Donnan equilibrium law*. The electrochemical potential of phosphate ions within the plant cells ( $\Phi_i$ ) must then equal the electrochemical potential of phosphate ions in the soil solution ( $\Phi_o$ ):

$$\Phi_i = \Phi_o$$

$$\mu_i + (zF\Psi)_i = \mu_o + (zF\Psi)_o$$

$$(RT \ln a)_i + (zF\Psi)_i = (RT \ln a)_o + (zF\Psi)_o$$

$$(zF\Psi)_o - (zF\Psi)_i = (RT \ln a)_i - (RT \ln a)_o$$

$$\Psi_o - \Psi_i = (RT)/(zF) \ln [(a_i)/(a_o)]$$

$(\Psi_o - \Psi_i) = E$  was previously called the *membrane* or *Donnan potential*, where  $a_i$  is the phosphate ion activity inside the plant cells, and  $a_o$  is the phosphate ion activity in the soil solution (outside plant cells).

Changing from the natural to the common logarithm ( $\ln = 2.303 \log$ ) and substituting  $R$  and  $F$  for the gas and Faraday constant, respectively, the Donnan potential assumes at  $T = 298 \text{ K}$  ( $25^\circ\text{C}$ ) the following formula:

$$E = \Psi_o - \Psi_i = (0.059/z) \log (a_i/a_o) \quad (9.8)$$

### 9.7.3 SCHOFIELD'S PHOSPHATE POTENTIAL

The term *phosphate potential* is introduced by Schofield (1955) to be used as an index for availability of soil phosphorus. Similarly, as with the definition of soil water potential, the phosphate potential is defined as the amount of work that must be conducted to move reversibly and isothermally an infinitesimally small amount of a phosphate ion from a pool of phosphates at a specified location at atmospheric pressure to the point under consideration. Schofield (1955) was of the opinion that a labile pool of phosphates existed in the soil from which the plant roots could draw their P needs.

By measuring the pH and the total P concentration in  $0.01 \text{ M}$   $\text{CaCl}_2$  solution, the solubility product of phosphate ions can be expressed as:

$$K_{sp} = (\text{Ca}^{2+})^{1/2}(\text{H}_2\text{PO}_4)$$

By taking  $-\log$ , this product changes into:

$$-\log K_{sp} = -1/2 \log(\text{Ca}^{2+}) + -\log(\text{H}_2\text{PO}_4)$$

or

$$pK_{sp} = 1/2 p\text{Ca} + p\text{H}_2\text{PO}_4 \quad (9.9)$$

in which  $p = -\log$ .

Equation 9.9 is called the *phosphate potential*. It is, in fact, a solubility product, and Chesworth (2008) indicates that the use of the term *potential* is incorrect. However, the name *phosphate potential* has been used for years; hence, the name is expected to be retained irrespective of being allegedly far related to the concept of electrochemical potentials. It is expected to be useful in estimating the solubility of phosphates in soil solutions. Because availability of phosphate to plants is related to the solubility of phosphates, the phosphate potential can be used to make indirect predictions as to the phosphate availability to plants. But, because of several technical difficulties, the use of phosphate potentials as an index of availability of phosphate has not been tested adequately. Nonetheless, in analogy to the water potential, a low phosphate potential suggests high availability, whereas a high phosphate potential refers to lower availability of P to plants.



---

# 10 Soil Reaction

## 10.1 DEFINITION AND IMPORTANCE

The *soil reaction* is a term used to indicate the acid–base reactions in soils (Brady, 1974, 1990; Logsdon et al., 2008; Tisdale and Nelson, 1975). Although the extent of the soil's acid–base reaction is commonly expressed in terms of soil pH, the use of the terms acidic pH (Chorover, 2006), neutral pH, and basic pH is incorrect. Soil pH values are plain numbers from 0 to 14, which are derived from the hydrogen ion activity in  $-\log$  form. Therefore, the term *soil reaction* can be used to simplify and avoid this problem. Accordingly, it is more appropriate to use the terms *soils with acid, neutral, or basic reaction* or, if desired, *soils with low pH or soils with high pH*.

Brady and Weil (1996, 2008) consider the soil reaction a master variable that affects most of the soil properties. They believe that pH will not only affect the chemical and biological properties of soils, but will also affect the physical properties, including air and water movement in soils. The latter is subject to arguments, because many questions will arise on the issue of pH dependency of air and water movement in soils. It is very difficult to provide a direct scientific basis for differences in the flow of water and air in soils at low and high pH. Nevertheless, the soil reaction can be considered a *master determinant*, instead of a master variable, in controlling plant growth and crop production. The effect of the acid–base reactions in soils is manifested directly or indirectly on the growth of plants. Directly,  $H^+$  ions are reported to have a toxic effect on plants when present in high concentrations. Indirectly, the soil reaction may influence plant growth through its effect on solubility and availability of plant nutrients. The changing phosphate concentration with soil pH, as discussed in the preceding chapter, is one example. Another good example is the concentration of micronutrients reaching toxic or adequate levels with changing soil pH. Many soil chemical and biological reactions can occur only at specific soil reactions. The rate of decomposition of soil minerals and organic matter is influenced by the soil reaction. Weathering of primary minerals is promoted by low soil pH, because sufficient amounts of protons are required for hydrolysis to occur. The  $H^+$  ions are consumed by the hydrolysis reaction, and  $OH^-$  ions are produced, making the soil solution become more basic (Birkeland, 1974; Wild, 1993). Formation of clay minerals depends on specific soil reactions. The solubility of alumina and silica is markedly affected by pH. At pH less than 4, alumina is considered to become more soluble than silica. On the other hand, between pH 5 and 9, alumina is practically insoluble, whereas silica becomes increasingly soluble. Such a condition may lead to differential leaching of silica, and the consequent formation of kaolinite, gibbsite, and bauxite (Ollier, 1975). On the other hand, smectite is more likely to be formed in a soil reaction favoring the presence of adequate amounts of silica.

Another chemical property influenced by soil pH is the exchange reaction, especially in soils with variable charges (Theng, 1980). However, exchange reactions are not the reason for soil acidity, but, depending on pH, are accumulating more  $H^+$  ions through exchange processes.

The transformation of  $NH_4^+$  into  $NO_3^-$ , called nitrification, is considered the most pH-sensitive biochemical reaction in soils. Nitrification in forest soils is noted to occur below pH 4 but has not been found to take place below pH 6 in solution cultures (Paul and Clark, 1989).

The soil reaction is also an important, if not a determining, factor in environmental issues. It controls the fate of inorganic and organic pollutants in soils, by affecting their degradation or decomposition, solubility, and precipitation by formation of complex compounds, and many more. Adsorption of heavy metals by soil colloids increases with increased pH. Depending upon the pH,

the organic pollutant can be present in the soil solution in the cationic, anionic, or molecular form. The form in which it occurs determines the rate and degree of adsorption and, hence, its mobility in soil. The importance of the concept of surface acidity was discussed earlier in this connection of adsorption of organic compounds (see Section 7.1).

The colloidal particles in soils can also behave as acid or base. Hydrogen or Al-saturated clays usually behave as an acid and may react with bases.

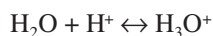
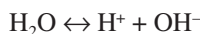
## 10.2 ACID–BASE CHEMISTRY

To understand, study, and apply the acid–base concept, it is important to first define an acid and a base. Three major concepts of acids and bases are available: Arrhenius, Brønsted–Lowry, and Lewis. Other less used concepts also exist—for example, Usanovich, Lux–Flood, and Pearson (Volpe and Siboni, 2006). The latter three are not used too often due to their ambiguity but will be addressed briefly below for completeness.

### 10.2.1 THE ARRHENIUS CONCEPT

The concept of Arrhenius developed between 1880 and 1890, stated that an acid is a compound that contains hydrogen. In aqueous solution, the acid yields hydrogen ions ( $H^+$ ). The hydrogen ion is in fact a bare proton, without the electron connected to it in the hydrogen atom. Therefore, the terms *hydrogen ion* and *proton* are often used interchangeably. Free hydrogen ions do not exist in the soil solution but exist only attached to water molecules, forming *hydronium ions*,  $H_3O^+$ . Because of the many complications introduced by the use of  $H_3O^+$  in writing chemical reactions, for simplicity it is customary to use  $H^+$  only.

Acids that can dissociate one, two, three, and more protons are often referred to as *mono-*, *di-*, *tri-*, and *polyprotic* acids, respectively. Compounds that can both dissociate or add a proton are called *amphiprotic* (Greek: *amphi* means “both”) compounds. Water is an example of an amphiprotic compound because it can dissociate, though very weakly, a proton and accept a proton to form a hydronium ion, as illustrated by the following reactions:



This reaction, called *autoprotolysis*, occurs to such an extent that only very small amounts of hydronium and hydroxyl ions are produced. Refined analyses reported values of  $1 \times 10^{-7} M$  for  $H_3O^+$  and  $OH^-$  ions in pure water at 25°C.

A base, on the other hand, is a compound containing hydroxide ( $OH$ ) groups that dissociate in aqueous solution as hydroxyl ions ( $OH^-$ ). A basic solution is also called an alkaline solution.

The Arrhenius concept is essentially valid only for the definition of acids. Almost all acids contain hydrogen and dissociate  $H^+$  ions. However, Arrhenius’ definition of a base limits the bases to only compounds containing hydroxide groups. It is currently known that ammonia ( $NH_3$ ) and many other organic substances exhibit characteristics of base compounds.

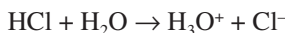
### 10.2.2 THE BRØNSTED–LOWRY CONCEPT

Brønsted and Lowry defined independently, in 1923, that an *acid* is a compound capable of donating a proton (*proton donor*). On the other hand, any compound capable of accepting a proton is considered a *base* (*proton acceptor*). This acid–base concept is also known as the *proton concept*.



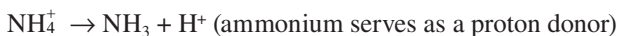
Therefore, HCl is an acid. However, after dissociation, the remaining  $\text{Cl}^-$  ion is then a base, because it can accept a proton. This type of acid–base pair is called a *conjugate pair*, with the  $\text{Cl}^-$  ion being the conjugate base of the acid HCl.

If HCl is dissolved in water, the following reaction occurs:



$\text{H}_3\text{O}^+$  was previously called a *hydronium ion*. Because hydronium is formed by adsorption of a proton by the water molecule, water is a proton acceptor. Consequently, water can be considered a base. The reaction to the left will not occur ( $\leftarrow \text{H}_3\text{O}^+ + \text{Cl}^-$ ), because  $\text{H}_2\text{O}$  is a stronger proton acceptor than proton donor.

According to this proton concept, ammonia ( $\text{NH}_3$ ) is then a base, and the ammonium ion ( $\text{NH}_4^+$ ) is called an acid, because of their reactions as illustrated below:



As is the case with HCl, this ( $\text{NH}_4^+ - \text{NH}_3$ ) pair is also a conjugate acid–base pair, with  $\text{NH}_3$  as the conjugate base of the acid  $\text{NH}_4^+$ .

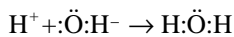
However, ammonia can also function as an acid, because it can dissociate according to the following reaction:



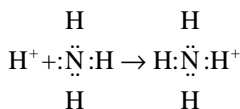
The amide ( $\text{NH}_2^-$ ) ion is the conjugate base to the acid  $\text{NH}_3$ . With a base stronger than itself,  $\text{NH}_3$  will behave as an acid, but with an acid stronger than itself, it will react as a base. Such a compound was previously called an amphiprotic compound.

### 10.2.3 THE LEWIS CONCEPT

According to this theory, also developed in 1923, an acid is a compound that can accept an electron pair (*electron-pair acceptor*). A base is a compound that can donate an electron pair (*electron-pair donor*). Hence, any substance that has an unshared pair of electrons is a base, and any compound that can react with that pair of electrons is an acid. This is also called the *electron concept*. The following serves as an example:



In this reaction, the  $\text{H}^+$  ion accepts an electron pair. The proton is then the acid and the bonding is called a *covalent bond*. The hydroxyl ion donates the electron pair and is considered the base. Another example is as follows:



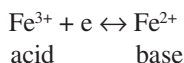
Again, the  $H^+$  ion accepts an electron pair and is the acid. Ammonia,  $NH_3$ , is then the base, because it donates the electron pair.

#### 10.2.4 THE USANOVICH CONCEPT

This concept that was developed by a Russian scientist, Michael Usanovich, in 1934 (Volpe and Siboni, 2006) is defined as follows:

1. Acid as a compound that reacts with a base, and in the process accepts electrons or anions or gives up cations.
2. Base as a compound that reacts with an acid, giving up electrons or anions or combines with cations.

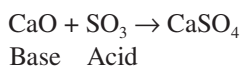
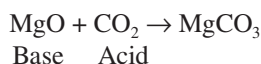
Usanovich is of the opinion that all compounds in the reduced state are bases, whereas all compounds in the oxidized state are acids. The following example illustrates Usanovich acid–base theory:



The reaction above shows the relationship of Usanovich's theory with the redox concept that was quoted in the literature by the confusing statement of an "overlap of the redox concept."

#### 10.2.5 THE LUX AND FLOOD CONCEPT

Herman Lux developed his acid-base concept in 1937 (Lux, 1939), which in 1947 was rediscovered by Hakon Flood (see Flood and Forland, 1947, p. 592). In their opinion, "an acid is an oxide ion acceptor, whereas a base is an oxide ion donor." This can be illustrated by Lux's (1939, p. 303) examples as follows:



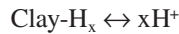
#### 10.2.6 THE PEARSON CONCEPT

Pearson (1963) developed the *HSAB* or *hard soft acid base concept* (see also Volpe and Siboni, 2006). *Hard* refers to a chemical species with a small radius, which is highly charged and weakly polarized, whereas *soft* refers to a chemical species with a large radius that is low in charge and strongly polarized. For example,  $H^+$  is a hard acid, whereas  $Ag^+$  is a weak acid. A hard base is  $OH^-$ , whereas a soft base is  $I^-$ . It finds occasional applications in transition metal chemistry and in ligand exchange reactions. This will be addressed in Section 12.1.

### 10.3 APPLICATION IN SOILS

In studying the three major theories, perhaps it can be noted that in the soil solution at one time both the Brønsted–Lowry and the Lewis theories can be applied. However, at another time, the Arrhenius and Brønsted–Lowry theories are more suitable to describe the condition. Reactions with clay minerals perhaps follow more the Brønsted–Lowry concept, whereas complex reactions involving organic matter apply only to the Lewis theory.

If clay can adsorb and dissociate protons as illustrated by the reaction:



where  $H_x$  is the number of adsorbed  $\text{H}^+$ , we can assume that soil clays can

1. Accept  $\text{H}^+$ : According to the Brønsted–Lowry concept, clay is then a base.
2. Dissociate  $\text{H}^+$ : Applying again the Brønsted–Lowry theory, clay is an acid.

Hence, clay behaves as an amphoteric compound.

## 10.4 FORMULATION OF SOIL ACIDITY AND ALKALINITY

### 10.4.1 SOIL pH

The theories of Arrhenius and Brønsted–Lowry in combination must be applied to characterize acid and alkaline conditions in soils. In acid soils, more  $\text{H}^+$  than  $\text{OH}^-$  ions are present. On the other hand, a basic soil has in its soil solution more  $\text{OH}^-$  than  $\text{H}^+$  ions. A soil with a neutral reaction contains equal amounts of  $\text{H}^+$  and  $\text{OH}^-$  ions. To characterize these conditions, the term *soil pH* is used. The term pH was introduced by Sørensen in 1909 while he was working on problems in brewing beer, where the fermentation reactions involved are very sensitive to the  $\text{H}^+$  ion concentration. It is defined as:

$$\text{pH} = \log 1/(a_{\text{H}^+}) = -\log a_{\text{H}^+} \quad (10.1)$$

where  $a_{\text{H}^+}$  is the activity of  $\text{H}^+$  ions.

However, frequently, it is more convenient to use  $\text{H}^+$  ion concentration rather than activity. In dilute conditions  $a_{\text{H}^+}$  equals  $(\text{H}^+)$ , and Equation 10.1 becomes:

$$\text{pH} = \log 1/(\text{H}^+) = -\log(\text{H}^+)$$

where  $-\log = \text{p}$ .

A simple term, pH, is now available for describing soil acidity by saying only that the pH is 7, instead of saying the  $\text{H}^+$  ion concentration is  $1 \times 10^{-7} \text{ M}$ . Application of this pH concept in the *autoprotolysis* or dissociation of pure water gives the following relationships. As discussed in Chapter 4, the ion product of water is:

$$K_w = C_{\text{H}^+} \times C_{\text{OH}^-} = 10^{-14} \text{ at } 25^\circ\text{C}$$

By taking the  $-\log$ , this equation changes into:

$$-\log K_w = -\log C_{\text{H}^+} + -\log C_{\text{OH}^-} = -\log 10^{-14}$$

or

$$\text{p}K_w = \text{pH} + \text{pOH} = 14 \quad (10.2)$$

in which  $\text{p} = -\log$ .

Equation 10.2 states that  $\text{pH} + \text{pOH} = \text{constant}$ , and conversion of one into another is a simple matter. Therefore, in describing soil acidity or soil alkalinity, it is not necessary to determine both

pH and pOH. If pH is known, pOH, or the  $-\log$  of the hydroxyl ion concentration, can be calculated using Equation 10.2.

We can see from the formulations above that the pH concept or the term soil acidity describes both the  $H^+$  and  $OH^-$  ion concentrations. If the soil solution contains 1 mole of  $H^+$  ions per liter (or  $1 \times 10^{-0} M$ ), then the soil  $pH = -\log 10^{-0} = 0$ , which constitutes the extreme limit of soil acidity, and consequently,  $pOH = 14$ . This means that the soil is very strongly acid, because the concentration of hydroxyl ions is  $1 \times 10^{-14}$  mol/L, which is an extremely low concentration. However, the number of actual  $OH^-$  ions per liter is still large. Avogadro's number is  $6 \times 10^{23}$ , so a concentration of  $1 \times 10^{-14}$  mol/L corresponds to  $6 \times 10^9$   $OH^-$  ions, which is 6,000,000,000  $OH^-$  ions/L.

When, on the other hand, the soil solution contains 1 mole of  $OH^-$  ions per liter (or  $1 \times 10^{-0} M$ ), then the  $pOH = 0$ , and the  $pH = 14$ , indicating the extreme alkaline limit of pH. In this case, the  $H^+$  ion concentration is extremely small, though the absolute number of  $H^+$  ions, amounting to  $6 \times 10^9$  ions per liter, is still large.

### 10.4.2 ACIDITY CONSTANT

According to the Brønsted–Lowry concept, the following acid–base relationship is valid:



This is a dissociation reaction; therefore, at equilibrium we have

$$K_A = [(H^+)(\text{base})]/(\text{acid})$$

in which  $K_A$  is the *acidity constant*. This was formerly called  $K_a$  or the ionization constant, but some books still use the term *acid dissociation constant*. Application of the pH concept in this equation gives:

$$pK_A = [pH - \log (\text{base})]/-\log (\text{acid})$$

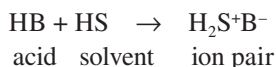
Rearranging gives

$$pH = pK_A + \log [(\text{base})/(\text{acid})]$$

This is the Henderson–Hasselbalch equation discussed in Section 4.13, and such a conclusion is supported by Anslyn and Dougherty (2005). The above derived equation also means that for a given ratio of concentrations (or activities) of an acid and its conjugated base, the pH has a fixed value (Novozamsky et al., 1976). When  $(\text{base}) = (\text{acid})$ ,  $\log[(\text{base})/(\text{acid})] = 0$ ; hence,  $pH = pK_A$ . In aqueous solutions, the  $pK_A$  generally ranges from  $\leq -2$  to  $\geq 12$ . A strong acid has a  $pK_A \leq -2$ , whereas a weak acid exhibits a  $pK_A$  between 2 and 7. On the other hand, a weak base is characterized by a  $pK_A$  between 7 and 10, whereas a strong base is characterized by a  $pK_A \geq 12$ . Consequently,  $H_3PO_4$ —a polyprotic acid with three  $K_A$  values—is a strong acid at  $K_{A1}$  but has to be considered a weak acid at  $K_{A2}$  and at  $K_{A3}$  falls even into the category of a weak base (see Section 4.16).

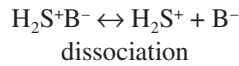
### 10.4.3 ACID STRENGTH AND ION PAIRS

The strength of an acid HB depends on the reaction of the acid with the solvent:



This reaction results in ionization of the acid and conjugated base. In most electrolytes, the resulting component ions do not completely dissociate from each other. The cations and anions are strongly attracted to each other, and a large part behaves as if it is not ionized. These ions present in association are called *ion pairs* (Davies, 1962). The degree of ionization is dependent on the relative alkaline strengths of the conjugated base and the solvent.

The dissociation of an ion pair into its component ions can be illustrated as follows:



The degree of dissociation depends on the dielectric constant of the solvent. The dielectric constant is the ratio of the capacity of an electric condenser in a vacuum and in the solvent,  $\epsilon = C_v/C_s$ .

By combining the two foregoing reactions, the dissociation constant ( $K_a$ ) of HB can be written as:

$$K_a = [(\text{H}_2\text{S}^+)(\text{B}^-)]/[(\text{HB}) + (\text{H}_2\text{S}^+\text{B}^-)]$$

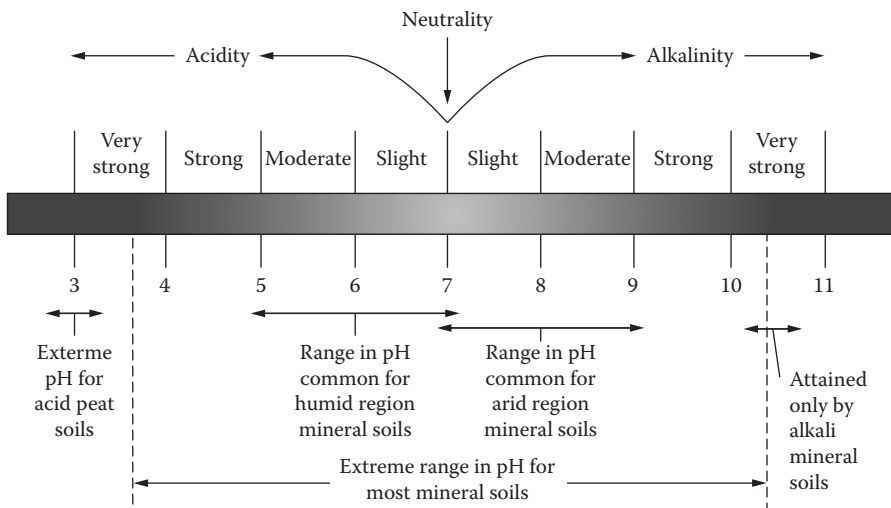
The value for  $K_a$  is used as a quantitative measurement of the strength of the acid.

## 10.5 CONCEPTS OF SOIL ACIDITY

### 10.5.1 SOIL pH RANGE

On the basis of their relative degree of acidity, the soils are divided into several acidity or alkalinity classes, as shown in Figure 10.1. As stated before, such a classification enables the use of proper terms for indicating acid–base conditions in soils. Instead of applying inaccurate terms, such as acid pH, neutral pH, basic pH, and the like, the use of the terms slightly, moderately, strongly, and very strongly acid (or basic) soil is more appropriate. By using them, the pH range is known.

Acid soils ( $\text{pH} < 7$ ) are usually common in humid regions. In these soils, the concentration of  $\text{H}^+$  ions exceeds that of  $\text{OH}^-$  ions. Most plants grow best in soils with a slightly acid reaction. In this pH range, nearly all plant nutrients are available in optimal amounts. Soils with a  $\text{pH} < 6$  will



**FIGURE 10.1** Soil pH ranges and soil reaction classes. (From Brady, N. C., *The Nature and Properties of Soils*, 8th ed., Figure 17–3, 463, MacMillan, New York, 1974. Reprinted and electronically produced by permission of Pearson Education, Inc., Upper Saddle River, NJ.)

more likely be deficient in some of the available nutrients for optimal plant growth. Calcium, Mg, and K are especially deficient in acid soils. In strongly and very strongly acid soils, Al, Fe, and Mn may exist in toxic quantities because of their increased solubilities. In addition, these elements will react with phosphates to form insoluble phosphates, as discussed in Section 9.3, on phosphate retention and fixation. Alkaline soils ( $\text{pH} > 7$ ) occur mostly in semiarid to arid regions. Because of the alkaline reaction, the soils contain low amounts of soluble Al, Fe, and Mn, due to formation and subsequent precipitation of insoluble Al, Fe, and Mn hydroxides. The micronutrients, Fe, Mn, Cu, and Zn, are usually unavailable or are available in quantities insufficient for plant growth. Severe micronutrient deficiency will most likely occur in moderately to strongly basic soils. In general, high pH and available Ca content are closely related, but there are exceptions, especially when Na is present. In strongly alkaline soils, phosphate fixation is again a problem due to formation of insoluble tricalcium phosphates.

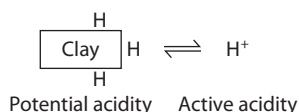
### 10.5.2 ACTIVE VERSUS POTENTIAL ACIDITY

A number of compounds contribute to the development of acidic and basic soil reactions. Inorganic acids and organic acids, produced by the decomposition of soil organic matter, are common soil constituents that may affect soil acidity. Water is a source for a small amount of  $\text{H}^+$  ions. Autoprotolysis of water yields hydronium ions in concentrations of  $1 \times 10^{-7}$  moles per liter (at  $25^\circ\text{C}$ ). Respiration of plant roots yields  $\text{CO}_2$  that will produce  $\text{H}_2\text{CO}_3$  in water. Nitrification is an additional biochemical source for  $\text{H}^+$  ions in soils. Cation exchange reactions are often considered to make the soils more acid by losing bases through exchange with  $\text{H}^+$  ions already present in soils, but cation exchange is neither a source nor a producer of  $\text{H}^+$  ions. Through the loss of bases by exchange, it is accumulating  $\text{H}^+$  ions, and therefore affecting reserve acidity.

The  $\text{H}^+$  ions may be present in soils as adsorbed  $\text{H}^+$  ions on the surface of the colloidal complex, or as free  $\text{H}^+$  ions in the soil solution. The portion of  $\text{H}^+$  ions adsorbed by the clay complex becomes exchangeable  $\text{H}^+$  ions. The exchangeable  $\text{H}^+$  ions dissociate into free  $\text{H}^+$  ions, and the amount adsorbed is usually in equilibrium with the amount free in solution. The chemical conditions created produce a chemical environment showing two types of soil acidities, as illustrated in Figure 10.2.

The types of  $\text{H}^+$  ions and the degree of ionization and dissociation into the soil solution determine the nature of soil acidity. The adsorbed, reserve, or exchangeable  $\text{H}^+$  ions are the reasons for the development of *potential*, *reserve*, or *exchange acidity*. The magnitude of the latter can be determined by titration of the soil. The free  $\text{H}^+$  ions create the *active acidity*. Active acidity is measured and expressed as soil pH. This is the type of soil acidity upon which plant growth reacts. However, the tendency exists today to call this exchange acidity *salt replaceable acidity*, which is related especially to exchangeable  $\text{Al}^{3+}$  that can be replaced by unbuffered salt solutions (e.g., KCl) (Chesworth, 2008). However, this is more a type of *potential acidity* because it requires hydrolysis of  $\text{Al}^{3+}$  to produce the  $\text{H}^+$  ions that are the true sources for soil acidity.

Taken together, the active and potential acidity make up the *total soil acidity*. The free  $\text{H}^+$  ion concentration of the soil solution at any particular time is relatively very small compared to the reserve or exchangeable  $\text{H}^+$  concentration. Most soil chemists indicate that the potential acidity may be 1000 times greater than the active acidity in acid sandy soils, and it may be even 50,000 to



**FIGURE 10.2** Relationship between active acidity and potential acidity. The latter is also called reserve or exchange acidity, because adsorbed  $\text{H}^+$  ions are  $\text{H}^+$  ions in reserve and are at the same time exchangeable.

100,000 times larger in acid clayey soils. In humid region soils, the removal of bases from the colloidal material, especially calcium, occurs constantly through ion exchange. Rainfall is sufficiently high to provide large amounts of water for leaching most of the bases from the soil. Their places on the colloidal complexes are taken by  $H^+$  ions.

The soil pH can be influenced only when sufficient amounts of lime are added to neutralize the total acidity. The greater the cation exchange capacity of the soil, the greater the reserve or potential acidity, and the more difficult it is to reduce the total acidity. This resistance to change in soil reaction is called the *buffer capacity*.

Brady and Weil (1996) reported a third type of soil acidity that they called *residual acidity*. It is defined as soil acidity that remains after active and exchange acidity have been neutralized. They believe that residual acidity is associated with aluminum hydroxy ions and with  $Al^{3+}$  and  $H^+$  ions that are bound in nonexchangeable forms by organic matter and silicate clays. Chesworth (2008) calls this “the remaining soil acidity that cannot be replaced by an unbuffered salt solution” (p. 10).

Aluminum hydroxy ions  $Al(OH)^{2+}$  and  $Al(OH)_2^+$  are the products of hydrolysis of  $Al^{3+}$  ions, which in turn are subject to hydrolysis, releasing  $H^+$  ions during the reaction. This will be discussed in detail in Section 10.5. According to current concepts, aluminum ions and their hydrolysis products are the primary sources of  $H^+$  ions in soils for both active and potential acidity. If free  $Al^{3+}$  ions can be considered contributors to the creation of residual acidity, then their hydrolysis products will also be important substances affecting in a similar fashion residual acidity. Nonexchangeable Al bound by organic matter is perhaps the only source for production of  $H^+$  ions creating the residual acidity. However, it is subject to many arguments, because this Al is known to be present in chelate form, and the stability of Al-humic acid chelates is pH dependent. Hydrolysis of chelated  $Al^{3+}$  depends upon its release into free  $Al^{3+}$  ions. In clay minerals, the only nonexchangeable bound Al is structural Al in the octahedrons, which can only be released after saturation of the clay complex with  $H^+$  ions. This reaction will cause a gradual destruction or decomposition of the clay mineral and is likely to occur only in extreme acid reactions not normally found in ordinary soil conditions. On the other hand, the substitution of Ca and Mg for octahedral Al or, in other words, the destruction of clay minerals by liming, has not been known to occur.

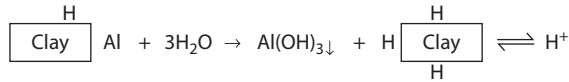
The most important types of nonexchangeable  $H^+$  ions bound to soil organic matter are the OH groups in carbohydrates, which do not contribute to production of  $H^+$  ions to any appreciable extent. However, the functional groups of humic acids and other organic acids can dissociate their  $H^+$  ions. Such dissociation is dependent upon pH and was discussed in detail in Section 5.9.

Nonexchangeable  $H^+$  ions bound to clay minerals are present as structural OH groups attached to the Al octahedrons. Only at high pH values will the exposed OH groups dissociate their hydrogen atoms. It is not yet known whether the nonexposed OH groups, located in the interior of the crystal, are also subject to a similar dissociation reaction. Dissociation of exposed OH groups on mineral surfaces was discussed in Chapter 6 as the major reason for the development of variable negative charges. They are, therefore, exchangeable at high soil pH. Whether the release of these  $H^+$  ions contributes to the residual acidity is a matter of conjecture.

### 10.5.3 NONSELECTIVE AND PREFERENTIAL ADSORPTION OF HYDROGEN IONS BY SOILS

Bolt (1976) distinguishes two types of adsorption of  $H^+$  ions by soil colloids—*nonselective* and *preferential adsorption*. Soil colloids, such as clay, adsorb  $H^+$  ions by the nonselective process. They accumulate on the charged surface as a swarm of counterions. The relative proportion can be estimated with the Gapon equation. Nonexchangeable  $H^+$  ions bound to clay are only present as structural OH groups attached to the Al octahedrons in the clay mineral. As indicated before, these hydroxyl groups, when exposed on the surface of the mineral, can dissociate their  $H^+$  ions at very high pH, increasing in this way the negative variable charges of the clays. In contrast to clay





**FIGURE 10.3** Theoretical reaction of the release of Al from a H–Al–clay, producing H<sup>+</sup> ions.

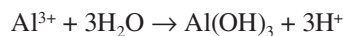
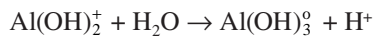
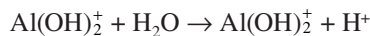
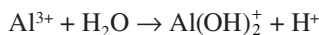
minerals, organic colloids exhibit preferential adsorption of H<sup>+</sup> ions. The organic compounds contain acidic groups, such as carboxyl and phenolic hydroxyl groups, which are highly selective for association with protons. The adsorbed H<sup>+</sup> ions are, then, considered part of the functional groups, and are located on the surface. Bolt (1976) considered them more difficult to exchange against other cations. It was shown that the exchange reaction is pH dependent.

## 10.6 THE ROLE OF ALUMINUM IN SOIL ACIDITY

Most clay particles interact with H<sup>+</sup> ions. Evidence is available that hydrogen-saturated clay undergoes a spontaneous decomposition. The hydrogen ion penetrates the octahedral layer and replaces the Al atoms. The Al released is then adsorbed by the clay complex and a H–Al–clay complex is formed rapidly. The Al<sup>3+</sup> ions may hydrolyze and produce H<sup>+</sup> ions as illustrated in the reaction shown in Figure 10.3. This reaction contributes toward increasing the H<sup>+</sup> ion concentration in soils. The magnitude of the change in pH is related to the Al concentration expressed in terms of the *aluminum potential*, pAl, which can be explained as follows. The exact reaction processes of hydrolysis of free Al<sup>3+</sup> ions are, however, more complicated than illustrated in Figure 10.3, because Al<sup>3+</sup> cannot exist as a free ion too long. As soon as an Al<sup>3+</sup> ion is present in the soil solution, it is quickly surrounded by six molecules of H<sub>2</sub>O in octahedral coordination, forming Al(H<sub>2</sub>O)<sub>6</sub><sup>3+</sup>. This ion is called an *aluminum hexahydronium ion*, which is the Al compound that undergoes hydrolysis:



The hydrolysis process continues further in a stepwise process according to the reactions as illustrated below. For simplicity, the Al monomers are customarily written in these reactions without their coordinated water:



Applying the mass action to the total or final reaction above gives:

$$K_h = [\text{Al}(\text{OH})_3](\text{H}^+)^3 / [(\text{Al}^{3+})(\text{H}_2\text{O})^3]$$

where K<sub>h</sub> is the hydrolysis constant. By considering Al(OH)<sub>3</sub> and H<sub>2</sub>O pure compounds at standard states, their activity equals unity. Hence, the equation can be converted into:

$$K_h = (\text{H}^+)^3 / (\text{Al}^{3+})$$

By taking  $-\log$ , the equation becomes:

$$-\log K_h = -\log (H^+)^3 - [-\log (Al^{3+})]$$

Substituting p for  $-\log$  gives:

$$pK_h = 3pH - pAl^{3+}$$

or

$$3pH = pK_h + pAl^{3+}$$

Division by 3 gives:

$$pH = \frac{1}{3} pK_h + \frac{1}{3} pAl^{3+}$$

The equation above, commonly called the *aluminum potential*, shows the relationship between pH and Al activity in soils. The degree of change in soil pH is, accordingly, dependent upon the aluminum concentration as expressed in terms of the aluminum potential. Once again, the author realizes that the equations above have been derived from ion activity products; hence, the term *aluminum potential* may not be acceptable for some (Chesworth, 2008). However, the name is now common knowledge and is used by most soil scientists as is the case with the *phosphate potential*. (See Section 9.7.3.) But in all fairness, the term *potential* not only relates to electric charges as implied by Chesworth (2008), but it also has the connotation of various degrees of possibilities capable of developing into actuality (*Merriam-Webster*, 1973). In this case, it is possible to determine the pH from the Al activity values; in other words, the equation has the potential to be used in predicting soil pH.

Polymerization of the Al-monomers,  $Al(OH)^{2+}$ , yields dimeric Al-hydroxides (Figure 10.4). As illustrated in Figure 10.4, oxolation reaction of Al-hydroxide polymers also increases the  $H^+$  ion concentration of the soil solution.

From the discussion above, it is clear that monomeric aluminum ions ( $Al^{3+}$ ) adsorbed electrostatically on the negatively charged surfaces of clay minerals can be released by exchange with other cations. They hydrolyze in solution, forming a series of Al-hydroxy compounds while releasing protons at the same time. The hydrolysis products are reabsorbed by the clay minerals, causing increased hydrolysis and production of more  $H^+$  ions. Acid soils are, therefore, high in soluble aluminum accompanied by a complex series of its hydrolysis products in the form of Al-hydroxy substances. As indicated above, the degree of change in pH is controlled by the aluminum potential. In line of this concept, Kennedy (1992) presents a hypothesis that aluminum compounds in acid soils are in fact pH buffers. Free  $Al^{3+}$ , released by exchange of adsorbed Al into the soil

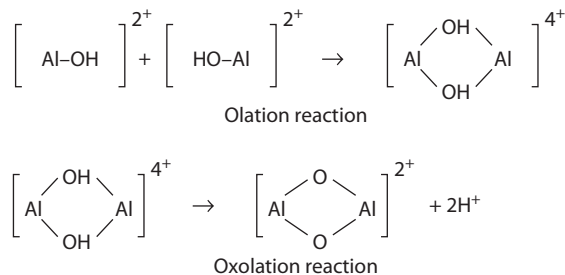
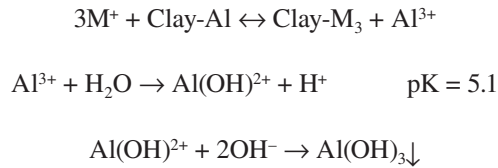


FIGURE 10.4 Polymerization of aluminum monomers.

solution, yields  $H^+$  upon hydrolysis. When the latter is not reabsorbed on the clay complex, but instead is neutralized by liming, the aluminum hydroxy ions are precipitated as insoluble aluminum hydroxides:



However, more  $H^+$  ions can be produced if more Al can be released from the exchange sites to replace the amounts lost, and the soil pH then remains unaffected. Therefore, exchangeable Al concentration can be considered as a source of *reserve acidity* in the same sense as the concept of reserve acidity based on exchangeable  $H^+$  concentrations. Because the hydrolysis of aluminum hydroxy compounds occurs at  $pK = 5.1$ , the buffering effect is felt at a soil  $pH \leq 5.1$ .

Kennedy (1992) believes that similar reactions are valid for  $Fe^{3+}$  ions. Free  $Fe^{3+}$  ions, released into the soil solution from the exchange sites on the clay surfaces, are also important sources of protons. When these protons happen to be neutralized by liming, the soil pH can only be maintained if more Fe can be moved from the exchange sites into the soil solution. Because the hydrolysis of  $Fe^{3+}$  occurs at a  $pK$  equal to 2.2, the buffering effect occurs at even lower soil pH values, and hence is unrealistic or nonpractical for normal soils.

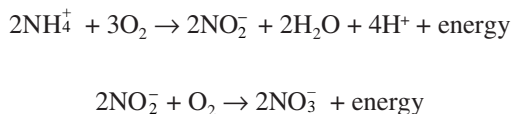
In view of the basic principles in aluminum chemistry as discussed above, it is perhaps accurate to say that the aluminum monomers, dimers, and polymers are more important in affecting potential and active acidity, rather than affecting residual acidity.

## 10.7 THE ROLE OF FERTILIZERS, SULFUR, PYRITE, N FIXATION, AND ACID RAIN IN SOIL ACIDITY

In addition to the aforementioned processes, both potential and active acidity can also be increased by human activities in agriculture and industry. The use of fertilizers to increase crop production in agriculture, the production of *mine spoils* containing pyrite in the coal industry, and emission of pollutant gases contributing to acid rain by the factories and power plants are *anthropogenic sources of  $H^+$  ions*.

### 10.7.1 AMMONIUM FERTILIZERS

Rising demands in food production pressurized by the rapidly increasing world population have stimulated the use of fertilizers. On the basis of their effect on soil pH, chemical fertilizers can for convenience be distinguished into *acid-forming*, *basic-forming*, and *neutral* fertilizers. All ammonium fertilizers are acid-forming fertilizers, because they decrease the soil pH. Basic-forming fertilizers, on the other hand, such as  $NaNO_3$ , may increase soil pH, and the application of neutral fertilizers has no effect on pH. Large applications of ammonium fertilizers are increasing the  $H^+$  concentrations in soils. In a normal healthy soil, ammonium ions will be attacked by microorganisms and oxidized into nitrate ions according to the following reactions:



As indicated in an earlier chapter, the oxidation of ammonium into nitrate, called *nitrification*, occurs in two steps. In the first step, the conversion of ammonium into nitrite, by the bacteria *Nitrosomonas* sp., produces four protons (see the first reaction above), which may increase soil acidity. In the second and final step, nitrite is oxidized into nitrate by the *Nitrobacter* sp. bacteria. Sparks (2002), quoting data from the literature, indicated that soil acidification due to nitrification of applied N to the amounts of 50 to 200 kg N per ha was 4 to 16 times greater than the effect of acid rain. Unfortunately not much more information is available on the effect of nitrification on soil pH, and only a few researchers have addressed it casually (Gowariker et al., 2009; Rengel, 2003). On the other hand, the literature abounds with studies of the effect of pH on the process of nitrification.

### 10.7.1.1 Equivalent Acidity and Acidity Index

The amount of acidity created by commercial fertilizers is usually expressed in terms of *equivalent acidity*, which is defined as the amount of lime required per unit amount of fertilizers used to bring the soil pH back to prefertilizer application levels. This is also called the *acidity index* by Gowariker et al. (2009) and should not be confused with the *acidity constant* (see Section 10.4.2). Values for equivalent acidities of major chemical fertilizers are shown in Table 10.1. As can be noticed, the values of equivalent acidities can be positive or negative in sign. For example, the equivalent acidity of ammonium nitrate equals 593. This means that the use of 1000 kg (or 2000 lb) of  $\text{NH}_4\text{NO}_3$  will decrease the soil pH to a point where 593 kg (or 1188 lb) of lime ( $\text{CaCO}_3$ ) are needed to restore the original pH. Therefore, the equivalent (or potential) acidity of 1000 kg (or 1 ton equals 2000 lb) of ammonium nitrate equals 593 (or 1188).

In contrast, the equivalent acidity of  $\text{NaNO}_3$  is  $-292$  (or  $-583$ ), which means that the use of 1000 kg (or 2000 lb) of  $\text{NaNO}_3$  will increase the pH to a point that (literally) 292 kg (or 583 lb) of  $\text{CaCO}_3$  must be taken out of the soil to restore soil pH to prefertilizer level.

Kennedy (1992) believes that nitrification of nitrogenous fertilizers will increase soil acidity, but never to the full extent expected from the nitrification reactions. Only one-half of the acidity expected from the nitrification reaction will be developed. This is caused by (1) the simultaneous uptake of nitrogen by plants (e.g., nitrate), (2) loss of  $\text{NH}_3$  by volatilization from soil, and (3) denitrification. Denitrification processes consume one proton per nitrate converted to  $\text{N}_2$ .

**TABLE 10.1**  
**Equivalent Acidity of Major Commercial Fertilizers**

Fertilizer	Equivalent Acidity	
	Per 1000 kg	Per 2000 lb
Ammonium nitrate, $\text{NH}_4\text{NO}_3$	593	1188
Ammonium phosphate, $\text{NH}_4\text{H}_2\text{PO}_4$	724	1450
Anhydrous ammonia, $\text{NH}_3$	70	140
Muriate of potash, $\text{KCl}$	—	—
Nitrate of soda, $\text{NaNO}_3$	$-292$	$-583$
Sulfate of ammonia, $(\text{NH}_4)_2\text{SO}_4$	1099	2200
Sulfate of potash, $\text{K}_2\text{SO}_4$	—	—
Superphosphate, $\text{Ca}(\text{H}_2\text{PO}_4)_2$	—	—
Urea, $\text{CO}(\text{NH}_2)_2$	749	1500
Triple superphosphate	—	—

### 10.7.2 PHOSPHATE FERTILIZERS

Application of monocalcium phosphate and superphosphate is also noted to increase soil acidity, although their equivalent acidity values are not listed in Table 10.1. Hydrolysis of superphosphate will yield orthophosphoric acid:



Being an acid, o-phosphoric acid will dissociate its proton in the soil solution, which decreases soil pH. The effect will occur particularly in soils where superphosphate is applied in bands. In crop production, the acidification effect is considered a temporary effect (Kennedy, 1992), because eventually the phosphate concentration will be reduced by plant uptake, or leaching, or by sorption and fixation reactions.

The use of superphosphate may also be of advantage in reducing the pH of alkaline soils and in buffering against increasing alkalinity.

### 10.7.3 ELEMENTAL SULFUR

Elemental sulfur, S, has often been used in crop production and horticultural operations to produce an acid growing environment needed by certain plants. The soils in tea plantations are frequently acidified by adding sulfur, and soils for growing azaleas, rhododendrons, and blueberries often received treatments of  $\text{FeSO}_4$ . Oxidation of sulfur produces sulfuric acid, which increases the  $\text{H}^+$  ion concentration in the soil solution. The oxidation reaction can be illustrated as follows:

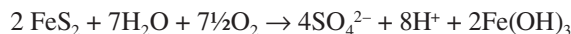


In soils, such a reaction is made possible by the presence of sulfur-oxidizing bacteria. In addition to creating acid media for acid-loving plants, the use of S to decrease soil pH is often desirable in alkaline and saline soils. In this case, elemental S is usually applied in combination with fertilizers, such as *S-coated urea*.

Emission of sulfur in the atmosphere by natural causes or by industry is a major contributor of acid rain, which will be discussed in a later section.

### 10.7.4 PYRITE ( $\text{FeS}_2$ )

Oxidation of pyrite,  $\text{FeS}_2$ , a sulfur mineral, produces sulfuric acid,  $\text{H}_2\text{SO}_4$ , which dissociates its protons in the soil solution. The reaction can be illustrated as follows:



This reaction produces eight protons and contributes toward increasing soil acidity. According to Stevenson (1986), the oxidation of pyrite is partly chemical and partly biochemical and yields  $\text{FeSO}_4$ , not  $\text{Fe}(\text{OH})_3$  as shown by the reaction above.

The process is of special importance in soils of coastal regions affected by the tide, and in soils derived from *mine spoils* or *mine tailings*. Drainage of tidal marshes causes oxidation of  $\text{FeS}_2$ . The sulfates from seawater are the sources of sulfides in the deltaic and coastal marshes. In inland swamps, the sulfides are derived from oxidation of sulfates from the surrounding rocks.

Coal contains large amounts of sulfur in the form of pyrite and organic sulfur. The residue of coal mines, called *mine spoil*, left behind on the land is rich in pyrite, which is subject to oxidation

in nature, creating extremely acid conditions in soils. One recent dramatic example of this problem is the pH reported of soils derived from mine spoils in Hungary, which was in the range of  $\text{pH}_{\text{KCl}} = 3.20$  to  $3.26$  (Simon, 2005). Compounded by the Cd, Cu, Pb, and Zn toxic concentrations of 7.1, 120, 2154, and 605 mg/kg, respectively, the soil was a real head-sore for crop production. However, Simon (2005) reported that by adding lime to increase the soil pH to 5, the soil became suitable for use as potting soil. Simon also claimed that *phytostabilization* of the toxic metals by growing red fescue have reduced the risk considerably of contaminating the food chain. What he meant was *phytoextraction*—a category of *phytoremediation* of soils—of the toxic elements by red fescue (see Tan, 2009).

The use of coal as an energy source will also oxidize the pyrite minerals and the organic sulfur, increasing emission into the atmosphere of sulfur dioxide gas. The latter is known to be an important contributor to acid rain, as will be discussed in Section 10.6.6.

### 10.7.5 BIOLOGICAL NITROGEN FIXATION

The effect of biological nitrogen fixation on soil acidity is a controversial issue. Most people realize the impact of soil pH on biological N fixation, in particular by legumes, but not the other way around. These legumes and their root rhizobia are generally very susceptible to soil pH and are noted to grow well only at the pH range of 5 to 8 (Leigh, 2002). The perception that biological nitrogen fixation increases soil acidity originates from growing legume-based pastures in Australia. The soils in areas with significant winter rainfall have been noted to become strongly acidic after growing legume-based pastures for an extended period of time. Kennedy (1992) believes that ammonia levels increase considerably in the soil due to ammonification of organic-N from nitrogen fixation. In a soil ecosystem where the level of inorganic nitrogen is in excess to that needed by the growing plants, this excess of ammonium will be nitrified, adding significant amounts of  $\text{H}^+$  ions to the soil solution. Kennedy (1992) argues that the process of nitrogen fixation alone does not contribute directly toward increasing the  $\text{H}^+$  ion concentration in soils, but it is the product in the form of organic-N released into the soil that has precisely a similar effect as the reaction of acid-forming fertilizers.

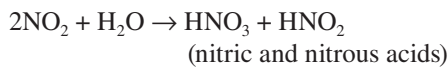
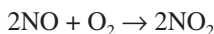
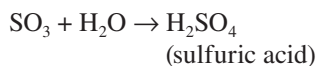
### 10.7.6 ACID PRECIPITATION

Acid precipitation, also known as *acid rain*, is caused by the conversion of nitrogen oxide and sulfur dioxide gases into strong acids. Alewell (2003) calls it also *acid deposition* and defines it as “the acidification of soils and the ecosystem by the acid input from the atmosphere due to human activities by burning fossil fuel” (p. 83). However, it should be realized that the process creating acid rains can also involve natural processes that occur frequently during thunderstorms and in regions with active volcanism. Wildfires and bushfires also contribute to the emission of gases contributing to acid rain. Carbon monoxide, nitrogen oxide, and sulfur oxide gases are released into the air by all of these activities and contribute to acid rain and acid soils in the region. However, emission of these pollutant gases into the atmosphere by human activity is often in excess to that created by natural causes and is today one of the most urgent issues of the century. The enhanced and continuous production of unwanted gases, generated by the combustion of fuel from motor vehicles, electric power production, space heating and cooling, and disposal of refuse, has become of global concern. In the United States alone, it was estimated, in 1965, that those anthropogenic processes have produced and released into the air 72 million tons of carbon monoxide, 26 million tons of sulfur dioxides, and 13 million tons of nitrogen oxides (Manahan, 1975, 2009). Kennedy (1992) quotes that nitrogen oxides are produced at the rate of 50 million tons annually. In central Europe, anthropogenic emissions of pollutant gases exceed natural emissions by a factor of 10. In clean air, nitric oxide is known

to have a half-life of a few days, but in polluted air it may be converted rapidly into nitrogen dioxide, which is soluble in water.

These gases are very harmful to the environment, plant growth, and human health. Carbon monoxide is very toxic for animals and human beings. It displaces oxygen from hemoglobin and reduces the capacity of blood to carry oxygen. The latter results in suffocation. Exposure to high levels of sulfur dioxide gas may cause *leaf necrosis* in plants. There is now evidence that nitrogen oxide gases, produced not only by industry but also by supersonic and space transport, may be harmful to the ozone layer of the stratosphere. From the standpoint of acid rain, carbon monoxide is of less significance than sulfur dioxides and nitrogen oxides.

Oxidation of sulfur dioxides and nitrogen oxides in the air and subsequent dissolution of the oxidation products in raindrops produce sulfuric acids, nitric acids, and their salts. Not only are these acids very corrosive, but they also result in a decrease in pH of the rainwater. The salts of these acids have been implicated in the formation of *turbid haze* or fog covering industrial towns in the Midwest and California. The processes of formation of acids can be illustrated by the following reactions:



These reactions are, in reality, very complex, and it is believed they are catalyzed by the presence of ozone. Sulfuric, nitric, and nitrous acids are strong acids and will dissociate their protons in water droplets of fog or rain. Because of this, the pH of rainwater or water in fog may decrease to two or lower. However, until now a lot of confusion existed on the pH as a result of acid rain. As of 2000, acid rain in the United States is considered to have a pH of  $\pm 4.3$  (Tan, 2009). The deposition of these acids in cloud and fog water is called by Alewell (2003) *occult deposition*. Alewell also distinguished between (1) *wet deposition*, which pertains to the above, and (2) *dry deposition*, which he defines as “the transport from the atmosphere of particulates and gaseous contaminants directly on land, water and plant surfaces in the absence of real precipitation or rain” (p. 83).

Acid rain has become of increasing concern today in Europe and North America because of the *die-back* of forest trees, a harmful process also known as *forest decline*. Acid rain has been implicated in defoliation of the forest in Germany, though direct evidence has not been presented. Development of fine roots in Scandinavian spruce has been noted to be restricted in the surface soil because of increased soil acidity. Yellowing of the needles and thinning of the crowns were thought to be symptoms of chronic water stress and magnesium deficiency as a result of the degrading environment (Kennedy, 1992). This yellowing of spruce needles has also been noted in the early 1970s in Czechoslovakia and the *Fichtelgebirge* of Northeast Bavaria (Germany) as the result of Mg deficiency. However, it is more likely that all these symptoms are caused by Al toxicity, due to increased solubility of alumina compounds in acid soils. Reports have also indicated that the increased acidity of lake water in the Adirondacks of the United States, because of acid rain, has contributed to *fish kill*, because most fish are sensitive to pH below 4.5. Key organisms of the food chain supporting lake trout will disappear at pH 5.8, whereas the ability of fish to reproduce may be impaired as early as pH 5.8 (Kennedy, 1992). Because of reproductive failure, salmon and brown trout are expected to disappear altogether at pH 5. However, the Great Lakes have been reported to possess an internal buffer capacity. The buffering reaction is a biological process through respiration of



nitrate (denitrification) and sulfate. The rate of buffering is noted to be proportional to the sulfate and nitrate concentration in lake water (Kennedy, 1992).

The effect of acid rain is of a less serious nature in soils than in lake water. Soils exhibit a cation exchange capacity (CEC) that provides them with a buffering complex to adsorb the excess protons from acid rain. However, prolonged impact by acid rain can saturate the buffer capacity of soils, which eventually increases soil acidity. This is especially critical in sandy soils that are weakly buffered by nature. Soils of calcareous origin may be able to neutralize the effect of acid rain due to its high pH and high base content. Alewell (2003) believes that the acid input to soils under forest cover is also affected by what he calls *canopy interaction*, which involves *through-fall*—water dripping down from tree canopies—and *stem flow*. The author claims that leaching of nutrients from through-fall and stem flow is far greater than by incident rains.

Two methods were proposed to control the effect of acid rain on soil acidity: cleaning the emissions in industry and in motor vehicles and liming the soils, or both. For example, the primary source of enhanced production of sulfur dioxide gas is coal. The sulfur in the coal is present as pyrite,  $\text{FeS}_2$ , and as organic sulfur. Upon burning of the coal, the pyrite minerals are oxidized and sulfur dioxide is produced as discussed above. Removing the S from the coal before use in the ovens to keep sulfur dioxide emissions at relatively low level is an option, but it is still a costly process. The effect of acid rain in soils is usually controlled by liming the soils. In Scandinavia, acidification of lakes is neutralized by spraying lake water with  $\text{CaCO}_3$  or  $\text{Ca}(\text{OH})_2$  slurries.

## 10.8 BUFFERING CAPACITY OF SOILS

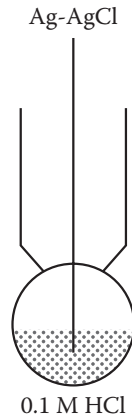
Chemically, a buffer solution is defined as one that resists a change in pH on addition of acid or alkali. Buffer solutions contain compounds that react with acid or base so that the  $\text{H}^+$  ion concentration in the solution remains constant. In soils, the clay and humic fractions act as a buffer system. As discussed previously, the soil cation exchange complex creates the development of active and potential acidity. The potential acidity will maintain the equilibrium with the active acidity. If the active  $\text{H}^+$  ion concentration is neutralized by the addition of lime, the potential acidity will release exchangeable  $\text{H}^+$  ions into the soil solution to restore the equilibrium, and no change in soil reaction occurs until the reserve in  $\text{H}^+$  is exhausted. The magnitude of the potential acidity usually far exceeds that of the active acidity. It was noted that in sandy soil, reserve acidity was 1000 times greater than active acidity. In clay soils with high organic matter content, reserve acidity was even 50,000 to 100,000 times greater than active acidity. Therefore, buffering capacity is greater in clay soils than in sandy soils. The larger is the buffer capacity, the larger is the amount of lime needed to raise the soil pH to the desired level.

The concept of buffering capacity of soils is not limited to the soil's resistance to changes in soil reaction. The soil can also act as a filter for dissolved and colloidal contaminants. It may act as a sieve, or during the passage through the topsoil, the aerated condition may oxidize and mineralize, in particular, the organic compounds. The ions released by mineralization are adsorbed by the soil's adsorption complex and prevented from reaching the groundwater.

## 10.9 ELECTROMETRIC MEASUREMENT OF SOIL pH

The determination of soil pH is now conducted with a glass electrode. It consists of a thin glass bulb containing dilute HCl, into which is inserted an Ag-AgCl wire, serving as the electrode with a fixed voltage (Figure 10.5). When the glass bulb is immersed in a soil solution, a potential difference develops between the solution in the bulb and the soil solution outside the bulb. This potential E is formulated by the *Nernst equation*:

$$E = (RT/nF) \log (K/M^{n+})$$



**FIGURE 10.5** A schematic diagram of a glass electrode.

where  $R$  is the gas constant,  $T$  is the absolute temperature,  $n$  is the valence,  $F$  is the Faraday constant,  $K$  is a constant, and  $M$  is the activity of ions to be measured with  $n+$  valence.

$E$  is called the *half-cell potential* and cannot be measured alone. If the glass electrode is placed against a reference electrode (usually a calomel electrode), the potential difference between the two ( $E - E_{\text{cal}}$ ) is measurable.

Before any pH measurement, the two electrodes have to be placed first in a solution of known pH (e.g., usually a solution with a  $\text{H}^+$  ion concentration = 1 g/L). This is called *standardizing* the electrodes and the pH meter. The overall potential of the total cell  $E_o$  equals  $E - E_{\text{cal}}$  and is formulated as follows:

$$E_o = [(RT/F) \log (K/1)] - E_{\text{cal}} \quad (10.3)$$

If the two electrodes are now placed in the solution with the unknown  $\text{H}^+$  ion concentration, the potential  $E_c$  is:

$$E_c = [(RT/F) \log (K/\text{H}^+)] - E_{\text{cal}} \quad (10.4)$$

Subtracting Equation 10.3 from Equation 10.4 gives

$$E_c - E_o = (RT/F) [\log (K/\text{H}^+) - \log K]$$

$$E_c - E_o = (RT/F) \log (1/\text{H}^+)$$

or

$$E_c - E_o = (RT/F) \text{pH}$$

Because  $RT/F = 0.0591$  at  $25^\circ\text{C}$ ,

$$\text{pH} = (E_c - E_o)/0.0591 \quad (10.5)$$

This means that for a change of one pH unit, the potential will change with 0.0591 volts. The soil pH can be measured in several ways. It can be measured in a water extract of soil, aqueous soil suspension, KCl-soil suspension, or  $\text{CaCl}_2$ -soil suspension.

### 10.9.1 MEASUREMENT OF pH IN WATER EXTRACT

Soil and water are mixed in a 1:1 or 1:2 (weight/volume) ratio and stirred thoroughly for 15 minutes, after which the supernatant is collected by centrifugation for pH measurement. The pH value obtained usually increases with increased volume of water used. The increase in pH is caused by the dilution of the  $H^+$  ion concentration in the solution. Therefore, the smallest soil/water ratio that can be used without producing technical difficulties is preferred in this method of pH measurement.

### 10.9.2 MEASUREMENT OF pH IN SOIL SUSPENSION

Soil and water are also mixed in a 1:1 or 1:2 ratio and then stirred for 15 minutes, after which the pH is directly measured in the soil suspension. As with the previous method, the value obtained will also change with increased dilution by the use of wider soil/water ratios. Some workers prefer to use a saturated soil paste. However, in sandy soils the contact between the electrode and the soil solution is decreased, and the chance to damage the electrode is increased. The value obtained is considered to be closer to the true pH value in nature than the supernatant pH. It is often lower in value than the soil pH measured in its supernatant solution. This is caused by the suspension effect, which will be discussed below.

### 10.9.3 MEASUREMENT OF pH IN A KCl SOLUTION

For this method, the soil is mixed with a 1 M KCl solution in a 1:1 or 1:2 ratio. The pH is measured directly in the soil suspension. This type of measurement will yield a more stable result than with the two other previously discussed methods. It is sometimes referred to as the *buffered pH*. In acid soils, the pH value obtained is usually lower than that measured with the other methods above. The use of  $pH_{KCl}$  will provide better information concerning the chemical properties of the system (Moore and Loeppert, 1987). It is believed that the KCl-pH reflects closely the CEC and the cationic composition of the exchange complex.

### 10.9.4 MEASUREMENT OF pH IN A $CaCl_2$ SOLUTION

The soil is mixed with a 0.1 M  $CaCl_2$  solution using a 1:1 or 1:2 soil-to-solution ratio, and the pH is measured in the  $CaCl_2$  suspension. This type of measurement is often used in conjunction with the determination of the *lime potential*, which will be discussed separately below.

## 10.10 SUSPENSION EFFECT IN SOIL pH MEASUREMENT

In the pH measurement, the reference and indicator electrodes are immersed in a heterogeneous soil suspension composed of dispersed solid particles in an aqueous solution. If the solid particles are allowed to settle, the pH can be measured in the supernatant liquid or in the sediment. Placement of the electrode pair in the supernatant gives a higher pH reading than placement of the electrodes in the sediment. This difference in soil pH reading is called the *suspension effect*.

Stirring the soil suspension before measurement will not solve the problem, because the latter procedure gives unstable readings. According to Bolt et al. (1976), the reference electrode should be placed in the supernatant. The position of the glass electrode is considered immaterial at the equilibrium condition. This is rather strange because the electrode pair then measures the supernatant pH if both electrodes are placed in the supernatant. The glass electrode should more likely be placed in the sediment.

## 10.11 LIME POTENTIAL

It is apparent from the foregoing discussions that measurements of soil pH can give highly variable results, because they are affected by several factors, including suspension effect, soil/water ratios, and electrolyte levels. Schofield and Taylor (1955) proposed the use of 0.1 M CaCl<sub>2</sub> solutions for obtaining stable readings in pH measurements. However, instead of using single ion activity measurements, Schofield and Taylor (1955) suggested the use of ion activity ratios for determination of soil acidity and base saturation. If the soil exchange complex is saturated with both H<sup>+</sup> and Ca<sup>2+</sup> ions, at equilibrium Schofield's ratio law says that:

$$H^+/\sqrt{Ca^{2+}} = \text{constant}$$

By taking  $-\log$ , this ratio changes to

$$-\log H^+/\sqrt{Ca^{2+}} = \text{constant}$$

$$(-\log H^+) - (-\log \sqrt{Ca^{2+}}) = \text{constant}$$

or

$$pH - \frac{1}{2}pCa = \text{constant} \quad (10.6)$$

This equation is called the *lime potential*. It characterizes the composition of the exchange complex relative to its saturation by H<sup>+</sup> and Ca<sup>2+</sup> ions. Many of the methods for determination of the lime requirement take into consideration the lime potential. The equation says that a change in pH is dependent on the Ca<sup>2+</sup> concentration expressed as the calcium potential ( $pH = \frac{1}{2}pCa + \text{constant}$ ), and as discussed in Section 10.5, the term potential is viable.

## 10.12 THE NEED FOR ACIDIC SOIL REACTIONS

Usually, soil fertility is improved by liming acid soils to pH 6 to 7. Most plants grow well in this pH range. At this soil reaction, available Ca, Mg, and P concentrations are adequate for plant growth. The levels of micronutrient contents in the soil solution are sufficient. Both fungal and bacterial activity are also present.

However, in certain cases it is desirable to maintain a strong to moderately acid condition for plant growth. Some ornamental plants (e.g., azaleas and rhododendrons) require acid soil reactions for optimum growth. Pine trees also grow better in acid soils. Other crops that are grown in acid soils are blueberries, pineapples, and Irish potatoes. With potatoes, the acid condition will reduce the development of potato scab, a disease caused by actinomycetes, which affects the quality of the potatoes. Tea is also grown frequently in acid soils.

A number of compounds can be used to maintain or intensify soil acidity. Acid organic matter (e.g., pine needles) or chemical compounds such as S powder or FeSO<sub>4</sub> can be mixed with the soil to produce the acid reaction. The role of these compounds in contributing to the H<sup>+</sup> ions concentration was discussed in Section 10.6.

## 10.13 SOIL REACTIONS IN SALINE AND SODIC SOILS

### 10.13.1 SALINIZATION

Saline and sodic soils, today called *Aridisols*, are soils of arid regions where the average precipitation is less than 500 mm (20 in.) annually. The amount of H<sub>2</sub>O coming from the precipitation is

insufficient to neutralize the amount of  $\text{H}_2\text{O}$  lost by evaporation and evapotranspiration. As the water is evaporated in the atmosphere, the salts are left behind in the soil. The process of accumulation of soluble salts in these soils is called *salinization*. The salts are mostly  $\text{NaCl}$ ,  $\text{Na}_2\text{SO}_4$ ,  $\text{CaCO}_3$ , and  $\text{MgCO}_3$ . In the past, the soils developed were called *saline soils*, *white alkali soils*, or *solonchaks*. They belong to the zonal-type soils. Salinization can also occur locally and develops the intrazonal type of saline soils (e.g., soils reclaimed from the sea bottom) and soil's in coastal areas affected by the tide.

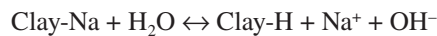
### 10.13.2 SODICATION AND ALKALINIZATION

The addition of salts to the soil may result in saturating the soil's exchange complex with Na. The process of progressively increasing the Na saturation of the soils exchange complex is called *sodication*. The soils formed are called *sodic soils*, *solods*, *solonetz*, or *black alkali soils*. If these soils occur only in small areas (in small localized spots), they are often called *slick spots*.

Kamphorst and Bolt (1976) reported that sodication does not necessarily yield a rise in soil pH. Many sodic soils are neutral in reaction, whereas a number of solonetzic soils are even acid in reaction. In sodic soils with a neutral soil reaction, the Na salts are neutral salts such as  $\text{NaCl}$ . The strong alkaline reaction ( $\text{pH} = 10$ ) of most sodic soils is caused by alkalization. The latter is due to hydrolysis of  $\text{Na}^+$  ions or  $\text{Na}_2\text{CO}_3$  compounds:



The  $\text{OH}^-$  ions produced will increase the soil pH, whereas the  $\text{Na}^+$  is saturating the exchange complex. The latter, in turn, may undergo hydrolysis, which also contributes toward increasing the  $\text{OH}^-$  ion concentration in the soil:



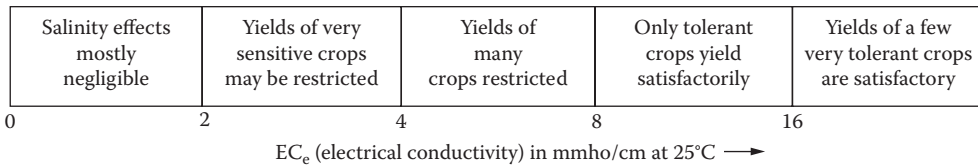
## 10.14 CHEMICAL CHARACTERIZATION OF SALINE AND SODIC SOILS

It is apparent from the foregoing that soil pH is not a good method for characterization of these soils. The saline soils have a soil  $\text{pH} = 8.5$  or lower. The sodic soils may possess a soil  $\text{pH} = 10$ , and some of the soils may be neutral, whereas others are acid in reaction. To distinguish saline and sodic soils from other soils, the U.S. Salinity Laboratory (Richards, 1954) proposed to use as criteria soluble salt and exchangeable  $\text{Na}^+$  content. These parameters are expressed in terms of electrical conductivity ( $\text{EC}_e$ ) for salt content and exchangeable sodium percentage (ESP) for exchangeable  $\text{Na}^+$  content. The salinity of the soil is found by measuring the  $\text{EC}_e$  in *millimho per centimeter (mmho/cm)* of the soil's saturated extract. In the International System of Units (SI) system, the unit *decisiemen/m* is used, but because  $\text{mmho/cm} = \text{decisiemen/m}$ , the conversion is a simple matter. The ESP analysis is conducted by suction and filtration of a water-saturated soil paste. The exchangeable sodium percentage is then calculated using the following formula:

$$\text{ESP} = (\text{exchangeable Na}^+ / \Sigma \text{exchangeable cations}) \times 100\%$$

Based on ESP and  $\text{EC}_e$  values, three groups of soils are recognized: (1) *saline soils*, (2) *saline-alkali soils*, and (3) *nonsaline-alkali (sodic) soils*.

The *saline soils* are characterized by  $\text{EC}_e > 4$  mmho/cm at  $25^\circ\text{C}$ , and  $\text{ESP} < 15\%$ . Dispersion of saline soils occurs at  $\text{ESP} = 15\%$ . The soil pH is ordinarily less than 8.5. Because of the presence of excess salts and low amounts of  $\text{Na}^+$  ions in exchange position, these soils are usually in a flocculated state, and their permeability is considered to be equal or higher than the two other soils.



**FIGURE 10.6** The degree of salinity, as expressed in  $EC_e$  values, on yields of crops according to the U.S. Salinity Laboratory. (Adapted from Richards, L. A., ed., *Diagnosis and Improvement of Saline and Alkali Soils*, USDA Agriculture Handbook No. 60, U.S. Government Printing Office, Washington, DC, 1954.)

The *saline-alkali soils* are soils with  $EC_e > 4$  mmho/cm at 25°C, and ESP > 15%. These soils have both free salts and exchangeable  $Na^+$ . As long as excess salts are present, the soil is flocculated, and the pH is normally  $\leq 8.5$ . When the soils are leached, the free salt content decreases, and the soil reaction may become strongly alkaline (pH > 8.5) because of hydrolysis of the exchangeable  $Na^+$ .

*Nonsaline-alkali soils* are characterized by  $EC_e < 4$  mmho/cm at 25°C and ESP > 15%. Most of the  $Na^+$  is in exchangeable form, and very small amounts of free salts are present in the soil solution. The soil pH ranges from 8.5 to 10. As a result of irrigation, strongly alkaline conditions may develop in these soils, and pH values reaching 10 are common.

The selection of the *critical value for  $EC_e$*  at 4 mmho/cm was reported to be based on the expected salt damage to crops. The  $EC_e$  value of 4 mmho/cm originated with Schofield in 1942, who considered the soil to be saline at 4 mmho/cm or above. At the latter values, the yield of many crops is restricted. Kamphorst and Bolt (1976) indicated that an  $EC_e$  of 4 mmhos/cm corresponded to an osmotic pressure at field capacity of 5 bars. At  $EC_e$  values between 2 and 4 mmho/cm, only very sensitive crops will be affected, and at values below 2 mmho/cm the effect of salinity is negligibly small (Figure 10.6). However, different opinions exist on the critical  $EC_e$  value, because several authors indicated that cotton, wheat, and soybeans are growing well in soils at  $EC_e$  values of 7.7, 6, and 5 mmho/cm, respectively (Fipps, 2003; Rhoades et al., 1992). Perhaps these crops can be grouped as salt-tolerant crops. Sugar beet is another crop that is considered salt tolerant.

The decision to use an ESP value of 15% is also arbitrary, because no sharp changes in soil properties have been observed as the degree of saturation of the exchange complex with  $Na^+$  ions is increased. Moreover, different crops will react differently to the same ESP value (Kamphorst and Bolt, 1976; Richards, 1954). The U.S. Salinity Laboratory has used, from history and experience, the ESP = 15% as a boundary limit to distinguish nonalkali from alkali soils.

### 10.15 EFFECT OF SALINIZATION AND SODICATION ON PLANT GROWTH

The accumulation of soluble salts in soils severely inhibits plant growth. It induces plasmolysis (see Section. 7.6), by which  $H_2O$  moves out of the plant into the soil solution. Most scientists only realize the danger of the osmotic effect to crops brought about by salinization. However, according to Stewart and Howell (2003), the following special ion effect can also be very harmful to growing crops. The  $Na^+$  and  $Cl^-$  ions are taken up and move with the transpiration flow from roots to leaf tissues where they accumulate. Stewart and coworker indicate that older leaves exhibit greater transpiration than younger leaves; hence, the tips and margins, in particular, of the older leaves will develop injury first due to accumulation of the above. They firmly believe that the combined osmotic and this special ion effect are perhaps even more harmful than the guidelines for salt tolerance would have indicated.

Another important effect is that the presence of high amounts of  $Na^+$  ions may keep the soil particles suspended. Upon drying, the soil may cake, and crust formation develops at the surface. The latter decreases soil porosity, and aeration is severely inhibited. Of equal importance is the high pH in many of the soils which reduces the availability of many micronutrients. These soils frequently encounter Fe, Cu, Zn, or Mn deficiencies.

**TABLE 10.2**  
**Index of Salinity Hazard in EC<sub>e</sub> Values**

Salinity Hazard	EC <sub>e</sub> (mmho/cm at 25°C)
Low	<0.75
Medium	0.75–1.5
High	1.5–3
Very high	>3.0

In the opinion of Sparks (2002), three parameters or equations are available for the determination of sodic hazards. They are the SAR (sodium adsorption ratio), ESR (exchangeable sodium ratio), and ESP (exchangeable sodium percentage). The present author believes that a big difference exists between salinity and sodic hazards. Sodic refers mainly to the issue of Na (sodic) ions, whereas salinity refers to a broader spectrum where not only sodium, but also pH, osmosis, and so forth, are included. Hence, a distinction is made below by addressing them separately, which will expose the issue clearly.

## 10.16 IRRIGATION OF SALINE AND SODIC SOILS

Reclamation and management of the saline and sodic soils are based mainly on proper irrigation and drainage, on the exchange of Na<sup>+</sup> for Ca<sup>2+</sup> on the exchange complex, and on the use of salt-tolerant crops.

### 10.16.1 SALINITY HAZARDS

To make saline soils arable, leaching of excess salts by irrigation is usually conducted. A proper drainage method and the use of irrigation water with the proper salt quality are necessary. In this respect, the electrical conductivity EC<sub>e</sub> is frequently used as an index for salinization hazard. The hazard of salinization is considered low if irrigation water used has an EC<sub>e</sub> < 0.75 mmho/cm (Richards, 1954; Taylor and Ashcroft, 1972) (see Table 10.2).

In arid regions, salinization is a natural phenomenon. Therefore, the chances for salinization are considered very high if water with EC<sub>e</sub> = 3.0 or higher is used for irrigation over many years, even on nonsaline soils.

### 10.16.2 HAZARDS OF SODICATION

The hazard of sodication is usually estimated by the use of the sodium adsorption ratio (SAR). The SAR formula varies somewhat according to different authors. The formula, as originally presented by the U.S. Salinity Laboratory, is as follows (El-Swaify, 1979; Richards, 1954):

$$\text{SAR} = (\text{Na}^+) / \sqrt{[(\text{Ca}^{2+} + \text{Mg}^{2+})/2]} \quad (10.7)$$

However, Janzen (1993) and Sparks (2002) give a slightly different version for SAR:

$$\text{SAR} = (\text{Na}^+) / \sqrt{(\text{Ca}^{2+} + \text{Mg}^{2+})} \quad (10.8)$$

The concentration of Na<sup>+</sup> and Ca<sup>2+</sup> + Mg<sup>2+</sup> can be expressed in millimoles per liter (Janzen, 1993; Kamphorst and Bolt, 1976) or in milliequivalents per liter (El-Swaify, 1979; Taylor and Ashcroft,



1972). Sparks (2002) also indicates that total concentrations are used in Equation 10.8, and not activities; hence, SAR does not express the effects of ion pair or complex formation that influence changes in free ion concentration and activities. He also claims that  $\text{Ca}^{2+}$  and  $\text{Mg}^{2+}$  are treated as similar ion species. Perhaps these are more academic problems, because in practice the concentrations of  $\text{Ca}^{2+}$  in soils are generally substantially higher than those of  $\text{Mg}^{2+}$  ions. Sparks also suggests that Equation 10.8 be simplified into the following:

$$(\text{Na-soil})/[\text{CEC} - (\text{Na-soil})] = k_G \text{ SAR} = \text{ESR} \quad (10.9)$$

where  $k_G$  SAR equals the modified Gapon selectivity coefficient.

It is up to the readers whether Equation 10.9 is a simpler version than Equation 10.8. Anyway, no agreement seems to exist either on the formula or the units to be used, creating in this way considerable confusion on the proper determination of SAR. For most soils, El-Swaify (1979) believes that SAR is related linearly to ESP.

Because the sodic soils are highly saturated with  $\text{Na}^+$  ions, it is necessary to use irrigation water with low SAR values on these soils. It is sometimes suggested to add gypsum to the irrigation water. But most often the gypsum is plowed under in the soil. This may ensure the development of low SAR values of the water in the soil. The  $\text{Ca}^{2+}$  may, at the same time, replace  $\text{Na}^+$  from the exchange complex. Theoretically, any soluble Ca compound that will not affect soil pH can be used together with irrigation water to reduce the SAR value and exchange the  $\text{Na}^+$  ions.

### 10.17 SALT BALANCE AND LEACHING RATIO

Irrigation will sometimes only wet the soil. This is a potential danger for salt buildup. In the management of saline and sodic soils, the salt balance is taken into account. The latter means that the amount of salt brought into the soil must equal the amount of salt leached out of the soil. Therefore, more water must be applied over that needed to wet the soil. The additional water, used for leaching, is called the *leaching requirement* (LR) (Bernstein and Francois, 1973):

$$\text{LR} = \text{EC}_{\text{iw}}/\text{EC}_{\text{dw}}$$

where  $\text{EC}_{\text{iw}}$  is the electrical conductivity of irrigation water, and  $\text{EC}_{\text{dw}}$  is the electrical conductivity of saturation extract of saline soil which exhibited 50% decrease in yield.

If the irrigation water increases in salinity over the years, the value of LR becomes larger. Bernstein and Francois (1973) suggested managing irrigation in such a way that the major water needs of crops are supplied at the minimum salinity level of the irrigation water.

### 10.18 IRRIGATION-INDUCED SALINIZATION AND SODICATION

The hazard of salinization and sodication is perhaps not limited to semiarid and arid region soils. Currently, it is common practice to also use supplementary irrigation in areas with measurable rainy seasons. With easy access to water from the huge underground aquifers in the southern coastal plain region of the United States, large areas are now continuously being irrigated by the center pivot sprinkle system. No adequate disposal systems of the used irrigation water have yet been devised. The irrigation water reaching the soil is allowed to percolate naturally through the soil and return to the groundwater in a more concentrated condition. A large part of the irrigation water may, perhaps, also evaporate, leaving the salts in the surface soil. No investigations have yet been done on the potential hazard of salinization and sodication by the use of this water. The danger of salinization and sodication is somewhat reduced by the presence of a humid climate. However, over many years, one can expect a reduction in the quality of this irrigation water by the use of high amounts of fertilizers and in the absence of a proper drainage and disposal system.

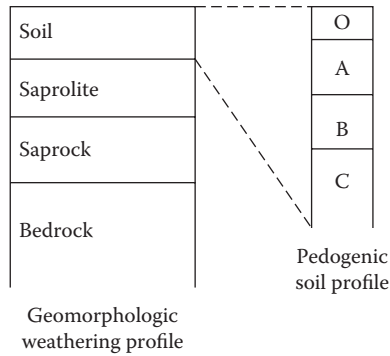
---

# 11 Soil Chemistry and Soil Formation

## 11.1 CONCEPTS OF WEATHERING

A number of opinions and several concepts are present on weathering and its result on earth. As defined in the dictionary, “weathering is the physical disintegration and the chemical decomposition of earth material at or near the earth’s surface” (Merriam-Webster, 1973, 2003), which soil scientists interpreted as precursors of *pedogenesis* or soil formation. In contrast, geomorphologists and geologists assign a geological issue to weathering involving evolution of *landscape*, characterized by *weathering profiles*. Geomorphologists believe that weathering and erosion have formed earth’s landscape. The forces responsible are considered to be cyclic or episodic (Huggett, 2003). Applying the French concept of *biostasy* and *rhexistasy* of Erhart (1967), they indicate that during biostasy (the period of biological equilibrium which is the normal state), weathering profiles are formed with ferrallitic soils on top. During rhexistasy, set off by a series of tectonic activities with active volcanism, periodic seismic upheavals and calamitous climatic changes, the biological equilibrium above is disrupted and erosion becomes rampant, destroying the ferrallitic soil cover of the weathering profiles (see also Tan, 2009). Another theory followed by geologists is the *K-cycle*, which bears close resemblance to the Erhart model (Huggett, 2003). Although several weathering profiles are recognized depending on types of rocks, all of them have similar features. All weathering profiles have in common a soil layer, underlain by a layer of *saprolite*, *saprock*, and *bedrock*. The latter can be subdivided again into *altered* and *unaltered rock* (Velde and Meunier, 2008). Therefore, a weathering profile can be visualized schematically as shown in Figure 11.1.

The geologic or geomorphologic concept emphasizes weathering of rocks and its result through the earth’s crust deep down to what they call unaltered rock. It is in essence the breakdown of rocks with the consequent formation of rock debris, characterized by a decrease in rock density and an increase in formation of finer materials, especially clay. A *weathering profile* is formed which is composed of layers of weathered rocks, varying in particle sizes with clay as the ultimate fine size. The decreasing clay content and increasing density from soil to saprolite, saprock, and bedrock are the main distinct differences of the weathering layers. Velde and Meunier (2008) defined saprolite as “a nonstructure-conservative altered saprock with lower density and higher clay content than the saprock” (p. 115). In pedology (soil science), saprolite is defined as an “unconsolidated residual rock material underlying the soil and grading to hard bedrock below” (SSSA, 1997, p. 8). The saprock is defined by Velde and Meunier as “a structure-conservative altered rock” (2008, p. 115), and the present author believes that this is perhaps similar to the “regolith” in soil science. The concept of a soil profile in pedology (see Figure 11.1) differs in that it emphasizes weathering of all materials, both inorganic and organic, in the upper surface only of earth’s crust. These processes precede pedogenesis and form the parent material, which by soil formation is converted into a pedon (soil). A sequence of soil horizons is formed in the pedon—O, A, B, and C horizons—from the surface down to the C horizon, which collectively is called a *soil profile* (Tan, 2009). The kind of weathering of rocks below the soil surface to deep below in earth’s crust, creating a weathering profile, is called *geochemical weathering* by Jackson and Sherman (1953), whereas that occurring in the soil (pedon) section only is known as *pedochemical* weathering. This will be discussed in more detail in Section 11.2.



**FIGURE 11.1** A geomorphologic or geologic weathering profile as compared to a pedogenic soil profile.

## 11.2 WEATHERING PROCESSES

The discussion below emphasizes weathering processes in pedology. As indicated above, weathering refers to the disintegration and alteration of rocks and minerals by physical and chemical processes. However, today it is known that biological processes also play a distinct, important role. *Physical weathering* is caused by physical stresses within the rock or mineral. It causes the rocks to disintegrate into smaller-sized material, without changing the chemical composition. *Chemical weathering* is caused by chemical reactions, and definite chemical changes occur in the weathering products. It is a constructive force, because new materials are formed (e.g., clay and humic material). For an illustration of the chemical reactions involved (e.g., solution, hydration, dehydration, hydrolysis, oxidation, reduction, and carbonization), reference is made to the textbooks on the principles of soil science (Birkeland, 1974; Brady, 1974, 1990; Donahue et al., 1977; Foth and Turk, 1978; Tan, 2009). *Biological processes* have been known for a long time to play a major role in rock and mineral weathering and in soil genesis, but only with recent advances in soil organics have these processes gained prominence. Rock and mineral dissolution through chelation by organic acids, such as humic acids, is presumed today to be more effective than hydrolysis (Birkeland, 1974; Tan, 1986, 2009). Two types of biological weathering processes are distinguished: (1) biochemical weathering and (2) biological weathering. According to Robert and Berthelin (1986), *biochemical weathering* is related to reactions with chemical compounds excreted or secreted by organisms, and to interactions with their decomposition products. On the other hand, *biological weathering* includes biochemical weathering and other processes related to the presence and activity of live organisms. Often a sharp distinction cannot be made between biological and biochemical weathering. Physical disintegration of rocks by growing roots requires the presence of live organisms, but rock and mineral dissolution by chelation can take place in the presence or absence of live organisms.

In nature, physical, chemical, and biological weathering may occur simultaneously. They usually precede soil formation from solid rocks. Although, by nature, physical weathering is of more importance at or near the soil surface, occasionally it may take place below the soil surface. Plant roots may contribute to physical weathering below the soil surface. By growing into cracks, they may rupture the rocks apart.

Chemical weathering can occur at the soil surface, in the solum, or below the solum. Therefore, Jackson and Sherman (1953) suggested distinguishing it into pedochemical and geochemical weathering. *Pedochemical weathering* refers to chemical weathering within the solum, which is that part of the soil profile from the O to B horizons only. On the other hand, *geochemical weathering* is weathering below the solum, or in other words from the C horizon to farther below. Geochemical weathering of rocks below the pedon was discussed in Section 11.1. In pedology, often a sharp separation between pedochemical and geochemical weathering, as reported by Buol et al. (1973), is

difficult to realize in nature. The main chemical reactions, such as solution, hydrolysis, hydration, dehydration, oxidation, reduction, and carbonation, take place in the solum as well as in the parent material. Leaching of K from micas, alteration of clays by H<sup>+</sup> ions, and interlayering and formation of clays can occur as a pedochemical or as a geochemical process.

Biological weathering is expected to occur mainly in the solum, because biological activity decreases rapidly with depth in the pedon. Decomposition and formation of organic acids, respiration of roots and microorganisms, nitrification, and ammonification are more likely to take place in the surface soil than in the subsoil or in the parent material. Of course, exceptions are always present. Long and deep taproots may grow and crack stones and rocks in the subsoil.

Regardless of the differences in opinion, weathering in general results in a decrease in particle size of materials, in the release of soluble material, and in the synthesis of new materials (clay and humus).

## 11.3 STABILITY AND WEATHERING OF SOIL MINERALS

### 11.3.1 CRYSTAL CHEMISTRY AND MINERAL PROPERTIES

The breakdown and stability of minerals are quite complex and require a complete understanding of crystal chemistry. The relative resistance of a mineral to weathering processes is determined by its internal structure. The latter depends on the strength of the atoms or ions binding their neighboring ions in the crystal lattice of the mineral. Four major types of binding forces between atoms in crystals have been reported (Evans, 1939): ionic, homopolar, metallic, and van der Waals forces. Although in many cases the structural bonds arising from interionic interactions cannot be attributed to one bond type, the bonds in the crystal structure of soil minerals are considered to be mostly ionic.

Several mineral properties are affected by the respective bond types (Table 11.1). The ionic and homopolar bonds between atoms yield hard crystals, with high melting points. On the other hand, van der Waals attraction gives rise to only weak bonds and relatively soft crystals, with low melting points.

### 11.3.2 COORDINATION THEORY AND PAULING'S RULES

In many books, the theory of crystal chemistry is perplexing. For example, a crystal structure is defined as “a three-dimensional array of anions with cations inserted in the interstices” (Carter and Norton, 2007, p. 71). The stability of such a structure, called a *coordination polyhedron*, depends on *Pauling's rule*. The major coordination polyhedra in soils are Al-octahedra and Si-tetrahedra. In

**TABLE 11.1**  
Selected Physical and Structural Properties of Minerals as Related to Bonding Type

Mineral Property	Types of Bonds			
	Ionic	Homopolar	Metallic	Van der Waals
Mechanical	Strong, hard	Strong, hard	Variable	Weak, soft
Thermal	High melting point	High melting point	Variable melting point	Low melting point
	Low thermal expansion	Low thermal expansion		High thermal expansion
Electrical	Nonconducting	Nonconducting	Conducting	Nonconducting
Optical	Variable	High refractive index	Opaque	Transparent
Structural	High coordination	Low coordination	Very high coordination	Very high coordination
	Moderately high density	Low density	High density	

nature, they often share crystal edges, faces, or vertices (points of intersects). Edge and face sharing reduce the distance between the ions in the polyhedron, and hence increase repulsion between ions with similar charges. The latter tends to destabilize the crystal structure. A major force for destabilization of an ionic crystal is considered the *Coulombic repulsion force* between cations. This nature of chemical bonds in a crystal structure was the reason for Pauling's investigation leading to the formulation of his famous rules (Pauling, 1960). For his research in crystal chemistry, Linus Pauling was awarded the Nobel Prize in chemistry in 1954. The present author tries to explain Pauling's rules below in simpler language.

The structure of soil minerals is formed by regular groupings of anions packed closely around a cation. Because most soil minerals are in oxide forms, the anions are usually oxygen atoms. The number of anions surrounding the cation is called the *coordination number* and is dependent on the respective ionic radii. A cation surrounded by three anions in an equilateral triangle configuration has a coordination number of 3. An arrangement of four anions around the cation is called a fourfold coordination. Such a crystal structure is called a *tetrahedron*. Silica tetrahedrons are examples of fourfold coordination structures. A sixfold coordination structure is a configuration with six anions around the cation, yielding an *octahedron*, such as the aluminum octahedron. With ions of larger dimensions, coordination numbers of 7 to 12 are possible.

This coordination theory in crystal structures is slightly different from that used in *complex compounds (chelates)* formed by coordination reactions involving humic acids. However, viewed from the standpoint of broad generalities, some similarities between the two types of coordination theories are present. Complex formation and chelation by coordination reactions will be discussed in Chapter 12.

Because the atomic bonds in many of the soil minerals are ionic, the crystal structure of these minerals obeys the principles of ionic crystals as formulated by *Pauling's rules* (1929, 1960).

*The first rule* states that "a coordinated polyhedron of anions is formed about each cation, with the cation–anion distance being determined by the sum of the radii, and the *coordination number* of the cation being determined by the radius ratio" (Pauling, 1960, p. 544). Not only are crystal structure and associated coordination number dependent on the size of the ions, they must, at the same time, obey the *law of electroneutrality*. A large cation, therefore, can coordinate more anions around it and still keep the anions apart. Smaller cations are capable of coordinating fewer anions. The limiting factor for each crystal arrangement is formulated by the *radius ratio* of the ions involved. The radius ratio is expressed as follows:

$$\text{Radius ratio} = r_c/r_a$$

where  $r_c$  is the radius of the cation, and  $r_a$  is the radius of the anion.

A minimum radius ratio exists for each coordination number (Table 11.2). If the radius ratio is below a minimum value, the cation can coordinate only the next smaller number of anions. For

**TABLE 11.2**  
**Relationship of Radius Ratio  $r_c/r_a$  and Coordination Number**

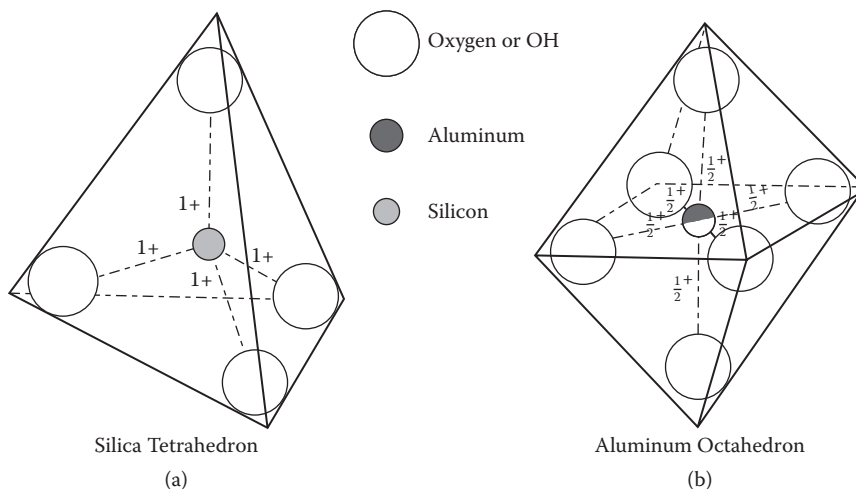
Limit Range of $r_c/r_a$	Coordination	
	Number	Crystal Geometry
0.000 to ~	1	
0.000 to ~	2	Angular
0.155 to 0.255	3	Trigonal planar
0.255 to 0.414	4	Tetrahedron
0.414 to 0.732	6	Octahedron
0.732 to 1.000	8	

example, a limit range of the radius ratio of 0.155 to 0.255 indicates that the cation in any cation–anion combination with a radius ratio  $r_c/r_a$  of 0.155 is capable of being in close association with only three anions. It will coordinate four anions if the radius ratio satisfies the value of 0.255 or larger.

It should be noted again that the values in Table 11.2 are the ranges within which the radius ratio of atoms arranged geometrically in a crystal can vary without affecting the corresponding coordination number. The absolute values of  $r_c/r_a$  ratios between any two atom pairs are generally smaller than those stated in Table 11.2. For example, the absolute radius ratio of silicon and oxygen  $r_{Si}/r_O = 0.42/1.40 = 0.300$  qualifies for a fourfold coordination. However, the absolute radius ratio of aluminum and oxygen is  $r_{Al}/r_O = 0.51/1.40 = 0.364$ . The latter does not fall within the limit range for a sixfold coordination.

*Pauling's second rule* states that “in a stable coordination structure, the total strength of the valency bonds which reach an anion from all neighboring cations equals the charge of the anion.” This rule, also known as the *electrostatic valence principle*, indicates that the charge of the cation must be shared (divided) equally by the number of bonds to the neighboring anions. At the same time, the number of these bonds depends upon the coordination number of the cation. This rule provides for a symmetric arrangement of bonds of equal strength around each cation. Applied to soil minerals, Pauling's rule results in the following arrangement of charges. In soil minerals, mostly oxides, the number of oxygen atoms normally packed around the cation is considered the coordination number. The coordination number of silicon is 4, that of aluminum may be either 4 or 6, whereas iron and magnesium have coordination numbers of 6. Potassium is a large ion and is characterized by a coordination number of 12. Because each silicon ion in the tetrahedron is surrounded by four oxygen atoms, Pauling's rule says that the bond strength is equally shared among the tetrahedral bonds; in other words, the charge of the silicon ion is divided by the number of bonds (by four). Consequently, each oxygen atom in the tetrahedron has half of its charge satisfied by the silicon to which it is bonded (Figure 11.2). The remaining unsatisfied valencies of the oxygen atoms are balanced by association with another silicon or with two  $Al^{3+}$  or  $Mg^{2+}$  ions. The sharing of an oxygen atom by two silicon ions develops the basic silicate mineral structure.

In an aluminum octahedron, the  $Al^{3+}$  ion is surrounded by six oxygen atoms. The bond strength with each oxygen atom contributed by the  $Al^{3+}$  ion is, therefore,  $3/6$  or  $1/2$ . Applying Pauling's



**FIGURE 11.2** (a) The charge of the silicon atom is shared equally with the four surrounding oxygen atoms; consequently, each oxygen has only half of its charge satisfied by the silicon. (b) The charge of the aluminum atom is shared equally with the six surrounding oxygen atoms; consequently, the bond strength contributed by the  $Al^{3+}$  ion to each oxygen atom is only half.



second rule in a similar manner,  $\text{Fe}^{2+}$  or  $\text{Mg}^{2+}$  in octahedral position will contribute only  $2/6 = 1/3$  charge to each of the oxygen atoms.

### 11.3.3 STABILITY OF MINERALS AND BOND STRENGTH

As discussed previously, the fundamental units of silicate minerals are  $\text{SiO}_4$  tetrahedrons. The latter can be joined together in several ways, and, depending upon the arrangement of these  $\text{SiO}_4$  tetrahedra, the minerals have been distinguished into cyclo-, ino-, neso-, phyllo-, soro-, and tectosilicates (see Section 6.1). A single unit or several units of tetrahedra can be linked together by other cations in the mineral framework. For example, double chains of silica tetrahedra can be linked together by Ca and Mg atoms, such as in amphiboles, or  $\text{SiO}_4$  and  $\text{AlO}_4$  tetrahedra can be linked together by alkali or alkaline earth metals located in the lattice interstices, such as in feldspars. Whatever the structural arrangement is, the Si–O–Si linkage, called the *siloxane linkage* (Sticher and Bach, 1966), requires the greatest energy to form, compared with other cation–oxygen bonds (Table 11.3). The data in Table 11.3 show that Si–O bonds are the strongest bonds, requiring 3110 to 3142 kg cal/mol for their formation. Aluminum–oxygen bonds are the next strongest (1793 to 1878 kg cal/mol needed for formation), and the bonds between the other metal ions and oxygen appear to be the weakest (299 to 919 kg cal/mol). The greater the number of Si–O bonds by linkage of increasingly larger numbers of silica tetrahedra through oxygen sharing, the greater will become the resistance to weathering. On the basis of a progressive increase of oxygen sharing between adjacent silica tetrahedra, Keller (1954) and Birkeland (1974) ranked the silicate groups as follows:

nesosilicates < inosilicates (single chain) < inosilicates (double chain) < phyllosilicates < tectosilicates

To correlate such a ranking with a corresponding increase of resistance against weathering is subject to arguments. For example, the clay minerals belonging to the phyllosilicates are more resistant to weathering than feldspar and leucite, which are tectosilicates. However, in terms of comparison between biotite (phyllosilicate) and feldspar (tectosilicate), the foregoing ranking may have

**TABLE 11.3**  
**Energy of Formation of Cation–Oxygen Bonds**

Cation	Energy of Formation (kg cal/mol)
$\text{Si}^{4+}$ (nesosilicates)	3142
$\text{Si}^{4+}$ (inosilicates, single chain)	3131
$\text{Si}^{4+}$ (inosilicates, double chain)	3127
$\text{Si}^{4+}$ (phyllosilicates)	3123
$\text{Si}^{4+}$ (tectosilicates)	3110
$\text{Al}^{3+}$ (framework)	1878
$\text{Al}^{3+}$ (nonframework)	1793
$\text{Fe}^{3+}$	0919
$\text{Mg}^{2+}$	0912
$\text{Ca}^{2+}$	0839
$\text{H}^+$ (in OH)	0515
$\text{Na}^+$	0322
$\text{K}^+$	0299

Sources: Paton, T. R. *The Formation of Soil Material*, Allen & Unwin, Boston, MA, 1978; Keller, W. D. *Am. Mineral.*, 39, 783, 1954.



some value. Apparently, susceptibility to weathering is not affected by only the mineral structure, but a number of additional factors may also play an important role in mineral breakdown, as will be discussed with the individual silicate groups.

If the foregoing assumption is valid, stating that bonds requiring the greatest energy to form will also be the most resistant to attack by weathering, the data in Table 11.3 suggest that destruction of nonframework cation–oxygen bonds, such as Mg–O and Ca–O, will be relatively easier than the decomposition of the siloxane bonds, considered to be the silicate framework bonds. Cleavage of the siloxane bonds is made possible especially by interaction with chelating substances (Sticher and Bach, 1966). After collapse of the nonframework bonds, the tetrahedra may begin to break down when aluminum is present in the tetrahedral position. Because the weaker bonds are subject to attack first, the implication is that energy requirements for weathering may be considerably less than the energy requirements for formation of the bonds. In view of these considerations, the minerals in the various silicate groups are expected to differ in the way they respond to attack by weathering:

*Cyclosilicates*—The structure of this group is characterized by six-membered hexagonal rings of silica tetrahedra linked together by cations, such as Mg, Na, or Fe. The bonds formed by the latter are the weakest spots, but because of the abundance of Si–O linkages, the minerals in this group are relatively stable.

*Inosilicates*—The inosilicate group has in its structure single-chain (pyroxenes) and double-chain (amphiboles) silica tetrahedra linked together by Ca, Mg, or Fe. Because of the presence of many weak spots provided by the Ca–O, Mg–O, or Fe–O bonds, these minerals tend to weather rapidly.

*Nesosilicates*—The minerals in this group are composed of single tetrahedra linked together by Mg or Fe. To effect a breakdown, it is considered sufficient to sever the weaker Mg–O or Fe–O bonds. Notwithstanding the bond energy considerations, susceptibility of the minerals in this group to breakdown by weathering appears to vary considerably from one mineral to another (e.g., olivine versus zircon). The tight packing of oxygen atoms known to exist in zircon makes the mineral comparatively hard. On the other hand, the looser packing of oxygens in olivine makes the mineral weather faster.

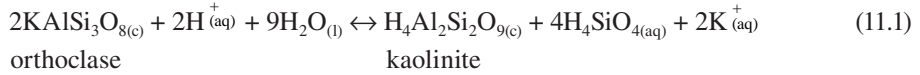
*Phyllosilicates*—Linkages of silica tetrahedral and alumina octahedral sheets by mutually shared oxygen atoms form the basis for the structure of this group. Some of the minerals (e.g., biotite and muscovite) are relatively susceptible to weathering, whereas others, like the clay minerals, are resistant weathering products, and further breakdown of clays is difficult. Disruption of the mineral usually occurs through removal (or replacement with OH) of interlayer ions, or through cleavage of Al–O bonds in tetrahedral and octahedral positions.

*Sorosilicates*—Individual and linked silica tetrahedra formed by mutually shared oxygen are the basis for the structure of this group. Consequently, they are rather difficult to decompose. However, decomposition may take place in tetrahedra in which Al has substituted for Si.

*Tectosilicates*—The minerals are considered solid solution minerals with a framework of silica tetrahedra, in which the cavities are occupied by Na, Ca, and so on. The minerals in this group may also vary considerably in their resistance to weathering (e.g., leucite and plagioclase versus potash feldspars). The relative degree of close packing of atoms in their structural framework may be the reason for such a variability in weathering. Increased substitution of Al for Si in tetrahedra of plagioclase minerals is also considered a factor that makes these minerals weaker than potash feldspars.

## 11.4 WEATHERING OF FELDSPARS AND THE SILICA POTENTIAL

An important process in chemical weathering is the decomposition of soil minerals by hydrolysis. Hydrolysis is the main decomposition reaction for feldspar minerals. This can be illustrated by the decomposition reaction of orthoclase:



By assuming the activities of orthoclase, water, and kaolinite unity, the mass action law gives:

$$K = [(\text{H}_4\text{SiO}_4)^2(\text{K}^+) / (\text{H}^+)]$$

in which K denotes the decomposition or equilibrium constant.

By taking the log, this equation becomes

$$\log K = \log [(\text{K}^+) / (\text{H}^+)] + 2 \log (\text{H}_4\text{SiO}_4) \quad (11.2)$$

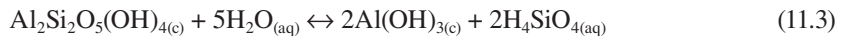
In p (–log) form, Equation 11.2 is considered the *chemical potential* determining weathering stability of orthoclase:

$$\text{pK} = 2\text{pH}_4\text{SiO}_4 - \log (\text{K}^+) / (\text{H}^+)$$

The parameter  $\text{pH}_4\text{SiO}_4$  is called the *silica potential*. The present author likes to reinforce that the use of the term *potential* is justified, though as indicated before, Chesworth (2008) objects to it. This was clearly addressed in Section 10.5. If the activity of  $\text{H}_4\text{SiO}_4$  decreases below the value of the silica potential ( $\text{pH}_4\text{SiO}_4$ ) of quartz or amorphous silica, orthoclase will decompose and form kaolinite as indicated by Equation 11.1. In an equilibrium condition, the ratio  $(\text{K}^+) / (\text{H}^+)$  is unity (Garrels and Christ, 1965), and only the activity of  $\text{H}_4\text{SiO}_4$  remains to control the stability of orthoclase.

## 11.5 WEATHERING OF KAOLINITE AND THE GIBBSITE POTENTIAL

After formation, kaolinite is also subject to decomposition and can be transformed into gibbsite by weathering. The following reaction (Kittrick, 1967, 1969; Tan et al., 1973) determines the stability of kaolinite:

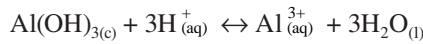


In pure condition, kaolinite, gibbsite, and  $\text{H}_2\text{O}$  are considered unity; therefore, the following relationship follows from Equation 11.3:

$$\text{pK} = 2\text{pH}_4\text{SiO}_4 \quad (11.4)$$

The assumption is made that after part of the kaolinite is converted into gibbsite, the solution soon becomes saturated relative to gibbsite. At this point, kaolinite and gibbsite exist together in equilibrium, satisfying Equation 11.3. Equation 11.4 is considered the *silica potential* determining the stability of kaolinite. Note that this pK (silica potential) has a value larger than the pK value controlling the stability of orthoclase [ $\text{pK} = 2\text{pH}_4\text{SiO}_4 - \log(\text{K}^+/\text{H}^+)$ ]. Kaolinite is stable if  $\text{pH}_4\text{SiO}_4$  is smaller than 4.73 (Tan et al., 1973).

Gibbsite, in turn, may be converted into  $\text{Al}^{3+}$ . The decomposition reaction can be written as follows:



for which is valid

$$\text{pH} - \frac{1}{3} \text{pAl}^{3+} = 2.7 \quad (11.5)$$

The expression  $\text{pH} - \frac{1}{3} \text{pAl}^{3+}$  is called the *gibbsite potential*. Again, it can be argued that this chemical potential determines the stability of gibbsite. Gibbsite is stable only if the gibbsite potential is less than 2.7 and when the activity of  $\text{H}_4\text{SiO}_4$  is very small (Kittrick, 1967, 1979; Tan et al., 1973).

All of these reactions, the decomposition of orthoclase, kaolinite, and gibbsite, called hydrolysis, are in essence a *desilicification* process, called erroneously *desilication* by other authors (see *Merriam-Webster*, 2003). The process will be discussed further in Section 11.7.1.

## 11.6 STABILITY AND PHASE RELATIONSHIPS OF SOIL MINERALS

After the stabilities of feldspar, kaolinite, gibbsite, and other soil minerals have been formulated as chemical potentials, a phase diagram can be drawn using as units of the ordinates the parameters in the equations of the chemical potentials. Such a diagram delineates the regions at which the minerals are stable and shows the points at which they are not stable and start to decompose to form another mineral. An example of such a diagram is given in Figure 11.3.

The line bordering the areas of gibbsite and kaolinite is the chemical potential as expressed by  $\text{pH}_4\text{SiO}_4 = 4.73$ . All points on this line represent conditions at which both kaolinite and gibbsite coexist in equilibrium. In the gibbsite area (to the left of the line,  $\text{pH}_4\text{SiO}_4 > 4.73$ ), the soil solution is undersaturated with  $\text{H}_4\text{SiO}_4$ , and only gibbsite is stable in such an environment. If kaolinite is present at  $\text{pH}_4\text{SiO}_4 > 4.73$ , it will automatically decompose and form gibbsite, a reaction to increase the silica concentration for restoring the equilibrium condition. In the kaolinite area (to the right of the line,  $\text{pH}_4\text{SiO}_4 < 4.73$ ), kaolinite is stable. If gibbsite is present at  $\text{pH}_4\text{SiO}_4$ , the presence of larger concentrations of  $\text{H}_4\text{SiO}_4$  will resiliate, or better silicify, gibbsite into kaolinite. A similar discussion can be given for the other lines and areas.

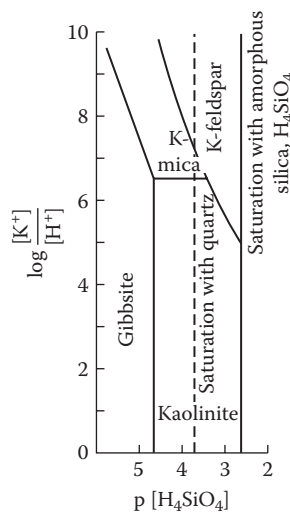


FIGURE 11.3 Stability and phase diagram of soil minerals.

Many types of stability diagrams can be made. Some are relatively simple, and others are three-dimensional, computerized, and unnecessarily complex. However, all of them have as a purpose the prediction of possible successive alteration of minerals with gradual changes in ion activity ratios as weathering proceeds.

## 11.7 BIOLOGICAL AND BIOCHEMICAL WEATHERING

Evidence has been reported and accumulated that live organisms and soil organic matter have a significant effect on weathering. The information available today indicates that the degree of weathering induced by soil organisms and soil organic compounds may be more important than that brought about by chemical reactions alone (Tan, 2009). In Section 11.2, the terms *biological* and *biochemical weathering* were introduced to recognize the increasing importance of organisms and organic matter in weathering and soil formation. However, the problem is that the effect of biological and biochemical weathering is often overshadowed by that of hydrolysis, oxidation-reduction, and other pure chemical processes. Microscopic studies are frequently required to determine the weathering effects occurring at the interfaces between live organisms and soil minerals. At first considered difficult and tedious, these studies today are becoming less complicated with the availability of electron microscopy.

An abstract, recently published in *Geochimica et Cosmochimica Acta* from an article presented in a symposium by White et al. (2005), tried to distinguish weathering into *lithogenic* and *biogenic* effects. Unfortunately, this article confuses the concept of biological weathering. The biogenic effect was explained as  $\text{Ca}^{2+}$  uptake by plants, which is more the issue of plant nutrition rather than a weathering phenomenon. The low Na/Ca ratio at the surface to 1 m deep was claimed to be the evidence for the biogenic weathering, whereas the high Na/Ca ratio at 1 m deep and below was suggested to have been affected by lithogenic weathering. In the opinion of the present author, this low Na/Ca ratio close to the surface is due more likely to leaching of  $\text{Na}^+$  ions, released from the decomposition of plagioclase, down to deeper layers. In soil science, it is common knowledge that  $\text{Na}^+$  ions are more mobile than  $\text{Ca}^{2+}$  and will move earlier than  $\text{Ca}^{2+}$  with the percolating water to deeper depth. Moreover, preferential uptake of Ca by plant roots—as indicated by White and coworkers as the prime reason—would have skyrocketed the Na/Ca ratio instead, whereas in addition, rooting media of plants seldom extend to 1 m deep. On the other hand, the high Na/Ca ratios at 1 m deep and below are then caused by accumulation of the  $\text{Na}^+$  ions migrating from above.

### 11.7.1 BIOLOGICAL WEATHERING

Until recently, biological weathering has not received the attention that it deserves as has physical and chemical weathering, yet it is an outstanding process contributing to soil formation. Without biological weathering, the surface of the earth is just a mixture of weathered rocks and minerals and by definition cannot be regarded as soil. Similar to the moon material, it is just plain *regolith* or *sap-rock*. New materials, such as clay minerals, have been formed during chemical weathering. Humus, including humic matter, is also synthesized during decomposition of organic matter. In this case, it is not customary to use the term weathering of organic matter. Humic matter is also a new material and, similar to clay, it is synthesized during pedogenesis, and as such it is an important constituent building up the soil. When live organisms have set a foothold and humus is incorporated in the weathered mass of rocks, minerals, and clays, this inorganic and organic mixture starts to become a soil. The biochemical reactions in the decomposition of organic matter and the humification process were discussed in Chapter 5 and elsewhere in detail (Stevenson, 1994; Tan, 1994, 2009).

Live soil organisms are reported to affect the dissolution of rocks and minerals and precipitation and formation of new minerals (Robert and Berthelin, 1986; Silver et al., 1986). Microbial mediation has enhanced weathering of rocks and minerals allegedly by as much as  $10^6$  folds (Huang et al., 2005), which has some merit, although this figure is somewhat exaggerated, especially in

the absence of supporting research data to corroborate such an extremely high increase. These authors, quoting a series of references, indicate that soil microorganisms are capable of dissolving minerals by indirect and direct actions under aerobic as well as anaerobic conditions. Rock and mineral dissolution by live organisms is, in fact, of general occurrence and represents phenomena of high local intensity. Bacteria, algae, and fungal and lichen hyphae are virtually glued to mineral surfaces because of the presence of a polymer interface on their bodies, composed of polysaccharide gels. Hyphae, capable of penetrating cracks deep into the rock, may separate or detach the minerals from rock surfaces. In minerals, this may cause a microdivision of the crystals. Such disintegration is believed not to be entirely a physical process, because microscopic examination has revealed white deposits of Ca-oxalate at the base of the detached minerals. This disintegration is apparently enhanced by a chemical dissolution by oxalic acid (Robert and Berthelin, 1986). The capabilities of microorganisms in the dissolution of phosphate minerals and silicates have recently been the focus of several investigations. *Pisolithus tinctorius*, an ectomycorrhizal root fungus, is known for its potential in the dissolution of insoluble phosphate compounds. When inoculated into Caribbean pine, *Pinus caribea*, the fungus increases P-uptake by the pine roots. *Glomus* sp., an endomycorrhizal fungus, is reported to increase K-uptake by soybean plants grown in a biotite medium. The fungus is believed to cause increased weathering of biotite (Mojallali and Weed, 1978). This is the mycorrhizae species that attracted a lot of attention by U.S. Department of Agriculture Agricultural Research Service (USDA-ARS) scientists for its production of *glomalin*, a glycoprotein, much acclaimed as the superglue of the century in soil aggregation (Comis, 2002). (See Section 5.3.1.) The weathering of soil minerals by the root system is apparently not limited to dissolution reactions only. Other modes of reactions are direct enzymatic oxidation or reduction of mineral components, and indirect attack by metabolically produced chemical agents and ligands (Huang et al., 2005). It was reported by several authors that the root system of many plants has induced the transformation of biotite into vermiculite (Mortland et al., 1956) and kaolinite (Spyridakis et al., 1967). Robert and Berthelin (1986) suspect that the rhizospheric nonsymbiotic and symbiotic microorganisms are responsible for this transformation. The rhizosphere is known to be the place where microorganisms congregate, and where most likely biochemical reactions are active for mineral weathering and concentration.

Precipitation of soil elements and formation of new minerals by live organisms have now received increasing research attention with the easy access in electron microscopy. Calcite microcrystals have been detected at the surface of hyphae and roots, growing on carbonate rocks. They are even noticed as fine needles inside the hyphae and the epidermal root cells. After the organisms die, the calcite crystals may give rise to formation of cytomorphic sands (Robert and Berthelin, 1986). Ca-oxalate in soils is always considered a biological product. Plant roots, lichens, and fungus can also concentrate and precipitate Fe. The presence of ferrihydrite in lichens growing on basalt is regarded by many as strong evidence that precipitation of Fe is a biological process. Iron accumulation and oxidation by the roots of rice plants have been connected to formation of goethite and lepidocrocite found inside and outside the epidermal cells of rice roots. According to Silver et al. (1986), microbial oxidation of Fe occurs as a *nonenzymatic* (indirect) or as an *enzymatic* (direct) process. The nonenzymatic process takes place in aerobic soils at pH 5.2, whereas the enzymatic process is caused by rod-shaped *Thiobacilli* sp. and curved rod-shaped *Leptospirillum* sp. These organisms thrive only in an environment with pH 2.5 to 3.5 and can use ferrous iron as an energy source and CO<sub>2</sub> as their carbon source. Biological processes have also been implicated in the reduction processes of Fe<sub>2</sub>S and S compounds as discussed in Chapter 9. The microbial reduction of Fe<sub>2</sub>S, yielding H<sub>2</sub>S, is an important process in the cycle of conversion of pyrite into jarosite in soils of coastal regions affected by the tide. When the tide recedes, *aerobiosis* takes place, a process enabling the bacteria *T. ferrooxidans* to convert pyrite into the mineral jarosite, KFe<sub>3</sub>(SO<sub>4</sub>)<sub>2</sub>(OH)<sub>6</sub>. However, when the soil is submerged again by the tide for a long period of time, *anaerobiosis* occurs. The H<sub>2</sub>S, produced by the bacteria *D. desulfuricans*, is then used for conversion of the jarosite into pyrite (Silver et al., 1986).

### 11.7.2 BIOCHEMICAL WEATHERING

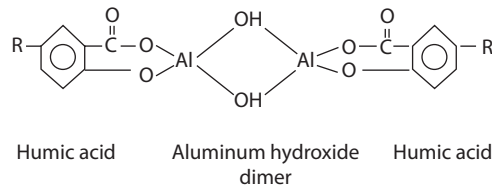
As defined in Section 11.2, biochemical weathering is mineral weathering due to interactions of rocks and minerals with organic substances produced during decomposition of soil organic matter, or to reactions with organic compounds secreted by soil organisms. A variety of organic compounds can be produced by soil organisms, and some of them may have been released constantly into the soil as root exudates or secretions. They are generally low molecular weight compounds, and many of them are organic acids. However, by decomposition of plant and animal tissue, more complex organic acids are released and synthesized. These acids may range from the nonhumified simple aliphatic, aromatic, and heterocyclic acids to the very complex humified organic acids, such as humic and fulvic acids.

The effectiveness of these organic acids in mineral degradation depends on a number of factors, among which are the concentration and chemical reactivity of the acids. By sheer concentration, humic and fulvic acids, forming the bulk of soil humus, are more important than the nonhumified organic acids. Many of the nonhumified organic acids may chemically be as effective as humic matter, but due to their presence in minor concentrations, their effect is overshadowed by that of humic and fulvic acids (Tan, 1986). In laboratory analysis, simple organic acids, such as salicylic acids and oxalic acids, exhibit the same degree of dissolution of silicate minerals as humic acids (Stevenson, 1994). On the basis of chemical reactivity, the organic acids can be distinguished into two groups: (1) organic acids in which the acidic characteristics are attributed only to the presence of carboxyl,  $-\text{COOH}$ , groups; and (2) organic acids in which the acidic characteristics are attributed to carboxyl and phenolic- $\text{OH}$  groups. Examples of the first category of acids are formic, acetic, and oxalic acids. Although they may exhibit a complexing capacity, their effect on mineral weathering is generally through the acidic ( $\text{H}^+$  ions) effect. Many display dissociation constants that are comparable to strong acids. The second group of organic acids includes humic and fulvic acids and a number of the more complex nonhumified organic acids. By virtue of the presence of carboxyl,  $-\text{COOH}$ , and phenolic- $\text{OH}$  groups in their molecules, they have the advantage over simple organic acids by being able to exert an acidic and an interaction effect. The interactions can be in the form of (1) electrostatic attraction, (2) complex reaction or chelation, and (3) coadsorption or water and metal bridging. These reactions were discussed in Chapter 4.

Today's data indicate that the acidity and chelating capacity of the organic acids bring about the degradation of many rocks and minerals (Schnitzer and Kodama, 1976; Tan, 1976a, 1978a, 1980, 2009). They may be able to pry loose structural Al and Fe from micas, feldspars, and kaolinite, or any other soil mineral, thereby accelerating the decomposition process. The organic chelating agent may perhaps react with an exposed cation, followed by movement of the complex compound or chelate into solution. As a chelate, Al and other metals are rendered soluble over a pH range in which these metals are normally insoluble. Such a release of metal cations in the form of chelates or complexes has an important bearing in soil formation and nutrient supply to plant roots. Not only will the mobilization and precipitation of the metal chelates result in horizon differentiation giving rise to different kind of soils, but depending on stability, such chelates are believed to provide the carrier mechanism by which depleted nutrients at root surfaces can be replenished.

Recently, indications have been presented that the organic acids can enhance or inhibit formation of clay minerals. Formation of imogolite and allophane in laboratory conditions appears to be inhibited by the presence of citric, tannic, malic, tartaric, salicylic, humic, and fulvic acids (Huang et al., 2005; Huang and Violante, 1986). Hydrolysis and polymerization of aluminum hydroxide compounds are also harmfully affected by citric acid. Kwong and Huang (1975, 1977) and Huang and Violante (1986) postulate that the organic acid occupies coordination sites of dimeric aluminum hydroxides, preventing in this way further polymerization and hydrolysis of the dimers. The interaction process, as illustrated in Figure 11.4, shows that the attachment of the organic ligand to the aluminum hydroxide dimer terminates the hydroxyl bridging mechanism necessary for further polymerization of the aluminum compound. Huang and Violante (1986) also argue that within a





**FIGURE 11.4** Interaction between humic acid and aluminum hydroxide dimer.

certain range of organic ligand/Al ratios, the organic acids favor the formation of pseudoboehmite. They believe that these organic acids are far more effective than inorganic ligands in inducing formation of short-ranged ordered clay minerals, such as pseudoboehmite and allophane.

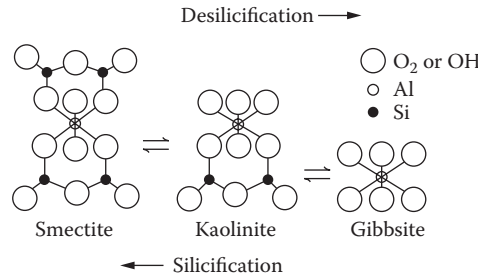
## 11.8 SOIL FORMATION PROCESSES OR PEDOGENESIS

The process of soil formation, or pedogenesis, is a complex biological and chemical problem and is usually difficult to describe with a single reaction. Reactions may occur simultaneously, or a sequence of reactions one after another is involved. Simonsen (1959) stated that the pedon is formed by the combined actions of additions of inorganic and organic materials to the surface, transformation of compounds within the soil, vertical transfer of soil constituents within the soil, and removal of soil components from the soil. The pedon created exhibits specific series of soil layers, called *soil horizons*, from the surface down to the parent materials. Collectively, the series of soil horizons makes up a *soil profile* (see Figure 11.1, and Tan, 2009). The various types of soil formation processes involved vary according to the conditions. However, it is not the purpose of this book to list them in this chapter. For a list of the various processes of soil formation, refer to Buol et al. (1973) and Tan (2008). It is perhaps more important and in line with the title of this book, *Principles of Soil Chemistry*, to discuss major soil forming processes with general applicability to the development of pedons, such as desilicification and translocation of Al, Fe, and clay related to the formation of argillic, albic, spodic, and oxic horizons.

### 11.8.1 DESILICIFICATION

The proper term according to the *Webster New Collegiate Dictionary* is *desilicification*, though several scientists use *desilication* (Buol et al., 1973; Chesworth, 2008). To *silicify*—and not to *silicate*—is to convert into or impregnate with silica. Desilicification is a process in which silica is released from soil silicates. This silica does not originate from quartz minerals as assumed by Chesworth (2008), but it is more likely released by decomposition of the more weatherable silicate minerals, such as feldspars and plagioclase. Part of the released silica reacts with alumina to form clays, whereas the remainder is subject to leaching. Consequently, the soil exhibits a loss of silica and at the same time, has a residual accumulation of Fe and Al as stable weathering products, including sesquioxides. This process may occur in the tropics or in the temperate regions in the presence of sufficient amounts of moisture and the right temperature. Usually it is more pronounced in the humid tropics. In the past, the process was known as *laterization* or *ferralitization* and was considered the main reason for formation of *lateritic soils*—some call them *ferralitic soils*, soils rich in Fe and Al—*laterites* and *bauxites*. Next to a warm humid climate, another important requirement for desilicification is a perfectly well-drained environment for the ease of leaching and removal of silica. The reactions can be illustrated with the decomposition of orthoclase into kaolinite (see Equation 11.1) and with the decomposition of kaolinite into gibbsite (see Equation 11.3). If the soil is well drained and permeability is rapid, the activities of dissolved ions and  $\text{H}_4\text{SiO}_4$  are kept low by rapid leaching. The end product of weathering will then be gibbsite. Over geologic time periods, a continued desilicification process will ultimately transform the minerals into bauxite. Under

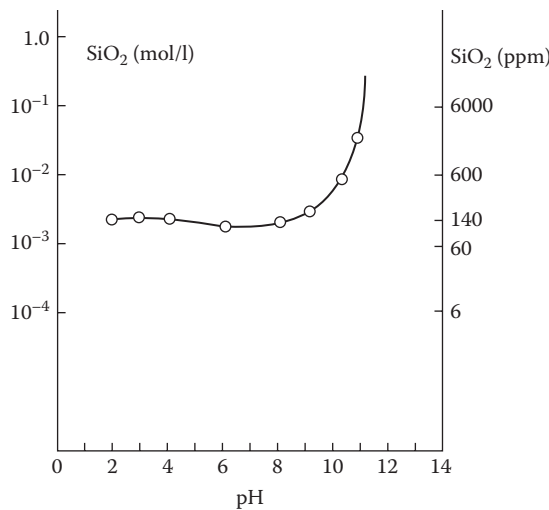




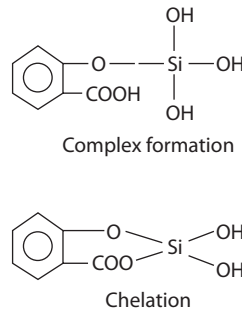
**FIGURE 11.5** Desilicification and silicification in soils of major clay minerals.

poor drainage conditions and low permeability, leaching is inhibited, and silica will not be leached. The latter results in an increase in  $H_4SiO_4$  activity and  $K^+/H^+$  ratio, leading to formation of smectites and illites (Van Schuylenborgh, 1971). This process is called *silicification*. Under changing physicochemical conditions, smectite can be converted into kaolinite, and kaolinite into smectite by desilicification and silicification, respectively. These processes, also referred to as *transformation* (Singer, 1979), can be illustrated as in Figure 11.5.

The degree to which Si can be leached out of soil depends on its capacity to remain in solution. The solubility of silica is determined by the law of polymerization. Present in concentrations below 140 ppm  $SiO_2$  (25°C), silica is found mainly in the form of monosilicic acid,  $Si(OH)_4$ , which is considered a true solution (Krauskopf, 1956; Millot, 1970). The solubility of this silica remains constant at 140 mg/L in the range of pH 2 to 9, but at pH values above nine, the solubility of silica increases rapidly (Figure 11.6). If the concentration of silica in the solution exceeds 140 ppm, polymerization of silica occurs, and usually a mixture of polymers and monomers of  $Si(OH)_4$  is found in the soil solution. The polymers will be precipitated by the introduction of small quantities of Al, or by decreasing pH (Paton, 1978), leaving the monomers in solution, which may tend to be leached out of the system if conditions are favorable. Polymerization of silica monomers can be prevented by interaction with humic acids. Monosilicic acids are known to form complexes with soil organic compounds, especially with humic and fulvic acids. The complexation process can be illustrated by the reactions in Figure 11.7. The Si–O bond serves as a bridge between humic acid molecules. These



**FIGURE 11.6** Solubility of silica as related to pH. (Reprinted from Krauskopf, K. B., *Geochim. Cosmochim. Acta*, 10, 1–26, 1956. Copyright 1956, with permission from Elsevier.)



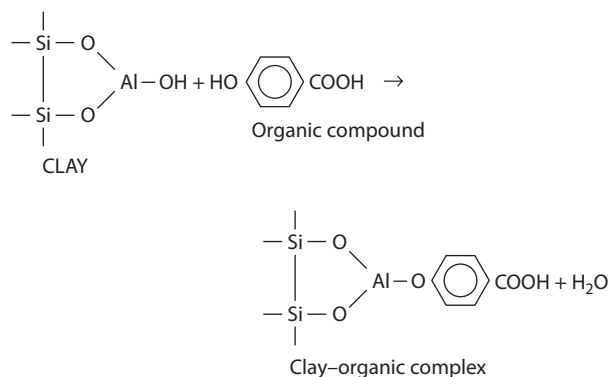
**FIGURE 11.7** Complex formation and chelation between monosilicic acid and humic acid.

reactions play, of course, a significant role in the weathering of rocks and minerals, as discussed above in the section on biochemical weathering. The high affinity of humic acids for Si and metal ions brings about the degradation of rocks and minerals. The subsequent release of Si in the form of complexes or chelates has an important bearing in soil formation due to movement of Si in the pedon. As a chelate, silica is prevented from polymerization and remains soluble. It is then free to move with the percolating water, a process enhancing the desilicification process. This is perhaps the reason why silica and organic matter are lost in the formation of oxisols by a process formerly called *laterization*. It explains the low silica/sesquioxide ratios and low organic matter contents in Oxisols.

### 11.8.2 TRANSLOCATION OF CLAYS

The process of clay translocation leads to enrichment of B horizons with clays. Such B horizons are called *argillic* (Bt) horizons or *textural B horizons* in the U.S. Soil Taxonomy. In some textbooks, the process is also called *lessivage* (Buol et al., 1973). The clays have migrated from the A to the B horizon because of an increase in peptization. According to Zaidel'man (2007), for lessivage to take place, the soil must not have hydrological barriers for movement of water and mass transfer down the profile. The author above also indicates that lessivage plays an important role in podzolization and gleization processes.

Evidence was presented that clays and organic matter can form complexes (Greenland, 1971; Tan, 1976a). Although the exact mechanism is not yet known, the hypothetical reaction, as shown in Figure 11.8, serves as an example. This reaction adds an acidic group (COOH) to the clay surface and contributes a strong negative charge to the clay. The surface potential of the clay–organic complex is, therefore, larger than that of the clay alone. Consequently, the electrokinetic potential, formerly explained with the zeta ( $\zeta$ ) potential, also becomes larger. As a clay–organic complex, the clay remains suspended for a longer time and moves downward with the percolating water.



**FIGURE 11.8** Complex formation of clay with humic acid.

**TABLE 11.4**  
**Solubility Constants of Fe Compounds**

Fe Compound	Solubility Constant
$\text{Fe(OH)}_3$ amorphous $\leftrightarrow \text{Fe}^{3+} + 3\text{OH}^-$	$\text{pK} = \text{pFe} + 3\text{pOH} = 38.2$
$\text{Fe(OH)}_3$ amorphous $\leftrightarrow \text{Fe(OH)}^{2+} + 2\text{OH}^-$	$\text{pK} = \text{pFe(OH)} + 2\text{pOH} = 26.3$
$\text{Fe(OH)}_3$ amorphous $\leftrightarrow \text{Fe(OH)}_2^+ + \text{OH}^-$	$\text{pK} = \text{pFe(OH)}_2 + \text{pOH} = 17.0$
Goethite	$\text{pK} = 45.2$
Lepidocrocite	$\text{pK} = 42.5$
Hematite	$\text{pK} = 42.5$
Maghemite	$\text{pK} = 41.0$

Source: Van Schuylenborgh, Syllabus of Lectures for Postgraduate Training, Agriculture University, Wageningen, The Netherlands, 1966.

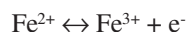
Several reactions are responsible for clay accumulation in the B horizon. The movement stops where the percolating water stops, resulting in flocculation of clay. Capillary withdrawal of water into the soil fabric deposits clay as clay skins, *argillans*, on the walls of pores and peds.

### 11.8.3 TRANSLOCATION OF ALUMINUM AND IRON

The downward movement of Al and Fe together with organic matter results in formation of *albic* (E) and *spodic* (Bhs) horizons. This process was called *podzolization* in the past. It gives rise to formation of spodosols (podzols). Several pedologists believe that podzols are formed by *lessivage*. This soil formation process explains the formation of Bt horizons but does not justify the translocation of Al, Fe, and organic matter, necessary for the development of spodic horizons or formation of podzols.

Most of the Fe subject to translocation comes from the decomposition of biotite and ferromagnesian minerals. The possible ionic forms of Fe(III) are  $\text{Fe}^{3+}$ ,  $\text{Fe(OH)}^{2+}$ ,  $\text{Fe(OH)}_2^+$ ,  $\text{Fe}_2(\text{OH})^{4+}$ , and  $\text{Fe(OH)}_4^-$  (Van Schuylenborgh, 1966). The ionic forms of Fe(II)—for example,  $\text{Fe}^{2+}$ ,  $\text{Fe(OH)}^+$ , and  $\text{Fe(OH)}_3^-$ —are less stable than those of Fe(III). Most of the soils in which translocation occurs are well drained. Therefore, most of the iron is in Fe(III) ionic form. The concentration of the Fe ions depends on the solubility of their respective solid phase. Solubility constants of some of the iron compounds in soils are listed in Table 11.4.

The assumption was made in the previous section that in well-drained soils the iron is in Fe(III) form. However, whether Fe(III) or Fe(II) occurs under natural soil conditions depends more precisely on the oxidation potential. If the following redox reaction of iron is studied:



then

$$\text{K} = [\text{Fe}^{3+}]/[\text{Fe}^{2+}]$$

Application of the Nernst equation gives the following relation:

$$E_h = E^\circ + \frac{RT}{nF} \ln K$$

or

$$E_h = E^\circ + 0.059 \log[\text{Fe}^{3+}]/[\text{Fe}^{2+}]$$

in which  $E_h$  is called the *oxidation potential*. After complete oxidation of Fe(II) to Fe(III), the concentration of Fe(II) ions becomes negligible and can be neglected so that the relationship changes into:

$$E_h = E^\circ + 0.059 \log[\text{Fe}^{3+}]$$

If, however, reduction processes prevail, the activity of Fe(II) becomes very large, so that for all practical purposes, the activity of Fe(III) can be neglected. The oxidation potential assumes then the following relation:

$$E_h = E^\circ - 0.059 \log[\text{Fe}^{2+}]/[\text{Fe}^{3+}]$$

$$[\text{Fe}^{3+}] = \text{negligible}$$

$$E_h = E^\circ - 0.059 \log[\text{Fe}^{2+}]$$

Therefore, the oxidation potential  $E_h$  increases upon oxidation and decreases as a result of reduction processes. When the activity of Fe(III) equals that of Fe(II), the oxidation potential also equals the standard oxidation potential,  $E^\circ$ :

$$[\text{Fe}^{3+}] = [\text{Fe}^{2+}] \rightarrow E_h = E^\circ$$

With the use of these oxidation potentials and pH values, several stability fields of Fe(II) and Fe(III) systems were developed by various authors (Garrels and Christ, 1965; Hem and Cropper, 1959). An example is given in Figure 11.9. From the diagram in Figure 11.9, it can be noticed that Fe(II) ions are stable at oxidation potentials below  $E_h = 0.3$ , if soil pH is 5 to 7. Only if the soil reaction is strongly acid will Fe(II) ions remain stable at  $E_h > 0.3$ . The natural condition is represented by the shaded portion in Figure 11.9. A major part of this shaded area (b) lies in the stable field of ferric hydroxide,  $\text{Fe}(\text{OH})_2^+$ , compounds. Hem and Cropper (1959) indicated that Fe(II) ions remain soluble at concentrations not to exceed 100 ppm ( $E_h = 0.3$  and pH = 5). For further discussion and a detailed treatise on the principles of redox potentials, see Chapter 3 and Section 11.8.

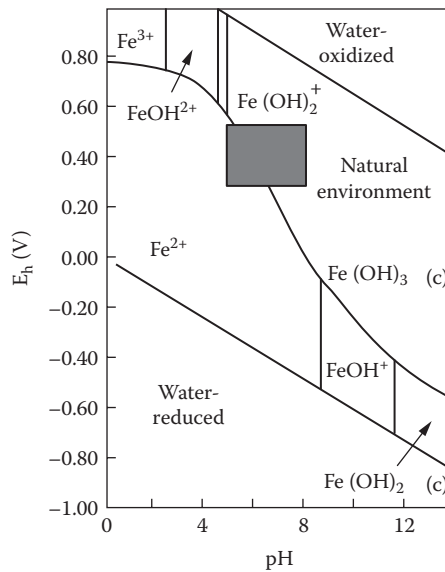
Almost all silicates are sources for Al. The ionic forms of Al(III) are  $\text{Al}^{3+}$ ,  $\text{Al}(\text{OH})_2^+$ ,  $\text{Al}(\text{OH})_2^+$ ,  $\text{Al}(\text{OH})_4^-$ ,  $\text{Al}_2(\text{OH})_4^{2+}$ ,  $\text{Al}_2(\text{OH})_4^{2+}$ ,  $\text{Al}_4(\text{OH})_{10}^{2+}$ , and  $\text{Al}_6(\text{OH})_{12}^{6+}$  (Van Schuylenborgh, 1966). As with iron, the concentration of the various Al ions is also dependent on the solubility of their respective solid forms. Solubility constants of some of the aluminum hydroxide compounds are listed in Table 11.5. These data show that most of the solubility constants (pK values) of Al and Fe compounds are very large, which means that the solubilities are expected to be low. For example, let us calculate the number of  $\text{Al}^{3+}$  ions produced by the dissociation reaction of amorphous  $\text{Al}(\text{OH})_3$ , as listed in Table 11.5 on the first line, in a soil with pH 4:

$$\text{pH} + \text{pOH} = 14$$

Therefore,

$$\text{pOH} = 14 - 4 = 10$$

Substituting this pOH value in  $\text{pK} = \text{pAl} + 3\text{pOH} = 32$ , gives:



**FIGURE 11.9** Stability field diagram for aqueous Fe(III)–Fe(II) systems. (Adapted from Hem, J. D., and W. H. Cropper, U.S. Geological Survey Water Supply Paper 1459A, 1959; Garrels, R. M., and C. L. Christ, *Solutions, Minerals, and Equilibria*, Harper & Row, NY, 1965.)

$$\text{pAl} + (3 \times 10) = 32$$

$$\text{pAl} = 32 - 30 = 2$$

or

$$-\log \text{Al} = 2$$

$$\text{Al}^{3+} = 10^{-2} \text{ moles/L}$$

Such a value for  $\text{Al}^{3+}$  ion concentration is quite high, indicating that amorphous  $\text{Al}(\text{OH})_3$  with a  $\text{pK} = 32$  is not that insoluble. It agrees with the concept that strongly acidic soils ( $\text{pH} = 4$ ) contain large amounts of Al. However, when similar calculations are made for  $\text{Fe}(\text{OH})_3$  with a  $\text{pK} = 38.2$ , an Fe concentration of  $1 \times 10^{-8.2}$  moles/L is obtained for a soil with  $\text{pH} = 4$ . This is a very low concentration of iron.

According to textbooks, theoretically, the lower is the  $\text{pK}$  value, the more soluble the compounds are expected to be. However, it appears that amorphous  $\text{Al}(\text{OH})_3$ , with a  $\text{pK} = 14.1$ , produces smaller amounts ( $1 \times 10^{-4.1} M$ ) of Al than  $\text{Al}(\text{OH})_3$  with a  $\text{pK} = 32$  in soils with  $\text{pH} = 4$ . This is quite surprising and creates a lot of questions. One can argue, of course, that in the case of  $\text{Al}(\text{OH})_3$  ( $\text{pK} = 14.1$ ), the Al ions are in the form of  $\text{Al}(\text{OH})_2^+$ , which is less soluble than  $\text{Al}^{3+}$ , or that the  $\text{pK}$  values presented by Van Schuylenborgh (1966) are too low.

The general consensus is that the  $\text{pH}$  range in many soils is such that most Al and Fe compounds are essentially insoluble. Therefore, the possibility of migration of Al and Fe in the ionic forms shown is very small. Other agents are required to make Al and Fe more soluble.

Evidence has been presented showing that decomposition products of soil organic matter, and especially of humic acids (Hodgson, 1969; Martin and Reeve, 1960a, 1960b; Tan, 1978a), are capable of solubilizing the insoluble compounds by complexing the Al and Fe. The complexation and chelation reactions have been discussed in the section of humic acids in Chapter 5. As a complex or

**TABLE 11.5**  
**Solubility Constants of Al Compounds**

Al Compound	Solubility Constant
$\text{Al(OH)}_3$ amorphous $\leftrightarrow \text{Al}^{3+} + 3\text{OH}^-$	$\text{pK} = \text{pAl} + 3\text{pOH} = 32$
$\text{Al(OH)}_3$ amorphous $\leftrightarrow \text{Al(OH)}^{2+} + 2\text{OH}^-$	$\text{pK} = \text{pAlOH} + 2\text{pOH} = 23.4$
$\text{Al(OH)}_3$ amorphous $\leftrightarrow \text{Al(OH)}_2^+ + \text{OH}^-$	$\text{pK} = \text{pAl(OH)}_2 + \text{pOH} = 14.1$
Gibbsite	$\text{pK} = 36.2(\text{Al}^{3+})$
Gibbsite in $\text{H}_2\text{O}$	$\text{pK} = 14.6(\text{Al}[\text{OH}]_4^-)$
Gibbsite in base	$\text{pK} = 0.579\text{Al}[\text{OH}]_4^-)$

Source: Van Schuylenborgh, J. Syllabus of Lectures for Postgraduate Training, Agriculture University, Wageningen, The Netherlands, 1966.

chelate, Al and Fe may remain soluble at pH ranges that make them usually insoluble. Stability and mobility of these complexes depend also on the metal concentration in the soil solution. If the Al or Fe concentration is low, complexes will be formed in the A horizon with low metal/organic ligand ratios. In this case, the amount of Al or Fe chelated is insufficient to cause immobilization of the metal–organo compound, and the complex or chelate may then move down the pedon (De Coninck, 1980). During the downward migration, the chelates may pick up more of the polyvalent cations, which results in a progressive decrease of their net negative charges. The presence of a higher metal ion concentration in the subsoil, or an acidity different from that in the A horizon, may eventually neutralize the remaining charges. The consequent precipitation of the chelates in the B horizon gives rise to the development of *spodic* (Bhs) horizons, diagnostic for Spodosols (Podzols).

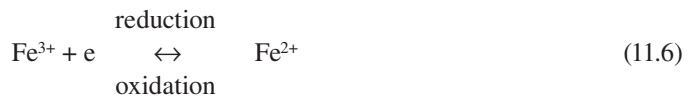
Metal–organo complexes also tend to disperse easily at low electrolyte concentration, enhancing their movement downward to deeper layers in the pedon. The loss of Al, Fe, and organic matter from the A horizon leads to formation of *albic* (E) horizons.

Because the solubility constants (pK values) of Al and Al-organic complexes are generally smaller than those of Fe and Fe-organic complexes, the Al-organic complexes are more soluble than the Fe-organic complexes. Consequently, Al-organic complexes may move earlier and also deeper into the pedon than the Fe-organic complexes. In the B horizon, these compounds can be precipitated and accumulated by (1) formation of insoluble complexes due to saturation with additional Al and Fe, (2) hydrolysis of metal complexes, (3) microbial attack of the organic ligands (Van Schuylenborgh, 1965), or (4) a combination of these processes.

## 11.9 OXIDATION AND REDUCTION REACTION IN SOILS

Reduction and oxidation, or *redox* reactions, occur in almost any soil and have not been regarded or emphasized as very important soil-forming processes. Redox reactions contribute to formation of *plinthite* and *gley* horizons. Gleying is, especially, significant in poorly drained soils, such as the *paddy soils* where inundation of the soil is a required operation for the cultivation of lowland rice (Tan, 1968, 2008).

*Reduction* is, by definition, the gain of electrons, whereas *oxidation* is the loss of electrons. This was illustrated in Chapter 3 on principles of electrode potentials by the classical reaction as follows:



Oxidation reactions usually occur in well-drained soils. On the other hand, reduction processes are more likely to be predominant in poorly drained soils, or where excess water is present. As indicated earlier, the latter develops gley horizons.

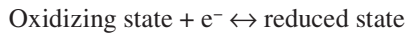
Usually known as the *soil redox state*, this condition occurs in almost any soil. Both reduction and oxidation conditions can occur simultaneously in the pedon. The surface layers of the pedon are in an oxidized state, and the subsoil layers may be in a reduced condition due to a fluctuating groundwater level. The latter may lead to *pseudogley* formation or to *plinthization*.

The redox condition of soils affects the stability of iron and manganese compounds. To a certain extent, microbial activity and accumulation and decomposition of organic matter are also affected by the soil redox state. Fresh organic matter is thought to aid formation of reduced condition. Bloomfield (1951, 1953) reported that aqueous leaf extracts reduced Fe(III) into Fe(II) in soils. The mobilization of Fe and Mn, due to redox conditions and subsequent formation of Fe- and Mn-organo chelates, have been reported to give rise to formation of *iron-B* followed by a *manganese-B horizon* in paddy soils (Tan, 1968). In tidal floodwater areas, reduction processes play a considerable role in the formation of sulfur-rich soils. These soils are generally very strongly acid in reaction as discussed in Chapter 10.

Soils with different redox conditions may react differently upon N fertilization. In well-drained soils, ammonium N is subject to nitrification and converted into nitrates ( $\text{NO}_3^-$ ). However, if the ammonium fertilizer is applied to a *reduced* soil, such as to *lowland rice* or *paddy soils*, it remains available as ammonium ( $\text{NH}_4^+$ ).

### 11.9.1 REDOX POTENTIALS

As addressed in Chapter 3, the potential of a half-cell reaction for a system as illustrated by Equation 11.6 is called the *electrode potential*. The half-cell reaction can be written in a general expression as follows:



The corresponding half-cell potential for this generalized reaction obeys the Nernst equation:

$$E_h = E^\circ + (RT/nF)\log(\text{oxidized state})/(\text{reduced state}) \quad (11.7)$$

$E_h$  is now called the *redox potential*. It is the half-cell potential relative to a standard reference electrode.  $E^\circ$  is a constant, called the *standard redox potential* of the system, and  $RT/F$  equals 0.0592 at 25°C (see Chapter 3, and Garrels and Christ, 1965). If the activities of the oxidized and reduced species are unity, the ratio becomes 1, and the log equals 0, and hence  $E_h$  equals  $E^\circ$ . Therefore, the *standard redox potential* is defined as the redox potential of the system at which the activities of oxidized and reduced species are unity.

### 11.9.2 REDOX REACTION LIMITS IN SOILS AND THE $E_h$ -pH RELATION

The principles of redox reactions and redox potentials can be used for the determination of the limits of the redox status in soils. As indicated in Chapter 3, the stability of water imposes limits on the soil's redox potential. The upper limit in aqueous systems is the decomposition of water into oxygen gas (Garrels and Christ, 1965):



The oxidation potential,  $E_h$ , of this reaction is then:



$$E_h = E^\circ + [1/4(0.059)] \log [(P_{O_2})(H^+)^4]/(H_2O)^2 \quad (11.9)$$

where  $P_{O_2}$  is the partial pressure of  $O_2$  gas in atm.

In reactions involving gas, it replaces the use of concentration units. Because under standard conditions  $P_{O_2}$  equals 1 atm, and the activity of pure  $H_2O$  is unity, the oxidation potential changes into:

$$E_h = E^\circ + 0.059 \log (H^+)$$

or

$$E_h = E^\circ - 0.059 \text{pH} \quad (11.10)$$

The lowest limit of the redox potential is considered the dissociation of water into hydrogen ions that eventually convert into  $H_2$  gas. This process can be illustrated by the following reaction:

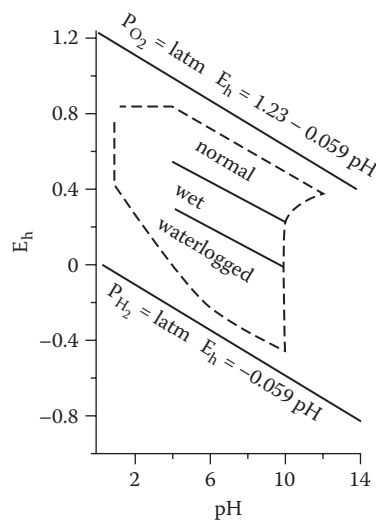


The reduction potential for this reaction is then written in a similar way as:

$$E_h = E^\circ + [(0.059)/2] \log [(H^+)^2]/P_{H_2} \quad (11.12)$$

Because at standard conditions the partial pressure of  $H_2$  gas,  $P_{H_2}$ , equals 1 atm, Equation 11.12 can be changed to assume a relationship similar to Equation 11.10.

At the upper limit, the standard redox potential,  $E^\circ$  equals 1.23 V. This value is derived from calculations using figures of standard free energy changes of formation of the products and reactant in Equation 11.8. At the lowest limit, the standard redox potential,  $E^\circ$  equals 0. The two potentials plotted against pH, producing an  $E_h$ -pH relation, delineate the redox region or equilibrium limits within which water is stable in soils (Figure 11.10). The regression line posing as the upper boundary of the stability of water has an intercept equal to 1.23 V, whereas the regression line representing the lowest boundary for the stability of water has an intercept equal to 0 V. Therefore, at the regression curve, represented by  $E_h = 1.23 - 0.059 \text{pH}$ , water is in equilibrium with  $O_2$ . Water present



**FIGURE 11.10** Stability limits of water as a function of redox potential ( $E_h$  in volts) and pH. Dotted line delineates redox limits of soils and microorganisms.

above this top line will decompose rapidly into  $O_2$  gas. At the regression curve, represented by  $E_h$  equals  $-0.059\text{pH}$ , water is in equilibrium with  $H_2$  gas, and water present below this bottom line will be dissociated into  $H^+$  ions and the latter into  $H_2$  gas.

### 11.9.3 THE $pe$ - $pH$ RELATION

Because electrode potentials can also be expressed in terms of  $pe$ , replacement of the  $E_h$  values on the Y axis (Figure 11.10) with the corresponding  $pe$  values (see Section 3.5.2 for conversion of  $E_h$  into  $pe$ ) produces a  $pe$ - $pH$  diagram without changing the principles or interpretation of the  $E_h$ - $pH$  diagram. The equations representing the borders of stability of soil water, however, change according to the numerical  $pe$  values used on the Y axis. For the highest limit of the redox potential, Equation 11.10 converts into:

$$pe = 20.8 - 1.01pH \quad (11.13)$$

This equation represents the equilibrium of water and oxygen at a partial pressure of 1 atm. The  $pe$ - $pH$  linear curve has an intercept at 20.8 (the equivalent of 1.23 V in the  $E_h$ - $pH$  diagram) and a slope equal to 1.01 (equivalent to 0.059 V in the  $E_h$ - $pH$  diagram). The lowest limit of the redox potential for the redox stability of water is then represented by:

$$pe = -1.01pH \quad (11.14)$$

This equation replaces  $E_h = -0.059pH$ .

It is now evident that water in equilibrium with atmospheric  $O_2$  is defined by  $pe^0 = 20.8$ . At this  $pe$  level, most of the elements in soils are expected to exist in their highest oxidation states. Carbon, C, will be present as  $CO_2$ ,  $CO_3^{2-}$ , or as  $HCO_3^-$ ; N as  $NO_3^-$  and  $NO_2^-$ ; Fe as  $FeOOH$ ,  $Fe_2O_3$ , or  $Fe^{3+}$ ; Mn as  $MnO_2$ , though some  $Mn^{2+}$  may be present; and S mainly as  $SO_4^{2-}$ . The lower oxidation states and the reduced forms are present only in very small amounts. At  $pe^0 = 0$ , water is then in equilibrium with  $H_2$  gas, and at this  $pe$  level, the elements discussed above will exist mostly in their highest reduced forms.

Whether to use the  $E_h$ - $pH$  or  $pe$ - $pH$  diagram is left to the reader's preference. Both convey the same principles, but  $E_h$  can be measured with a Pt electrode and a voltmeter or pH meter, whereas  $pe$  can be calculated only by using Equation 3.13, after the  $E_h$  value has been determined.

### 11.9.4 THE IMPORTANCE OF $E_h$ - $pH$ OR $pe$ - $pH$ RELATIONS IN SOIL AND BIOLOGICAL SYSTEMS

The area within the dotted line (Figure 11.10) is, according to Baas Becking et al. (1960), the range of redox potentials of soils. It can be divided into three subregions with  $E_h$  or  $pe$  values characteristic for normal, wet, and waterlogged soils, respectively (Bohn et al., 1979). These soils are called *oxic*, *suboxic*, and *anoxic* soils, respectively, by Sposito (1989). At pH 7, normal or oxic soil is characterized by  $E_h > 413$  mV ( $pe > 7$ ), wet or suboxic soil by  $E_h = 413$  to 118 mV ( $pe = 7$  to 2), and waterlogged or anoxic soil by  $E_h < 118$  mV ( $pe < 2$ ). As the  $E_h$  or  $pe$  becomes smaller, the electron activity becomes larger, and reduction increases correspondingly.

The sequence of reduction of various compounds in soils usually occurs in the order of O, N, Mn, Fe, and S, concurrent with decreasing  $pe$  levels. At high  $pe$  ( $\geq 7$ ), oxygen is reduced first into  $H_2O$ . With a decrease in  $pe$  value, this is followed by reduction of  $NO_3^-$  and  $NO_2^-$ , and so on. Reduction of  $MnO_2$  is reported to occur at the same  $pe$  level as that of  $NO_3^-$  reduction (Stumm and Morgan, 1981). Then comes the reduction of  $FeOOH$  to  $Fe^{2+}$ , and when sufficiently low  $pe$  levels have been attained, sulfate,  $SO_4^{2-}$ , ions and  $CO_2$  are the last to be reduced. According to Stumm and Morgan (1981), such a succession of reduction, concurrent with increasingly lower  $pe$  values, is expected if the reactions

occur in the order of their thermodynamic possibilities. Typical reduction products in waterlogged soils are  $\text{H}_2\text{S}$  and  $\text{S}_2\text{O}_3^-$  (thiosulfate) compounds.

The different redox conditions will, of course, not only affect the chemical status of plant nutrients, but also the activity of various microorganisms. Because soil organisms are composed of approximately 90% water, their redox activities are expected to be confined within the borders of the stability of water. These organisms do not oxidize directly but act as redox catalysts, and mediate the oxidation of substances or the reduction of  $\text{O}_2$ . Because most of the reduction processes discussed above are biologically mediated reactions, the reduction sequence results in an ecological succession of microorganisms (e.g., from aerobic heterotrophs to fermentors, followed by sulfate reducers). Sulfate-reducing bacteria, mediating the reduction reaction, become active only when  $E_h$  decreases below 0 mV. In general, *aerobic* soil organisms thrive in *normal* or oxic soils, where the drainage is excellent (low electron activity), and anaerobic organisms flourish in waterlogged or anoxic soils where the drainage is poor (high electron activity). Wet or suboxic soil (medium electron activity) may contain *facultative* anaerobic organisms or a mixture of aerobic and anaerobic microorganisms.

### 11.9.5 CONSTANCY IN $E_h$ -pH OR $pe$ -pH RELATIONS

The negative correlation between  $E_h$  and pH or between  $pe$  and pH, as noted in Figure 11.10, also indicates that if pH increases,  $E_h$  or  $pe$  decreases, and vice versa. Liming acid soils increases soil pH and hence will decrease the redox potential of soils. However, as oxidation of reduced compounds increases gradually as a result of liming,  $E_h$  or  $pe$  will eventually increase again, forcing the pH to decrease. Incorporation of organic matter to soils means adding electrons. This will tend to decrease the soil  $pe$ , resulting in an increase in soil pH. However, a decrease in  $pe$  will result in an increase in oxidation, and if oxidation processes increase,  $pe$  increases again, which forces the soil pH to decrease. Consequently, soils affected by changes in redox reaction due to application of lime, organic matter, and fertilizers tend to adjust their redox potential and pH so that a constant  $E_h$ -pH or  $pe$ -pH can be maintained (Bartlett, 1981), a process related to the soil's buffering capacity.

### 11.9.6 APPLICATION OF REDOX POTENTIALS IN SOILS

The redox potential varies with the reduction and oxidation state in soils. It is also associated with soil pH.  $E_h$ -pH relations are usually linear and were discussed earlier in Section 11.9.3 (see also Garrels and Christ, 1965).

An illustration of the variations in redox potentials can be given when reduced iron is oxidized by an oxidizing agent (Figure 11.11). The curve in Figure 11.11 indicates that oxidation of Fe(II) causes the redox potential to rise. When 50% of Fe(III) is produced and present, the redox potential equals 770 mV. This can be verified statistically by assuming that the half-cell reaction,  $\text{Fe}^{3+} + e^- \leftrightarrow \text{Fe}^{2+}$ , is characterized by a standard potential  $E^\circ = 770$  mV (see Table 3.1). The redox potential for this reaction was formulated as:

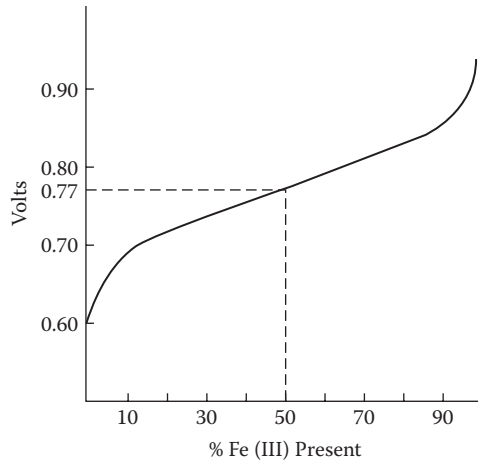
$$E_h = E^\circ + 0.059 \log(\text{Fe}^{3+}/\text{Fe}^{2+})$$

if

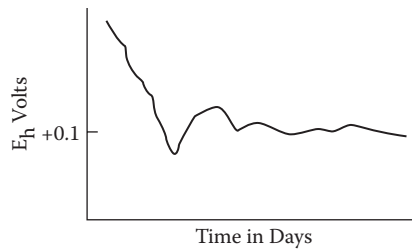
$$\text{Fe}^{2+} = \text{Fe}^{3+} (= 50\%)$$

then

$$E_h = E^\circ + 0.059 \log 1$$



**FIGURE 11.11** Redox potential curve of a waterlogged soil in the presence of oxidation of Fe(II)  $\rightarrow$  Fe(III). (From Jeffery, J. W. O., *European J. Soil Sci.*, 11, 140–148, 1960. With permission from John Wiley & Sons.)



**FIGURE 11.12** The redox potential curve as influenced by the length of flooding time. (From Jeffery, J. W. O., *European J. Soil Sci.*, 11, 140–148, 1960. With permission from John Wiley & Sons.)

or

$$E_h = E^{\circ} = 0.770 \text{ V}$$

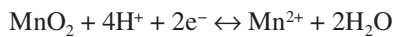
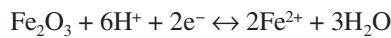
From above, it can be inferred that the redox potential of soils in an oxidized state is higher than that of soils in a reduced state. Jeffery (1960) reported an  $E_h$  value of  $-250 \text{ mV}$  for soils in strong anaerobic condition. He also found that the redox potential was affected by flooding as shown in Figure 11.12. During the initial stage of flooding, the redox potential dropped rapidly, to increase again upon continued flooding, and stabilized eventually at approximately  $100 \text{ mV}$ . A system that has a stabilized redox potential is said to be *well poised*.

**TABLE 11.6**  
**Redox Potential Values at Various Soil Aeration Statuses**

Soil Aeration Status	$E_h$ (V)
Well-aerated soils	0.4 to 0.7 or higher
Somewhat poorly aerated soils	0.3 to 0.35 or lower
Waterlogged soils	$-0.4$ or lower

The redox potential can, therefore, be used to indicate the aeration status in soils (Table 11.6). Drastic changes take place in the physical, chemical, and biological conditions of soils with development of poor aeration or waterlogged conditions. Oxygen content decreases rapidly in poorly aerated soils. Respiration of plant roots and microorganisms will rapidly consume the remaining oxygen in soil air. Therefore, oxygen content decreases with a decrease in  $E_h$ . At low  $E_h$  values, the dissolved oxygen in soil water will then be used by the microorganisms, and at very low  $E_h$  values, even the combined oxygen, in the form of ferric oxides, nitrates, and sulfates, will be attacked.

A notable chemical effect resulting from waterlogging is the conversion of insoluble iron and manganese oxides into soluble Fe(II) and Mn(II), respectively. The reactions can be represented as follows:

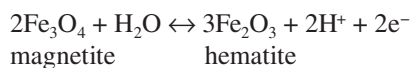


Consequently, in those poorly aerated soils in which reduction processes prevail, iron is found as  $\text{Fe}^{2+}$  iron, manganese as  $\text{Mn}^{2+}$ , nitrogen as  $\text{NH}_4^+$ , and sulfur as  $\text{SO}_3^{2-}$  ions. On the other hand, these ions are present in the oxidized state in well-drained soils (e.g., as  $\text{Fe}^{3+}$ ,  $\text{Mn}^{4+}$ ,  $\text{NO}_3^-$ , and  $\text{SO}_4^{2-}$ ).

Biologically, decreasing oxygen content in soils produces drastic changes in the population of soil microorganisms. At low oxygen content, *anaerobic* microorganisms (*Actinomyces* sp.) may prevail over *aerobic* microorganisms. In medicine, the redox potential is applied for the detection of certain diseases. Low values of the redox potential around the gum increase the risk of *gingivitis*, a gum disease.

### 11.9.7 STABILITY OF IRON OXIDES AND HYDROXIDES

The redox potential and pH are used to define stability relationships between iron oxide and iron hydroxide minerals. The formation of hematite from magnetite is considered an oxidation reaction. The reaction is simplified as follows:



The redox potential of this system is then:

$$E_h = E^\circ + [(0.059)/2]\log\{[(\text{Fe}_2\text{O}_3)^3(\text{H}^+)^2]/[(\text{Fe}_3\text{O}_4)^2(\text{H}_2\text{O})]\}$$

By assuming that  $\text{H}_2\text{O}$  and the mineral species are in a pure state, their activities are unity. Therefore, the equation changes to:

$$E_h = E^\circ + [(0.0590)/2]\log(\text{H}^+)^2$$

or

$$E_h = E^\circ - 0.059\text{pH} \quad (11.15)$$

Equation 11.15 is a linear relationship between  $E_h$  and pH. It delineates the boundary between stability of magnetite and hematite. If the redox potential of the system is larger than the  $E_h$  value of

Equation 11.15, hematite is stable. If the redox potential of the system is smaller than the  $E_h$  value calculated from Equation 11.15, magnetite exists as the stable species.

### 11.9.8 ACTIVITY OF REDUCTION PRODUCTS

Van Breemen and Brinkman (1976) stated that flooding aerobic soils reduced first the  $\text{NO}_3^-$  in soils. After the disappearance of nitrate, manganese would be in line for reduction, followed by iron. The latter increased the concentrations of  $\text{Mn}^{2+}$  and  $\text{Fe}^{2+}$  ions during the initial period of reduced condition. The concentration of  $\text{Mn}^{2+}$  and  $\text{Fe}^{2+}$  ions decreased again upon continued flooding and then stabilized at a constant level. The net reaction is a condition in which Fe(III) and Fe(II) ions are present together. Such a condition is considered desirable for soils (Jeffery, 1960).

---

# 12 Chemistry of Soil–Organic Matter Interactions

## 12.1 COMPLEX FORMATION AND CHELATION

Slightly different versions on the concepts of complex reaction and chelation are now available in the literature. The older versions are clear and straightforward, whereas the “modern” versions are often confused and ambiguous in their language. The terms *complex formation* and *chelation* have been used in soil science interchangeably even in the newer literature. One of these new versions defines *complex formation* as “a metal–ligand interaction,” and *chelation* as “a process of a donor atom with more than one available non-binding pair of electrons donating them simultaneously to two or more metal ions, acting to bridge them together” (Bailey et al., 2002). The complexes are usually distinguished into two main groups: (1) metal–ligand coordination complexes, and (2) supramolecular complexes. The first group will be addressed below, and the second group was discussed in Chapter 5, Section 5.9.1.2, on supramolecular associations of humic acids.

### 12.1.1 COMPLEX FORMATION

Given the nature of bonding, a clear distinction between complex formation and chelation is more than justified. In the older literature, complex formation is also defined as the reaction of a metal ion and a ligand through electron-pair sharing (Martell and Calvin, 1952; Mellor, 1964; Murmann, 1964). The resulting product is called a *metal–ligand coordination complex*. The metal ion is the electron-pair acceptor, and the ligand is the electron-pair donor. The term *ligand* is derived from the Latin *ligare*, which means “to bind.” It is sometimes also called *sequestering agent*. The bonding in complexation occurs by only one donor atom of the ligand, which is in contrast to chelation, where two or more donor atoms are involved, resulting in formation of the characteristic *chelate ring*. In a complex, the metal ion serves as the central ion, and the ligands, mostly organic ions, are coordinated around it in a *first coordination sphere*. The number of ligands bonded to the central atom in a definite geometry is called the *coordination number*. Hydrated metal ions in solution are also considered complexes with water, because they are surrounded by water molecules (Perrin, 1964). The above, referred to earlier as a *metal–ligand interaction* by Bailey et al. (2002), is a reaction conforming to the Lewis acid–base concept. These authors also believe that the preference of a metal ion reacting with a particular ligand is based on the ligand being a hard or soft base (see Section 10.2.6 for the concept of hard and soft acids and bases). Hard acids are considered to form stronger complexes with hard bases, but weaker complexes with soft bases. The interaction in the hard acid–hard base category is due mostly to electrostatic forces, whereas covalent forces are mainly responsible in “soft–soft” interactions.

Almost any metal atom can serve as an acceptor atom, including  $K^+$ ,  $Li^+$ ,  $Na^+$ ,  $Ag^+$ , and  $Au^+$  (Murmann, 1964). A long-known complex compound with a monovalent ion is potassium ferrocyanide. A ligand can be an anion ( $Cl^-$  or  $R-CH_2-COO^-$ ) or a neutral molecule ( $NH_3$ ). The complexes produced can be in the form of cations, anions, or neutral molecules—in other words, can be negatively or positively charged or have no charge at all.



Several naturally occurring soil organic acids are capable of complexing metal ions. The reaction occurs mostly with the transition metals, Al, Fe, Cu, Zn, and Mn, and is often considered a special case of an adsorption process. Such kind of adsorption is quite different from the regular Coulombic adsorption of cations in an electric double layer. As indicated in a previous section of cation exchange, the metal ion “adsorbed” in a complex reaction cannot be exchanged rapidly in the traditional manner of cation exchange reactions. The bonds in a complex compound are covalent bonds; hence, they are stronger bonds than the electrostatic bonds in cation exchange reactions. However, an exchange of the complexed metal is still possible, but such an exchange depends on many factors (e.g., soil pH, affinity of the metals for the ligand, and stability of the complexes). The exchange will take place more rapidly between transition metals. For example, an exchange of complexed Al by free Fe occurs more easily than by  $\text{Na}^+$  ions. The exchange by  $\text{Na}^+$  ions is very difficult, because the  $\text{Na}^+$  ion cannot occupy the center position of the  $\text{Al}^{3+}$  ion in the complex.

### 12.1.2 CHELATION

Some of the organic ligands can bind the metal ion with more than one donor functional group. This type of bonding forms a heterocyclic ring, called a *chelate* ring (Figure 12.1). The process of formation of a chelate ring is called *chelation* (Greek, *chele* means lobster claw), and the resulting complex compound is called a chelate. In this case, the ligand is sometimes called *chelator* or *chelant*. If one ligand molecule is involved in the formation of a chelate, the compound is a monodentate chelate or complex. If two ligand molecules form a chelate with a metal, the complex compound is called a bidentate. The term *dentate* is presumed to originate from *dent* (“tooth”) and has the connotation of *biting*—“bitten by the lobster claw.” Examples of two types of chelates are presented in Figure 12.2.

Depending on the number of ligands participating in the formation of the chelate, we can also have tridentates, tetradentates, pentadentates, and hexadentates. According to Bailey’s concept (Bailey et al., 2002), the ligands can have three, four, five, and six donor groups, respectively, and depending on the number of donor groups involved, the chelates formed are called tri-, tetra-, penta-, and hexadentates. The formation of chelates with more than one ligand imparts high stability to the compound.

As will be discussed in Section 12.3, the chelation reactions have proved to be very beneficial in acid soils, in which the presence of large amounts of free Al, Fe, and Mn can create toxicity to plant growth. The organic acids can bind metal ions present in excessive amounts in the soil solution and later release them to plants in smaller amounts, as needed (Tan and Binger, 1986). In this way, micronutrient toxicity can be controlled, because the organic acids prevent buildup of large amounts of micronutrients in the soil solution. Many of the organometal chelates formed are insoluble and

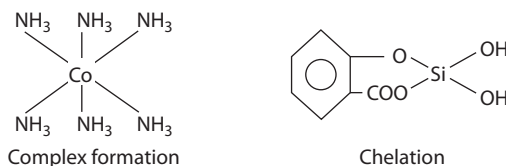


FIGURE 12.1 Complex formation and chelation.

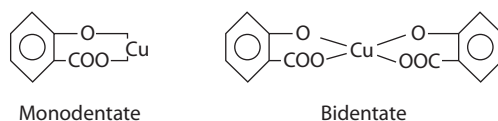


FIGURE 12.2 Monodentate and bidentate chelates.

prevent the metal from reaching the groundwater. The latter process is an important aspect in environmental quality. Considerable concern has been extended toward Pb and Cd pollution of agricultural and forested ecosystems, but these toxic contaminants can be immobilized through chelation by humic matter and other soil organic compounds (Stevenson, 1994). Chelates also play a very important role in food and medicines. Carbohydrates, lipids, amino acids, phytic acids, and so forth, are naturally occurring chelating agents. Some of these biological chelates are defined as proteinates or complexes. A number of well-known drugs (e.g., aspirin and the antibiotics penicillin and tetracyclines), are allegedly functioning through a chelation process (Furia, 1980).

## 12.2 INTERACTIONS WITH SOIL ORGANIC COMPOUNDS

The organic compounds in soil that are capable of interacting with inorganic substances were categorized in Section 5.9.1 into *nonhumified* and *humified organic* compounds. The nonhumified materials are biochemicals produced by the living organisms and may range from simple aliphatic acids to complex aromatic, heterocyclic acids, and miscellaneous biochemicals. They include formic acid, acetic acid, amino acid, benzoic acid, citric acid, oxalic acid, tannic acid, tartaric acid, vanillic acid, and the miscellaneous compounds, such as phytic acid, chlorophyll, sugars, sugar acid, polysaccharides, polyuronides, and gums (Stevenson, 1994; Tan, 1986, 2009; White, 2005). Many of the biochemicals are producing water-soluble pigments capable of chelating metal ions in soils. They are called *siderophores*. *Pseudomonas* sp. has been reported to secrete *pyocyanin*, a violet-colored pigment noted to be a strong chelator.

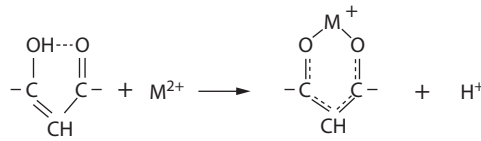
All these compounds have been released into the soil during the decomposition process of plant and animal residue, whereas many of them may have been secreted as root exudates. Some are intermediate products of plant and microbial metabolism, and others are the result of oxidative degradation of organic matter. For example, clover and pineapple plants contain large amounts of oxalic acids. Upon decomposition of these plants, these acids enter the soil. The role of oxalic acid in the dissolution of primary minerals has been addressed in the section on biochemical weathering. The rhizosphere contains microorganisms that synthesize large amounts of organic acids and other biochemical chelating agents. The availability of Fe in alkaline soils is reported to be caused by organic chelating agents produced in the rhizosphere by microorganisms or secreted by plant roots.

The concentration of most of these acids in soil is generally very low. For example, the amount of acetic acid is between 0.7 and 1 mmol/100 g soil. In general, the concentration of organic acids in the soil solution is normally in the range of  $1 \times 10^{-3}$  to  $1 \times 10^{-4}$  moles/L. Higher concentrations have usually been detected in the rhizosphere and in the leachates from forest canopies (Stevenson, 1994). Amino acids have been detected in higher concentrations than the other organic acids, but their role as chelating agents is considered only secondary to the other biochemicals (Stevenson, 1994).

The other group of organic acids is the humified organic acids, including humic and fulvic acids. The concentration of humic acid (HA) and fulvic acid (FA) is considerably higher than that of most of the nonhumified acids, though their contents may vary from soil to soil. Large amounts of humic and fulvic acids are present in Mollisols and Alfisols, but humic acid (780 mg/100 g soil; FA/HA ratio = 0.4) is generally the dominant organic fraction in Mollisols. In Ultisols, the humic fraction is composed mostly of fulvic acid (516 mg/100 g soil; FA/HA ratio = 6.5). For more details, see Chapter 5.

### 12.2.1 EFFECTIVENESS OF ORGANIC ACIDS IN CHELATION

The effectiveness of the organic acids in complex formation and chelation reactions depends on their chemical reactivity. Bailey et al. (2002) believe that it depends on whether they are hard or soft bases. However, the major donors of electron pairs in organic acids are  $-\text{COOH}$  and  $-\text{OH}^-$ , which are hard bases according to Pearson (1963). Because of this, the organic acids can be distinguished into two groups: (1) organic acids with acidic characteristics attributed to only the presence of carboxyl



**FIGURE 12.3** Example of formation of metal ( $M^+$ ) chelate ring structure.

groups,  $-\text{COOH}$ , and (2) organic acids with acidic characteristics due to the presence of both  $-\text{COOH}$  and phenolic- $\text{OH}$  groups, called functional groups, in their molecules. As indicated before, the first group of acids may exhibit some complexing capacity, but their main effect is more through the acidic ( $\text{H}^+$ ) effect or electrostatic attraction. The second group of acids is capable of exerting a variety of interaction reactions, including electrostatic attraction, coadsorption, and complex and chelation reactions. Details about this topic are provided in biochemical weathering and in Chapter 5.

The structure of the humic molecule presents a number of unique sites for potential interaction reactions, as discussed in Chapter 5. The interaction reactions take place at a large number of reactive sites on the functional groups with binding affinities ranging from weak attraction to strong bonding mechanisms forming highly stable coordinate linkages. Electrostatic attraction by the carboxyl groups and  $\text{H}_2\text{O}$  bridging are examples of relatively weak bonds, whereas formation of a ring (chelate) structure by carboxyl and phenolic- $\text{OH}$  groups produces relatively stronger bonds. Stevenson (1994) believes that the chelate ring is not the sole structural unit of humic acid complexes. Evidence from infrared spectroscopy indicates that  $\text{OH}$  groups,  $\text{C}=\text{O}$ , and  $\text{NH}$  groups in other types of organic substances are also capable of forming chelate-like ring structures by complexing metal ions. Conjugated ketonic structures are postulated to be involved in the interaction, as illustrated in Figure 12.3.

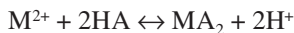
## 12.3 METAL-ORGANIC COMPLEX REACTIONS

### 12.3.1 STABILITY CONSTANTS

Humic matter is capable of forming both soluble and insoluble complexes with metal ions (Tan, 1978a; Stevenson, 1976a,b). Some of the factors affecting the solubility of metal-organic complexes are (1) pH, (2) the presence of salts or cations, (3) dissociation of functional groups, and (4) saturation of binding sites. Metal complexes of fulvic acids are generally more soluble than those of humic acids, perhaps because of the lower molecular weights and higher solubility of fulvic acids in water.

Cations have the potential for enhancing polymerization of humic matter by linking the individual humic molecules together, yielding chain-like structures. Stevenson (1994) indicates that the metal-humic acid complex remains soluble when the metal-to-humic ligand ratio is low. The metal-humic acid complex becomes insoluble and precipitates as the *salt bridges* increase and the chain-like structure grows. The maximum chelating (binding) capacity of humic matter equals its *total acidity* (= amounts of  $\text{H}^+$  from  $\text{COOH}$  + phenolic  $\text{OH}$  groups). A total acidity of 1000 mEq/100 g corresponds to 90 mg of  $\text{Al}^{3+}$ /g of humic acid, bonded by the functional groups. If this maximum bonding capacity is met, the ligand is saturated with the metal, and the complex or chelate becomes insoluble. Dissociation of functional groups induces repulsion of charged groups, as indicated by the dissociation of carboxyl groups:  $-\text{R}-\text{COOH} \leftrightarrow -\text{R}-\text{COO}^- + \text{H}^+$ , giving a stretched configuration to the humic molecule. After reaction with a cation, the negative charge is neutralized and the stretched molecule collapses, thereby reducing solubility.

The problem of solubility of metal-humic acid complexes is usually studied and expressed in terms of *stability constants*. Depending on the stability constants of the complex compound, they can be soluble or insoluble in water. Assume that the following reaction occurs:



where M is a metal ion with valence 2+, HA is humic acid, and MA<sub>2</sub> is the metal–humic acid complex. According to the mass action law, the equilibrium constant K of the equation above is then:

$$K = \frac{[(MA_2)(H^+)^2]}{[(M^{2+})(HA)^2]}$$

By taking the log, this equation changes to:

$$\log K = \log \frac{[(MA_2)(H^+)^2]}{[(M^{2+})(HA)^2]}$$

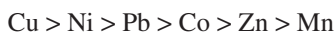
If the activities of HA and MA<sub>2</sub> are considered unity, then:

$$\log K = \log \frac{(H^+)^2}{(M^{2+})}$$

or

$$\log K = 2\log(H^+) - \log(M^{2+}) \quad (12.1)$$

where log K is called the *stability constant*. As the name implies, it determines the stability of the chelates (Tan et al., 1971a,b). It is also called *formation constant* or *association constant* by Furia (1980) and several other scientists, and the constant K is then often replaced by the symbol β. Mention is made in the literature of Furia being the “guru” on formation constants of metal–ligand complexes. Tan et al. (1971b) calculated the log K values for metal–fulvic acid complexes. They found that the stability of the complex compound was high if the value of log K was large. These complexes are then comparatively less soluble. On the other hand, Tan and coworkers noticed that a low stability constant suggested that the metal–ligand complex not only dissolved quickly, but that the ligand also readily dissociated from the metal, making the metal ions available for adsorption by plant roots. Therefore, the data in Table 12.1 indicate that Cu–FA complexes are more or less soluble than Zn–FA or Mg–FA complexes. The degree of solubility is largest for the Mg–FA complexes. The effect of pH in increasing the stability constants is demonstrated clearly by the data in Table 12.1. These log K values are in the range of those reported by Furia (1980) and Stevenson (1994) for 1:1 complexes of Cu and Zn with fulvic and humic acids. The data above are also in agreement with those presented by White (2005), who suggests the presence of a lyotropic series for stability constants, in decreasing order, involving some of the heavy metals as follows:



The affinity of some ligands to chelate metals is sometimes very strong, yielding then metal–ligand chelates with correspondingly very high formation constants (stability constants). Chelates formed with Al<sup>3+</sup>, Fe<sup>3+</sup>, or Cu<sup>2+</sup> ions are considered very stable. Furia (1980) listed formation constants for Cu–EDTA, Cu–alanine, and Cu–pyrophosphate in the range of 18.8, 8.2, and 6.7, respectively. A ligand from a chelate or complex with high formation constants will attract a metal from a complex

**TABLE 12.1**  
**Stability Constants (logK) of Metal–Fulvic Acid Complexes**

Stability Constant	Cu–FA	Zn–FA	Mg–FA
logK (pH 3.5)	7.15	5.40	3.42
logK (pH 5.5)	8.26	5.73	4.06

with lower formation constants. As can be noticed, Cu–EDTA is listed with the highest stability or formation constant; hence, ethylene diamine tetra-acetic acid (EDTA) is, according to Furia (1980), so powerful in sequestering metals that it is used to “steal” metals from other complexes. In this connection, Bailey et al. (2002) indicate that ions of the monovalent alkali metals, Li, Na, K, Rb, and Cs, have, in Bailey and coworkers’ language, “little electron pair tendencies.” These ions will, therefore, form weak complexes. On the other hand, divalent alkali earth ions, such as Mg and Ca, tend to form strong complexes with strong electronegative donors, whereas ions with charges  $>2+$ , such as  $\text{Al}^{3+}$  and especially the group of transition metals, will form the strongest complexes with a variety of ligands.

Stability constants are believed to be conditional constants, dependent on pH, ionic strength, and concentration of reactants. They are assumed to be valid only for well-defined, low molecular weight compounds, and are of limited value for use with humic and fulvic acids (Stevenson, 1994). Humic matter is considered heterogeneous in nature, though evidence to the contrary was reported (Lobartini et al., 1997). They may also exhibit configurational changes accompanying pH changes and reactions occurring in functional groups. These complications limit the determination and use of stability constants for humic acids according to Stevenson (1994).

## 12.4 CLAY–ORGANIC COMPOUND COMPLEXES

Clay can also form complexes with organic compounds (Greenland, 1971; Tan, 1976a; Theng, 1972, 1974). The organic compounds can be cationic, anionic, and polar nonionic in nature.

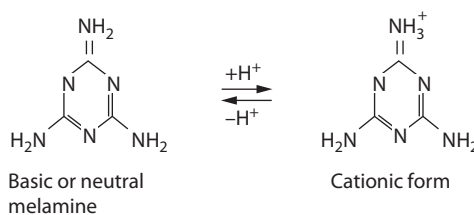
### 12.4.1 COMPLEX FORMATION WITH ORGANIC ANIONS

Under ordinary conditions, clay has a negative charge and, therefore, will repel organic anions. However, depending on pH or zero point charge (ZPC) value, clays with variable charges may develop positive charges (Chapter 6). Kaolinite has been reported to be amphoteric in nature, because it may carry a positive charge on the edge surface and a negative charge on its basal surface. The broken edge surfaces of clays also attain positive charges because of unsatisfied valencies.

Therefore, at normal soil pH ranges, the principles of anion adsorption, as discussed in Chapter 9, apply equally well to interaction reactions with organic anions. Two mechanisms are available for interaction of organic anions with clays, *positive* and *negative adsorption*. Under special conditions, other options are available, such as *van der Waals attraction*, *metal bridging* and *water bridging*, also called *coadsorption*, and *ligand exchange*. These special processes will also be addressed below.

#### 12.4.1.1 Positive and Negative Adsorption

Positive adsorption is defined in Chapter 9 as the attraction of organic anions by positively charged surfaces. Positive charges are usually developed under strongly acidic conditions, mostly on the surfaces of clays with variable charges. Therefore, under normal conditions, the main mechanism for adsorption of organic anions is negative adsorption. At soil pH below its  $\text{pK}_a$  value, the organic compound exists mainly in the acidic form and, therefore, behaves as a cation. It will be attracted



**FIGURE 12.4** Example of a transformation of a basic or neutral ion into a cation.

by negatively charged clay surfaces. However, at soil pH above its  $pK_a$  value, the organic compound exists in its basic form and behaves as an anion (Hirt and Schmitt, 1958). The transformation of a basic or neutral organic compound into its cationic form can be illustrated by the protonation reaction as shown in Figure 12.4.

Negative adsorption, as the main mechanism for adsorption of organic anions, was defined earlier as repulsion of anions by negatively charged clay surfaces (Chapter 8; see also Theng, 1972). Therefore, the relationship between complex formation (coordination bonding) and repulsion (negative adsorption) is rather obscure and questionable. Several authors have noted the presence of negative adsorption of herbicides by smectite (Bailey and White, 1970; Frissel and Bolt, 1962; Weber, 1970). Herbicides, such as 2,4-D and 2,4,5-T, are found to be negatively adsorbed by Na-smectite in a medium with a pH above the  $pK_a$  value of the organic compound. Negative adsorption continues to be important, until the pH of the medium equals the  $pK_a$ , or the dissociation constant of the respective compound. Positive adsorption starts as soon as the pH decreases below the  $pK_a$ . Bailey and White (1970) consider the dissociation constant to be a major factor in determining adsorption processes. The  $pK_a$  is used by these authors as an indicator for the degree of acidity or basicity of the substance. At pH values greater than  $pK_a$ , these organic substances exist in the basic form, and, therefore, behave as anions. As such, they are subject to attraction by positively charged surfaces, or to repulsion by negatively charged clays.

#### 12.4.1.2 Metal and Water Bridging

Another possibility for interaction between organic anions and silicate clays is through reactions with cations in exchange positions or through water molecules coordinated to these cations. The principles of these processes, called *cation* or *metal bridging* and *water bridging*, respectively, were discussed in previous chapters. Metal bridging appears to be a major force in interaction processes between organic anions and clay minerals exhibiting mainly permanent negative charges, such as the 2:1 lattice types of clays. Such an interaction is made possible especially when polyvalent cations are present on exchange sites. Unlike the monovalent cations, polyvalent cations can maintain neutrality at the interface by neutralizing both the negative charge of the organic anion and the clay surface. Two major types of bridging interactions have been proposed by Stevenson (1994). In the first type, water in the hydration shell of the polyvalent cation is not displaced and reacts with the organic anion by hydrogen bonding. In the second type of bridging reaction, water is displaced from the hydration shell of the polyvalent cation, and the organic anion becomes directly coordinated to the cation.

A *ligand exchange* mechanism has also been reported for the interaction of fulvic acid with allophanic clays in Andosols, soils developed from volcanic ash. Parfitt et al. (1977) assume that in the interaction process, the carboxyl ( $\text{COO}^-$ ) group of fulvic acid displaces an OH group on the oxide surface of allophane. Such an interaction between humic matter and allophanic clays is believed to account for the high humus content in Andosols.

#### 12.4.1.3 Van der Waals Force in the Complexation of Anions

*Van der Waals force* yields only physical bonds and is operational with all molecules. Van der Waals force provides only for a weak bonding mechanism, but because it results in close contact, attraction by van der Waals force may be followed by coordination bonding, necessary for complex or chelation reactions. According to Stevenson (1994), van der Waals interaction can be very important in the adsorption of neutral polar and nonpolar organic compounds. Such a physical interaction is perhaps the major adsorption process for nonpolar organic compounds.

### 12.4.2 COMPLEX FORMATION WITH ORGANIC CATIONS

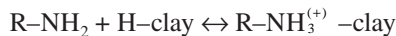
Under certain pH conditions, a number of organic compounds may be positively charged. This was discussed for amino acids in Chapter 5, and an additional example is provided in Figure 12.4. Due



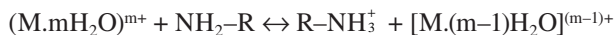
to the presence of positive charges on the organic compounds, positive attraction to the negatively charged clay minerals is the main reaction under normal conditions. The relationship of adsorption and complex formation becomes, in this case, clear due to the intimate contact, which is not provided in negative adsorption.

Positive charges can also develop on the organic compound by the following protonation processes. Mortland (1970) suggested that after adsorption by clay, the organic compounds become positively charged by accepting protons as follows:

1. H<sup>+</sup>-saturated clays may donate the proton:

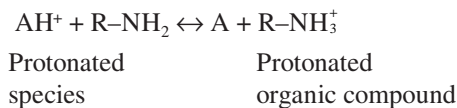


2. Water polarized by a cation can donate a proton to the organic compound:



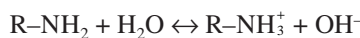
where M = cation with m<sup>+</sup> charges.

3. By the presence of a protonated species, AH<sup>+</sup>, that donates a proton to the organic molecule:



These organic compounds, having attained positive charges, may replace inorganic cations on exchange positions or in interlayer surfaces of clays. Such an exchange follows the general laws of cation exchange reactions. The exchange also occurs stoichiometrically and reaches a maximum equaling the cation exchange capacity (CEC) of clays (Greenland, 1965, 1971; Hendricks, 1941). If the organic cation occupies intermicellar spaces, analysis of basal spacings of clays indicates that the organic cation is adsorbed with its shortest axis perpendicular to the silicate layer (Theng, 1972).

Within the pH range of most soils (pH 4 to 8), most of the basic types of pesticides gain positive charges through some kind of a protonation process, as discussed above. According to Stevenson (1994), a protonation reaction of an organic compound is characterized by an equilibrium constant pK<sub>p</sub>. This is derived from a protonation reaction as follows:



The *protonation constant*, pK<sub>p</sub> (instead of Stevenson's pK<sub>b</sub>) is then:

$$K_p = \frac{(\text{R-NH}_3^+)(\text{OH}^-)}{(\text{R-NH}_2)(\text{H}_2\text{O})} \quad (12.2)$$

Water, the organic compound, and its protonated form, in pure states, are assigned activities equal to unity. Hence, in p (-log) form, Equation 12.2 changes into:

$$\text{pK}_p = (-\log(\text{OH}^-)) = \text{pOH}$$

$$\text{pOH} = 14 - \text{pH}$$



and hence,

$$pK_p = 14 - \text{pH} \quad (12.3)$$

Because the dissociation constant of electrolytes,  $pK_a$ , has been defined as the pH at which the electrolyte dissociates and produces equal concentrations of anions and undissociated molecules (see Chapter 4), the following relationship applies:

$$pK_a = \text{pH}$$

Substituting this into Equation 12.3 yields:

$$pK_p = 14 - pK_a \quad (12.4)$$

Equation 12.4 is in essence similar to the equation ( $pK_a = 14 - pK_b$ ) presented by Stevenson (1994). However, Equation 12.4 is based on protonation, which is in line with the topic, in contrast to Stevenson's premise focusing on the strengths of acid as reflected by  $pK_a$  values. The relationship above suggests that the *protonation constant* ( $pK_p$ ) is directly related to the dissociation constant ( $pK_a$ ) and vice versa. This means that protonation reactions depend on the pH at which the compounds dissociate easily (50/50). Similarly as in the case of  $pK_a$  values, a high  $pK_p$  value indicates a low degree or low rate of protonation, whereas a low  $pK_p$  value signifies a high degree of protonation. From Equation 12.4, it is evident that a high  $pK_a$  value will yield a low  $pK_p$  value, and a low  $pK_a$  value will give a high  $pK_p$  value. Consequently, protonation occurs more readily with compounds that are not easily dissociated. The ease of dissociation apparently will inhibit attachment of  $H^+$  ions, or protonation.

### 12.4.3 COMPLEX FORMATION WITH AMPHOTERIC ORGANIC COMPOUNDS

As discussed earlier, important organic substances in soils with amphoteric characters are humic compounds, proteins, and amino acids. The presence of functional groups, such as carboxylic and amino groups, in their molecules gives them the ability to exist either as cations, anions, or as zwitterions (see Section 5.5.1). The dominant ion species present in the soil solution depends on the soil reaction. The latter can be illustrated with the  $\alpha$ -amino acid, L-alanine, as illustrated by Figure 12.5.

The ion species in which the amino acid occurs governs the interaction with other soil components. In an acid soil reaction, or at pH values below the isoelectric point, amino acids are usually positively charged. As discussed in Chapter 5 (see Section 5.5.1), the amino group can obtain an extra proton and then behave as a cation. As such, the cationic form of amino acid can be attracted to the clay surface by cation exchange. The latter mechanism and proton transfer are expected to be the main processes for the interaction reactions at the clay–solution interface, or in the intermicellar spaces of expanding layer silicates.

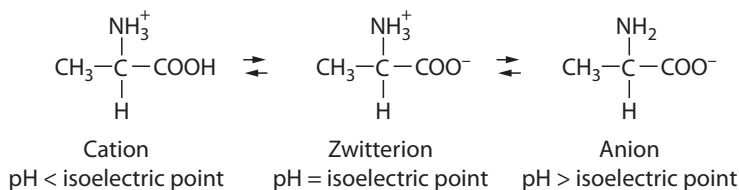
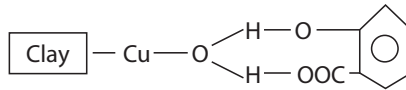


FIGURE 12.5 Conversion of amino acids into cations, zwitterions, and anions.



**FIGURE 12.6** Water bridging by  $\text{H}_2\text{O}$  molecules in the hydration shell.

At neutral soil reactions, or soil pH close to the isoelectric point, amino acids are dipolar and behave as a zwitterion. Although most soils under field conditions are in this pH range, the pH at the clay interface, previously discussed in Chapter 7 as *surface acidity* (see Section 7.6.1), is generally lower than the pH of the bulk solution. When present as a zwitterion, the amino acid will interact through ion dipole reactions. The positive pole ( $\text{NH}_3^+$ ) can be attracted directly to the negatively charged clay surfaces. On the other hand, the negative pole of amino acid ( $\text{COO}^-$ ) can also undergo interactions with metal cations adsorbed on the clay surfaces. In alkaline conditions, or soil pH above the isoelectric points, amino acids are negatively charged and possess anion characteristics. Although the anionic form is considered to be less important than the cationic and zwitterion forms (Theng, 1974), it has the capability of reacting with positively charged clay surfaces, or it may be attracted to the surface of clays by cationic or water bridging.

#### 12.4.4 COMPLEX FORMATION WITH NONIONIC ORGANIC COMPOUNDS

Nonionic organic molecules can also be adsorbed by clay minerals. This type of adsorption, sometimes called *molecular adsorption* (Bohn et al., 1979), can take place at the surface of clay minerals or in the intermicellar spaces of expanding types of clays. If the organic compound is not protonated or deprotonated to become an uncharged molecule, its adsorption occurs mainly by van der Waals attraction and hydrogen bonding. Van der Waals attraction appears to be the principal force of adsorption for uncharged nonpolar organic compounds, such as DDT and aldrin. The van der Waals attraction is usually considered weak and short-ranged in nature. However, as discussed in Chapter 6, it is additive because all atoms in the organic molecule and on the clay surface contribute to the total bond energy, which then results in a formidable force. In general, van der Waals force functions in almost all kinds of adsorbent–adsorbate relations.

The interaction between clay and uncharged organic molecules, such as alcohols and ethylene glycol, is made possible by the presence of exchangeable cations (Mortland, 1970). These cations are surrounded by water molecules arranged as a hydration shell. One or several of the water molecules can be exchanged for an organic ligand. The organic compound attaches itself through the exchangeable cation to the clay surface. This reaction is also called a *complex reaction*. If the cation has a low hydration energy, then the cation may form a direct coordinate bond with the oxygen atoms of the organic molecule. Water molecules in the hydration shell of the cation can also function as a bridge. The interaction, previously called water bridging, is illustrated in Figure 12.6.

In contrast to water bridging, molecular adsorption of soil organic substances can also occur through removal of adsorbed water molecules. This process, called previously *hydrophobic bonding*, is not an active adsorption process according to Bohn et al. (1979). Lipids, including waxes, fats, oils, and resins are hydrophobic compounds. When humic and fulvic acids are coated with this lipoidic material, water molecules compete poorly for adsorption sites with nonpolar organic substances, such as DDT, aldrin, and dieldrin. Water tends to be repelled, and DDT and aldrin tend to be preferentially attracted over water.

Adsorption of organic molecules in intermicellar spaces is called *intercalation*. The basal spacing of clays increases stepwise as one, two, or three layers of organic compounds are intercalated. Compounds with strong polarity will orient themselves parallel to the silicate surface when intercalated (Hoffmann and Brindley, 1960).

## 12.5 COMPLEX FORMATION AND MOBILITY OF SOIL CONSTITUENTS

### 12.5.1 METAL MOBILITY

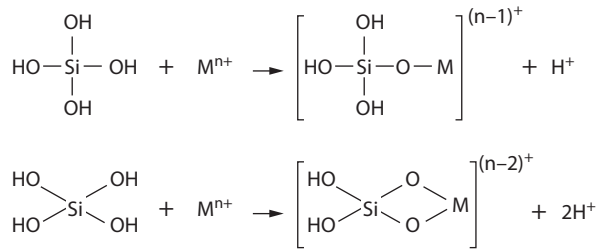
The effect of chelation on metal mobility was discussed in Chapter 11 in relation to desilicification and translocation of Al and Fe in the formation of albic, spodic, and oxic horizons. Such an effect is caused by a change in ionic behavior. After chelation the cation is surrounded by the chelating ligands. The cation may be transformed into an anion, and anions will be repelled by negatively charged colloids. Therefore, they will remain mobile. The elements, once released by weathering in the soil, behave according to the conditions. Some will be used for clay mineral synthesis, such as Si, Al, and Fe, whereas others will be adsorbed by soil colloids and plant roots. This can be also considered as a process of immobilization. Elements adsorbed by clay minerals can be made available to plant growth by exchange, or can be translocated, later on, with the percolating water to deeper soil depth. They may also be removed from the soil profile and are then called “leached.” For some of the elements, such as K and Na, the latter is a simple process, because they easily form soluble substances. With Fe and Al, it is a complex problem. Iron and Al compounds are usually insoluble at the normal soil pH range. However, the solubility of these substances can be increased by complex formation or chelation with soil humic compounds. Metals in the form of metal chelates can percolate with the rainwater downward in the soil profile. As a soluble chelate, the metal can also be taken up by plants through exchange reactions.

As discussed in Chapter 11 in the *podzolization process*, stability and mobility of Al and Fe humates depend on the metal concentration in the soil solution. If the concentrations of Al and Fe available for chelation or complex formation are low, complexes are formed in the A horizons with low metal/organic ratios. In this case, the amount of Al or Fe chelated is insufficient to cause immobilization of the metal chelate, and they may then remain mobile (De Coninck, 1980). On the other hand, if sufficient amounts of Al and Fe are released by the weathering of rocks so that metal–humic chelates can be formed with high metal/organic ligand ratios, these chelates formed will then be immobilized in the A horizon. De Coninck (1980) believes that in the mobile state, the metal–humic complexes are hydrophilic in nature and, hence, are highly hydrated. On the other hand, in the immobile state, they become hydrophobic due to loss of hydration water. The formation of andic horizons in Andosols is an example of the immobilization of metal–humic complexes in the form of Al–humates, or complexes between humic matter and allophanic clays (Tan, 1984; Wada and Aomine, 1973). Another example is the development of mollic epipedons in Mollisols due to immobilization of Ca–humates.

Though complex formation can also occur with  $\text{Ca}^{2+}$  and  $\text{Mg}^{2+}$  ions, these complexes are comparatively more soluble than Al-, and Fe-humic complexes. Problems related to stability constants of metal–humic complexes were discussed in Section 12.2.1. Calcium and Mg are also relatively more soluble than Al and Fe and can exist as free ions over a wide range of soil pH. Therefore, the mobility of  $\text{Ca}^{2+}$  and  $\text{Mg}^{2+}$  is less dependent on complex formation than is that of  $\text{Al}^{3+}$  and  $\text{Fe}^{3+}$ .

Aluminum and Fe chelates are usually present in Spodosols and Andosols, whereas Ca chelates occur mainly in Mollisols (Tan, 1978a, 1984). As explained earlier, Al and Fe chelates in Spodosols have high mobility and are the reasons for the formation of albic and spodic horizons. On the other hand, the Ca chelates in Mollisols are immobile. This difference in mobility is not only due to the degree of saturation of the complex with metals, but also due to the difference in types of organic ligands. In Spodosols, the organic ligands are mostly fulvic acids, whereas in Mollisols and Andosols, the ligands are mainly humic acids. Fulvic acid is the water-soluble humic fraction and, consequently, may form more soluble or more easily dispersible chelates than humic acids. Humic acids are by definition insoluble in water and may form stable Ca chelates in Mollisols.

Recently, evidence has been presented that organic matter is not the only compound capable of increasing the mobility of Al, Fe, and other metals (Tan, 1994; Taylor, 1988). Several inorganic substances are also known to be able to enter into complex reaction with Al and Fe. For instance, monosilicic acid is able to form complexes with metal ions. Such a complexation reaction, as illustrated in

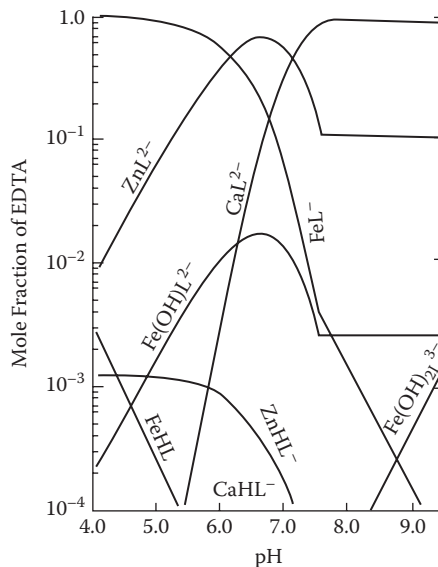


**FIGURE 12.7** Top: Complex reaction between monosilicic acid and a cation,  $\text{M}^{n+}$ , in which  $n^+$  is the number of positive charges. Bottom: Chelation reaction between monosilicic acid and a cation  $\text{M}^{n+}$ . (Adapted from Tan, K. H. *Environmental Soil Science*, Marcel Dekker, New York, 1994)

Figure 12.7, is of importance in the weathering of rocks and minerals. The resulting metal–silicate complex or chelate is in ionic form and remains in solution. This is perhaps one of the *inorganic* mechanisms proposed by Taylor (1988) and Stevenson (1994) for podzolization, by which Al and Fe may be transported as inorganic complexes to form Bs horizons (“s” is “sesquioxides”), characteristic of *iron-podzols* (*Spodosols*). A major flaw in this hypothesis is that silica is mobile and moves with Al or Fe to the B horizon. The requirement of podzolization is that silica is immobile and is left behind to accumulate in the A horizon, whereas Al and Fe are translocated downward.

## 12.6 STABILITY DIAGRAM OF METAL CHELATES

The cations in soils, such as  $\text{H}^+$ ,  $\text{Al}^{3+}$ ,  $\text{Fe}^{3+}$ ,  $\text{Zn}^{2+}$ ,  $\text{Mn}^{2+}$ ,  $\text{Ca}^{2+}$ , and  $\text{Mg}^{2+}$ , may compete with each other for bonding with the chelating agent. The cation that can form the most stable chelate in the particular condition will be bonded. Lindsay (1974) and Lindsay and Norvell (1969) have made a number of stability diagrams of Zn-, Fe-, and Ca-EDTA (Figure 12.8). They reported that at pH 6 to 7, Zn-EDTA was stable. By the term *stable*, Lindsay and Norvell (1969) meant that the chelate



**FIGURE 12.8** Stability diagram of  $\text{Zn}^{2+}$ ,  $\text{Fe}^{2+}$ ,  $\text{Ca}^{2+}$ , and  $\text{H}^+$  complexes with EDTA and DTPA as influenced by soil pH. (From Lindsay, W. L., and W. A. Norvell, *Soil Sci. Soc. Am. Proc.*, 33, 62–68, 1969. With permission.)

existed as a stable soluble compound. Between pH 5.5 and pH 7, Fe-EDTA was the stable species in the chelate mixture. At pH 7 to 7.3, Ca-EDTA was stable. These authors concluded that  $\text{Fe}^{3+}$  displaced  $\text{Zn}^{2+}$  from Zn-EDTA at low pH, whereas  $\text{Ca}^{2+}$  displaced  $\text{Zn}^{2+}$  or  $\text{Fe}^{3+}$  from Zn-EDTA or Fe-EDTA at high pH. Therefore, the presence of  $\text{Fe}^{3+}$  at low pH may cause  $\text{Fe}^{3+}$  to become chelated and remain soluble (stable). On the other hand, Zn is then expelled from the chelate compound and precipitates as  $\text{Zn}(\text{OH})_2$ . The latter may cause Zn deficiency. The question is how  $\text{Zn}(\text{OH})_2$  can be formed at low pH values. Deficiency of Zn is only possible after displacement by Ca, because the high pH is conducive for formation of insoluble  $\text{Zn}(\text{OH})_2$ .

## 12.7 COMPLEX FORMATION AND CLAY MOBILITY

The migration of clay in soils requires that clay remain in suspension. Dispersion and suspension are increased by (1) a low electrolyte or low base content in soils, (2) by the absence of positively charged colloids, or (3) by a combination of both of these factors. Soils high in  $\text{CaCO}_3$  show little evidence of translocation of clays. However, clay can also form complexes with soil organic compounds. The latter increases its capacity to disperse (see Section 11.7.2) and, consequently, increases its mobility.

## 12.8 COMPLEX FORMATION AND SOIL FERTILITY

Complex formation and chelation play important roles in improving soil fertility. The physical, chemical, and biological conditions of soils are directly and indirectly influenced by complex reactions.

### 12.8.1 COMPLEX FORMATION AND SOIL PHYSICAL CHARACTERISTICS

Soil organic matter is considered very important for improving the physical conditions in soils for plant growth. Stability of soil organic matter against decomposition and its consequent accumulation in soils are processes related to complex formation between clay minerals and soil organic compounds (see Section 5.4.1). It is an established fact that adequate organic matter content is essential for development and maintaining an excellent soil structure and proper bulk density. It also increases the water-holding capacity of soils, which is of immense importance in sandy soils. A favorable soil structure and bulk density will in turn improve soil porosity, drainage, and aeration.

Formation of a stable soil structure is often associated with complex formation between clay minerals and soil organic compounds. As discussed in Section 5.4.2, the interaction of soil polysaccharides with clay particles has been related to enhancing aggregation of soil particles, with the consequent formation of granular to crumb structures (Baver, 1963; Greenland et al., 1961, 1962). This stabilizing effect on soil structure is attributed to an increase in cementing effect or *cohesion*. By interaction with soil clays, the polysaccharides are thought to change the electrochemical properties of the clay surfaces for adsorption of water. The organic compounds compete with water molecules for adsorption sites, and the force for the exchange process is called *hydrophobic bonding* (see Section 7.3.4). Because of the displacement of water, wetting and swelling of clay particles are reduced, thereby increasing cohesion or cementation. The stabilization effect of soil aggregates by fungal mycelia, as frequently postulated by several authors, is considered a temporary effect by Baver (1963), because mycelia and cells will die rapidly and undergo further microbial decomposition. The idea to liken the effect of polysaccharides with a “coat of paint” as suggested by Stevenson (1994) is somewhat misplaced. A coat of paint is a plain physical layering, in contrast to a complex reaction where chemical bonding is involved. *Physical encapsulation* is, of course, also possible, and this can be called *the coat of paint* that will be subject to rapid microbial attack. However, due to complexation, the polysaccharides are known to be relatively stable against microbial decomposition. Emerson et al. (1986) also stress the importance of polysaccharides, called *ECP* (extracellular polysaccharides), in aggregation of soil clays.

Other organic compounds may also be capable of affecting aggregation of soil particles through complexation reactions, such as sugars, exudates, mucigels, and humic matter. Gels secreted by roots may also coat and interact with soil minerals and organic fragments near the root surface. These gels are often metabolized and transformed by microbial activities. The mixture of root gels, metabolized gels, and microbial gels is called *mucigel* (Emerson et al., 1986). However, the major compound constituting mucigel is polysaccharides (Paul and Clark, 1989). These mucigels, therefore, are composed of large molecules that hardly move around in soils, and perhaps it is the very fine clay fraction that migrates with the movement of water to the mucigels to initiate aggregation. Humic and fulvic acids have also been linked to encouraging soil structure formation through clay–metal–humic acid interactions (Swift, 1991). According to Stevenson (1994), flocculation of clay–humic complexes is a major requirement for the aggregation process. More recently, a glycoprotein, called glomalin, was claimed by U.S. Department of Agriculture Agricultural Research Service (USDA-ARS) scientists as “the glue of the century” in soil aggregation (Comis, 2002). This was discussed in Section 5.3.1.

### 12.8.2 COMPLEX FORMATION AND SOIL CHEMICAL CHARACTERISTICS

In the preceding sections, it is shown that chelation increases the mobility and, consequently, plant availability of many cations. The release of plant nutrients by weathering of soil minerals is usually a slow process. However, complex formation tends to accelerate the decomposition process of soil minerals, and, accordingly, also accelerates the release of soluble nutrients.

The harmful effect of fixation of K and P is also offset by complex formation with organic ligands. Evidence was presented by Tan (1978b) that humic and fulvic acids increase the release of K fixed in the intermicellar spaces of clays.

It is expected that chelation or complex formation may also contribute toward making insoluble inorganic phosphates more soluble. The solubility of  $\text{AlPO}_4$ ,  $\text{FePO}_4$ , or  $\text{Ca}_3(\text{PO}_4)_2$  is increased considerably by complex formation with humic matter or other organic compounds. A ligand from a complex with high formation constants will attract a metal from a complex with lower formation constants (see Section 12.3.1). Humic and fulvic acids have a high affinity for Al, Fe, and Ca, while the corresponding humometal complexes exhibit large  $\log K$  values. Consequently, humic substances will compete easily for these elements with the respective phosphates by complex formation, releasing in the process the phosphate ions in the soil solution. Lobartini et al. (1994) show an enhanced dissolution of the phosphate mineral apatite due to interaction with humic acids. The dissolution is pH dependent, because more  $\text{PO}_4^{3-}$  ions are detected at pH 5 than at pH 7. The complexes are in the form of humophosphate esters as determined by  $^{31}\text{P}$  NMR (nuclear magnetic resonance) spectroscopy. Humic compounds are also effective in binding the micronutrients, such as Fe, Cu, Zn, and Mn. In acid soils, these micronutrients are present in large amounts and cause toxicity problems to plants. Acid soils are also high in soluble Al, which is known to create Al toxicity. By adding humic acid to these acid soils, Al toxicity is alleviated (Tan and Binger, 1986), and some of the excess micronutrients are taken out of the solution by complex formation with the humic compounds. In time, they can be released again to plants in smaller amounts as needed. In this way, the chelate acts as a regulatory agent. In some soils, the soluble fraction of the micronutrients Fe, Zn, Cu, and Mn can be deficient, because usually they are too insoluble, especially in soils characterized by high pH, such as in Aridisols. Chelation of these elements by soil organic matter increases their solubility (Lindsay, 1974). The latter helps to maintain adequate levels of soluble micronutrients in the soil solution.

From an environmental or ecological standpoint, complexing of heavy metal ions by humic compounds may temporarily reduce toxic hazards for human beings, animals, and plants. Of considerable interest in environmental pollution is also the interaction of pesticides and their degradation products with soil organic matter. Stevenson (1994) believes that pesticide residues can form stable complexes with soil organic compounds, greatly increasing their persistence in soils. Two interaction processes are suggested to play major roles in the reactions: (1) direct linkage of the pesticide to the organic compound and (2) synthesis of humic acid-like compounds using the pesticide residues.



According to Stevenson (1994), basic pesticides, such as s-triazine, will form a linkage with the carbonyl groups of soil organic matter, whereas pesticides containing carbonyl groups will react with amino groups of soil organic matter. Pesticide residues can also be transformed into other forms by conjugate reactions with metabolites produced by plants and soil microorganisms. Cross-coupling of *xenobiotics* with humic acids is another possibility.

The second possibility as indicated by Stevenson (1994)—formation of humic acid-like material—also has some beneficial effects for the soil ecosystem. The biodegradation of pesticide residue is reported to yield chemically reactive products that are often more harmful than the original materials (Tan, 2009). However, they can link with carbonyl groups, carboxyl groups, phenolic–OH groups, and amino groups of soil organic substances to form *humic acid-like* compounds. Because of such an interaction by which the altered pesticide residue is incorporated in the molecular structure of a newly synthesized product, humic matter, the identity and behavior of the pesticide are completely erased. The importance of such a reaction in environmental quality is without question.

### 12.8.3 COMPLEX FORMATION AND SOIL BIOLOGICAL CHARACTERISTICS

It is apparent today that complex formation between live organisms, such as bacteria and fungi, and soil clays and humic matter is of a more common and important occurrence than previously expected. It is a process of great environmental importance for biochemical reactions to proceed, and more becomes known on the role of life soil organisms in complex formation and its effect on many of the organic cycles vital for continuation of life (Huang et al., 2005). Because of the sheer number in soils, microorganisms are bound to also form complexes with clay minerals and humic substances (Tan, 1984, 2009). Numerically, their population is the largest among all soil organisms, though it decreases rapidly with depth in the pedon. The roots of plants usually grow in that part of the soil that is rich with humus, where the dead, senescent, and live roots provide adequate food for microbial life. That part of the root–soil interface, where biological activity is at a maximum, is called the *rhizosphere*. The root surface, providing critical sites for interactions between microorganisms and plant cells, is called the *rhizoplane*, whereas the epidermal and cortical tissues of roots, colonized by microbes, are called the *endorhizosphere*. Paul and Clark (1989) prefer to call the latter *histosphere* or *cortosphere*. In these regions, the microorganisms usually congregate, and values of  $1 \times 10^9$  bacteria and fungi in 1 g of soils are not uncommon for well-drained and fertile soils, though the numbers may decrease considerably with distance from the rhizosphere (Paul and Clark, 1989).

These microbial cells will be adsorbed by organic and inorganic soil constituents and may also interact in a similar fashion as humic acid interacting with clay. Such an interaction between microorganisms and soil clays and humic acids results in changes in the soil properties, especially the charge characteristics of soils, though not much is known at the present time. Most soil scientists are used to the idea that the charge characteristics of soils are mainly confined to the clay and humic fractions. However, currently it is known that the cells of living organisms possess a significant amount of variable charges. Most bacteria are larger than clay particles and usually carry negative charges (Burns, 1986; Paul and Clark, 1989). This cell charge is believed to be affected by the charges of the clays in such a way that an interaction can take place, producing cell–clay complexes (Stout and Lee, 1980). However, the present author believes that the interaction is much the same as the interaction between humic acid and clay and humic acid and pesticides as discussed previously. The difference with humic acid or clay is only that bacteria are composed of cells that are too large to classify as colloids, but they nevertheless behave as colloids. The colloidal behavior is attributed to repulsion among the negatively charged bacterial cells, causing them to disperse in aqueous solutions. Such suspension is a characteristic known to be exhibited only by colloids. In contrast to clay and humic acids, bacteria are also living cells that possess the capability of growing, exhibit metabolism processes, and move independently. The interaction between bacteria and clay, forming complexes, can be described in physicochemical terms as follows (Marshall, 1968):





where B is bacterial cell, Cl is clay, and x and y are the concentrations (numbers) of B and Cl, respectively.

Since this is an equilibrium reaction, the equilibrium constant, K, can be calculated using the mass action law:

$$K = (B_xCl_y)/[(B)^x(Cl)^y]$$

In log form this equation becomes:

$$\log K = \log(B_xCl_y) - x \log B - y \log Cl$$

LogK is called the *stability constant* of the complexes formed. The larger is the value for K, the larger is the value for the stability constant, and hence the greater is the affinity of B for interacting with Cl. (See Section 12.3.1.) No investigations have yet been done in this respect.

Such an interaction between bacterial cells and soil clays is affected by the charge densities of the cells and the clay minerals. Some bacterial species, such as *Rhizobia* sp., have two types of cells, each characterized by different charge densities. One group of cells has charges attributed to carboxyl groups only, whereas the other group has charges created by complex combinations of amino and carboxyl groups. The latter yields smaller charge densities than the single carboxyl groups and is expected to have weaker interactions with clay (Marshall, 1968).

Not all soil organisms will react in such a way with clay or humic acids. The larger soil flora and fauna are generally too large and well insulated to be affected by the charge characteristics of the soil mineral and organic fractions. In analogy to the preservation of organic matter in soils as a result of complex formation with clays, the interaction between bacterial cells and clays also ensures the survival and accumulation of specific groups of bacteria, their enzymes, and their metabolic products. The adsorption of proteins by clays and their subsequent protection from decomposition has been known for many years. Clay–enzyme and humic–enzyme interactions are processes by which the activity of the enzymes can be preserved (Burns, 1986).

Extracellular enzymes can be adsorbed by clays through van der Waals forces, ion exchange, and H bonding. The type of adsorption, the properties of the ambient microenvironment (e.g., pH and ionic composition), and the physicochemical characteristics of the enzyme (e.g., pI and molecular mass) will determine the stability and residual activity of the complexed enzymes (Burns, 1986). The *pI* is the *isoionic point* or the pH at which the enzyme has a net charge of zero. Clay minerals with large surface areas are capable of adsorbing urease and protease, enzymes of importance in the decomposition of urea and protein, respectively. Due to adsorption, the enzymes are protected from hydrolytic attack by other enzymes, but the catalytic sites of the enzymes, responsible for decomposition reactions, become less available, especially when the enzymes are adsorbed in intermicellar surfaces. A small molecule, like urea, may be able to reach by diffusion the adsorbed urease and undergo decomposition, but a large molecule, such as protein, is more likely unable to penetrate the intermicellar spaces of the clay mineral (Paul and Clark, 1989).

Interaction between enzymes and humic acids occurs not only by adsorption, but also by covalent bonding during the synthesis of humic compounds, by a process similar to the incorporation of pesticide residue in the molecular structure of humic acid. Enzymes bound to humic acids are considered to remain stable and active, and most are resistant to degradation by other enzymes. These enzymes make possible the organic and nutrient cycling in soils. Much of the organic C and N entering the soil is of a polymeric nature and would not be available for uptake by higher plants and microorganisms, if their molecular masses are not reduced by enzymatic depolymerization. It would be an environmental disaster if the enzymes would not have survived in soils. Without interaction with clay and humic acids, free enzymes are usually rapidly denatured by a host of physical

and chemical soil properties (e.g., pH and ionic composition), or they may serve as substrates for proteolytic microorganisms (Burns, 1986).

#### 12.8.4 CHELATION AND COMPLEXATION IN INDUSTRY AND MEDICINES

Chelators have found practical applications in industry. Citric acids are used as water softeners in the production of soap and shampoos. Phosphonates were added in laundry detergents. They are now banned for use by the U.S. Environmental Protection Agency because of fear of polluting the environment by creating massive eutrophication. Chelants are also applied in the *steam engineering* or *chelant water treatment systems* for cleaning water boiler systems.

In the pharmaceutical industry and in medical science, chelating agents are used for detoxification of poisoning by intake of toxic metals (e.g., Hb, Hg, As, and Cd). In chelate form, these toxic metals become inactive and are excreted out of the animal or human body. A common and apparently popular artificial chelator in this respect is EDTA that was approved in 1991 by the U.S. FDA office. EDTA has also been used by dentists for irrigation and cleaning purposes in root canals. Chelation is also suggested for treatment of clogged arteries and for an easier and less dangerous alternative method of heart bypass surgery. However, *chelation therapy* (Taylor and Williams, 1995), though promising and interesting, and by many considered as *alternative medicine*, is still controversial. It is not a major scope of this book and is addressed here as a related subject only.



---

# Appendix A: Fundamental Constants

---

Symbol	Name	Value
c	Velocity of light	$2.9979 \times 10^8$ m/sec
e	Electronic charge	$1.6021 \times 10^{-19}$ C $4.8032 \times 10^{-10}$ esu
L	Avogadro's number	$6.0225 \times 10^{23}$
h	Max Planck's constant	$6.6256 \times 10^{-34}$ J sec
F	Faraday constant	$9.6487 \times 10^7$ C/kmol $2.8926 \times 10^{14}$ esu/mol
R	Gas constant	$82.056$ cm <sup>3</sup> atm/(mol)(K) $1.9872$ cal/(mol)(K) $8.3143$ J/(mol)(K)
K	Kelvin temperature	$-273^\circ\text{C} = 0$ K
k	Boltzman constant	$1.3805 \times 10^{-23}$ J/K

---



---

# Appendix B: Greek Alphabet

---

<b>Greek Letter</b>	<b>Greek Name</b>
A α	Alpha
B β	Beta
Γ γ	Gamma
Δ δ	Delta
E ε	Epsilon
Z ζ	Zeta
H η	Eta
Θ θ	Theta
I ι	Iota
K κ	Kappa
Λ λ	Lambda
M μ	Mu
N ν	Nu
Ξ ξ	Xi
O ο	Omicron
Π π	Pi
P ρ	Rho
Σ σ	Sigma
T τ	Tau
Υ υ	Upsilon
Φ φ	Phi
X χ	Chi
Ψ ψ	Psi
Ω ω	Omega

---





# Appendix C: Periodic Classification of Elements

1a	2a	3b	4b	5b	6b	7b	8					1b	2b	3a	4a	5a	6a	7a	O			
1 H 1.0080		Periodic Classification of Elements Based on $^{12}\text{C} = 12.0000$															2 He 4.003					
3 Li 6.939	4 Be 9.012																5 B 10.81	6 C 12.011	7 N 14.007	8 O 15.999	9 F 18.998	10 Ne 20.183
11 Na 22.930	12 Mg 24.31																13 Al 26.98	14 Si 28.09	15 P 30.974	16 S 32.064	17 Cl 35.453	18 Ar 39.948
19 K 39.102	20 Ca 40.08	21 Sc 44.96	22 Ti 47.90	23 V 50.94	24 Cr 52.00	25 Mn 54.94	26 Fe 55.85	27 Co 58.93	28 Ni 58.71	29 Cu 63.54	30 Zn 65.37	31 Ga 69.72	32 Ge 72.59	33 As 74.92	34 Se 78.96	35 Br 79.909	36 Kr 83.80					
37 Rb 85.47	38 Sr 87.62	39 Y 88.91	40 Zr 91.22	41 Nb 92.91	42 Mo 95.94	43 Tc (99)	44 Ru 101.1	45 Rh 102.90	46 Pd 106.4	47 Ag 107.87	48 Cd 112.40	49 In 114.82	50 Sn 118.69	51 Sb 121.75	52 Te 127.60	53 I 126.90	54 Xe 131.30					
55 Cs 132.91	56 Ba 137.34	57 La* 138.91	72 Hf 178.49	73 Ta 180.95	74 W 183.85	75 Re 186.2	76 Os 190.2	77 Ir 192.2	78 Pt 195.09	79 Au 197.0	80 Hg 200.59	81 Tl 204.37	82 Pb 207.19	83 Bi 208.98	84 Po (210)	85 At (210)	86 Rn (222)					
87 Fr (223)	88 Ra 226.05	89 Ac** (227)																				

Lanthanide* series	58 Ce 140.12	59 Pr 140.91	60 Nd 144.24	61 Pm (147)	62 Sm 150.35	63 Eu 151.96	64 Gd 157.25	65 Tb 158.92	66 Dy 162.50	67 Ho 164.93	68 Er 167.26	69 Tm 168.93	70 Yb 173.04	71 Lu 174.97
Actinide** series	90 Th 232.04	91 Pa (231)	92 U 238.03	93 Np (237)	94 Pu (242)	95 Am (243)	96 Cm (247)	97 Bk (249)	98 Cf (251)	99 Es (254)	100 Fm (253)	101 Md (256)	102 No (254)	103 Lw (257)



# Appendix D: X-Ray Diffraction

## 2 $\theta$ d-Spacing Conversion

2 $\theta$  d-Spacing Values for Cu K $\alpha$  Radiation with  $\lambda \approx 1.5405 \text{ \AA}$  (0.1540 nm)

2 $\theta$	0.0	0.1	0.2	0.3	0.4	0.5	0.6	0.7	0.8	0.9
0	$\infty$	882.63	441.32	294.21	220.66	176.53	147.11	126.09	110.33	98.076
1	88.263	80.245	73.555	67.897	63.047	58.845	55.167	51.922	49.038	46.457
2	44.135	42.033	40.122	38.378	36.779	35.308	33.950	32.693	31.526	30.440
3	29.425	28.476	27.587	26.751	25.964	25.223	24.522	23.859	23.232	22.636
4	22.071	21.532	21.020	20.531	20.065	19.619	19.193	18.785	18.394	18.018
5	17.659	17.312	16.979	16.660	16.352	16.054	15.768	15.491	15.225	14.967
6	14.717	14.476	14.243	14.017	13.798	13.586	13.381	13.181	12.988	12.800
7	12.617	12.440	12.267	12.099	11.936	11.777	11.622	11.471	11.325	11.182
8	11.042	10.906	10.773	10.644	10.517	10.394	10.273	10.155	10.040	9.9270
9	9.8168	9.7098	9.6042	9.5010	9.4001	9.3015	9.2053	9.1105	9.0173	8.9264
10	8.8378	8.7500	8.6645	8.5506	8.4989	8.4181	8.3387	8.2609	8.1847	8.1100
11	8.0360	7.9644	7.8935	7.8234	7.7549	7.6880	7.6220	7.5571	7.4932	7.4305
12	7.3688	7.3081	7.2484	7.1897	7.1320	7.0751	7.0192	6.9642	6.9100	6.8567
13	6.8042	6.7524	6.7015	6.6513	6.6019	6.5532	6.5053	6.4550	6.4114	6.3655
14	6.3203	6.2757	6.2317	6.1883	6.1456	6.1035	6.0619	6.0209	5.9804	5.9405
15	5.9011	5.8623	5.8239	5.7860	5.7488	5.7119	5.6755	5.6395	5.6041	5.5691
16	5.5345	5.5004	5.4666	5.4333	5.4004	5.3679	5.3358	5.3040	5.2727	5.2417
17	5.2111	5.1809	5.1510	5.1214	5.0922	5.0633	5.0348	5.0065	4.9787	4.9511
18	4.9238	4.8968	4.8701	4.8437	4.8176	4.7918	4.7663	4.7410	4.7160	4.6913
19	4.6669	4.6426	4.6187	4.5950	4.5715	4.5482	4.5253	4.5026	4.4801	4.4577
20	4.4357	4.4138	4.3922	4.3708	4.3496	4.3287	4.3079	4.2872	4.2669	4.2467
21	4.2267	4.2069	4.1872	4.1678	4.1486	4.1295	4.1106	4.0919	4.0733	4.0550
22	4.0367	4.0187	4.0008	3.9831	3.9656	3.9481	3.9309	3.9139	3.8969	3.8801
23	3.8635	3.8469	3.8306	3.8144	3.7983	3.7824	3.7666	3.7509	3.7354	3.7200
24	3.7047	3.6896	3.6746	3.6596	3.6449	3.6302	3.6157	3.6013	3.5870	3.5728
25	3.5587	3.5448	3.5309	3.5172	3.5036	3.4901	3.4767	3.4634	3.4502	3.4371
26	3.4241	3.4112	3.3984	3.3857	3.3731	3.3606	3.3482	3.3359	3.3236	3.3115
27	3.2995	3.2875	3.2758	3.2639	3.2522	3.2406	3.2291	3.2176	3.2063	3.1951
28	3.1839	3.1727	3.1617	3.1508	3.1399	3.1291	3.1184	3.1078	3.0973	3.0868
29	3.0763	3.0660	3.0557	3.0455	3.0354	3.0253	3.0153	3.0054	2.9955	2.9857
30	2.9760	2.9664	2.9568	2.9472	2.9377	2.9283	2.9190	2.9098	2.9005	2.8914
31	2.8823	2.8732	2.8643	2.8553	2.8465	2.8376	2.8289	2.8202	2.8116	2.8029
32	2.7945	2.7859	2.7775	2.7691	2.7608	2.7526	2.7443	2.7362	2.7281	2.7200
33	2.7120	2.7040	2.6961	2.6882	2.6804	2.6727	2.6649	2.6573	2.6496	2.6420
34	2.6345	2.6270	2.6195	2.6121	2.6048	2.5974	2.5902	2.5830	2.5757	2.5686
35	2.5615	2.5541	2.5474	2.5404	2.5334	2.5295	2.5196	2.5129	2.5060	2.4993
36	2.4926	2.4859	2.4793	2.4727	2.4661	2.4596	2.4531	2.4466	2.4402	2.4338
37	2.4274	2.4211	2.4149	2.4086	2.4024	2.3962	2.3901	2.3840	2.3779	2.3719
38	2.3659	2.3599	2.3540	2.3480	2.3421	2.3362	2.3305	2.3247	2.3189	2.3131
39	2.3074	2.3018	2.2962	2.2905	2.2849	2.2794	2.2739	2.2684	2.2629	2.2574



---

# Appendix E: System International (SI) Units

---

<b>SI Unit</b>	<b>Symbol</b>
Ampere (electrical current)	A
Candela (luminous intensity)	cd
Meter (length)	m
Mole (amount of substance)	mol
Kelvin (thermodynamic temperature)	K
Kilogram (mass)	kg
Second (time)	s
Square meter (area)	m <sup>2</sup>

---



---

# Appendix F: Factors for Converting U.S. Units into System International (SI) Units

---

U.S. Unit	SI Unit	To Obtain SI Unit Multiply U.S. Unit by
Ångstrom	Nanometer, nm	$10^{-1}$
Atmosphere	Megapascal, MPa	0.101
Bar	Megapascal, MPa	$10^{-1}$
Calorie	Joule, J	4.19
Cubic foot	Liter, L	28.3
Cubic inch	Cubic meter, m <sup>3</sup>	$1.64 \times 10^{-5}$
Curie	Becquerel, Bq	$3.7 \times 10^{10}$
Degrees, °C (+273, temperature)	Degrees, K	1
Degrees, °F (-32, temperature)	Degrees, °C	0.556
Dyne	Newton, N	$10^{-5}$
Erg	Joule, J	$10^{-7}$
Foot	Meter, m	0.305
Gallon	Liter, L	3.78
Gallon per acre	Liter per ha	9.35
Inch	Centimeter, cm	2.54
Micron	micrometer, μm	1
Mile	Kilometer, km	1.61
Mile per hour	Meter per second	0.477
Millimho per cm	Decisiemens per m, dS m <sup>-1</sup>	1
Ounce (weight)	Gram, g	28.4
Ounce (fluid)	Liter, L	$2.96 \times 10^{-2}$
Pint	Liter, L	0.473
Pound	Gram, g	454
Pound per acre	Kilogram per ha	1.12
Pound per cubic foot	Kilogram per m <sup>3</sup>	16.02
Pound per square foot	Pascal, Pa	47.9
Pound per square inch	Pascal, Pa	$6.9 \times 10^3$
Quart	Liter, L	0.946
Square foot	Square meter, m <sup>2</sup>	$9.29 \times 10^{-2}$
Square inch	Square cm, cm <sup>2</sup>	6.45
Square mile	Square kilometer, km <sup>2</sup>	2.59
Ton (2000 lbs)	Kilogram, kg	907
Ton per acre	Megagram per ha, Mg ha <sup>-1</sup>	2.24

---





---

# References and Additional Readings

- Achard, F. K. 1786. Chemische Untersuchung des Torfs. Crell's. *Chem. Ann.* 2: 391–403.
- Ackert, L. 2006. The role of microbes in agriculture: Sergei Vinogradskii's discovery and investigation of chemosynthesis, 1880–1910. *J. Hist. Biol.* 39: 373–406.
- Adams, F. 1974. Soil Solution. In: *The Plant Root and Its Environment*, E. W. Carson (ed.). University Press of Virginia, Charlottesville, VA, pp. 441–481.
- Adler, H. H., P. F. Kerr, E. E. Bray, N. P. Stevens, J. M. Hunt, W. D. Keller, and E. E. Pickett. 1950. *Infrared Spectra of Reference Clay Minerals*. Am. Petroleum Inst., Project 49. Clay Mineral Standards Prelim. Report No. 8. Cornell University, Ithaca, NY.
- Afanasyev, G. N. 2004. *Vavilov–Cherenkov and Synchrotron Radiation: Foundations and Applications*. Kluwer Academic/Springer, New York.
- Agrawal, A. M., R. V. Manek, W. M. Colling, and S. H. Neau. 2003. Studies on the interaction of water with ethylcellulose: Effect of polymer particle size. *AAPS PharmSciTech* 4(4), article no. 60.
- Ahmad, F., and K. H. Tan. 1986. Effect of lime and organic matter on soybean seedlings grown in aluminum-toxic soil. *Soil Sci. Soc. Am. J.* 50: 656–661.
- Ahmad, N., and A. R. Mermut (eds.). 1996. *Vertisols and Technologies for Their Management*. Development in Soil Science 24. Elsevier Science, New York.
- Aiken, G. R., D. M. McKnight, R. L. Wershaw, and P. MacCarthy (eds.). 1985. *Humic Substances in Soils, Sediments, and Water*. Wiley Interscience, New York.
- Alewell, C. 2003. Acid inputs into the soils from acid rain. In: *Handbook of Soil Acidity*, Zdenko Rengel (ed.). Marcel Dekker, Inc., New York, pp. 83–116.
- Aliev, A. E., and R. V. Law. 2003. Solid state NMR spectroscopy. In: *Nuclear Magnetic Resonance*, Vol. 32, G. A. Webb (Senior Reporter). Royal Society of Chemistry, London, pp. 238–291.
- Allaby, A., and M. Allaby. 1999. Miller Indices. *A Dictionary of Earth Sciences*. <http://www.encyclopedia.com>, July 7, 2009.
- Allday, J. 2002. *Quarks, Leptons and the Big Bang*. Taylor & Francis/CRC Press, Boca Raton, FL.
- Anastas, P., and J. Warner. 1998. *Green Chemistry: Theory and Practice*. Oxford University Press, New York.
- Appelquist, T. W. 1986. Elementary particle. In: *McGraw-Hill Yearbook of Science and Technology*, McGraw-Hill, New York, pp. 184–186.
- ASA-CSSA-SSSA. 1998. *Publication Handbook and Style Manual*. American Society of Agronomy–Crop Science Society of America–Soil Science Society of America, Madison, WI.
- Anslyn, E. V., and D. A. Dougherty. 2005. *Modern Physical Organic Chemistry*. University Science Books, New York.
- Aslyng, H. C. 1963. Soil physics terminology. *Int. Soc. Soil Sci. Bull.* 23: 7–10.
- Baas Becking, L. G. M., I. R. Kaplan, and D. Moore. 1960. Limits of the natural environment in terms of pH and oxidation-reduction potential. *J. Geol.* 68: 243–284.
- Bagotsky, V. S. 2006. *Fundamentals of Electrochemistry*. Wiley Interscience, Hoboken, NJ.
- Baierlein, R. 2001. The elusive chemical potential. *Am. J. Phys.* 69(4): 423–434.
- Bailey, G. W., and J. L. White. 1970. Factors influencing the adsorption and movement of pesticides in soils. In: *Residue Reviews*, Vol. 32, F. A. Gunther and J. D. Gunther (eds.). Springer-Verlag, New York, pp. 29–92.
- Bailey, R. A., H. M. Clark, J. P. Ferris, S. Krause, and R. L. Strong. 2002. *Chemistry of the Environment*, 2nd ed. Elsevier Academic Press, New York.
- Barber, S. A. 1974. Influence of the plant root on ion movement in soil. In: *The Plant Root and Its Environment*, E. W. Carson (ed.). University of Virginia Press, Charlottesville, VA, pp. 525–564.
- Barber, S. A. 1981. Soil chemistry and the availability of plant nutrients. In: *Chemistry in the Soil Environment*, D. E. Baker (organ. comm.). ASA Publ. No. 40. Am. Soc. Agron., Madison, WI, pp. 1–12.
- Barnhisel, R. I. 1977. Chlorites and hydroxy interlayered vermiculite and smectite. In: *Minerals in Soil Environments*, J. B. Dixon, S. B. Weed, J. A. Kittrick, M. H. Milford, and J. L. White (eds.). *Soil Sci. Soc. Am.*, Madison, WI, pp. 331–356.
- Barrow, J. D. 2008. *New Theories of Everything*. Oxford University Press, New York.
- Bartlett, R. J. 1981. Oxidation-reduction status of aerobic soils. In: *Chemistry in the Soil Environment*, D. E. Baker (organ. comm.). ASA Publ. No. 40. Am. Soc. Agron., Madison, WI, pp. 77–102.

- Baver, L. D. 1963. The effect of organic matter on soil structure. *Pontif. Acad. Sci. Scr. Varia* 32: 383–413.
- Beaty, E. R., K. H. Tan, R. A. McCreery, J. H. Edwards Jr., and R. L. Stanley. 1976. Returned clippings and N fertilization on bahiagrass herbage production and nitrogen and organic matter contents of soil. *Agron. J.* 68: 384–387.
- Beckett, P. H. T. 1964a. Studies on soil potassium. I. Confirmation of the ratio law: Measurement of potassium potential. *J. Soil Sci.* 15: 1–8.
- Beckett, P. H. T. 1964b. Studies on soil potassium. II. The immediate Q/I relations of labile potassium in the soil. *J. Soil Sci.* 15: 9–23.
- Bergaya, F., B. K. G. Theng, and G. Lagaly (eds.). 2006. *Handbook of Clay Science*. Elsevier Science, New York.
- Bernstein, L., and L. E. Francois. 1973. Leaching requirement studies: Sensitivity of alfalfa to salinity of irrigation and drainage waters. *Soil Sci. Soc. Am. Proc.* 37: 931–943.
- Besoin, E. 1968. Imogolite in volcanic soils of Chile. *Geoderma* 2: 151–169.
- BIPI, Bureau International des Poids et Mesures. 2009. *La Système International d'Unités*, SI brochure, Section 5.2. Pavillon de Breteuil, Sevres Cedex, France.
- Birkeland, P. W. 1974. *Pedology, Weathering, and Geomorphological Research*. Oxford University Press, New York.
- Bjerrum, N., 1923. Die Konstitution der Ampholyte, besonders der Aminosäuren, und ihre Dissoziations-Konstanten. *Z. Phys. Chem.* 104: 147–173.
- Bland, D. E., and A. F. Logan. 1965. The properties of syringyl, guaiacyl, and p-hydroxyphenol artificial lignins. *Biochem. J.* 95: 515–520.
- Bloomfield, C. 1951. Experiments on the mechanism of gley formation. *J. Soil Sci.* 2: 196–211.
- Bloomfield, C. 1953. A study of podzolization. Part 1. The mobilization of iron and aluminum by Scots pine needles. *J. Soil Sci.* 4: 5–16.
- Bockris, J. O'M., A. K. N. Reddy, and M. E. Gamboa. 2008. *Modern Electrochemistry 2A: Fundamentals of Electrode Processes*, 2nd ed. Springer, New York.
- Bogoslovskiy, V. N., and B. V. Levinskiy. 2006. *Agro-Technologies of the Future. Book I. Energens. The New Generation of Humates*. UNITI Publishers, Moscow.
- Bohn, H., B. McNeal, and G. O'Connor. 1979. *Soil Chemistry*. Wiley Interscience, New York.
- Bohn, H., B. McNeal, and G. O'Connor. 2001. *Soil Chemistry*, 3rd ed. Wiley Interscience, New York.
- Bolt, G. H. 1967. Cation-exchange equations used in soil science—A review. *Neth. J. Agric. Sci.* 15: 81–103.
- Bolt, G. H. 1976. Adsorption of anions by soils. In: *Soil Chemistry. A. Basic Elements*, G. H. Bolt and M. G. M. Bruggenwert (eds.). Elsevier Science, Amsterdam, pp. 91–95.
- Bolt, G. H., and M. G. M. Bruggenwert (eds.). 1976. *Soil Chemistry. A. Basic Elements*. Elsevier Science, Amsterdam.
- Bolt, G. H., M. G. M. Bruggenwert, and A. Kamphorst. 1976. Adsorption of cations by soil. In: *Soil Chemistry. A. Basic Elements*, G. H. Bolt and M. G. M. Bruggenwert (eds.). Elsevier Science, Amsterdam, pp. 54–95.
- Boonsirichai, K., C. Guan, and P. H. Mason. 2002. Root gravitropism: An experimental tool to investigate basic cellular and molecular process underlying mechanosensing and signal transmission in plants. *Annu. Rev. Plant Biol.* 53: 421–447.
- Bowden, J. W., A. M. Posner, and J. P. Quirk. 1977. Ionic adsorption on variable charge mineral surfaces. Theoretical charge development and titration curves. *Aust. J. Soil Res.* 15: 121–136.
- Bowden, J. W., A. M. Posner, and J. P. Quirk. 1980. Adsorption and charging phenomena in variable charge soils. In: *Soils with Variable Charge*, B. K. G. Theng (ed.). New Zealand Soc. Soil Sci., Soil Bureau, Lower Hutt, pp. 167–194.
- Boyes, W. 2002. *Instrumentation Reference Book*, 3rd ed. Elsevier Butterworth-Heinemann, Oxford, UK.
- Brady, N. C. 1974. *The Nature and Properties of Soils*, 8th ed. MacMillan, New York.
- Brady, N. C. 1990. *The Nature and Properties of Soils*, 10th ed. MacMillan, New York.
- Brady, N. C., and R. R. Weil. 1996. *The Nature and Properties of Soils*, 11th ed. Prentice Hall, Upper Saddle River, NJ.
- Brady, N. C., and R. R. Weil. 2008. *The Nature and Properties of Soils*, 14th ed. Pearson–Prentice Hall, Upper Saddle River, NJ.
- Bragg, Sir L., and G. F. Claringbull. 1965. *Crystal Structures of Minerals*. Bell, London.
- Bray, H. G., and K. White. 1966. *Kinetics and Thermodynamics in Biochemistry*. Churchill Ltd., London.
- Brewer, R., and J. R. Sleeman. 1960. Soil structure and fabric. Their definition and description. *J. Soil Sci.* 11: 172–185.
- Brindley, G. W., and T. D. Thompson. 1966. Clay organic studies. XI. Complexes of benzene, pyridine and 1,3-substituted propanes with a synthetic Ca-fluor-hectorite. *Clay Miner.* 6: 345–351.

- Brindley, G. W., S. W. Bailey, G. T. Faust, S. A. Forman, and C. I. Rich. 1968. Report of the nomenclature committee (1966–1967) of the Clay Minerals Society. *Clays Clay Miner.* 16: 322–324.
- Brogliè, Louis de. 1984. *The Wave-Particle Dualism*. Springer, New York.
- Brunauer, S., P. H. Emmett, and E. Teller. 1938. Adsorption of gases in multimolecular layers. *J. Am. Chem. Soc.* 60: 309–319.
- Buckingham, E. 1907. Studies on the movement of soil moisture. *USDA Bureau of Soils Bull.* 38, Washington, DC.
- Budzikiewicz, H., and R. D. Grigsby. 2006. Mass spectrometry and isotopes: A century of research and discussion. *Mass Spectrom. Rev.* 25(1): 146–157.
- Buol, S. W., R. J. McCracken, and F. D. Hole. 1973. *Soil Genesis and Classification*. Iowa State University Press, Ames, IA.
- Buol, S. W., R. J. Southard, R. C. Graham, and P. A. McDaniel. 2008. *Soil Genesis and Classification*. Wiley-Blackwell, New York.
- Burdick, E. M. 1965. Commercial humates for agriculture and the fertilizer industry. *Econ. Bot.* 19: 152–156.
- Burges, A. 1960. The nature and distribution of humic acid. *Scient. Proc. R. Dublin Soc. Ser. A* 1: 53–59.
- Burns, G., M. H. B. Hayes, and M. Stacey. 2006. Some physicochemical interactions of paraquat with soil organic materials and model compounds. *Weed Res.* 13(1): 79–90.
- Burns, R. G. 1986. Interactions of enzymes with soil minerals. In: *Interactions of Soil Minerals with Natural Organics and Microbes*, P. M. Huang and M. Schnitzer (eds.). SSSA Special Publ. No. 7. Soil Sci. Soc. Am., Madison, WI, pp. 429–451.
- Calvin, M., and J. A. Bassham. 1962. *The Photosynthesis of Carbon Compounds*. Benjamin, Menlo Park, CA.
- Campbell, N., B. Williamson, and R. Heyden. 2006. *Biology, Exploring Life*. Pearson-Prentice Hall, Upper Saddle River, NJ.
- Carter, C. B., and M. G. Norton. 2007. *Ceramic Materials: Science and Engineering*. Springer, New York.
- Caurie, M. 2006. The derivation of the GAB equation from the BDDT adsorption theory. *Int. J. Food Sci. Technol.* 41(2): 173–179.
- Chapman, D. L. 1913. A contribution to the theory of electrocapillarity. *Philos. Mag.* 25(6): 475–481.
- Chen, C., J. B. Dixon, and F. T. Turner. 1980. Iron coatings on rice roots. Morphology and models of development. *Soil Sci. Soc. Am. J.* 44: 1113–1119.
- Chen, Y., and M. Schnitzer. 1976. Scanning electron microscopy of a humic acid and its metal and clay complexes. *Soil Sci. Soc. Am. J.* 40: 682–686.
- Chen, Y., N. Senesi, and M. Schnitzer. 1977. Information provided on humic substances by  $E_4/E_6$  ratios. *Soil Sci. Soc. Am. J.* 41: 352–358.
- Chen, Y., N. Senesi, and M. Schnitzer. 1978. Chemical and physical characteristics of humic and fulvic acids extracted from soils of the Mediterranean region. *Geoderma* 20: 87–104.
- Cheshire, M. V., and D. B. McPhail. 2005. Hyperfine splitting in the electron spin resonance solution spectra of humic substances. *Eur. J. Soil Sci.* 47(2): 205–213.
- Chesworth, W. (ed.). 2008. *Encyclopedia of Soil Science*. Springer, New York
- Chorover, J. 2006. Andisols. In: *Encyclopedia of Soil Science*, R. Lal (ed.). Taylor & Francis/CRC Press, Boca Raton, FL, pp. 101–104.
- Choudhry, G. G. 1983. *Humic Substances: Structural, Photophysical, Photochemical, and Free Radical Aspects, and Interactions with Environmental Chemicals*. Garden Beach Science, New York.
- Chow, C. K. (ed.). 2007. *Fatty Acids in Foods and Their Health Implications*, 3rd ed. Taylor & Francis/CRC Press, Boca Raton, FL.
- Clark, F. E., and K. H. Tan. 1969. Identification of a polysaccharide ester linkage in humic acid. *Soil Biol. Biochem.* 1: 75–81.
- Cohen, I. R., T. Civitas, J. G. Frey, B. Holström, K. Kuchutsie, R. Marquardt, I. Mills, F. Pavese, M. Quack, J. Stohner, H. L. Straus, M. Takami, and A. J. Thor. 2007. *Quantities, Units and Symbols in Physical Chemistry*. The IUPAC Green Book, 3rd ed. RSC (Royal Society of Chemistry) Publishing, Cambridge, UK.
- Comis, D. 2002. Glomalin: Hiding place for a third of the world's stored soil carbon. *USDA-ARS, Agric. Res. Mag.* 50(9): 4–7.
- Connell, D. W., and G. J. Miller. 1984. *Chemistry and Ecotoxicology of Pollution*. Wiley-Interscience, New York.
- Conte, P., R. Spaccini, and A. Piccolo. 2006. Advanced CPMAS- $^{13}\text{C}$  NMR techniques for molecular characterization of size-separated fractions from a soil humic acid. *Anal. Bioanal. Chem.* 386(2): 382–390.
- Cook, F. J., and J. H. Knight. 2003. Oxygen transport to plant roots. Modeling for physical understanding of soil aeration. *Soil Sci. Soc. Am. J.* 67: 20–31.
- Cook, R. L., and C. H. Langford. 1998. Structural characterization of a fulvic acid and a humic acid using solid-state ramp-CP-MAS  $^{13}\text{C}$  nuclear magnetic resonance. *Environ. Sci. Technol.* 32(5): 719–725.

- Cooke, J. D., J. Hamilton-Taylor, and E. Tipping. 2007. On the acid-base properties of humic acid in soil. *Environ. Sci. Technol.* 42(2): 465–470.
- Cornell, R. M., and U. Schwertmann. 2004. *The Iron Oxides*, 2nd ed. Wiley Interscience, New York.
- Cosgrove, T. 2005. *Colloid Science: Principles, Methods, and Applications*. Wiley–Blackwell, Hoboken, NJ.
- Cragg, R. H. 1971. Lord Ernest Rutherford. *Chem. Br.* 7: 518.
- Cranwell, P. A., and R. D. Haworth. 1975. The chemical nature of humic acids. In: *Humic Substances, Their Structure and Function in the Biosphere*, D. Povoledo and H. L. Golterman (eds.). Centre Agric. Publ. Doc., Wageningen, The Netherlands, pp. 13–18.
- Curie, M. 2002. *Radioactive Substances*. Dover Publications, Mineola, NY.
- Davies, C. W. 1962. *Ion Association*. Butterworth, Washington, DC.
- Davis, L. E. 1945. Simple kinetic theory of ionic exchange for ions of unequal charge. *J. Phys. Chem.* 49: 473–479.
- Debye, P., and E. Hückel. 1923. The theory of electrolytes. I. Lowering of freezing point and related phenomena. *Physikalische Zeitschrift* 24: 185–206.
- De Coninck, F. 1980. Major mechanisms in formation of spodic horizons. *Geoderma* 24: 101–128.
- Degens, E. T., and K. Mopper. 1975. Early diagenesis of organic matter in marine soils. *Soil Sci.* 119: 65–72.
- De La Rosa, J. M., H. Knicker, E. Lopez-Capel, D. A. C. Manning, J. A. Gonzalez-Perez, and F. J. Gonzalez-Vila. 2008. Direct detection of black carbon in soils by Py-GC/MS, Carbon-13 NMR spectroscopy and thermogravimetric techniques. *Soil Sci. Soc. Am. J.* 72(1): 258–267.
- De Levie, R. 2003. The Henderson–Hasselbalch equation: Its history and limitations. *J. Chem. Ed.* 80: 146–147.
- De Rujula, A. 1983. Neutrino exploration of the Earth. *Phys. Rep.* 99(6): 341–396.
- Dell’Agnola, G., and S. Nardi. 1986. News about biological effect of humic substances. In: *Humic Substances. Effects on Soil and Plants*, REDA (ed.). Ramo Editoriale degli Agricoltori, Milano, Italy, pp. 78–88.
- Delzer, G. C., and S. W. McKenzie. 2003. *Five Day Biochemical Oxygen Demand*, 3rd ed. U.S. Geological Survey, Technique of Water Resources Investigations, USGS, TWRI book 9-A7.
- Di Pasquale, M. G. (ed.). 2007. *Amino Acids and Protein for the Athlete. The Anabolic Edge*, 2nd ed. Taylor & Francis/CRC Press, Boca Raton, FL.
- Dixon, J. B. 1977. Kaolinite and serpentine group minerals. In: *Minerals in Soil Environment*, J. B. Dixon, S. B. Weed, J. A. Kittrick, M. H. Milford, and J. L. White (eds.). Soil Sci. Soc. Amer. Madison, WI, pp. 357–403.
- Donahue, R. L., R. W. Miller, and J. C. Shickluna. 1977. *Soils, An Introduction to Soils and Plant Growth*. Prentice Hall, Englewood Cliffs, NJ.
- Dormaar, J. F. 1974. Scanning electron microscopy as applied to organo-mineral complexes in alkaline extracts of soil. *Soil Sci. Soc. Am. Proc.* 38: 685–686.
- Dormaar, J. F. 1975. Effects of humic substances from Chernozemic A<sub>h</sub> horizons on nutrient uptake by *Phaseolus vulgaris* and *Festuca sabrella*. *Can. J. Soil Sci.* 55: 111–118.
- Douglas, L. A. 1977. Vermiculite. In: *Minerals in Soil Environments*, J. B. Dixon, S. B. Weed, J. A. Kittrick, M. H. Milford, and J. L. White (eds.). Soil Sci. Soc. Am., Madison, WI, pp. 259–292.
- Dria, K. J., J. R. Sachleben, and P. G. Hatcher. 2002. Solid-state carbon-13 nuclear magnetic resonance of humic acids at high magnetic field strengths. *J. Environ. Qual.* 31: 393–401.
- Durant, W. 1980. *The Age of Faith. The Story of Civilization*, Vol. 4, pp. 162–186. Simon & Schuster, New York.
- Eapen, D., M. L. Barroso, G. Ponce, M. E. Campos, and G. I. Cassab. 2005. Hydrotropism: Root growth responses to water. *Trends in Plant Sci.* 10: 44–50.
- Egawa, T., and Y. Watanabe. 1964. Electron micrographs of the clay minerals in Japanese soils. *Bull. Natl. Inst. Agric. Sci. (Jpn) Series B14*.
- Ellis, J., G. Guidice, M. L. Mangano, I. Tkachev, and U. Wiedemann. 2008. Review of the safety of LHC collisions. LHC Safety Assessment Group, 5 September. *J. Phys. G: Nucl. Part. Phys.* 35: 115004–115022.
- El-Swaify, S. A. 1979. Irrigation water. In: *The Encyclopedia of Soil Science. Part 1. Physics, Chemistry, Biology, Fertility, and Technology*. Dowden, Hutchinson and Ross, Stroudsburg, PA, pp. 251–255.
- Eltantawy, I. M. 1980. The effect of heating on humic acid structure and electron spin resonance signal. *Soil Sci. Soc. Am. J.* 44: 512–514.
- Eltantawy, I. M., and M. Bavarez. 1978. Structural study of humic acids by x-ray, electron spin resonance, and infrared spectroscopy. *Soil Sci. Soc. Am. J.* 42: 903–905.
- Emerson, W. W., R. C. Foster, and J. M. Oades. 1986. Organo-mineral complexes in relation to soil aggregation and structure. In: *Interactions of Soil Minerals with Natural Organics and Microbes*, P. M. Huang and M. Schnitzer (eds.). SSSA Special Publ. No. 17. Soil Sci. Soc. Am., Madison, WI, pp. 521–548.



- Erhart, H. 1967. *La Genèse des Sols en tant que Phénomène Géologique. Esquisse de Théorie Géologique et Géochimique. Biostasie et Rhéxistatie*, 3rd ed. Masson, Paris.
- Eriksson, E. 1952. Cation exchange equilibria on clay minerals. *Soil Sci.* 74: 103–113.
- Essington, M. E. 2003. *Soil and Water Chemistry: An Integrative Approach*. Taylor & Francis/CRC Press, Boca Raton, FL.
- Esteban, C., G. Lopez, A. Herrero, and F. Sanchez. 2009. *Cosmochemistry: The Melting Pot of the Elements*. Cambridge University Press, New York.
- Eswaran, H. 1972. Morphology of allophane, imogolite and a halloysite. *Clay Miner.* 9: 281–285.
- Eswaran, H., G. Stoops, and C. Sys. 1977. The micromorphology of gibbsite forms in soils. *J. Soil Sci.* 28: 136–143.
- Evans, R. C. 1939. *An Introduction to Crystal Chemistry*. Cambridge University Press, London.
- Fahy, E., S. Subramaniam, A. Brown, C. K. Glass, A. H. Merrill, Jr., R. C. Murphy, C. R. H. Clark, D. W. Russell, Y. Seyama, W. Shaw, T. Shimizu, F. Spener, G. van Meer, M. S. van Nieuwenhze, S. H. White, J. L. Witztum, and E. A. Dennes. 2005. A comprehensive classification system for lipids. *J. Lipid Res.* 46: 839–862.
- Fanning, D. S., and V. Z. Keramidas. 1977. Micas. In: *Minerals in Soil Environments*, J. B. Dixon, S. B. Weed, J. A. Kittrick, M. H. Milford, and J. L. White (eds.). Soil Sci. Soc. Am., Madison, WI, pp. 195–258.
- Farmer, V. C. 1968. Infrared spectroscopy in clay mineral studies. *Clay Miner.* 7: 373–387.
- Farmer, V. C., and F. Palmieri. 1975. The characterization of soil minerals by infrared spectroscopy. In: *Soil Components, Vol. 2. Inorganic Components*, J. E. Gieseking (ed.). Springer-Verlag, New York, pp. 573–671.
- Farmer, V. C., A. R. Fraser, J. D. Russell, and N. Yoshinaga. 1977. Recognition of imogolite structure in allophane clays by infrared spectroscopy. *Clay Miner.* 12: 55–57.
- Farmer, V. C., W. J. McHardy, L. Robertson, A. Walker, and M. J. Wilson. 1985. Micromorphology and sub-microscopy of allophane and imogolite in a Podzol Bs horizon: Evidence for translocation and origin. *J. Soil Sci.* 36: 87–95.
- Farrar, J. J. 2002. Fairy rings: Fantasy or nightmare? United States Golf Association, USGA Green Section Record, November/December.
- Felbeck, Jr., G. T. 1965. Structural chemistry of soil humic substances. *Adv. Agron.* 17: 327–368.
- FIFA, Fertilizer Industry Federation of Australia. 2006. *Australian Soil Fertility Manual*. CSIRO, Collingwood, Victoria, Australia.
- Fiorentino, G., R. Spaccini, and A. Piccolo. 2006. Separation of molecular constituents from a humic acid by solid-phase extraction following a transesterification reaction. *Talanta* 68: 1135–1142.
- Fipps, G. 2003. Irrigation water quality standards and salinity management. Fact Sheet B-1667. Texas Coop. Extension Service, Texas A&M University, College Station, TX.
- Fisher, M. J., D. A. Charles-Edwards, and M. M. Ludlow. 1981. An analysis of the effects of repeated short-term soil water deficits on stomatal conductance to carbon dioxide and leaf photosynthesis by the legume *Macroptilium atropurpureum* cv. Siratro. *Aust. J. Plant Physiol.* 8: 347–357.
- Flaig, W. 1975. An introductory review on humic substances: Aspects of research on their genesis, their physical and chemical properties, and their effect on organisms. In: *Humic Substances, Their Structure and Function in the Biosphere*, D. Povoledo and H. L. Golterman (eds.). Centre Agric. Publ. Doc., Wageningen, The Netherlands, pp. 19–42.
- Flaig, W., and H. Beutelspacher. 1951. Electron microscope investigations on natural and synthetic humic acids. *Z. Pflanzenernähr. Dung. Bodenk.* 52: 1–21.
- Flaig, W., H. Beutelspacher, and E. Rietz. 1975. Chemical composition and physical properties of humic substances. In: *Soil Components, Vol. 1. Inorganic Components*, J. E. Gieseking (ed.). Springer-Verlag, New York, pp. 1–211.
- Flood, H., and T. Forland. 1947. The acidic and basic properties of oxides. *Acta Chemica Scandinavica* 1: 592–598.
- Foster, M. D. 1962. Interpretation of the composition and a classification of the chlorites. U.S. Geological Survey Professional Paper 414A.
- Foth, H. D., and L. M. Turk. 1978. *Fundamentals of Soil Science*. John Wiley & Sons, New York.
- Freundlich, H. 1926. *Colloid and Capillary Chemistry*. Methuen, London.
- Friedman, M. H. 2008. *Principles and Models of Biological Transport*. Springer, New York.
- Fripiat, J. J. 1965. Surface chemistry and soil science. In: *Experimental Pedology*, E. G. Hallsworth and D. W. Crawford (eds.). Butterworths, London, pp. 3–24.
- Frissel, M. J. 1961. The adsorption of some organic compounds, especially herbicides, on clay minerals. *Verslag Landbouwk. Onderzoek* 76: 3–14.

- Frissel, M. J., and G. H. Bolt. (1962). Interaction between certain ionizable organic compounds (herbicides) and clay minerals. *Soil Sci.* 94: 284–291.
- Furia, T. E. 1980. *Handbook of Food Additives*, 2nd ed., Vol. II. CRC Press, Boca Raton, FL.
- Gaillard, M. K. 1983. Toward a unified picture of elementary particle interactions. *Am. Sci.* 70: 506–514.
- Gaillard, M. K. 1986. Superconducting supercollider. In: *McGraw-Hill Yearbook of Science and Technology*, S. P. Parker (ed.). McGraw-Hill, New York, pp. 333–335.
- Gaines, G. L., and H. C. Thomas. 1955. Adsorption studies on clay minerals. II. A formulation of the thermodynamics of exchange adsorption. *J. Chem. Phys.* 21: 714–718.
- Gapon, E. N. 1933. Theory of exchange adsorption in soils. *J. Gen. Chem.* (USSR) 3: 144–152.
- Garrels, R. M., and C. L. Christ. 1965. *Solutions, Minerals, and Equilibria*. Harper & Row, New York.
- Garrett, A. B. 1962. The flash genius: The Bohr atomic model: Niels Bohr. *J. Chem. Educ.* 39: 534.
- Gast, R. C. 1977. Surface and colloid chemistry. In: *Minerals in Soil Environments*, J. B. Dixon, S. B. Weed, J. A. Kittrick, M. H. Milford, and J. L. White (eds.). Soil Sci. Soc. Am., Madison, WI, pp. 27–73.
- Ghabbour, E. A., and G. Davies. 2005. *Humic Substances: Molecular Details and Applications in Land and Water Conservation*. Taylor & Francis, New York.
- Ghosh, K., and M. Schnitzer. 1980a. Effects of pH and neutral electrolyte concentration on free radicals in humic substances. *Soil Sci. Soc. Am. J.* 44: 975–978.
- Ghosh, K., and M. Schnitzer. 1980b. Fluorescence excitation spectra of humic substances. *Can. J. Soil Sci.* 60: 373–379.
- Ghosh, K., and M. Schnitzer. 1980c. Macromolecular structures of humic substances. *Soil Sci.* 129: 266–276.
- Giles, C. H., T. H. McEwan, S. N. Nakhwa, and D. Smith. 1960. Studies in adsorption. Part XI. A system of classification of solution adsorption isotherms, and its use in diagnosis of adsorption mechanisms and in measurement of specific surface areas of solids. *J. Chem. Soc.*, 3973.
- Giunti, C., and C. W. Kim. 2007. *Fundamentals of Neutrino Physics and Astrophysics*. Oxford University Press, New York.
- Glashow, S. L. 1986. Neutrino. In: *McGraw-Hill Yearbook of Science and Technology*. McGraw-Hill, New York, pp. 304–306.
- Glasstone, S. 1946. *Textbook of Physical Chemistry*. Van Nostrand, Princeton, NJ.
- Goenadi, D. H., and K. H. Tan. 1988. Differences in clay mineralogy and oxidic ratio of selected LAC soils in temperate and tropical regions. *Soil Sci.* 146: 151–159.
- Goenadi, D. H., and K. H. Tan. 1991. The weathering of paracrystalline clays into kaolinite in Andisols and Ultisols in Indonesia. *Indonesian J. Trop. Agric.* 2: 56–65.
- Goh, K. M., and F. J. Stevenson. 1971. Comparison of infrared spectra of synthetic and natural humic and fulvic acids. *Soil Sci.* 112: 392–400.
- Gollany, H. T., P. R. Bloom, and T. E. Schumacher. 1997. Rhizosphere soil-water collection by immiscible displacement-centrifugation technique. *Plant Soil* 188(1): 59–64.
- Gortner, R. A., and W. A. Gortner. 1949. *Outlines of Biochemistry*. Wiley & Sons, New York.
- Gouy, G. 1910. Sur la constitution de la charge électrique à la surface d'un électrolyte. *Ann. Phys. (Paris) Ser.* 4, 9: 457–468.
- Gowariker, V., V. N. Krishnamurthy, S. Gowariker, M. Dhanorkar, and K. Paranjape. 2009. *The Fertilizer Encyclopedia*. Wiley Interscience, New York.
- Graff, P., and P. Reaney. 2005. Soil in temperate climate releases about 300 times the amount of carbon a year than burning fossil fuel does. *News in Science*, Sidney, Australia.
- Greene, B. 1999. *The Elegant Universe: Superstrings, Hidden Dimensions, and the Quest for the Ultimate Theory*. Norton & Company, New York.
- Greene, B. 2003. *A theory of everything? Some physicists believe string theory may unify the forces of nature*. NOVA/PBS, Science Programming. <http://www.pbs.org/wgbh/nova/elegant/>.
- Greenland, D. J. 1965. Interaction between clays and organic compounds in soils. 1. Mechanisms of interaction between clays and defined organic compounds. *Soils Fertil.* 28: 415–425.
- Greenland, D. J. 1971. Interactions between humic and fulvic acids and clays. *Soil Sci.* 111: 34–41.
- Greenland, D. J., and J. P. Quirk. 1962. Surface areas of soil colloids. Trans. Int. Soil Sci. Conf. Commun. IV and V, Palmerston North, New Zealand, pp. 79–87.
- Greenland, D. J., and J. P. Quirk. 1964. Determination of the total surface areas of soils by adsorption of cetyl pyridium bromide. *J. Soil Sci.* 15: 178–191.
- Greenland, D. J., and M. H. B. Hayes (eds.). 1978. *The Chemistry of Soil Constituents*. Wiley-Interscience, New York.
- Greenland, D. J., and C. J. B. Mott. 1978. Surfaces of soil particles. In: *The Chemistry of Soil Constituents*, D. J. Greenland and M. H. B. Hayes (eds.). Wiley & Sons, New York, pp. 321–353.



- Greenland, D. J., G. R. Lindstrom, and J. P. Quirk. 1961. Role of polysaccharides in stabilization of natural soil aggregates. *Nature* 191: 1283–1284.
- Greenland, D. J., G. R. Lindstrom, and J. P. Quirk. 1962. Organic materials which stabilize natural soil aggregates. *Soil Sci. Soc. Am. Proc.* 26: 366–371.
- Griffiths, D. J. 1987. *Introduction to Elementary Particles*. John Wiley & Sons, New York.
- Grimshaw, R. W. 1971. *The Chemistry and Physics of Clays*. Wiley-Interscience, New York.
- Grot, W. 2007. *Fluorinated Ionomers*. Plastic Design Library—William Andrew Publishing/Elsevier, New York.
- Guminski, S. 1957. The mechanism and conditions of the physiological actions of humic substances on the plant. *Pochvovedenie* 12: 36.
- Guminski, S., and Z. Guminska. 1953. Studies on the activity of humus on plants. *Acta Soc. Bot. Pol.* 22: 45–54.
- Guminski, S., D. Augustin, and J. Sulej. 1977. Comparison of some chemical and physico-chemical properties of natural and model sodium humates and of biological activity of both substances in tomato water cultures. *Acta Soc. Bot. Pol.* XVI: 437–448.
- Hadzi, D., C. Klofutar, and S. Oblak. 1968. Hydrogen bonding in some adducts of oxygen bases with acids. Part IV. Basicity in hydrogen bonding and in ionization. *J. Chem. Soc. (A)*: 905–918.
- Hall, M. B. 1966. The background of Dalton's atomic theory. *Chem. Br.* 2: 341.
- Hamann, C. H., A. Hamnett, W. Vielstich, and T. Iwasita. 2007. *Electrochemistry*, 2nd rev. updated ed. Wiley–VCH Verlag GmbH, Weinheim, Germany.
- Harter, R. D., and G. Smith. 1981. Langmuir equation and alternate methods of studying “adsorption” reactions in soils. In: *Chemistry in the Soil Environment*, R. H. Dowdy, J. A. Ryan, V. V. Volk, and D. E. Baker (eds.). ASA Special Publ. No. 40. Am. Soc. Agron., Soil Sci. Soc. Am., Madison, WI, pp. 167–182.
- Hatcher, P. G., R. Rowan, and M. A. Mattingly. 1980. <sup>1</sup>H and <sup>13</sup>C NMR of marine humic acids. *Org. Chem.* 2: 77–85.
- Hatcher, P. G., G. E. Maciel, and W. L. Dennis. 1981. Aliphatic structure of humic acids: A clue to their origin. *Org. Geochem.* 2: 43–48.
- Hatcher, P. G., J. L. Faulon, D. A. Clifford, and J. P. Matthews. 1994. A three-dimensional structural model for humic acids from oxidized soil. In: *Humic Substances in the Global Environment and Implications on Human Health*, N. Senesi and T. M. Miano (eds.). Proc. 6th Intern. Meeting of the Intern. Humic Substances Soc., Monopoly, Bari, Italy, September 20–25, 1992. Elsevier, Amsterdam, pp. 133–138.
- Hayes, M. H. B., and C. E. Clapp. 2001. Humic substances: Considerations of compositions, aspects of structure, and environmental influences. *Soil Sci.* 166(11): 723–737.
- Heitner, C., S. Sarkanen, N. G. Lewis, and D. Dimmel (eds.). 2009. *Lignin and Lignans: Advances in Chemistry*. Taylor & Francis/CRC Press, Boca Raton, FL.
- Hem, J. D., and W. H. Cropper. 1959. Survey of ferrous-ferric chemical equilibria and redox potentials. U.S. Geological Survey Water Supply Paper 1459A.
- Hendricks, S. B. 1941. Base exchange of the clay mineral montmorillonite for organic cations and its dependence upon adsorption due to Van der Waals forces. *J. Phys. Chem.* 45: 65–81.
- Hillel, D. 1972. *Soil and Water. Physical Principles and Processes*. Academic Press, New York.
- Hingston, F. J., R. J. Atkinson, A. M. Posner, and J. P. Quirk. 1968. Specific adsorption of anions on goethite. *Trans. 9th Int. Congr. Soil Sci.* 1: 669–677.
- Hodgson, J. F. 1969. Metal-organic complexing agents and transport of metal to roots. *Soil Sci. Soc. Am. Proc.* 33: 68–75.
- Hoffmann, R. W., and G. W. Brindley. 1960. Adsorption of nonionic aliphatic molecules from aqueous solutions on montmorillonite. Clay-organic studies II. *Geochim. Cosmochim. Acta* 20: 15–29.
- Holbrook, N. M., and M. A. Zwieniecki (eds.). 2005. *Vascular Transport in Plants*, 4th ed. Elsevier Academic Press, New York.
- Holty, J. G., and P. E. Heilman 1971. Molecular sieve fractionation of organic matter in a Podzol from south-eastern Alaska. *Soil Sci.* 112: 351–356.
- Hu, T. Q. (ed.). 2002. *Chemical Modification, Properties and Usage of Lignin*. Springer, New York.
- Huang, P. M., and A. Violante. 1986. Influence of organic acids on crystallization and surface properties of precipitation products of aluminum. In: *Interactions of Soil Minerals with Natural Organics and Microbes*, P. M. Huang and M. Schnitzer (eds.). SSSA Special Publ. No. 17. Soil Sci. Soc. Am., Madison, WI, pp. 159–221.
- Huang, P. M., M. K. Wang, and C. Y. Chiu. 2005. Soil mineral–organic matter–microbe interactions: Impacts on biogeochemical processes and biodiversity in soils. *J. Pedobiologia* 49: 609–615.
- Huang, Q., P. M. Huang, and A. Violante. 2008. *Soil Mineral–Organic Interactions. Theories and Applications*. Springer, New York.

- Hud, N. V. (ed.). 2008. *Nucleic Acid–Metal Ion Interactions*. RSC (Royal Society Chemistry), London.
- Huggett, R. 2003. *Fundamentals of Geomorphology*. Taylor & Francis/Routledge, New York.
- Hughes, A. B. (ed.). 2009. *Amino Acids, Peptides and Proteins in Organic Chemistry. Vol. 1—Origin and Synthesis of Amino Acids*. Wiley–VCH, Weinheim, Germany.
- Hurlbut, Jr., C. S., and C. Klein. 1977. *Manual of Mineralogy* (after James Dana), 19th ed. Wiley & Sons, New York.
- Inglezakis, V. J., and S. G. Pouloupoulos. 2006. *Adsorption, Ion Exchange and Catalyst. Design of Operations and Environmental Applications*. Elsevier Science, New York.
- Inoue, K., and P. M. Huang. 1990. Perturbation of imogolite formation by humic substances. *Soil Sci. Soc. Am. J.* 54: 1490–1497.
- Inoue, T., and K. Wada. 1973. Adsorption of humified clover extracts by various clays. Trans. 9th Int. Congr. Soil Sci., Vol. 3, Adelaide, Australia, 1968. American Elsevier, New York, pp. 289–298.
- International Union of Pure and Applied Chemistry (IUPAC). 2009. *Compendium of Chemical Terminology. Version 2.0.3. “The Gold Book.”* RSC (Royal Society of Chemistry) Publishing, Cambridge, UK.
- Jackson, M. L., and G. D. Sherman. 1953. Chemical weathering of minerals in soils. *Adv. Agron.* 5: 219–318.
- Jackson, T. A. 1975. Humic matter in natural waters and sediments. *Soil Sci.* 119: 56–64.
- Janzen, H. H. 1993. Soluble salts. In: *Soil Sampling and Methods of Analysis*, M. R. Carter (ed.). Lewis, Boca Raton, FL, pp. 161–166.
- Jeffery, J. W. O. 1960. Iron and the  $E_h$  of waterlogged soils with particular reference to paddy. *J. Soil Sci.* 11: 140–148.
- Jenny, H. 1936. Simple kinetic theory of ionic exchange. I. Ions of equal valency. *J. Phys. Chem.* 40: 501–517.
- Job, G., and F. Hermann. 2006. Chemical potential—A quantity in search of recognition. *Euro. J. Phys.* 27: 353–371
- Johnson, S. L., and K. A. Rumon. 1965. Infrared spectra of solid 1:1 pyridine–benzoic acid complexes; the nature of the hydrogen bond as a function of the acid-base level in the complex. *J. Phys. Chem.* 69: 74–79.
- Joussein, E., S. Petit, J. Churchman, B. Theng, D. Righi, and B. Delvaux. 2005. Halloysite clay minerals—A Review. *Clay Miner.* 40(4): 383–426.
- Kamphorst, A., and G. H. Bolt. 1976. Saline and sodic soils. In: *Soil Chemistry. A. Basic Elements*, G. H. Bolt and M. G. M. Bruggenwert (eds.). Elsevier Scientific, Amsterdam, pp. 171–191.
- Kaplan, T. A. 2006. The chemical potential. *J. Stat. Phys.* 122(6): 1237–1260.
- Karnok, K. A., E. J. Rowland, and K. H. Tan. 1993. High pH treatments and the alleviation of soil hydrophobicity in golf greens. *Agronomy J.* 85: 983–986.
- Keddy, P. A. 2007. *Plants and Vegetation. Origin, Processes, Consequences*. Cambridge University Press, New York.
- Keeling, R. F., S. C. Piper, A. F. Bollenbacher, and S. J. Walker. 2008. Atmospheric CO<sub>2</sub> values (ppmv) derived from in situ air samples collected at Mauna Loa, Hawaii, USA. Carbon Dioxide Research Group, Scripps Institute of Oceanography (SIO), University of California, La Jolla.
- Keller, W. D. 1954. Bonding energies of some silicate minerals. *Am. Mineral.* 39: 783–793.
- Keller, W. D. 1964. Processes of origin and alteration of clay minerals. In: *Soil Clay Mineralogy. A Symposium*, C. I. Rich and G. W. Kunze (eds.). University of North Carolina Press, Chapel Hill, pp. 3–76.
- Kennedy, I. R. 1992. *Acid Soil and Acid Rain*, 2nd ed. Res. Studies Press. Taunton, Somerset, England.
- Kestenbaum, D. 2007. The world’s largest particle accelerator. NPR, National Public Radio, News, April 9, Washington, DC.
- Khan, M. A., and D. J. Weber (eds.). 2009. *Ecophysiology of High Salinity Tolerant Plants*. Springer, New York.
- Kim, J. S. 2008. Morphological characteristics and lignin distribution in bamboo (*Phyllostachys pubescens*) degraded by the white rot fungus *Lentinus edodes*. *Holz Forschung* 62(4): 481–487.
- Kirkham, M. B. 2005. *Principles of Soil and Plant Water Relations*. Elsevier Academic Press, New York.
- Kirkwood, J. G., and Z. W. Salsburg. 2001. *Theory of Solutions. Documents on Modern Physics*. Taylor & Francis/Gordon and Breach, London.
- Kittrick, J. A. 1967. Gibbsite-kaolinite equilibria. *Soil Sci. Soc. Am. Proc.* 31: 314–316.
- Kittrick, J. A. 1969. Soil minerals in the Al<sub>2</sub>O<sub>3</sub>-SiO<sub>2</sub>-H<sub>2</sub>O system and a theory of their formation. *Clays Clay Miner.* 17: 157–167.
- Kleijn, W. B., and J. D. Oster. 1983. Effects of permanent charge on the electric double layer properties of clays and oxides. *Soil Sci. Soc. Am. J.* 47: 821–827.
- Klotz, I. M. 1950. *Chemical Thermodynamics*. Prentice Hall, Englewood Cliffs, NJ.
- Kolthoff, I. M., and E. B. Sandell. 1952. *Textbook of Quantitative Inorganic Analysis*. Macmillan, New York.
- Kononova, M. M. 1961. *Soil Organic Matter*, T. Z. Nowakowski and G.A. Greenwood (trans.). Pergamon, Oxford.

- Kononova, M. M. 1966. *Soil Organic Matter*. Pergamon, Oxford.
- Koudriavtsev, A. B., R. F. Jameson, and W. Linert. 2001. *The Law of Mass Action*. Springer, New York.
- Krauskopf, K. B. 1956. Dissolution and precipitation of silica at low temperatures. *Geochim. Cosmochim. Acta* 10: 1–26.
- Krauskopf, K. B. 2003. *Introduction to Geochemistry*. McGraw-Hill College, New York.
- Kreider, R. B. 1999. Effects of protein and amino acid supplementation on athlete performance. *Sportscience* 3(1): 1–14.
- Krishnamoorthy, C., and R. Overstreet. 1949. Theory of ion exchange relationships. *Soil Sci.* 68: 307–315.
- Kruyt, H. R. 1944. *Inleiding tot de Physische Chemie*. Uitgeverij H.J. Paris, Amsterdam.
- Kubicki, J. D., and S. Apitz. 1999. Models of natural organic matter and contaminants. *Org. Geochem.* 30: 911–927.
- Kubiena, W. L. 1938. *Micropedology*. Collegiate Press, Ames, IA.
- Kuiper, K. F., A. Deino, F. J. Hilgen, W. Krijgsman, P. R. Renne, and J. R. Wijbrans. 2008. Synchronizing rock clocks of earth history. *Science* 320(5875): 500–504.
- Kumada, K. 1965. Studies on the colour of humic acids. Part 1. On the concepts of humic substances and humification. *Soil Sci. Plant Nutr.* 11: 151–156.
- Kumada, K. 1987. *Chemistry of Soil Organic Matter*. Japan Sci. Soc. Press, Tokyo.
- Kumada, K., and H. M. Hurst. 1967. Green humic acid and its possible origin as a fungal metabolite. *Nature* 214: 5–88.
- Kumada, K., and E. Miyara. 1973. Sephadex gel filtration of humic acids. *Soil Sci. Plant Nutr.* 19: 255–263.
- Kunze, G. W., and W. F. Bradley. 1964. Occurrence of a tabular halloysite in a Texas soil. *Clays Clay Miner.* 12: 523–527.
- Kwong, Ng Kee K. F., and P. M. Huang. 1975. Influence of citric acid on the crystallization of aluminum hydroxides. *Clays Clay Miner.* 23: 164–165.
- Kwong, Ng Kee K. F., and P. M. Huang. 1977. Influence of citric acid on the hydrolytic reactions of aluminum. *Soil Sci. Soc. Am. J.* 41: 692–697.
- L'Annunziata, M. F. 2007. *Radioactivity: Introduction and History*. Elsevier Science, New York.
- Lagerwerff, J. V., and G. H. Bolt. 1959. Theoretical and experimental analysis of Gapon's equation for ion exchange. *Soil Sci.* 87: 127–222.
- Lal, R. 2006. *Encyclopedia of Soil Science*. Taylor and Francis/CRC Press, Boca Raton, FL.
- Langmuir, I. 1918. The adsorption of gases on plane surfaces of glass, mica and platinum. *J. Am. Chem. Soc.* 40: 1361–1382.
- Lawoko, M. 2008. *Lignin Carbohydrate Complexes in Softwood and Chemical Pulps*. VDM Verlag, Saarbrücken, Germany.
- Lehn, J. M. 1995. *Supramolecular Chemistry*. Wiley-VCH, New York.
- Lehninger, A., D. L. Nelson, and M. M. Cox. 2008. *Principles of Biochemistry*, 5th ed. W. H. Freeman, New York.
- Leigh, G. J. (ed.). 2002. *Nitrogen Fixation at the Millenium*. Elsevier Science, New York.
- Levesque, M., and M. Schnitzer. 1967. Organo-metallic interactions in soils. 6. Preparation and properties of fulvic acid-metal phosphates. *Soil Sci.* 103: 183–190.
- Levine, D. D. 2000. *The Diffusion of Agricultural Limestone Dissolution Products*. M.S. Thesis, University of Wisconsin, Madsion.
- Levine, I. N. 2008. *Physical Chemistry*, 5th ed. McGraw-Hill, New York.
- Levinovitz, A. W., and N. Ringertz (eds.). 2001. *The Nobel Prize: The First 100 Years*. Imperial College Press–World Scientific, London, UK.
- Lewis, G. N., and M. Randall. 1921. The activity coefficient of strong electrolytes. *J. Am. Chem. Soc.* 43: 1112.
- Li, L., W. Huang, P. Peng, G. Sheng, and J. Fu. 2003. Chemical and heterogeneity of humic acids repetitively extracted from a peat. *Soil Sci. Soc. Am. J.* 67: 740–746.
- Lindsay, W. L. 1974. Role of chelation in micronutrient availability. In: *The Plant Root and Its Environment*, E. W. Carson (ed.). University Press of Virginia, Charlottesville, VA, pp. 507–524.
- Lindsay, W. L., and E. C. Moreno. 1960. Phosphate equilibrium in soils. *Soil Sci. Soc. Am. Proc.* 24: 177–182.
- Lindsay, W. L., and W. A. Norvell. 1969. Equilibrium relationships of  $Zn^{2+}$ ,  $Fe^{3+}$ ,  $Ca^{2+}$ , and  $H^+$  with EDTA and DTPA in soils. *Soil Sci. Soc. Am. Proc.* 33: 62–68.
- Lindsay, W. L., M. Peech, and J. S. Clark. 1959. Solubility criteria for the existence of variscite in soils. *Soil Sci. Soc. Am. Proc.* 23: 357–360.
- Lobartini, J. C., K. H. Tan, J. A. Rema, A. R. Gingle, C. Pape, and D. S. Himmelsbach. 1992. The geochemical nature and agricultural importance of commercial humic matter. *Sci. Total Environ.* 113: 1–15.

- Lobartini, J. C., K. H. Tan, and C. Pape. 1994. The nature of humic acid-apatite interaction products and their availability to plant growth. *Commun. Soil Sci. Plant Anal.* 25: 2355–2369.
- Lobartini, J. C., G. A. Orioli, and K. H. Tan. 1997. Characteristics of soil humic acid fractions separated by ultrafiltration. *Comm. Soil Sci. Plant Anal.* 28: 787–796.
- Lobartini, J. C., K. H. Tan, and C. Pape. 1998. Dissolution of aluminum and iron phosphate by humic acids. *Commun. Soil Sci. Plant Anal.* 29: 535–544.
- Logsdon, S., D. Clay, D. Moore, and T. Tsegaye. 2008. *Soil Science. Step-by-Step Field Analysis*. ASA, CSSA, SSSA, Madison, WI.
- Lowe, L. E., and W. C. Tsang. 1970. Distribution of a green humic acid component in forest humus layers of British Columbia. *Can. J. Soil Sci.* 50: 456–457.
- Lu, F., and J. Ralph. 1999. Detection and determination of p-coumarylated units in lignin. *J. Agric. Food Chem.* 47(5): 1988–1992.
- Luu, Y., B. A. Ramsay, and J. A. Ramsay. 2003. Nitrotriacetate stimulation of anaerobic Fe(III) respiration by mobilization of humic materials. *Appl. Environ. Microbiol.* 69(9): 5255–5262.
- Lux, H. 1939. Säuren und Basen im Schmelzfluss: die Bestimmung der Säurstoffionen-Konzentration. *Zeitschr. Elektrochemie* 45(4): 303–309.
- Mackenzie, R. C. 1975. The classification of soil silicates and oxides. In: *Soil Components, Vol. 2, Inorganic Components*, J. E. Gieseking (ed.). Springer-Verlag, New York, pp. 1–25.
- Mackenzie, R. C., and S. Caillere. 1975. The chemical characteristics of soil minerals and the use of these characteristics in the qualitative and quantitative determination of clay minerals in soils. In: *Soil Components, Vol. 2, Inorganic Components*, J. E. Gieseking (ed.). Springer-Verlag, New York, pp. 529–571.
- Magdoff, F., and R. R. Weil (eds.). 2004. *Soil Organic Matter in Sustainable Agriculture*. Taylor & Francis/CRC Press, Boca Raton, FL.
- Manahan, S. E. 1975. *Environmental Chemistry*. Willard Grant Press, Boston, MA.
- Manahan, S. E. 2008. *Fundamentals of Environmental Chemistry*, 3rd ed. Taylor & Francis/CRC Press, Boca Raton, FL.
- Manahan, S. E. 2009. *Environmental Chemistry*, 9th ed. Taylor & Francis/CRC Press, Boca Raton, FL.
- Manley, R. J., C. Feller, and M. J. Swift. 2007. Review. Historical evolution of soil organic matter concepts and their relationships with fertility and sustainability of cropping systems. *Agric. Ecosys. & Environ.* (Elsevier) 119(3–4): 217–233.
- Manov, G. G., R. G. Bates, W. J. Hamer, and S. F. Acree. 1943. Values of the constants in the Debye–Hückel equation for activity coefficients. *J. Am. Chem. Soc.* 65: 1765–1767.
- Mao, J. D., B. Xing, and K. Schmidt-Rohr. 2001. New structural information on a humic acid from two-dimensional <sup>1</sup>H-<sup>13</sup>C correlation solid-state nuclear magnetic resonance. *Environ. Sci. Technol.* 35(10): 1928–1934.
- Marshall, K. C. 1968. Interaction between colloidal montmorillonite and cells of Rhizobium species with different ionogenic surfaces. *Biochim. Biophys. Acta* 156: 179–186.
- Martell, A. E., and M. Calvin. 1952. *Chemistry of the Metal Chelate Compounds*. Prentice Hall, New York.
- Martin, A. E., and R. Reeve. 1960a. Chemical studies of podzolized illuvial horizons. V. The flocculation of humus by ferric and ferrous iron and by nickel. *J. Soil Sci.* 11: 382–393.
- Martin, A. E., and R. Reeve. 1960b. Chemical studies of podzolic illuvial horizons. IV. The flocculation of humus by aluminum. *J. Soil Sci.* 11: 369–381.
- Martin, F., C. Saiz-Jimenes, and A. Cert. 1977. Pyrolysis-gas chromatography-mass spectrometry of soil humic fractions. I. The low boiling point compounds. *Soil Sci. Soc. Am. J.* 41: 1114–1118.
- Martin, J. H., W. H. Leonard, and D. L. Stamp. 1976. *Principles of Field Crop Production*. Macmillan, New York.
- Martin, J. P., J. O. Ervin, and R. A. Shepherd. 1966. Decomposition of the iron, aluminum, zinc and copper salts or complexes of some microbial and plant polysaccharides in soil. *Soil Sci. Soc. Am. Proc.* 30: 196–200.
- Martin, J. P., K. Haider, and E. Bondietto. 1975. Properties of model humic acids synthesized by phenoloxidase and autoxidation of phenols and other compounds formed by soil fungi. In: *Humic Substances, Their Structure and Function in the Biosphere*, D. Povoledo and H. Golterman (eds.). Centre Agric. Publ. Doc., Wageningen, The Netherlands, pp. 171–186.
- Mattson, S. 1931. The laws of soil colloidal behavior: III. Amphoteric behavior. *Soil Sci.* 32: 343–365.
- Mattson, S., and L. Wiklander. 1940. The pH and amphoteric behavior of soils in relation to the Donnan equilibrium. *Ann. Agr. Coll. Sweden* 8: 1–54.
- McBride, M. B. 1994. *Environmental Chemistry of Soils*. Oxford University Press, New York.
- McCarthy, J., and B. Norum. 1986. Continuous electron beam accelerator facility (CEBAF). In: *McGraw-Hill Yearbook of Science and Technology*, S. P. Parker (ed.). McGraw-Hill, New York, pp. 333–335.



- McCarthy, J. S., B. E. Norum, and R. C. York. 1983. A long range plan for nuclear science, Report of DOE/NSF Nuclear Science Advisory Committee. Proc. 12th Int. Conf. High Energy Accelerations, Batavia, IL.
- McEwan, D. M. C., and A. Ruiz-Amil. 1975. Interstratified clay minerals. In: *Soil Components, Vol. 2, Inorganic Components*, J. E. Gieseking (ed.). Springer-Verlag, New York, pp. 265–334.
- McGraw-Hill. 2005. *McGraw-Hill Concise Encyclopedia of Physics*, 2nd ed. McGraw-Hill Professional, New York.
- McSween, H. Y., S. M. Richardson, and M. Uhle. 2004. *Geochemistry: Pathways and Processes*, 2nd ed. Columbia University Press, New York.
- Mehlich, A. 1981. Charge properties in relation to sorption and desorption of selected cations and anions. In: *Chemistry in the Soil Environment*, R. H. Dowdy, J. A. Ryan, V. V. Volk, and D. E. Baker (eds.). Am. Soc. Agron., Soil Sci. Soc. Am., Madison, WI, pp. 47–75.
- Mehta, N. C., P. Dubach, and H. Deuel. 1963. Untersuchungen über die Molekulargewichtsverteilung von Huminstoffen durch Gelfiltration an Sephadex. *Z. Pflanzenernähr. Dung. Bodenk.* 102: 128–137.
- Mekaru, T., and G. Uehara. 1972. Anion adsorption of ferruginous tropical soils. *Soil Sci. Soc. Am. Proc.* 36: 296–300.
- Mellor, D. P. 1964. Historical background and fundamental concepts. In: *Chelating Agents and Metal Chelates*, F. P. Dwyer and D. P. Mellor (eds.). Academic Press, New York, pp. 1–50.
- Merriam-Webster. 1973. *Webster's New Collegiate Dictionary*. G & C Merriam Company, Springfield, MA.
- Merriam-Webster. 2003. *Merriam-Webster's Collegiate Dictionary and Thesaurus*. Deluxe Audio Edition (Version 3.0, 11th ed.). Merriam-Webster, Springfield, MA.
- Meunier, A. 2007. Soil hydroxy-interlayered minerals: A re-interpretation of their crystallochemical properties. *Clays Clay Miner.* 55(4): 380–388.
- Miller, R. H., and J. F. Wilkinson. 1979. Nature of the organic coating on sand grains of nonwettable golf greens. *Soil Sci. Soc. Am. Proc.* 41: 1203–1204.
- Millot, G. 1970. *Geology of Clays*. Springer-Verlag, New York.
- Mills, H. A., and J. B. Jones, Jr. 1996. *Plant Analysis. Handbook II. A Practical Sampling, Preparation, Analysis, and Interpretation Guide*. Micro-Macro, Athens, GA.
- Milner, H. B. 1952. *Sedimentary Petrography*. Thomas Murby & Co, London, UK.
- Minson, D. J., and J. R. Wilson. 1980. Comparative digestibility of tropical and temperate forage—A contrast between grasses and legumes. *J. Austr. Inst. Agric. Sci.* 46: 247–249.
- Mojallali, M., and S. B. Weed. 1978. Weathering of micas by mycorrhizal soybean plants. *Soil Sci. Soc. Am. J.* 42: 367–372.
- Moore, J. T., and R. H. Loeppert. 1987. Significance of potassium chloride pH of calcareous soils. *Soil Sci. Soc. Am. J.* 51: 908–912.
- Mortenson, J. L. 1961. Physico-chemical properties of a soil polysaccharide. *Trans. 7th Int. Congr. Soil Sci.* 1960, Madison, WI. American Elsevier, New York, II: 98–104.
- Mortenson, J. L., D. M. Anderson, and J. L. White. 1965. Infrared spectrometry. In: *Methods of Soil Analysis, Part 1*, C. A. Black, D. D. Evans, J. L. White, L. E. Ensminger, and F. E. Clark (eds.). Agronomy series No. 9., Am. Soc. Agron., Madison, WI, pp. 743–770.
- Mortland, M. M. 1970. Clay-organic complexes and interactions. *Adv. Agron.* 22: 75–117.
- Mortland, M. M., J. J. Fripiat, J. Claussidon, and J. Uijterhoeven. 1963. Interaction between ammonia and expanding lattices of montmorillonite and vermiculite. *J. Phys. Chem.* 67: 248–253.
- Mortland, M. M., K. Lawton, and G. Uehara. 1956. Alteration of biotite to vermiculite by plant growth. *Soil Sci.* 82: 477–481.
- Murmann, R. K. 1964. *Inorganic Complex Compounds*. Holt-Reinhold, New York.
- Murray, H. H. 2007. *Applied Clay Mineralogy. Occurrence, Processing, and Applications of Kaolins, Bentonites, Palygorskites, Sepiolite and Common Clays*. Elsevier Science, New York.
- Narasimhan, T. N. 2007. Central ideas of Buckingham (1907): A century later. *Vadose Zone J.* 6: 687–693.
- Nebergall, W. H., F. C. Schmidt, and H. F. Holtzclaw, Jr. 1972. *College Chemistry*. 5th ed. D.C. Heath, Lexington, MA.
- Newman, R. H., and K. R. Tate. 1980. Soil phosphorus characterization by <sup>31</sup>P nuclear magnetic resonance. *Commun. Soil Sci. Plant Anal.* 11: 835–842.
- Newman, J., and K. E. Thomas-Alyea. 2004. *Electrochemical Systems*, 3rd ed. Wiley, Hoboken, NJ.
- Nichols, K., S. Wright, W. Schmidt, M. Cavigelli, and K. Dzantor. 2002. Carbon contribution and characteristics of humic acid, fulvic acid, particulate organic matter and glomalin in diverse ecosystems. International Humic Substances Society, Boston, MA, Conference Proceedings: 365–367.
- NIIR Board. 2004. *The Complete Technology Book on Bio-Fertilizer and Organic Farming*. National Institute of Industrial Research, NIIR, Delhi, India.

- Nimmo, J. R., and E. R. Landa. 2005. The soil physics contributions of Edgar Buckingham. *Soil Sci. Soc. Am. J.* 69: 328–342.
- Norde, W. 2003. *Colloids and Interfaces in Life Sciences*. Taylor & Francis/CRC Press, Boca Raton, FL.
- Norrish, K. 1954. Swelling of montmorillonite. *Disc. Faraday Soc.* 18: 120–134.
- Novozamsky, I., J. Beek, and G. H. Bolt. 1976. Chemical equilibria. In: *Soil Chemistry. A. Basic Elements*, G. H. Bolt and M. G. M. Bruggenwert (eds.). Elsevier Scientific, Amsterdam, pp. 13–42.
- Oden, S. 1919. Humic acids. *Kolloidchem. Beih.* 11: 75.
- Ogner, G. 1979. The  $^{13}\text{C}$  nuclear magnetic resonance spectrum of a methylated humic acid. *Soil Biol. Biochem.* 11: 105–108.
- Ogner, G. 1980. Analysis of the carbohydrates of fulvic and humic acids as their partially methylated alditol acetates. *Geoderma* 23: 1–10.
- Ogner, G. 1983.  $^{31}\text{P}$ -NMR spectra of humic acids. A comparison of four different raw humus types in Norway. *Geoderma* 29: 215–219.
- Ollier, C. 1975. *Weathering*. Longman Group, London.
- Olness, A., and C. E. Clapp. 1973. Occurrence of collapsed and expanded crystals in montmorillonite-dextran complexes. *Clays Clay Miner.* 21: 289–293.
- Olness, A., and C. E. Clapp. 1975. Influence of a polysaccharide structure on dextran adsorption by montmorillonite. *Soil Biol. Biochem.* 7: 113–118.
- Orioli, G. A., and N. R. Curvetto. 1980. Evaluation of extractants for soil humic substances. 1. Isotachophoretic studies. *Plant Soil* 55: 353–361.
- Orlov, D. S. 1985. *Humus Acids of Soils*. Moscow University Press. Translated from Russian (K.H. Tan, ed.). Amerind Publ., New Delhi, India.
- Orlov, D. S., and N. L. Erosiceva. 1967. Zur frage der Wechselwirkung von Huminsäuren mit einigen Metallkationen. *Vestnik-Moskovskogo Universiteta. Biologia, Pochvedinie* 1, pp. 98–105.
- Orlov, D. S., Y. M. Ammosova, and G. I. Glebova. 1975. Molecular parameters of humic acids. *Geoderma* 13: 211–229.
- Orr, J. R. 1986. Particle accelerator. In: *McGraw-Hill Yearbook of Science and Technology*, S. P. Parker (ed.). McGraw-Hill, New York, pp. 329–331.
- Osmond, D. A. 1958. Micropedology. *Soils Fertil.* 21: 1–6.
- Ott, J., and J. Boerio-Goates. 2000. *Chemical Thermodynamics: Principles and Applications*. Elsevier Academic Press, New York.
- Papendick, R. I., and C. S. Campbell. 1981. Theory and measurement of water potential. In: *Water Potential Relations in Soil Microbiology*, J. F. Parr, W. R. Gardner, and L. F. Elliot (eds.). SSSA Publ. No. 9. Soil Sci. Soc. Am., Madison, WI, pp. 1–22.
- Parfitt, R. L. 1980. Chemical properties of variable charge soils. In: *Soils with Variable Charge*, B. K. G. Theng (ed.). New Zealand Soc. Soil Sci., Soil Bureau, Lower Hutt, pp. 167–194.
- Parfitt, R. L. 1992. Definitions of allophane. *AIPEA (Assoc. Int. pour l'Etude des Argilles), Newsletter* 28: 16–19.
- Parfitt, R. L., A. R. Fraser, and V. C. Farmer. 1977. Adsorption of hydrous oxides. III. Fulvic acid and humic acid on goethite, gibbsite and imogolite. *J. Soil Sci.* 28: 289–296.
- Parfitt, R. L., and J. M. Kimble. 1989. Conditions for formation of allophane in soils. *Soil Sci. Soc. Am. J.* 53: 971–977.
- Parker, F. W. 1921. Methods of studying concentration and the composition of the soil solution. *Soil Sci.* 12: 209–232.
- Paton, T. R. 1978. *The Formation of Soil Material*. Allen & Unwin, Boston, MA.
- Patrick, G. L. 2004. *Instant Notes. Organic Chemistry*. BIOS Scientific, Abingdon, UK.
- Paul, E. A., and F. E. Clark. 1989. *Soil Microbiology and Biochemistry*. Academic Press, San Diego, CA.
- Pauling, L. 1929. The principles underlying the structure of complex ionic compounds. *J. Am. Chem. Soc.* 51: 1010–1026.
- Pauling, L. 1960. *The Nature of the Chemical Bond*, 3rd ed. Cornell University Press, Ithaca, NY.
- Pearson, R. G. 1963. Hard and soft acids and bases. *J. Am. Chem. Soc.* 85(22): 3533–3539.
- Perrin, D. D. 1964. *Organic Complexing Reagents*. Wiley-Interscience, New York.
- Piccolo, A. 2002. The supramolecular structure of humic substances: A novel understanding of humus chemistry and implications in soil science. *Adv. Agron.* 75: 57–78.
- Pierce, R. H., Jr., and G. T. Felbeck, Jr. 1975. A comparison of three methods of extracting organic matter from soils and marine sediments. In: *Humic Substances. Their Structure and Function in the Biosphere*, D. Povoledo and H. L. Golterman (eds.). Centre Agric. Publ. Doc., Wageningen, The Netherlands, pp. 217–232.

- Pies, R. W., and D. P. Rogers. 2005. *Handbook of Essential Psychopharmacology*, 2nd ed. American Psychiatric, Arlington, VA.
- Poapst, P. A., C. Genier, and M. Schnitzer. 1970. Effect of a soil fulvic acid on stem elongation in peas. *Plant Soil* 32: 367–372.
- Poapst, P. A., C. Genier, and M. Schnitzer. 1971. Fulvic acid and adventitious root formation. *Soil Biol. Biochem.* 3: 367–372.
- Polchinsky, J. 1998. *String Theory*. Cambridge University Press, New York.
- Polchinsky, J. 2007. “Al strung out?” A review in *American Scientist*, January/February 2007, Volume 1. (<http://www.americanscientist.org/bookshelf/id.3145>). Assessed April 12, 2010.
- Polianin, A. D. 2007. *Hydrodynamics, Mass and Heat Transfer in Chemical Engineering*. Taylor and Francis/CRC Press, Boca Raton, FL.
- Ponge, J. F. 2003. Humus forms in terrestrial ecosystems: A framework of biodiversity. *Soil Biol. Biochem.* 35: 935–945.
- Ponnamperuma, F. N., E. Martinez, and T. Loy. 1966. Influence of redox potential and partial pressure of carbon dioxide on pH values and the suspension effect of flooded soils. *Soil Sci.* 101: 421–431.
- Posner, A. M. 1964. Titration curves of humic acid. *Trans. 8th Int. Congr. Soil Sci.*, Bucharest, Romania, 1964. Academy of the Socialist Republic of Romania, Bucharest 11: 161–164.
- Povh, B. 1995. *Particles and Nuclei: An Introduction to the Physical Concepts*. Springer-Verlag, New York.
- Qualls, R. G., A. Takiyama, and R. L. Wershaw. 2003. Formation and loss of humic substances during decomposition in a pine forest floor. *Soil Sci. Soc. Am. J.* 67: 899–909.
- Raats, P. A. C., and M. Th. Van Genuchten. 2006. Milestones in soil physics. *Soil Sci.* 171(1): 21–28.
- Ranville, J. F., and R. L. Schmiermund. 1998. An overview of environmental colloids. In: *Perspectives in Environmental Chemistry*, D. L. Macalady (ed.). Oxford University Press, New York, pp. 25–45.
- Rao, M. A., S. S. H. Rizvi, and A. K. Datta (eds.). 2005. *Engineering Properties of Food*. 3rd ed. Taylor & Francis/CRC Press, Boca Raton, FL.
- Rapley, R. 2000. *The Nucleic Acid Protocol Handbook*. Humana Press, Totowa, NJ.
- Rastall, R. H. 1916. *Agricultural Geology*. University Press, Cambridge, MA.
- Ravi, S., P. D’Ordorico, T. Over, and T. M. Zobeck. 2004. On the effect of air humidity on soil susceptibility to wind erosion: The case of air-dry soils. *Geophys. Res. Lett.* 31: LO 9501.
- Reddy, K. R., and R. D. DeLaune. 2008. *Biochemistry of Wetlands*. Taylor & Francis/CRC Press, Boca Raton, FL.
- Rengel, Z. (ed.). 2003. *Handbook of Soil Acidity*. Taylor & Francis/CRC Press, Boca Raton, FL.
- Rhoades, J. D., A. Kandiah, and A. M. Mashali. 1992. The use of saline water for crop production. FAO Irrigation and Drainage Paper No. 48. Food and Agricultural Organization of the United Nations, Rome.
- Rich, C. I. 1968. Mineralogy of soil potassium. In: *The Role of Potassium in Agriculture*, V. J. Kilmer, S. E. Younts, and N. C. Brady (eds.). Am. Soc. Agron., Madison, WI, pp. 79–108.
- Rich, P. R. 2003. The molecular machinery of Keilin’s respiratory chain. *Biochem. Soc. Trans.* 31: 1095–1105.
- Richards, J. G., A. P. Farrell, and C. J. Brauner (eds.). 2009. *Hypoxia*. Elsevier Academic Press, New York.
- Richards, L. A. 1941. A pressure-membrane extraction apparatus for soil solutions. *Soil Sci.* 51: 377–386.
- Richards, L. A. (ed.). 1954. *Diagnosis and Improvement of Saline and Alkali Soils*. USDA Agriculture Handbook No. 60. U.S. Government Printing Office, Washington, DC.
- Richter, B. 1986. Linear Colliders. In: *McGraw-Hill Yearbook of Science and Technology*, S. P. Parker (ed.). McGraw-Hill, New York, pp. 331–333.
- Rieman, W. III, and H. F. Walton. 1970. *Ion Exchange in Analytical Chemistry*. Pergamon Press, Oxford, UK.
- Riffaldi, R., and M. Schnitzer. 1972. Electron spin resonance spectrometry of humic substances. *Soil Sci. Soc. Am. Proc.* 36: 301–307.
- Ritsema, C. J., and L. W. Dekker. 2003. *Soil Water Repellency. Occurrence, Consequences and Amelioration*. Elsevier, New York.
- Roberson, T., K. C. Reddy, S. S. Reddy, E. Z. Nyakatawa, R. L. Raper, D. W. Reeves, and J. Lemunyon. 2008. Carbon dioxide efflux from soil with poultry litter applications in conventional and conservation tillage systems in northern Alabama. *J. Environ. Qual.* 37: 535–541.
- Robert, M., and J. Berthelin. 1986. Role of biological and biochemical factors in soil mineral weathering. In: *Interactions of Soil Minerals with Natural Organics and Microbes*, P. M. Huang and M. Schnitzer (eds.). SSSA Special Publ. No.17. Soil Sci. Soc. Am., Madison, WI, pp. 453–495.
- Robinson, G. W. 1924. Pedology as a branch of geology (Soil studies). *Geol. Mag.* 61: 444–447.
- Roscoe, H. E., and A. Harden. 2008. *A New View of the Origin of Dalton’s Atomic Theory. A Contribution to Chemical History (1896)*. Kessinger, Whitefish, MT.



- Rose, D. A., A. Kennedy, and F. Abbas. 2007. Gravity segregation during miscible displacement—re-investigation and re-interpretation. *Aust. J. Soil Res.* 45(5): 319–332.
- Rosenberg, J., L. M. Epstein, and P. Krieger. 2009. *College Chemistry. Schaum's Outline*, 9th ed. McGraw-Hill Professional, Columbus, OH.
- Ross, C. S., and P. F. Kerr. 1934. Halloysite and allophane. U.S. Geological Survey Professional Paper 185G, pp. 135–148.
- Rossmann, F. G., and C. J. van Oss. 2002. *Colloid and Surface Properties of Clays and Related Minerals*. Taylor & Francis/CRC Press, Boca Raton, FL.
- Rovira, A. D., and B. M. McDougall. 1967. Microbiological and biochemical aspects of the rhizosphere. In: *Soil Biochemistry*, A. D. McLaren and G. H. Peterson (eds.). Marcel Dekker, New York, pp. 417–463.
- Rowell, R. M. (ed.). 2005. *Handbook of Wood Chemistry and Wood Composites*. Taylor & Francis/CRC Press, Boca Raton, FL.
- Ruggiero, P., F. S. Interesse, and O. Sciacovelli. 1980. <sup>1</sup>H NMR evidence of exchangeable aromatic protons in fulvic and humic acids. *Soil Biol. Biochem.* 12: 297–299.
- Sainju, U. M., J. D. Jabro, and W. B. Stevens. 2008. Soil carbon dioxide emission and carbon content as affected by irrigation, tillage, cropping systems, and nitrogen fertilization. *J. Environ. Qual.* 37: 98–106.
- Sakakibara, A. 1980. A structural model of softwood lignin. *Wood Sci. Technol.* 14(2): 89–100.
- Salfeld, J. C. 1975. Ultraviolet and visible adsorption spectra of humic systems. In: *Humic Substances. Their Structure and Function in the Biosphere*, D. Povoledo and H. L. Golterman (eds.). Centre Agric. Publ. Doc., Wageningen, The Netherlands, pp. 269–280.
- Scarani, V., and R. Thew. 2006. *Quantum Physics: A First Encounter*. Oxford University Press, New York.
- Schaetzl, R. J., and S. Anderson. 2005. *Soils. Genesis and Geomorphology*. Cambridge University Press, New York.
- Scharpenseel, W. H. 1966. Aufbau und Bindungsform der Ton-Huminsäure-Komplex. 2. Hydrothermal Synthese von Ton-Humussäure, sowie anderer Organo-mineralische Komplexen Untersuchungen am Roentgenerat, I.R. Spectrometer und Elektronen-mikroskop. *Zeitschr. Pflanzenern. Dung. Bodenk.* 114: 3–8.
- Schnitzer, M. 1965. The application of infrared spectroscopy to investigations on soil humic compounds. *Can. Spectrosc.* 10: 121–127.
- Schnitzer, M. 1971. Characterization of humic constituents by spectroscopy. In: *Soil Biochemistry*, Vol. 2, A. D. McLaren and J. Skujins (eds.). Marcel Dekker, New York, pp. 60–95.
- Schnitzer, M. 1974. The methylation of humic substances. *Soil Sci.* 117: 94–102.
- Schnitzer, M. 1975. Chemical, spectroscopic and thermal methods for the classification and characterization of humic substances. In: *Humic Substances. Their Structure and Function in the Biosphere*, D. Povoledo and H. L. Golterman (eds.). Centre Agric. Publ. Doc., Wageningen, The Netherlands, pp. 293–310.
- Schnitzer, M. 1976. The chemistry of humic substances. In: *Environmental Biogeochemistry*. Vol.1. *Carbon, Nitrogen, Phosphorus, Sulfur, and Selenium Cycles*, J. O. Nriagu (ed.). Proc. 2d Int. Symp. Environ. Biogeochem., Hamilton, Ontario, Canada, April 8–12, 1975, Ann Arbor Science, Ann Arbor, MI, pp. 89–107.
- Schnitzer, M., and S. U. Khan. 1972. *Humic Substances in the Environment*. Marcel Dekker, New York.
- Schnitzer, M., and H. Kodama. 1976. The dissolution of micas by fulvic acid. *Geoderma* 15: 381–391.
- Schnitzer, M., and D. A. Hindle. 1980. Effect of peracetic acid oxidation on N-containing components of humic materials. *Can. J. Soil Sci.* 60: 541–548.
- Schnitzer, M., D. A. Shearer, and J. R. Wright. 1959. A study in the infrared of high molecular-weight organic matter extracted by various reagents from a Podzolic B horizon. *Soil Sci.* 87: 252–257.
- Schofield, R. K. 1947. A ratio law governing the equilibrium of cations in the soil solution. *Proc. 11th Int. Congr. Pure Appl. Chem.* 3: 257–261.
- Schofield, R. K. 1955. Can a precise meaning be given to “available phosphorus”? *Soils Fertil.* 18: 373–375.
- Schofield, R. K., and A. W. Taylor. 1955. The measurement of soil pH. *Soil Sci. Soc. Am. Proc.* 19: 164–167.
- Schulten, H. R., and P. Leinweber. 2000. New insights into organic-mineral particles: Composition, properties, and models of molecular structure. *Biol. Fertil. Soils* 30: 399–432.
- Schulten, H. R., and M. Schnitzer. 1993. A state-of-the-art structural concept for humic substances. *Naturwissenschaften* 80: 29–30.
- Schulten, H. R., and M. Schnitzer. 1995. Three dimensional models for humic acids and soil organic matter. *Naturwissenschaften* 82: 487–498.
- Schwertmann, U., and R. M. Taylor. 1977. Iron oxides. In: *Minerals in Soil Environments*, J. B. Dixon, S. B. Weed, J. A. Kittrick, M. H. Milford, and J. L. White (eds.). Soil Sci. Soc. Am., Madison, WI, pp. 145–180.
- Science Daily*. 2010 (March 30). Large Hadron Collider: Beams colliding at record energies mark start of research program. <http://sciencedaily.com/releases/2010/03/>.

- Senesi, N., and M. Schnitzer. 1977. Effects of pH, reaction time, chemical reduction and irradiation on ESR spectra of fulvic acid. *Soil Sci.* 123: 224–234.
- Serway, R. A., J. S. Faughn, and C. Vuille. 2009. *College Physics*. Brooks/Cole, Florence, KY.
- Sewald, N., and H. -D. Jakube. 2009. *Peptides: Chemistry and Biology*. Wiley-VCH, New York.
- Shukla, K. P., and M. R. Nayar. 1941. Modified equations for adsorption and base-exchange in soils. Letters to the Editors. *Curr. Sci.* 10: 201–204.
- Silver, H., H. L. Ehrlich, and K. C. Ivarson. 1986. Soil mineral transformation mediated by soil microbes. In: *Interactions of Soil Minerals with Natural Organics and Microbes*, P. M. Huang and M. Schnitzer (eds.). SSSA Special Publ. No. 17. Soil Sci. Soc. Am., Madison, WI, pp. 497–519.
- Simonson, R. W. 1959. Outline of a generalized theory of soil genesis. *Soil Sci. Soc. Am. Proc.* 23: 152–156.
- Singer, A. 1979. Clay mineral formation. In: *The Encyclopedia of Soil Science, Part 1*, R. W. Fairbridge and C. W. Finkle, Jr. (eds.). Dowden, Hutchinson and Ross, Stroudsburg, PA, pp. 76–82.
- Sinha, M. K. 1971. Organo-metallic phosphates. I. Interaction of phosphorus compounds with humic substances. *Plant Soil* 35: 471–484.
- Sinha, M. K. 1972. Organo-metallic phosphates. IV. The solvent action of fulvic acids on insoluble phosphates. *Plant Soil* 37: 457–467.
- Slatyer, R. O. 1957. The significance of the permanent wilting percentage in studies of plant and water relations. *Bot. Rev.* 23: 585–636.
- Slatyer, R. O. 1967. *Plant–Water Relationships*. Academic Press, New York.
- Soil Survey Staff. 1975. *Soil Taxonomy. A Basic System of Soil Classification for Making and Interpreting Soil Surveys*. Agric. Handbook No. 436. U.S. Government Printing Office, Washington, DC.
- Soil Survey Staff. 2006. *Soil Taxonomy. A Basic System of Soil Classification for Making and Interpreting Soil Surveys*. Agric. Handbook No. 436, 2nd ed. Landcare USDA-NCRS (National Conservation Resources Support Service), Des Moines, IA.
- Sonon, L. S., M. A. Chappell, and V. P. Envangelou. 2001. A brief history of soil chemistry. Iowa State University, Agronomy Department paper, 8pp; published by the authors as [www.agronomy.iastate.edu/soilchemistry/history](http://www.agronomy.iastate.edu/soilchemistry/history).
- Sowden, F. J., Y. Chen, and M. Schnitzer. 1977. The nitrogen distribution in soils formed under widely differing climatic conditions. *Geochim. Cosmochim. Acta* 41: 1524–1526.
- Spangler, M. G., and R. L. Handy. 1982. *Soil Engineering*, 4th ed. Harper & Row, New York.
- Sparks, D. L. 1999. *Soil Physical Chemistry*, 2nd ed. Taylor & Francis/CRC Press, Boca Raton, FL.
- Sparks, D. L. 2003. *Environmental Soil Chemistry*, 2nd ed. Elsevier-Academic Press, New York.
- Sparks, D. L. 2006. Historical aspects of soil chemistry. The origins of agricultural chemistry: The forerunner of soil chemistry. In: *Foot Prints in the Soil: People and Ideas in Soil History*, B. P. Warkentin (ed.). Elsevier Science, New York, pp. 307–338.
- Sparks, D. L., and W. C. Liebhardt. 1981. Effect of long-term lime and potassium applications on quantity-intensity (Q/I) relationship in sandy soil. *Soil Sci. Soc. Am. J.* 45: 786–790.
- Sposito, G. 1980. Freundlich equation for ion exchange reactions in soils. *Soil Sci. Soc. Am. J.* 44: 652–654.
- Sposito, G. 1989. *The Chemistry of Soils*. Oxford University Press, New York, NY.
- Sposito, G. 2008. *The Chemistry of Soils*, 2nd ed. Oxford University Press, New York.
- Sposito, G., and K. M. Holtzclaw. 1977. Titration studies on the polynuclear, polyacidic nature of fulvic acid extracted from sewage sludge-soil mixtures. *Soil Sci. Soc. Am. J.* 41: 330–336.
- Spyridakis, D. E., G. Chesters, and S. A. Wilde. 1967. Kaolinization of biotite as a result of coniferous and deciduous seedling growth. *Soil Sci. Soc. Am. Proc.* 31: 203–210.
- Srodon, J. 2007. Identification and quantitative analysis of clay minerals. In: *Handbook of Clay Science*, F. Bergaya, B. K. G. Theng, and G. Lagaly (eds.). Elsevier Science, New York, pp. 765–778.
- SSSA (Soil Science Society of America). 1997. *Glossary of Soil Science Terms*. Soil Science Soc. Am., Madison, WI.
- Steelink, C. 1964. Free radical studies of lignin, lignin degradation products and soil humic acids. *Geochim. Cosmochim. Acta* 28: 1615–1622.
- Steelink, C., and G. Tollin. 1967. Free radicals in soils. In: *Soil Biochemistry*, A. D. McLaren and G. H. Peterson (eds.). Marcel Dekker, New York, pp. 147–173.
- Steinberg, C. E. W. 2003. *Ecology of Humic Substances in Freshwaters*. Springer-Verlag, Berlin.
- Sten-Knudson, O. 2007. *Biological Membranes: Theory of Transport, Potentials and Electrical Impulses*. Cambridge University Press, New York.
- Stephenson, A., and J. Turner. 1997. *Amino Acids Neurotransmission*. Portland Press, London, UK.
- Stepniewski, W. 2006. Oxygen diffusion rate and plant growth. In: *Encyclopedia of Soil Science*, 2nd ed., Vol. 2, R. Lal (ed.). Taylor & Francis/CRC Press, Boca Raton, FL, pp. 1236–1238.

- Stern, O. 1924. Zür Theorie der elektrolytischen Doppelschicht. *Z. Elektrochem.* 30: 508–516.
- Stevenson, F. J. 1965. Gross chemical fractionation of organic matter. In: *Methods of Soil Analysis, Part 1*, C. A. Black, D. D. Evans, J. L. White, L. E. Enslinger, and F. E. Clark (eds.). Agron. series No. 9., Am. Soc. Agron., Madison, WI, pp. 1409–1421.
- Stevenson, F. J. 1976a. Stability constants of  $\text{Cu}^{2+}$ ,  $\text{Pb}^{2+}$  and  $\text{Cd}^{2+}$  complexes with humic acids. *Soil Sci. Soc. Am. J.* 40: 665–672.
- Stevenson, F. J. 1976b. Binding metal ions by humic acids. In: *Environmental Biogeochemistry. Vol. 1. Carbon, Nitrogen, Phosphorus, Sulfur, and Selenium Cycles*, J. O. Nriagu (ed.). Proc. 2nd Int. Symp. Environ. Biogeochem., Hamilton, Ontario, Canada, April 8–12, 1975, Ann Arbor Science, Ann Arbor, MI, pp. 519–540.
- Stevenson, F. J. 1986. *Cycles of Soil Carbon, Nitrogen, Phosphorus, Sulfur, Micronutrients*. Wiley Interscience, New York.
- Stevenson, F. J. 1994. *Humus Chemistry. Genesis, Composition, Reactions*, 2nd ed. Wiley & Sons, New York.
- Stevenson, F. J., and K. M. Goh. 1971. Infrared spectra of humic acids and related substances. *Geochim. Cosmochim. Acta* 35: 471–483.
- Stevenson, F. J., and K. M. Goh. 1972. Infrared spectra of humic and fulvic acid and their methylated derivatives, evidence for nonspecificity of analytical methods for oxygen-containing functional groups. *Soil Sci.* 113: 334–345.
- Stevenson, I. L., and M. Schnitzer. 1982. Transmission electron microscopy of extracted fulvic and humic acids. *Soil Sci.* 133: 179–185.
- Stewart, B. A., and T. A. Howell. 2003. *Encyclopedia of Water Science*. Marcel Dekker, New York.
- Sticher, H., and R. Bach. 1966. Fundamentals in the chemical weathering of silicates. *Soils Fertil.* 29: 321–325.
- Stick, R. V., and W. Spencer. 2008. *Carbohydrates: Essential Molecules of Life*. Elsevier, New York.
- Stolzy, L. H. 1974. Soil atmosphere. In: *The Plant Root and Its Environment*, E. W. Carson (ed.). University Press of Virginia, Charlottesville, VA, pp. 335–361.
- Stolzy, L. H., and J. Letey. 1964. Measurement of oxygen diffusion rates with the platinum electrode. III. Correlation of plant response to soil oxygen diffusion rates. *Hilgardia* 35: 567–576.
- Stout, J. D., and K. E. Lee. 1980. Ecology of soil micro- and macroorganisms. In: *Soils with Variable Charge*, B. K. G. Theng (ed.). New Zealand Soil Sci. Soc., Lower Hutt, New Zealand, pp. 353–372.
- Stucki, J. W., K. Lee, L. Zhang, and R. A. Larson. 2002. Effect of oxidation state on the surface and structural properties of smectite. *Pure Appl. Chem.* 74(11): 2145–2158.
- Stumm, W., and J. J. Morgan. 1981. *Aquatic Chemistry. An Introduction Emphasizing Chemical Equilibria in Natural Waters*, 2nd ed. Wiley, New York.
- Su, R. K. 2009. *Carbohydrates Can Kill*. Jus et Veritas, Portsmouth, VA.
- Sudo, T., and H. Yotsumoto. 1977. The formation of halloysite tubes from spherulitic halloysite. *Clays Clay Miner.* 25: 155–159.
- Sutton, R., and G. Sposito. 2005. Molecular structure in soil humic substances: The new view. *Environ. Sci. Technol.* 39(23): 9009–9015.
- Swift, R. S. 1991. Effects of humic substances and polysaccharides on soil aggregation. In: *Advances in Soil Organic Matter Research. The Impact on Agriculture and the Environment*, M. S. Wilson (ed.). Redwood Press, Wiltshire, England, pp. 153–162.
- Swift, R. S., B. K. Thornton, and A. M. Posner. 1970. Spectral characteristics of a humic acid fractionated with respect to molecular weight using agar gel. *Soil Sci.* 110: 93–99.
- Swindale, L. D. 1975. The crystallography of minerals of the kaolin group. In: *Soil Components, Vol. 2, Inorganic Components*, J. E. Gieseking (ed.). Springer-Verlag, New York, pp. 121–154.
- Tait, J. M., N. Yoshinaga, and B. D. Mitchell. 1978. Occurrence of imogolite in some Scottish soils. *Soil Sci. Plant Nutr.* 24: 145–151.
- Taiz, L., and E. Zeiger. 2002. *Plant Physiology*, 3rd ed. Sinauer Assoc., Sunderland, MA.
- Takashi, N., Y. Yamazaki, A. Kobayashi, A. Higashutani, and H. Takashi. 2003. Hydrotropism interacts with gravitropism by degrading amyoplasts in seedling roots of *Arabidopsis* and radish. *Plant Physiol.* 132: 805–810.
- Tan, K. H. 1964. The Andosols in Indonesia. In: *F.A.O. Meeting on the Classification and Correlation of Soils from Volcanic Ash. World Soil Resources*. F.A.O. Rep.14. U.N. Educ. Sci. Cult. Org., Rome, Italy, pp. 23–30.
- Tan, K. H. 1968. The genesis and characteristics of paddy soils in Indonesia. *Soil Sci. Plant Nutr.* 14: 117–121.
- Tan, K. H. 1975. Infrared absorption similarities between hyatomelanic acid and methylated humic acid. *Soil Sci. Soc. Am. Proc.* 39: 70–73.

- Tan, K. H. 1976a. Complex formation between humic acid and clays as revealed by gel filtration and infrared spectroscopy. *Soil Biol. Biochem.* 8: 235–239.
- Tan, K. H. 1976b. Contamination of humic acid by silica gel and sodium bicarbonate. *Plant Soil* 44: 691–695.
- Tan, K. H. 1978a. Formation of metal-humic acid complexes by titration and their characterization by differential thermal analysis and infrared spectroscopy. *Soil Biol. Biochem.* 10: 123–129.
- Tan, K. H. 1978b. Effect of humic and fulvic acids on release of fixed potassium. *Geoderma* 21: 67–74.
- Tan, K. H. 1978c. Variations in soil humic compounds as related to regional and analytical differences. *Soil Sci.* 125: 351–358.
- Tan, K. H. 1980. The release of silicon, aluminum, and potassium during decomposition of soil minerals by humic acid. *Soil Sci.* 129: 5–11.
- Tan, K. H. (ed.). 1984. *Andosols*. Van Nostrand Reinhold, New York.
- Tan, K. H. 1985. Scanning electron microscopy of humic matter as influenced by methods of preparation. *Soil Sci. Soc. Am. J.* 49: 1185–1191.
- Tan, K. H. 1986. Degradation of soil minerals by organic acids. In: *Interactions of Soil Minerals with Natural Organics and Microbes*, P. M. Huang and M. Schnitzer (eds.). SSSA Special Publ. No.17. Soil Sci. Soc. Am., Madison, WI, pp. 1–27.
- Tan, K. H. 1994. *Environmental Soil Science*. Marcel Dekker, New York.
- Tan, K. H. 1996. *Soil Sampling, Preparation, and Analysis*. Marcel Dekker, New York.
- Tan, K. H. 2003. Chemical Processes. In: *Handbook of Processes and Modeling in the Soil-Plant System*. Food Product Press, The Haworth Reference Press, Binghamton, NY, pp. 27–56.
- Tan, K. H. 2005. *Soil Sampling, Preparation, and Analysis*, 2nd ed. Taylor & Francis/CRC Press, Boca Raton, FL.
- Tan, K. H. 2008. *Soils in the Humid Tropics and Monsoon Region of Indonesia*. Taylor & Francis/CRC Press, Boca Raton, FL.
- Tan, K. H. 2009. *Environmental Soil Science*, 3rd ed. Taylor & Francis/CRC Press, Boca Raton, FL.
- Tan, K. H., and J. Van Schuylenborgh. 1959. On the classification and genesis of soils derived from andesitic volcanic material under a monsoon climate. *Neth. J. Agric. Sci.* 7: 1–22.
- Tan, K. H., and J. Van Schuylenborgh. 1961. On the organic matter in tropical soils. *Neth. J. Agric. Sci.* 9: 174–180.
- Tan, K. H., and F. E. Clark. 1968. Polysaccharide constituents in fulvic and humic acids extracted in soils. *Geoderma* 2: 245–255.
- Tan, K. H., and R. A. McCreery. 1970a. Possibility of the silylation technique in gas liquid chromatography of fulvic and humic acids. *Geoderma* 4: 119–126.
- Tan, K. H., and R. A. McCreery. 1970b. The infrared identification of a humo-polysaccharide ester in soil humic acid. *Commun. Soil Sci. Plant Anal.* 1: 75–84.
- Tan, K. H., and J. E. Giddens. 1972. Molecular weights and spectral characteristics of humic and fulvic acids. *Geoderma* 8: 221–229.
- Tan, K. H., and R. A. McCreery. 1975. Humic acid complex formation and intermicellar adsorption by bentonite. Proc. 1974 Int. Clay Conf., Mexico City, Mexico, Applied Publ., Wilmette, IL, pp. 629–641.
- Tan, K. H., and B. F. Hajek. 1977. Thermal analysis of soils. In: *Minerals in Soil Environments*, J. B. Dixon, S. B. Weed, J. A. Kittrick, M. H. Milford, and J. L. White (eds.). Soil Sci. Soc. Am., Madison, WI, pp. 865–884.
- Tan, K. H., and V. Nopamornbodi. 1979. Effect of different levels of humic acids on nutrient content and growth of corn (*Zea mays* L.). *Plant Soil* 51: 283–387.
- Tan, K. H., and H. F. Perkins. 1980. The value of the U.S. Soil Taxonomy classification of red tropical soils derived from volcanic ash. Proc. CLAMATROPS, Int. Conf. Classif. Manage. Trop. Soils, Kuala Lumpur, Malaysia, Aug. 1977. Int. Soil Sci. Soc., Kuala Lumpur, Malaysia, pp. 110–119.
- Tan, K. H., and A. Binger. 1986. Effect of humic acid on aluminum toxicity in corn plants. *Soil Sci.* 141: 20–25.
- Tan, K. H., L. D. King, and H. D. Morris. 1971a. Complex reactions of zinc with organic matter extracted from sewage sludge. *Soil Sci. Soc. Am. Proc.* 35: 748–751.
- Tan, K. H., R. A. Leonard, A. R. Bertrand, and S. R. Wilkinson. 1971b. The metal complexing capacity and the nature of the chelating ligands of water extract of poultry litter. *Soil Sci. Soc. Am. Proc.* 35: 266–269.
- Tan, K. H., H. F. Perkins, and R. A. McCreery. 1973. Kaolinite-gibbsite thermodynamic relationship in Ultisols. *Soil Sci.* 116: 8–12.
- Tan, K. H., V. G. Mudgal, and R. A. Leonard. 1975a. Adsorption of poultry litter extracts by soil and clay. *Environ. Sci. Technol.* 9: 132–135.
- Tan, K. H., E. R. Beaty, R. A. McCreery, and J. B. Jones. 1975b. Differential effect of Bermuda and Bahia grasses on soil chemical characteristics. *Agron. J.* 67: 407–411.



- Tan, K. H., G. W. Bailey, and H. F. Perkins. 1978. Infrared analysis. In: *Analysis of Clay, Silt and Clay Fractions of Selected Soils from the Southeastern United States*. Southern Coop. Ser. Bull. 219. University of Kentucky, pp. 25–38.
- Tan, K. H., R. A. Leonard, L. E. Asmussen, J. C. Lobartini, and R. A. Gingle. 1990. The geochemistry of black water in selected coastal streams of the southeastern United States. *Commun. Soil Sci. Plant Anal.* 21: 1999–2016.
- Tan, K. H., D. S. Himmelsbach, J. C. Lobartini, and G. R. Gamble. 1994. The issue of artifacts in NaOH extraction of humic matter. In: *Humic Substances in the Global Environment and Implications on Human Health*, N. Senesi and T. M. Miano (eds.). Elsevier, Amsterdam, pp. 109–114.
- Taylor, D. M., and D. R. Williams. 1995. *Trace Element Medicine and Chelation Therapy*. Royal Society of Chemistry, Cambridge, UK.
- Taylor, R. M. 1988. Proposed mechanism for the formation of soluble Si and FeIII-Al hydroxy complexes in soils. *Geoderma* 42: 65–77.
- Taylor, S. A., and G. L. Ashcroft. 1972. *Physical Edaphology*. Freeman, San Francisco, CA.
- Taylor, S. A., and R. O. Slatyer. 1960. Water–soil plant relations terminology. *Trans. 7th Int. Congr. Soil Sci.*, Madison, WI, 1: 80–90.
- Theng, B. K. G. 1972. Formation, properties, and practical applications of clay-organic complexes. *J. R. Soc. New Zealand* 2: 437–457.
- Theng, B. K. G. 1974. *The Chemistry of Clay-Organic Reactions*. John Wiley & Sons, New York.
- Theng, B. K. G. (ed.). 1980. *Soils with Variable Charge*. New Zealand Soc. Soil Sci., Soil Bureau, DSIR, Lower Hutt, New Zealand.
- Thomas, G. W. 1974. Chemical reactions controlling soil solution electrolyte concentration. In: *Plant Root and Its Environment*, E. W. Carson (ed.). University Press of Virginia, Charlottesville, VA, pp. 483–506.
- Thomas, G. W. 1977. Historical developments in soil chemistry: Ion exchange. *Soil Sci. Soc. Am. J.* 41: 230–231.
- Thomas, G. W., and W. L. Hargrove. 1984. The chemistry of soil acidity. In: *Soil Acidity and Liming*, F. Adams (ed.). Agron. Series No. 12. Am. Soc. Agron., Crop Sci. Soc. Am., and Soil Sci. Soc. Am., Madison, WI, pp. 3–56.
- Thompson, M. L. (ed.). (1985). *Soil Micromorphology and Soil Classification*. SSSA Special Publ. No. 15. Soil Sci. Soc. Am., Madison, WI.
- Thomson, K. 2008. Aqueous electrolytes: Phase diagrams and process simulation/optimization. Aqueous Solutions Aps, Soborg, Denmark. March 8: [http://www.phasediagram.dk/chemical\\_potentials.htm](http://www.phasediagram.dk/chemical_potentials.htm).
- Thorn, K. A., D. W. Folan, and P. MacCarthy. 1989. Characterization of the International Humic Substances standard and reference fulvic and humic acids by solution state carbon-13 (<sup>13</sup>C) and hydrogen-1 (<sup>1</sup>H) nuclear magnetic resonance spectrometry. Water-Resources Investigations Report 89-4196. U.S. Geological Survey, Denver, CO.
- Thurman, E. M., and R. L. Malcolm. 1981. Preparative isolation of aquatic humic substances. *Environ. Sci. & Technol.* 15(4): 463–466.
- Thurman, E. M., R. L. Wershaw, R. L. Malcolm, and D. J. Pinckney. 1982. Molecular size of aquatic humic substances. *Organic Geochem.* 4: 27–35.
- Tiley, R. J. D. 2004. *Understanding Solids. The Science of Materials*. Wiley, New York.
- Time. 2010 (April 12). “The World, 3: Switzerland,” p. 16.
- Tisdale, S. L., and W. L. Nelson. 1975. *Soil Fertility and Fertilizers*. MacMillan, New York.
- Tiurin, I. V., and M. M. Kononova. 1962. Biology of humus formation and questions of soil fertility. *Trans. Joint Meet. Commun. IV and V, Int. Soc. Soil Sci.*, Palmerston-North, New Zealand, pp. 203–219.
- Treseder, K. K., and K. M. Turner. 2007. Glomalin in ecosystems. *Soil Sci. Soc. Am. J.* 71: 1257–1266.
- Troeh, F. R., and L. M. Thompson. 2005. *Soils and Soil Fertility*, 6th ed. Wiley-Blackwell, New York.
- Trubetskoi, O. A., O. E., Triebetskaya, and C. Saiz-Jimenez. 2005. The study of stable electrophoretic fractions of humic acids by pyrolytic gas chromatography–mass spectrometry. *Eurasian Soil Sci.* 38(11): 1183–1189.
- Tucker, K. A., K. J. Karnok, D. E. Radcliffe, G. Landry Jr., R. W. Roncador, and K. H. Tan. 1990. Localized dry spots as caused by hydrophobic sands on bentgrass greens. *Agron. J.* 82: 549–555.
- Turner, N. C., and M. M. Jones. 1980. Turgor maintenance by osmotic adjustment. A review and evaluation. In: *Adaptation of Plants to Water and High Temperature Stress*, N. C. Turner and P. J. Kramer (eds.). Wiley Interscience, New York, pp. 87–103.
- Turner, N. C., and P. J. Kramer (eds.). 1980. *Adaptation of Plants to Water and High Temperature Stress*. Wiley Interscience, New York.
- Uriyo, A. P., and A. Kesseba. 1975. Organic phosphorus in soil profiles. *Geoderma* 13: 201–210.

- Van Bemmelen, J. M. 1910. *Die Absorption. Gesammelte Abhandlungen Über Kolloide und Absorption*. Mit Unterstützung der Verfassers neu Herausgegeben von Wo. Oswald. Theodor Steinhoff, Dresden, Germany.
- Van Breemen, N., and R. Brinkman. 1976. Chemical equilibria and soil formation. In: *Soil Chemistry, A. Basic Elements*, G. H. Bolt and M. G. M. Bruggenwert (eds.). Elsevier Scientific, Amsterdam, pp. 141–170.
- Van der Marel, H. W. 1959. Potassium fixation, a beneficial soil characteristic for crop production. *Z. Pflanzenernähr. Dung. Bodenk.* 84: 51–62.
- Van Olphen, H. 1977. *Clay Colloid Chemistry*. Wiley & Sons, New York.
- Van Raij, B., and M. Peech. 1972. Electrochemical properties of some Oxisols and Alfisols of the tropics. *Soil Sci. Soc. Am. Proc.* 36: 587–593.
- Van Schouwenburg, J. Ch., and A. C. Schuffelen. 1963. Potassium-exchange behavior of an illite. *Neth. J. Agric. Sci.* 11: 13–22.
- Van Schuylenborgh, J., and A. M. H. Sanger. 1949. The electrokinetic behavior of iron- and aluminum-hydroxides and oxides. *Recueil des Travaux Chimiques des Pays-Bas* 68: 999–1010.
- Van Schuylenborgh, J. 1966. *Chemical Aspects of Soil Formation*, syllabus of lectures postgraduate training. Agriculture University, Wageningen, The Netherlands.
- Van Schuylenborgh, J. 1971. Weathering and soil forming processes in the tropics. In: *Proc. Bandung Symp. Soils Trop. Weathering*, Indonesia, UNESCO, Paris, pp. 39–50.
- Van Wijk, W. R., and D. A. De Vries. 1963. The atmosphere and the soil. In: *Physics of Plant Environment*, W. R. van Wijk (ed.). North Holland Publ., Amsterdam, pp. 17–61.
- Velde, B., and A. Meunier. 2008. *The Origin of Clay Minerals in Soils and Weathered Rocks*. Springer, New York.
- Verwey, E. J. W., and J. T. G. Overbeek. 1948. *Theory of the Stability of Lyophobic Colloids*. Elsevier, New York.
- Visser, S. A. 1986. Effects of humic substances on plant growth. In: *Humic Substances. Effects on Soil and Plants*, REDA (ed.). Ramo Editoriale degli Agricoltora, Milano, Italy, pp. 89–135.
- Volk, J. S., C. E. Forsythe. 2006. Diet, exercise, and hormone interactions on skeletal muscle. *Hormone Res.* 66(1): 17–21.
- Volpe, D. C., and S. Siboni. 2006. Acid–base behavior of (polymer) surfaces: Theory. In: *Encyclopedia of Surface and Colloid Science*, P. Somasundaran (ed.). Taylor & Francis/CRC Press, Boca Raton, FL, pp. 74–79.
- Von Wandruszka, R., R. R. Engebretson, and L. M. Yates. 1999. Humic acid pseudomicelles in dilute aqueous solutions: Fluorescence and surface tension measurements. In: *Understanding Humic Substances: Advanced Methods, Properties and Applications*, E. A. Ghabbour and G. Davies (eds.). Royal Society of Chemistry, Cambridge, UK, pp. 79–85.
- Wächtershäuser, G. 2000. Origin of Life: Life as we don't know it. *Science* 289: 1307–1308.
- Wada, K. (1977). Allophane and imogolite. In: *Minerals in Soil Environments*, J. B. Dixon, S. B. Weed, J. A. Kittrick, M. H. Milford, and J. L. White (eds.). Soil Sci. Soc. Am., Madison, WI, pp. 603–639.
- Wahl, D. 2005. Eine kleine Geschichte der Elektrochemie. *Galvanotechnik* 96(8): 1820–1838.
- Wafer, C. C., J. B. Richards, and D. L. Osmond. 2004. Construction of platinum-tipped redox probes for determining redox potentials. *J. Environ. Qual.* 33: 2375–2379.
- Walker, G. F. 1961. Vermiculite minerals. In: *The X-ray Identification and Crystal Structures of Clay Minerals*, G. Brown (ed.). Mineralogical Society, London, pp. 297–324.
- Walker, G. F. 1975. Vermiculites. In: *Soil Components, Vol. 2, Inorganic Components*, J. E. Gieseking (ed.). Springer-Verlag, New York, pp. 155–189.
- Wallace, J. M., and L. C. Whitehand. 1980. Adverse synergistic effects between acetic, propionic, butyric, and valeric acids on the growth of wheat seedling roots. *Soil Biol. Biochem.* 12: 445–446.
- Walther, J. V. 2009. *Essentials of Geochemistry*. Jones & Bartlett, Sudbury, MA.
- Wang, F. L. 2000. Ammonium adsorption and desorption in sandy soils. *Soil Sci. Am. J.* 64: 1669–1674.
- Wang, J. J., D. L. Harrell, and P. F. Bell. 2004. Potassium buffering characteristics of three soils low in exchangeable potassium. *Soil Sci. Soc. Am. J.* 68: 654–661.
- Watanabe, A., D. B. McPail, N. Maie, S. Kawasaki, H. A. Anderson, and M. V. Chesire. 2005. Electron spin resonance characteristics of humic acids from a wide range of soil types. *Org. Chem.* 36(7): 981–990.
- Way, J. T. 1850. On the power of soils to absorb manure. *J. R. Agric. Soc.* 11: 313–379.
- Weast, R. C. (ed.). 1972. *Handbook of Chemistry and Physics*. Chemical Rubber Co., Cleveland, OH.
- Webb, G. A. (Senior Reporter). 2003. *Nuclear Magnetic Resonance*, Vol. 32. Royal Society of Chemistry, London.
- Weber, J. B. 1970. Mechanism of adsorption of s-triazines by clay colloids and factors affecting plant availability. In: *Residue Reviews*, Vol. 32, F. A. Gunther and J. D. Gunther (eds.), Springer-Verlag, New York, pp. 90–130.
- Weil, J. A., and J. R. Bolton. 2007. *Electron Paramagnetic Resonance. Elementary Theory and Practical Applications*, 2nd ed. Wiley-Interscience, New York.

- Weir, C. C., and R. J. Soper. 1963. Interaction of phosphates with ferric organic complexes. *Can. J. Soil Sci.* 43: 393–399.
- Wershaw, R. L. 1992. Membrane-micelle model for humus in soils and sediments and its relation to humification. U.S. Geological Survey, Denver, Open File Report 91-513.
- Wershaw, R. L. 1993. Model for humus in soils and sediments. *Environ. Sci. Technol.* 27(5): 814–816.
- Wershaw, R. L. 1999. Molecular aggregation of humic substances. *Soil Sci.* 164: 803–811.
- White, J. L. 1971. Interpretation of infrared spectra of soil minerals. *Soil Sci.* 112: 22–31.
- White, R. E. 2005. *Principles and Practice of Soil Science. The Soil as a Natural Resource*, 4th ed. Wiley-Blackwell, New York.
- White, A. F., M. S. Schulz, D. V. Vivit, T. D. Bullen, and J. Aggarwal. 2006. Distinguishing between lithogenic and biogenic processes in soil weathering environments. *Geochim. Cosmochim. Acta* 70(18): A698.
- Whitehead, D. C., and J. Tinsley. 2006. The biochemistry of humus formation. *J. Sci. Food Agric.* 14: 849–857.
- Wiklander, L. 1964. Cation and anion exchange phenomena. In: *Chemistry of the Soil*, F. E. Bear (ed.). Reinhold, New York, pp. 163–205.
- Wild, A. 1993. *Soils and the Environment: An Introduction*. Cambridge University Press, Cambridge, England.
- Wilding, L. P., and K. W. Flach. 1985. Micropedology and soil taxonomy. In: *Soil Micromorphology and Soil Classification*, L. A. Douglas and M. L. Thompson (eds.). SSSA Special Publ. No. 15. Soil Sci. Soc. Am., Madison, WI, pp. 1–16.
- Wilding, L. P., and H. Lin. 2006. Advancing the frontiers of soil science towards geosciences. *Geoderma* 131: 257–274.
- Wilkinson, J. P., and R. H. Miller. 1978. Investigation and treatment of localized dry spots on sand golf greens. *Agron. J.* 70: 299–304.
- Wilkinson, R. E. (ed.). 2000. *Plant Environment Interactions*, 2nd ed. Marcel Dekker, New York.
- Wisaksono, M. W., and K. H. Tan. 1964. *Ilmu Tanah. Djilid II*. Pradnjaparamita II Publishers, Jakarta, Indonesia.
- Wise, D. L., D. J. Trantolo, E. J. Eichon, H. I. Inyang, and U. Stottmeister. 2000. *Bioremediation of Contaminated Soils*. Taylor & Francis/CRC Press, Boca Raton, FL.
- Wolf, D. E., R. S. Johnson, G. D. Hill, and R. W. Varner. 1958. Herbicidal properties of neburon. *Proc. N.C. Weed Control Conf.* 15: 7–18.
- Wright, M. R. 2005. *An Introduction to Aqueous Electrolyte Solutions*. John Wiley & Sons, New York.
- Yates, D. E., S. Levine, and T. W. Healy. 1974. Site-binding model of the electric double layer at the oxide/water interface. *J. Chem. Soc. Faraday Trans. I*, 70: 1807–1819.
- Yong, R. N. 2000. *Geoenvironmental Engineering*. Taylor & Francis/CRC Press, Boca Raton, FL.
- Yoshida, M., K. Sakagami, R. Hamada, and T. Kurobe. 1978. Studies on the properties of organic matter in buried humic horizon derived from volcanic ash. I. Humus composition of buried humic horizon. *Soil Sci. Plant Nutr.* 24: 277–287.
- Yoshinaga, N., and S. Aomine. 1962. Imogolite in some Ando soils. *Soil Sci. Plant Nutr.* 8: 6–13.
- Yuen, Q. H., and H. W. Hilton. 1962. Soil adsorption of herbicides. The adsorption of monuron and diuron by Hawaiian sugar cane soils. *J. Agr. Food Chem.* 10: 386–391.
- Zaidel'man, F. 2007. Lessivage and its relation to the hydrological regime of soils. *Eurasian Soil Sci.* 40(2): 115–125.



# INDEX

## A

- Absorbance, 2  
Absorption, 2, 76  
Accelerator  
  atomic, 8  
  particle, 8  
Acetic acid, 295  
  importance in complex formation, 295  
Acid  
  alpha- ( $\alpha$ -) linoleic, 89  
  amphiprotic, 244, 245  
  deposition, 257  
  diprotic, 244  
  dissociation constant, 248  
  eicosapentaenoic (EPA), 89  
  fatty, 87  
  Lewis, 245  
  lipoidic, 88  
  monoprotic, 63, 65, 70, 200, 244  
  organic, 236, 278, 295  
  polyprotic, 63, 65, 70, 200  
  rain, 257  
  strong, 63, 258  
  weak, 63  
Acid-base chemistry, 69, 244  
  concepts, 244–245  
Acid-base pair, 245  
Acid loving plants, 262  
Acid precipitation, 257  
  and buffer capacity of soils, 258  
  effect on fish, 258  
  effect on forests, 258  
  effect on human health, 257  
  effect on soil, 257, 258  
Acid strength, 248  
Acidity constant, 248, 255  
Acidity index, 255  
  of fertilizers, 255  
Acquired soil hydrophobicity, 196  
*Actinomyces* sp., 291  
Active acidity, 250  
  human activity and, 253–254  
Activity, 60, 70  
  coefficient, 70, 215, 216  
  definition, 70  
  electron, 31–33  
Activity ratio, 68, 216, 261  
Adhesion, 193  
Adsorbed cation, 205, 294  
Adsorption, 76, 150, 183  
  characteristics, 183, 185  
  chemical forces in, 186  
  coordination bonding in, 186, 187  
  electrostatic bonding in, 186, 187  
  forces of, 186  
  hydrogen bonding in, 186, 187  
  hydrophobic bonding in, 186, 187  
  isotherms, 188, 202  
  intermicellar, 194  
  lyotropic series of, 184  
  molecular, 302  
  negative, 183, 192, 226, 227–228, 298  
  nonselective, 251  
  nonspecific, 150, 153, 184, 188, 226, 227  
  physical forces in, 186, 228  
  positive, 183, 192, 226, 228, 298  
  pseudo-, 185  
  preferential, 251  
  specific, 150, 153, 183–184, 188, 226, 229  
  surface acidity in, 186–187  
  surface potential in, 205  
  types of, 183  
Adsorption of amphoteric, 200  
Adsorption of anions, 225  
  hydrodynamic radius in, 205  
  lyotropic series in, 205  
Adsorption of cations, 295  
Adsorption of microbial cells, 132, 308  
Adsorption of organic compounds, 198  
  cation bridges in, 198  
  coordination bonding in, 198  
  diffuse ion swarm in, 198  
  interlayer, 200  
  molecular orientation in, 200–201  
  molecular size effect on, 198–199, 201  
Adsorption of uncharged organic compounds, 199  
Adsorption of water, 193  
  in coordination shells, 193  
  by hydrogen bonding, 193  
  in interlayer spaces, 194, 195  
  by organic matter, 195  
  by silicate clays, 193  
Aeration, 43  
  core, 44  
  definition of, 44  
  normal, 44  
  spike, 44  
Aerification, 44  
Aerobic  
  conditions in soil air, 41  
  decomposition, 5, 41–42, 43  
  microorganisms, 289, 291  
  respiration, 41–42  
Aerobic heterotrophs, 289  
Aerobiosis, 277  
Aerosol, 75  
Agricultural chemistry, 1  
Agricultural geology, 1  
Akaganè, 148  
Akaganeite, 148  
Albic horizon, 282, 285  
Albite, 207  
Alchemie, 2  
Alcohol  
  coumaryl, 90

- coniferyl, 90
- guaiacyl, 90
- sinapyl, 90
- syringyl, 90
- trihydroxy, 90
- Aldehydes, 78
- Aldose, 78, 79
- Alkalinization, 263
- Allophane, 133, 151–152, 155
  - anion exchange capacity of, 153
  - cation exchange capacity of, 153
  - characteristics of, 152
  - composition of, 152
  - definition of, 152
  - d spacings of, 154
  - EDAX of, 154
  - effect of organic acids on formation of, 278
  - identification in soils of, 154
  - occurrence in soils, 154–155
- Alpha ( $\alpha$ ) particle, 23
- Alternaria* sp., 197
- Aluminum
  - chemistry, 251–252
  - as pH buffer, 253
- Aluminum chelate, 303
- Aluminum hexahydronium, 252
- Aluminum octahedron, 271
- Aluminum potential, 252, 253
- Aluminol surface, 167
  - protonation of, 226
- Aluminum and H-saturated clays
  - clays, 252
- Aluminum hydrous oxide clays, 148
  - cation exchange capacity of, 150
  - characteristics of, 149–150
  - composition of, 149
  - DTA of, 150
  - d spacing of, 150
  - members (types) of, 149
  - occurrence in soils of, 150–151
  - structure of, 150
- Aluminum hydroxide
  - dimers, 279
  - interaction with humic acids, 279
  - monomer, 278
  - organic acids effect on polymerization of, 278–279
- Aluminum hydroxyphosphates, 237
  - solubility of, 238
- Aluminum monomers, 252
  - and soil acidity, 252
- Aluminum (Mg) octahedron, 137, 138
- Aluminum polymers, 253
  - and soil acidity, 253
- Aluminum potential, 26, 252–253
- Aluminum and soil acidity, 251–252
- Amberlite XAD resin, 99
- Amino acids, 83
  - accumulation in soils, 84
  - acidic, 83, 86
  - aliphatic, 83
  - alpha,  $\alpha$ -, 83–84
  - anabolic effect of, 86–87
  - aromatic, 83
  - basic, 84, 86
  - bound, 77
  - chemistry, 84, 85
  - colloidal behavior of, 85
  - conversion into anion, cation, and zwitter ions, 301–302
  - content in soil, 76
  - free, 77
  - heterocyclic, 84
  - in human health, 86
  - in humic acids, 84
  - neutral, 84
- Ammonia fixation by lignin, 93
- Ammonium fixation, 145, 221
- Amorphous clay, 133, 151
  - definition of, 151
  - types of, 151–152
- Amorphous state, 151
- Amphiphilic, 75, 88
- Amphiprotic, 244, 245
- Ampholytes, 64
- Amphoteric
  - characteristics of kaolinite, 298
  - compounds, 64, 85, 149, 199
- Anaerobic
  - conditions in soil air, 41
  - decomposition, 5, 42, 43
  - respiration, 42, 43
- Anaerobic organisms, 289, 291
  - facultative, 289
- Anaerobiosis, 42, 277
- Analytical chemistry, 2
- Andosols, 154, 303
  - Al and Fe chelates in, 153
- Angiosperm, 91
- Anion adsorption, 226, 230
  - definition of, 15
  - lyotropic series, 228
  - negative, 227
  - nonspecific, 226, 227
  - positive, 226, 228
  - specific, 226, 229
- Anion exchange, 228
  - mechanisms, 225–226
- Anion exchange capacity (AEC), 228
- Anion penetration, 229
- Anoxic soil, 41, 50, 288
- Antigorite, 135
- Antimatter, 10
- Antioxidants, 94
- Antiport system, 235
- Apatite, 233
  - isomorphous series of, 233
- Apocrenic acid, 95
- Apoplast pathway, 58
- Apoptosis, 94
- Aquifer, 50
- Arabinose, 79
- Argillans, 25, 282
- Argillic horizon, 281
- Argon dating, 24
- Aridisols, 262
- Aromatization, 92
- Arrhenius concept of acidity, 244

- Association constant, 297; *See also* Stability constant of metal–organic complexes
- Asymbiotic propagation, 81
- Atkins diet, 82
- ATLAS experiment, 10
- Atom, 7
  - concept of, 7, 14
  - dimension of, 14
- Atomic accelerators, 8
- Atomic mass, 15, 16
- Atomic mass number, 15, 16
- Atomic mass unit, 16
- Atomic model, 7
  - of Rutherford and Bohr, 14
- Atomic number, 15, 17
- Atomic orbital, 18
- Atomic planes, 135
- Atomic radius, 18
  - crystalline, 18, 19
  - hydrated, 18, 19
  - importance of, 18
- Atomic smashers; *See* Atomic accelerators
- Atomic structure, 7, 14
- Atomic weight, 15, 17, 19
  - standard base of, 17
- Atomos, 3, 7
- ATP, adenosine triphosphate, 77, 78, 235–236
- Autoprotolysis, 244
- Avogadro's number, 17, 311
- B**
- Back emf, 27
- Bacteria
  - methanogenic, 41
- Baryons, 11
- Basal plane, 137, 159
- Basal spacings, 135, 136
- Base, definition of; *See* Acid–base chemistry
- Base exchange, 206
- Base saturation, 223
  - calculation of, 223
  - correlation with pH, 223
  - relation with soil fertility, 223
- Bauxite, 151, 279
- Bayerite, 149
- Becquerel, 23
- Bedrock, 267
  - altered, 267
  - unaltered, 267
- Beidellite, 135, 141
- Bentonite, 141
- Benzene derivatives of humic acid, 125
- Benzoic acid, 125
- $\beta$  (beta) particles, 23
- $\beta$  (beta) process, 12
- BET equation, 189, 191, 194
- Bidentate, 232
- Big bang reaction, 10
- Biochemical cycle, 82
  - and electron activity, 82
- Biochemical oxidation, 52
  - of ammonium, 52
  - of iron compounds, 52
  - of sulfur compounds, 52
- Biochemical oxygen demand, 52
- Biochemical weathering, 276, 278
  - coadsorption in, 278
  - complex reaction in, 278
  - electrostatic attraction in, 278
  - types of organic acids in, 278
  - water and metal bridging in, 278
- Biochemistry, 2, 5
- Biofuel, 82
- Biogenic silica, 148
- Biogenic weathering, 276
- Biological degradation of humic acid, 125
- Biological fixation of P, 235, 236
  - ATP in, 235
  - by chelation, 235
  - as immobilization, 234
- Biological nitrogen fixation, 257
- Biological oxidation demand, 52–53
  - carbonaceous stage, 53
  - nitrogenous stage, 53
  - in pollution, 53
  - values, 53
- Biological weathering, 276
  - Ca-oxalate in, 277
  - enzymatic effect, 277
  - nonenzymatic effect, 277
  - organisms in, 277
  - physical effect of, 277
- Biomass, 76
- Biostasy, 267
- Biotite, 135, 144, 145
  - hydro, 144
- Björckman method, 91
- Black alkali soils, 263
- Black holes, 10
  - mini, 10
- Black water, 99
- Boehmite, 149, 163
- Boltzmann constant, 176, 208, 311
- Boltzmann equation, 176
- Bond
  - coordination, 187, 194–195, 269–270, 293
  - covalent, 66, 245, 294
  - electrostatic, 167, 268, 294
  - homopolar, 269
  - hydrogen, 51, 187, 195–196
  - ionic, 269
  - metallic, 269
  - siloxane, 167, 269, 272
  - Van der Waals, 269
- Bond strength and mineral stability, 272
- Bosons, 13
  - Higgs, 10
- Bradyrhizobium*, 230
- Bragg's law, 158
- Bridging, 104, 230, 236
  - aluminum, 230–231
  - calcium, 230–231
  - metal, 95, 278, 298–299
  - water, 95, 278, 298, 299
- Brittle mica, 135

- Brønsted–Lowry acidity concept, 69, 244  
 application in soil, 247
- Brucite, 145
- Brunauer, Emmett, and Teller (BET) equation, 191  
 BET–BDDT equation, 191  
 use of, 192
- Buffer capacity, 250–251, 259  
 of soils, 250, 259, 289
- Buffer solution, 259
- Bulk solution, 176, 177, 227
- ## C
- Calcite, 207, 208
- Calcium chelate, 303
- Calcium fluorapatite, 233  
 stability diagram of, 238
- Canopy interaction, 259
- Capillarity, 52
- Capillary potential, 54, 55
- Carbohydrates, 42–43, 78  
 aerobic decomposition of, 42  
 anaerobic decomposition of, 42  
 beneficial effect of, 42  
 in biofuel production, 82  
 complex, 79  
 environmental importance, 81–83  
 in human nutrition, 82  
 open chain structure of, 78, 79  
 ring structure, 78, 79
- Carbon dioxide, CO<sub>2</sub>  
 content in air, 41, 45  
 content in water, 49–50  
 Mauna Lea data set, 41
- Carbon to nitrogen ratio (C/N), 130
- Carbonaceous BOD (CBOD), 53
- Carbonation, 208
- Carbon dating, 23
- Carbonyl group determination in  
 humic acid, 103  
 in amino acid, 85  
 determination in humic acid, 102
- Casparian strip, 58
- Catabolism, 42
- Cation, 15  
 bridging, 198–199, 299  
 exchangeable, 206  
 exchanging power of, 210  
 fixed, 221
- Cation exchange, 205–206  
 constant, 213  
 empirical equations, 212, 213  
 equations or models, 212  
 kinetic equations, 214  
 mass equations, 213  
 mono-divalent reactions, 214  
 mono-monovalent reactions, 213  
 by soil organic matter, 224  
 thermodynamic equations, 215
- Cation exchange capacity (CEC), 205, 208–209  
 determinations, 208–209  
 effective (ECEC), 210  
 permanent charge (CEC<sub>p</sub>), 210  
 of soil colloids, 209  
 total (CEC<sub>t</sub>), 210  
 units of, 208  
 variable (CEC<sub>v</sub>), 210
- Cation exchange constant, 67, 213
- Cation exchange equations  
 Donnan, 218–219  
 double layer, 220  
 Eriksson, 220  
 Freundlich, 212  
 Gaines and Thomas, 214, 215  
 Gapon, 212, 213, 214  
 Kerr, 213, 219  
 Langmuir–Vageler, 212, 213  
 Rothmund–Kornfeld, 211  
 Vageler, 212  
 van Laar, 210  
 Vanselow, 211, 214
- Cation–oxygen bonds, 272  
 energy of formation, 272
- Cell–clay complexes, 307  
 bacterial, 307
- Cell potential, 27, 67, 260
- Cell wall, 59  
 half, 27, 260
- Cellulose, 80  
 molecular weight, 80
- Chain structure, 78, 136, 296
- Chamosite, 145
- Charge density, 175–176
- Charging ions, 227
- Chelant, 294; *See also* Chelators  
 in chelant water treatment, 309
- Chelate, 270, 294  
 bidentate, 232, 294  
 definition, 294  
 EDTA and DTPA, 304  
 environmental importance, 295, 306–307  
 in food and medicines, 295  
 monodentate, 232, 294  
 phyto, 89  
 stable, 304
- Chelate ring, 105, 294, 296
- Chelation, 104, 153, 237, 278, 294  
 and alternative medicine, 309  
 and clay mobility, 305  
 definition of, 293, 294  
 of enzymes, 308  
 humic and fulvic acid in, 295, 306  
 in industry, 309  
 and metal mobility, 306  
 of organic matter, 295  
 role of organic acids in, 295  
 and soil fertility, 305  
 therapy, 309  
 in weathering, 304
- Chelators, 294  
 in detoxification of heavy metals, 309  
 in soap and shampoo industries, 308  
 in steam engineering, 309
- Chele, 294
- Chemical fixation of phosphate, 230
- Chemical potential, 3, 36–37, 38, 274  
 application in ion uptake, 27

- of feldspar, 274
  - of gibbsite, 274
  - of kaolinite, 274
  - of phosphate, 240
  - of soil water, 54–55
  - of water in plants, 58–59
  - in weathering stability, 274
- Chemical units, 21
- Chemisorption, 150, 184, 229
- of anions, 226
- Chemistry
- branches of, 2–3
  - colloid, 1, 5
  - cosmo, 3
  - definition of, 2
  - environmental, 5, 6
  - green, 5, 6
  - physical, 3, 6
  - soil, 2, 5
- Chlorite, 145
- cation exchange capacity of, 145
  - characteristics of, 145
  - classification of, 145
  - composition of, 145
  - d spacing of, 146
  - occurrence in soils of, 146
  - structure of, 145
- Cholesterol, 87, 89
- Chromatography; *See also* Humic
- gas–liquid, 105
  - gel, 105, 106–107
  - HPSEC (high-performance size-exclusion chromatography), 105
- Chrysotile, 135
- Clay, 133
- amorphous, 133
  - charge per unit formula of, 135
  - dioctahedral, 137
  - expanding, 141
  - identification of, 155
  - interstratified, 137
  - long-range-order, 134
  - mixed layer, 133
  - noncrystalline, 134,
  - nonexpanding, 143
  - paracrystalline, 134, 153
  - short-range-order (SRO), 134, 152
  - silicate, 136
  - structure of, 136
  - trioctahedral, 137
  - 1:1 type of, 138–139
  - 2:1 type of, 137, 141, 142
  - 2:1:1 type of, 137, 142, 145
  - 2:2 type of, 137, 145
  - variable charge, 172
- Clay–enzyme interactions, 308
- Clay mobility as influenced by
- chelation, 305
- Clay–organic complex formation, 233, 281, 298
- coadsorption in, 236, 278
  - ligand exchange in, 229, 298, 299
  - negative adsorption in, 226, 227, 298
  - positive adsorption in, 226, 227, 298
  - protonation in, 300
  - van der Waals attraction in, 298, 299
  - water and metal bridging, 298, 299
- Clay skins, 25
- Clay vermiculite, 144
- Clinochlore, 145
- Clintonite, 135
- Coadsorption, 105, 199, 230, 236, 278, 298
- Coagula, 76
- Cohesion, 193, 305
- Collider, 8
- Brookhaven RHIC, 9
  - CEBAF, 8
  - CERN large hadron, 9–10
  - SLAC, 8
- Colloid, 48
- definition of, 75
  - hydrophobic, 75
  - hydrophilic, 185
  - linear, 123
  - lyophobic, 75
  - lyophilic, 75
  - size limit, 75
  - soil, 75–76
  - sphero, 112, 123
- Colloid chemistry, 1, 75, 113
- Colloidal clay, 25, 133
- Color ratio, 107, 109, 112–113
- Complex compound, 105, 187, 237, 270
- clay–organic, 298
  - metal–organic, 296
- Complex formation, 105, 153, 223, 278
- with amphoteric compounds, 301
  - and biological properties, 307
  - and bulk density, 305
  - and clay mobility, 305
  - clay–organic, 298
  - definition, 293
  - metal–organic, 223, 296
  - and mobility of soil constituents, 302–303, 306
  - with nonionic compounds, 298, 302
  - with organic anions, 298
  - with organic cations, 298, 299
  - relation to soil fertility, 305
  - and soil structure, 305
- Coniferyl alcohol, 90
- Conjugate base, 245
- Conjugate ion pair, 245
- Constant partition isotherm, 188
- Control of acid rain on soil acidity, 258–259
- Cookeite, 146
- Coordinated water, 194–195
- Coordination
- bond, 186, 187, 299
  - compound, 187, 293
  - number, 270, 273
  - polyhedron, 269
  - reaction, 187
  - theory, 269–270
- Coordination sphere, 194–195, 293
- Corn (*Zea mays* L.)
- effect of humic acid on, 131
- Corrensites, 146
- Cortosphere, 307
- Cosmotron, 9

Cotransport system, 235  
 Cotyledon  
   di, 91  
   mono, 91  
 Coulomb  
   law of, 206  
 Coulombic force, 66, 202, 294  
 Coulombic repulsion, 270  
 Coumaryl alcohol, 90  
 Counterion sphere, 90  
 Covalent bond, 245, 294  
 Crenic acid, 95  
 Cryoscopic distillation, 110  
 Crystal chemistry, 269  
   of soil minerals, 269  
 Crystal lattice, 135  
 Crystal structure, 135  
 Crystalline clay, 133–134  
 Cristobalite, 147, 163  
   alpha ( $\alpha$ ), 147  
   beta ( $\beta$ ), 147  
*Culvularia* sp., 197  
 Cutan, 25  
*Cyanobacteria*, 43  
 Cyclosilicates; *See* Silicates  
 Cytomorphic sand, 277  
 Cytoplasmolysis, 197

## D

Dalton's atomic theory, 7  
 Dalton or emu, 16, 75, 96  
 Debye  
   length, 72  
   radius, 72  
   sphere, 72  
 Debye–Hückel theory, 71  
 Decomposition  
   aerobic, 41–42  
   anaerobic, 42  
   of feldspar, 274  
   of gibbsite, 275  
   of kaolinite, 274  
 Decomposition constant, 274  
 Decomposition voltage, 27  
 Delta ( $\Delta$ ) pH, 174  
 Dent, 294  
 Dentate, 294  
   mono-, bi-, tri-, 294  
 Deoxyribonucleic acid (DNA), 76  
 Deoxyribose, 68, 76  
    $\alpha$ -2-Deoxyribose, 76  
 Depolycondensation, 130  
   of humic acid, 131  
 Depolymerization, 130  
   of humic acid, 131  
 Derivative spectrum of humic acid, 114  
 Desilicification, 275, 279  
   of kaolinite, 280  
   of smectite, 280  
 Desorption, 76  
 Deuterium, 22  
 Dewpoint  
   oppressive, 47

  temperature, 47  
 Diaspore, 149, 163  
 Dickite, 139  
 Die-back, 258  
   in Fichtelgebirge (Bulvaria, Germany), 258  
 Dielectric constant, 180, 249  
 Differential thermal analysis (DTA), 155  
   baseline in, 155–156  
   curves of  
     gibbsite, 157–158  
     goethite, 157–158  
     kaolinite, 157–158  
     montmorillonite, 157–158  
   endothermic peak of, 155–156  
   exothermic peak, 155–156  
   heating rates in, 155  
   samples for, 155, 157  
   standard (reference) material in, 155  
   qualitative, 157  
   quantitative, 157  
 Diffuse double layer, 176  
   in cation exchange, 220  
   charge, 225  
   effect of electrolytes on, 177  
   and stability of clay suspension, 180  
   thickness of, 177  
 Diffuse-ion swarm, 184, 229  
 Diffuse layer; *See* Diffuse double layer  
 Diffusion, 44, 45  
 Diffusive cloud or counterions, 90  
 Dimorphic clay, 137  
 Dioctahedral, 137  
 Dioxyribonucleic acid (DNA), 89  
 Disaccharides, 195  
 Dissociation  
   of strong electrolytes, 62–63  
   of water, 62  
   of weak electrolytes, 63–64  
 Dissociation constant,  $pK_a$  or  $pK_A$ , 60, 62, 63, 248  
   in determination of acids and bases, 248  
    $pK_p$ , 301  
 Donnan equilibrium law, 38, 218, 240  
 Donnan potential, 38, 241  
 Donnan principle, 38  
   in cation exchange, 218  
   in CEC, 218  
 Double layer, 3, 175; *See also* Diffuse double layer  
   counterion sphere, 90  
   suppression, 178  
 Drainage, 193  
 Dry deposition, 258

## E

Edaphology, 5  
 Edge and face sharing, 270  
 EDTA (ethylene diamine tetra-acetic acid), 297, 298  
   in alternative medicine, 309  
   in complex reactions, 297, 303–304  
   in dentistry, 309  
   in treatment of clogged arteries, 309  
 Effect of humic acid on plant growth, 130–131  
   direct, 130  
   indirect, 130

- Effective concentration, 70  
 $E_n$ -pH relation, 287  
  constancy in, 289  
Eicosapentaenoic acid (EPA) or omega-3, 89  
Einstein, 16, 17  
Electric charge, 170  
  intrinsic surface, 173  
  permanent, 171, 173  
  pH dependent, 172  
  proton, 172  
  variable, 172–173  
Electric double layer, 175  
  diffuse, 176  
  effect of cations on, 178  
  effect of valency on, 177–178  
  Gouy–Chapman, 176–177  
  limitations, 178  
  Helmholtz, 176  
  stability of clays and, 181  
  Stern, 178, 179  
  thickness of, 177  
Electric potential, 27  
Electric triple layer, 179  
Electrical conductivity (EC<sub>e</sub>), 263–264  
  basis for selection of, 263  
  critical value of, 264  
  ranges in plant growth, 263–264  
  units, 264  
Electrochemical cell, 25, 27  
Electrochemical potential, 25, 26, 37, 38  
  application in ion uptake by plants, 38  
Electrode  
  hydrogen, 27–28  
  poisoning, 46  
  reference, 27  
Electrode potential, 26, 27, 28, 286  
  conversion into pe, 33, 287  
  in redox reactions, 33, 287  
  standard, 30  
Electrokinetic potential, 179, 281  
Electrolysis, 27  
Electrolytes  
  dissociation of, 62–63  
Electrolytic cell, 27  
Electrometric measurement of pH, 259  
  in CaCl<sub>2</sub> solution, 261  
  in KCl solution, 261  
  Nernst equation in, 260  
  in soil suspension, 260–261  
  standardizing electrodes in, 260  
  suspension effect in, 261  
  in water extract, 260  
Electron, 7, 11, 14, 158  
  acceptor, 69, 245  
  activity, 31, 68  
  availability, 29  
  concept, 245  
  donor, 69, 245  
  shells, 14  
    K shell, 14  
    L shell, 14  
    M shell, 14  
  valence, 14  
Electron activity, 31, 68  
  definition, 31  
  and equilibrium constants, 68  
Electron activity in terms of pe, 31, 33, 288  
Electron(ic) charge, 14, 311  
Electron microscopy, 121  
  of gibbsite, 151  
  of halloysite, 139–140  
  of humic acid, 121–123  
  of imogolite, 153, 154  
  of kaolinite, 140  
  transmission, 121  
  scanning, 121  
Electron pair acceptor, 245, 293  
Electron pair donor, 245, 293  
Electron paramagnetic resonance (EPR), 115, 117  
  first, second, and third derivative spectra of, 117–118, 119  
  G value, 117  
  high field and high frequency, 117  
  hyperfine splitting (coupling), 117  
Electron spin resonance (ESR); *See* EPR and Humic acids  
Electrostatic bond, 64, 187  
Electrostatic drag, 110  
Electrostatic valence principle, 271  
  in relation to bond strength, 271  
Element, 7, 17  
Elementary particles, 10, 14  
Elution volume, 107  
Emulsion, 75  
Endoplasmic reticulum, 89  
Energy of formation of cation–oxygen bonds, 272  
Energy of soil water  
  electrical, 53  
  kinetic, 53, 203  
  potential, 53  
Enthalpy, 51  
Entropy of water, 51  
Enzymes, 77  
  constitutive, 77  
  endo, 80  
  exo, 80  
  extracellular, 308  
  free, 308  
  humic acid interactions, 308  
  induced, 77  
Equilibrium  
  law of, 60  
Equilibrium constant, 59, 60, 274, 308  
  in electron activity, 69  
  and free energy relation, 68  
  in ion exchange, 67  
  and ion pairs, 65–66  
  relation to electrode potential, 67–68  
  relation to free energy in thermodynamics, 68  
Equilibrium potential, 38  
Equivalent acidity, 255  
  of fertilizers, 255  
Equivalent weight, 19  
  in acid-base titration, 19, 20  
  in complex reaction, 19, 20  
  of monovalent ions, 19  
  in oxidation-reduction, 20–21  
  of polyvalent ions, 19–20  
Ethanol production, 83



- Eutrophication, 50, 228, 308  
 Exchange alkalinity, 229  
 Exchange constant, 67, 213  
 Exchange reactions, 212–215  
   by lipids, 88  
   by nucleic acids, 90  
 Exchangeable sodium percentage (ESP), 263, 264–266  
   basis for selection of, 263  
 Exchangeable sodium ratio (ESR), 264  
 Exchanging power of cations, 210  
 Exposed hydroxyl groups, 173  
   protonation of, 173  
 Extracellular reaction, 43
- F**
- Fairy rings, 81  
 Faraday constant, 28, 173, 311  
 Fatty acids, 89  
   in human health, 89  
   omega-3, 89  
 Feldspars, 274  
   weathering of, 274  
 Fermentation, 42  
   anaerobic, 42  
   ethanol, 43  
   lactic acid, 43  
 Fermi–Dirac statistics, 13  
 Fermions, 11, 13  
 Ferrallitic soils, 279  
 Ferrallitization, 279  
 Ferric hydroxide  
   amorphous, 148  
 Ferrihydrite, 149  
 Ferrol surface, 168  
 Ferroxhyte, 149  
 Fertilizers  
   acid forming, 254  
   ammonium, 254  
   basic forming, 254  
   neutral, 254  
   phosphate, 255  
 Fick's law  
   in diffusion, 45  
 Field capacity, 193  
 Fish kill by acid rain, 258  
 Fixation  
   ammonium, 93, 222  
   biological of phosphate, 233  
   cation, 222  
   chemical, 230  
   importance in soils of, 222  
   metal ion, 222  
   phosphate, 152, 230–234  
   potassium, 222  
 Flocculation and dispersion, 181–182  
   effect of interparticle distance on, 181  
   effect on plant growth, 181–182  
 Flux of water, 59  
 Force carrier, 13  
 Forest decline, 258  
 Formality, 21–22  
 Formation constant, 297; *See also* Stability constant of  
   metal–organic complexes
- Framework structure, 133, 136  
 Free diffusional space, 58  
 Free energy of reaction, 4, 68  
 Free energy of water, 53, 193  
 Free water, 51  
 Freundlich  
   constant, 189  
   equation, 189  
   exponent, 189  
   van Bemmelen, 189–190  
 Fructose, 92  
 Fulvic acid, 77, 95, 97, 99, 100  
   alcoholic hydroxyl content, 100, 103  
   carboxyl content of, 100, 102  
   chromatography of, 105, 108  
   definition of, 97  
   elemental composition of, 99–100  
   extraction and isolation of, 98  
   infrared spectroscopy of, 115  
   molecular weight of, 96  
   nuclear magnetic resonance (NMR) of, 121  
   phenolic hydroxyl group content of, 100, 103  
   polysaccharide in, 122, 126, 128  
   total acidity of, 100  
   total hydroxyl content of, 100  
 Functional groups of humic matter, 224, 296  
 Fungi  
   brown-rot, 93  
   lignolytic, 93  
   soft-rot, 93  
   white-rot, 93
- G**
- Galvanic cell, 27  
 Gapon equation, 212, 213–214, 217, 231  
 Gas constant, 47, 311  
 Gaseous solution, 48  
 Gels, 75, 76  
   hydro, 76  
   true, 75  
 Geochemical weathering, 4, 267  
 Geochemistry, 1, 2, 3, 4  
 Geology, 2, 4, 5  
 Geomorphologic weathering profile, 268  
 Geosciences, 4  
 Gibbs equation, 189, 192  
   negative adsorption in, 192  
   positive adsorption in, 192  
 Gibbs–Duhem model, 193  
 Gibbs free energy, 3, 36  
 Gibbs phase rule, 3  
 Gibbsite, 86, 149, 150–151, 158, 274, 280  
   differential dissolution, 150  
   d spacing, 161, 163  
   DTA of, 158  
   electron microscopy of, 151  
   infrared characteristic of, 168  
   pK value of, 284  
   stability constant of, 275, 284  
   structure of, 150  
   weathering of, 275  
 Gibbsite potential, 26, 274, 275  
 Gigatron, 8

- Gingivitis, 291  
 Glass electrode, 260  
 Gleization, 281  
 Gley formation, 285  
 Glomalin, 76, 97, 277  
*Glomus* sp., 277  
 Glucose, 79  
 Glucoseamine, 87, 89  
 Glucosidic bonds, 80  
 Gluon, 11  
 Glycemic index (GI), 82  
 Glycerol, 87  
 Glycerol reaction with clay, 142  
 Glycoprotein, 277, 306  
   in complex formation, 306  
   in soil aggregation, 277  
 Glycosyl transfer, 80  
 Goethite, 86, 148, 149, 150  
   differential dissolution of, 150  
   d spacing of, 161, 163  
   pK value of, 282  
   stability constant of, 282, 283  
 Gouy–Chapman double-layer theory, 176  
   limitations to, 178  
 Gravitational potential, 55  
 Graviton, 11, 13  
 Gravitropism, 48  
 Gravity segregation, 49  
 Gray humic acid, 97  
 Green humic acid, 97  
 Guaiacyl propane monomers, 90  
 Guggenheim–Anderson–de Boer (GAB) equation, 191–192  
 Gymnosperm, 90
- H**
- Hadron, 10, 11  
 Half-cell, 27, 28, 30  
   potential, 27, 260  
   reaction, 27, 28–30, 69, 286  
 Half-life of radioisotopes, 23  
 Halloysite, 139  
   characteristics of, 139  
   composition of, 139  
   d (basal) spacing of, 139  
   electron microscopy of, 139–140  
   meta-, 139  
   tabular, 140  
 Hard soft acid base (HSAB) concept, 246, 293  
 Heat of adsorption, 194  
 Heat of hydration, 51  
 Heat of solution, 51  
 Heat theorem, 28  
 Heat of wetting, 51  
 Hectorite, 141  
 Helmholtz double-layer theory, 175–176  
 Helmholtz free energy, 36  
*Helminthosporium* sp., 197  
 Hematite, 148, 149, 150, 291  
   pK value of, 282  
   stability constant of, 282  
 Hemicellulose, 79  
 Henderson–Hasselbalch equation, 64–65  
   application of, 65, 248  
   buffer capacity, 65  
   in humic acid reactions, 104  
   pK<sub>a</sub> of, 64–65  
 Henry's rule, 47, 48, 49  
 Heteropolysaccharides, 76  
 High-affinity isotherm, 188  
 High-performance size-exclusion chromatography (HPSEC), 105  
 Histosphere, 307  
 Homopolar bonds, 269  
 Homopolysaccharides, 79  
 Humates, 132  
 Humic acid, 95–96  
   A, B, P, R<sup>p</sup>, and P types of, 97  
   agricultural importance of, 130–132  
   alcoholic-OH content of, 103  
   allochthonous, 97  
   amino acid in, 101, 125, 128  
   autochthonous, 98  
   brown, 96  
   carboxyl content of, 101, 102  
   chromatography of, 105  
   color ratio (E<sub>4</sub>/E<sub>6</sub>) of, 107, 108, 112–113  
   composition of, 99  
   derivative spectrum of, 113–114  
   diameter (size) of, 95  
   direct effect on plants of, 130  
   electron microscopy of, 121, 123–124  
   electron paramagnetic resonance (EPR) of, 117  
   electron spin resonance (ESR) of, 98, 117–118  
   elemental composition, 99, 100  
   enzyme interactions, 308  
   esterification of, 102  
   extraction and isolation of, 97–99  
   fluorescence spectrum of, 114  
   free radical content of, 115  
   functional groups of, 102, 103–104  
   geologic, 97  
   gray, 96  
   green, 96, 97  
   hydroxyl content of, 103  
   indirect effect on plants of, 130–131  
   industrial importance of, 130, 132  
   infrared absorption bands of, 114–115  
   infrared spectroscopy of, 114–115  
   magnetic resonance spectroscopy of, 115–116  
   molecular weights of, 95–96, 109–110, 112  
   nuclear magnetic resonance (NMR) of, 118–119  
     aliphatic region, 122  
     aromatic region, 122  
   phenolic hydroxyl content of, 103  
   polysaccharides in, 101, 115, 119, 126, 128  
   potentiometric titrations of, 106  
   protein in, 101, 126, 128  
   pseudostructures of, 129  
   saponification (NaOH treatment) of, 126  
   silylation of, 109  
   spectral characteristics of, 112  
   structural chemistry of, 124  
   hypothesis of author, 127  
   hypothesis of Flaig, 127  
   hypothesis of Kononova, 126  
   hypothesis of Picollo, 128

- hypothesis of Stevenson, 127
    - total hydroxyl content of, 103
    - UV and visible light
      - spectrophotometry of, 112
  - Humic allophane soils, 155
  - Humic matter, 77, 94
    - allochthonous, 97
    - aquatic, 97, 99
    - autochthonous, 97
    - carboxyl groups in, 101, 102
    - chromatography of, 105–106, 109
    - elemental composition of, 99, 100
    - extraction of, 97–99
    - fractions, 96, 111
    - geologic, 97
    - grass and bamboo, 97
    - hardwood, 97
    - hydroxyl groups in, 103
    - linear dimension, 95
    - mass units, 95, 96
    - membrane-micelle model, 94
    - molecular weight of, 95, 109–110, 112
    - new look of, 94–96
    - old look of, 94–95
    - operational concept, 94
    - pH-dependent charges in, 172
    - polymer (old) concept, 94
    - pseudomicellar concept of, 94
    - softwood, 97
    - spectral characteristics of, 112, 113
    - structural chemistry of, 124
    - supramolecular (new) concept, 94, 95–96
    - terrestrial, 97
    - total acidity of, 101
    - types of, 97
    - variable charges, 103–104
  - Humidity
    - absolute, 47
    - air, 46
    - relative, 46–47, 57
    - soil, 46
    - specific, 47
  - Humification, 76, 94
  - Humified substances, 76, 94, 295
  - Humin, 95
  - Hummous, 77
  - Humus, 77
  - Humus, 76, 77
    - acid, 95
    - content in soils, 76
  - Hydrolysable unknown N (HUN), 90, 101
  - Hydrargillite, 149
  - Hydration shell, 66, 184, 302
  - Hydration water, 184
    - in first hydration shell, 195
    - in outer hydration shell, 195
  - Hydrobiotite, 144
  - Hydrogen bonding, 51, 187
    - adsorption of water by, 193
  - Hydrogen electrode
    - standard, 29
  - Hydrogen ion
    - adsorbed or exchangeable, 251
    - anthropogenic source of, 254
    - nonexchangeable, 251
    - nonselective adsorption of, 251
    - preferential adsorption of, 251
  - Hydrologic cycle, 50
  - Hydronium ion, 62, 214
  - Hydrophilic colloid, 75
  - Hydrophobic bonding, 187, 305
    - in molecular adsorption, 302
  - Hydrophobic colloid, 75
  - Hydrophobicity
    - acquired soil, 81, 196
  - Hydroquinone, 92
  - Hydrosols, 76
  - Hydrostatic pressure, 54, 56
  - Hydrotropism, 48
  - Hydrous mica, 143
  - Hydroxy-interlayered minerals (HIM), 145
  - Hydroxy-interlayered smectite (HIS), 145
  - Hydroxyaluminum interlayer
    - vermiculite (HIV), 145, 217, 222
  - Hymatomelanin acid, 97, 99, 115, 126
    - infrared spectrum of, 115, 126
  - Hypoglycemia, 82
  - Hypogravity, 48
  - Hypoxia, 46, 50
    - environmental, 50
    - medical, 50
- I**
- Identification of clay minerals, 155
  - Illite, 143, 222
    - cation exchange capacity of, 143
    - characteristics of, 143
    - d spacing of, 143
    - occurrence in soils of, 143
    - potassium content of, 143
  - Imbibition, 80
  - Immiscible displacing liquid, 49
  - Immobilization of
    - metal–humic acid complexes, 303
    - phosphate, 233–234, 235
  - Imogo, 152
  - Imogolite, 152, 153, 155
    - alumina/silica ratio of, 152, 153
    - cation exchange capacity of, 153
    - characteristics of, 153
    - composition of, 153
    - d spacing of, 154
    - electron microscopy of, 154
    - occurrence in soils of, 155
    - proto-, 153
    - structure of, 153, 154
  - Indicator electrode, 261
  - Indifferent ions, 227
  - Infrared analysis, 161
    - bending vibration, 165
    - dipole moment in, 162
    - fingerprint regions, 166, 167, 168
      - of gibbsite, 168
      - of humic matter, 115
      - of kaolinite, 167
      - of montmorillonite, 167
    - frequency units in, 166

- functional groups in, 103, 166
  - group frequency regions, 166, 167, 168
    - of gibbsite, 168
    - of kaolinite, 167
    - of montmorillonite, 167
    - of organic compounds, 115, 116
  - molecular vibrations in, 165
  - samples for, 165
  - simple harmonic motion, 162
  - stretching vibrations, 162
  - types of vibrations in, 165
  - wave numbers in, 166
  - Infrared bands of clays, 166–168
  - Infrared bands of humic acids, 116
  - Inner Helmholtz layer, 179
  - Innersphere complex reaction, 188, 229
  - Innersphere surfaces, 167, 184, 193
  - Inorganic components of soils, 133
  - Inosilicates; *See* Silicates
  - Insulin, 84
  - Intercalation, 200, 302
    - of 1:1 type of minerals, 200
    - of 2:1 type of minerals, 200
  - Interface, 28, 76
  - Interfacial energy, 183
  - Interlayer adsorption of organic matter, 200
  - Interlayer charge, 222
  - Interlayer water, 195
    - characteristics of, 195
    - effect on basal spacings of, 194, 195
    - types of, 194
  - Internal pairing of proton donors, 195, 196
  - Interparticle attraction, 203
  - Interparticle distance, 181
    - effect on aggregation of soil particles, 181
    - effect on stability of clay suspension, 181
  - Interplanar spacing, 135
  - Interstratification, 146
    - random, 146
    - regular, 146
  - Intrinsic surface charge, 173
  - Ion activity, 70
    - coefficient, 70
  - Ion–dipole reaction, 199
  - Ion exchange constant, 67
  - Ion pairs, 65–66, 248–249
    - acid strength and, 248
    - equilibrium constants, 66, 249
    - innersphere, 66
    - outersphere, 66
  - Ion product constant, 62
  - Ion selectivity, 67, 213
    - coefficient, 67
      - Gapon, 67
      - Vanselow, 67
  - Ion transport, 27
  - Ion uptake by plants, 27
  - Ionic bond, 269
  - Ionic radius, 19
    - crystalline, 19, 205
    - hydrated, 19, 205
  - Ionic strength, 71–73
    - effect on ion activity coefficients, 72
    - of ocean water, 72–73
    - of streams and lakes, 72–73
    - of water and rocks, 72–73
  - Ionization constant ( $pK_a$  or  $pK_a$ ), 64, 248
  - Iron chelate, 303
  - Iron hydroxyphosphate, 232
    - solubility of, 231
  - Iron oxide clays, 148
    - cation exchange capacity of, 150
    - characteristics of, 148–149
    - composition of, 149
    - d spacing of, 150
    - fixation of phosphate, 150
    - members (types) of, 148
    - occurrence in soils of, 150–151
    - retention of cations by, 150
    - soil aggregation by, 150
    - stability of, 291
    - structure of, 148–149
  - Iron-podzol, 303
    - B<sub>1</sub> horizon, 303
  - Island structure, 136
  - Isoelectric point, 85, 173, 180, 301
  - Isoelectric point pH (pI), 85
  - Isoionic point, pI, 308
  - Isolated structure, 136
  - Isomorphous substitution, 171–172
    - ease of, 172
  - Isoprenoid, 87
  - Isotopes, 22
- K**
- K-cycle, 267
  - K fixation, 221
    - effect of complex formation on, 306
  - Kaolinite, 138
    - cation exchange capacity of, 139
    - characteristics of, 139
    - composition of, 138
    - d spacing of, 138
    - DTA of, 157, 158
    - members (types) of, 139
    - occurrence in soils of, 139
    - stability of, 275
    - structure of, 138
    - surface area of, 185
    - weathering of, 140
  - Kerr's equation, 213–214
  - Ketones, 78
  - Ketose group, 78
  - Kinetic equations of cation exchange, 214–215
  - Klasons method, 91
  - Kuroboku soils, 155
- L**
- Landscape evolution, 267
  - Langmuir equation, 189, 190, 212–213
    - reassessment of, 191
  - Langmuir–Freundlich equation, 190
  - Landmuir–Vageler, 212
  - Laterites, 279
  - Lateritic soils, 279
  - Laterization, 279, 281

- Lattice  
  spacing, 135, 159  
  structure, 133, 135
- Law of conservation of mass, 2
- Law of electroneutrality, 270
- Law of mass action, 4, 59–60, 215
- Leaching ratio, 266
- Leaching requirement, 266
- Leaf necrosis, 257
- Lecithine, 88
- Leonardite, 98
- Lepidocrocite, 148, 149, 163  
  pK value of, 282  
  stability constant of, 282
- Leptons, 10, 11
- Leptospirillum*, 277
- Lessivage, 281, 282
- Leucite, 272
- Lewis  
  acid-base concept, 244–245  
  application in soils, 246  
  acidity, 187, 245  
  base, 187, 245
- Ligand, 293, 303
- Ligand exchange, 187, 188, 229, 298, 299
- Ligare, 293
- Lignan, 94
- Lignification, 92  
  functions of, 92
- Lignin, 90  
  ammonia fixation of, 93  
  colloidal chemistry, 92–93  
  coumaryl, 90  
  from grasses, bamboo, and palm, 90  
  from hardwood, sinapyl, 90  
  importance of, 93  
  in industry and pharmacology, 93  
  moss, 90  
  pulp and paper production, 93  
  from softwood, coniferyl, 91  
  structure of, 91  
  in vascular bundles of grass, 93  
  in vascular bundles of legumes, 93
- Lignite, 93, 98, 121, 132
- Lignolytic fungi, 93
- Ligno-protein theory, 127
- Lime potential, 261–262
- Limonite, 149
- Linoleic acid, 89
- Lipids, 77–87  
  classification of, 87  
  cation exchange of, 88  
  compound, 87  
  contents in soils, 88  
  derived, 87  
  exchange reactions by, 88  
  glycerol in, 87  
  glyco, 87  
  isoprenoid, 87  
  phospho, 87  
  prenol, 87  
  saccharo, 87  
  simple, 87  
  sphingo, 87  
  sterol, 87  
  structure of, 88  
  syringil, 90  
  terpenoid, 87
- Lithogenic weathering, 276
- Litter, 76
- Lizardite, 135
- Localized dry spot, 196, 197  
  organisms in, 197
- London–Van der Waals attraction; *See* Van der Waals attraction
- Long-range-order minerals, 134
- Low carb diet, 82
- Lowland rice, 286
- Lux and Flood concept, 246
- Lyophilic colloids, 75
- Lyophobic colloids, 75
- Lytropic series  
  of anions, 228  
  of cations, 205  
  of metals in chelation, 297  
  of oxygen sharing, 272
- ## M
- Macropores, 193
- Maghemite, 149, 163  
  pK value of, 282  
  stability constant of, 282
- Magnetic resonance imaging (MRI), 119
- Magnetic resonance spectroscopy; *See also* Humic acid  
  electron para (EPR), 115, 117, 118  
  electron spin resonance (ESR), 117
- Magnetite, 291  
  conversion into hematite, 291
- Margarite, 207
- Mass, 15  
  atomic, 15  
  SI units of, 15
- Mass action, 59  
  in cation exchange, 215
- Mass flow, 44–45
- Mass number, 15  
  atomic, 15
- Matter,  
  anti, 10  
  dark, 10
- Matric potential, 54, 55–56, 59, 193
- Matric suction, 55
- Matrix  
  soil, 25
- Mauna Loa data set, 41
- Max Planck length, 14, 311
- Maximum retentive capacity, 193
- Mean residence time  
  of glomalin, 78  
  of humus, 78
- Megatron, 8
- Membrane  
  biological, 38, 218  
  micelle concept of humic compounds, 96  
  potential, 38, 241
- Meson, 13
- Metahalloysite, 139

- Metal bridging, 96, 230, 299
- Metal–ligand  
 complexes, 293  
 environmental or ecological effect, 306, 307, 308  
 interaction, 293, 302  
 ratio, 303  
 soft and hard bases (acids) in, 293
- Metal mobility induced by chelation, 302–303
- Metallic bond, 269
- Metamorphism, 207
- Methane, 43, 82
- Methanogens, 43
- Mica, 135, 143, 222  
 hydrous, 143  
 soil, 143
- Micromorphology, 25
- Micropedology, 25
- Micropores, 193
- Miller indices, 135–136
- Mine spoil, 254, 256
- Mine tailings, 256
- Mineral  
 conversion, 147  
 14 Å, 144
- Mineral properties, 269  
 electrical, 269  
 mechanical, 269  
 optical, 269  
 structural, 269  
 thermal, 269
- Mineralization of organic P, 234
- Mixed-layer clay, 146  
 d spacing of, 146  
 interstratified, 146  
 occurrence in soils of, 146–147
- Moisture potential, 54, 55
- Moisture tension, 55
- Molality, 21, 22
- Molar water potential, 56
- Molarity, 21, 22
- Mole fraction, 22
- Molecular adsorption; *See* Adsorption  
 in complex reaction, 302  
 hydrophobic bonding in, 302  
 van der Waals force in, 302
- Molecular modeling of humic acids, 129
- Molecular orientation in adsorption, 201
- Molecular sieve fractionation, 105–106
- Molecular volume of humic acid, 112
- Molecular weight of humic acid, 95, 110  
 number-average ( $M_n$ ), 110  
 weight-average ( $M_w$ ), 110, 111  
 Z-average ( $M_z$ ), 110
- Mollic epipedon, 303
- Mollisols, 142, 303  
 immobilization of Ca-humates in, 303
- Mononucleotides, 89
- Monoprotic acid, 62, 63, 199
- Monosaccharides, 79
- Monosilicic acid complexation with metals, 304
- Montmorillonite, 141–142, 160, 162, 164, 200  
 adsorption of organic compounds by, 200  
 cation exchange capacity of, 142  
 characteristics of, 141  
 d spacing of, 142  
 members of, 141  
 occurrence in soils of, 142–143  
 specific surface area of, 142, 185  
 structure of, 141  
 swell–shrink capacity of, 142, 143
- Mucigels, 305, 306  
 in complex formation, 305
- Mucilage, 81
- Mullite, 157
- Multilayer adsorption, 191
- Muons, 11
- Muscovite, 207
- Mutarotation, 78
- N**
- Nackrite, 139
- Negative adsorption; *See* Adsorption
- Negative charge, 170  
 by dissociation of exposed hydroxyl groups, 172  
 increase by organo–clay complex formation, 281  
 by isomorphous substitution, 170, 171  
 permanent, 171  
 variable, 172
- Nernst equation, 27, 28, 58, 260, 282  
 Thompson rule, 28
- Nesosilicates; *See* Silicates
- Neuroprotective agent, 94
- Neurotransmitters, 86
- Neutrinos, 11  
 annihilation, 11  
 dark matter, 11  
 GEMINI project, 12  
 GENIUS project, 12  
 GEOSCAN project, 12  
 LUNASCAN project, 12  
 types of, 11
- Neutrons, 7, 10, 11, 14
- Newton  
 law of, 7, 15
- Nimite, 145
- Nitrification, 1, 254  
 definition, 254  
 effect of pH on, 243, 254  
 effect on soil acidity, 257  
 organisms, 254
- Nitrobacter*, 254
- Nitrosomonas*, 254
- Noncharging ions, 227
- Noncrystalline clay, 133, 152
- Nonhumified substances, 76, 295
- Nonsaline-alkali soil, 263
- Nonselective adsorption of H<sup>+</sup>, 251
- Nontronite, 135, 141
- Normality, 21
- Nuclear charge, 14, 17
- Nuclear force  
 strong, 11, 12  
 weak, 11, 12
- Nuclear fusion, 12
- Nuclear magnetic resonance (NMR), 119–120, 121  
 CP-MAS <sup>13</sup>C (cross-polarization magic-angle-spinning  
 carbon-13), 120

- of fulvic acid, 121, 123
  - of humic acid, 121
  - hyperpolarization, 120
  - liquid N<sub>2</sub> technique, 124
  - major regions, 120, 121
  - of polysaccharides, 122
  - solid state, 120
  - Nucleic acid, 89
    - deoxyribo, DNA, 89
    - exchange reactions of, 90
    - oxyribo, RNA, 89
  - Nucleoprotein, 89
  - Nucleus, 7, 14, 89
    - size, 14
- O**
- Occult deposition, 258
  - Octahedron, 270, 271; *See also* Aluminum octahedron
  - Olation reaction, 253
  - Oligosaccharides, 79
  - Omega-3 fatty acid, 89
  - Opal, 148
  - Organic acids, 78, 295
    - effectiveness in chelation, 278, 295
    - humified, 278, 295
    - nonhumified, 278, 295
    - types of, 278, 295
  - Organic colloids, 76
  - Organic compounds, 77
  - Organo-phosphate complexes, 236
  - Orthoclase, 207
  - Orthophosphoric acid, 255–256
  - Orthosilicic acid, 280
  - Oscillation, 165
  - Osmometry, 110
  - Osmosis, 54, 193
  - Osmotic adjustment, 197
  - Osmotic potential, 54, 56, 59, 197, 198
    - at zero turgor, 198
  - Osmotic pressure, 198
  - Osmotic volume, 198
  - Outer Helmholtz layer, 179
  - Outersphere complex reaction, 188, 227
  - Outersphere surface, 167, 184
  - Overburden water potential, 55
  - Oxic horizon, 279
  - Oxic soil, 288, 289
  - Oxidation, 43, 285
    - biochemical, 52
    - enzymatic, 277
    - microbial, 277
    - nonenzymatic, 277
  - Oxidation potential,  $E_h$ , 29, 283
    - $E_h$  – pH relation, 287
  - Oxidation-reduction reactions, 28–29, 285
  - Oxides, 148–149
  - Oxidic ratio, 151
  - Oxisol, 281
  - Oxolation reaction, 253
  - Oxygen
    - availability, 50
    - content in air, 41
    - content in water, 50
    - depletion, 50
    - revolution, 108
  - Oxygen demand of water, 52
    - biochemical, 52
    - biological (BOD), 52
    - carbonaceous (CBOD), 53
    - chemical (COD), 52
    - nitrogenous stage of, 53
    - total (TOD), 52, 53
    - values of, 53
  - Oxygen diffusion rate (ODR), 45
    - critical, 46
    - minimum, 46
  - Oxy-hydroxy surface, 168
  - Ozone, 44
    - layer, 258
- P**
- Paddy soils, 285, 286
    - iron-B horizon, 286
    - manganese-B horizon, 286
  - Palygorskite, 135, 137
  - Paracrystalline clay, 133, 151, 153
  - Paragonite, 135
  - Particles
    - alpha ( $\alpha$ ), 22
    - elementary, 10
  - Partition coefficient,  $K_d$ , 107, 109
    - relation with color ratio, 108
  - Passive transport, 38
  - Pauling's rules, 269, 270, 271
  - pe–pH relation, 288
    - constancy in, 289
    - diagram, 287
    - importance in biological systems, 288
    - importance in soils, 288
  - Pearson concept, 246
  - Pedochemical weathering, 4, 5, 268
  - Pedogenic soil profile, 268
  - Pedogenesis, 267, 279
  - Pedology, 4, 5
  - Pedon, 4, 6, 267, 279
  - Pennatite, 145
  - Peptides, 84
    - poly, 84
  - Permanent charge, 171
  - Permanent structural charge, 171
  - Permanent wilting percentage, 193
  - Permanent wilting point, 103, 197
  - Petrography, 1
  - Phase diagram of soil minerals, 275
  - pH-dependent charge, 172, 255
    - of humic matter, 104
  - pH effect on humic and fulvic acid structure, 123
  - pH measurements, 259–260
    - in CaCl<sub>2</sub>, 261
    - in KCl, 261
    - in soil suspension, 260
    - suspension effect in, 261
    - in water extract, 260
  - Phenyl propane, 91
  - Phlogopite, 135
  - Phosphate availability and fixation, 230



- relationship with pH, 236, 237–238
- Phosphate fixation: *See* Fixation
  - in acid soils, 231
  - in alkaline soils, 232
  - biological, 233
  - effect of complexation on, 306
  - by ferrol and aluminol surfaces, 232
- Phosphate potential, 26, 238, 240, 253
  - chemical, 239, 240
  - electrochemical, 239, 240
  - Schofield's, 239, 241
- Phosphate retention, 230, 231
  - Gapon relation of, 231
  - mass action in, 231
- Phosphatides, 87
- Photon, 11, 13
- Photosynthesis, 82
- Phyllosilicates, 135, 147; *See also* Silicates
- Physical adsorption, 228
- Physical chemistry, 3, 4
  - soil, 4
- Physical encapsulation, 305
- Physics, 3
- Phytoestrogen, 94
- Phytoextraction, 257
- Phytoremediation, 257
- Phytostabilization, 256
- pI, 308
  - value, 61, 62, 301
  - value of aluminum compounds, 284
  - value of iron compounds, 282
- Pisolithus tinctorius*, 230, 277
- pK<sub>a</sub> values, 63, 226, 199–200, 248
  - critical  $\Delta pK_a$ , 200
- pK<sub>b</sub>, 301
- pK<sub>p</sub>, 300–301
- pK<sub>sp</sub>, 61
- Plant–soil–water energy relation, 58
- Plasma
  - inorganic soil, 25
  - organic soil, 25
  - quark–gluon, 10
- Plasmolysis; *See* Cytoplasmolysis
- Plinthite, 285
- Plinthization, 286
- Pneumatic pressure, 56
- Podzol, 282, 303
- Podzolization, 281, 282, 303, 304
  - inorganic mechanism of, 282, 303
  - requirement of, 304
- Point zero charge (PZC), 225
  - pristine, 225
- Polar molecules, 201
- Polarity of water, 51
- Polarizability of organics, 201
- Polyhedron, 270
  - coordination, 269
- Polyhydroxyaldehydes, 78
- Polyketides, 87
- Polymerization of aluminum, 278, 279
- Polymerization law in solubility of silica, 280
- Polynuclear polyacid, 103
- Polyprotic acid, 63, 65, 199
- Polysaccharides, 79
  - extracellular (ECP), 305, 306
  - in fulvic acids, 101, 122, 126
  - hetero, 79
  - homo, 79
  - in humic acids, 101, 122, 126
  - role in complex formation, 305
  - role in soil aggregation, 305
- Pore space
  - gas filled portion of, 44
  - total, 41
- Positive charges, 173, 225, 226
- Positive heat of adsorption, 185
- Positrons, 7
- Potassium fixation, 221–222
  - as influenced by complex formation, 306
- Potential buffering capacity, PBC<sup>K</sup>, 217
- Potential determining ions, 173, 225
- Potential energy, 54
- Potential soil acidity, 250
- Potentiometric titration, 173–174
- Preferential adsorption of H<sup>+</sup>, 251
- Pressure potential, 56, 59
- Primary minerals, 133
- Pristine point zero charge (PPZC), 225
- Proactinium, 23
- Profile
  - soil, 4, 279
  - weathering, 4
- Protease, 308
- Proteins, 83–84
  - in humic acids, 101
  - nucleo, 89
- Proteolytic organisms, 308
- Proteosynthesis, 131
- Proterozoic era, 43
- Protoimogolite, 153
- Proton, 7, 10, 11, 14
  - acceptor, 244, 245
  - charge, 172–173
  - concept, 244
  - donor, 244, 245
- Protonation, 186, 226
  - in complex formation, 300
  - constant, pK<sub>p</sub>, 300, 301
  - of hydroxyl groups, 173
  - processes, 300
- Protoplasm, 59
- Pseudoadsorption, 185
- Pseudo-boehmite, 279
  - organic/Al ratio in formation of, 279
- Pseudogley formation, 286
- Pseudomonas* sp., 295
- Pseudostructures, 129
  - computer models of, 130
- P-solubilizing organism, 277
- Putrefication, 43
- Pycocyanin, 295
- Pyrite, 256, 259
- Pyrogallol, 92
- Pyrophyllite, 135, 162
- Pyruvate, 42
- Pyruvic acid, 42

## Q

- Quantity/Intensity relation,  $Q/I$ , 216
  - equation, 216
  - intensity factor, 216, 217
  - potential buffering capacity,  $PBC^K$ , 217, 218
  - quantity factor, 216, 217
- Quantum mechanics, 7
- Quantum physics, 7
- Quarks, 10, 11
  - down, 11
  - up, 11
- Quartz, 147
  - alpha ( $\alpha$ ), 147
  - beta ( $\beta$ ), 147
  - hexagonal, 147
  - trigonal, 147
- Quinhydrone, 118
- Quinone, 92, 117, 118

## R

- Radiation
  - $K_\alpha$ , 15
  - $K_\beta$ , 15
- Radioactivity, 23
  - Half-life of, 23
- Radius of ions; *See* Ionic radius
- Radius ratio, 270
  - and crystal geometry, 270–271
  - relationship with coordination number, 270
- Rectorite, 146
- Redox potential, 26, 29, 46, 286
  - application in soils of, 287, 289
  - curve as influenced by time of flooding, 290
  - curve of waterlogged soil, 290
  - determination of, 46
  - relationship with soil pH, 287
  - and stability of iron compounds, 291
  - standard, 286
  - values at soil reaction status, 290
- Redox reaction, 28, 289
  - effect on soil microorganisms, 289, 291
  - effect on status of plant nutrients, 289, 291
  - in gleying, 286
  - limits in soils, 286, 287
  - in paddy soils, 286
  - in plinthite formation, 286
  - in relation to electron activity, 33, 287
  - in relation to nitrification, 286
  - in relation to soil formation, 286
  - in soils, 287
- Reduction, 43, 285
  - potential, 29, 287
  - products activity, 292
- Reference electrode, 27, 260
- Reference temperature, 71
- Regolith, 4, 276
- Repulsive energy, 181
- Repulsive potential, 181
- Reserve soil acidity, 254
- Resonance frequency, 14
- Respiration, 130, 131
  - aerobic, 41

- anaerobic, 42
- cellular, 42
- oxidative, 42, 44
- rH concept, 34–35
- Rhexistasy, 267
- Rhizobia*, 308
- Rhizoplane, 307
- Rhizosphere, 277, 295, 307
  - acetic acid in, 277, 295
  - organisms, 295
  - secretions and production of chelants in, 294
  - endo, 307
  - number of microorganisms in, 277, 295
- Rhizotron, 48
- Ribonucleic acid (RNA), 79, 89
  - messenger, mRNA, 89
  - ribosomal, rRNA, 89
  - soluble, sRNA, 89
- Ribose, 89
- Ribosomes, 89
- Roentgen radiation, 15
- Root exudates, 131
- Rothmund–Kornfeld model, 210–211, 212

## S

- Saccharides
  - di-, 79
  - hetero-, 79
  - homo-, 79
  - mono-, 79
  - oligo-, 79
  - poly-, 79–80, 101, 126
  - soil poly-, 80
- Saline–alkali soils, 263
- Saline soils, 262, 265
  - chemical characteristics of, 262–263
  - dispersion of, 263
  - effect on plant growth, 263–264
  - irrigation of, 264
- Salinity hazard, 264–265
- Salinization, 262
  - effect on plant growth, 264
  - irrigation induced, 264–265
- Salt balance, 266
- Salt bridges, 296
- Salt replaceable acidity, 250
- Sand, 133
  - coarse, 157
  - cytomorphic, 277
  - fine, 157
  - medium, 157
  - very fine, 157
- Saponification, 87
- Saponite, 141
- Saprocks, 4, 267, 276
- Saprolite, 4, 267
- Sauconite, 135
- Schofield's ratio law, 220–221, 261
  - and phosphate concentration, 239
- Schwertmannite, 149
- Second and third derivative EPR spectra, 117–118
- Secondary minerals, 133

- Seismology, 12  
 reflective sonic, 12
- Selectivity coefficient, 67, 213, 215  
 Gapon, 67, 214  
 Vanselow, 67, 214
- Self flocculation  
 of kaolinite, 226
- Semiquinone, 118
- Sephadex-gel filtration, 106–107, 111, 112
- Sepiolite, 135
- Sequestering agent, 293
- Serpentine, 135
- Shearing plane, 180
- Sheet structure, 135, 136
- Shell  
 K, 14  
 L, 14  
 M, 14
- Short-range-order (SRO) clay, 133, 134, 151, 152
- SI system, 15, 21, 51
- Siderophores, 295
- Silanol surface, 167
- Silica  
 complex formation with humic acid, 281  
 potential, 26, 274  
 solubility of, 280
- Silica minerals, 147  
 amorphous, 147  
 characteristics of, 147  
 composition of, 147  
 d spacing of, 148  
 members (types) of, 147  
 occurrence in soils of, 148  
 solubility of, 147–148  
 structure of, 147  
 surface area of, 147  
 surface charge of, 147
- Silica tetrahedron, 136, 137, 271
- Silicates  
 cyclo-, 133–134, 273  
 ino-, 133–134, 273  
 neso-, 133–134, 273  
 phyllo-, 133–134, 135, 273  
 soro-, 133–134, 273  
 tecto-, 133–134, 273
- Silicic acid (mono, ortho), 280
- Silicification, 279, 280  
 of gibbsite, 280  
 of kaolinite, 280
- Siloxane bond, 167, 272
- Siloxane surface, 167
- Silt, 133
- Silylation, 109
- Simple harmonic motion, 165
- Slick spots, 263
- Slipping plane, 180
- Smectite, 141–142, 222
- Sodic soils, 263  
 chemical characterization of, 263  
 effect on plant growth, 264  
 irrigation of, 265
- Sodication, 262  
 effect on plant growth, 264  
 irrigation induced, 266
- Sodication hazard, 263, 265
- Sodium adsorption ratio (SAR), 264, 265, 266
- Soft acid–soft base interaction, 293
- Soil acidity; *See also* Active acidity  
 active, 250  
 concept of, 249  
 exchange, 250  
 equivalent, 250  
 need for, 249  
 potential, 250  
 reserve, 250, 254  
 residual, 251  
 role of acid rain in, 257  
 role of aluminum in, 252–253  
 role of fertilizers in, 254  
 role of monocalciumphosphate in, 255  
 role of N-fixation in, 254–255, 257  
 role of pyrite in, 254, 256, 259  
 role of sulfur in, 254, 256  
 total, 296
- Soil air, 5, 44, 48  
 absolute humidity of, 47  
 composition of, 41  
 fluctuation of CO<sub>2</sub> content in, 41  
 humidity of, 46  
 O<sub>2</sub> content in, 41, 45  
 quality characterization, 45  
 relative humidity of, 46  
 specific humidity of, 47
- Soil composition, 5, 25
- Soil fabric, 25, 26
- Soil fatigue, 89
- Soil formation, 267; *See also* Pedogenesis  
 processes, 279–280
- Soil horizon, 267  
 albic, 282  
 argillic, B<sub>1</sub>, 281  
 iron-B, 286  
 manganese-B, 286  
 spodic, 282  
 textural B, 281
- Soil matrix, 25
- Soil microbiology, 1, 5
- Soil moisture suction, 57
- Soil moisture tension, 57
- Soil organic matter, SOM, 76
- Soil redox state, 286
- Soil pH  
 buffered, 261  
 definition, 247–248, 260  
 formulation of, 247, 260  
 in leaching of Al and Fe, 258  
 measurement of, 260–261  
 in nitrification, 258  
 ranges, 249
- Soil physical chemistry, 3
- Soil physics and complex reaction, 305
- Soil plasma, 25, 26  
 inorganic, 25  
 organic, 25
- Soil profiles, 267, 279
- Soil reaction, 243  
 and availability of inorganic P, 237  
 definition of, 243

- effect on nitrification, 243
- requirements for plant growth, 241
- types (classes) of, 249
- Soil solution, 48
  - approximations of, 48–49
  - concept of, 48
  - importance of, 48
- Soil vermiculite, 135, 144
- Soil water, 48, 50
  - chemistry of, 50–51
  - energy concepts of, 53
  - energy relation with plants of, 58
  - potential, 54
  - units of soil water potential, 56–57
- Sol, 75, 76
  - hydro, 75, 76
- Solods, 263
- Solonchaks, 263
- Solonetz, 263
- Solubility, 61
- Solubility constant
  - of aluminum compounds, 284
  - of iron compounds, 282
  - of kaolinite, 274
  - of orthoclase, 274
  - of variscite, 239
- Solubility of iron compounds in relation to redox potentials, 283
- Solubility of phosphates as influenced by complex formation, 306
  - soil pH, 236–237
- Solubility product, 61
  - constant, 61
  - of iron compounds, 282
  - of variscite, 239
- Solubility of silica, 147, 280
- Solute, 26, 48, 56
- Solute potential, 54, 56, 59
- Solvation, 200
  - sheath, 66
- Solvent, 48
- Sorbate, 76
- Sorbent, 76
- Sorosilicates; *See* Silicates
- Sorption, 76
  - chemi, 150
- Specific surface area; *See* Surface area
- Sphingosine, 87
- Spodic horizon, 282, 285, 303
- Spodosols, 303
  - Al and Fe chelates in, 303
- Stability constant, log K, 224, 296–297
  - of aluminum compounds, 285
  - of clay–microbial interactions, 307–308
  - derivation of, 296–297
  - of EDTA complexes, 297–298
  - of gibbsite, 275
  - of iron compounds, 282
  - of kaolinite, 274
  - of metal–organic complexes, 224, 297
  - of soil minerals, 275
- Stability fields (diagrams)
  - of EDTA and DPTA complexes, 304
  - of iron compounds, 284
  - of metal chelates, 304
  - of soil minerals, 275
  - of variscite, strengite, and apatite, 239
- Stability of minerals, 272
  - effect of bond type on, 272
  - energy formation in, 272
  - ranking of, 272
  - phase relationship and, 275
- Standard electrode potential, 29
- Standard model of atoms, 13, 14
- Standard state, 71
- Statistical modeling of isotherms, 188–189
- Stem flow, 259
- Steric hindrance, 201
- Stern double-layer theory, 178
- Stern layer, 178
- Stern potential, 179
- Sterol, 87
- Stratified vermiculite, 145
- Strengite, 232
  - isomorphous series of, 232
  - solubility diagram, 238
- String theory, 13
  - super, 13
- Structural chemistry of clay, 135
- Structural chemistry of humic acid according to author's hypothesis, 128
  - Flaig, 126
  - Kononova, 125–126
  - Piccolo, 129
  - Schnitzer and Khan, 125
  - Stevenson, 126–127
- Subatomic particles, 7–8
- Suberin, 58
- Suboxic soil, 288, 289
- Sulfate-coated urea, 256
- Sulfate reducers, 289
- Supernova, 10, 11
- Supramolecular
  - assemblages, 96, 128
  - complexes, 293
- Surface acidity, 184, 186, 301
- Surface area, 169
  - specific, 170, 185
  - total, 169
  - variation of, 171
- Surface charge density, 174, 176
  - equation, 185
- Surface chemistry, 167
- Surface energy, 183
- Surface potential, 175
- Surface run-off, 50
- Surface tension, 51, 183, 211
- Surfaces
  - aluminol, 167–168
  - broken, 168, 169, 226
  - ferrol, 168, 169
  - innersphere, 167
  - outersphere, 168
  - oxyhydroxy, 168, 169
  - silanol, 168
  - siloxane, 167
  - specific, 170
  - total, 169

Surfactant, 75  
 Suspension effect, 260  
 Symplast pathway, 58  
 Synchrotrons, 8  
   CEBAF and ELIC, 8  
   CERN, 9  
   Fermi National Laboratory, 9  
   Realistic Heavy Ion, 8, 9  
   Stanford linear, 9

**T**

Tabular halloysite, 139  
 Talc, 135, 162  
 Tectosilicates; *See* Silicates  
 Tensiometer, 55  
 Tetrahedron, 136, 270, 271; *See also* Silica tetrahedron  
   pedogenesis  
 Tetramorphic clay, 137  
 Tevatron; *See* Synchrotrons  
 Textural B horizon, 281  
 Theory of everything, 13  
 Thermodynamic equilibrium constant, 68  
 Thermodynamics, 68  
   in cation exchange, 215  
   chemical, 215  
   first law of, 68  
   third law of, 28  
*Thiobacilli*, 277  
 Thorium, 23  
 Through fall, 259  
 Total soil water potential, 54  
 Transcellular membrane potential, 38  
 Transcellular transport, 58  
 Transformation, 280  
 Transition metal, 187, 294  
 Translocation of Al and Fe, 282, 285  
 Translocation of clay, 281  
 Tridymite, 147  
   alpha ( $\alpha$ ), 147  
   beta ( $\beta$ ), 147  
 Trimorphic clay, 137  
 Trioctahedral, 137  
 Triple layer, 179  
 Tritium, 22  
 Trumao soils, 155  
 Turbid haze, 258  
 Turgor potential, 59, 198

**U**

Ulmic acid, 95  
 Unit cell, 135–136, 137  
   size of, 135  
 Unit structure, 137  
 Units of soil water potential, 56–57  
 Uranium, 14, 17, 23  
 Urease, 308  
 Uronic acid, 127  
 Usanovich acid-base concept, 246

**V**

Vacuole, 59

Valence, 18, 19  
 Valence electron, 15, 18  
 Valence principle  
   electrostatic, 271  
 Van Bemmelen–Freundlich equation, 190  
 Van der Waals attraction, 176, 181, 186, 298  
   and complexation of anions., 299  
   effect of molecular size on, 201–202  
   effect on stability of minerals, 180–181  
 Van Laar model, 210–211  
 Vanselow, 211  
 Variable charge  
   clay, 150  
   of humic acid, 104  
   of microorganisms, 307  
   soil, 150  
 Variscite, 232  
   isotherm, 239  
   stability diagram, 238  
 Vascular bundle, 93  
 Vermiculare, vermicularis, 144  
 Vermiculite, 144, 222  
   cation exchange capacity of, 145  
   characteristics of, 144  
   composition of, 144  
   d spacing of, 144  
   occurrence in soils of, 144  
   soil, 144  
   structure of, 144  
   surface area, 185  
 Vibrations  
   bending, 165  
   stretching, 165  
 Volcanic ash soils, 148, 154  
 Voltaic cell, 27  
 Volumetric water potential, 56, 57

**W**

Water, 50  
   dimension of, 57  
   in first coordination sphere, 187, 194, 195  
   in second coordination sphere, 194, 195  
   interlayer, 194  
   polarity of, 51  
   unit mass of, 51  
 Water bridge, 96, 105, 184, 299, 302  
 Water molecule, 50  
 Water potential, 53, 54, 197  
   definition of, 54, 197  
   leaf, 59  
   molar, 56  
   root, 59  
   total, 54  
   units of, 56–57  
   volumetric, 56  
 Water potential difference, 53  
 Water potential gradient, 53  
 Water repellency, 81  
   due to lipids, 88  
 Waterproofing, 81  
 Weathering, 267  
   biochemical, 268, 278  
   biogenic effect, 276

biological, 268, 276  
 chemical, 268  
 of cyclosilicates, 273  
 definition, 267  
 effect of chelating agents on, 278  
 geochemical, 4, 267, 268  
 geomorphic, 267  
 of inosilicates, 273  
 lithogenic effect, 276  
 of nesosilicates, 273  
 pedochemical, 4, 267, 268  
 of phyllosilicates, 273  
 physical, 268  
 processes, 268  
 of soil minerals, 269, 272  
 stability of minerals in, 269  
 of tectosilicates, 273  
 Weathering of feldspar, 274  
 Weathering of kaolinite, 274  
 Weathering profiles, 267  
 Weathering sequence, 140  
 Wedge zone, 222  
 Weight, 15  
 Wet deposition, 258  
 White alkali soils, 262  
 Wilting point; *See* Permanent wilting point

## X

Xenobiotics, 306  
   in complex formation, 306  
 X-ray, 15  
 X-ray diffraction, 158  
   basis for, 158

Bragg's law in, 158–159  
 characteristic d spacings of soil minerals in, 163–164  
 first-order diffraction in, 159  
 hkl spacing in, 158  
 K $\alpha$  radiation in, 158  
 K $\beta$  radiation in, 158  
 lattice spacing in, 159  
 oriented samples in, 159, 161  
 patterns of gibbsite, 162  
 patterns of goethite, 162  
 patterns of illite, 161  
 patterns of kaolinite, 160  
 patterns of montmorillonite (smectite), 160  
 powder samples in, 159  
 pretreatments in, 161, 165  
 qualitative interpretation of, 157  
 semiquantitative interpretation of, 157  
 2 theta ( $\theta$ ) values in, 160  
 units for lattice spacing in, 159

## Z

Zero point of charge (ZPC), 150, 173, 174, 225  
   determination of, 173–174  
   effect of pH on, 173, 174  
 Zero point net charge (ZPNC), 173  
 Zero point proton charge (ZPPC), 173  
 Zeta potential, 180, 281  
   in clay–organic complexes, 281  
   effect of electrolytes on, 180  
 Zwitterion, 85, 86, 301–302



Praise for the third edition:

***“... bridges the gap between pure chemistry and soil science and presents soil as a basic entity in a wide range of disciplines.”***

*—Bulletin of the International Society of Soil Science*

***“Included in this text are many interesting historic details and other items of information usually overlooked in most recent highly focused textbooks...provides interesting and...useful background and supplementary reading for any course in soil chemistry...a valuable addition to all soils libraries, both public and private.”***

*—Soil Science*

**A Complete Reexamination of  
Soil Chemistry and Its Role in the Environment**

Learn the secrets of soil chemistry and its role in agriculture and the environment. Examine the fundamental laws of soil chemistry, how they affect dissolution, cation and anion exchange, and other reactions. Explore how water can form water bridges and hydrogen bonding, the most common forces in adsorption, chelation, and more. Discover how electrical charges develop in soils creating electrochemical potentials forcing ions to move into the plant body through barriers such as root membranes, nourishing crops and plants. You can do all this and more with the **Principles of Soil Chemistry, Fourth Edition**.

Since the first edition published in 1982, this resource has made a name for itself as a textbook for upper-level undergraduates and as a handy reference for professionals and scientists. This fourth edition reexamines the entire reach of soil chemistry while maintaining the clear, concise style that made the previous editions so user-friendly. By completely revising, updating, and incorporating a decade's worth of new information, author Kim Tan has enhanced this edition and created an entirely new book.



**CRC Press**

Taylor & Francis Group  
an informa business

[www.crcpress.com](http://www.crcpress.com)

6000 Broken Sound Parkway, NW  
Suite 300, Boca Raton, FL 33487  
270 Madison Avenue  
New York, NY 10016  
2 Park Square, Milton Park  
Abingdon, Oxon OX14 4RN, UK

K10718

ISBN: 978-1-4398-1392-8

90000



9 781439 813928