

How to Write for

# **PERCUSSION**

a comprehensive guide to percussion composition

**samuel z solomon**

Copyright ©2002 by Samuel Z Solomon  
Library of Congress Catalog Card No. 10-95545  
ISBN: 0-9744721-0-7

All rights reserved  
Printed in the USA

First Edition

Special thanks to the following:

musical example typesetter:  
Nico Muhly

composers of musical excerpts:  
Shawn Crouch  
Jefferson Friedman  
Matthew Fuerst  
Nico Muhly  
Ryan Streber

co-editors:  
Samuel Adler  
Daniel Bauch  
Jonathan Bisesi  
Shawn Crouch  
Daniel Druckman  
Jefferson Friedman  
Pia Gilbert  
Gordon Gottlieb  
Jeffrey Irving  
Steven Mackey  
Jeffrey Milarsky  
Nico Muhly  
Eric Poland  
Elisabeth Sanborn  
Nadia Sirota  
Ryan Streber  
Nancy Zeltsman

assistant photographer:  
Nadia Sirota

(instruments in photos provided by The Juilliard School)

# table of contents

**foreword by Samuel Adler**

**preface by Daniel Druckman**

**1 introduction**

**7 1 . general logistics**

Instrument choice

Over-scoring

**8** Large setups and rehearsal considerations

Visuals

Noise

**9** Budget

Space

Music that will be frequently performed

Exotic instruments

Electronic percussion

**10** Instruments percussionists do not play

Multiple percussionists

Logistics

**11** Section setup

Timpanists

Broadway pit

**12** Non-percussionists playing percussion

Chairs and stands

How fast percussionists can play

General conditions

**13** Specific tempi

**14** Unidiomatic writing - music that often requires memorization

Dynamics

**15** Physical exertion and shaking

Reaching instruments

Instruments with pedals

**16** Moving with hand-held instruments

Working with headphones

- 17 Melodic lines or counterpoint in a setup of different instruments
- Multiple instruments for a specified instrument
- 18 Pitch bending
- Vibrato
- 19 Sympathetic resonance
- 20 Adding mass to instruments

## 2. general notation

- 21 Instrument list
- 22 Instrument key
- 23 Setup diagram
- Abbreviation
- Language
- 24 Symbol notation
- Divided or undivided parts / Score part or separate parts
- Undivided score part
- 26 Divided score part
- 27 Separate parts
- Multiple copies of parts
- Handwritten versus computer-generated parts
- Cues
- 28 Notating percussion in a conductor's score
- Notating unpitched percussion
- Staves
- 30 Noteheads
- Adding pitched instrument staves to unpitched instrument systems
- 31 What goes where on the staff
- 32 The chicken or the egg?
- Clefs
- 33 Key signatures
- 34 Unspecified instruments (indeterminate instrumentation)
- How much to notate
- Systems of notation for which there is no standard
- Return to a "normal" method of playing
- Dynamics
- 35 Rolls
- Rolling on one surface
- 36 Rolling on two surfaces
- Rolling on four surfaces
- 37 One-handed rolls
- 39 Rolling on three surfaces
- Rolling from the resonance of a previous attack
- Bowed instruments
- 41 Articulation and phrasing
- Dead stroke
- Note lengths
- Exact or inexact note-length indications
- 43 Damper pedals
- 44 Muting (muffling, dampening)
- Sustaining instruments
- 45 Orchestrating to evoke the sounds of different cultures

47	<b>3. beaters</b>
	To indicate or not to indicate?
	Beater lingo
48	Logistical beater issues
	Problems with extreme register
49	Beater tricks
50	The shaft and butt of beaters
51	Sticks
52	Mallets
53	Triangle beaters, knitting needles
	Brushes
54	Chime hammers
	Rute
	Hands
	Sticks as instruments

55	<b>4. tone color</b>
	Factors that affect tone color
	Dynamics
	Beaters
56	Placement of attack
	Muting
57	Unpitched instruments (indeterminately pitched instruments)
58	Timbral specifics of cymbals and tam-tams
	Miscellaneous timbral effects

59	<b>5. drums</b>
	Sticks on drums
61	Mallets on drums
	Hands on drums
62	Playing on the rim or shell
	Placement on the head
63	Mutes
	Drum size
	Two-headed drums
	Pitch bending
64	Multiple drums in setups
	Idiomatic writing for drums
65	Types of drums
	Timpani
66	Ranges
67	Changing pitch
	Multiple timpanists
68	Obsolete notation
	Timpani extended technique
	Harmonics
	Sympathetic resonance
	Striking the bowl
	Prepared timpani
69	Timpani as unpitched instruments

69	Tom-toms, snare drum, field drum, tenor drum, timbales, roto-toms, bongos, congas, tamborim
	Snare drum
70	Tenor drum and timbales
	Roto-toms
71	Bongos and congas
	Other drums
72	Frame drum, djembe, dumbek
	Bass drums
73	Drumset

## 75 **6. keyboard percussion**

	Ranges
	Marimba
76	Vibraphone
	Xylophone
77	Glockenspiel
	Crotales
	Chimes
78	Resonators
	Pedals
	Vibraphone motor
79	Removing notes from the set
	Idiomatic writing for mallet instruments
	Thumbs and pinkies
82	Idiomatic writing for chimes
83	Stacked instruments
84	Rolls
	Balance problems
	Overtone interference
85	Figurative writing for glockenspiel and crotales
	Glockenspiel as an extension of the vibraphone
	Multiple players
	Special effects
	Striking the edge of the bar
86	Glissandi
	Node
87	Harmonics
	Mouth vibrato
88	Glockenspiel vibrato
	Pitch bend
	Clusters
	Prepared instruments
	Marimshot
89	Church bell effect
	Miscellaneous

- 91 **7. metal**  
Cymbals  
Multiple cymbals  
Suspended cymbals  
92 Special suspended cymbals  
93 Hi-hat  
94 Crash cymbals  
Ring  
Pick up/put down time  
Speed  
Crash articulations  
Rolls  
95 Mounting crash cymbals on a hi-hat stand  
Bass drum/cymbal attachment
- Gongs  
96 Tam-tam  
Nipple gong  
Wind gong  
Chinese opera gong  
Other gongs  
Gong stands and racks
- 97 Triangle  
Cowbells, agogo bells, almglocken  
98 Japanese temple bowls, mixing bowls  
99 Brake drums, anvils, metal pipes  
Thundersheet  
Steel drums (steel pans)  
100 Special effects  
Scrape  
Water  
Prepared instruments

- 101 **8. wood**  
Woodblocks, templeblocks, log drum  
102 Claves  
Wood drums  
Cajón

- 103 **9. miscellaneous instruments**  
104 Bottles  
Cabasa  
Castanets  
Church bells (ship bells, Berlioz bells)  
Coconuts  
Conch shell  
105 Crystal glasses  
Finger cymbals  
Flexatone  
Friction Roll (finger rub and Superball mallets)

106	Guiro (gourd), washboard Hammer as used in Mahler Symphony No. 6 Hand bells Lion's roar
107	Maracas, shakers
108	Mark tree, wind chimes, bell tree
109	Pop gun Quica (cuica) Rainstick
110	Ratchet Rice bowls Rute Sandpaper blocks Sirens
111	Slapstick, whip Sleighbells Stones, prayer stones Tambourine
112	Thumb piano (African thumb piano, kalimba, mbira)
113	Vibraslap Whistles Wind machine

## Appendices:

### 115 **A. sample setups**

### 135 **B. scores with comments**

	Shawn Crouch, <i>Suspended Contact</i>
142	Jefferson Friedman, <i>Sacred Heart: Explosion</i>
147	Ryan Streber, <i>Rondel</i>
150	Nico Muhly, <i>Sustained Music</i>

### 153 **C. beaters**

### 157 **D. dynamics**

### 161 **E. suggested works**

### 171 **sources**

### 173 **index**



# foreword

Most composers of the twentieth and twenty-first centuries have fully integrated the percussion section into their orchestral thinking and are using a great variety of percussion instruments with ever increasing frequency. Samuel Solomon's book *How to Write for PERCUSSION* therefore comes as a welcome gift to composers who are deeply involved with this often mysterious section of the orchestra. Much of the mystery and a great deal of intimate knowledge of percussion instruments as well as techniques of performance, types of beaters used, special setups of the section, and many other pertinent topics are discussed and clarified. This is not an orchestration text in the traditional sense, but rather a guide book for all those composers and arrangers involved in the process of writing for percussion. It is my feeling that conductors would also greatly profit by using this brief work, for it is written by a professional percussionist who has performed many of the works discussed in the book and studied carefully all the other excerpts. Here is a volume which is truly practical, for Sam Solomon is a very fine performer and writes from a practitioners point of view, giving advice which is invaluable to all of us. Many of the urgent and sometime puzzling questions of notation, color, availability of instruments, as well as problems often faced by percussionists such as fatigue factors in performance or the choreography situations of the section are frankly exposed and discussed in detail. A list of works and frequent citations in the text itself clarify and support the major topics. This is a "musician's book" and a true contribution to the literature of orchestration.

Samuel Adler  
Professor Emeritus, Eastman School of Music  
Composition Faculty, Juilliard School  
Author, *The Study of Orchestration*

# preface

Nothing about Sam Solomon is ordinary. I remember vividly my first encounter with a precocious, extremely talented 18 year-old, brimming with self confidence and exuding a musical maturity way beyond his years. The next four years were revelatory, as he soaked up information like a sponge and showed an ability to learn and understand music at a rate I've seldom seen before or since. Since then I've followed his blossoming career with pride and admiration. When he told me he was contemplating writing this book, my reaction was twofold: first, that it was presumptuous for anyone in their mid-twenties to attempt an authoritative text like this, and second, that if anyone could do it, it would be Sam.

And... the book does not disappoint. Composers who take the time to study this book will find a wealth of information and insight. A broad range of topics are covered, from basic timbral considerations like stick and instrument choices through subtle problem areas of logistics and notation. Perhaps most informative are the comprehensively annotated score excerpts and the extensive listening and study list. If I could stress one point above all others to composers, it would be the vital importance of studying expert percussion writing of past masters such as those listed here. No amount of sound modules, samplers, or midi "scratch-pads" can substitute for this kind of knowledge.

For those of you who might find this amount of detail a little bit daunting, remember, this is what we do. Percussion is all about minutiae - choosing just the right cymbal for the climax of a piece, finding a snare drum that will blend effortlessly with the brass, choosing a mallet that will articulate well but still sound full, finding the spot on the crotale that bows the easiest, etc. For percussionists, God truly is in the details, and this book will certainly get you a lot closer to that ideal. Enjoy!

Daniel Druckman  
Associate Principal Percussion, New York Philharmonic  
Chairman, Percussion Department, Juilliard School

# introduction

Every culture in the world has traditions, both musical and non-musical, that include percussion. Many of these unique applications have been gradually incorporated into “Western” percussion playing through the works of composers over the past three hundred years. Even today the percussion family continues to grow as information is shared, composers experiment, and older techniques are refined. The result is an enormous collection of unique musical and cultural developments, the size of which makes percussion especially difficult to control in composition.

This book presents those developments which have thus far become standard practice in Western composition and explains how these practices are realized in performance. A composer with an understanding of the ways percussionists operate, respond to notation, and make choices will be able to design compositions that best represent his or her musical intentions. *How to Write for PERCUSSION* explores, from a percussionist’s perspective, this path from composer’s intent to performer’s realization and will provide the reader with the tools necessary to comfortably create innovative and skilled percussion composition.

## **How this book is organized**

Most other orchestration books present percussion by first describing each instrument separately and then discussing the specifics of setup, mallets, notation, and special effects. Although percussion is a collection of many very different instruments, the techniques used often apply to not one but many instruments if not to all percussion. For this reason, *How to Write for PERCUSSION* approaches each instrument through its similarities to other instruments thus making the process of understanding and retaining this enormous amount of information as easy as possible.

There are nine chapters. The first four consider issues that apply to all percussion.

1. **General Logistics** explores the behind-the-scenes issues of movement, instrument choice, instrument setup, concert production, and sound production. These are the often overlooked concerns which significantly influence the success of a composition.
2. **General Notation** details the key notational concepts for percussion writing, including guidelines for how to create parts and scores, how to set up notational systems for multi-percussion setups, and how to deal with articulation, phrasing, note length, and special effects.

3. **Beaters** describes each beater, its specific uses, special effects, and issues of changing beaters within a piece.
4. **Tone Color** explains the physical factors that can be used to manipulate timbre on percussion instruments.

The following five chapters discuss specific types of instruments.<sup>1</sup>

5. **Drums**
6. **Keyboard Percussion**
7. **Metal**
8. **Wood**
9. **Miscellaneous Instruments**

**Drums**, **Keyboard Percussion**, **Metal**, and **Wood** discuss instruments that are struck. **Miscellaneous Instruments** discusses instruments that are scraped, shaken, cranked, and blown through, as well as some struck instruments that do not fit into the other categories. Non-keyboard instruments of definite pitch and those of indefinite pitch are not separated from each other because the techniques used are not necessarily different (e.g., timpani and tom-toms).

The five appendices expand and reinforce the concepts detailed in the rest of the book.

- A. **Sample Setups** is a collection of instrument lists with their corresponding setup diagrams and instrument keys.
- B. **Scores with Comments** presents excerpts from real scores with comments that elaborate on important logistical and notational issues.
- C. **Beaters** charts the appropriateness of various beaters on various instruments.
- D. **Dynamics** charts the relative dynamics of various instruments struck with various beaters.
- E. **Suggested Works** is an annotated list of compositions that use percussion well.

There is far more information presented in this text than the composer needs to write the average percussion part. The majority of the information relates to the construction of complex percussion parts which involve many instruments, many players, multiple setups, and unusual playing techniques. Beyond that, much of the text is included to introduce the composer to vocabulary percussionists use and to give insight into the ways percussionists think about and interpret music, notation, and logistics.

1. Other books choose to classify instruments with respect to the way they produce sounds: idiophones (instruments which produce sound through vibration of their entire body, like cymbals, wood blocks, and marimba bars), membranophones (instruments which produce sound through vibration of a stretched membrane, like tom-toms and timpani), and aerophones (instruments which produce sounds with a stream of blowing air, like whistles). Because this method of categorization is not used in musical contexts - in scores or in conversation - this book prefers to classify instruments with the terms listed above.

## **Working with percussionists**

It cannot be stressed enough that composers should work with percussionists as much as possible. Although this book is very informative, it cannot compare with the experience of seeing the setups, watching how performers move within them, and hearing how the instruments sound alone and in the context of an ensemble. *Only with a clear understanding of the sounds of these instruments will the composer use them successfully in composition.* The study of recordings and scores (see Appendix E) and collaboration with percussionists will be invaluable. In addition, an electronic companion to *How to Write for PERCUSSION* with audio and video clips is forthcoming.

## **What this book does not include**

### **General music issues**

This text avoids describing musical issues which are not percussion-specific. It is assumed the reader already has a strong understanding of composition for other instruments.

### **Sound descriptions**

Few descriptions of an instrument's sound are included. A description in writing could not do a sound justice and would more than likely mislead the reader. It is best to listen to these instruments in person or on recordings.

### **Percussion in context**

This book is written from a percussionist's perspective. The author is not a composer; therefore, little instruction regarding the compositional use of percussion in the context of an ensemble is included. The reader will find an extensive list of sources of such instruction in Appendix E.

### **History**

For the sake of clarity, the history or the origin of instruments or techniques is rarely included, and only the most up-to-date pertinent information is presented. Historical information that is provided is for the purpose of helping the reader understand older scores.

### **Dictionary**

A percussion dictionary, with names of instruments and playing techniques in other languages, is not included but can be found in other books and on the Internet.

### **Ethnic playing styles**

The music of every culture in the world includes percussion instruments with native playing techniques. These techniques generally belong to improvised playing styles which developed as a direct result of their respective musical styles. This book assumes the composer is not writing in a traditional ethnic style, and descriptions of these techniques are only occasionally included. For detailed information on traditional music and playing styles of a particular instrument, the composer should consult a percussionist with expertise in that style.

### **Drum corps**

Drum corps and marching band writing and arranging is not specifically covered. Composers and arrangers working in that idiom often already have a wide knowledge of what is available and how it can be used. This book will, however, still be of use, especially for pit writing where the orchestral/chamber music world and the drum corps world overlap the most.

**Location specifics**

This book is written with respect to the conditions in New York City, but almost all of it will be useful regardless of locale. Discrepancies with respect to location are most likely to be found in the availability of certain instruments, instrument ranges, familiar playing techniques, and union rules. Again, it is always best to consult the percussionist or group for whom the composition is written.

**Works cited**

The musical works referenced in this book are important pieces by important composers, scores and recordings of which should be widely available. Specific examples of scores printed in this book are composed by friends of the author.

**Instruments covered**

The list of instruments discussed in this book intends to represent all of the most common and most readily available instruments in Western composition. Instruments in parentheses are alternate names for the preceding instrument.

**Drums**

timpani, tom-toms, snare drum, field drum, tenor drum, timbales, roto-toms, bongos, congas, tamborim, frame drum, djembe, dumbek, bass drum, drumset

**Keyboard Percussion**

marimba, vibraphone (vibes), xylophone, glockenspiel (bells, orchestra bells), crotales (antique cymbals), chimes (tubular bells)

**Metal**

suspended cymbals, crash cymbals, gongs, triangle, cowbells, agogo bells, almglocken, Japanese temple bowls (prayer bowls, temple bells, bowl gongs), mixing bowls, brake drums, anvil, metal pipes, thundersheet, steel drums (steel pans)

**Wood**

wood blocks, temple blocks (Chinese blocks), log drums (slit drums), claves, wood drums, cajón

**Miscellaneous Instruments**

bottles, cabasa, castanets, church bells, coconuts, conch shell, crystal glasses, finger cymbal, flexatone, friction roll, guiro, washboard, hammer as used in Mahler Symphony No. 6, hand bells, lion's roar, maracas, shakers, mark tree, wind chimes, bell tree, pop gun, quica, rainstick, ratchet, rice bowls, rute, sandpaper blocks, sirens, slapstick, whip, sleighbells, stones, prayer stones, tambourine, thumb piano (mbira, kalimba), vibraslap, whistles, wind machine

This list does not include many exotic and rare instruments. A list of all percussion instruments could fill hundreds of pages, but only a small percentage would be practical for a composer to request. The above list is most representative of what is available and what percussionists know how to use. This focus allows the text to go into detail on unusual techniques and sounds that can be produced from each instrument.

### The value of not reading this book

Some performers may argue that ignorance can encourage originality. Great notational, sonic, and logistic innovations have resulted from composers writing without any understanding of the reality of performance. That is, however, a rare case, and the author believes that great innovations are most often launched from a foundation of knowledge than from ignorance.

### Terms

The following are terms used throughout the text that are not specifically defined elsewhere.

**hardware** - the stands by which instruments are suspended or mounted.

**wrap** - a group of instruments set up together to often be played by one person.

**sticking** - the equivalent of *fingering* in piano music. It may consist of R's and L's (for right and left) or 1's, 2's, 3's, and 4's (with four mallets).

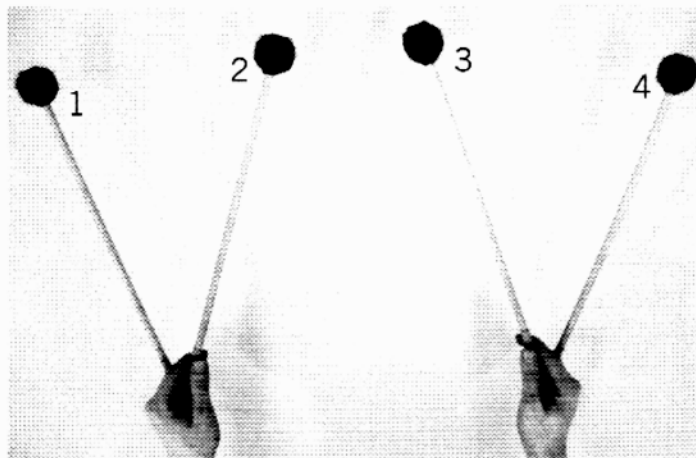

[Figure i.1]

**trap table, trap tray, stick tray** - a padded table on which percussionists place beaters and small instruments. This may be a specially designed table or simply a music stand that is laid flat and covered by a towel.

# general logistics

The logistical complexities that are inherent to percussion playing can often get in the way of the composer's musical intentions. This chapter will discuss some of the general issues that percussionists and composers face with respect to physical movement, instrument choice, instrument setup, concert production, and sound production. These are mostly non-musical issues which the composer may not normally be considering while writing a piece, but which have a significant effect on the final musical product.

## **Instrument choice**

### **Over-scoring**

A large number of instruments will often create complex logistics (large setups and fast beater changes) that can make the music very difficult to execute. Percussion over-scoring can also make a piece seem cluttered and awkward; overused percussion sounds will stick out far more than overused string or wind sounds. Of course, using many instruments can be done skillfully and effectively, but a smaller instrumentation leaves fewer opportunities for problems.

When choosing instruments, when is enough, enough? With an enormous instrument list, some of the less important instruments can often be eliminated or easily and effectively substituted with something already on stage. Questions to ask oneself when adding instruments to an already large list are:

- Is this new sound significantly different in effect than something already being used?
- Will it be heard?
- Does the player have time to get to the instrument, pick up the instrument, or get the appropriate mallets? Can the instrument be positioned closely enough so the performer can get to it?
- If the instrument has been used before, is it being used by the same person? If it is a different person, does that person have time to get to the instrument that has already been used, or does there need to be two of the same instrument on stage? If two are needed, is there room to have multiples of this instrument, and is the second person's part substantial enough to justify having two of these instruments?



Specific examples:

- Could the passage for two tenor drums be played on the already existing two tom-toms, or vice versa?
- Is it necessary to use two different kinds of guiros in two separate, heavily orchestrated sections?
- Player 2 has one one-measure crotale passage in his or her part during a heavily orchestrated part of the piece. There are already a lot of glockenspiel passages in player 2's part, and there are a lot of crotale passages in player 3's part. Can player 3 play the one measure crotale passage? If not, does player 2 have time to go over to player 3's crotales? If not, is it worth having two sets of crotales, or can player 2 just play the passage on glockenspiel?

Of course, these types of decisions should not outweigh musical considerations.

### **Large setups and rehearsal considerations**

Types of questions like those above are especially valuable for music that will have little rehearsal time, namely, conducted large ensemble works. In this setting there will often be far less preparation, so the less troublesome the logistics, the better the performance will tend to be. For example, if there are only two rehearsals for a piece in a conservatory orchestra concert of student compositions and the setups and mallet switches are very challenging, the chances that the performers will make some compromises are high.

Also in a "large ensemble/little rehearsal time" situation, the bigger and more difficult the setup, the less it will tend to be practiced. To do so, the percussionist must collect all the instruments and set them up. That alone may take up to an hour and will leave less time for practice. If the instruments in the setup are used individually (for example, if a piece has a setup with marimba, vibraphone, glockenspiel, crotales, five toms, bass drum, suspended cymbal, tam-tam, and maracas but all the difficult parts are on the marimba alone), then the performer can practice just those parts without the entire setup. If the difficult passages use all the instruments in the setup together, they must all be set up to be practiced.

For small uncondacted ensemble and solo works, the composer can feel much less restricted. In these cases, the percussionist has probably had a role in choosing the piece for performance and is interested in spending some time on it. "Spending some time" means practice time, rehearsal time, setup time, and time figuring out instruments, mallets, and other logistics.

### **Visuals**

Percussion is an especially visual instrument, and visual musical gestures are very effective. If a piece requires visuals that are drastically different from the intended character of the piece because of numerous instruments or frequent beater changes, then the piece can seem scrambled and disjointed. This is especially true of solo percussion music where the audience is sure to be looking directly at the percussionist. Excitement may be added if the performer must drop and pick up mallets quickly or run across the stage to get to an instrument, but this may not be the correct character; if the mood is slow and tranquil, fast motions will be a distraction.

### **Noise**

Quick beater or instrument switches may also create unwanted noise. If a percussionist has to drop and pick up mallets very quickly, a little noise may result. Instruments that produce sound by shaking - tambourines, sleighbells, maracas, and shakers - will likely create unwanted noise during a hurried pick-up or put-down. The sound of footsteps can also be a distraction if the player needs to walk quickly or run to another part of the stage. In all cases, noise will not be made if proper time is allotted.

### **Budget**

An instrument that is not readily available has to be either purchased or rented. This may be a financial challenge to some performing ensembles and could mean the difference between a group choosing to perform a piece or not. Generally, this and many of the below issues will only be a problem for traveling solo performers and small chamber groups. More established ensembles (such as large orchestras) will usually have the resources to accommodate the composer's demands.

### **Space**

A large number of percussion instruments requires a large amount of space. This is commonly a problem in small chamber music halls, on stages with different level risers, in opera or Broadway pits, or in rehearsal spaces.

### **Music that will be frequently performed**

With solo and chamber music - due to problems of instrument transportation, instrument rental, and stage space - the smaller and more convenient the setup, the more likely it will be performed. In a conservatory or with established organizations where many instruments are available, almost anything is possible; elsewhere, problems may arise. Percussionists will often look for pieces for which there are many possible performance opportunities. If there are a large number of instruments, a large stage is needed; if the performer does not own an instrument, it must be bought, borrowed, or rented; if instruments cannot be preset, extra time must be taken during a concert for set up. This is where a touring group or performer may get discouraged. For example, Per Nørgård's *I Ching* for a roomful of instruments is rarely performed outside of a conservatory, but Frederick Rzewski's *To the Earth* for four flower pots and spoken voice can be taken and performed anywhere.

Marimba is one instrument for which there are far more performance opportunities than there are for other percussion. Many percussionists consider themselves "marimbists" and play that instrument exclusively. As a result, there is a much larger market for solo and chamber music with marimba than there is for solo and chamber music with other percussion.

### **Exotic instruments**

If an especially rare instrument is requested, it is possible that one will not be acquired in time for the concert. In this case, the composer should plan to provide the instrument or let the performers use a substitute instrument. A description of the sound of the instrument (written in the score) will help the performer find an appropriate substitute (e.g., "The Southwest Siberian Xiboxia has a high, bright, and metallic sound with a metallic buzz and a short decay"). Or the composer could suggest a specific substitute for the instrument (e.g., "If a B<sub>♭</sub> hubcap is not available, use a B<sub>♭</sub> nipple gong").

### **Electronic percussion**

Synthesized percussion can be used alone or alongside acoustic percussion (see John Adams's *Death of Klinghoffer*). A percussionist can have an electronic MIDI controller, such as an Octapad, DrumKat, or MalletKat, within a setup of acoustic instruments. Regular keyboard synthesizers can also be used to synthesize percussion and are oftentimes more practical than the percussion MIDI controllers listed above, as they are more widely available.

With MIDI controllers, sound will be consistent regardless of what beater strikes the pad so mallet changes are unnecessary. Also, these controllers take up very little space in a setup; an acoustic sound that could require a very large instrument or group of very large instruments can be replaced by a compact drum pad. The sounds produced can be changed during a piece, so one small MIDI drum pad or keyboard can produce hundreds of different sounds that would normally require a stage full of instruments and a stage full of percussionists. For this reason, MIDI controllers are popular in Broadway pits where space is often more scarce than money.

The disadvantages, however, are many. Synthesized percussion sounds are rarely an accurate representation of the acoustic sound and are usually best used for and limited to invented or altered sounds. The equipment needed is often expensive and not always available. Set up is time consuming, and computer crashes, unplugged cables, and feedback are just a few of the many things that can go wrong. If electronics are involved, generous dress rehearsal time should be allotted to get everything set up and working correctly.

### **Instruments percussionists do not play**

There are an enormous number of instruments in the percussion family, many of which most percussionists do not study. Percussionists are frequently required to learn new instruments and can easily do so by applying techniques from commonly studied instruments. In some cases, however, it is not so easy.

- Cimbalom and hammered dulcimer are not instruments that most percussionists study. A composer should only write for cimbalom or hammered dulcimer if it is known that there is someone who plays and has access to these instruments.

- Musical saw is an instrument percussionists rarely play. Simple melodies can be executed with practice, but especially complicated parts should be reserved for musical saw specialists.

- Non-percussion keyboard instruments (piano, harpsichord, and celeste) are generally left to the professional keyboard players. There are many non-keyboardist musicians who are proficient in piano and can play these instruments well, but this should not be assumed. All percussionists will, however, have basic knowledge of the keyboard and can play a few chords or simple lines if necessary (see Luciano Berio's *Circles*, Jacob Druckman's *Animus II*, Henry Cowell's *Set of Five*).

- Steel pans are frequently found in a percussion collection, although few percussionists are proficient with this instrument. The pitches are not arranged like a keyboard, and the layout is very unfamiliar. Fast notey passages will be difficult and will need to be memorized; slow lines, ostinati, and isolated notes can easily be executed. See **Metal** for more information.

### **Multiple percussionists**

#### **Logistics**

The best way to avoid problems with multi-player logistics is to assign instruments to each individual player before the parts are written. For example, before starting a piece, the composer decides that there are four percussionists:

player 1: timpani

player 2: marimba, five toms, bass drum, and two suspended cymbals

player 3: vibraphone, five temple blocks, tambourine, guiro, and tam-tam

player 4: glockenspiel, crotales, xylophone, triangle, and vibraslap

If those setups are maintained while writing, numerous problems are automatically avoided. Conceptualizing the previous arrangement is far easier than trying to organize this:

four players:  
timpani  
marimba  
vibraphone  
xylophone  
glockenspiel  
crotales  
two suspended cymbals  
tam-tam  
five toms  
bass drum  
five temple blocks  
tambourine  
guiro  
triangle  
vibraslap

With the latter plan, it is very easy to lose track of who is playing which instrument, what mallets they are holding, where they are on the stage, where the instrument is on stage, and so on.

### **Section setup**

Unless stage positions are used for spatial effects, the placement of each individual player does not need to be specified. The section setup is often out of the composer's hands for logistical or acoustic reasons specific to the piece or hall or as a result of the preference of the players, conductor, or organization.

### **Timpanists**

Professional orchestras usually have a timpanist plus three or four percussionists. The timpanist is hired to play timpani. If the timpanist has to play any instrument other than timpani, he or she is paid a doubling fee. For an orchestra piece, it is best to not give the timpanist anything else to do even if there is plenty of extra time in the timpani part. Commissions from professional orchestras will often require this.

Depending on the specific contract and union rules for the timpanist, writing for prepared timpani or for striking the timpani bowls (see **Timpani in Drums**) may not qualify as additional percussion and thus may be permissible. In this case, it is best to research the orchestra and union's rules.

### **Broadway pit**

The percussion section in a score for a musical theater show often consists of a drumset player and a percussionist. The percussion part can include many instruments: vibraphone, marimba, glockenspiel, chimes, bongos, congas, many little instruments (a.k.a. "toys" - wind chimes, shakers, triangles, wood blocks, cowbells, etc.), and timpani (often no more than two or three due to space constraints). Just as orchestral timpanists are paid doubling fees for playing instruments other than timpani, a Broadway percussionist will be paid separate fees for keyboard instruments, timpani, drums, Latin percussion, ethnic percussion, electronics, etc. (contact the local union for details).

### **Non-percussionists playing percussion**

Some simple percussion playing is often asked of non-percussionists, such as a triangle or wood block part. Even though the percussionists are not playing these instruments, they will be expected to supply them. The instrument and person for whom it is to be supplied should be indicated in the instrument list in the percussionist's part.

Although creating a sound with percussion instruments is child's play, playing them in time (and musically) is not that easy. Some non-percussionists, most notably wind players and vocalists, are not used to producing sound with a large physical motion. String players, conductors, and keyboard players (especially pianists) will have a much easier time playing percussion instruments well than wind players or vocalists because they are used to moving their arms in time in relation to an object (i.e., a string or piano key).

### **Chairs and stands**

Often composers organize their own rehearsals and are in charge of setting up the number of chairs and stands. Percussionists usually need far more than one stand - sometimes up to nine or ten. They may even need a few chairs for mounting a bass drum or placing crash cymbals. The composer should consult the percussionist involved to determine his or her exact needs.

### **How fast percussionists can play**

#### **General conditions**

The conditions that affect the playing speed are:

- The number of surfaces and distances between them. Playing on just one surface (such as one drum) will be easiest and fastest. If the writing requires maneuvering around a setup or large instrument (like marimba or timpani), speed is sacrificed. The further apart the instruments or notes, the more time it will take to get there.

- The weight of the beater - the heavier, the slower. For example, percussionists can play faster while holding two mallets than while holding four and faster with drum sticks than with large bass drum beaters.

- Dynamics. At extreme dynamics, percussionists have to exert energy toward maintaining the dynamic that could otherwise be channeled into speed. This is especially true of soft dynamics where the amount of restraint necessary to play softly may be significant. The amount of energy required is dependent on how a particular instrument played with a particular beater speaks with respect to dynamics (see **Appendix D**). For example, a percussionist can play very quickly at soft dynamics when playing with hands or soft mallets around a set of five drums; to produce an equivalent speed and dynamic with drum sticks would be extremely difficult.

- Endurance. A percussionist can maintain a higher speed if the passage does not continue for too long. Even a few very short rests placed periodically throughout a passage can make it easier; rests give the player's muscles a short opportunity to regain oxygen and discard built up waste (lactic acid and carbon dioxide). Endurance will often come into play for very short bursts of very fast notes. For example, a quick series of up to five strokes can easily be squeezed out by one hand with the help of gravity and bounce. Quick figures that diminuendo are more easily executed than those that crescendo or stay constant (see **Figure 1.1**).



[Figure 1.1]

In Figure 1.1, it would be far more difficult to play straight sixteenth notes in one hand at that speed for the same period of time.

- Double strokes. Under certain conditions percussionists can use a *double stroke* or *bounce stroke* where the beater makes two articulations each time it strikes the instrument. This is most common with drum sticks but can also work with hard plastic, hard rubber, or wood mallets. With softer sticks, the cushioning of the felt or yarn will reduce the bounciness of the beater and make it more difficult to perform a double stroke. Bounces can be more easily and quickly executed on tight drums (bongos, snare drum, high toms) than other less-bouncy surfaces. Double strokes will be used for especially fast passages when both hands are on the same surface. The composer does *not* need to indicate the use of double strokes.

- Physical balance. It is easier to play fast alternating (hand-to-hand) strokes than fast strokes with both hands simultaneously. The hand-to-hand motion creates a balance while two hands together requires the performer's body to compensate. As an example, the reader may try this exercise: move your arms in the air as if drumming on an imaginary conga (right, left, right, left, etc.) as fast as you can. Now move both arms together as fast as you can so that both hands strike the imaginary conga simultaneously. Switch back and forth between the two motions and notice the difference in the way your head moves. As you can see, two hands at once requires much more energy.

### Specific tempi<sup>1</sup>

When playing hand-to-hand for an extended period of time, an average percussionist can play sixteenth notes at ♩=160. That means one hand can move at half that speed.

When holding four mallets, speed is slowed to sixteenth notes at ♩=120 since two mallets in a hand are more mass to move. This tempo applies to hand-to-hand motion as well as mallet-to-mallet motion with each individual hand.



[Figure 1.2]

1. The tempi given throughout this section are comfortable and are for passages in which each hand or mallet stays on one surface. Faster playing is possible but should be used with caution and with consideration of the issues above. "Hand-to-hand" playing means the hands simply alternate (right, left, right, left...) instead of using double strokes or more complicated four mallet stickings.



In a large ensemble such as an orchestra, especially soft sounds will not project enough to be heard. Some special effects described in this book are very subtle and soft and should therefore be reserved for chamber and solo contexts.

When holding four mallets, control of dynamics is limited between the two mallets of one hand when simultaneously striking a surface. For example, if two mallets of one hand strike two notes of a marimba together, they will tend to sound the same dynamic. Slight dynamic differences are possible but difficult, and attempts to achieve extreme dynamic differences may result in the mallets not striking together. In this case, the best way to achieve two different dynamics is by striking with two separate hands or by holding two different mallets.

### **Physical exertion and shaking**

Percussionists are commonly required to use a lot of physical force to execute a passage. Crash cymbals, loud rolls, and quick passages can tax the player's muscles and increase his or her heart rate. This will make the player's hands shake slightly, and for up to a minute afterward the execution of soft delicate passages will be difficult.

### **Reaching instruments**

Instruments far away from each other in a setup may not be able to be played at the same time. This can be a problem especially with two mallets in one hand; the performer may be able to reach two instruments with two separate hands but not with the two mallets of one hand (the mallet span is, of course, much smaller than the arm span). This commonly becomes a problem with stacked mallet instruments (see **Stacked Instruments in Keyboard Percussion**).

### **Instruments with pedals**

Vibraphone, chimes, hi-hat, and pedal bass drum all have pedals that require the performer's attention. With especially large setups, it may be impossible for the performer to reach a pedal while playing another area of a setup; sustain on a vibraphone may need to be cut short or a bass drum articulation may need to be substituted if the percussionist is positioned too far from the pedal.

Simultaneously operating multiple pedals is possible, but the percussionist may need to sit down to do so. Keyboard instruments often require that the player stand, so complicated passagework on multiple pedals in setups that include keyboard instruments should be avoided. Playing multiple pedals with just one foot can also be very awkward and difficult. If a foot pushes a pedal and then moves to another pedal, the first pedal may swing back and forth and create unwanted noise. In some cases, the foot may need to rest on the pedal for a moment after it is depressed to ensure the proper sound (such as the short clash of the cymbals of a hi-hat).

Occasionally, composers request the pedal operation of instruments that are normally struck with a stick or mallet. This can be advantageous, as it can free up the hands to play other things, but it can create setup challenges. Mounting an instrument in the proper position to be played by a pedal often requires the performer build or buy a special device. Devices exist for mounting cowbells and plastic woodblocks for pedal operation which makes those the most probable candidates for additional pedal instruments. This, however, is still far more difficult than playing these instruments with a hand-held beater.

A discussion of idiomatic pedal writing can be found in the **Idiomatic Writing for Drums** section of the **Drums** chapter.



### Moving with hand-held instruments

Hand-held instruments can be played while moving to a new position in a setup, after which the hand-held instrument will be available with the other part of the setup and not with the previous part. For example, in this setup,

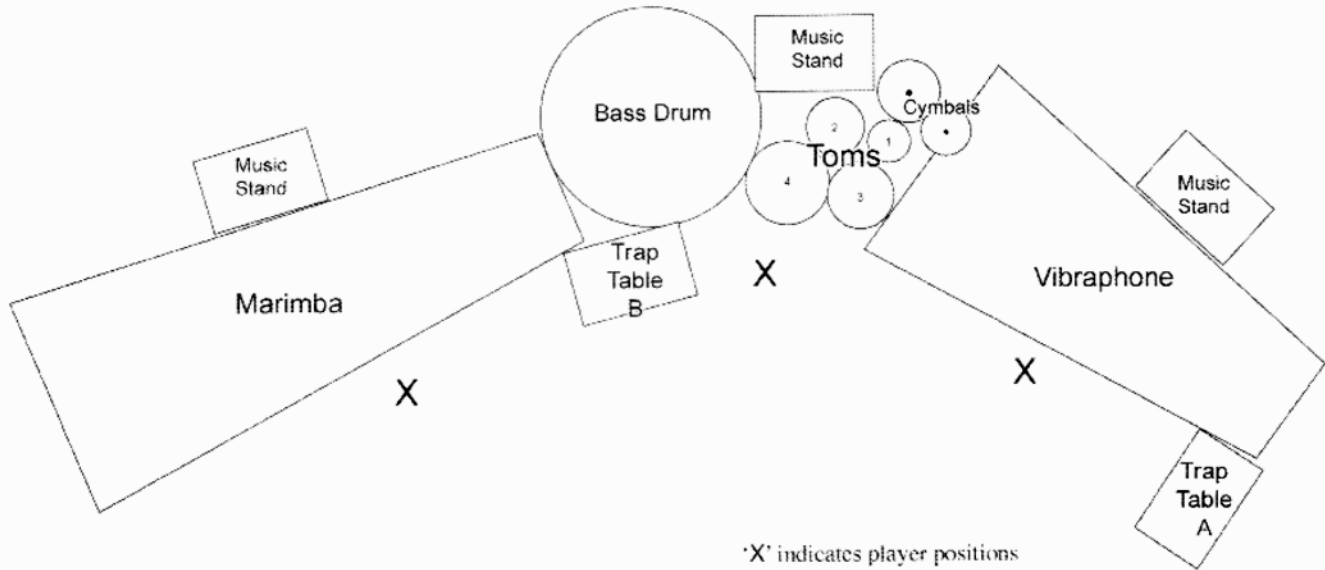

[Figure 1.4]

a percussionist is asked to play vibraphone, switch quickly to tambourine, and then switch quickly to marimba. After playing vibraphone, the player would pick up the tambourine from "Trap Table A," walk over to the marimba while playing tambourine, then put the tambourine down on "Trap Table B" and start playing marimba. Now the tambourine is stationed at "Trap Table B," and the player will not be able to quickly switch to it from the vibraphone but will be able to do so from the marimba or drums. The composer does not need to indicate this choreography.

### Working with headphones

A percussionist may have to wear headphones in pieces involving electronics. If the player has to move around a large setup, he or she can easily get tangled in the cord. The cord can also get caught on instruments, disturbing them or pulling the headphones from the performer's head. In these situations, it is best to keep motion to a minimum if possible. Wireless headsets may be needed if a lot of moving around is involved.

A piece that will require headphones should be practiced with the headphones before the performance; this can bring to light any problems that can be fixed before the dress rehearsal. Headphone logistics are, of course, the performer's issue, but the composer is often involved with getting the equipment for such pieces and should be aware that these problems may arise.

### Melodic lines or counterpoint in a setup of different instruments

If a composer writes a melodic line that moves around a setup of instruments of very different timbres, the ear may hear more than one line. Just as one might hear counterpoint between high and low registers of the piano, two or three melodies might be heard between unpitched instruments with different timbres. For example, if there are two snare drums, two cowbells, and two nipple gongs, one might hear the drums as one voice, the cowbells as another, and the gongs as a third instead of hearing one continuous line around the six instruments. This:



[Figure 1.5]

might sound more like this:



[Figure 1.6]

On the other hand, sometimes a melodic line can come across if it is realized over a wide variety of instruments. In this case, the counterpoint would be too complex and thus a single line is perceived. For example, if all sixteen articulations of Figure 1.5 were played on sixteen different instruments, the resulting sounds would be too varied for a non-linear organization to be apparent. This is an extreme example, but realistically, one melodic line is likely to be perceived when lines are moving over seven or more differently sounding instruments.

### Multiple instruments for a specified instrument

Just as different mallets are used to get different colors on the same instrument, percussionists will often use more than one of the same instrument for different dynamics, pitches, or orchestrations. For example, for a suspended cymbal part, a percussionist may use two or three cymbals: a medium-sized, thin, dark sounding cymbal for soft notes, a smaller, thicker, bright sounding instrument for short loud choked notes, and a very large cymbal for loud sweeping rolls. Multiple snare drums are also sometimes used for involved parts: a bright, loud, dry metal shell drum for loud articulate passages with the brass, a smaller drum with wire snares for soft rolls, and a wood shell drum for mellower articulate work with the strings.

Other times a percussionist will be forced to use multiple instruments because one instrument is incapable of meeting all of the requirements for the part. If loud and soft passages are written for a ratchet, then two different ratchets might be used. If both very loud passages and very articulate *pianissimo* passages are written for shaker, then two shakers might be used.

The use of extra instruments will usually be determined by the performer, but indications in the part by the composer (after the part has been worked out by a performer) may be appropriate.

### **Pitch bending**

Timpani, roto-toms, flexatones, and slide whistles have mechanisms which can bend the pitch.

Unpitched instruments like cymbals, tam-tams, guiros, lion's roars, quicas, friction rolls, sirens, and wind machines will produce a pitch or pitch spectrum which will become higher with an increase of dynamic and lower with a decrease of dynamic. See **Tone Color** and **Miscellaneous Instruments**.

Some gongs, most notably Chinese opera gongs, naturally produce a pitch bend when struck.

On all drums, the head can be depressed with a fist, elbow, or stick to stretch the head and raise the pitch. The pitch of a drum can be lowered by covering the resonating drum head with a wooden board or similar object. See **Drums** for details.

Individual notes of a marimba, vibraphone, xylophone, and glockenspiel can be bent downward by sliding and pressing a hard plastic or rubber mallet into the center of the bar. See **Keyboard Percussion** for details.

Resonant metal instruments like gongs, crotales, and triangles can be lowered into a tub of water to bend the pitch downward. See **Metal** for details.

A pitch bend effect can be achieved by playing instruments like cymbals, crotales, or temple bowls which rest on the head of a timpano. The overtones of the head of the timpano resonate sympathetically with the pitch of the instrument resting on it. When the pedal of the timpano is manipulated, it gives the impression that the pitch of the instrument resting on it is bending. See **Prepared Timpani** in **Drums** for details.

A pitch bend effect can be achieved by blending an instrument's sound with that of another instrument capable of glissando. In his *Music for a Summer Evening*, George Crumb asks the performer to whistle along with the vibraphone and glissando (with the whistle) from note to note. This sounds as if a portamento effect is achieved by the vibraphone.

### **Vibrato**

Percussion vibrato is a pulsing vibrato (like flute vibrato) and not a pitch bending vibrato. Vibrato achieved by using some of the above pitch bending techniques is not common and would be rather awkward.

Vibrato on vibraphone is very common by use of its motor. Mouth vibrato, another vibraphone specific technique, is achieved by rapidly opening and closing one's mouth while holding it over the note. See **Keyboard Percussion** for details.

Triangle vibrato can be achieved by shaking the instrument back and forth after it has been struck. This can only be done when the triangle is held, not when it is mounted. Glockenspiel vibrato is created by waving a hand up and down over the struck note. These are very soft, subtle effects.

Rolls in percussion can act expressively as vibrato does for other instruments. One can achieve a vibrato-like effect by manipulating the type and speed of rolls. Specifics of roll speed and type are rarely prescribed by the composer; an *expressivo* marking is enough to indicate this type of execution.

## Sympathetic resonance

Certain resonant instruments will respond in sympathy to other sounding instruments. This can be used as a special effect, but in some cases it can be the cause of problems.

Metal instruments will tend to sing along with other loud sounds. This sympathetic resonance is very soft and will only be noticed in the silence after a sound is made. For example, in a silence after a loud orchestra passage, those sitting around a tam-tam will notice it resonating at one or several of the pitches previously present in the orchestra. Cymbals and tam-tams resonate at a wide number of pitches and are especially susceptible to this effect. Vibraphone and chimes with pedals down will quietly hum pitches that are loudly introduced to them from an outside source. For example, with stacked marimba and vibraphone, if a loud chord is struck on the marimba while the vibraphone pedal is depressed, that chord will resonate quietly on the vibraphone after the marimba sound has disbursed. Amplification can help bring out the subtle resonance in these instruments. This is the same effect that is commonly used with sympathetically resonating piano strings.

With timpani, two drums tuned a unison, fifth, or octave from each other will ring sympathetically with one another. By striking one drum loudly and then muffling it, one can hear the sympathetic resonance of the other drum. This effect is very subtle, and a glissando (on the drum not struck) can be used to make the sympathetic resonance more noticeable (see Elliott Carter's *Adagio* from *Eight Pieces for Timpani*).



[Figure 1.7]

In Figure 1.7, the Roman numerals signify which timpano is to be played. See *Timpani in Drums* for further explanation.

With prepared instruments, the rattling or buzzing sound achieved by placing an item (coin, paper clip, tin foil, rattle, tambourine, sleighbells, etc.) on an instrument is a function of sympathetic resonance. In the case of prepared timpani, the harmonics of the drum head resonate sympathetically with the resonance of the crotales, temple bowls, or cymbal (see *Prepared Timpani in Drums*).

Timpani can also be used as resonators for other non-percussion instruments that are played into the heads of the drums while the pedal is adjusted (with trumpets in Jefferson Friedman's *Sacred Heart: Explosion* and trombones in Christopher Rouse's *Seeing*).

Sympathetic resonance can be a problem in the case of unwanted additional vibrations. Some instruments, like bass drum, produce many pitches that correspond to those in the hardware used in a setup or to those in objects in the room (heating ducts, etc.) and can set off many rattles and buzzes when played. This should not be a problem in concert halls and with properly cared-for instruments and hardware.

Sometimes an instrument itself can respond unfavorably to outside stimuli, as is often the case with snare drum. When snare drum is used in a setup or ensemble, the unwanted sounds of vibrating snares are almost always a problem. On the other hand, the snare's sympathetic buzzing can be used as an effect to enhance a wind or brass sound or that of another percussion instrument (see *Drums* for more information).

**Adding mass to instruments**

The pitch of an instrument can be lowered by adding mass to the resonating body. In all cases, added mass will dampen the resonance of the instrument. The more mass added, the more dampening will occur.

As mentioned earlier in **Pitch Bending**, one can bend the pitch of a marimba, vibraphone, xylophone, or glockenspiel note by pressing and sliding a hard plastic mallet into the center of the bar. This adds the mass of the mallet head to the bar and thus lowers the pitch (see **Keyboard Percussion**).

Also mentioned earlier, metal instruments can be lowered into a tub of water. The mass of the water is added to the resonating instrument (see the **Water** section of **Metal**).

A bottle or glass filled with water will resonate at a lower pitch than the empty vessel when struck, bowed, or rubbed. As more water is added, the pitch will become lower and the instrument will become more dampened. (See George Crumb's *Black Angels*.)

Little bits of clay can be applied to an instrument to lower the pitch. This is used directly in back of the nipple to tune nipple gongs, in the center of the drum head on some hand drums, and in the center of the underside of marimba, vibraphone, or xylophone bars when quarter-tone tuning is required. In addition to lowering the pitch, the clay will dampen the instrument. With hand drums and nipple gongs, the dampening of the clay serves an additional purpose: to dampen higher overtones and clarify the fundamental pitch.

Dampening an instrument in a normal fashion may result in a pitch drop. Normally, the cloth/body part/tape/etc. that is dampening the instrument is too loosely applied to create this effect. If the instrument is held tightly, however, for example by a hand, then there will be a noticeable difference between the dampened and undampened pitch; of course, the dampened pitch will only sound for a short moment before the dampening takes full effect. The reader can observe this subtle effect with a drinking glass: strike the glass with a pencil then strike it again while grasping it tightly with the other hand. A slight pitch difference can be observed.

# 2.

# general notation

Musical notation and music are both a type of language. The process by which notation becomes music is a translation or series of translations from language to language. The fewer and more intuitive these translations, the more successful the notation will be. The language of percussion notation is especially abstract and must often be newly defined for each specific instance. By understanding the ways percussionists interpret notations and translate them into setup, sound, and ultimately music, the composer will be able to employ notations that make it easiest for the performer to read, understand, and execute his or her intentions.

## Instrument list

A complete list of instruments should *always* be included at the beginning of the score and part. This list should be complete for the entire piece - not just an individual movement. An instrument list will make it much easier for the percussionist to gather and set up the needed instruments and beaters. If the player must go through the part to find all the necessary instruments, there is a much greater chance one will be overlooked. An instrument list can also help clarify any ambiguous instrument indications in the score.

If the piece requires multiple percussionists and the parts are divided, then the instrument list should be divided by player. If instruments are shared by two or more players, the instrument should appear in both players' instrument lists with an indication that it is to be shared and with whom it is to be shared. This indication will allow the percussionists to set up so the shared instrument is within reach of both players. If instruments with only a small number of pitches are used (like nipple gongs, roto-toms, and chimes and crotales taken out of the set), then the instrument list should indicate the pitches.

player 1: timpani

player 2: marimba (shared with player 3)  
five toms  
large bass drum  
two suspended cymbals

three nipple gongs

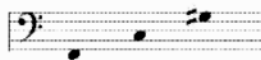

player 3: vibraphone  
five temple blocks  
tambourine  
guiro  
tam-tam (shared with player 4)  
marimba (shared with player 2)

player 4: glockenspiel

four crotales  
xylophone  
triangle  
vibraslap  
tam-tam (shared with player 3)

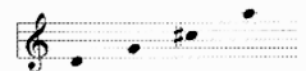

### Instrument key

An instrument key indicates where and how the instruments and some special effects are notated on the staff. Details on how to make an instrument key are found later in this chapter.

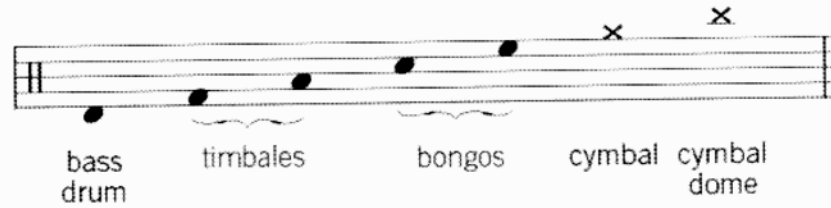

[Figure 2.1]

An instrument key is usually not necessary and is most often used for complicated setups in solo and chamber works. If a piece uses multiple percussionists with complicated setups, multiple instrument keys are appropriate.

Even with an instrument key, whenever possible and practical, the name of the instrument should be written above each of its entrances; it is best to not require the performer to memorize an instrument key. If a group of instruments is used as one instrument (e.g., two snare drums, three tom-toms, and a bass drum are always played together), instead of writing each instrument as it enters, the composer may indicate that group (e.g., “drums”).



[Figure 2.2a]

(WB = woodblocks; CB = cowbell; SD = snare drum)

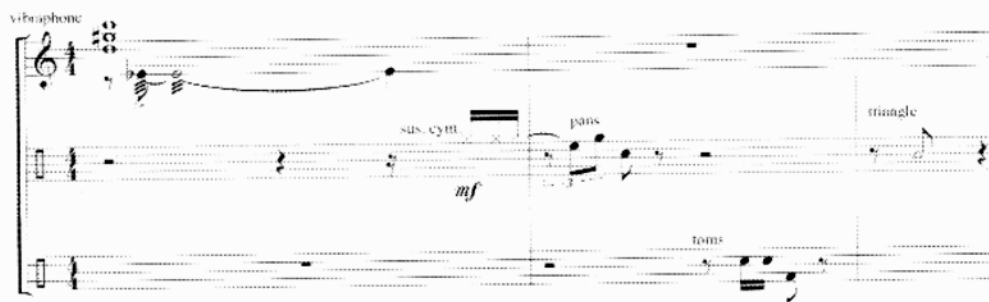

[Figure 2.2b]

(“pans” means frying pans)

[Both excerpts from Shawn Crouch’s *Suspended Contact*  
[©2001 HoneyRock Publishing, used by permission]

It is especially important in a conductor’s score to write the instrument name. If the conductor wishes to look down and see what instrument is being played, he or she should not have to search back a few pages or look at an instrument key at the beginning of the score. Details on percussion notation in conductors’ scores are found later in this chapter.

## Setup diagram

A setup diagram is a pictorial representation of the instrument setup and may be included in the beginning of the part. It is best to consult with a percussionist or even wait until the piece has been performed to settle on a diagram since the setup may change during the performer's preparation of the piece. For example, a diagram for a setup including:

- 2 cowbells
- 2 bongos
- 3 tom-toms
- 2 suspended cymbals
- china cymbal
- pedal bass drum
- tam-tam

may look like this (the X indicates the position of the player):

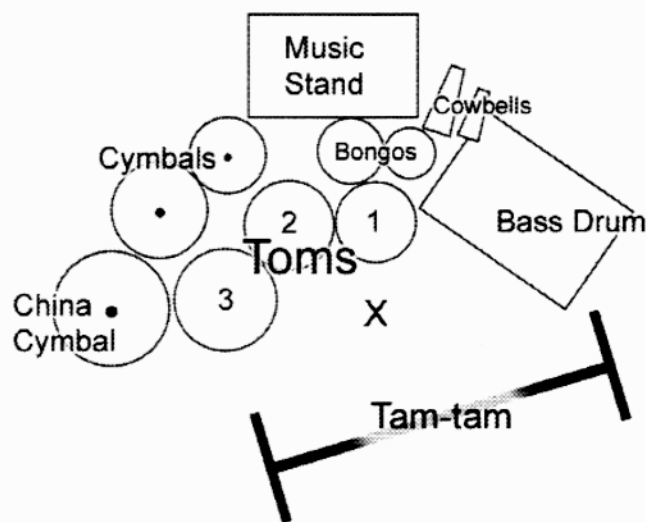

[Figure 2.3]

## Abbreviation

Poor use of abbreviation can make indications very unclear. When abbreviating, one must include the entire unabbreviated name of the instrument earlier in the piece or in the instrument list. Abbreviations like "T. Bls." which could be either Temple Blocks or Tubular Bells, or "Mar." which could be Marimba or Maracas should be avoided; the abbreviation used should belong to that instrument and that instrument only. It is also helpful to put the abbreviation in parentheses next to the full instrument name in the instrument list; this will leave little chance of confusion.

For example:

- marimba (Mba)
- snare drum (SD)
- bass drum (BD)
- cowbells (CB)
- sleighbells (SB)
- Japanese temple bowls (JTB)
- crystal glasses (GI)

Standard abbreviations do not exist. Abbreviations should be devised by the composer.

## Language

Instrument names and performance instructions should be written in one language - preferably English. English speaking composers sometimes use foreign terms for instruments (e.g., *gran cassa* instead of *bass drum*); this is not recommended except in the case of instruments that are commonly



called by foreign names, like *timpani* or *glockenspiel*. Composers writing in other languages may want to include an English translation of any text in the part.

The names of standard instruments written in other languages will usually not give performers much trouble (although an English translation, if only in the opening instrument list, is still very much welcome). Language can be a real barrier and translations are especially valuable with more complex performance instructions and unusual beater or instrument specifications.

### Symbol notation

Symbol notation uses small pictures or icons to denote different instruments, mallets, and playing techniques, such as:

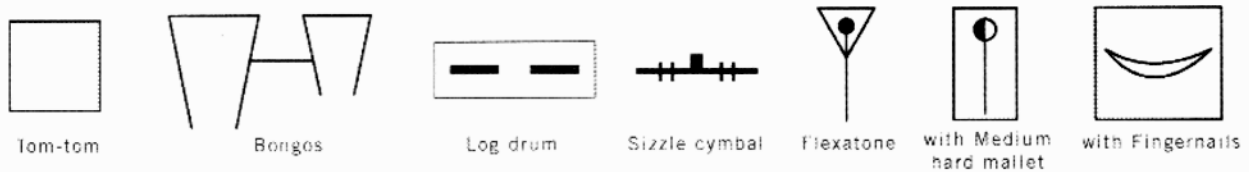

[Figure 2.4]

This system was an unsuccessful attempt to transcend language barriers. Few composers ever used it, and as a result, percussionists did not become familiar with the symbols. When playing music that uses symbol notation, most performers must constantly look back to the instrument key at the beginning of the part to translate. (See Jacob Druckman's *Animus II*, Luciano Berio's *Circles*.) Use of this system is not recommended.

### Divided or undivided parts / Score part or separate parts

Parts for an ensemble piece with multiple percussionists can be made one of three ways: an undivided score part, a divided score part, or separate parts.

#### Undivided score part

With an undivided score part, all the music appears on the same page with no indication of what music is to be played by which individual player. This means that the performers will have to figure out how many people are needed and then divide the parts among themselves.

If the parts are rather simple and sparse with only a few instances of more than one person playing at a time, then an undivided score part is probably best (see Figure 2.5). In this case, more than one player can read from the same music, and they can follow each other's parts.

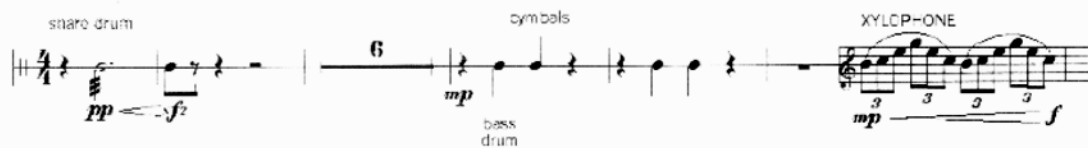

[Figure 2.5]

On the other end of the spectrum, an undivided score part is also best if the parts are very complicated with lots of simultaneous playing and no clear way to divide them (see Figure 2.6). In this case, the performers are likely to have an easier time dividing the parts than the composer. If the composer were to divide the parts, they would have to be done exactly right (with respect to issues of space, shared instruments, doubled instruments, getting to and from instruments and mallets, etc.), or even more problems would be created. If the composer does not want to or does not know how to divide the parts, a percussionist could help, or this task could be left for the percussionists who perform the piece.

Very involved score parts will often create especially difficult page turns.

♩ = 86

Snare Drum

3 Tom-Toms

Bass Drum

Susp. Cymbal

Triangle

Tam-Tam

4 Brake Drums

Crotales

Guiro/Vibraslap

SD

Toms

BD

Cym.

Tri.

Tam

Brake Dr.

Crot.

Guiro/Vbrslp.

(rimshot)

(choke)

(bell)

(edge, choke)

(stick in middle)

(with mallet)

(x's = triangle beater on edge)

[Figure 2.6]

As explained in *General Logistics*, the best way to ensure a proper division of parts is to assign instruments to each player and then write with those setups in mind. Dividing a complicated undivided score can be very tricky. If the setups are designed before the music is written, then it will work out much more smoothly.

**Divided score part**

Parts can be divided but still notated together on the same page. This allows the percussionists to see what others in the section are playing. Divided score parts are also useful when players are required to move around and share different setups; a player moving to his or her neighbor's setup can just look at the music that is there and not have to bring their music from their previous setup. Divided score parts also allow percussionists to divide the music between them differently than the composer has done without having to pencil in music from another part. Figure 2.6 could be condensed for four players like this:

Figure 2.7 shows a divided score for a percussion ensemble, divided into two systems. The first system is in 4/4 time with a tempo of 86. The second system is in 3/4 time. The score is divided into four staves (I, II, III, IV) for each system. The instruments and techniques are as follows:

- Staff I:** 3 tom-toms, snare drum. Dynamics: *ff*, *mf*, *pp*, *pp*.
- Staff II:** large bass drum, 4 brake drums. Dynamics: *ff*, *pp*, *sub. ff*, *(pp)*.
- Staff III:** suspended cymbal (choke), (choke) tam-tam, (bell), (scrape on edge). Dynamics: *ff*, *mf*, *p*.
- Staff IV:** guiro, triangle, crotales. Dynamics: *ff*, *mp*, *pp*, *mf*.

The second system includes the following instruments and techniques:

- Staff I:** (rimshot). Dynamics: *ff*, *pf*, *p*, *ff*.
- Staff II:** *ff*.
- Staff III:** (choke), (bell), *ff* (edge choke), (x's = with triangle beater on edge), (bell). Dynamics: *ff*, *mf*, *pp*.
- Staff IV:** vibrislap, (with mallet). Dynamics: *mp*, *pp*, *p*.

[Figure 2.7]

Parts can also be partially divided (e.g., two parts - one with players 1 and 2 and the other with players 3 and 4).

When a composer prepares for an orchestral reading in which the percussionists will not have much time to look at the parts, properly divided parts are a must. With an undivided part, a percussionist may have to sit down with the score for some time to work out all the logistics. This preparation time may not be available before a reading.

### **Separate parts**

Separate parts (one player's music per part) can reduce visual clutter and facilitate page turns. As stated earlier, separate parts must be divided correctly, otherwise many more problems are created than solved.

### **Multiple copies of parts**

If a large setup is involved, the composer should provide at least two copies of the part. Percussionists will often need extra copies for different areas of a large setup. An extra copy will eliminate the need for the performer to move music around during the piece or to have to make last minute photocopies.

### **Handwritten versus computer-generated parts**

A beautifully handwritten part is always welcome, but for many reasons, a computer-generated part is usually better. When using large instruments or setups, percussionists are often forced to play at a distance from their music. An eighth rest that looks a bit like a quarter rest or an E<sub>b</sub> that is a little too close to the D line will be a serious problem. Most of these problems are solved with a computer-generated part.

### **Cues**

Cues are always helpful. The best type of cue is from another percussionist. In this case, the person playing the cue is close by, heard very well, easily distinguishable from the rest of the ensemble, and is often visible. More specifically, the best percussion cue is an entrance of a new instrument.

Next to percussion, the horns can be a good cue source in an orchestral setting. The horns are often situated directly in front of the percussion with their bells pointed backwards. The rest of the back row - trumpets and low brass - are easily heard and can be watched for entrances. Entrances and distinct rhythms in the strings can easily be seen from afar, if not heard. Basically, in thickly textured tutti sections, please don't provide a bassoon cue.

During a mallet switch, instrument switch, or timpani tuning change, the player may have momentarily shifted his or her attention from counting rests. Cues before entrances after these spots are especially appreciated.

Cues, not just at the end, but also in the middle of especially long rests are very helpful to orient the performer before he or she must be ready to play.

### Notating percussion in a conductor's score

In a conductor's score, the percussion section is traditionally found just beneath the trombones and tuba and above the harp, keyboard instruments (piano, celeste, etc.), soloists, chorus, and strings. The timpani is always on top of the other percussion with its own bracket. There is no guarantee that the percussionists will set up in the order notated in the score, so the labels "Player 1, Player 2, etc." can be arbitrary.

For pieces with multiple percussionists playing multiple instruments, the player's number and the instrument name should appear on each page of the score. The conductor should not have to flip back a few pages or look at an instrument key in the beginning of the score to see which instrument is being played.

The image shows a page of a musical score for a percussion section. It consists of several staves. At the top, there are two staves for Trombone 1 & 2 and Trombone 3 & Tuba. Below these are the percussion staves: Timpani (Timp.), Percussion 1 (4 Roto-toms), Percussion 2 (4 Tom-toms and Bass Drum), Percussion 3, and Harp/Quadrant (Hp. + Quad.). The percussion parts are written with various rhythmic notations, including eighth and sixteenth notes, rests, and dynamic markings such as *f*, *mf*, and *mp*. The score is in 3/8 time and features complex rhythmic patterns.

[Figure 2.8]

[From Jefferson Friedman's *Sacred Heart: Explosion*]

### Notating unpitched percussion

Because of the infinite combinations of instruments and infinite ways of setting them up, a specific system of notation is not standard and must be devised for each new piece. The following are guidelines for forming an effective notation.

#### Staves

Different lines and spaces on a staff can be used to denote different notes, different instruments, and even different sounds. In Figure 2.9, instead of two or three instruments, staff lines are used for different sounds on one instrument.

tom-tom  
edge center

snare drum  
with stick with yarn

djembe  
slap tone bass

[Figure 2.9]

For a small number of notes, instruments, or sounds, only a one-line staff may be needed. One line can show up to three instruments or sounds: below the line, on the line, and above the line.

[Figure 2.10]

As instruments or sounds are added, lines can be added. For seven sounds, one might use a three-line staff.

[Figure 2.11]

A regular five-line staff is most common, with ledger lines if necessary. Two bracketed five-line staves (like a grand staff) can be used for larger setups. Anything larger should be avoided as it can make the part difficult to read. The use of many one-line staves is not ideal because it can result in excessive cross-beaming and notated rests (see Stravinsky's *Histoire du Soldat* and *Rite of Spring* timpani part). For example, this:

gongs

cowbells

drums

[Figure 2.12a]

is much easier to read like this:

gongs  
cowbells  
drums

[Figure 2.12b]

One line with written instructions or symbols can also be used. The examples in Figure 2.9 could also be notated like this:

Figure 2.13 shows three musical staves illustrating notation for unpitched instruments. The first staff is for a tom-tom, with a legend indicating 'e = edge' and 'c = center'. The notes are marked with 'E' and 'C' below them, and stems are directed downwards. The second staff is for a snare drum, with a legend indicating '— with stick' and '— with yarn'. The notes are marked with '—' below them, and stems are directed downwards. The third staff is for a djembe, with a legend indicating 'B = bass', 'T = tone', and 'S = slap'. The notes are marked with 'B', 'T', and 'S' below them, and stems are directed downwards.

[Figure 2.13]

If instrument changes are infrequent, one line with written instructions may be appropriate. Stem direction should be used to further clarify instruments, as with the bass drum and cymbals in Figure 2.14.

Figure 2.14 shows a musical staff in 4/4 time. The first measure contains a snare drum note (marked *pp*) and a bass drum note (marked *fz*). The second measure is a rest. The third measure is a six-measure rest (marked '6'). The fourth measure contains a crash cymbal note (marked *mp*) and a bass drum note (marked *mp*). The fifth and sixth measures contain crash cymbal notes.

[Figure 2.14]

### Noteheads

Differently shaped noteheads can be used to make instruments immediately recognizable and easier to pick out at a glance. Different noteheads can also be used to make staff lines available for more than one instrument or sound when there is not enough room on a staff for all the instruments or sounds to be represented (see Figure 2.17).

In a setup, drums are usually regular noteheads, and instruments like cymbals, cowbells, or wood blocks may be X's. Triangles sometimes have triangle shaped noteheads. Under normal playing conditions, pitched instruments should always be notated with regular noteheads.

### Adding pitched instrument staves to unpitched instrument systems

When pitched instruments are included among many unpitched instruments, it is best to add extra staves. More than one pitched instrument can coexist on one staff, but only if the writing is sparse. In this case, the composer can make instruments distinguishable with note stem direction and by writing the instrument name above the music that belongs to it (see Figure 2.15).

**Adagio, con rubato**

[Figure 2.15]

[From Ryan Streber's *Rondel*]

Instruments that only use a few pitches (e.g., tuned gongs, crotale notes, chime notes, almglocken, roto-toms, or timpani) do not necessarily need to be notated on a pitched clef. The pitches can be specified at the beginning of the part and subsequently notated like unpitched instruments.

[Figure 2.16]

### What goes where on the staff

The position of the instruments on a staff should have a direct relationship to the physical setup of the instruments:

- left to right in a setup = low to high on the staff
- back to front = low to high (i.e., instruments closer to the performer will be notated lower than instruments further from the performer)
- anything played by the feet is notated on the bottom

For example, a setup with two tom-toms, two bongos, and five temple blocks might be notated like this:

[Figure 2.17]

and be set up like this (the X indicates the position of the performer):

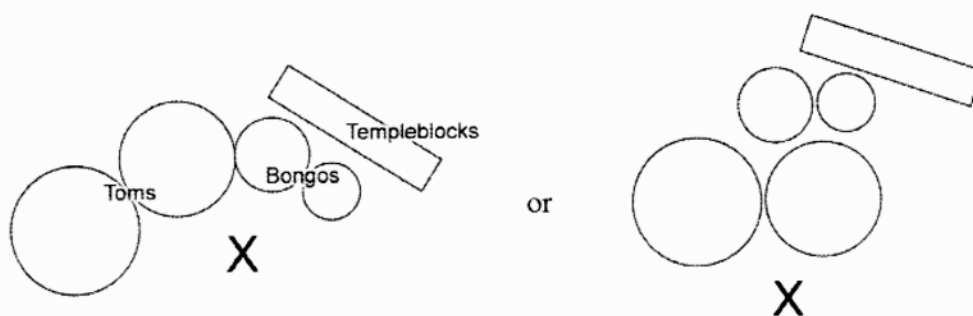

[Figure 2.18]



Instruments that are operated by a foot pedal will always be notated at the bottom regardless of the instrument's pitch or placement in the setup.

In large, complicated setups, the physical relationship of the instruments can sometimes be more important than even the pitch of the instruments. If a triangle is positioned to the left of a bass drum, then the bass drum should be notated above the triangle even though the pitch is drastically opposite. Logical pitch sequence should, however, be maintained if possible.

Instruments will be set up and notated with the guidelines above only if they are used together as one instrument. In the example on the previous page (Figures 2.17 and 2.18), the writing will probably use the sounds of the drums and temple blocks like different notes of a pitched instrument. This careful setup/notation relationship is unnecessary, however, when instruments are used separately. For example, if a part calls for xylophone, snare drum, bass drum, and wood block and these instruments are always used on their own with enough time for the performer to comfortably switch between them, then they can be notated and set up without too much consideration.

If the writing uses the instruments together and the notation disagrees with the setup, it is not such a tragedy. Percussionists are used to this and can adapt, but the music will be much more difficult to read and learn. A percussionist may ask the composer to re-notation accordingly for especially complicated parts.

### **The chicken or the egg?**

Which comes first - the notation or the setup? It could go either way. Most often, composers will compose without a specific setup in mind. In these cases, the performer will design a setup to fit the notation as closely as possible, but because of physical demands that the writing imposes or physical demands that the size or shape of the instruments impose, the setup may not fit the notation exactly. As stated above, this is not a significant problem, and percussionists commonly read notations that do not exactly fit the setups.

For a complicated setup or one on which very fast or very difficult figures will be played, it is advantageous for the composer to devise a setup before starting to write. With a preconceived setup, one is sure to use appropriate notation, thus making the piece easier to read and learn. Also, with a setup diagram to look at while composing, the composer can get a feel for how the performer will move around the instruments and can see what is possible and what is comfortable.

It is best to consult a percussionist to figure out how to set up the instruments. Setting up instruments has a lot to do with personal preference, the writing in the piece, and the size and shape of the instruments. One can get an idea of how to set instruments up from **Appendix A**, but the composer should work with a percussionist whenever possible.

### **Clefs**

For pitched instruments, percussionists read either treble or bass clefs. Soprano, alto, and tenor clef should be avoided. Unpitched percussion is always notated in percussion clef. Percussion clefs can be drawn a number of different ways, as long as they do not specify pitch.

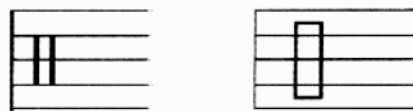

[Figure 2.19]



### Unspecified instruments (indeterminate instrumentation)

Due to the enormous size of the percussion family, composers can sometimes afford to be vague with their instrument specifications. Such indications allow performers to be creative and/or practical with their choices; performers may then use something that is of limited availability, an interesting combination of instruments, or an instrument they made or discovered (keep in mind that percussion “instruments” can be found in attics, basements, kitchens, living rooms, back yards, toy stores, etc.). Certain characteristics of unspecified instruments may be specified, such as material (wood, metal, skin [drum], glass, etc.), pitch register, and amount of resonance. For example, David Lang’s *The Anvil Chorus* calls for three resonant metals, four non-resonant metals, four pedal operated metals (with no additional specification), two wood blocks, and kick bass drum.

Drum choices are commonly left open. Instead of “two high tom-toms, two congas, two timbales, two timpani and a bass drum” the composer may write “nine drums.” This allows the performer to pick instruments that are more creative, effective, and available.

### How much to notate

Sometimes passages on unpitched instruments may be vaguely notated. Most percussionists are accustomed to improvising and can do so effectively. Instead of writing out a part completely, it may be better for the composer to write an outline of the rhythm or indicate the character of the part and let the player fill in the rest. A completely written out part might be more work for both the composer and player and may end up sounding exactly like an improvisation.

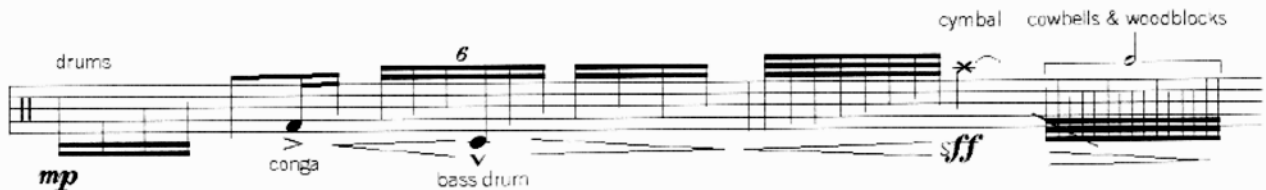

[Figure 2.24]

### Systems of notation for which there is no standard

Notations for many special effects are not standardized and should be explained at the beginning of the score and parts. In this book, if no specific notation is suggested, there is no common notation; one should be created by the composer or the instructions should be written out. Remember, English is always standard.

### Return to a “normal” method of playing

When an unusual method of playing is indicated (e.g., using a prepared instrument or playing with unusual mallets), it should be indicated when the player should stop doing this (e.g. “remove paper clip” or “return to normal beaters”).

### Dynamics

Different instruments have a far different dynamic range from one another, even when struck with the same mallet at the same intensity. This should be taken into account when dealing with setups or instrument switches. For example, a *fortissimo* maraca will not have a chance against a *fortissimo* brake drum with brass mallets, and a fast passage on four small tom-toms with snare sticks cannot get as soft as a similar vibraphone passage with yarn mallets.

When an instrument switch is made, a new dynamic specific to the new instrument should always be notated.

See Appendix D for a detailed explanation of dynamic discrepancies.

## Rolls

A roll is a tremolo often used to simulate sustain. Rolls with soft beaters on resonant instruments can sound seamless (like bass drum mallets on bass drum, soft marimba mallets on the low end of the marimba, and yarn mallets on cymbal). On less resonant instruments, each stroke of the tremolo will be heard so the roll will need to be played more quickly.

### Rolling on one surface

Rolls can be notated a number of different ways.

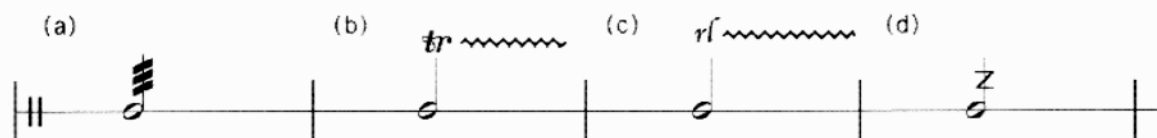

[Figure 2.25]

Figure 2.25:

- (a) The three-slash notation is most common but can be confused with abbreviated measured thirty-second notes. If the three-slash notation is used for rolls, it should not also be used to indicate thirty-second notes in the same piece.
- (b) The trill sign notation is also common but can be confused with a trill.
- (c) This is a modern notation adapted from the trill sign and has been used in some recent French music - "rf" means *roll* (or *roulée*). This notation is unambiguous.
- (d) The Z notation is clear but not often found in concert music; it is used primarily in drum corps.

Notations (c) and (d) are not standard and should be explained at the top of the score and part.

Unique to drum sticks is the *buzz* or *closed* roll, where the sticks bounce and make numerous articulations per stroke to create a very rapid tremolo. A *single-stroke* roll (no multiple bounce in each hand, just single strokes) can be executed with all beaters.

Just one stroke from a buzz roll can be used as an effect or for especially short rolls (see Figure 2.26).

One can elongate this buzz effect by controlling the pressure with which the stick is held to the instrument. The stick can be dropped naturally, like dropping a ping pong ball on a table (see Figure 2.27), or pressure can be applied to speed up the bounce. A diminuendo will result naturally in all cases.

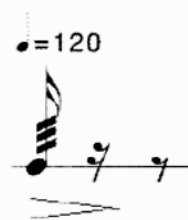

[Figure 2.26]



[Figure 2.27]

In drum corps and military style drumming, an *open* or *double-stroke* roll is used. With an *open roll*, only two articulations are made with each stroke and all the individual attacks can be heard. An *open roll* may be specified on drums to evoke a military sound.

Percussionists will decide which type of roll to use, depending on the beaters and the resonance of the instrument. With sticks on small tight drums (small to medium tom-toms, tenor drums, timbales, small to medium roto-toms, snare drums, field drums, and bongos), a roll, unless otherwise

indicated, will mean a buzz roll. Buzz and open rolls are possible on all instruments when sticks are used. A *buzz roll* (with sticks or any beater) cannot be effectively executed when four mallets are held. Single-stroke rolls are more appropriate on larger drums with loose heads (even with sticks), on all non-drum instruments with sticks, and on all instruments with mallets. Single-stroke rolls will not work as well on snare drum, bongos, or other small drums because the sound is very short and has little resonance to fill the space between the strokes. These distinctions are rarely notated and are almost always left up to the performer.

Rolls generally start with a slight emphasis. The second of two untied rolled notes will be re-attacked. Dotted line ties are often used to tie rolls: both dotted and regular ties are acceptable.

When a rolled note is followed without a tie by an unrolled note (see Figure 2.28a), the unrolled note will receive a slight accent (similar to the slight accent a wind player would make when re-attacking a note). The roll will usually be played right up to the note as if it were tied, but some players might add a slight break beforehand. When the notes are tied (see Figure 2.28b), the roll will still end with a slight accent, but this accent will tend to be less than that of the previous example. In this case, there is sure to be no break between the notes.

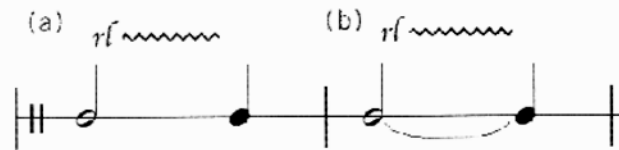

[Figure 2.28]

Interpretations of the notations in Figure 2.28 will vary slightly, but those described are common.

Rolls on sustaining instruments, like vibraphone, are not often necessary and can sometimes be a distraction. These notes may be best left to ring naturally.

### Rolling on two surfaces

A roll on two instruments or two notes is a trill between those two instruments or notes. In notation, a tremolo between two notes with separate stems (Figure 2.29a) is less familiar to percussionists than a tremolo on two notes on one stem (2.29b). Notation (b) also makes the rhythm easier to read; however, only notation (a) indicates which note should start the tremolo.



[Figure 2.29]

### Rolling on four surfaces

There are a variety of roll types with rolls on four surfaces. Roll type indications are almost exclusively found in marimba transcriptions (written by marimbists) or in scores that have been edited by a percussionist. If the composer feels that controlling these specific roll textures is important, it is probably best to experiment with a performer after the piece has been written and learned so the different roll types can be heard in context. Percussionists sometimes switch back and forth between roll types throughout the learning process to try to find the one that is just right for each situation. Roll type is usually not important compositionally and may be a decision best left to the performer.

There are three main types of rolls: the *traditional roll*, the *ripple* or *Musser roll*, and the *independent roll*. The traditional roll is just hand-to-hand.



[Figure 2.30]

A ripple or Musser roll (after marimbist Clair Omar Musser) is similar to the traditional roll except instead of the two mallets in each hand striking simultaneously, they are staggered to give a less metered texture. This is sometimes notated with an S through the note stem.



[Figure 2.31]

With the independent roll, the two mallets in each hand alternate independently of the other hand. The two hands could even alternate at different speeds to create a more meterless texture. This is sometimes notated with an O through the note stem.



[Figure 2.32]

The S and O notations are not standard and should be explained at the top of the score and part.

The above patterns are the most common types of rolls, but any fast pattern can function as such. (See Jacob Druckman's *Reflections on the Nature of Water*, second movement).



[Figure 2.33]

### One-handed rolls

One hand can execute an independent roll by itself, called a *one-handed roll*, which leaves the other hand available to do other things. This one-handed roll could be executed on two surfaces or on one surface (see Figure 2.34).

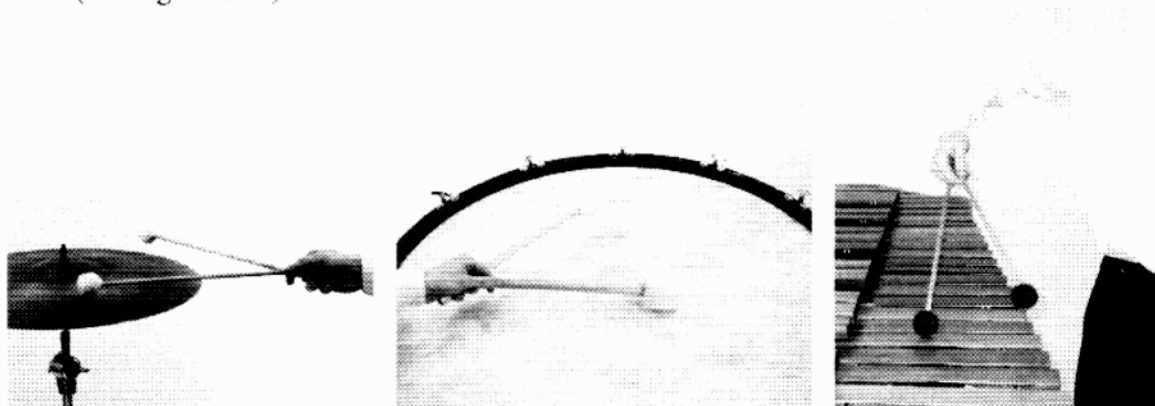

[Figure 2.34]

## 2. general notation

A one-surface roll can be achieved with the independent roll or with a *split-bar roll*. A split-bar roll is executed by placing the two mallets of one hand on either side of a marimba bar - one on top and the other underneath - and then shaking the mallets up and down (see Figure 2.35a). This was originally designed for marimba but can be used on all instruments that have both sides accessible:

- the “white” notes on marimba, vibraphone, xylophone, and crotales and the “black” notes if the other side of the instrument is reachable; reaching the black notes is not practical under normal playing conditions
- cymbals
- the edge of gongs
- Japanese temple bowls
- cowbells, agogo bells, almglocken
- metal pipes
- thundersheet
- temple blocks
- crystal glasses



[Figure 2.35a]



[Figure 2.35b]

When executed on a non-keyboard instrument, this technique is often also called a *mandolin roll*. The choice of an independent or mandolin roll should be that of the performer. The decision will be based upon sticking and movement issues that will be explored throughout the preparation of the piece. An indication of roll type may be included, if at all, only after the piece has been worked out by a performer.

One note or instrument can also be sustained with a single-mallet roll. This is a much slower roll and only works well at soft dynamics with soft mallets on resonant instruments (e.g., vibraphone, cymbals, tam-tam, bass drum, and the lower register of marimba). Rolls on large tam-tams are usually done this way, even at loud dynamics.

Other one-handed rolls:

A standard triangle roll is executed with one hand. The player moves the beater rapidly back and forth between two sides.



[Figure 2.36]

With cymbals, a mandolin roll can be executed with one brush by placing the cymbal edge in the middle of the brush's wires and moving the brush up and down. This only works at soft dynamics.



[Figure 2.37]

One-handed rolls on cowbells and almglocken can be executed by moving the beater rapidly up and down inside the mouth of the bell.

Double-headed beaters can be used to achieve one-handed rolls on bass drum. The hand rotates back and forth and strikes the drum with alternating ends of the mallet. Rolls with double-headed bass drum beaters cannot be played as loudly as two-handed rolls.

## Rolling on three surfaces



[Figure 2.38]

A rolled three-note (or three-instrument) chord (Figure 2.38a) can be executed in a number of ways:

- (b) two notes against one note
- (c, d) two notes against two notes with one common note
- (e) three separate notes - two with an independent roll and the other with a single-mallet roll, single-note independent roll, or split-bar roll
- (f) another pattern

The method of execution will be decided by the performer and does not need to be indicated.

## Rolling from the resonance of a previous attack

The start of a roll can be delayed on resonant instruments by tying a struck note to a rolled note of the same pitch. The roll will have an ambiguous beginning, emerging out of the dying resonance of the first struck note. This is especially effective with *forte-pianos* where the roll can pick up after the resonance has dwindled to *piano*.



[Figure 2.39]

## Bowed instruments

The following instruments can be bowed with a bass or cello bow:

- vibraphone
- crotales
- marimba
- xylophone
- chimes
- cymbals
- gongs
- triangle
- cowbells, agogo bells, and almglocken
- Japanese temple bowls
- thundersheets
- crystal glasses
- flexatone

Two hands are usually required to bow crotales and all non-keyboard instruments - one to hold the instrument in place and the other to bow. Only one hand is needed with other keyboard instruments, so two bows can be held or the non-bowing hand could do something else like strike the instrument with mallets.



Percussion instruments do not speak nearly as well as the strings of traditionally bowed instruments so a gradual swelling dynamic is most easily executed. A sharp attack on the start of a bowed note is almost impossible (unless struck with a mallet). Sustaining a loud note for an extended period of time or managing two different dynamic shapes with two different bows is very difficult to execute. This figure is most natural:



[Figure 2.40]

The bowed sound and the resonating sound can be notated separately; this is the most accurate notation. It can be done with note lengths or, on vibraphone, with pedal indications.



[Figure 2.41]

Bowing takes time and is a bit awkward, so fast passages are not possible. The composer should allow time for the performer to pick the bow up, get it in place, make the instrument sound, and put the bow down. On mallet instruments, more time is required to move the bow from the "white" notes to the "black" notes. To do so the player must lift the bow up and over the instrument to the other side before getting it into position for the next note. Also, when bowing the accidentals, the music stand can often get in the way, and extra time may be necessary to maneuver around it.



[Figure 2.42]

When a bow re-attacks an already ringing note, it will tend to dampen the instrument before making it sound again. A smooth re-attack is possible but difficult. As a result, especially long bowed notes may not work since the bow changes may be too apparent. The bow's tendency to dampen can be used as an effect, especially with vibraphone where one can stop the bow short to immediately dampen the sound. This is like a dead stroke (or dead bow) - see **Dead Stroke**.

Multiple players with two bows each could be used to execute more complicated bowed passages (see Steve Reich's *Sextet*). For example, two players can play on either side of a vibraphone - one bowing the naturals and the other bowing the accidentals.

Bowed cymbals, unpitched gongs, and thundersheets will produce a pitch (or several pitches) from the harmonic spectrum of the instrument. The pitch(es) produced vary depending on the speed of the bow, the volume, the spot on the instrument that is bowed, the place the instrument is held by the other hand, and how much of the instrument is muffled by the holding hand or stand. With all the

variables, many different pitches can be created on one instrument, but unfortunately they cannot be controlled. The pitch is very unpredictable, and it is unreasonable to request specific pitches, specific pitch relations, or even a consistent pitch.

Keyboard instruments, tuned gongs, triangles, cowbells, agogo bells, almglocken, Japanese temple bowls, and crystal glasses will have a definite and constant pitch when bowed. Flexatones will have a definite pitch, which will bend as the tension of the metal is manipulated.

The number of bows needed should be specified in the instrument list.

### **Articulation and phrasing**

Although true legato and control over different articulations cannot be achieved on most percussion instruments, articulation and phrasing markings can still be helpful. Percussionists can realize these notations through dynamics, beating spot (where the instrument is struck), and mallet choices. A composer should not hesitate to write slurs into a glockenspiel or even a snare drum part; the slur sound can still be achieved even though each note must be articulated. The effect will not be as apparent as it would be on a clarinet, but these notations will make a difference.

On resonant instruments with pitch bend capabilities, such as timpani or flexatone, a true slur can be executed by striking the instrument once and then changing the pitch. This effect is dependent on the volume of the resonance - the further the slurred note is from the original articulation (in time and in interval), the softer it will be. A slur alone will not indicate a glissando; glissando must be notated separately.

Rolls can connect notes and create a slur-like effect.

### **Dead stroke**

A *dead stroke* is achieved by holding the mallet on the instrument after the attack to dampen the vibration. Dead strokes are commonly notated with a plus sign (+) over the note. Ringing notes in a passage with dead strokes can be indicated with a circle (o) over them; this is not necessary but can help to clarify. "D.S." or staccato dots are other common indications for dead stroke. These notations are not standard and should be explained at the top of the score and part.

Dead strokes take more time to execute than normal strokes since the mallet head needs to spend more time on the instrument. The faster a dead-stroke passage moves, the less effective it will be.

With drum sticks, wood mallets, plastic mallets, and hard rubber mallets, dead strokes will create a buzz sound as the beater bounces quickly on the instrument (like the bounce of a buzz roll). Mallets wrapped with yarn, cord, and felt have a soft layer of material to cushion the attack and eliminate the bounce. This buzz can be avoided by using wrapped mallets (e.g., instead of plastic mallets, very hard yarn or cord mallets could be used) or by wrapping a layer of masking tape around the mallet head.

Dead strokes can be used as short notes on marimba or vibraphone to contrast with the resonating normal strokes (see Steven Mackey's *See Ya Thursday*). On drums they will sound harsher and will raise the pitch slightly as the drum head is stretched by the pressure of the dead stroke.

### **Note lengths**

#### **Exact or inexact note-length indications**

Exact note-length indications are not always necessary. Percussion parts will often have approximate note lengths since some instruments only ring for a short period of time. As a result, percussionists are accustomed to making decisions about when to stop an instrument from ringing.

For the most control over note length, exact note lengths can be written (as one would for piano music) with an indication at the beginning of the part that note lengths should be accurately observed. For less specific notation, indications can be used only when necessary (for cymbals and other resonant instruments). An “l.v.” (laissez vibrer, let vibrate) or an open slur can indicate to let the instrument ring, and a coda symbol, two slashes, or the word “cut,” “choke,” “damp,” or “secco” can be used to indicate dampening.



[Figure 2.43]

Some instruments have little or no natural resonance. For these instruments, note length does not need to be notated exactly; a whole note will not ring any longer than a sixteenth note. Note length will not change unless the instrument is dampened while it is struck. Sometimes note lengths are important to indicate dynamic and timbral phrasing, but the actual length of the note will not be influenced. These instruments are:

- snare drum and high pitched drums
- xylophone
- vibraphone with pedal up
- wood/temple blocks
- claves
- cajón
- slapstick
- castanets
- tambourine
- maracas/shakers

Some other instruments have a little resonance that can be controlled through dampening but are generally left to sound for their full lengths. If accurate short durations are desired for special articulation effects, then dampening can be notated. These instruments are:

- medium pitched drums
- marimba
- log drum
- cowbells, agogo bells, almglocken
- brake drums, anvils
- metal pipes
- finger cymbals
- rice bowls
- vibraslap

In the above two categories, notation of accurate note lengths may be more trouble than it is worth. Excessive rests can clutter a part and make it very difficult to read (see Figure 2.44a). If inexact note lengths create phrasing problems, articulations can substitute (see Figure 2.44b).

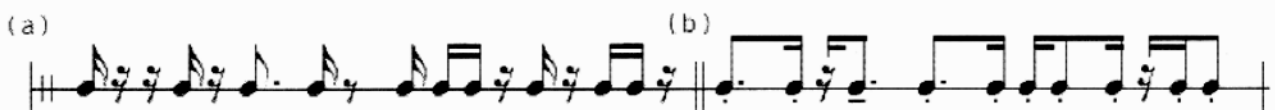

[Figure 2.44]

With resonant instruments, resonance should be considered and controlled either with accurate note lengths, with dampening indications, or through the discretion of the performer. These instruments are:

- timpani
- bass drum
- vibraphone
- glockenspiel
- crotales
- chimes
- cymbals and gongs
- Japanese temple bowls, mixing bowls
- triangle

The composer should be careful to not over-indicate note lengths and dampening. Enough time for the player to observe these indications will not always be available, and many long notes and ties can clutter the part without any realistic effect. Dampening may take just a fraction of a second, but that fraction of a second must still exist. If the player needs to play, turn a page, or change mallets, then dampening might not be possible. A performer can sometimes dampen with one hand (especially with small instruments), in which case the other hand is free to do other things.

All the beats in a measure must still be accounted for even when an instrument is ringing (Figure 2.45a). Figure 2.45b is not correct and is confusing.

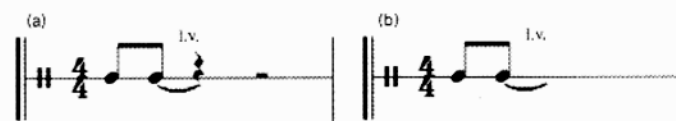

[Figure 2.45]

### Damper pedals

Vibraphone and chimes have damper pedals so note length can be more easily observed. Pedaling can be notated as one would for piano (mm6-7 in Figure 2.46). Pedal indications are very clear but limited because all the notes are dampened and released at once; these instruments do not have the piano's ability to sustain individual notes while the damper is applied. If specific note lengths are written without pedal indications, percussionists can try to use the pedal while dampening individual notes with a mallet or hand. This will allow some notes to ring longer or shorter than other notes as necessary (mm20-27 in Figure 2.46). Often slurs are used to indicate pedal groupings (mm8-10). The composer should choose one of these pedal notations and use it consistently throughout a given piece to avoid ambiguity.



[Figure 2.46]

[From Nico Muhly's *Sustained Music*]

Flutter pedal, half pedal, and other pedal effects used on piano apply to vibraphone and to some extent on chimes. If necessary, a weight could be used to hold down the pedal of a vibraphone or a set of chimes to leave them free to sustain without the player's foot. Chimes often have a mechanism that can be used to keep the damper open.

### Muting (muffling, dampening)

Instruments can be muted with a piece of cloth, tape, a mallet, a hand, or another body part. If an instrument is dampened directly after it is struck, it will simply shorten the note length. If the instrument is dampened while it is struck, it not only shortens the length but will also change the sound. The sound of the resonance will also change if the instrument is only somewhat dampened after the attack (see Tone Color).

Light dampening with a piece of cloth is often used to make drums drier and darker and to clear up soft articulate passages on timpani and other large resonant drums. Heavy dampening is commonly used with pedal bass drums; towels, sheets, or something similar is often inserted into the drum, giving it a full but punchy sound.

Muting can be used as a special effect on all instruments.

When a cloth mute is used, some time is required to place it onto or remove it from the instrument. Other means of muting are more flexible; by muting with a mallet, finger, hand, leg, or torso, one can adjust the degree of muffling while playing. When complex muting is required, it is best if only one hand is required to play so the other hand is free to muffle.

Closed and open (dampened and free-to-ring) are commonly notated with +’s and o’s, respectively. Passages like Figure 2.47 are most effective on smaller instruments like triangle, where dampening can be done quickly and easily; on instruments such as a large tam-tam, this would be very difficult to execute.



[Figure 2.47]



[Figure 2.48]

Percussionists often use various dampening techniques on resonant instruments to control the sound and note lengths regardless of whether or not it is indicated by the composer. For example, the resonance of a concert bass drum head is usually controlled with a leg (see Figure 2.48), hand, or towel.

Dampening wind chimes and mark tree is somewhat difficult to execute effectively. These instruments are often left to exhaust themselves naturally even though they ring for a rather long time. Some mark trees have damper bars that allow the percussionist to muffle the instrument in less time.

### Sustaining instruments

Of course with instruments that have unnatural sustain - instruments that are rolled on, bowed, scraped, shaken, cranked, blown through, etc. - note length should always be notated exactly.

## Orchestrating to evoke the sounds of different cultures

Percussion often plays an important role in the sounds characteristic to the music of different cultures. For this reason, composers commonly use percussion to elicit these styles.

For example:

- Beethoven - battling armies in *Wellington's Victory*
- Rimsky-Korsakov - Persian music in *Scheherazade*
- Ravel - Spanish music in *Alborada del Gracioso*
- Bernstein - Jazz in *West Side Story*
- Gershwin - Afro-Cuban music in *Cuban Overture*
- Lou Harrison - Gamelan in *Concerto for Violin and Percussion Orchestra*

Below are some examples of instruments that conjure the sounds of different cultures or styles. These are instruments native to these cultures or Western instruments that imitate native sounds.

- Jazz - drumset (with sticks or brushes), vibraphone
- Rock 'n' Roll - drumset
- Ragtime - drumset, xylophone, marimba, woodblocks, whistles
- Marching or military band - snare drum, bass drum, crash cymbals, triangle. (This is originally the sound of the Turkish Janissary bands, to which 18<sup>th</sup> century composers were making a reference when they used these instruments.)
- Afro-Cuban - claves, bongos, congas, timbales, cowbell, suspended cymbals, maracas, guiro, shakers, whistles
- Brazilian - shakers, pandeiro, quica, large drums, tamborim, whistles, triangle, agogo bells, snare drum
- African - djembe and other hand drums, shakers, cowbells, agogo bells, vocal percussion
- Spanish - tambourine, castanets, triangle, snare drum, bass drum, crash cymbals
- Middle East - riq, dumbek, frame drums, finger cymbals
- Balinese (gamelan) - tuned gongs, various semi-pitched metal instruments (pipes, cans, brake drums, etc.) in sets of about five to ten
- Chinese - different types of gongs, various drums (Chinese drums), wind chimes, temple bowls, temple blocks
- Indian - tabla (This instrument is not covered in this book because few percussionists are proficient with its use. Tabla require years of intense study to master. Some percussionists will have a limited tabla technique, but it is advisable that the composer avoid using this instrument unless a tabla player is available.)

# 3.

## beaters

### **To indicate or not to indicate?**

Unless the composer wishes to have a specific or unusual sound, beater choice is best left up to the performer. A description of the desired sound (e.g., “dark,” “heavy,” “warm,” “sharp,” “pointed,” “light”) rather than the mallet is the most accurate indication and allows the percussionist to make choices (mallet or otherwise) that produce exactly the sound the composer intends.

### **Beater lingo**

Often when specifying beaters, the instrument to be used is named. For example, instead of *plastic mallet* for use on xylophone, one might say *xylophone mallet* or instead of *felt mallet* for use on timpani, one might say *timpani mallet*.

“Stick,” “mallet,” and “beater” all mean, more or less, the same thing. The composer should not be too concerned with using the correct terms for the correct types of beaters; percussionists will always understand what is meant. Common uses of these terms are as follows:

A *stick* refers to a regular drum stick. A *mallet* is a stick with a head (e.g., timpani mallet, marimba mallet, bass drum mallet). One would not call a snare stick a *mallet* but might call a mallet a *stick*. For example, one would not say *drum mallet* when referring to a drum stick, but one might say *timpani stick* or *vibe stick*. *Beater* can be used for anything, but it is most commonly used for tam-tam, gong, bass drum, and triangle beaters. For triangle, it would be unusual to say anything but *triangle beater*. Again, this is not an important concern - mallet indications are never unclear because of an unusual use of the terms stick, mallet, or beater.

The different parts of sticks and mallets are defined as follows:

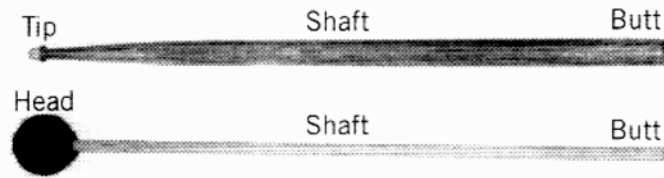

[Figure 3.1]

A typical drum stick has a thick shaft and a bead at the end. The bead (or *tip*) is usually made of wood but can sometimes be made of plastic. Mallets designed for use on keyboard instruments have thin shafts with a yarn, cord, rubber, wood, plastic, or brass head. Mallets designed for timpani have a thicker shaft (about the thickness of a drum stick) with a felt or wood head.

### Logistical beater issues

The composer must be aware that different instruments often require different beaters. When switching between two instruments, a percussionist may be forced to make a beater change and proper time must be allotted to do so. Determining the need and time for beater changes can be difficult so it is always best to consult a percussionist with a specific example.

Difficult beater changes will result in either a compromise of sound quality or a compromise of freedom of movement. Sound quality may be sacrificed if a percussionist does not have time to pick up the beater that will get the best sound out of an instrument (see Appendix C). Freedom of movement can be hindered if a percussionist is required to rush to get to the appropriate beater or hold the beaters in a less-than-ideal way. In these cases, the percussionist will be slightly handicapped and may not be able to perfectly execute a passage. Difficult beater changes can also create frantic motions or unwanted noise (see Visuals and Noise in General Logistics).

When calculating time for a mallet switch, the composer must factor in drop time as well as pick-up time. If the performer needs to drop four mallets and pick up another four mallets, this will take longer than if the performer is using his or her hands with no mallets and then has to pick up four mallets. In addition, it takes longer for a percussionist to pick up four mallets than to pick up two.

Some beaters are not appropriate for some instruments because they may damage the instrument (see Appendix C). Instrument damage is an especially important consideration; however, any beater can be used on any instrument without damage at extremely soft dynamics. At *pianississississimo*, even brass mallets on timpani are not damaging.

### Problems with extreme register

The use of a large bass drum or gong with other instruments in a setup may require some quick switches. The yarn mallets or sticks appropriate for a setup with, for example, marimba, toms, templeblocks, and cowbells will get a bright thin sound out of a large bass drum or tam-tam, and the mallets that produce a big full sound from a large bass drum or tam-tam are much too big for the other instruments. Since both the bass drum and tam-tam sound considerably different with a yarn mallet or stick than with their appropriate beater, it may be wise to allow a short time (maybe only a half of a second) to switch to a large beater before important bass drum or tam-tam notes.

A similar problem exists with five-octave marimba. On this instrument, the soft yarn mallets that are ideal for the bass of the instrument do not speak well at the top, and the hard mallets that work best at the top are too bright for the bass and can even break bars at loud dynamics. One remedy for this problem is the use of graduated mallets (e.g., from left to right: a soft mallet, two medium mallets, and a hard mallet, or some other combination). With graduated mallets one can use the appropriate



mallet to bring out the best colors of the entire range of the instrument; on the other hand, this mallet arrangement can create voicing and sticking problems. Most often, composers will just write without regard to these problems and leave it to the performer to figure out a combination of mallets to bring out the best colors from the instrument without disrupting the melodic and harmonic lines. If the composer wrote for a specific graduated mallet arrangement, it would tend to be more idiomatic and better sounding (see Steven Mackey's *See Ya Thursday*).

### Beater tricks

A percussionist can hold up to four beaters comfortably and with a lot of control. This technique can be of use when switching quickly back and forth between instruments. For example the player could hold one vibraphone and one crotale mallet in each hand at the same time (see Figure 3.2) thus allowing him or her to play two-mallet passages on both instruments.

Percussionists can, within reason, hold any combination of four mallets (e.g., a bass drum beater, two drum sticks, and a triangle beater). This opens up possibilities for using many instruments at once but significantly limits the use of each individual instrument.

Limited use of a triangle beater or other small beater in addition to four other mallets is awkward but possible. With more than four beaters, it is best to speak with the percussionist who is to perform the piece about the specific example. Some marimbists have actually become proficient in a limited six-mallet technique, but this is not widely used. It is best to never request more than four beaters at a time.

Gong beaters can be hung from the gong stand. This removes the need to pick up or drop the beater and also always keeps the beater in position to strike the instrument.

If necessary, a drum stick sound can be achieved with the butt end or shaft of a mallet. The butt and shaft of a felt mallet (timpani mallet) is much like that of a drum stick while keyboard mallet shafts are thinner and produce a lighter, brighter sound (see *The shaft and butt of beaters* later in this chapter).

Specialty sticks called *flip sticks*, *combo sticks*, or *two-headed sticks* are commonly available. Usually a drum stick is paired with a felt or yarn mallet so the player can flip the beaters over to create a totally different sound. Other specialty sticks exist but are not as common. Specialty sticks that are not readily available and that might have to be custom made are best used in solo or chamber pieces. In large ensemble situations where preparation time is not as abundant, it is best to request what is most common. Combo sticks should not be used in sets of four; it is very difficult, awkward, and time consuming to flip mallets over while holding a set of four. In this case, it would be more efficient to drop the mallets and pick up a new set.

At loud dynamics, the color differences between soft and hard beaters are far less noticeable. At soft dynamics, a yarn mallet and a drum stick will produce very different timbres from a tom-tom but at *forte*, these two different beaters have rather similar sounds. As a result, beater changes at loud dynamics may not be necessary.

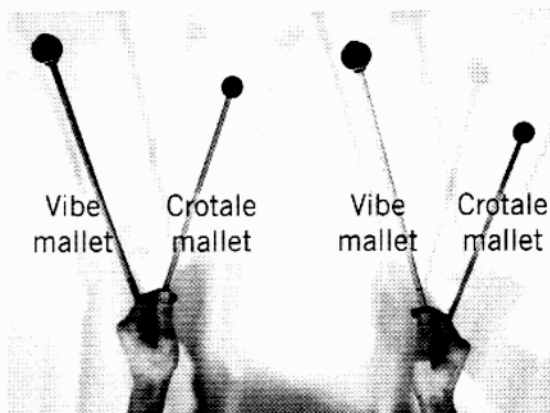

[Figure 3.2]

### The shaft and butt of beaters

The shaft or butt of a stick or mallet can be used for effects. The butt can be used everywhere, as can the head, but the shaft, for reasons of angle, can only be used in certain instances. In the case of bongos, congas, timpani, bass drum, and gongs, a large part of the shaft can be used and struck flat against the instrument; with other instruments, the shaft strikes at an angle and therefore is only striking a small portion of the instrument (see Figures 3.3a-g). Written instructions would be required to indicate the use of the shaft striking flat against the surface of an instrument; otherwise, an angled attack will be assumed. The following is a list of instances where the shaft of the mallet can be used successfully:

- on the edge of the bars of all keyboard mallet instruments except glockenspiel



- on the rim of all drums

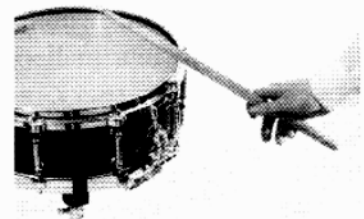

- flat across the head of bongos and congas (These instruments have sunken rims so the entire shaft of a stick can be struck flat against the head. On all other drums the rim would get in the way. This works with sticks and with mallets held upside down - not with mallets held normally.)



- flat on the head of timpani and bass drum (with drum sticks - not with mallets)

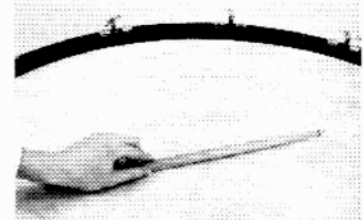

- on the edge and bell of cymbals



[Figures 3.3a. b. c. d. e. f]

- flat across the face of gongs (with drum sticks or with mallets held upside down - not with mallets held normally)

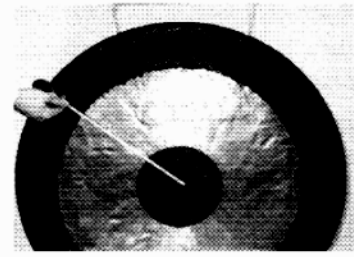

[Figure 3.3g]

- edge of gongs
- nipple of nipple gongs
- triangle
- Japanese temple bowls, mixing bowls, rice bowls
- cowbells, agogo bells, almglocken
- brake drums (with drum sticks or with mallets held upside down - not with mallets held normally)
- thundersheet
- woodblocks, templeblocks
- edge of tambourine, flat across the head of a tambourine
- machine castanets

The tip of a drum stick has a pointed and focused sound, the butt end has a much larger, darker, and fuller sound, and the sound of the shaft is larger still. The butt and shaft of a timpani mallet are far different than those of a keyboard mallet: the thick timpani mallet butt and shaft sounds like that of a drum stick while the thin keyboard mallet butt and shaft have a much smaller, brighter sound. Although mallet shafts come in a variety of materials (rattan, birch, maple, or fiberglass for keyboard mallets and wood [maple, hickory, etc.], bamboo, or graphite for timpani mallets), one can assume that the shaft sound will be with wood.

Again, requesting a switch to the butt ends of the beaters is not reasonable when the player is holding a set of four.

## Sticks



[Figure 3.4]

Sticks (also called *snare drum sticks*, *snare sticks*, or *drum sticks*) almost always have wooden tips. Plastic-tip sticks might be used in special instances to get thinner, higher sounds out of cymbals, gongs, and other metal instruments.

Drum sticks are not the only wooden sticks used. Timbale sticks are straight dowels with no tip and are often thinner than snare sticks. Much smaller wooden sticks like chopsticks and even wooden barbecue skewers can be used for delicate instruments or for brighter sounds.

### Mallets

Yarn, cord, rubber, plastic, and felt mallets come in a variety of hardnesses. Yarn is most commonly used on marimba, cord on vibraphone, rubber on marimba and xylophone, plastic on xylophone, glockenspiel, and crotales, and felt on timpani (see Appendix C). For soft rolled passages, a softer mallet is best. For faster articulated rhythms, a harder mallet is best. Again, these decisions are often best left up to the performer.

Yarn and felt mallets have a soft outer layer. These mallets will sound softer and less articulate at soft dynamics and harder and more articulate at loud dynamics. This is a very subtle color difference. Cord, rubber, and plastic mallets are more or less the same color throughout the dynamic range. Often percussionists make use of a special yarn mallet, called a *two-toned* mallet, which is very soft at soft dynamics and very hard at loud dynamics. This can give the performer a great variety of color from just one mallet but the color difference is dependent on dynamics.

Brass and wood mallets should be assumed to be available in one hardness. It is technically possible to find mallets of metal or wood with slightly different hardness (depending on the material, density, etc.), but it would be very strange to request a soft pair and a hard pair of brass mallets.

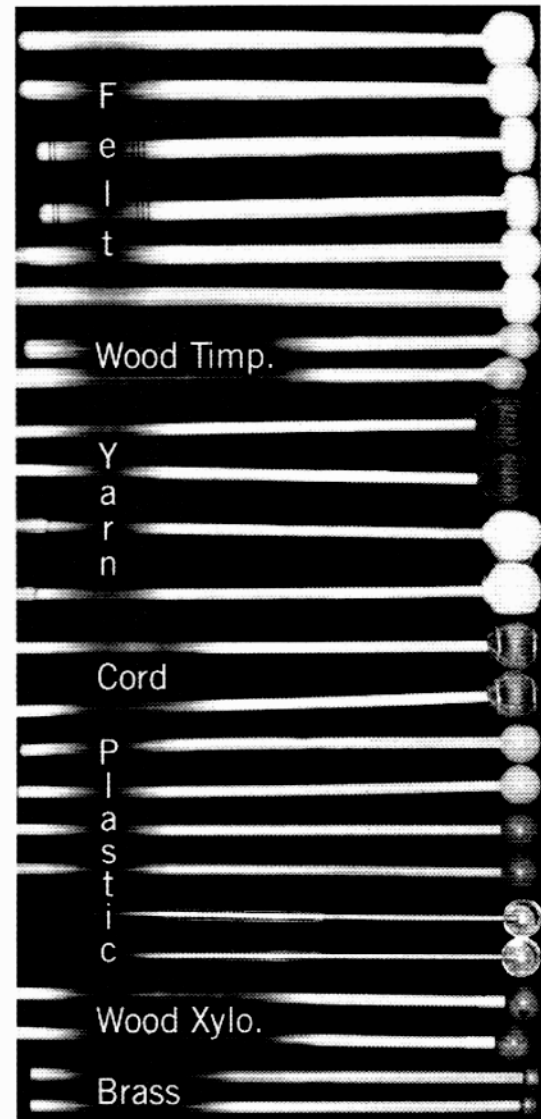

[Figure 3.5]

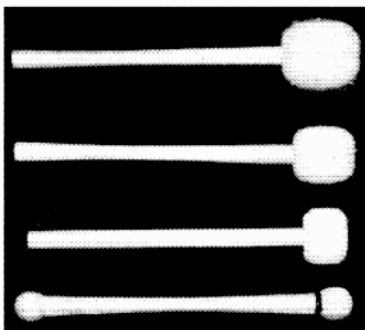

[Figure 3.6]

A bass drum beater is essentially an overgrown timpani mallet. They are wrapped in felt and come in a variety of hardnesses. Most often, just one mallet is used, but a pair can be used for rolls or faster passages that require two hands. Soft two-headed bass drum beaters exist (not pictured) and can be used to play rolls with one hand by striking the drum with alternating ends of the beater.

Gong beaters are about the size of bass drum mallets but are heavier and usually wrapped with yarn instead of felt. They come in a variety of sizes for different sized gongs.

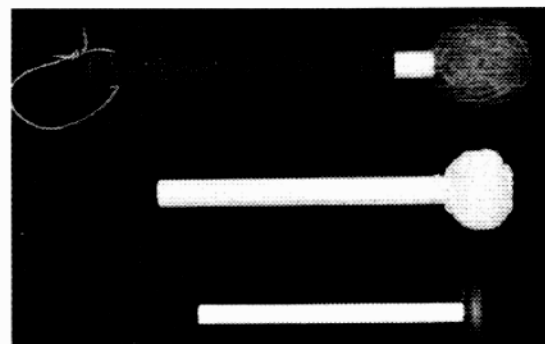

[Figure 3.7]

Slap mallets have a relatively large flat surface made of leather which creates a loud contact sound. These are used for special effects. Operating a set of four slap mallets is especially awkward; they are best used in pairs.

### Triangle beaters, knitting needles

Triangle beaters are small metal rods. They come in a variety of thicknesses. Besides their obvious use on triangle, triangle beaters are good for getting very high pitches out of cymbals and gongs. Triangle beaters are also perfect for scraping cymbals, gongs, and bell trees.

When a very light metal beater sound is needed, knitting needles work well. Knitting needles do not sound very good on triangle but are great for producing delicate bright sounds from cymbals and gongs.

### Brushes

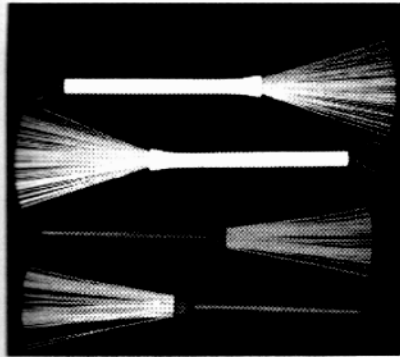

[Figure 3.8]

Brushes are made with metal wire or plastic. Light wire brushes are most common. Plastic brushes are usually heavier and louder. Heavy wire brushes called *rakes* are even louder and heavier than plastic.

Brushes can be used for a single stroke or a scrape. A scrape with a brush is not like a scrape with a triangle beater; it is more like a paint brush stroke. Brush scrapes are best used on drums and at soft dynamics on cymbals and gongs. A brush scrape is a one-handed operation and can be executed while the other hand does something else. By scraping in a circular motion around

the instrument, the performer can create this effect for as long as needed. A scrape is notated by writing "scrape" or with a special symbol above the note.

= stroke  
 = scrape

or

sc = scrape

SC      SC      SC      SC

[Figure 3.9]

A tremolo with brushes is a normal single-stroke tremolo in which the brushes strike the drum. If a scrape tremolo is desired (rapidly scraping back and forth), the composer should indicate this by writing "scrape tremolo." A scrape tremolo can be executed with one hand while a normal tremolo requires two. A normal tremolo can get much louder than a scrape tremolo.

On keyboard instruments, brushes will strike not one but a few notes. The composer should expect that a target pitch will be accompanied by the surrounding notes.

Brushes speak at a rather soft dynamic. Scrapes and even regular strokes cannot be nearly as loud as similar attacks played with sticks. When especially loud dynamics are required on drums, percussionists can compensate by playing rimshots (see Drums). Volume can also be increased by using thicker plastic brushes or heavy wire rakes. For loud scrapes on cymbals and gongs, a triangle beater or coin is more appropriate.

As a result of their dynamic limitation, brushes can be perfect for involved soft playing. With very fast multi-percussion passages, especially soft playing can be very difficult with sticks, and brushes may work far better. A rute is another softer alternative to sticks (see **Rute** below).

The butt end of brushes is usually a thick metal wire that can be used for all triangle beater purposes.

### Chime hammers

Chime hammers are made of rawhide or plastic. Percussionists usually pad one side so one hammer can be flipped around to act as both a hard and soft beater. Chime hammers are best used in pairs; maneuvering a set of four hammers is very awkward, difficult, and ineffective. Four mallet passages on chimes are more effectively executed with regular plastic or yarn mallets; these beaters will of course sound considerably different than chime hammers.



[Figure 3.10]

### Rute

A rute is a bunch of wooden dowels or twigs tied together. Traditionally (see Mahler's Symphony No. 2, third movement), the rute is rather large and struck on the shell of the bass drum, producing more of the sound of the rute than of the shell. This instrument has now been adapted to the size of a snare stick and can be used as a beater for a special effect on drums, cymbals, and other instruments. These smaller rutes were originally made for softer drumset playing (for low volume ensembles and practice). Both rute types are available.



[Figure 3.11]

### Hands

Playing with the hands is most common on drums (see **Drums** for details on hand drum techniques). On other instruments, hands can be used for special effects or if there is not enough time to pick up sticks. For example, if a percussionist is playing a set of drums with hands and needs to hit a suspended cymbal or a wood block, using the hands or fingers may be more reasonable than picking up a stick or mallet. Hands cannot usually play as loud as sticks or mallets.

Some hand playing techniques include:

- using flat hand, fist, heel of hand, flat fingers, fingertips, fingernails, and knuckles
- playing rhythms in one hand by alternating back and forth between the thumb and fingers or by alternating between fingers and heel of hand
- friction roll (rubbing a finger against the instrument to create a type of roll) - see **Friction Roll** in **Miscellaneous Instruments**
- scraping the finger nails or flesh of the hand against the instrument
- putting something on the fingers such as thimbles or special leather or felt gloves (see William Kraft's *Concerto for Timpani*)

### Sticks as instruments

Sticks and mallets can be struck together for a clave-like effect.

# 4.

## tone color

*Tone color* (or timbre) is the perceived sound that results from the prominence of certain overtones (partials) over others. These arrangements of overtones are what give each instrument its unique color.

Timbre can be described in an infinite number of ways: warm, sharp, green, sweet, dirty, etc. For the purpose of this explanation, timbre will be described only as “bright” or “dark,” i.e., more or less prominent higher overtones.

The larger the instrument, the wider the range of timbres. Just as the cello can play much lower than a violin and can also, under special conditions, produce pitches in the violin’s highest range, larger percussion instruments, like bass drum and tam-tam, can sound very low and dark and also, under special conditions, very high and bright.

With many unpitched percussion instruments (most notably metal instruments), the fundamental is not heard at all - the sound is all overtones. In these cases, a change in timbre will result in a change of the perceived pitch of the instrument.

### **Factors that affect tone color**

Timbre can be altered through dynamics, beater choice, placement of attack, and muting.

#### **Dynamics**

louder dynamic = brighter  
softer dynamic = darker

For example, when one rolls on a cymbal or tam-tam, the pitch will become higher as the dynamic grows and vice versa. With sirens, the pitch will become higher as one blows or cranks harder. With guiro, the pitch will be higher as one scrapes faster and harder. With marimba, the sound will be sharper as one strikes the bar more loudly. The higher overtones are brought out as the dynamic increases.

#### **Beaters**

smaller and/or harder beaters = brighter  
larger and/or softer beaters = darker

Especially on larger instruments, a large soft mallet will have a big dark sound while a small hard mallet will sound very small and bright. For example, a tam-tam struck with a triangle beater will produce pitches octaves above the pitches produced with a large tam-tam beater.<sup>1</sup> Similarly, in hand drumming, the use of one finger will produce a much brighter sound than the use of the whole hand.

1. Technically, the dark sound produced with a tam-tam beater contains all of the high overtones the triangle beater produces, but these overtones are fused into the sound of the low fundamental pitches. The triangle beater produces the overtones exclusively.

**Placement of attack**

When striking closer to the part of the instrument that vibrates the least, the sound will be brighter than the part of the instrument that vibrates the most (similar to a *sul ponticello* versus *sul tasto* effect on string instruments<sup>2</sup>). Specifically:

- on drums and gongs:
  - towards the edge = brighter
  - towards the center = darker
- on mallet instruments:
  - towards the node = brighter
  - towards the center = darker
- on cymbals and crotales:
  - towards the bell/center = brighter
  - towards the edge = darker
- on cowbell:
  - towards the closed end = brighter
  - towards the open bell = darker

**Muting**

If an instrument is muted while it is struck, the instrument will sound drier and more articulate. The larger and heavier the mute, the more muffling power it has. Placement of the mute will affect the sound in the opposite way that placement of the beating spot does (as described above). For example:

- on drums and gongs:
  - mute towards the edge = darker
  - mute towards the center = brighter

If an instrument is dampened slightly after it is struck, then the timbre of the ring is affected. For example, lower pitches can be taken out of the sound of a resonating tam-tam if the center of the instrument is dampened slightly. This will make the higher overtones more apparent.

Light dampening with a piece of cloth is often used to make drums drier and darker and to clear up soft articulate passages on timpani and other large resonant drums. Heavy dampening is commonly used with pedal bass drums; towels, sheets, or something similar is often inserted into the drum, giving it a full but punchy sound.

2. There may be some debate about the sound of *sul ponticello* actually being “bright” versus the “bright” sound of *sul tasto*. The *sul ponticello* effect on string instruments is the same as placement-of-attack effects on percussion instruments in that the bridge of a string instrument is a nodal point of the string (a place where it does not resonate) like the edge of a drum. In both cases, the sound becomes brighter when the resonating body (string or drum head) is attacked closer to this nodal point. However, additional effects on sound are created through proximity to the resonating chamber. The closer the point of attack is to the resonating chamber, the more support the fundamental pitches receive; this results in a darker and louder sound. If the point of attack is away from the resonating chamber, the sound will be quieter and brighter. In the case of a drum, cymbal, or tam-tam, the resonating chamber remains constant when the beating spot changes; in the case of marimba and vibraphone bars, the resonating chamber has most effect in the darkest part of the bar (the center) so those effects compliment each other. With string instruments, the resonating chamber is under the bridge so while those higher overtones are scratched out, the sound remains dark as a result of the support the fundamental pitches receive from the instrument’s cavity. With *sul tasto*, the attack occurs towards the center of the string where it resonates most freely and the sound is darker, but it is far from the instrument’s resonating chamber, which results in a bright wispy sound. (In addition, many of these sound effects are enhanced with changes of bow speed and pressure. For the purpose of this description, those additional factors, just as the additional factors in percussion - dynamic, beater, and muting variations - should be assumed to be constant.)

For string instruments, *sul ponticello* and *sul tasto* are both bright and dark for different reasons. It is the proximity to the bridge, not to the resonating chamber, with which the above analogy is made.



### **Unpitched instruments (indeterminately pitched instruments)**

Many percussion instruments are referred to as *unpitched*, although the concept of an unpitched instrument is not altogether accurate. Every sound does in fact have pitch - even a stomp on the floor. The acoustic effect that allows composers and percussionists to use these instruments without regard to their pitch is that the overtones the instrument produces are not in tune with the fundamental pitch (they are not integer multiples of the fundamental). These out-of-tune overtones do not fuse together in one's perception as they would on "pitched" instruments and instead distort one's ability to identify the fundamental pitch. This creates the effect referred to as "non-pitch"; however, it would perhaps be more correct to call these sounds *indeterminately pitched*.

In an ensemble, blend is paramount to what is considered a "good sound." Since pitch is an important part of what makes sounds blend together, using unpitched instruments in the context of a pitched ensemble can be very challenging. Good percussionists will strive for blend and will make choices appropriately, but the composer must still take special care to ensure that blend is even possible.

The role of unpitched percussion in an ensemble can be that of a solo line, a rhythmic support, or a coloristic addition. As a solo line, these instruments are meant to be heard as a separate entity and blend is less important. A rhythmic or motoric role is the most traditional and basic style of percussion writing, and pitches will tend to be ignored in favor of the rhythmic function. With coloristic percussion writing, the percussion sounds serve to color existing sounds in the ensemble; here, blend is most important.

The elements of blend are dynamics, articulation, and pitch. With clarinet, for example, these elements can be prescribed with predictable results. With percussion, it is not as simple. Dynamics can be accurately controlled; the composer can determine the proper dynamic for a particular instrument at a particular point in the piece, and the percussionist will predictably interpret the dynamic marking with respect to the instrument, musical passage, hall, and ensemble. Articulation can also be assigned with confidence; it can be controlled with instrument choice (e.g., the natural articulation of a vibraslap versus that of a wind gong) and with dynamics, note length, and beater choice. Pitch, on the other hand, is a considerable gray area.

Some composers avoid this complication and write almost exclusively for pitched percussion (see Boulez's *Sur Incises*). This is a safer route but leaves far fewer color possibilities. Although pitch is an unreliable blend element with unpitched percussion, the composer can compensate with careful choices of articulation and dynamics. The composer must have a very clear understanding of the sound characteristics of each instrument available and how those sounds relate to an ensemble. Many great examples can be found in the scores listed in **Appendix E**, and study of these works will be very valuable to the composer who seeks perfect coloristic percussion additions.

With music that predominantly features percussion and especially in solo percussion pieces, the pitches of the instruments can have a significant effect on the end musical result. These pitch choices are commonly left entirely up to the performer, and the composer simply concedes that pitch will be an indeterminate part of the composition. In some rare cases, pitch or pitch relation is prescribed by the composer. Louis Andriessen calls for specifically pitched woodblocks and templeblocks to accompany the marimba in *Woodpecker*. This piece is, as a result, rarely performed because the instruments are very difficult to acquire. Steve Reich asks for pitched claves for his *Music for Pieces of Wood*. Finding or making properly tuned claves is difficult but is far easier than tuned woodblocks and templeblocks. In *Zyklus*, Karlheinz Stockhausen requests four tom-toms, four cowbells, and two log drums (with two pitches each) to sound at pitches within a specific scale "if possible." With drums, the pitches can be easily realized (although they will not be especially apparent), and pitched almglocken can be used for the cowbells; finding properly pitched log drums, however, is very difficult and would require much trial and error.

### Timbral specifics of cymbals and tam-tams

Soon after a cymbal or tam-tam is struck, the dynamic and pitch spectrum peak and then slowly die. In Figure 4.1, *a* is the point of attack and *b* is the peak of the instrument's sound which occurs just a fraction of a second after *a*.

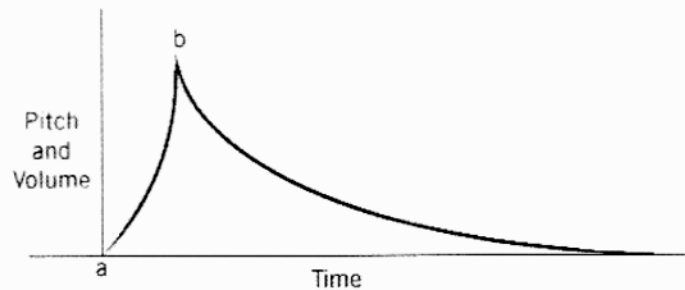

[Figure 4.1]

The shape of this curve is dependent on the size and thickness of the cymbal or tam-tam, the dynamic at which it is struck, and the beater with which it is struck:

- thicker and larger = late crest and long decay
- thinner and smaller = quick crest and short decay
- softer dynamics = late crest
- louder dynamics = quick crest
- larger and softer beater = late crest
- smaller and harder beater = quick crest

This curve happens quickly after the cymbal is struck, but it can be elongated and controlled with rolls.

Thicker cymbals and tam-tams are brighter, and thinner cymbals and tam-tams are darker. This is especially apparent at soft dynamics.

### Miscellaneous timbral effects

If a hi-hat is slowly closed while rolling softly on the top cymbal with sticks, the pitches of the overtones will become gradually lower as the cymbals become closer to each other. This is a very subtle and quiet effect used with amplification in Peter Eötvös's *Shadows* and with Chinese hand cymbals in Lei Liang's *Dialectal Percussions*.

Take a plastic foot-long ruler and hold it with one hand against the top of a flat table so most of it hangs off the edge. With the other hand, spring the free end of the ruler into motion so that it bounces up and down. Now gradually slide the whole ruler onto the table. The pitch rises as more of the ruler is on the table. This effect is used in Jacob Druckman's *Aureole*, where the shaft of a mallet on a conga is treated the same way as the ruler on the table.

When the edge of an instrument is struck with the shaft of a stick or mallet, the timbre is brighter when striking towards the tip of the stick than when striking towards the hand that is holding it. This can be observed with a pencil by striking the edge of a table at different points on the pencil's shaft.

# 5.

# drums

Instruments covered in this chapter are: timpani, tom-toms, snare drum, field drum, tenor drum, timbales, roto-toms, bongos, congas, tamborim, frame drum, djembe, dumbek, bass drum, and drumset. Parts of these instruments are defined as follows:

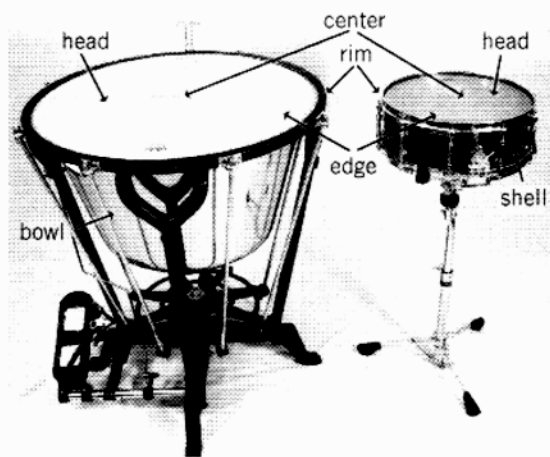

[Figure 5.1]

There are three main categories of techniques that can be used to play all drums: techniques unique to snare sticks (derived from snare drum and drumset playing), techniques unique to mallets (derived from timpani playing), and techniques derived from hand drumming.

## Sticks on drums

Drum sticks can be used on all drums, but they are less appropriate on timpani and certain hand drums (such as frame drum, djembe, and dumbek) as they can damage the drum head. The buzz roll, specific to drum sticks, has already been explained in **General Notation**.

A *rimshot* is executed by holding one stick down with the tip touching the center of the head and the shaft touching the rim and then striking it with the other stick. This takes half of a second to get into position, and only rhythms slow enough to be executed with one hand are possible.



[Figure 5.2]

A rimshot can also be created by striking the drum with one stick at an angle to hit both the head and the rim simultaneously. This produces a slightly different sound, requires no preparation time, and makes two-handed passages possible. This rimshot, however, is more difficult to execute consistently.

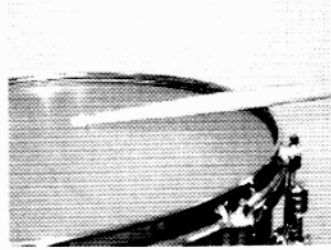

[Figure 5.3]

The specification of which type of rimshot used is rarely notated and is usually decided by the performer based on the passage.

A common abbreviation for rimshot is "R.S.," but as with all abbreviations, the first appearance in a part should be written out in full. Rimshots can damage timpani and generally should not be requested on that instrument. Rimshots are most naturally and almost always executed at a loud dynamic.

A *rim-click* (also called *side-stick* or *cross-stick*) is a technique often found in drumset playing whereby one end of the stick is held against the center of the head and the shaft strikes the rim. This takes about half of a second to get into position.



[Figure 5.4]

On drums smaller than 10 inches (bongos, small toms, small roto-toms), a rim click is ineffective because the stick is too long.

Rimshot and rim-click rolls are an unreasonable request. Very fast articulations are possible with the one-handed rimshot (the second of the two described above), but the sound produced is so sharp that the articulations will not blend together to create a roll effect. Rolls with the two-handed rimshot and rim-click are awkward and will not work.

Some basic drum jargon: a note with one grace note is called a *flam*, two grace notes is a *drag* or *ruff*, and three is a *four stroke ruff*.



[Figure 5.5]

Execution of these ornaments can vary. The composer should expect that percussionists will try to execute the ornament so each note is clear. If a big, fat, closed ornament is desired where many articulations (not just two or three) are crushed out by one hand before the main note, this notation (Figure 5.6) is appropriate.

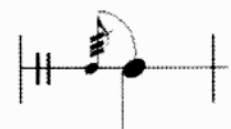

[Figure 5.6]

A French flam, found in some older French snare drum writing, is notated as a note with two stems (see Figure 5.7). This is played with both sticks striking almost simultaneously. It is not commonly found in modern scores.

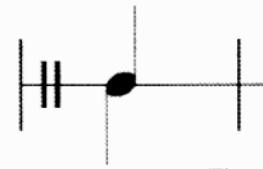

[Figure 5.7]

### Mallets on drums

Unique to the use of mallets on drums is the sound of rolls. Single-stroke rolls are used instead of buzz rolls, and at softer dynamics on resonant instruments (like timpani and bass drum) they can create a seamless sustaining sound.

### Hands on drums

The use of the hands is more common on some drums than others but is appropriate for all drums. Since so many different sounds can be produced with the hands, hand drumming notation can become very complicated. Hand drumming is traditionally an improvised art, so the best notation may be just the rhythm and dynamics with instructions to improvise different sounds; the performer will use these indications to design the best sounding and most idiomatic articulations.

More detailed notation will vary from instrument to instrument as each hand drum has its own unique techniques. These techniques all derive from a few basic sound concepts (see **Tone Color** for more):

- Using more surface of the hand will produce a lower pitch and a darker sound, and using less surface will produce a higher brighter sound.
- Playing towards the center of the drum will produce a lower pitch and a darker sound, and playing towards the rim of the drum will produce a higher brighter sound.
- Muffling the drum head with the other hand towards the center will shorten the note and cut out some lower pitches, making the sound brighter.
- Pushing on the head with the fingers, hand, or elbow will stretch the head and raise the pitch.

For example, if one strikes a djembe in the center of its head with an open palm, a low sustained fundamental pitch will result. If one strikes directly on the edge with just one finger while dampening the drum head with the other hand, a bright sharp sound will result.

At least two pitches can be produced on all drums when hands are used: a low pitch, usually the fundamental, and a high pitch played at the edge of the drum. These two pitches can be referred to as the *bass tone* (or *dum*) and the *rim tone* (or *tak* or *tek*); the syllables *dum* and *tak* are used in South Asian drumming traditions and have been adapted and applied to many other drums and playing styles. Big deep drums like djembe or conga have three main pitches: the bass tone, rim tone, and a stroke simply called *tone* which is a harmonic pitched about an octave above the fundamental and beneath the rim tone.

A *slap* can be executed on all drums. It is a high pitched accented sound which is achieved with a dead stroke towards the center of the drum. A slap is sometimes left to ring (called an *open slap*), in which case the attack is not a dead stroke but produces the same accented bright sound. In conga and djembe playing, the bass, tone, and slap sounds are used primarily, and the rim tone is only used occasionally.

Notation of these pitches does not need to be any more complicated than “high and low” or “high, medium, and low.” In these cases, the specific techniques used to execute the high/medium/low pitches will be determined by the performer.

Sound and note length can be controlled with open and muffled strokes. With a muffled stroke, the hand stays on the head after striking to muffle the sound (like a dead stroke). To muffle a rim tone, the percussionist needs to muffle with the other hand; the rim tone is executed at the very edge of the drum so the striking fingers, if left on the head, would not cover enough of the head to dampen it. Bass, tone, and slap sounds are executed towards the center of the drum so one can muffle with the striking hand. Closed and open tones can be notated on additional lines or with +’s and o’s.

A rub with the hand or fingernails can be used. This is executed by wiping the hand back and forth across the head in rhythm. The flesh of the hand is used for a softer, darker sound or the fingernails for a louder, brighter sound.

When the head is dampened while playing rim tones, the pitch can be altered by moving the dampening hand across the head toward the striking hand. The pitch of the overtones will become higher as the dampening hand gets closer to the striking hand and lower as the dampening hand moves further away.

A friction roll can be used as a long tone or rhythmically (see **Friction Roll** in **Miscellaneous Instruments**).

See the section on hands in **Beaters** for more effects. For more information on hand drumming, listen to Indian, Middle Eastern, African, and Afro-Cuban music.

### **Playing on the rim or shell**

The rim of a drum can be struck with the shaft of a stick. The head of the drum will resonate slightly, but this will not be especially audible. If one changes the drum pitch, the pitch of the rim sound will not change significantly. Rim pitch is relative to the drum size: smaller = higher, larger = lower.

The shell can also be struck for a similar effect. This is common in timbale playing where bell patterns are played on the metal shell of the drum. Except at loud dynamics, it is best not to request passages that require two sticks on one surface of the shell of a drum; the playing surface is vertical so it is difficult to achieve consistent playing positions with the two hands. It is more reasonable to have each stick play on opposite sides of the drum shell (or on two different shells); the two sounds will be slightly different and should be treated as such. If soft passages that require two hands are requested on the shell of a drum, then the performer may use an additional drum turned on its side so that the shell faces upward and both sticks can easily strike the same surface.

See **Striking the Bowl** in **Timpani Extended Technique** later in this chapter.

### **Placement on the head**

As described earlier, different places on a drum head will sound considerably different; the center has a thumpy dark sound and the edge has a pingy bright sound.

The center of a drum head will sound especially dead if the bottom of the drum is sealed off. On timpani, the bowl has only a small opening at the bottom so the center of a timpano head sounds especially dead and thumpy. With other drums where the bottom is open or covered with another head, the center sound is more resonant.

To notate the beating spot, one can use letters - “C” for center and “E” for edge - or different lines on the staff. On timpani, about a third of the way in from the edge is called the *normal* beating spot, which could be notated “N.” For other drums, the *normal* beating spot is the same as the *center* because the difference in timbre from edge to center is not as apparent as it is on timpani. When a passage travels gradually from one beating spot to another, a dotted line or arrow can be used.

These notations should be explained at the beginning of the score and part. (See Elliott Carter's *Eight Pieces for Four Timpani*, Bartók's *Sonata for Two Pianos and Percussion*, second movement, Cage's *Third Construction*.)

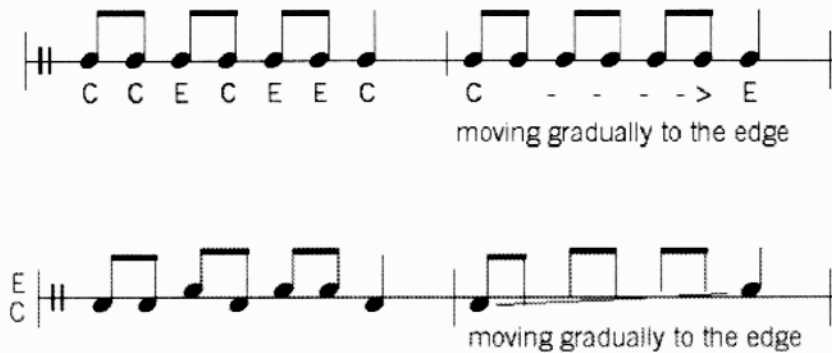

[Figure 5.8]

After it has been written out the first time, the text “moving gradually to the edge” will be understood and only the dotted line or glissando indication is necessary.

**Mutes** - see General Notation and Tone Color

### Drum size

Indication of drum size is notated “small,” “medium small,” “large,” etc.; dimensions are unnecessary. Requesting an approximate pitch or pitch range is appropriate for a more specific indication.

### Two-headed drums

Some drums have two heads. In most cases, only one of the heads is struck - the other just resonates sympathetically. Both heads are used in certain ethnic drumming and on bass drums in marching bands, but in most Western music it is not necessary or practical to strike both heads. On rare occasions, it is more convenient to use two heads, but this should be the choice of the performer.

### Pitch bending

The pitch of all drums can be manipulated by pressing on the head with an elbow, fist, finger, or stick. Pushing on the head stretches it to raise the pitch. This also dampens the head.

A drum sound will often naturally have a slight pitch bend. When the drum is struck loudly, the force of the stick will push on the head so that post-attack the head will quickly relax back into position and produce a small downward glissando. This is most apparent on drums with looser heads, played at loud dynamics.

The pitch of a drum can be lowered by covering the head as it resonates. If a wooden board (or something similar) is brought close to but not necessarily touching the head of a drum, the pitch will lower. The closer the board is and the more of the surface of the head it covers, the lower the pitch. This is especially effective on larger resonant drums like timpani. Since frame drums are held instead of mounted on a stand, one can achieve this effect by moving the instrument toward a surface like the floor, a table, or even the player's knee. These techniques dampen the head.

Timpani and roto-toms have mechanisms that bend the pitch (see *Types of Drums*).

### Multiple drums in setups

When using multiple drums together in a setup, one needs to consider pitch, dynamic, and timbral relationships. It may be best not to specify each drum type, for example one may notate “seven graduated drums” instead of naming each of the seven drums. This will allow the performer to find drum combinations that sound best, given the available instruments.

Drum pitch relationships are as follows:

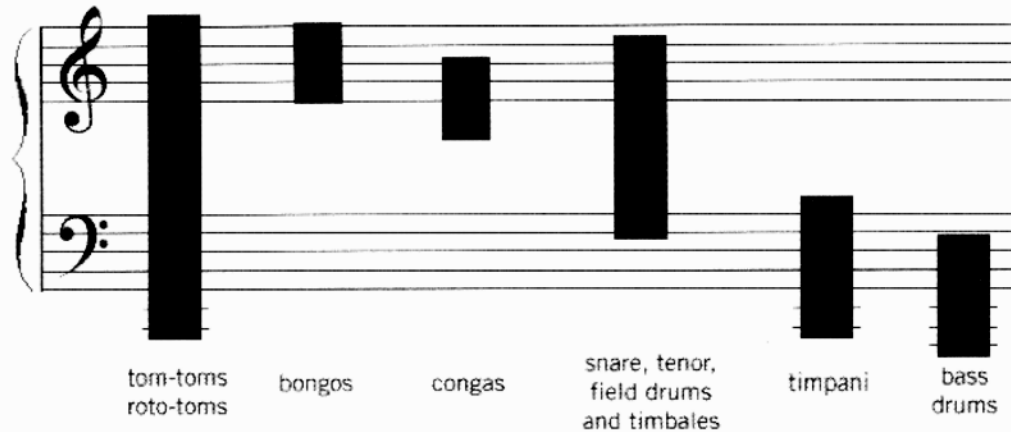

[Figure 5.9]

These are the most common pitch relationships, but drums can be tuned unusually if necessary. Timpani are almost always written with specific pitches, roto-toms are usually used as pitched instruments, and all these other drums are primarily used without pitch specification. Figure 5.9 shows approximate pitch ranges and should not be taken too literally.

Drums with deeper shells will typically be louder than those with shallower shells. For example, a large tom-tom can get much louder than a large roto-tom (roto-toms have no shell - see Figure 5.21).

Plastic-headed drums and calf-headed drums have slightly different timbres. Generally, it can be assumed that bongos and congas will have calf heads and all other drums will have plastic heads, although this can vary with the percussionist’s personal preference. Calf heads have a rounder sound with not as bright an attack; plastic heads give the attack more of a pop or crack. When used together in a setup, these different sounds may be apparent, especially at soft dynamics with snare drum sticks. This is a minor issue - bongos, congas, and other drums are frequently and successfully used together - but it should be noted that if the percussionist is using snare sticks and playing soft melodic passages between calf and plastic-headed drums, smooth phrasing may be difficult.

### Idiomatic writing for drums

It is very easy to visualize exactly what a percussionist must do to play passages on drums, and it is therefore relatively easy to write idiomatically for a set of drums. Once the composer decides how the drums are to be set up, he or she can “air drum” passages to see if they lay well. The composer could even set up objects like pillows or plates to try out passages.

As mentioned in **General Notation**, most percussionists are experienced with improvising on unpitched instruments. Instead of a completely written out drum part, just the rhythm, dynamics, and shape of the figures may be all that is necessary to get the correct feel (see Figure 2.24). This guarantees an idiomatic part.



Many percussionists who do not regularly play drumset are less proficient with complicated foot pedal work, so the composer may want to keep pedal bass drum passages relatively idiomatic. Pedal passages are far easier when the bass drum (or other pedal instrument) is doubled by a hand stroke or written as a steady rhythm. In Figure 5.10, (a) is more difficult than (b) or (c).

(a)  $\text{♩} = 112$   
4 toms  
bass drum

(b)  $\text{♩} = 112$   
4 toms  
bass drum

(c)  $\text{♩} = 112$   
4 toms  
bass drum

[Figure 5.10]

Also, when using a pedal, control over dynamics is not nearly as strong as when using hand-held beaters so dynamically sensitive passages should be written with caution.

## Types of drums

### Timpani

*Timpani* is plural; *timpano* is singular. Timpani are notated in bass clef.

A set of four drums is most common: I 32-30 inches, II 29-28 inches, III 26-25 inches, IV 24-23 inches (I is the lowest). A fifth (V 22-20 inches) piccolo timpano is also very common. Sometimes another combination of these drums (e.g., two II drums, a III, two IV's, and a V) or additional drums could be used if they are available. It is always best, however, to write for a standard set of four drums.

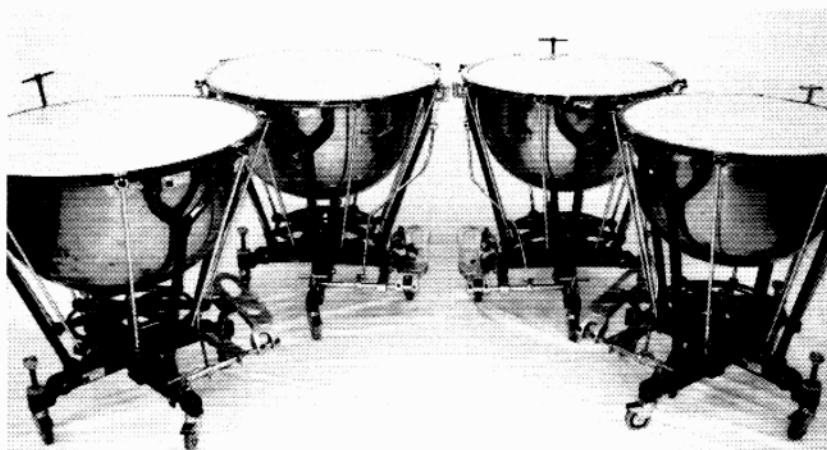

[Figure 5.11]

## Ranges

The overall range of timpani is:



[Figure 5.12]

Individually, the drum ranges are as follows:

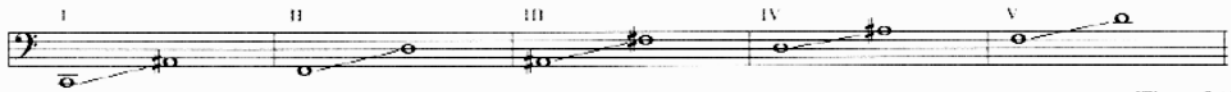

[Figure 5.13]

The top half-step in each case is a stretch. These notes will sometimes sound choked, depending on the quality of the instruments.

The lowest range of each of the drums will sound tubbier and the pitch will be less clear. On the other hand, these pitches will be more resonant in soft playing. The choice to put pitches on the lower range of a particular drum should be the decision of the performer based on the specific instruments available. These low ranges are:



[Figure 5.14]

There are three conditions under which the composer should consider the individual ranges: when writing a part with fixed pitches, when writing for just a few drums, and when dealing with glissandi. For fixed pitches, it is best if those pitches fit well into the ranges of the drums (e.g., if G, A, B, C is requested on a standard set of drums, the pitches will not sound best). If only a few drums are used (in a setup with other instruments or if there is a constraint on space), the composer should decide which drums he or she will use and write only for pitches in those drums' ranges. Glissandi should happen within the range of one drum. For example, a glissando from low G to high F# will not work; it must be split up.

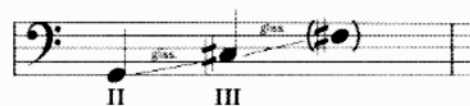

[Figure 5.15]

To smooth this out, the notes could be rolled to cover the points where drum change is needed (Figure 5.16a), or the note could be only partially reached with a glissando and then struck (Figure 5.16b).

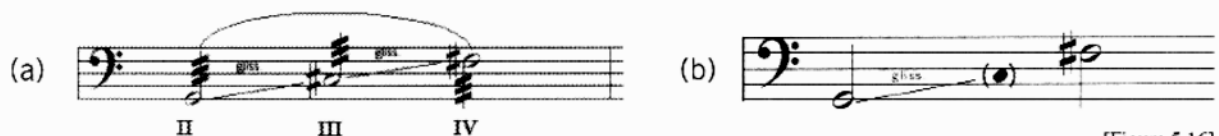

[Figure 5.16]

If the pitches are constantly changing, the composer does not need to be concerned with the range of the individual drums. The timpanist will determine which drums to use and on which drums to put pitches. A tuning plan - a guide to where and when to change pitches on drums - should not be provided by the composer. A tuning plan can vary depending on availability of drums and player preference. An already existing tuning plan will most often just get in the way of the player's own plan.

In very rare cases, timpani range is extended far upward. Roto-toms or bongos are often used for these high pitches since timpani small enough are not available (see Milhaud's *Creation du Monde*, Strauss' *Salome's Dance*, Ravel's *L'Enfant et les Sortilèges*). The use of these extreme ranges should be avoided.

The lowest possible note of a particular drum can be notated with a downward arrow notehead. At this point, the drum head will be very slack and have little to no recognizable pitch. This notation should be explained in the score and part.

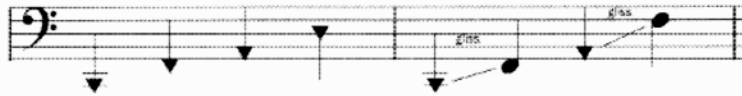

[Figure 5.17]

Two drums can be tuned to the same pitch for added volume. Although two different drums that are tuned to the same pitch will have much different sound quality, this will not be noticed at a very loud dynamic. Occasionally, composers call for two mallets to strike one drum simultaneously for loud notes. Although the two mallets do not produce much more sound than one, it is a nice visual effect. The reader should remember that one drum hit with one mallet can still be quite loud.

### Changing pitch

Melodic capabilities on timpani are limited but not as limited as one may think; complex pedaling is difficult but very possible. Charles Wuorinen's *Bassoon Variations* takes timpani to its melodic limit. The average Bartók timpani part (*Sonata for Two Pianos and Percussion*, *Piano Concerto No. 2*, and *Violin Concerto No. 2*) is a good example of melodic capabilities within reason.

When pedaling extensively, the player will have to sit down on a stool in order to operate two pedals at once. This should be taken into account when composing for a setup that includes timpani with other instruments. If the player is standing to play other instruments in a setup and then needs to sit for an involved timpani passage, some time should be allotted for the player to get into position on the stool.

Specific pitches do not necessarily need to be notated for quick articulations between the first and last pitches of a glissando. Note stems attached to the glissando line can indicate rhythm.



[Figure 5.18]

When the final note of a glissando is not reattacked, it should be written as a small grace note or as a note in parentheses. A slur is often used for this purpose, but timpanists will sometimes reattack the second of two slurred notes; the grace note and parentheses indications are less ambiguous.



[Figure 5.19]

### Multiple timpanists

Multiple timpanists are useful when many pitches are needed. This was especially true in the 19<sup>th</sup> century when quick pitch changes were not possible (see Mahler's Symphonies, Berlioz's *Symphony Fantastique* and *Requiem* [16 timpani!]). With modern timpani, multiple timpanists may be replaced by one player executing quick tuning changes. More than one timpanist can still add volume and play more complicated passages (see Carl Nielsen's *Symphony No. 4*, Christopher

Rouse's Symphony No. 2, and Philip Glass' *Concerto for Timpani*). Any more than two sets of timpani is impractical; five timpanists, each with one drum, is reasonable, but five players, each with four drums, is likely to be a problem because of availability of space and instruments.

### Obsolete notation

The reader may notice that in old scores (most notably early Mozart), the timpani notes are notated as C and G, but "Timpani D & A" is written at the top of the part. It was common practice at the time to treat timpani like a transposing instrument or like an unpitched instrument. Later, timpani parts were notated on their correct lines but without accidentals. For example, it would be notated as E and B with "Timpani E<sub>b</sub> & B<sub>b</sub>" indicated at the top of the part. These notational practices should no longer be observed.

The reader may also notice in some parts of Schumann, Verdi, and other composers that there are timpani notes that are out of harmony with the rest of the orchestra. This is because there was not enough time to retune the pitches with the old hand screw drums, and since the drums of the time did not produce a very clear pitch anyway, it did not make much difference that the pitch was a step off. The instruments of today are much clearer pitched, and pedal mechanisms allow very quick and efficient tuning. Most timpanists fix these "wrong" notes in those scores.

### Timpani extended technique

#### Harmonics

By pressing a finger or mallet against the drumhead about halfway between the center and edge and then striking towards the edge, the harmonic an octave above the fundamental is produced. This is a subtle effect, and a moment of preparation is necessary to get the finger or mallet into position. (See Elliott Carter's *Eight Pieces for Four Timpani*.)

**Sympathetic resonance** - see General Logistics

#### Striking the bowl

Indication to strike the copper bowl of the timpani is often notated with X noteheads. The bowl should not be struck too hard as it can be damaged. Often when loud or involved bowl playing is asked, timpanists will bring in another less valuable bowl and set it next to the timpani. Timpanists will go to great lengths to ensure the safety of their instruments.

Although union rules often require timpanists to be paid a doubling fee if they play any instrument other than timpani, striking the bowl may still qualify as timpani playing and thus may be permissible. Check with the particular orchestra or union for specifics.

When the bowl is struck, the head does not ring much; when the pedal is adjusted, it adjusts the pitch of the head and not the pitch of the bowl. For these reasons, it is not effective to move the pedal while striking the bowl. Similarly, little effect results if the pedal is adjusted while the rim is struck.

#### Prepared timpani

Crotales, Japanese temple bowls, or an upside-down cymbal can be placed on a timpano head and struck, rolled on, or bowed while the percussionist pedals up and down. A thumb-piano can also be played while resting on a timpano. These produce haunting effects. In each case, the overtones of the timpano head resonate sympathetically with the pitches produced by the instrument resting on it; the moving pedal gives the impression that these pitches are glissando-ing. These effects are very soft and will not be noticed if the pedal moves up and down too slowly. The specific pitch of the drum head will not be heard. (See Per Nørgård's *I Ching*, George Crumb's *Music for a Summer Evening*.)



Playing too many crotales on a timpano is unwieldy and passages will be difficult to execute; it is best to use no more than six notes in these situations. If quick passages or passages with many notes are needed, it is more appropriate to use a regular set of crotales on a stand.

Small items, like a coin or the ring from a soda can lid, can be placed on timpani heads to rattle. This works best at soft dynamics because at loud dynamics, the item will bounce off onto the floor. Objects can be placed on the head and secured with tape to rattle at loud dynamics without falling off, but this will muffle the head.

As with striking timpani bowls, prepared timpani may still technically be classified as timpani playing, and doubling fees may not apply. Check with the specific orchestra or union.

### Timpani as unpitched instruments

Timpani can be used as unpitched instruments. If muffled, tuned very low, or played loudly in context with other unpitched instruments, the pitch of the timpani can be ignored.

### Tom-toms, snare drum, field drum, tenor drum, timbales, roto-toms, bongos, congas, tamborim

A tom-tom (or just *tom*) can have one or two heads (just the top *batter* head, or both top and bottom heads) and comes in a variety of sizes and pitches from very high to very low. "Tom-tom" refers to a drum with no special features. Snare drums, field drums, tenor drums, timbales, roto-toms, bongos, and congas have special characteristics that make them more than just tom-toms, but they could all technically be described and even used as tom-toms.



[Figure 5.21]

These drums are almost always used as unpitched instruments. They can be tuned if necessary, but the pitches will not be very clear. Roto-toms are often used when tuned tom-toms are requested because the pitch is easily adjusted. It is not advisable to specify pitches for drums with snares because the snare sound will almost completely obscure the pitch. With the exception of roto-toms, the pitch of a drum cannot be changed within a piece; changing the pitch of roto-toms is possible but awkward.

### Snare drum

Snare drum (also called *side drum* or *military drum*) can come in a variety of sizes - from piccolo to field drum. A piccolo snare drum is just a few inches deep and is very bright and responsive. A standard snare drum is about 5 to 6 inches deep, and a field drum can be around 12 to 16 inches deep. Snare drum shells are made of wood, brass, fiberglass, steel, or other materials.

Snare drums have both a top and bottom head and have snares. Snares are wires that run across the bottom head of the drum and vibrate when the top head is struck; this gives the snare drum its unique sound. Snares can be lowered away from the head by use of a snare *throw off* or *clutch*, indicated with “snares off.” The snares can be turned on or off easily during performance, but some time (about a second or two) must be allotted to do so; without proper time for this switch, extra noise may be produced. A snare drum with the snares off is just a tom-tom. If there is no indication for snares on or off, “snares on” will be assumed.

Snares add a very bright timbre to the drum. The snare drum, even at soft dynamics, has a lot of cutting power and has difficulty blending well with darker sounding instruments. Because of the very tight articulation that the snares create, rolls on snare drums, especially those at soft dynamics, should always be executed as buzz rolls with drum sticks. Single stroke rolls with mallets or hands will tend to sound very choppy and unappealing.

The sound that the snares produce is dependent on the material or combination of materials used and the tightness of the snares against the head, neither of which is commonly specified by the composer. Any indication with respect to the timbre of the snares is rare, but a “wet” or “dry” sound may be specified. Drumset players sometimes use a wet snare; a dry snare is more of a marching band sound. Both are used in concert music for a variety of effects, but generally a concert snare sound is dry.

Snares are very sensitive and often vibrate sympathetically with just about everything. The wetter the snare, the more sensitive it is. Timpani, tom-toms, marimba, or vibraphone located close to a snare drum, or French horns, who often sit right in front of the percussion section in an orchestra, are common causes of snare noise. If a snare drum is used with other toms, the other toms might vibrate the snares and sound as if they have snares themselves. The size and volume of an orchestra can usually cover the buzzing snares, but the buzzing can be a real problem in chamber and solo settings. To cut down on the noise, percussionists try to turn on the snares only when absolutely necessary. It may be wise for a composer to leave a bit of time before and after each snare drum entrance for the snares to be turned on and off.

Although usually a drawback, a composer could use the sympathetic buzzing as an effect to enhance the sound of a wind, brass, or other percussion instrument.

### **Tenor drum and timbales**

A tenor drum is simply a field drum without snares. Timbales are a traditional Afro-Cuban instrument and are derived from (but only very loosely resemble) timpani. They are similar to a regular snare drum without snares, but always have metal shells and only one head. They are almost always used in pairs.

### **Roto-toms**

Roto-toms are tunable single-headed toms with a thin frame instead of a shell (see Figure 5.21). They come in the following sizes: 6, 8, 10, 12, 14, 16 and 18 inches. The pitch can be raised or lowered by spinning the entire drum. Unlike timpani, one cannot easily change pitch while playing. The design of these drums is best for fixed pitches; if the pitch is to be changed during a piece, enough time should be given (about 8 to 10 seconds) to do so accurately. Glissandi are possible but difficult, and the player must have one hand free to spin the drum. Pedal roto-toms do exist but are rare. Pitch specification is not necessary for roto-toms - they can also work as unpitched instruments.

When used with pitches, roto-toms are notated at pitch in treble and bass clef. Although there are some important pieces in which roto-toms are notated in alto clef, percussionists prefer treble and

bass. The best sounding pitches are the middle of a drum's range; the highest pitches will sound choked and the lower pitches will be flabby and unclear. The ranges are as follows:



[Figure 5.22]

Since they have no shell, roto-toms project the least of all drums. This is not to say they are not loud, but the sound and especially the pitch can get lost in a heavily orchestrated passage.

Although commonly used as an upward extension of timpani, the sound of roto-toms is quite different and the match is far from perfect.

### **Bongos and congas**

Bongos and congas are Latin instruments that are traditionally played with the hands, but sticks and mallets also work well (although some players might object to the use of sticks and mallets on these instruments, especially congas, as they can damage the drum head). Both instruments almost always have calfskin heads. Bongos are very high pitched and come in pairs with one 6-inch drum and one 8-inch drum attached to one another. These drums are always attached together so if only one drum is requested, the other drum will usually still be present in the setup. If more than two bongos are used, they will be tuned to graduated pitches since only the two drum sizes are available. Other sizes of bongos exist but are rare.

More than two bongos may be difficult to arrange in a setup. One may need to unscrew and re-screw the drums together to set them up in odd configurations. If it is inconsequential to the piece, it may be best to use a pair of bongos with other drums instead of three or four bongos. Since only the two sizes of bongos are common, any more than four bongos (with four different pitches) in one setup may be unreasonable.

Congas are deeper than bongos and are generally used in pairs, but any number (reasonably, up to four) is acceptable. These drums come in three basic sizes called (from low to high) the *tumba*, the *conga*, and the *quinto*. For nontraditional music, the use of these terms is unnecessary, and "low, medium, and high" is more appropriate.

Bongos and congas compliment each other - two bongos and two congas cover a nice range and have similar timbral qualities. Although congas are very large, they are not especially low in pitch. An overtone about an octave above the fundamental is the most prominent pitch. The fundamental is heard most with a *bass* stroke of the hand; this pitch is very low. The pitch produced with sticks, mallets, or the *tone* stroke of the hands is relatively high - just under the pitch of bongos. If necessary, the head of congas can be tuned very loosely so even sticks and mallets will produce low pitches.

### **Other drums**

Regular tom-toms can come in a wide range of sizes from very large to very small. The above drums could all be used instead of or along with regular toms.

A tamborim is a small Brazilian drum (6 inches in diameter) like a tambourine without jingles (see Steve Reich's *Tehillim*). It is generally held and played with one stick (or flayed stick, like a rute) but can be mounted.

Chinese tom-toms have a unique shape and two calfskin heads. They come in a variety of sizes and have a dry and dark sound. They are not as widely available as the other drums listed.

### Frame drum, djembe, dumbek

These three drums are just a few of the enormous number of ethnic hand drums. They are played almost exclusively with the hands and are generally held as follows: frame drum in the hands (Figure 5.23a), djembe between the legs (Figure 5.23b), and dumbek under the arm (Figure 5.23c). Each instrument has its own characteristic playing styles and techniques. The guidelines for hand drum notation described earlier in *Hands on Drums* do apply. To design a more detailed notation, the composer should take a close look at the instrument with a percussionist.



[Figure 5.23a]



[Figure 5.23b]



[Figure 5.23c]

Frame drums are like tambourines without jingles (a tambourine is technically a frame drum). They can be found in many different sizes from 8 to 20 inches. Djembes are large wooden (or fiberglass) drums with a booming bass and wide range of timbres. A dumbek is like a djembe but much smaller and made of ceramic or metal.

### Bass drums

There are two main types of bass drums: the concert bass drum and the pedal bass drum. A typical concert bass drum is very large and resonant and is played either upright (Figure 5.24a) or on its side (Figure 5.24b). A typical pedal bass drum (sometimes called *kick drum*) is smaller and much drier (usually muffled by towels, blankets, etc. inserted inside the drum); it is played with a mallet made of wood, plastic, or hard felt which is attached to a pedal (Figure 5.24c). Concert bass drums come in a variety of sizes from about 25 to 40 inches in diameter; pedal bass drum sizes range from about 16 to 22 inches. Large concert bass drums can also be played with a pedal, and pedal bass drums can also be played with sticks or mallets.

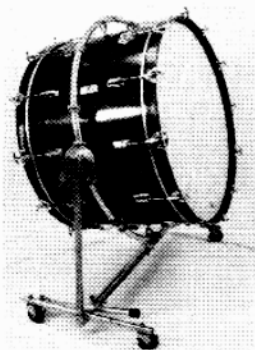

[Figure 5.24a]



[Figure 5.24b]



[Figure 5.24c]

A pedal drum is usually played with the foot facing the drum but can be placed behind the player so the pedal is operated by the heel of the foot (see Figure 5.25). This is advantageous if there is no room for the bass drum under a mallet instrument or within a setup.

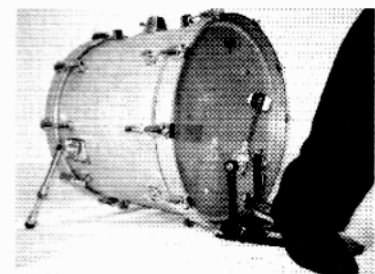

[Figure 5.25]



Double bass drum pedals are becoming more frequently used. This is a device that allows for both feet to play one bass drum. The feet cannot play quite as fast as the hands, but faster than one might think. Some percussionists can do this better than others. When both feet are involved, the percussionist might have to sit down. Standing is possible but difficult.

Tambourine, sleighbells, shaker, or another such instrument can be placed on a concert bass drum head to rattle when the head is struck.

### Drumset

Drumsets characteristically have a pedal bass drum, hi-hat, snare drum, one or more toms (three is common), and a variety of suspended cymbals. The low tom of a drumset often stands on the floor (see Figure 5.26) and is called a *floor tom*. The composer should not feel restricted to these instruments just because he or she feels the need to use a “drumset.” Another setup of drums, with or without cymbals or pedal instruments, may be what the composer is imagining.



[Figure 5.26]

Drumset should be used to evoke the sounds of specific styles of music (Jazz, Rock, etc.). For example, Leonard Bernstein’s *Symphonic Dances from West Side Story* uses drumset in Jazz and Latin music (see also Milton Babbitt’s *All-Set*). On the other hand, John Adams’s *Chamber Symphony* uses a drumset-like setup for an exclusively Adams sound. In this case, one might argue that it is not actually a “drumset,” but rather a multi-percussion setup. Regardless of terminology, any multi-percussion setup, whether it is drumset-like or not, should follow all the previously detailed notational guidelines for setups (see **General Notation**).

In addition to evoking the sounds of popular music styles, “drumset” also implies specific styles of playing. *Keeping time* is traditionally its primary roll. If the drummer reads from music, it is rarely a completely written out part. Usually the drummer will play off a song chart and respond to structure, motives in the rest of the ensemble, harmony changes, etc. Also, the style is usually indicated to let the drummer know what kind of *time* to play (e.g., swing, hard rock, shuffle). Charts notated more specifically might include important rhythms in the rest of the ensemble, upon which the drummer can accent and embellish, and spots in which to put a drum fill. A drum fill is a short embellishment about a bar or half of a bar long and usually at the end of a phrase.

The composer may further control a drumset part by notating specific rhythms for fills, places to put important cymbal crashes, specific ostinati to play, etc. Still, it is not necessary to notate each note and instrument. With careful study of Rock and Jazz recordings, a composer can get a good idea of how the drumset can be used.

The following is one example of a notational system for drumset which specifically indicates each instrument.

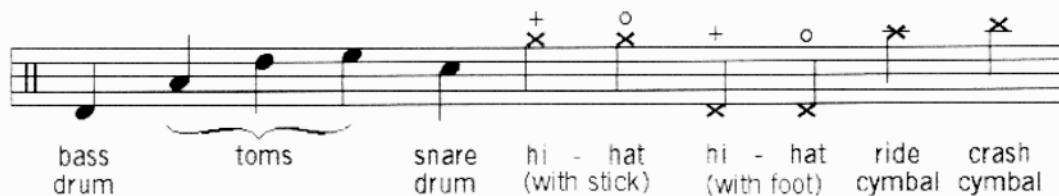

[Figure 5.27]

# 6.

# keyboard percussion

Instruments covered in this chapter are: marimba, vibraphone (vibes), xylophone, glockenspiel (bells or orchestra bells), crotales (antique cymbals), and chimes (tubular bells).

## Ranges

Ranges indicated below are correct for notation. Marimba, vibraphone, and chimes sound as written. Xylophone sounds one octave higher than written. Glockenspiel and crotales sound two octaves higher than written. Ranges in parentheses are not always available. Marimba is notated in treble or bass clef or on a grand staff. The other instruments are almost always exclusively notated in treble clef.

## Marimba - sounds as written

- (a) 4 octave - common (becoming more obsolete)
- (b) 4.3 octave - most common
- (c) 4.5 octave - somewhat common
- (d) 4.6 octave - somewhat common
- (e) 5 octave - common (becoming more common)
- (f) bass marimba - rare

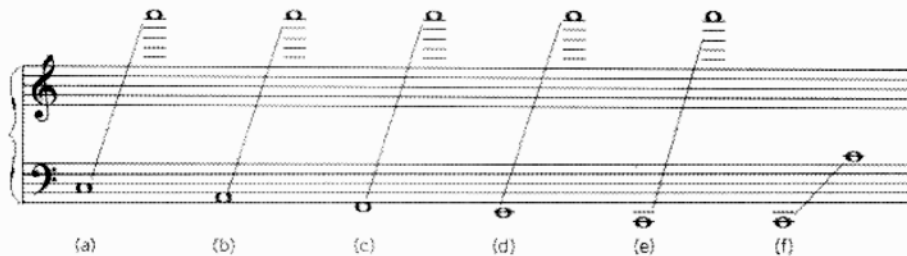

[Figure 6.1a]

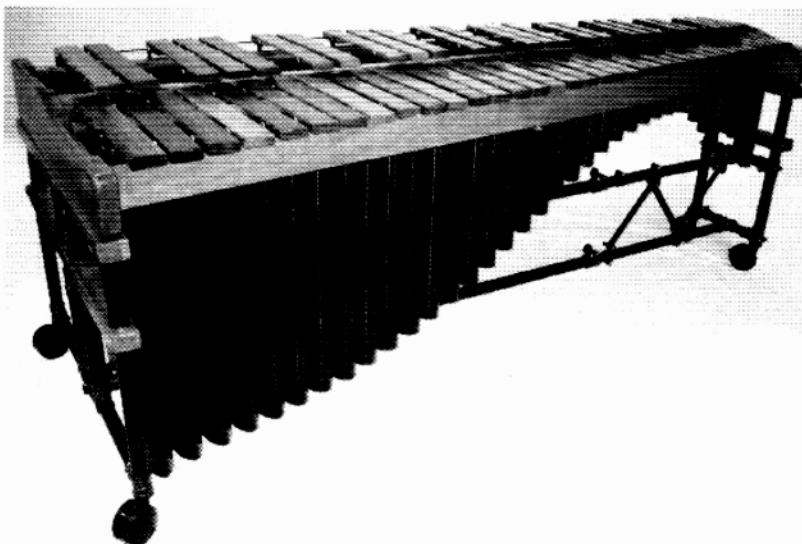

[Figure 6.1b]

**Vibraphone (vibes)** - sounds as written

- (a) 3 octave - standard
- (b) 3.5 octave - rare
- (c) 4 octave - rare

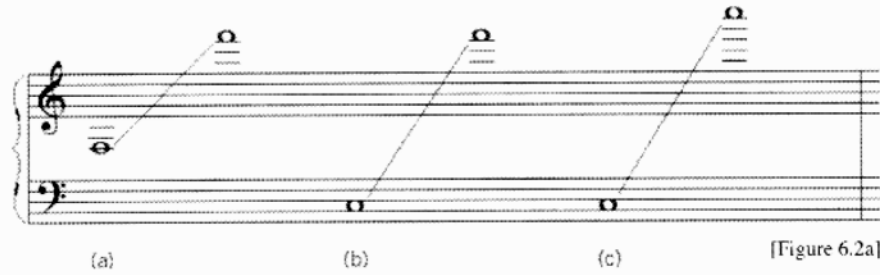

[Figure 6.2a]



[Figure 6.2b]

**Xylophone** - sounds one octave higher than written

Extended range (4-octave) xylophones are common but not standard.

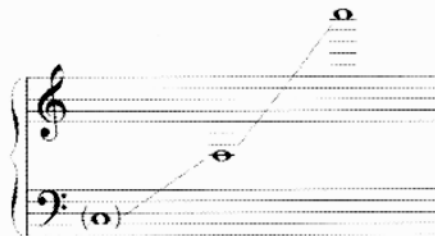

[Figure 6.3a]

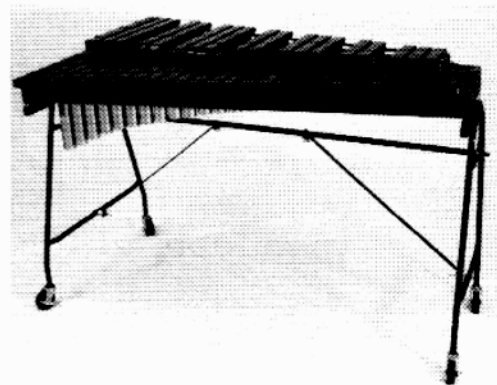

[Figure 6.3b]

**Glockenspiel** (bells or orchestra bells) - sounds two octaves higher than written

The lower F is the most common range expansion; the upper D is less common. Even larger ranges (up to a fifth below and a third above) are occasionally available.

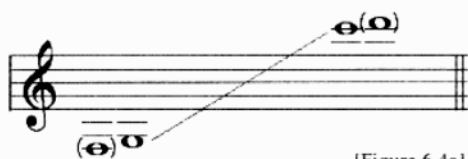

[Figure 6.4a]

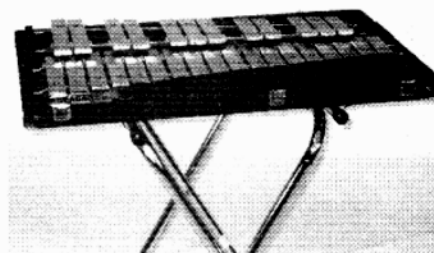

[Figure 6.4b]

**Crotales** (antique cymbals) - sound two octaves higher than written

The two octaves can be used separately or together.

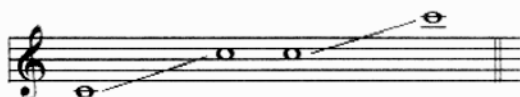

[Figure 6.5a]

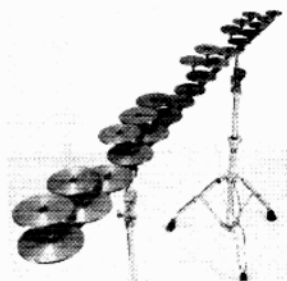

[Figure 6.5b]

**Chimes** (tubular bells) - sound as written

Additional individual chimes outside of this range, higher and lower, are sometimes available.

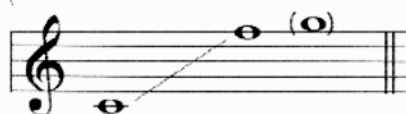

[Figure 6.6a]

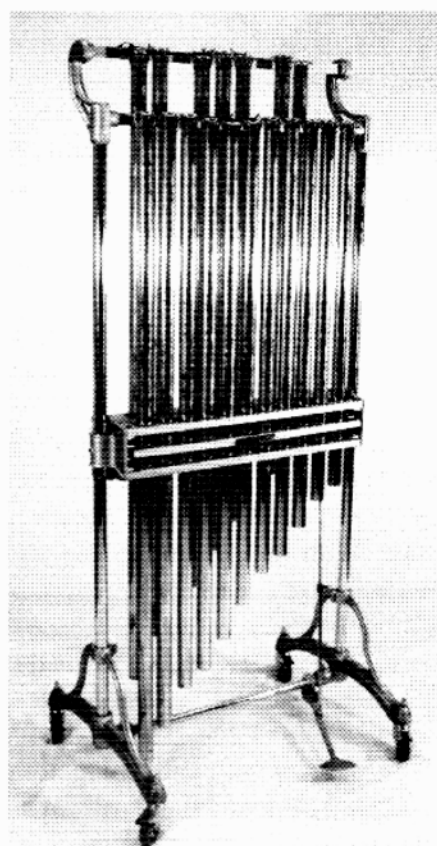

[Figure 6.6b]

### Resonators

Marimbas, vibraphones, xylophones, and some glockenspiels have resonators. The resonators are tubes that are closed at one end and tuned to the pitch of the bar under which they hang. The air inside the tube resonates sympathetically along with the bar when the bar is struck; this reinforces the fundamental tone and makes the sound louder and fuller.

As a special effect, resonators can be scraped horizontally with a yarn or cord mallet or gently with the mallet's butt end. This sound will vary considerably depending on the material of the resonators which is determined by the make and model of the instrument. A resonator scrape should not be done with hard plastic, wood, or metal beaters, as it can damage the resonators.

### Pedals

Vibraphones and chimes have pedals that control the resonance in much the same way the sustain pedal of a piano does. See the **Note Length** section of **General Notation** for more. Pedal glockenspiels exist but are rare.

### Vibraphone motor

The vibraphone has a motor that spins small disks (fans) inside the resonators. The disks, when horizontal, close off the resonator and eliminate its dynamic reinforcement. The motor spins the disks which rapidly opens and closes the resonators to create a vibrato-like effect. This is not a vibrato with pitch fluctuation, but rather a pulsing tremolo effect (like flute vibrato). (See Berg's *Lulu*.)

The motor can be turned on and off and the speed can be adjusted during performance. This is notated "motor on" or "motor off," and "fast motor," "slow motor," "medium slow motor," etc. The composer should be aware that it takes time to turn the motor on and off or to adjust its speed, and these operations can be especially awkward with mallets in hand. (See Charles Wuorinen's *Percussion Duo*.)

For exact motor speed, beats per minute can be indicated. This would have to be set before the start of the piece and could not realistically be adjusted with much accuracy during performance. It would be very difficult to try to adjust the motor speed to the tempo of a piece, but it is possible that the tempo could be taken from the speed of the motor.

A simple gear system located on the top end of the instrument controls the opening and closing of the disks. This gear system can be operated manually if a very slow and careful open/close is needed. A continuous opening and closing, like that of the motor, is difficult with this method. Manual operation of the gears requires only one hand so the other hand is free to play.

The disks are usually adjusted so both keyboards (the naturals and accidentals) open and close at the same time, but they can be adjusted otherwise. When the disks are set perpendicular to one another so that one keyboard's resonators are open while the other's are closed, a *Bunker trill* (after Larry Bunker) results. With this technique, the accidentals and naturals pulse opposite one another to create a sort of trill over the whole keyboard between the "white" and "black" notes. The position of the disks cannot be easily or quickly adjusted so some time must be allowed to do so. The Bunker trill is a subtle and quiet effect. It is not widely known and should be explained in detail in the score and part.

Vibraphone is most often used with the motor off. This is sometimes referred to as a *metallophone* (by Steve Reich), but percussionists are most used to seeing "vibraphone, motor off." Unless "motor on" is specified, motor off will be assumed. Vibraphone must be plugged into a power outlet when the motor is in use. Extension cords are usually required.

## Removing notes from the set

Specific chime and crotale notes can be removed from the set if only a few pitches are needed. Crotales can be mounted on cymbal stands (see Figure 6.7a) or placed on a trap table. Smaller chime racks that hold about four notes are common; a single chime can also be hung from a cymbal stand or held up by hand (see Figure 6.7b).



[Figure 6.7a]



[Figure 6.7b]

## Idiomatic writing for mallet instruments

### Thumbs and pinkies

Composers often write with a piano and are therefore thinking with ten fingers. A percussionist can hold up to four mallets comfortably and has quite a bit of freedom, but certainly not as much as a ten-fingered pianist. The dexterity that composers enjoy on piano can easily result in the composition of keyboard percussion music that is extremely difficult. By composing on piano with just thumbs and pinky fingers, the logistical problems that keyboard percussionists face will become immediately apparent.

One will first notice, when playing piano with only these fingers, that only four notes can be articulated simultaneously. This may be obvious, but with ten free fingers, composers can forget and occasionally slip in a five or six-note chord. Playing a simple scale with one hand is not nearly as easy - C major with alternating thumbs is actually appropriate. If the four-fingered pianist wants to pivot between two adjacent minor thirds in one hand (e.g., C-E $\flat$  and D $\flat$ -F $\flat$ ) the whole arm has to swivel back and forth. In addition to these limitations, imagine that each thumb and pinky are 16 inches long and the piano keys are three times as wide!

As silly as it may sound, this “thumbs and pinkies” technique is rather accurate. One is able to imagine how percussionists move across the keyboard, and this can help the composer write idiomatically for these instruments.

Percussionists can, however, play larger intervals than the thumbs and pinkies will usually allow. The interval stretch in one hand varies with instrument (the largest interval on a vibraphone will be much less than the largest interval on a glockenspiel) and with placement in the range of the instrument (the bars get wider on the low end of the instruments). For these reasons, it is hard to give an exact limit on interval size. The limit in the lowest octave of a five-octave marimba where the notes are largest is about an octave, comfortably. Larger intervals are possible as one moves up in the instrument’s range, but it is best to speak with a percussionist about a specific example.

Below is a list of the largest intervals in one hand for each instrument. Slightly larger intervals are possible but should be used carefully.

- marimba and vibraphone - octave
- xylophone and glockenspiel - 11th
- crotales - major 6th

Percussionists can play any smaller interval down to a unison. Articulating two adjacent notes with one mallet is not practical.

The composer must keep in mind that mallet instruments are large and awkward. A five-octave marimba is over eight feet long! The size of a fifth on the low end of a marimba is about equivalent to two octaves on a piano, so one can take what is known about accuracy problems with large leaps and runs that quickly span large distances on piano and apply that four-fold to keyboard percussion instruments.

There is one important limitation that the thumbs and pinkies technique does not address: mallet instruments are never touched like a piano so the performer has no way of feeling his or her way around the keyboard. Percussionists rely entirely on being able to see the keyboard to locate the correct notes. Of course muscle memory is in play which helps with interval sizes and distances across the keyboard, but this is very abstract. Most percussionists are required to play on many different instruments - not just marimba, vibraphone, xylophone, and glockenspiel but different brands of marimbas, vibraphones, xylophones, and glockenspiels where bar size can vary slightly. This has a considerable effect on one's ability to become truly familiar, as a pianist would, with the distances between notes and the sizes of intervals. There are some solo marimbists who play nothing but marimba and always play on the same instrument; for the rest of the percussion community, the ability to see the instrument is very important.

As a result, if the two hands are playing very far apart from each other, accuracy problems are created. The reader may try the following exercise: sit at a piano with your eyes focused on middle C and notice the span of your peripheral vision. Without moving your head, observe the range you can comfortably move your hands in both directions and still see what notes you are playing; now, divide that interval by four. This is the range in which a passage could comfortably fit on a mallet instrument - probably not much more than an octave. The composer can, of course, expand beyond that but must keep in mind that the player may only be able to look at one hand at a time. For this reason the composer may want to have difficult large leaps in only one hand at a time while the other plays tighter passages.

Here are some more specifics that one can discover with the thumb and pinky technique:

- Fourths, fifths, and sixths are the most comfortable intervals.
- Just as in piano playing, shifting one's whole hand around is difficult while figures that move each hand smoothly around the keyboard are much easier.
- Keeping one hand on each keyboard - naturals or accidentals - at a time is preferable (like the piano part in Stravinsky's *Petrouchka*).

The reader may try the following passage (Figure 6.8) on piano with thumbs and pinkies to get a feel for keyboard percussion playing. This passage is very idiomatic. Mallet indications are 1, 2, 3, 4 from left to right (see Figure i.1) - that is, 1 is left pinky, 2 is left thumb, 3 is right thumb, and 4 is right pinky. R and L mean right and left when both mallets (fingers) of the same hand are used together. (Mallet indications are rarely included in scores.)

Marimba

$\bullet = 116$

*p*

6 *quasi accell.*

*piu f* *p*

8 *sub. p* *sfz* *sub. p* *sfz*

10 *sub. p* *sfz* *sim.* 2 3 4 L R

12 2 3 2 3 2 3 2 3 2 3 1 3

14 1 3 2 4 1 3 2 3 2 L R 2 4 1 3 2 4 L R L R 1 4 2 3 2 L R

16 2 3 2 3 4 L R 2 3 3 2 3

18



[Figure 6.8 continued]

19

2 3

2 3 2 4 1 3

2 4 1 4

1 3 2 3

21

2 3 1 3

23

3 1 4 2 3 1 4 2 3 1 4 2 3 1 R

25

(p) *molto cresc.* 3 2 3 L

26

R L R L 3 3 L

*ff*

[Matthew Fuerst]

### Idiomatic writing for chimes

Chimes are far more awkward to play than other keyboard percussion because the beaters used are large and heavy and must be held up high in the air. It is especially difficult to hold more than two chime hammers, and only an interval of about a third can be reached with two hammers in one hand. Four mallet passages could be more easily executed with regular plastic or yarn keyboard mallets; however, this would sound considerably different than chime hammers. Fast passages are impractical with more than two hammers and are difficult even with two. Generally, chimes are best for slow passages.

## Stacked instruments

Mallet instruments can be stacked one in front of the other to be played at the same time or in quick succession. Marimba and vibraphone are commonly stacked (see Charles Wuorinen's *Percussion Duo*) with the vibraphone in front so the pedal is accessible (see Figure 6.9). Occasionally marimba can be positioned in front of the vibraphone with the vibraphone pedal extended, but the former configuration is most common. The marimba/vibraphone combination is perfect because the same mallets can be effectively used on both instruments. Xylophone and glockenspiel also stack well for this reason.

With stacked instruments, the instrument furthest from the performer should be notated on top. With the setup shown in Figure 6.9, the staves for the marimba would be on top even though the marimba's range extends far below that of the vibraphone (see Figure 6.10).



[Figure 6.9]

[Figure 6.10]

[From Ryan Streber's *Rondel*]

A smaller marimba (low A [4.3-octave] or low F [4.5-octave]) instead of a full 5-octave is far better if fast difficult passages are written between the instruments. The reach over the vibraphone can get tricky with the 5-octave, and the mallets necessary for the vibraphone are not ideal for the lowest register of the marimba. In general, it is best to avoid writing difficult passages for the instrument furthest from the player.

Many more logistical problems can arise with stacked instruments than with just a single instrument. To be safe, it is best to request only one instrument per hand at one time. If a keyboardist plays a

piano and a synthesizer at the same time, he or she cannot be expected to play both instruments at the same time with one hand. The same is true here. With stacked instruments, one cannot be exactly sure what will be in reach depending on the size of the instruments and how they are set up in relation to each other. For this reason, if a chord has three notes on the marimba and one note on the vibraphone, it may or may not be reachable. It is acceptable to have four notes on the marimba, four notes on the vibraphone, or two notes on each (see Figure 6.11).

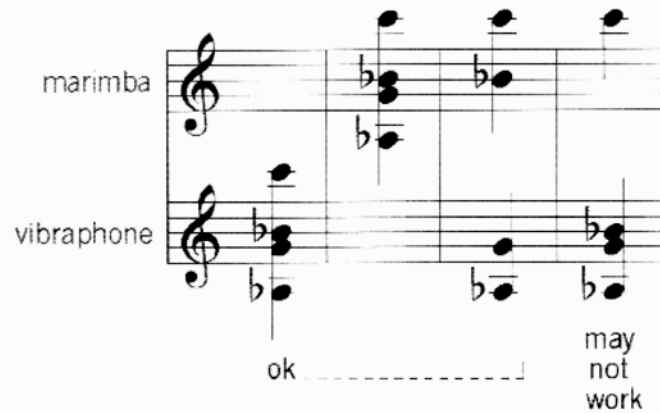

[Figure 6.11]

When stacked, only the “white” notes of the vibraphone are exposed to bowing. If “black” notes need to be bowed, the vibraphone must be pulled away from the marimba. This would require about five seconds. If the vibraphone is stacked behind the marimba with the pedal extended, bowing either side is unreasonable.

### Rolls

Rolls with hard mallets, like those used for xylophone, glockenspiel, and crotales or rolls in the upper register of marimba will always sound “beat-y”; that is, the individual strokes will be heard. Rolls can be seamless with softer mallets in the mid and lower register of the marimba, and under ideal conditions, rolled four-note chords can sound like an organ. With sustaining instruments such as vibraphone, glockenspiel, crotales, and chimes, the use of rolls is more of an effect than a necessity. For detailed information on rolls, see **General Notation**.

### Balance problems

The sound of glockenspiel, crotales, and xylophone cuts through an ensemble, and chimes can usually power their way through. The sound of marimba and especially vibraphone blend very well and tend to get covered in an orchestral setting. Harder mallets and stronger dynamics can help. The pulsing of the vibraphone’s motor can also be used to make the instrument’s sound more conspicuous (in the same way a blinking light is more noticeable than one that stays constant).

### Overtone interference

The composer should be aware that on a 5-octave marimba, the notes in the lowest octave have very strong and clear overtones; three octaves and a major third above (a major 24th) is especially apparent. If a minor tenth (or m17th, m24th, etc.) is struck, the dissonance between that interval and the overtone is very audible. It sounds almost as if all three notes had been struck. This applies to elevenths, eighteenth, etc. as well.



[Figure 6.12]

### Figurative writing for glockenspiel and crotales

As a result of their high pitch, lengthy ring, and shimmering overtones, the pitches of a glockenspiel and especially of crotales are not always clear within fast passages. A fast figure may sound more like many triangles than a series of notes. This can be a problem when individual pitches of a fast passage are important and need to be heard, or it can be a nice effect as a shimmering gesture (see John Adams's *Short Ride in a Fast Machine* and *Harmonielehre*).

### Glockenspiel as an extension of the vibraphone

Glockenspiel is timbrally very similar to vibraphone and is often used to supply notes that are not available in the vibraphone range. Unfortunately, vibraphone mallets do not work well on glock, and glock mallets are much too bright for vibraphone. If four-mallet passages are needed on both instruments, then the player will have to switch mallets. If only two-mallet passages are needed on each instrument, then the player can hold two vibraphone mallets and two glockenspiel mallets - one in each hand (see Figure 3.2). The composer should specify that the glockenspiel sound and the vibraphone sound should match as closely as possible so the player can make the appropriate mallet choices.

If two players are used, one for each instrument, then appropriate mallets will be used. It should still be specified that the vibraphone and glock sounds should blend as if they were one instrument so mallet choices can be made accordingly.

Sometimes very hard vibraphone mallets can work in the low to mid register of the glockenspiel.

### Multiple players

Mallet instruments, especially marimba, can be played simultaneously by more than one player. This can save space in a big setup or accommodate the unavailability of multiple mallet instruments. Additional players could even play simple parts from the opposite side of the instrument (see Steve Reich's *Music for Eighteen Musicians*). The composer should make sure that players on the same instrument will not run into each other and leave at least an interval of a third between the two parts.

### Special effects

#### Striking the edge of the bar

The edge of the bar can be played with the shaft of a mallet. One hand can only play on one keyboard ("white" or "black" bars) at a time. Large intervals in one hand are not possible; those larger than a sixth should be avoided unless in the uppermost register. There is a considerable distance from the edge of the white keys to the edge of the black keys, and a little time must be allowed for this jump. (See Joseph Schwantner's *Velocities*.)

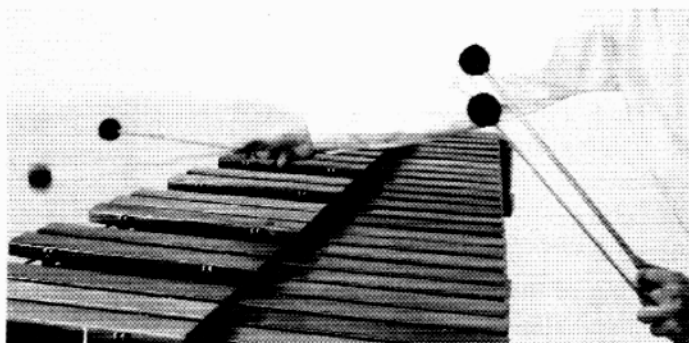

[Figure 6.13]

### Glissandi

Glissandi on mallet instruments are usually executed by running the mallet along the white notes (see Stravinsky's *Petrouchka*, Messiaen's *Oiseaux Exotiques*, Roger Reynolds' *Autumn Island*). A black note gliss is possible but not very effective since the bars are not all contiguous. If the starting or ending notes of a glissando are not to be struck normally, then they could be notated in parentheses (Figure 6.14b), with grace notes (6.14c), or not at all (6.14d, e, g).

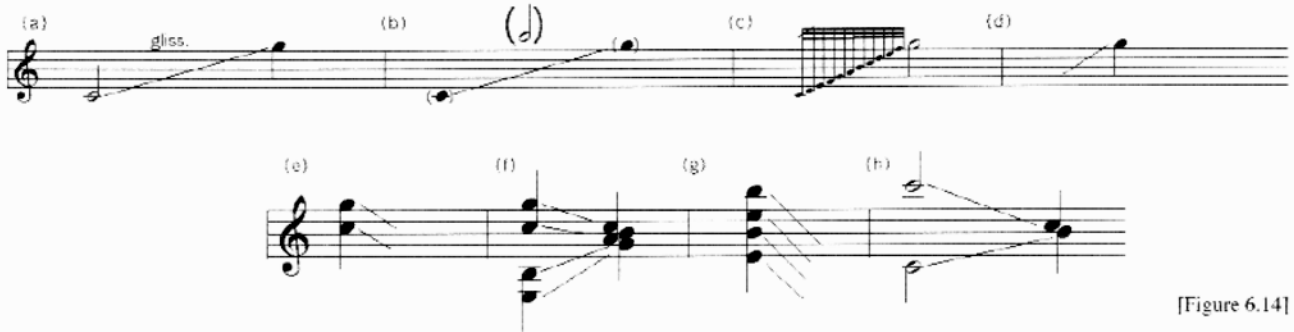

[Figure 6.14]

The first note of a glissando can be struck with either the hand performing the glissando or the other hand; the final note will preferably be struck with the “non-glissing” hand, otherwise there will be a slight break between the glissando and the final note. In Figure 6.14a, if the glissando is to be executed by the right hand, the C and G would most likely be struck with the left (non-glissing) hand.

If one hand is performing a glissando, the other hand can be doing something else; however, if the other hand is busy (or if both hands are playing glissandi), then the final note of the glissando may not be able to be struck normally without a slight break beforehand. For example, in Figure 6.14f and h, there would have to be a slight break before the end of the glissandi because both hands must prepare to strike the final notes.

Glissandi are more audible and usually more effective at faster speeds. In older scores where too much time is given to execute a glissando, percussionists will often start an octave lower. Appropriate glissando speed is an octave per quarter note at  $\text{♩} = 120$  or faster. Glissandi that cover smaller distances in longer periods of time can be achieved with a quick chromatic scale. Chromatic scale glissandi should be written out.

Glissandi are most effective with hard mallets like rubber or plastic. Hard yarn or cord will also work, but soft yarn will not speak well.

### Node

Different tone colors can be produced from marimba, vibraphone, xylophone, glockenspiel, and crotales by changing the beating spot on the bar relative to the node. The node is the least resonant and brightest sounding spot and sounds considerably different from the center of the bar. These sounds can be notated with “N” for node and “C” for center with a dotted line or arrow to indicate motion from one to the other (see Figure 6.16). These notations should be explained at the beginning of the score and part. This technique is most effective and almost exclusively used on marimba and vibraphone; it does not work nearly as well on xylophone and glockenspiel and only in special cases

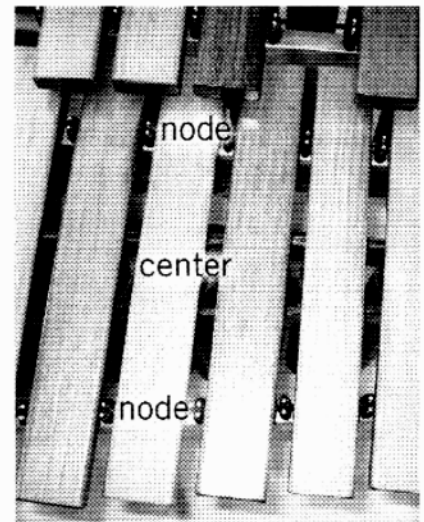

[Figure 6.15]

on crotales. The color difference is most apparent with hard mallets at mezzo-dynamics. (See Roger Reynolds' *Autumn Island*.)

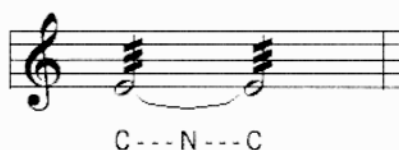

[Figure 6.16]

The node of crotales is at the very center of the disk. It has a brighter timbre which actually results in a higher pitch. The center of crotales can only be struck when individual crotales are taken off and placed on a trap table or timpano; it is impossible to strike the node with mounted crotales. Too many crotales on a table or timpano is unwieldy so it is best to use no more than six notes in these situations.

### Harmonics

A harmonic two octaves above the pitch of a bar can be produced by slightly dampening the bar (with a finger or mallet), striking toward the node, and then quickly removing the dampening. This works best in the lower register of marimbas and vibraphones. Harmonics are especially effective on vibraphone where the harmonic can be left to resonate. In this case, the necessary dampening can be achieved with the pedal (depressing it just after the attack) or with a semi-dead stroke. Vibraphone harmonics can also be bowed. Harmonics are somewhat unpredictable and are difficult to produce with consistency. (See George Crumb's *Madrigals*.)

### Mouth vibrato

The player can create a vibrato effect on vibraphone by opening and closing his or her mouth over a ringing bar. The air inside the mouth will resonate sympathetically with the overtones of the bar. As the mouth is opened and closed, the size of the space changes thus changing the pitch at which that space resonates. A very subtle glissando of overtones is heard as the mouth fluctuates between open and closed. This is a very soft, subtle, and funny-looking effect.



[Figure 6.17]

Due to the size of the human mouth, this effect only works in this range of the instrument:



[Figure 6.18]

Obviously, the player will have difficulty executing mouth vibrato in the middle of a quick passage. It should be isolated with time to get the mouth into and out of position.

**Glockenspiel vibrato**

Vibrato on glockenspiel can be created by waving a hand up and down over the struck note. This is a very subtle effect.

**Pitch bend**

A downward pitch bend is possible on marimba, vibraphone, xylophone, and glockenspiel by holding a hard rubber or plastic mallet at the bar's node, and then, after the bar is struck with another mallet, dragging the plastic mallet toward the center or end of the bar. This gradually adds the mass of the plastic mallet to that of the bar, lowering the pitch (about three quarters of a tone) and dampening the bar. Pitch bend works best in the middle range of marimba, full range of a vibraphone, and lower ranges of xylophone and glockenspiel. Pitch bending on mallet instruments takes a little time to prepare and can generally only be done on one note at a time. (See George Crumb's *Madrigals*, Jacob Druckman's *Animus II*.)

Pitch bend is also possible with crotales by dipping them into water after they have been struck (see the **Water** section in **Metal**).

**Clusters**

Clusters can be produced by striking a keyboard instrument with a dowel lengthwise. The dowel could be padded for a soft mallet sound or could be a snare drum stick for a bright clanking sound. Even a clave will work for small clusters. One dowel can effectively hit either "white" or "black" notes; two dowels must be used to hit both white and black notes at the same time. The dowel can be a custom size to hit a certain number of notes and can be angled to hit fewer notes (see Figure 6.19). Clusters are most effective on vibraphone and chimes where the notes can ring freely and sustain the cluster sound.



[Figure 6.19]

**Prepared instruments**

Vibraphone is the most eligible candidate for preparation. Coins, paper clips, and other such items can be taped to individual bars to sizzle when that note is struck. Tin foil can also be placed over the resonators of individual notes for a very interesting buzzing effect.

**Marimshot**

A *marimshot* is an effect similar to a rimshot whereby the mallet head and shaft strike the bar simultaneously. This can serve a similar function as the Bartók pizzicato. The note(s) that the shaft strikes may or may not be the same note that the head of the mallet strikes, depending on the angle at which the player must strike the note. The shaft will primarily produce a bright percussive sound and the pitch of the extra notes will not sound very loudly. When proper time is given, the shaft will be positioned so only the indicated note is struck. Marimshot can also be executed on xylophone.

With vibraphone, under normal playing conditions, marimshot works only on the "white" notes. Because the accidentals are not raised as they are on marimba and xylophone, the proper angle for a marimshot cannot be achieved on the "black" notes. Also, the additional notes that are sometimes struck by the shaft will be more apparent if the pedal is depressed and they are allowed to ring.

Marimshot should be explained at the beginning of the score and part.

### **Church bell effect**

A church bell effect can be achieved by playing random pitches and rhythms on chimes. This is notated with a wavy line (see Tchaikovsky's *1812 Overture*, Mahler's Symphonies 6 and 7). A set of pitches on which to play is often indicated.

Glockenspiel and crotales can be treated the same way for a high, tinkly wind chime effect.

### **Miscellaneous**

Xylophones and even marimbas with synthetic bars are fairly common. They do not have the beautiful tone of rosewood bars and usually ring unnaturally long, but they can withstand more abuse and stay better in tune.

Keyboard glockenspiel parts, such as Dukas's *Sorcerer's Apprentice*, Debussy's *La Mer*, Messiaen's *Chronochromie*, and Respighi's *Pines of Rome*, are now usually played on glockenspiel because keyboard glocks are uncommon in the United States. *La Mer* is sometimes played on celeste, another possible substitution. Octave transpositions must sometimes be made to fit keyboard glock parts in the small range of the glockenspiel.

A *xylorimba* is a xylophone with an extended range called for in scores by composers of the early and mid-20<sup>th</sup> century (e.g., Messiaen). It is now an obsolete instrument and should not be requested. In performances of older music, xylorimbas are simply replaced with xylophones and marimbas.

MIDI mallet instruments (e.g., MalletKat and Marimba Lumina) are currently poor substitutes for acoustic instruments but can be useful for invented or altered sounds. Synthesized vibraphone tends to sound closest to the real instrument, and synth vibes on a MIDI controller can be used in addition to an acoustic vibraphone for quartertone tunings, extended range, and other effects.



# 7.

# metal

Instruments covered in this chapter are: suspended cymbals, crash cymbals, gongs, triangle, cowbells, agogo bells, almglocken, Japanese temple bowls (prayer bowls, temple bells, bowl gongs), mixing bowls, brake drums, anvil, metal pipes, thundersheet, and steel drums.

## Cymbals

There are two main types of cymbals: *suspended* cymbals and *crash* cymbals. Suspended cymbals are suspended on a stand and struck with beaters. Crash cymbals are two cymbals struck together.

When a cymbal is struck and then muffled immediately, it is called a *choke*. This applies to both suspended and crash cymbals as well as gongs. This can be notated by writing “choke” or by any other indication to muffle or play a short note.

## Multiple cymbals

Cymbals do not sound at a pitch but rather a pitch spectrum. The pitch of a cymbal can change depending on volume, beater, and even with their placement in relation to the listener. As a result, cymbals have to be far away from each other in pitch to be easily distinguishable, so little is gained from the use of more than four regular suspended cymbals. If different types of cymbals are used (e.g., sizzle, china), then the listener can easily hear the differences.

Multiple crash cymbals played simultaneously require multiple players.

## Suspended cymbals

A regular orchestral suspended cymbal is designed for the widest pitch spectrum and longest ring time. It can be any size from about 14 to 22 inches. Ring time will vary with size - the larger the cymbal, the longer the ring. A *fortissimo* crash on an average 18-inch suspended cymbal will reach *piano* after about four seconds and a *piano* stroke will be inaudible after about two seconds.<sup>1</sup>



[Figure 7.1]

1. Ring times are approximate and vary with each individual instrument.

Rolls on cymbals are usually single-stroke rolls. Yarn, cord, felt, or soft rubber mallets can produce seamless swooshing rolls; fast passages on cymbals with these beaters will always result in a roll because the individual strokes will not be heard clearly. With sticks, hard rubber mallets, or plastic mallets, each individual attack will be audible. With snare sticks at soft dynamics, the articulation is so clear that a buzz roll may be preferable.

Suspended cymbals can also be bowed. Pitch should not be specified (see **Bowed Instruments in General Notation**).

Different spots on a cymbal sound differently. The edge of the cymbal has a large pitch spectrum and a washing sound. The *bell* (also called *dome* or *cup*) of the cymbal is brighter and has a more articulate attack and centered sound (see **Tone Color**). Beating spot can be notated by writing “edge” and “bell.”

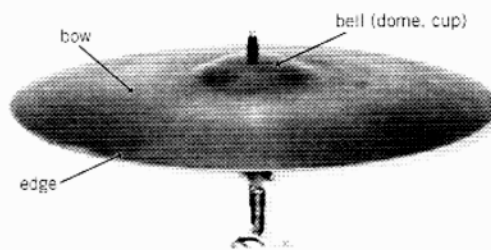

[Figure 7.2]

### Special suspended cymbals

There are many different types of suspended cymbals, most of which developed from drumset traditions. The most common are *ride*, *crash*, *splash*, *sizzle*, and *china*.

A ride cymbal is large (about 17 to 22 inches) with a very bright and dry sound.

A suspended crash cymbal (not to be confused with a pair of crash cymbals) is usually a bit smaller (12 to 18 inches) and has a full spectrum of sound and relatively short ring time. In a non-drumset context, “crash cymbals” will always indicate a pair of crash cymbals; drumset crash cymbals are called “medium-small suspended cymbals.”

The splash is the smallest cymbal (6 to 12 inches), is very bright, and has a very short ring time.

A sizzle cymbal is usually about the size of a ride cymbal. It is perforated with holes into which small metal rivets are placed; when the cymbal is struck, the rivets sizzle (see Henri Dutilleux’s *Cello Concerto*, George Crumb’s *Quest*). The same effect can be achieved by taping a coin or paper clip to a normal cymbal (see **Prepared instruments in Special effects** at the end of this chapter).

China cymbals come in a wide range of sizes (about 12 to 22 inches). They have a unique shape (see Figure 7.1) and a “trashy” sound with a short ring time (see Messiaen’s *Turangalila-Symphonie*, John Cage’s *Third Construction*).

## Hi-hat

Hi-hat is a mechanism with two cymbals - one suspended upside down and another above it suspended right side up - attached to a thin metal post. A foot pedal controls the up-and-down motion of the metal post. When the foot pedal is depressed, the cymbals are brought together. (See John Adams's *Chamber Symphony*, Bernstein's *West Side Story*, Luciano Berio's *Laborintus II*.)

Hi-hat cymbals are rather thick and about 14 inches in diameter; however, any type of cymbal can be put onto a hi-hat stand.

When the pedal is depressed and released, the hi-hat cymbals are crashed together like crash cymbals. When the pedal is depressed and not released, the cymbals produce a very short "chick" sound and then muffle each other. Similarly, a sustained or short sound can be produced when striking the cymbals with a beater while the pedal is either up or down (open or closed), respectively.

Generally, an "open" hi-hat (pedal up) is not completely open but rather slightly open so that the cymbals still touch and sizzle against each other. When completely open, the top hi-hat cymbal functions as a suspended cymbal.

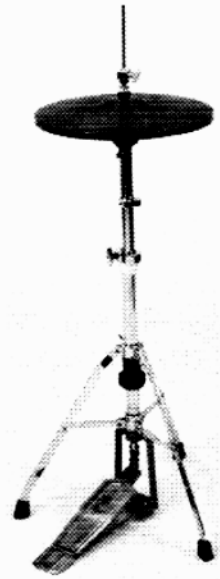

[Figure 7.3]

Hi-hat's normal resting position is open. To keep it closed, the player must hold the pedal down with a foot. The pedal can be disengaged so the hi-hat remains closed; this facilitates use of the closed hi-hat in a setup where the player's feet may be otherwise occupied. A second or two must be allowed for the pedal to be reengaged.

One staff line with open (o) and closed (+) symbols can be used for simple hi-hat notation. A slightly open symbol ( $\emptyset$ ) can be used as a separate sound from the completely open sound, otherwise, the open symbol (o) will indicate a slightly open sound. A dotted line between an open and closed symbol indicates a gradual change from one to the other. The one line staff notation is most common.

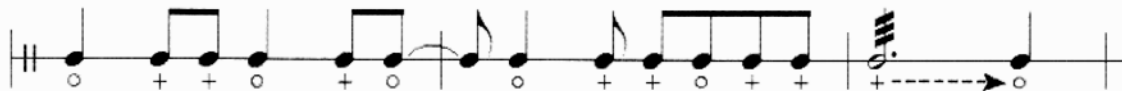

[Figure 7.4]

A two line staff can be used to notate complicated hi-hat parts - one line for the hand and one for the foot. Both lines use the open (o) and closed (+) symbols.

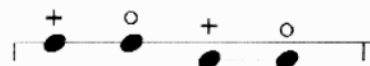

(a) (b) (c) (d)

[Figure 7.5]

In Figure 7.5:

- (a) strike the hi-hat with a beater with the pedal down
- (b) strike the hi-hat with the pedal up
- (c) depress the pedal and hold it down
- (d) crash cymbals and release them

Examples (a) and (c) sound very similar and can be substituted for each other.

The pedal must be depressed when the top line changes from open to closed, so the two motions (striking the cymbals and depressing the pedal) happen at the same time. For this, a closed foot stroke in parentheses can be notated simultaneously with the closed hand stroke. Figures 7.4 and 7.6 sound almost identical.



[Figure 7.6]

### Crash cymbals

Crash cymbals come in many different sizes and thicknesses. In addition to the timbral characteristics of cymbal size and thickness (explained in **Tone Color**), thicker crash cymbals will have a shorter, more articulate, and harder attack, while thinner cymbals will have a longer and softer attack. The type of cymbal used is not usually specified by the composer; if anything, a “large” or “small” pair of cymbals is indicated. (See Mahler’s and Shostakovich’s Symphonies, Tchaikovsky’s *Romeo and Juliet Overture*.)

### Ring

An undamped *fortissimo* crash will reach *piano* in up to four seconds. A *piano* crash will be inaudible after about a second and a half. The ring of the cymbals is controlled with muffling which is executed by bringing the edges of the cymbals in to the player’s torso.



[Figure 7.7]

### Pick up/put down time

Crash cymbals will make noise if they are not put down carefully, so enough time (about two or three seconds) must be allotted for the performer to pick up or put down these instruments. The cymbals must be held to allow them to ring; therefore, with long notes, the composer must take into account the ring time of the cymbals before giving the performer time to put them down.

### Speed

Crash cymbals are heavy and awkward instruments that require a lot of energy to play. Very fast articulations should be avoided and very quick changes to softer dynamics (*subito pianos*) may be difficult. The ability of a performer to execute a fast passage is proportional to the size of the cymbal - the smaller the faster.

### Crash articulations

Just as the length of the cymbal resonance can be controlled, so too can the length of the attack. By letting the cymbals sizzle against each other for a split second after the crash, one can elongate the attack. By pulling the cymbals apart immediately after the crash, one can make the attack more articulate. These articulations are not usually notated.

A scrape with the edge of one cymbal against the inside face of the other might be appropriate for soft long notes. This creates a long swish that is not very loud. A second or two is needed to get the cymbals in position for a crash cymbal scrape.

### Rolls

Crash cymbal rolls are rarely used. Where they are notated in pieces by Bartók, Mahler, Copland, and others, some percussionists argue that the composer was actually indicating a suspended cymbal roll. Regardless, this type of roll is now a part of percussion playing.

A loud crash cymbal roll can be achieved by rapidly striking the cymbals together, but this is difficult to execute consistently and can tire the player quickly. For softer crash cymbal rolls, the cymbals can be held together and moved against each other in a circular motion. Again, consistency is difficult. A far more effective crash cymbal roll requires two people: one person holds the cymbals together parallel to the floor while the other person rolls on them with mallets like a suspended cymbal. For this technique, some time is needed to get the cymbals into position. A hi-hat stand can be used to make this type of roll possible to execute with just one person.

### Mounting crash cymbals on a hi-hat stand

Small hi-hat cymbals can be replaced with larger crash cymbals, and soft crashes can be executed with just one hand or foot without any pick up/put down time needed. Also, a hi-hat stand can make the aforementioned crash cymbal roll possible to execute with just one person. Loud crashes are not possible on a hi-hat stand.

### Bass drum/cymbal attachment

Bass drum and crash cymbals can be played by one player with a bass drum/cymbal attachment. A bass drum/cymbal attachment mounts one cymbal to the bass drum so it can be crashed by another cymbal. The player operates the cymbal with one hand and the bass drum mallet with the other. The bass drum must be upright (see Figure 7.8), not flat on its side (see Figure 5.24b). Especially loud crashes are not possible with bass drum/cymbal attachment. (See Stravinsky's *Petrouchka*, Mahler's Symphonies 1 & 3, Rossini's Overtures.)



[Figure 7.8]

A cymbal can also be mounted face up on a cymbal stand to be used in the same manner.

A tam-tam can be struck with one crash cymbal. The inside face of the cymbal would strike flat against the face of the tam-tam. This produces the sound of both instruments.

### Gongs

*Gong* is a general term (like *tom-tom*) that refers to a group of instruments. It is not wise to use this term in writing without some additional qualification (e.g. *nipple gong* or *Chinese opera gong*). Although *tam-tam*, the most commonly used type of gong, is colloquially referred to simply as "gong," it should not be so in a score.

### Tam-tam

Like cymbals, tam-tams have a pitch spectrum - not a specific pitch. They are usually rather large but come in many sizes (10 to 50 inches). Ring time: a *fortissimo* tam-tam note would reach *piano* after about nine seconds, and a *piano* note would reach *pppp* after five seconds. Only one hand with one mallet is needed to roll on a large tam-tam because of its extended ring time. (See Mahler's and Shostakovich's Symphonies.)

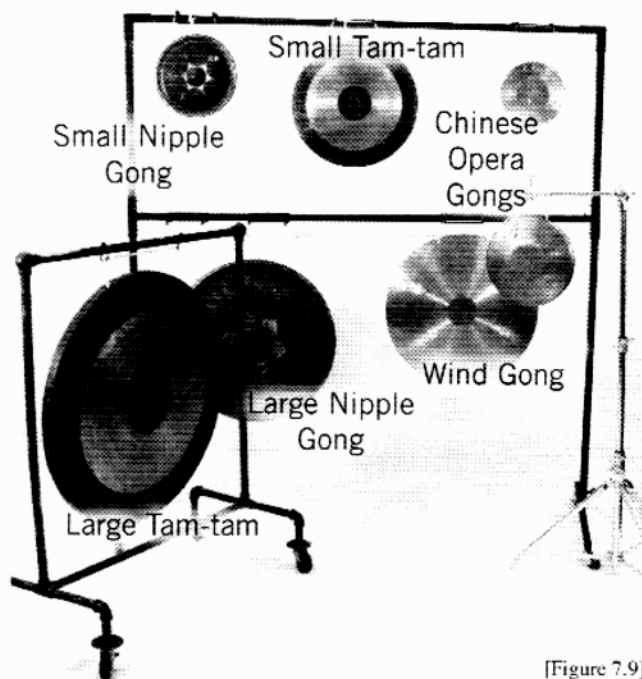

[Figure 7.9]

### Nipple gong

Nipple gongs (also called *Thai gongs* or *Javanese gongs*) are tuned to specific pitches (see Messiaen's *Et Expecto Resurrectionem Mortuorum*, Boulez's *Pli Selon Pli*). A full chromatic set of gongs is rare (three octaves requires 37 gongs, the largest of which is over 30 inches in diameter) so the composer should check with the group for whom he or she is writing to see what pitches are available. It may be possible to rent pitches that are not immediately available. The pitch of these instruments is somewhat unclear, and nipple gongs can sometimes be used as unpitched instruments.

Pitches within this range (Figure 7.10) are commonly found. Lower and higher pitches exist but are rare. Nipple gongs are very large, and many of these instruments will be awkward to setup and difficult to play. Logistically, the use of up to five gongs is reasonable.



[Figure 7.10]

The most clear fundamental pitch of a large nipple gong is achieved with a gong or bass drum beater striking directly on the nipple. With a smaller beater, such as a marimba mallet, a harmonic an octave higher will be more prominent; smaller beaters do, however, work well for smaller gongs. The area around the nipple will have a higher and very unclear pitch which sometimes sounds about a fifth above the fundamental.

### Wind gong

Wind gongs are unpitched like tam-tams but are much thinner. Their thinness results in a dark sound that crests and decays quickly after the attack.

### Chinese opera gong

Chinese opera gongs (also called *Peking opera gongs* or *Chinese fight gongs*) are fairly small (8 to 12 inches) and have a short ring time and a pitch bend. Smaller gongs will have an upward pitch bend while larger gongs will gliss downward. Pitch bend direction may be specified. (See Jean Piché's *Steal the Thunder*, Bright Sheng's *H'un (Lacerations)*, Chen Yi's *Qi*.)

### Other gongs

There are many other types of gongs from Asian traditions; the above are the types that have become standard in Western composition. If the composer would like to use other gong sounds, he or she may give the performer a free choice of gong type. This way the composer can allow the percussionist to use unusual gongs that are available to him or her without hindering future performances where those gong types are not available.

### Gong stands and racks

There are a variety of ways to suspend gongs. Most stands hold a single gong a few inches off the floor; large tam-tams are almost always mounted on these stands. Other stands with height adjustments can place a gong three to six feet off the ground; these are usually best for smaller instruments. Large racks also exist which can hold several gongs at one time. Small gongs can even be placed on a boom cymbal stand (a cymbal stand with a boom arm). (See Figure 7.9.)

Gongs can also be laid down on a trap table. The table will slightly mute the gong, which can help clarify fast rhythmic passages. Placing gongs on a table can be very effective with Chinese opera gongs; the gong would ring just long enough for its glissando to sound which creates an almost comical effect. Laying nipple gongs on a table is best when using them as unpitched instruments. (See Henry Cowell's *Set of Five*.)

## Triangle

Triangle is usually held in one hand and played with the other; any necessary dampening is executed by the fingers of the hand holding the instrument (see Figure 7.11). Triangle can also be hung from a music stand; this allows both hands to be free but makes dampening slightly more difficult. (See Liszt's *First Piano Concerto*, Bartók's *Miraculous Mandarin*, Bizet's *Carmen*.)

A triangle roll is executed by moving the triangle beater back and forth between two sides in one of the three corners. Fast rhythms can be executed in this manner or with two beaters. If two beaters are used, the triangle must be hung from a stand.



[Figure 7.11]

Triangle must be muted to varying degrees to control note length and articulation. Fast notes will tend to wash together so slight muting is often required for clarity. The use of muting is usually decided by the performer but can be prescribed by the composer (see **Note Length in General Notation**).

Triangles come in a variety of sizes. A player may use a few triangles in one piece to achieve the different colors appropriate for different passages in the music. Larger triangles sound fuller and louder and produce a large spectrum of pitches while smaller triangles sound lighter and softer and produce predominantly the uppermost partials. Like cymbals, triangles produce a pitch spectrum rather than a specific pitch; therefore, the use of more than four triangles graduated in pitch is a bit unreasonable. Multiple triangles played by one player will always be hung from a stand. (See Schwantner's *Percussion Concerto*.)

A triangle can be bowed with a bass or cello bow. This technique cannot be executed quickly, and generous amounts of time should be given to get the bow into position and make the instrument sound.

Triangle vibrato can be achieved by shaking the instrument back and forth after it has been struck. This can only be done when the triangle is held - not when it is mounted. This effect is very subtle.

A *ranch triangle* is much larger and thicker than normal triangles and rings only a short time. These instruments originated as a means to call the family in for dinner. (See Lou Harrison's *Symphony No. 2 "Elegiac."*)

## Cowbells, agogo bells, almglocken

Cowbells come in many sizes. They can be mounted by clamping them to a stand or placing them on a towel; the latter method will dampen the instruments. (See John Adams's *Chamber Symphony*, Bernstein's *West Side Story*, John Cage's *Third Construction*.) If necessary, rolls can be executed with one hand by moving the stick or mallet rapidly up and down inside the cowbell.

Two different beating spots on the cowbell can be used: the edge closer to

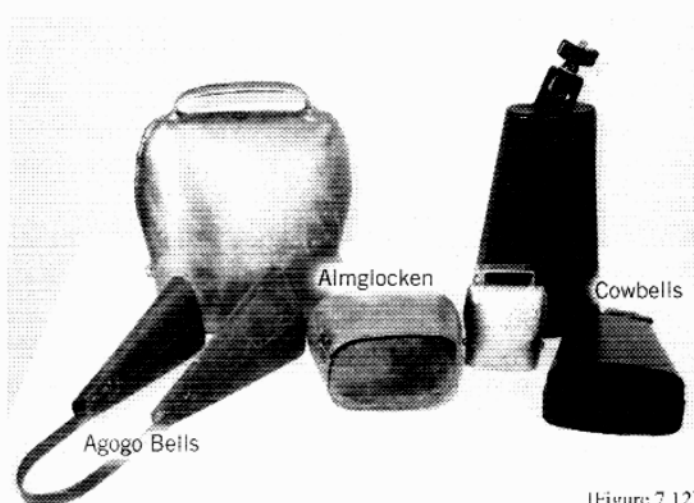

[Figure 7.12]

the opening and further back towards the closed end. The “further back” beating spot is slightly brighter and drier. These beating spots can be notated with an “o” for the open bell and “+” for the closed side. This notation should be explained at the top of the score and part.

“Cowbells” (*Herdenglocken*), as used in Mahler’s 6th Symphony, are not hit rhythmically but rather knocked back and forth randomly to evoke the sounds of cows grazing in a field. These cowbells have a metal clapper hanging inside, so when they are suspended and set into motion, the clapper swings back and forth and knocks into the sides of the bell; this is how a cowbell would operate around the neck of a cow. These cowbells are usually used in sets of up to about fifteen randomly pitched bells. Only starting and stopping points need be notated, not specific rhythms. These instruments are not especially common.

Agogo bells are generally a bit smaller than cowbells. They come in pairs and usually only one pair is used at a time. They can be held, clamped to a stand, or placed on a towel. When held, the two bells can be struck individually or clapped together by squeezing them (see Figure 7.13). (See Tan Dun’s *Concerto for Water Percussion*, Tania Leon’s *A La Par.*)



[Figure 7.13]

Almglocken are tuned cowbells (see Messiaen’s *Et Expecto Resurrectionem Mortuorum*). Like tuned gongs, specific pitches are not always readily available and almglocken may need to be rented. Normal cowbells have pitch but are less resonant than almglocken so the pitch dies away quickly. If specific pitches are requested for cowbells, almglocken will probably be used.

### Japanese temple bowls, mixing bowls

Japanese temple bowls (also called *prayer bowls*, *temple bells*, or *bowl gongs*) are fairly resonant pitched metal bowls. Although the pitch is rather clear, temple bowls are often used without pitch specification. These instruments are usually sold by size rather than by pitch, so finding a specifically pitched bowl may require much trial and error. For this reason, it may be best not to specify the pitch. Temple bowls are usually used in groups of up to five; the use of more is possible but may be unreasonable - one, two, or three is most common. (See George Crumb’s *Ancient Voices of Children* and *Music for a Summer Evening*, Per Nørgård’s *I Ching*.)

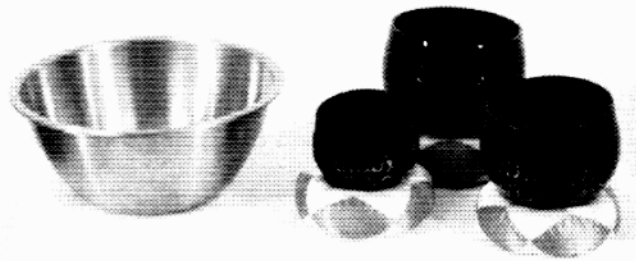

[Figure 7.14]

Temple bowls are most often struck on the edge or side, but they can also be rubbed along the edge with a short thick wooden stick. By striking the bowl to start it vibrating and then rubbing the wooden stick around the bowl’s lip, a sustained tone can be achieved.

A metal mixing bowl (standard kitchen variety) can be struck on its edge or side to produce a ringing pure tone like that of a Japanese temple bowl but with shorter ring time. Mixing bowls can also be filled with beads (or ball bearings, marbles, etc.) and stirred in a circular motion to slide the beads around the walls of the bowl. This produces a sustained swishing sound with variable dynamics. Stirred beads can only get so loud before they start flying out of the bowl. Mixing bowls can be flipped over and struck on the bottom. This produces a sound similar to a gong. Some bowls with thinner metal may produce an upward pitch bend.



## Brake drums, anvils, metal pipes

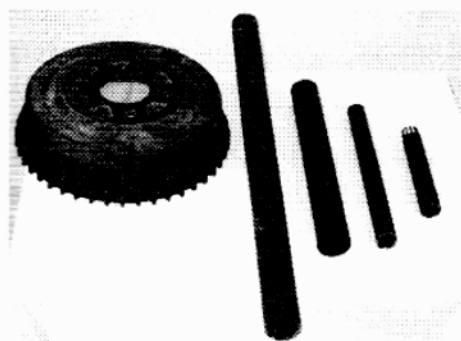

[Figure 7.15]

Junk yards usually carry a large selection of brake drums and metal pipes. Brake drums are very loud. Metal pipes are more resonant but not nearly as loud as brake drums. Anvils (not pictured) are not very common; they have a smaller, brighter sound than the brake drums and are far less loud. The composer should expect that anvil parts will be played on brake drums if anvils are not available.

These instruments are almost always used without specified pitches, even though brake drums and especially metal pipes will tend to have a single identifiable pitch. (See Elliott Carter's *What Next?*, Christopher Rouse's *Ogoun Badagris*, Lou Harrison's *Song of Queztecotl* and *Canticle No. 1*.)

## Thundersheet

A thundersheet is a large thin sheet of metal. It is most often shaken for long notes with sweeping or sporadic dynamics. It is unusual to articulate rhythms on a thundersheet by striking it with sticks or mallets, but this is possible. (See Crumb's *Music for a Summer Evening*.)

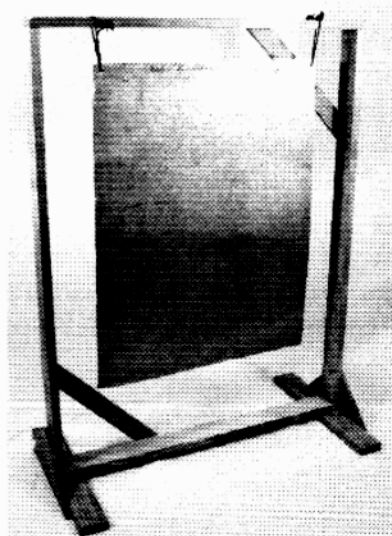

[Figure 7.16]

## Steel drums (steel pans)

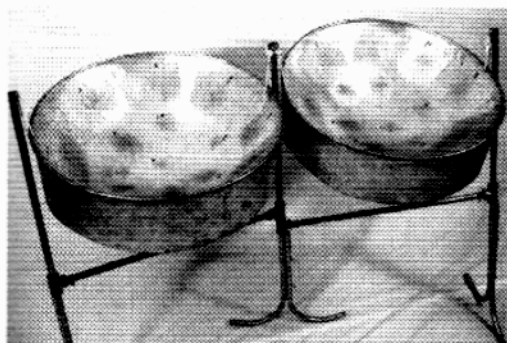

[Figure 7.17]

Tenor and soprano pans are most common. Soprano pans are also called *lead pans* (that is, "lead" as in leader - not the metal). Bass pans are very large (each made from an entire oil barrel) and are not often available.

The ranges are as follows:

- (a) a pair of tenor pans (pictured)
- (b) a soprano pan

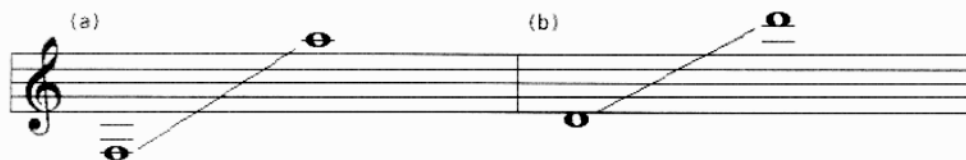

[Figure 7.18]

Bass pans have only three pitches each. The composer should check with the group for whom the piece is written to see which, if any, bass pan pitches are available.

Steel drums are instruments that most percussionists do not practice on a regular or even occasional basis. Unlike all other pitched mallet instruments, pitches are not laid out like a keyboard. To write for steel drums as one would for xylophone, with fast sixteenth note passages, is not practical. Very simple slow passages, isolated notes, or ostinati are far more reasonable (see Boulez's *Sur Incises*).

Steel drums are not very loud. If steel drums are played too loudly, they will be banged out of tune. For this reason, steel drums cannot be expected to project over other loud instruments. *Fortissimo* can be achieved but not like that of a drum or cymbal. Also, steel drums should always be played with special steel drum mallets which are very lightweight soft rubber mallets. If regular marimba or vibraphone mallets are used, they will tend to bang the instrument out of tune. For this reason, the composer should use caution when writing for steel drums in setups and allow time for the performer to switch to steel drum mallets.

### Special effects

#### Scrape

Cymbals and gongs can be scraped with a coin or triangle beater. The back of a marimba, vibe, xylo, or glock mallet can work on cymbals but not very well; a fingernail can work but only at very soft dynamics. To notate a scrape, simply write "scrape" over the note. The length of the note indicates the length of the scrape - not the length of the sustain. A quick scrape with a crescendo is easiest and most effective, but longer scrapes are possible. It will be assumed that the scrape will be left to ring unless otherwise indicated. (See Joseph Schwantner's *Percussion Concerto*, second movement.)

A scrape is sometimes called a cymbal or tam-tam glissando because there is a glissando of overtones. A quick stroke with a crescendo results in a glissando upward (see *Sacrificial Dance* in Stravinsky's *Rite of Spring*).

#### Water

All resonant metal instruments, like gongs, crotales, and triangles, can be lowered into a tub of water to bend the pitch downward. This also dampens the instrument. Bending the pitch upward is only possible if the instrument is struck repeatedly as it is drawn out of the water; if the instrument is struck once and pulled out, the water will immediately dampen the vibrating instrument and the glissando will not sound. The quiet sound of splashing water will surely accompany the dipping and retrieving of the instrument into and from the water. (See Tan Dun's *Concerto for Water Percussion*, Christopher Rouse's *Cello Concerto*, Joseph Schwantner's *Percussion Concerto*, second movement.)

small tam-tam



[Figure 7.19]

It should be understood that logistically, the use of water is often a problem. Most concert halls will prefer to not have water on stage. Tarps or towels will be laid down under and around the large tub of water that is required for these effects. Also, ample time must be allotted for the player to pick up and put down the instrument with minimal drippage and minimal splashing sound.

#### Prepared instruments

A sizzle effect can be created by attaching a coin, paper clip, or thin metal chain to a metal instrument. This is similar to the traditional sizzle cymbal (see *Cymbals* earlier). A manual sizzle can be achieved by holding a triangle beater or coin against the instrument; in this case, the sizzle can be added and taken away as needed while the instrument is resonating.

# 8.

# wood

Instruments covered in this chapter are wood blocks, temple blocks (Chinese blocks), log drums (slit drums), claves, wood drums, and cajón.

## Woodblocks, templeblocks, log drum

Woodblocks are very bright and high-pitched. They come in a variety of sizes and can be used one at a time or in groups (reasonably, up to six). Very small woodblocks are often called *piccolo woodblocks*. (See Copland's *Symphony No. 3*, Prokofiev's *Symphony No. 5*, Christopher Rouse's *Ku-Ka Ilimoku*.)

Templeblocks (also called *Chinese blocks*) are darker and lower-pitched than woodblocks. They most often come in sets of five (sets of six are sometimes available) and are suspended from a stand. (See Michael Torke's *Green*, William Kraft's *Concerto for Timpani*, Rouse's *Violoncello Concerto*, Druckman's *Windows*.) For additional pitches, woodblocks should be used (e.g., five templeblocks and two higher woodblocks make a set of seven graduated wood sounds).

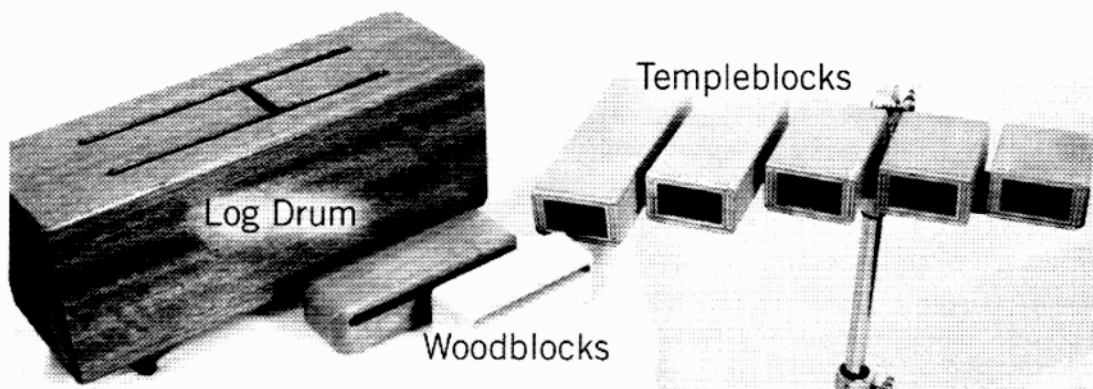

[Figure 8.1]

Plastic versions of wood and temple blocks are also common. They are not as beautiful sounding but can be struck with harder mallets at louder dynamics without breaking.

Woodblocks and templeblocks may be written as one or two words (e.g. *woodblocks* or *wood blocks*, *templeblocks* or *temple blocks*). Either is clearly understood and acceptable.

Log drums (also called *slit drums*) are pitched much lower than wood or temple blocks and have a very warm, mellow sound. A log drum usually has two pitches; multiple log drums can be used together for more pitches. Log drums are especially fragile instruments and should not be played too loudly or with too hard a beater. (See Rouse's *Ku-Ka Ilimoku*, Crumb's *Idyll for the Misbegotten*, Cage's *Third Construction*.)

### Claves

Claves are a traditional Cuban instrument and serve, in that music, as the rhythmic backbone and time keeper. They are held in the hands - one clave is used to strike while the other simply receives the blow and resonates. Since only one hand is used to produce the rhythm, claves can be played only so quickly. If necessary, a single clave can be mounted on a towel or foam rubber and played with xylophone mallets; this allows for passages that require two hands, but sound quality is sacrificed. (See Copland's *El Salon Mexico*, Rouse's *Violoncello Concerto*, John Zorn's *For Your Eyes Only*.)



[Figure 8.2]

### Wood drums

Wood drums are tom-toms with circular pieces of wood (usually one inch thick plywood) in place of the normal drum heads. The sound of the piece of wood is supported by the resonance of the drum shell. Unlike tom-toms, the pitch of a wood drum cannot be tuned higher or lower; it is at a fixed pitch dependent on the piece of wood and the size of the drum shell.

Sometimes a *log drum* is referred to as a *wood drum*, so a short description of the instrument in the score will help clarify.

### Cajón

A cajón (pronounced *ka-HONE*) is a South American and Cuban instrument which is becoming more commonly used in the United States. It is a resonant wooden box which is sat upon or held between the legs and played like a hand drum. All hand drum techniques apply (see **Beaters and Drums**). Cajón is best played with hands, but soft mallets are also appropriate.

# 9.

# miscellaneous instruments

Almost anything can be used as a percussion instrument. The composer should not neglect his or her kitchen, living room, bathroom, garage, or local hardware or toy stores as places to discover usable sounds. Percussionists often use items that one finds in everyday life: pots, pans, glass bottles, plates, silverware, jars, books, children's toys, tables, chairs, car parts, trash cans, trash can lids, floors, walls, ceilings, and even the performer's body and voice. John Zorn's *For Your Eyes Only* calls for the sounds of hammering nails, breaking glass, and a slamming door! Other parts of regular percussion instruments (like the frame of a keyboard instrument or the stand on which a cymbal or drum is mounted) are often employed as instruments themselves. All of the above can be added to the following list of percussion instruments covered in this chapter:

bottles, cabasa, castanets, church bells, coconuts, conch shell, crystal glasses, finger cymbals, flexatone, friction roll, guiro, washboard, hammer as used in Mahler Symphony No. 6, hand bells, lion's roar, maracas, shakers, mark tree, wind chimes, bell tree, pop gun, quica, rainstick, ratchet, rice bowls, rute, sandpaper blocks, sirens, slapstick, whip, sleighbells, stones, tambourine, thumb piano, vibraslap, whistles, and wind machine.

## **Bottles**

The mouth of a glass or plastic bottle can be blown over in the same manner one would play a flute. Specific pitches can be tuned by adjusting the amount of liquid in the bottle. A slight pitch bend can be achieved by changing the amount of lip placed over the hole. Glass bottles can also be struck with sticks or mallets.

**Cabasa**

Cabasa (afuche cabasa) is usually held by both hands, but can be mounted for one-handed operation. Different note lengths can be achieved (a half note at  $\text{♩}=120$  at the longest). The cabasa is not a particularly loud instrument, and when louder dynamics are requested, only shorter note values are possible. Rolls can be executed by rapidly twisting back and forth or even shaking the cabasa (this only requires one hand); however, rolls on this instrument are not very successful.

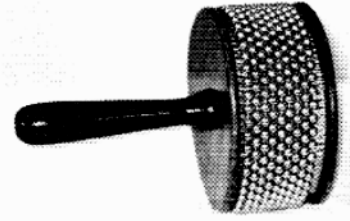

[Figure 9.1]

**Castanets**

The castanet sound is produced with the clapping of two cup shaped pieces of wood against each other. Traditional castanets (held in the hand and played while dancing) are not generally used in concert music; the castanets used by percussionists are mounted to handles or to a stand. Castanets with handles are held and played by striking the player's knee. Mounted castanets (called *machine castanets*) are struck with the hands or mallets and sometimes with other hand-held castanets for especially loud passages. (See Prokofiev's Piano Concerto No. 3 and Violin Concerto No. 2, Ravel's *Alborada del Gracioso*.)

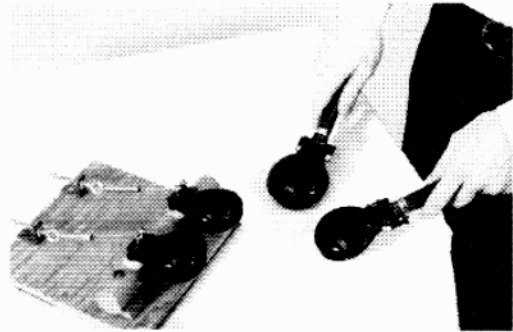

[Figure 9.2]

Rolls can be executed with both types of castanets. At loud dynamics a double-stroke roll is possible with hand-held castanets where the clappers rebound back into each other after striking the knee. This is a fuller sounding roll and is not possible on machine castanets.

Hand-held castanets can technically be used as beaters on drums, but this will damage the castanets and is not recommended.

Two pairs of finger cymbals are sometimes used as *metal castanets*. One pair rests on a table while the other pair is held and used to strike the resting cymbals.

**Church Bells (ship bells, Berlioz bells)**

Since Berlioz's *Symphonie Fantastique* is so frequently performed, some orchestras and conservatories own a pair of large church bells that are tuned C4 (middle C) and G3 or C3 and G2 for the last movement. These pitches will likely have some discordant overtones which allow them to work, to some extent, as unpitched instruments. These bells are played with chime hammers.

**Coconuts**

Coconut halves struck on a tabletop is a classic sound effect used to imitate horse hooves.

**Conch shell**

Conch shell is blown through like a brass instrument. Percussionists should be expected to play no more than one pitch with a steady fortissimo dynamic, not very lengthy sustain, and not very fast articulations (see John Cage's *Third Construction*). In the hands of a brass player, however, much more is possible, such as more complex dynamics and articulations, longer durations, and limited pitch control (through placement of a hand inside the "bell" of the shell and manipulation of the embouchure).

## Crystal glasses

Crystal glasses can be struck (not too loudly or else they will break), rubbed, and bowed. When a glass is rubbed around its top edge with a moistened finger, the glass will quietly hum a pitch. A glass will require about a second of rubbing before it will speak so fast passages on rubbed glasses are impossible. Glasses can also be bowed with a bass or cello bow; this is a perfect alternative to rubbing when loud dynamics are needed. Glasses can be tuned to specific pitches by adjusting the amount of water they hold. (See George Crumb's *Black Angels*, Joseph Schwantner's *...and the mountains rising nowhere*.)

## Finger cymbals

Finger cymbals are usually used for single notes, but quicker rhythms are possible. These instruments are played by striking the edges of the two cymbals together - not like crash cymbals where the cymbals are struck together on their flat surfaces. Finger cymbals are not very loud but have a lot of cutting power due to their high pitch. They can also be hung from a stand and struck with a plastic mallet, brass mallet, or a triangle beater. (See Bernstein's *West Side Story*, Jacob Druckman's *Animus II*, Luciano Berio's *Circles*.)



[Figure 9.3]

Two pairs of finger cymbals are sometimes used as metal castanets (see *Castanets*).

## Flexatone

Flexatone is inspired by but only loosely resembles the musical saw. It is a small thin piece of metal on which two mallets are mounted. It is held so the piece of metal can be bent to alter its pitch. When shaken, the mounted mallets bounce back and forth to create a tremolo. Specific pitches are difficult but possible; glissandi without specific pitch are easily executed. Flexatones can also be bowed for a sound more similar to that of a musical saw. The flexatone is played with one hand; bowing requires two. (See Jacob Druckman's *Animus II*, Steven Mackey's *Eating Greens*, Schoenberg's *Variations*.)



[Figure 9.4]

Flexatones are available in two sizes (large and small) with the following ranges:

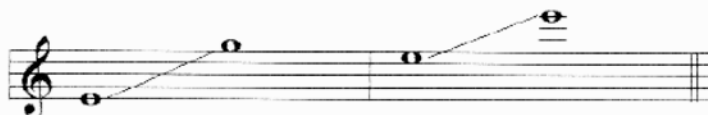

[Figure 9.5]

## Friction Roll (finger rub and Superball mallets)

A surface can be rubbed with a finger to create a groaning sound. This technique is similar to bowing in that it rapidly reattacks a surface to create a sustained sound. A friction roll on large drums (bass drums, timpani, large toms) could replace the sound of a lion's roar (see *Lion's Roar* later in this chapter). Deep groans can be rubbed out of walls, floors, wooden boxes, piano sound boards, etc. On smaller drums with tighter heads, this sounds more like a very rapid tremolo.

A Superball mallet is a Superball attached to a piece of coat hanger or another slightly flexible piece of metal or wood. A Superball mallet, dragged against a surface, creates a groaning sound like that of a finger rub. The Superball may be slightly easier to use than a finger because the degree of friction tends to be more consistent. The use of either a finger or a Superball can be the choice of the performer. (See George Crumb's *Idyll for the Misbegotten*, Lukas Foss's *Thirteen Ways of Looking at a Blackbird*.)

**Guiro (gourd), washboard**

Guiros are tube-shaped instruments with a series of grooves along the body. They come in many different sizes and are made of metal, wood, plastic, or traditionally, a hollowed-out gourd. Guiros can be scraped with small wooden or plastic dowels, the shafts of keyboard mallets, triangle beaters, wire rakes, or hair picks. Guiros are usually held in one hand and scraped by the other but can be mounted if necessary. The length of the note can be controlled to a certain degree and fairly quick rhythms can be articulated by using up and down scrapes (comfortably, sixteenth notes at  $\text{♩}=110$ ). Very long sustained notes are not easy but possible at soft dynamics. The pitch produced depends on the size of the instrument and the speed of the scrape (a faster scrape will produce a higher pitch and louder dynamic). (See Copland's *Billy the Kid*, David Lang's *Scraping Song*, Christopher Rouse's *Violoncello Concerto* and *Percussion Concerto*.)



[Figure 9.6]

Washboards are large grooved boards made of wood or metal. They can be much louder than guiros and are often used in place of guiros if especially loud dynamics are required (like Stravinsky's *Rite of Spring*). The grooves are much larger so larger scrapers, like snare sticks, can be used. In traditional jug band music, the washboard is worn around the player's neck and scraped and struck with thimbles worn on the fingers.

**Hammer as used in Mahler Symphony No. 6**

The two, arguably three, hammer strokes in Mahler's 6th Symphony have quite a powerful aural and visual effect. This instrument has been used in modern scores by various composers, most notably Christopher Rouse. It is, as Mahler describes, "a short, powerful, but dull-sounding stroke of nonmetallic character." It is marked at *fortississimo*. Orchestras often use a large plywood box which is struck with a large wooden hammer. Due to the size of the hammer, quick rhythms cannot be executed - loud isolated notes are most common. (See Mahler's Symphony No. 6, Rouse's *Gorgon*.)

**Hand bells**

Pitched hand bells are most commonly found in churches that have a hand bell choir. These instruments, however, are rarely found in percussion instrument collections. Hand bells are played by bouncing a clapper, mounted inside the bell, against the inside of the bell. One player can operate two bells at a time. The clapper has two striking surfaces - one soft and one hard.

Unpitched hand bells are common (like those elementary school teachers might use to call kids in from recess). They are used for tremolos rather than specific rhythms. There are many different kinds: the regular dinner bell (which comes in many different sizes) and other exotic bells like elephant and water buffalo bells (see Lou Harrison's *Canticle No. 1*).

**Lion's roar**

Lion's roar (also called *string drum*) is a drum with a string attached to the center of the drum head. Rosin is applied to the string. With a small piece of moistened cloth in hand, the player rubs the taut string thus vibrating the drum head to create a roaring sound. A small amount of time is needed to pick up the piece of cloth and get into position to play the lion's roar. Long sustained notes are most common - short rhythmic passages are impractical. (See Cage's *Third Construction*, Varèse's *Amérique*.) A friction roll on a large drum (see **Friction Roll**) can replace a lion's roar although it may not be as loud. Faster rhythms and some pitch control can be achieved on a quica (see **Quica**), which is similar to a lion's roar.



## Maracas, shakers

Maracas are gourds (or gourd-like containers made of wood, plastic, metal, or rawhide) filled with beads and attached to a handle. They are generally used in pairs. Rhythms are executed with a regular downward stroke or with downward and upward strokes where the beads strike the bottom and top of the inside of the gourd. Maracas are available in a variety of sizes and materials for many different timbres.

A pair of maracas with the same timbre is most often used, but two differently sounding maracas can be requested (e.g., one high and one low maraca).

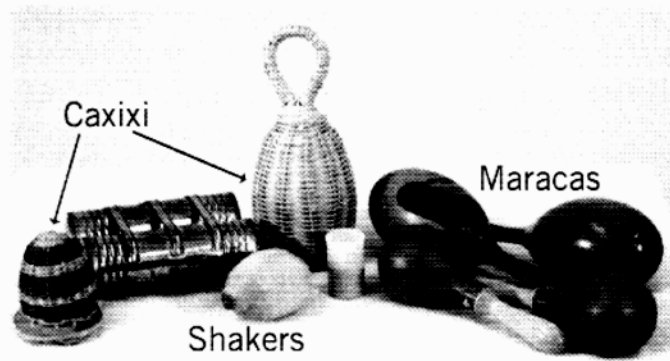

[Figure 9.7]

Rolls are executed by spinning or rapidly shaking the maracas. A spun roll is produced by holding the maraca upside-down and moving it in a stirring motion as if mixing the contents of a bowl (see Crumb's *Music for a Summer Evening*, Rouse's *Violoncello Concerto*). This type of roll is smooth and seamless but not always loud enough - the shake roll is much louder. Specification of roll type is not necessary.

Maracas can be mounted on a towel or piece of foam and struck with a hand or a beater. This facilitates the playing of maracas included in setups, but volume and sound quality of the instrument are greatly sacrificed. It is also difficult to get a mounted maraca to speak on time; the beads move inside the maraca in such a way that it will speak slightly after it is struck.

Maracas can be used on drums (as in Bernstein's *West Side Story* and *Jeremiah*), but this can damage nicer maracas; quality maracas will usually be substituted with more durable maracas. For this purpose, some manufacturers have created specialty maraca-mallets which have beads inside the mallet head.

There are an infinite number of other shakers - everything from traditional African or South American sounds to beads in a soda can. Percussionists often make their own shakers. Maracas are typically used in pairs while shakers are used one at a time (although the use of one maraca or two shakers is acceptable). More involved rhythms are often notated for maracas; with shakers, it is more common to simply play steady time.

A shaker will produce two different strokes: a forward stroke and a back stroke; the subtle difference between these two sounds is like that of the up-bow and down-bow of a violin. (See Frank Zappa's *Outrage at Valdez*. Steve Reich's *Tehillim* and *Music for Eighteen Musicians* have parts for maracas which would be very appropriate for shaker. Cage's *Third Construction* uses maracas and a variety of shakers and rattles.)

When a shaker is shaken quietly, the attacks become less articulate. If articulate soft shaker strokes are desired, then a shaker made specifically for soft dynamics can be used. Percussionists will usually have many types of shakers for various timbres and dynamics.

The tone color of the shaker can be adjusted by covering the surface of the instrument. Covering more of the shaker with one's hand will muffle high overtones. This makes the instrument softer and darker.

Caxixi (pronounced *cah-SHEE-shee*) is a special type of shaker (see Figure 9.7). The caxixi has a harder surface at its bottom for a louder, brighter color. It can be shaken side-to-side, like a normal shaker, or top-to-bottom to make use of the different colors.

Various shakers or bells can be attached to a player's ankles, wrists, or beaters to accompany the motion of stomping or playing of other instruments (see James Wood's *Village Burial with Fire*, Sofia Gubaidulina's *In the Beginning there was Rhythm*).

### Mark tree, wind chimes, bell tree

Mark tree is a row of small metal chimes which are organized in pitch from high to low. A glissando up or down is produced by running a finger or beater through it. Mark trees continue swinging back and forth after they are struck and are usually left to exhaust themselves naturally (which takes about six seconds). Dampening mark trees requires a couple seconds to execute effectively; some mark trees have a muffle bar with which the performer can muffle more quickly. Glissando direction and duration (no longer than three seconds) should be indicated. (See Per Nørgård's *I Ching*, John Zorn's *For Your Eyes Only*, Frank Zappa's *Dog Breath Variations/Uncle Meat*.)

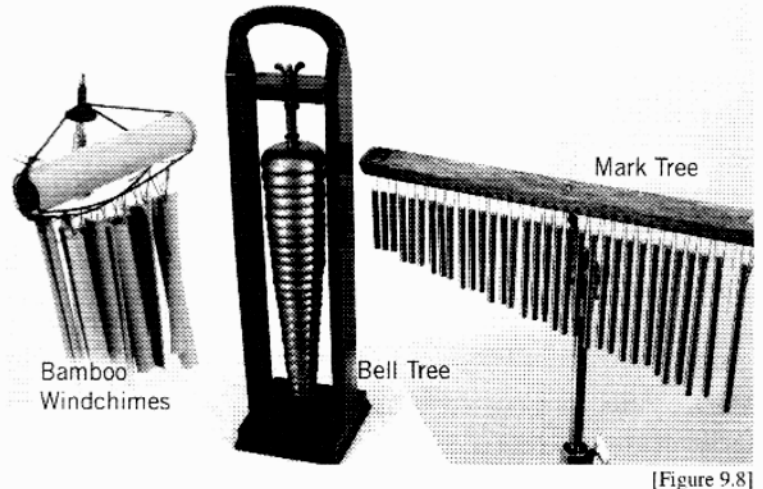

[Figure 9.8]

mark tree

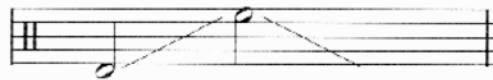

[Figure 9.9]

Wind chimes are very common (often found on one's back porch). They are usually made of metal but also, when specified, of bamboo or glass. Wind chimes have a much shorter ring time than mark trees (about a second or two) so note length can be easily controlled. They can be sustained by noodling one's fingers through them, they can be struck with a sharp attack and left to decay, or they can be clapped together and then held to stop the sound dead (often called a *wind chime choke*). After the chimes have been choked, the performer must eventually let go; this can be notated as a separate sound. If a silent release is desired, it must be done very slowly and carefully. (See Jacob Druckman's *Animus II*, Luciano Berio's *Circles*.)

Notation for wind chimes is vague, usually a single hit with its natural decay or a trill or tremolo to indicate a sustained tone.

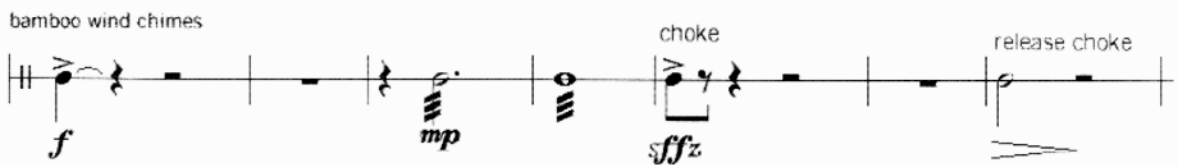

[Figure 9.10]

The composer should be careful not to write "chimes" if wind chimes are desired; "chimes" will indicate *tubular bells*.

Mark trees and wind chimes are sensitive and can be set into motion with just a light brush of a hand, body, or stick. For this reason, accidental mark tree/wind chime solos can occur during rehearsals and performances. In setups involving these instruments, care must be taken to avoid this. This is, of course, the performer's problem, but the composer should be aware of it.

Bell tree is a series of bells mounted on a stand and organized (inexactly) from high to low. It is similar to the mark tree but only sounds when struck (with a glock mallet, xylo mallet, or triangle beater) - there are no swinging parts. Glissandi, as well as random or relatively pitched single notes, can be played on a bell tree. Glissando direction and duration should be notated. If just a quick glissando is needed, be sure to indicate whether it should go to or start on the beat. (See Per Nørgård's *I Ching*, Steely Dan's *Babylon Sisters* and *Gaucha*.)



[Figure 9.11]

The bells of a bell tree are not exactly arranged in order of pitch - they are slightly mixed up. The microtonal scale stumbles upward and falls back down every couple of notes. In the context of a glissando, this mixed-up arrangement is not noticeable; it simply makes the glissando sound fuller.

### Pop gun

The pop of a pop gun is produced by forcing a cork out of a tube by pumping air into the other end. Once popped, the pop gun needs to be reloaded before it can be popped again; this takes only about a second. Operating a pop gun requires two hands, but it can be mounted and played with one hand if absolutely necessary. Only one dynamic, *forte*, should be requested.

### Quica (cuica)

Quica is a traditional Brazilian instrument. It is a small metal drum with a thin wood dowel attached to the inner side of the head. With a wet cloth, the wood dowel is rubbed (similar to the string of the lion's roar - see *Lion's Roar*) to create a moaning sound. The pitch can be altered by pressing on the head to different degrees. Specific pitches are not practical, but a few relative pitches can be executed. Specific note lengths up to a second long and rhythms no faster than sixteenth notes at  $\downarrow=100$  are possible. Some time must be allowed (about two or three seconds) for the percussionist to pick the quica up and get it into playing position. (See Rouse's *Infernal Machine*, John Zorn's *For Your Eyes Only*.)



[Figure 9.12]

### Rainstick

Rainstick is a long tube filled with beads. When the tube is tipped, the beads fall and filter slowly down the body of the tube. This sounds like rain. Dynamics can be controlled with the speed of the falling beads which is dependent on the angle the tube is tipped. Very precise stopping and starting of the rain sound should not be expected. The rainstick can also be used as a giant shaker.

### Ratchet

Ratchet is a fairly limited instrument. Very little dynamic control is possible; cranking faster will give the impression of louder volume, but the volume does not actually increase much. For a real dynamic variety, multiple ratchets with different loudnesses can be used. A rhythm executed on ratchet will not be articulated with single clicks but rather with short bursts of many clicks. Note length should be notated accurately. (See Richard Strauss's *Till Eulenspiegel*, Christopher Rouse's *Gorgon*, Moussorgsky/Ravel's *Pictures at an Exhibition*.)

Very large ratchets do exist but are not common. These are louder and have slower clicks so specific rhythms can be articulated (see Ottorino Respighi's *Pines of Rome*).



[Figure 9.13]

### Rice bowls

Rice bowls are small ceramic bowls which are usually struck with chopsticks. They can be used in sets with or without pitch specification. (See Henry Cowell's *Ostinato Pianissimo*.)

### Rute

Rute is a bunch of wooden dowels or twigs tied together (see Figure 9.14). Traditionally, the rute is rather large and struck on the shell of the bass drum to produce more of the sound of the rute than of the shell (see Mahler's *Symphony No. 2*, third movement). This instrument has now been adapted to about the size of a snare stick and can be used as an effect on drums, cymbals, and other instruments. The newer sticks were originally made for softer drumset playing (for low volume ensembles and practice). Both rute types are common.



[Figure 9.14]

### Sandpaper blocks

Sandpaper blocks are two pieces of sandpaper attached to blocks of wood (or another material) so that the sandpaper can be scraped together. Rhythms are easily executed and sustained notes can be achieved by scraping in a circular motion. Sandpaper blocks are not very loud. The coarseness of the sandpaper will affect the sound and volume. This instrument is usually held in both hands, but one of the blocks can be secured to a table for one-handed operation if necessary. (See John Adams's *Chairman Dances*, George Gershwin's *Porgy and Bess*.)

### Sirens

Siren whistles are very inexpensive, easy to find, and are ideal for a comical effect. Hand-crank sirens (like those used for the music of Edgar Varèse) are not nearly as common and have a much more serious and alarming sound. With both types of sirens, the louder it is played, the higher the pitch. Stopping a siren short may not be possible with certain hand-crank sirens so it may be necessary to let them die out on their own (this could take up to five seconds). Percussionists will find ways, if absolutely necessary, to halt the siren by jamming something in the mechanism (although this might damage the instrument). Notation is usually rather vague; a wavy line indicates relative pitch and volume (see Figure 9.15). (See siren whistles in Iannis Xenakis's *Persephassa*, David Rakowski's *Ten of a Kind*; crank sirens in Varèse's *Amérique* and *Ionisation*.)

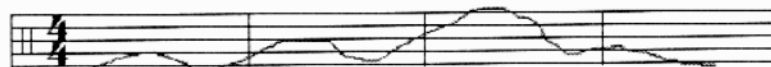

[Figure 9.15]

### Slapstick, whip

Slapstick is two pieces of wood slapped together to make a sound similar to that of a whip crack. Often, if “whip” is notated, a slapstick will be used. The use of an actual bull whip is rare for a number of reasons: the desired whip sound is difficult to get consistently, placing a whip crack accurately in time is extremely difficult, and a lot of space is needed to crack a whip without injuring someone. The only advantage to the real whip is the visual effect, which is powerful but which usually does not outweigh the whip’s musical and logistical drawbacks.



[Figure 9.16]

Slapstick cannot be played too quickly (not much faster than eighth notes at  $\text{♩}=120$ ). Two hands are used to operate a slapstick, but it can be placed on a trap table and operated with one hand if necessary. Spring-loaded slapsticks also exist which require only one hand; these are less accurate and can only execute slower rhythms. (See Mahler’s *Symphony No. 5*, Copland’s *Symphony No. 3*, Messiaen’s *Turangalila-Symphonie*.)

### Sleighbells

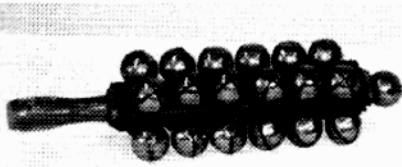

[Figure 9.17]

One can articulate rhythms on sleighbells by holding them down (with the handle facing up) and striking the top of the handle with a fist. They can also be shaken - notated with a tremolo. Enough time should be allotted for the percussionist to pick up the sleighbells without creating any unwanted jingling. (See Mahler’s *Symphony No. 4*, Copland’s *Billy the Kid*, Per Nørgård’s *I Ching*.)

### Stones, prayer stones

Two regular stones can be struck together. This is not very loud.

Prayer stones are not necessarily special stones, but rather stones played with a special technique. One stone is held in a cupped hand and is struck by the other stone. The shape of the cupped hand is altered to emphasize different overtones. This is a soft subtle effect. Specific pitches should not be written. (See Crumb’s *Ancient Voices of Children*.)

### Tambourine

Tambourine has been used by many cultures around the world. As a result, there are many different types of tambourines and many different playing styles.



[Figure 9.18]

The traditional orchestral tambourine is ten inches in diameter and has a single head. The sound of the head is secondary, and rather it is the sound of the jingles that is most important. The jingles are made from a variety of materials that produce different sounds; the composer may specify “bright” or “dark” sounding jingles, but this is not necessary or common. The tambourine is usually held but can be mounted or rested on a table. It is traditionally played with a hand, but sticks and mallets can be used.

Tambourine is usually held in one hand so fast rhythms which require two hands can present problems. Percussionists employ a variety of techniques to make faster rhythms possible: for fast soft passages, the tambourine will often be rested on the player’s leg and played with both hands; for loud passages, the player’s knee is often used as an extra fist to strike the tambourine. The

techniques used will vary depending on the passage, the particular instrument used, and the player's preference. The specific means of execution should not be a concern of the composer. (See Bizet's *Carmen*, Tchaikovsky's *Nutcracker*, Varèse's *Amérique*.)

Rolls can be executed by shaking the tambourine or rubbing a thumb or finger along the edge of the head (see **Friction Roll**). To specify, one can write "shake" or "thumb roll"; however, specifying roll type is not necessary. (See Stravinsky's *Tableau 4* of *Petrouchka*, Britten's *Storm* from the *Peter Grimes Four Sea Interludes*.)

If the tambourine is mounted and played loudly with a stick, percussionists will often substitute a drumset tambourine in place of a regular orchestral tambourine. Drumset tambourines are made of plastic, have no head, are brighter and drier than orchestral tambourines, and are built to withstand the abuse of snare drum sticks. The use of this type of instrument does not need to be specified. The drumset tambourine is simply a mountable version of an average Rock 'n' Roll style tambourine.

There are many ethnic tambourines from all over the world. The pandeiro and the riq<sup>1</sup> are probably the most notable in this context, although there are many others of equal musical and cultural importance. A pandeiro is a Brazilian instrument that is usually larger than a normal orchestral tambourine and has thicker jingles (see Figure 9.19a). With this instrument, the head sound is of equal importance to the jingle sound. The riq is a Persian instrument, slightly smaller than a normal orchestral tambourine, and also has thicker jingles (see Figure 9.19b). It is held vertically, like a frame drum, and played mostly with individual fingers. Unique to the riq is the striking of the jingles - not just the head. One hand primarily plays the jingles while the other hand moves between the jingles and the head.

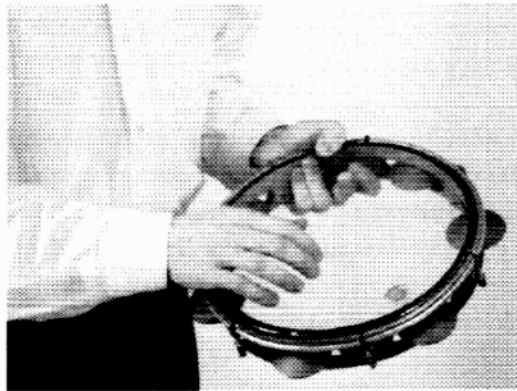

[Figure 9.19a]



[Figure 9.19b]

Pandeiro and riq playing is typically improvised. To use these instruments in a concert setting, a guide for improvisation may be better than a completely written-out part. For more detailed pandeiro and riq information, please consult a percussionist.

All pandeiro, riq, and frame drum techniques can be applied to all tambourines.

### **Thumb piano (African thumb piano, kalimba, mbira)**

Thumb piano is a set of small metal strips attached to a resonating chamber (such as a wooden box or a hollowed gourd) and tuned to specific pitches. The number of metal strips varies but there will be at least eight. The strips can be tuned by adjusting their length, but this cannot be done during performance - they must be preset. Thumb piano is not especially loud and is often amplified electronically or by the use of a sympathetically resonating acoustic instrument (with piano in George Crumb's *Music for a Summer Evening* and a timpano in Per Nørgård's *I Ching*).

1. "Pandeiro" and "riq" are among a few acceptable spellings of the names of these instruments.

### Vibraslap

Vibraslap is a modern invention that replaced the *jawbone of an ass* or *quijada*. It has about a one to four second decay but can be muted with a hand for shorter notes. It is usually held but can be mounted if necessary. It is best struck with a hand, but a stick or mallet could be used. (See John Cage's *Third Construction*, Jacob Druckman's *Aureole*.)



[Figure 9.20]

### Whistles

There are many types of whistles like bird calls and those used in various African and Latin American traditions. Bird calls come in many varieties depending on the bird (crow, cuckoo, dove, duck, jay, nightingale, etc.). Other non-bird whistles include police, samba, train, siren (see *Sirens*), and slide. Most whistles can be hung around the neck for quick pickup. Some can be held in the mouth without the help of a hand so the hands may do other things. Samba whistles have two pitches, but one hand is needed to open and close the hole that controls the pitch. Simple melodies can be executed on slide whistle; these instruments require two hands - one to hold the whistle and the other to operate the slide. (See slide whistle in George Crumb's *Music for a Summer Evening*; police whistle in Leonard Bernstein's *West Side Story*; police and samba whistle in Steven Mackey's *Tuck and Roll* and *Pedal Tones*.)

Tin whistles and penny whistles are probably better suited for wind players to play (at the risk of orchestra doubling fees). Ocarinas are simple enough for percussionists, but instruments with specific pitches may not be easy to find (see Gyorgy Ligeti's *Concerto for Violin*).

### Wind machine

Wind machine has a canvas that is pulled tightly down over what looks like a small water wheel. The wheel is hand-cranked and spun so it rubs against the canvas. Only long notes with big swooping dynamics are possible. Just as with a crank siren, an increase in dynamic will always result in an increase of pitch, and vice versa. (See Strauss's *Alpine Symphony* or *Don Quixote*, Ravel's *Daphnis et Chloe*.)

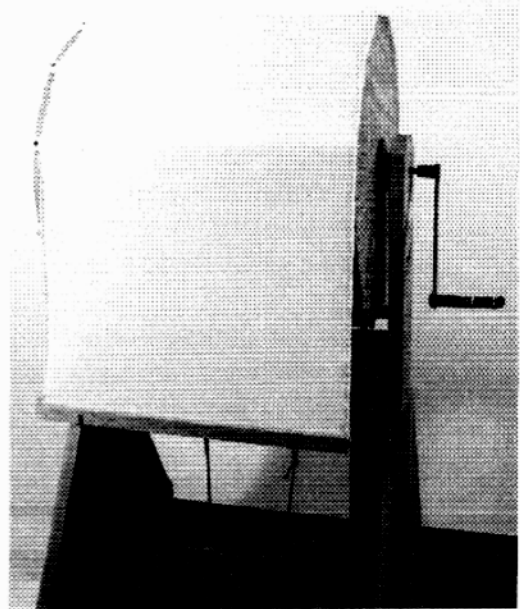

[Figure 9.21]

# Appendix A

## sample setups

This section provides a variety of sample instrument lists, setup diagrams, and instrument keys. These diagrams represent some of the many ways to set up each group of instruments. Specific placement of some instruments may change depending on the writing in the particular piece, the size and shape of the instruments available, and the performer's preference.

There is no standard method of drawing percussion setup diagrams. The composer should feel free to draw diagrams in the fashion he or she feels best represents the setup.

If the part is conceived for a specific setup, then it is helpful to include a diagram at the beginning of the score and part. If the part was written without a visual image of the setup in mind, then a diagram should only be included, if at all, after the piece has been worked out by a performer.

In many of the examples below, the setups are rather simple and a diagram in the score would not be necessary. These diagrams are included here to give the composer an idea of how a percussionist might set up these instruments and how the setup relates to the staff notation.

All of these setups would likely include a trap table or two. Placement of trap tables and music stands, although often very important, is not necessary in setup diagrams. Trap tables and music stands may be included, if at all, after the piece has been worked out by a performer.

The X indicates the position(s) of the performer. Multiple X's mean multiple player positions - not multiple players. The audience is located at the top of the page unless otherwise indicated. When the instruments are numbered, 1 is the highest pitch. Instruments are not drawn to scale.



suspended cymbal  
 2 bongos  
 2 timbales  
 bass drum

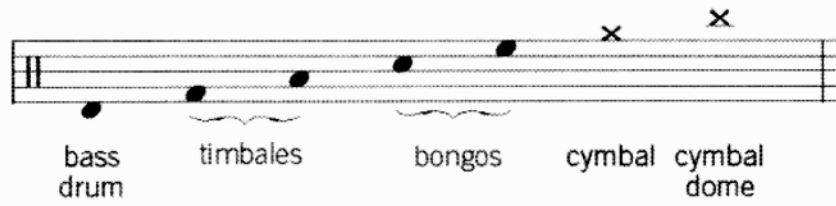
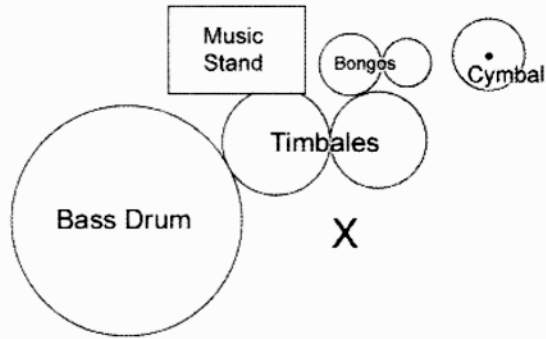

3 woodblocks  
 vibraphone

The woodblocks would likely be mounted on a trap table.

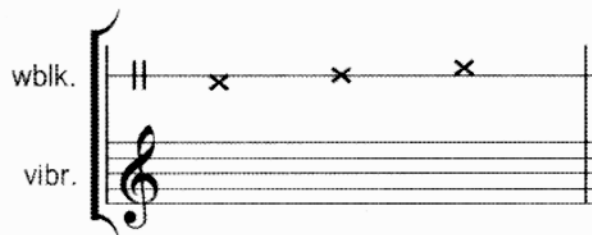
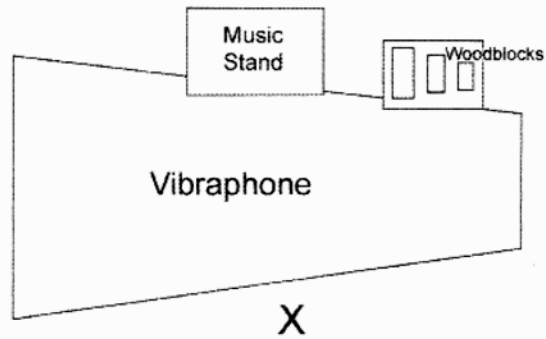

2 octaves of crotales  
 snare drum  
 sleighbells  
 triangle  
 tambourine  
 pair of maracas  
 slapstick  
 guiro

The small hand-held instruments would rest on a trap table. Placement of small instruments does not need to be included in a setup diagram, especially in a setup this small. The two octaves of crotales can be placed next to each other or stacked with the lowest octave closer to the player. The latter is a more compact and centered setup but requires the player to think of the keyboard in an unusual way. This arrangement also makes it difficult to bow the notes on the inside of the stacked instruments.

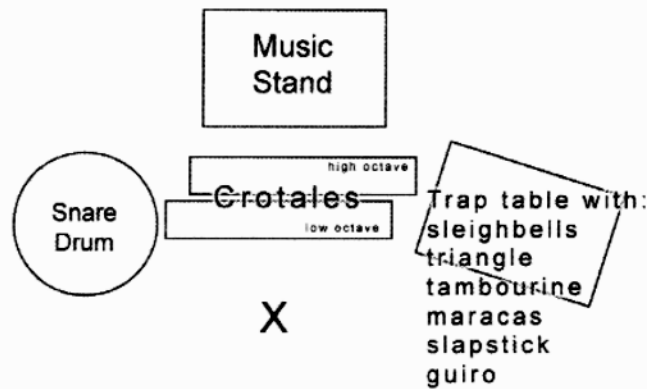
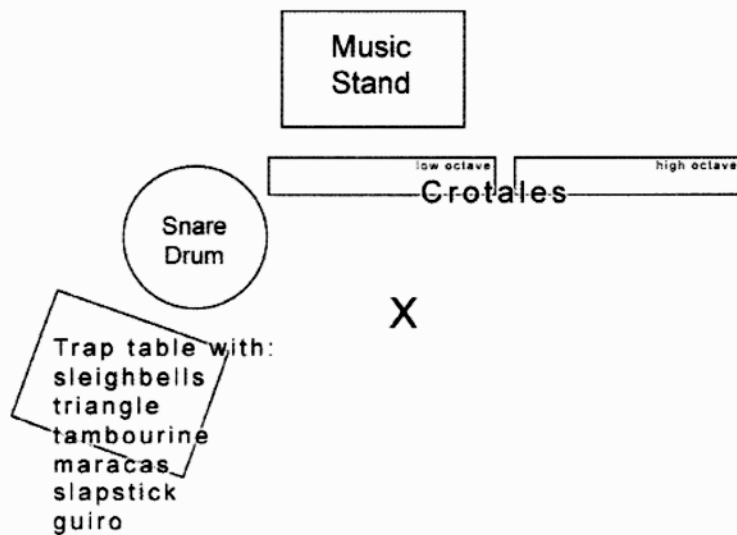

- 2 woodblocks
- 3 cowbells
- 2 tom-toms
- vibraphone

For a simple part, just music stand A would be used for the whole setup. If there are complicated passages on both the vibraphone and the unpitched instruments, then stands B and C may be preferred. This is entirely the player's preference. If there are complicated passages in two separate areas of a setup, the composer may want to supply two copies of the part. The woodblocks and cowbells would likely be mounted on a trap table.

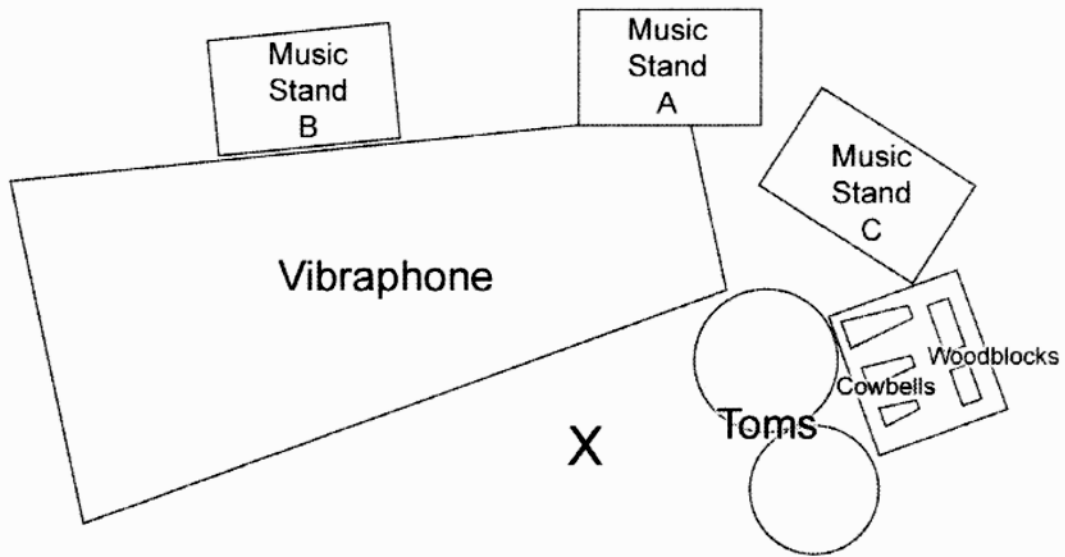

- 5 tin cans
- 2 bongos
- 3 tom-toms
- 2 timpani

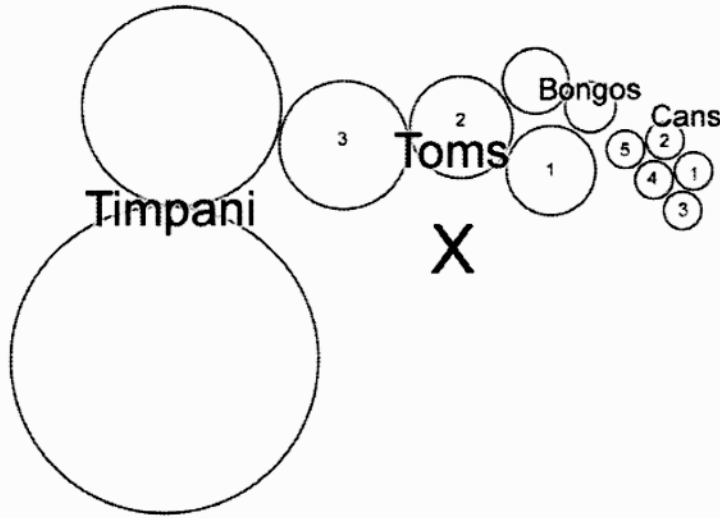

If the timpani have the same pitches throughout, they can be notated as unpitched instruments with the pitches indicated in the instrument list (see Figure 2.16).

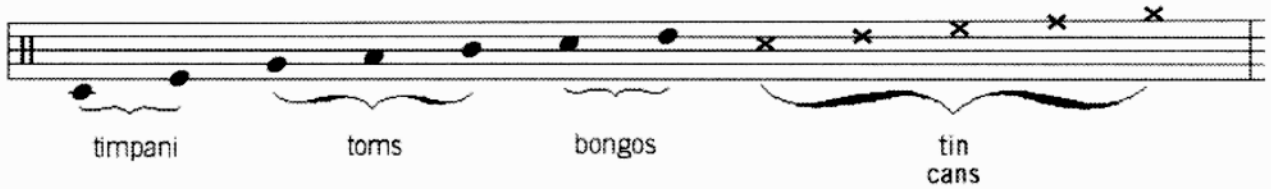

If the timpani pitch is manipulated during the piece, this notation is more appropriate.

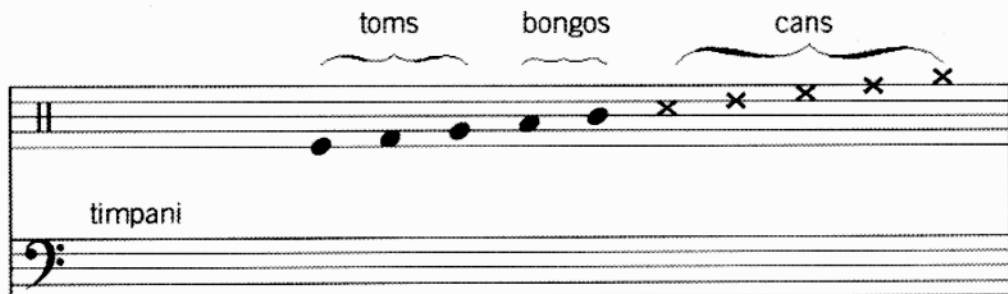

glockenspiel  
vibraphone  
triangle

Since the triangle is so small, it can be placed just about anywhere. Here, it is clipped to the music stand.

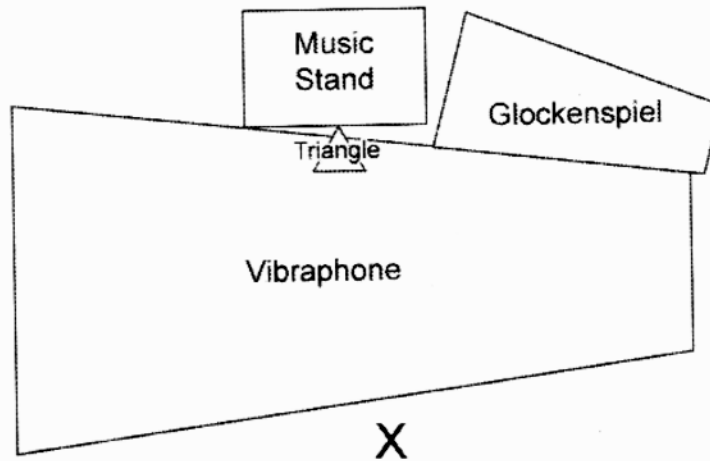

If the writing is sparse, the vibes and glock could be notated on the same staff and distinguished between with the written instrument name and with note stem directions. Otherwise, two separate staves should be used.

low octave of crotales  
 glockenspiel  
 3 suspended cymbals  
 3 triangles  
 bongo

Although only one bongo is required, both are present since bongos are attached in pairs. The triangles would hang from a stand.

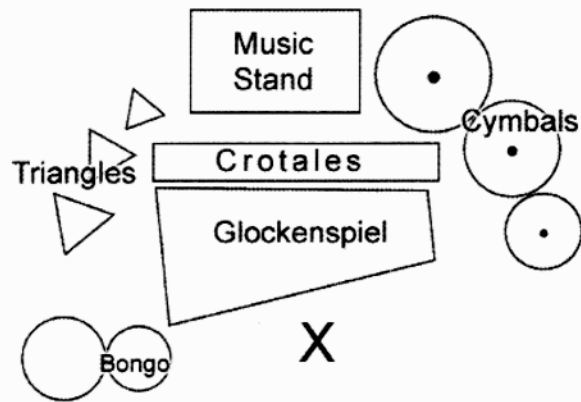

Depending on how they are used, the glockenspiel and crotales could be notated on the same staff or as follows:

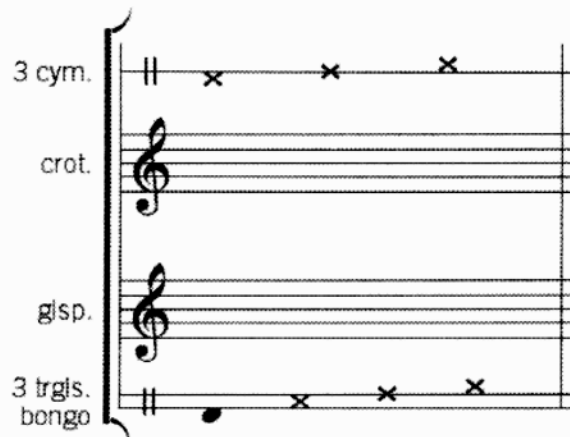

5 metal pipes  
5 tom-toms  
pedal bass drum

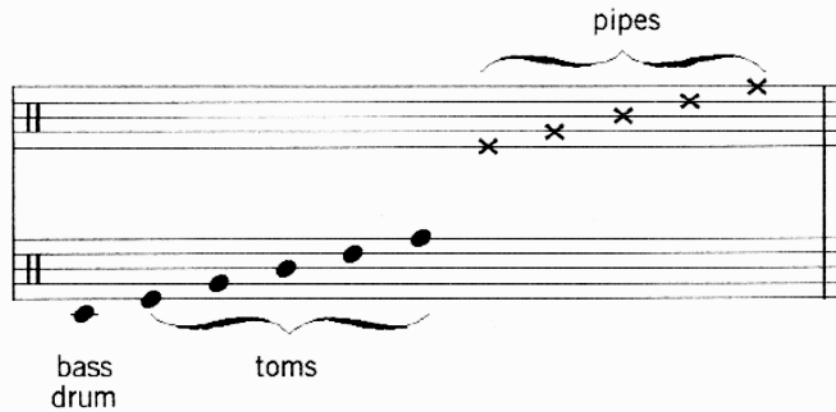
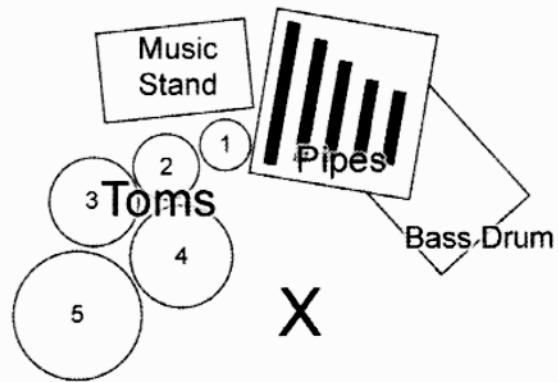

2 bongos (with hands)  
 2 congas (with hands)  
 hi-hat

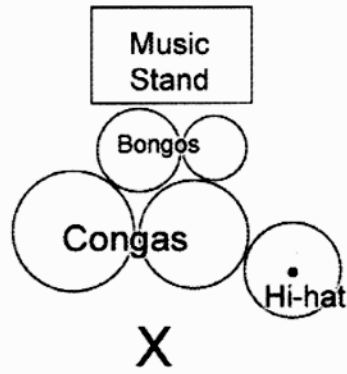

2 congas (bass, tone, slap)      2 bongos (tone, rim)      hi-hat w/ hand (open, closed)      hi-hat w/ foot (open, closed)

B T S B T S T R T R      x + o +      x x

congas      bongos      hi-hat w/ hand      hi-hat w/ foot

bass tone slap bass tone slap tone rim tone rim open closed open closed      x + o +      x x



- 2 cowbells
- 2 bongos
- 3 tom-toms
- 2 suspended cymbals
- china cymbal
- pedal bass drum
- tam-tam

With a large tam-tam, a low tam-tam stand behind the player would probably be used (diagram A).  
 If a small tam-tam were used, it could be mounted higher, above the bass drum (diagram B).

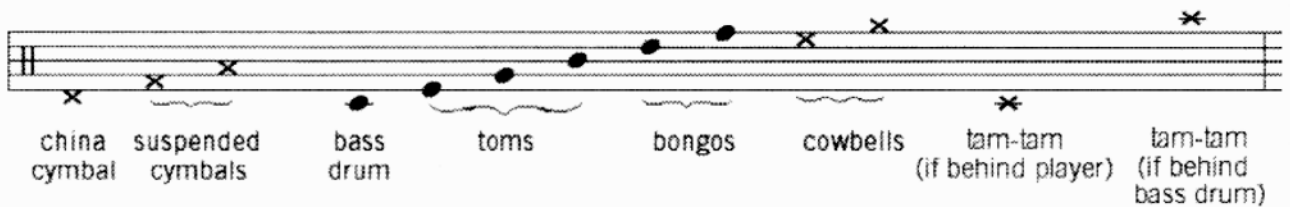
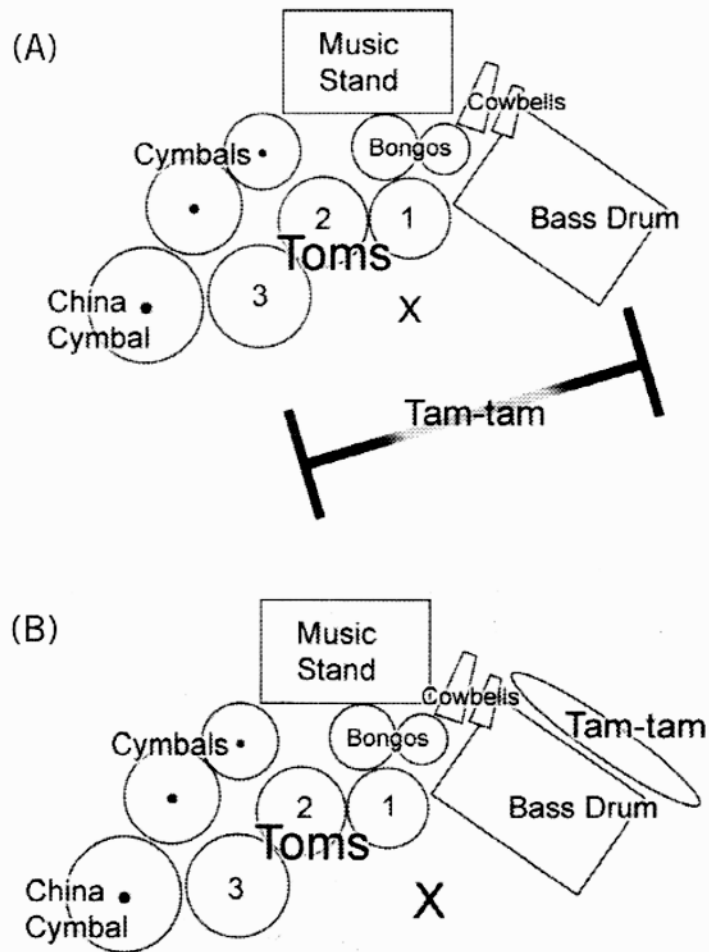

marimba  
 vibraphone  
 4 tom-toms  
 bass drum  
 2 suspended cymbals  
 tam-tam

If all the instruments are used together, this is one possible setup. The bass drum is located to the right of the toms (it would normally be on the left) so the toms can be located closer to the mallet instruments. If the bass drum was on the other side, the toms would be very far from the rest of the action. It will be a small task for the player to get used to playing the part with the bass drum on the "wrong" side. If the composer wrote specifically for this setup, the bass drum could be notated above the toms thus eliminating the wrong-side adjustment. The cymbals, in this case, are closer to the mallet instruments; if they were primarily used with the toms, they would be relocated in the setup and in the notation.

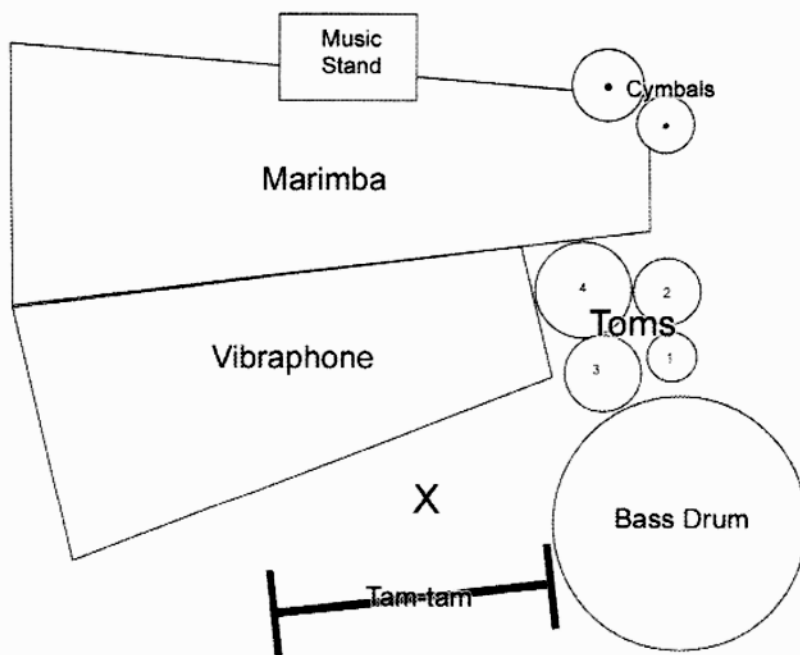

A. sample setups

If, with the same list of instruments, the unpitched instruments are primarily used around the vibraphone and the marimba is used separately, then the setup might look like this:

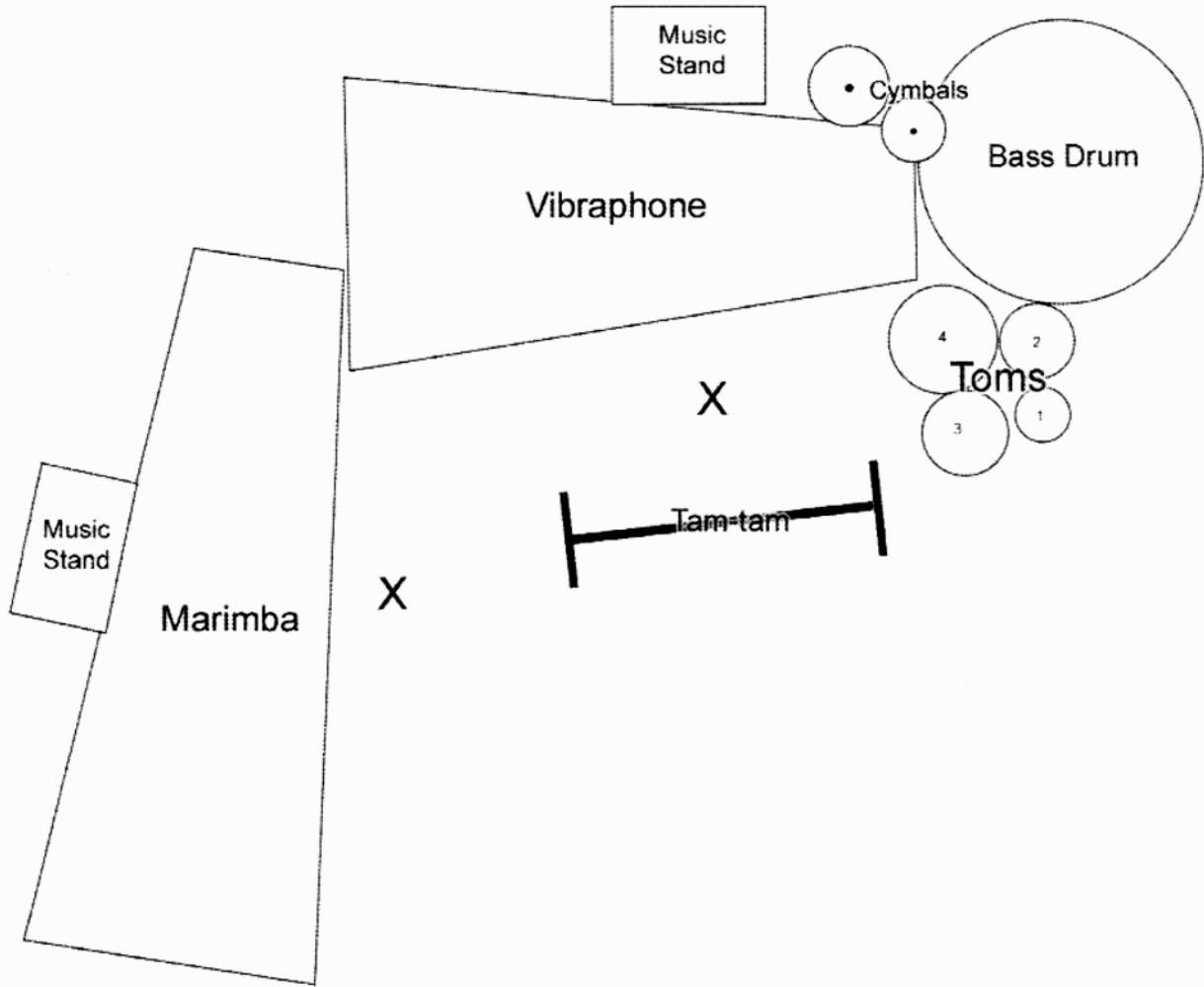

If the vibraphone and marimba are used separately but both with the unpitched instruments, the setup might look like this:

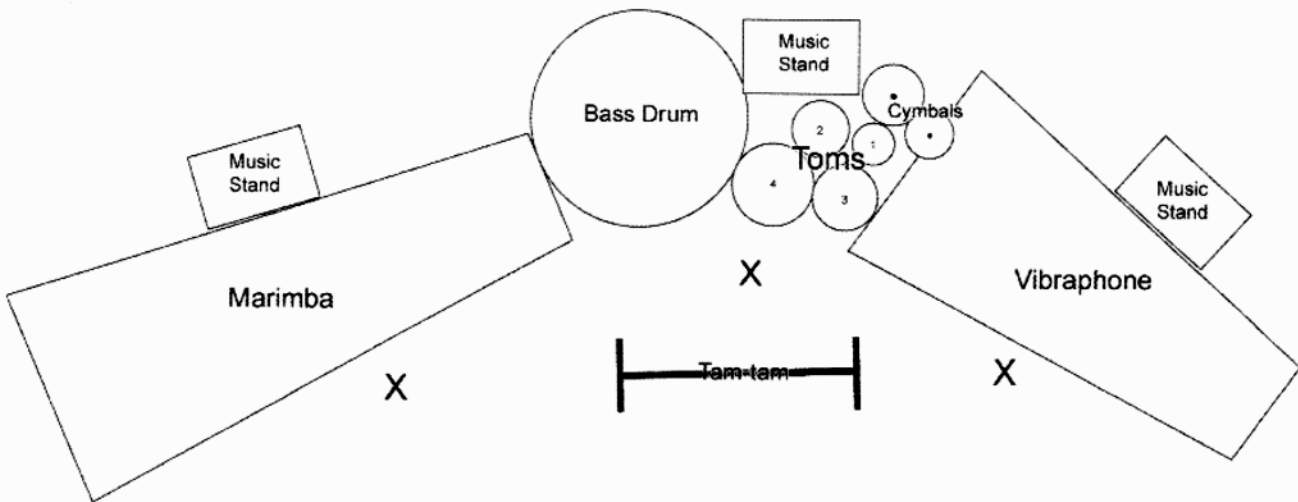

The musical score consists of three parts. The top part is a single staff labeled 'Vibr.' which is empty. The middle part is a single staff with a double bar line at the start, containing four quarter notes. Below these notes are labels: 'bass drum' under the first note, 'toms' under the second and third notes, 'cymbals' under the fourth note, and 'tam tam' under a note marked with an 'X' on the staff. The bottom part is labeled 'Mar.' and consists of two staves (treble and bass clef), both of which are empty.

- vibraphone
- glockenspiel
- xylophone
- triangle
- 5 templeblocks
- chimes
- 3 Japanese temple bowls on a timpano

This is just one of many possible ways to set up these instruments. If the glockenspiel is used with the vibraphone and the chimes with the xylophone, then the glock and chimes would be switched. If there are quick passages between both the glockenspiel and the vibraphone and the glockenspiel and the xylophone, the glockenspiel might be put in the middle, or two glockenspiels may be required. If the player must move quickly between the bowls and the vibes, then the timpano would be placed on the other side. All large setups will have many variations. The damper pedal of the chimes, in the setup below, is not reachable and would be preset to always let the chimes ring.

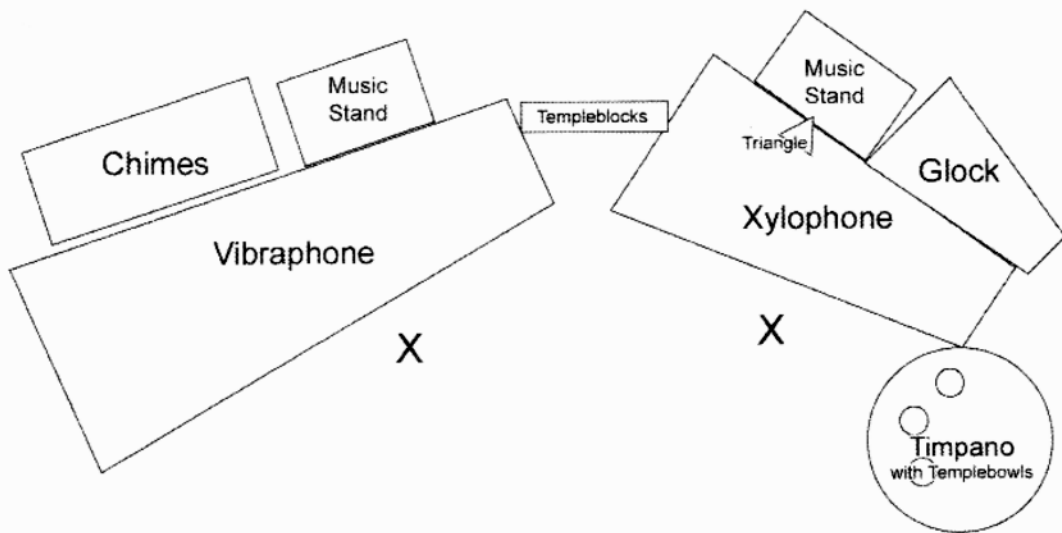

- marimba
- vibraphone
- glockenspiel
- 5 tom-toms
- bass drum
- 2 suspended cymbals
- tam-tam
- maracas
- claves

Again, this is a set of instruments with many possible setups. The maracas and claves would be placed on a trap table with sticks and mallets. Depending on player preference, this table may be behind the player, next to the glockenspiel, next to the toms, etc.

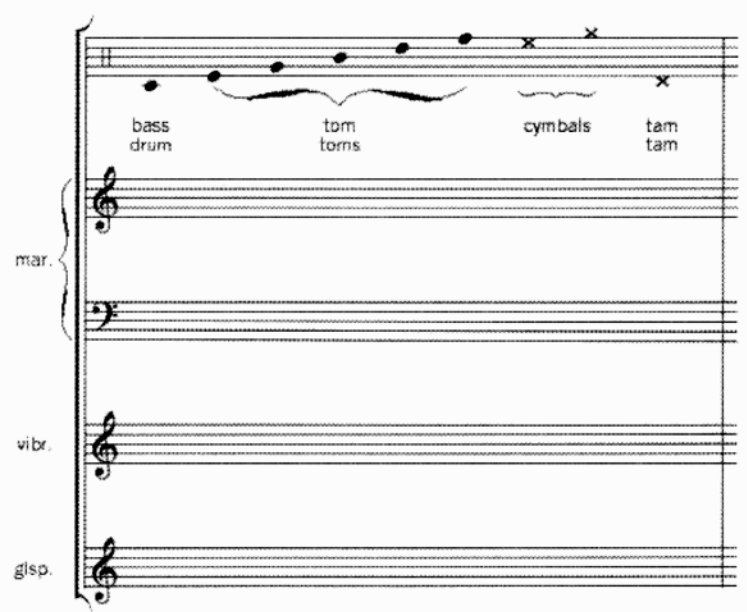
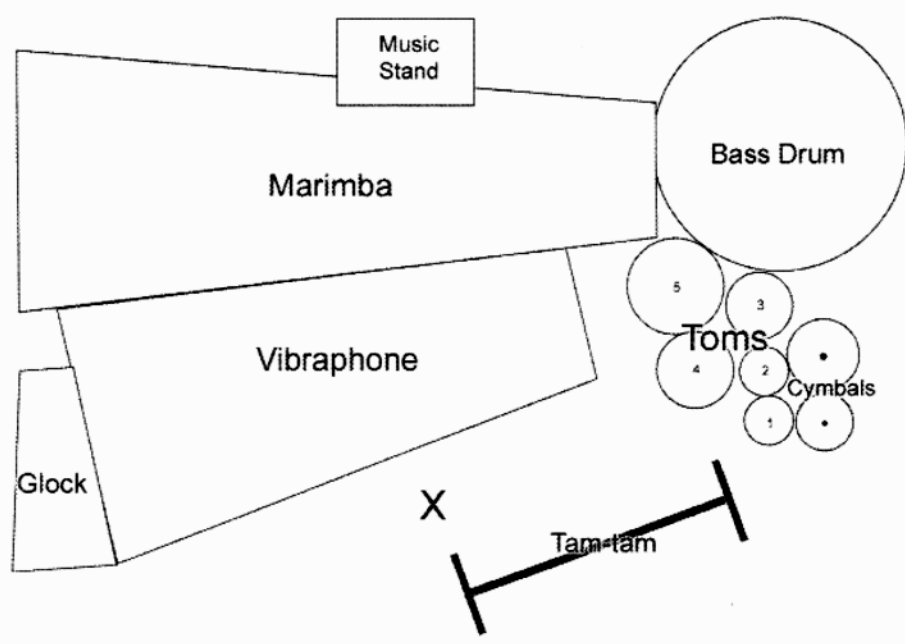

vibraphone  
 3 nipple gongs (no specific pitches)  
 2 crystal glasses  
 3 frying pans  
 3 cowbells  
 2 wood blocks  
 pedal bass drum  
 3 tom-toms  
 snare drum  
 hi-hat  
 2 suspended cymbals  
 large tam-tam  
 triangle

This is the setup for Shawn Crouch's *Suspended Contact*. In this case, the gongs hang from a rack over the vibraphone. The triangle hangs from a music stand. The vibraphone, bass drum, and hi-hat have pedals so footwork, as well as the direction the player is facing, must be considered. Pedals can be played with the heel of the foot so the player can play a pedal instrument even when facing the other way.

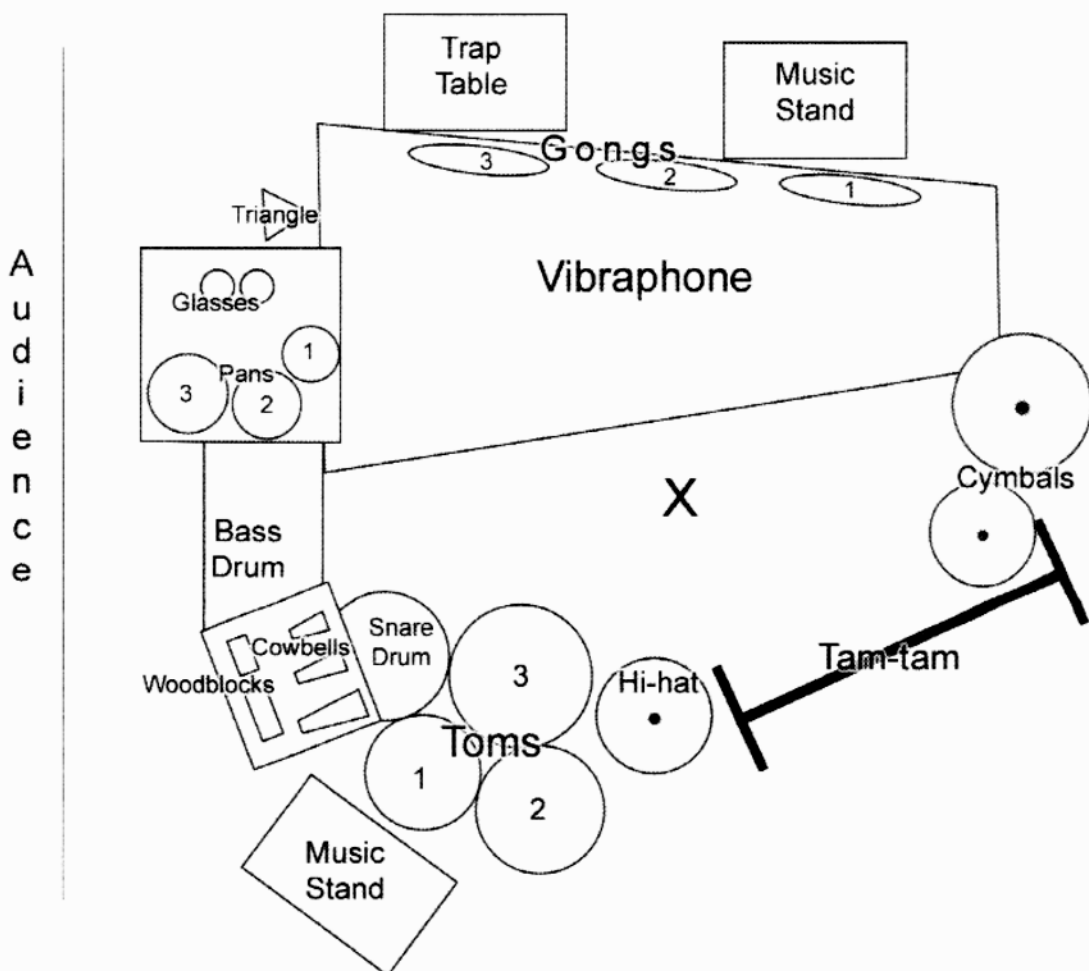

This setup surrounds the player entirely so there is no clean way to notate it. This is the notation used in *Suspended Contact* which Shawn and I designed before the piece was written. The gongs are notated without pitch.

The image shows a musical score for a percussion ensemble. It consists of two staves. The top staff is labeled 'vibraphone' and contains a treble clef. Below it are two staves for various percussion instruments. The first of these two staves includes: glasses (marked with an 'x'), pans (marked with a dot), cymbals (marked with an 'x'), triangle (marked with a triangle), wood blocks (marked with an 'x'), and cowbells (marked with a dot). The second staff includes: snare drum (marked with a dot), gongs (marked with a dot), toms (marked with a dot), hi-hat (marked with an 'x'), tam-tam (marked with a dot), and bass drum (marked with a dot). Below the second staff, there are two small symbols: an 'o' labeled 'open' and a '+' labeled 'closed'.

In hindsight, for reasons specific to the writing in the piece, the following notation may have been more appropriate; however, either notation is effective and functional.

The image shows an alternative musical score for a percussion ensemble, enclosed in a large rectangular frame. It consists of four staves. The top staff is labeled 'gongs' and 'cymbals'. The second staff is labeled 'vibraphone' and contains a treble clef. The third staff includes: pans (marked with a dot), glasses (marked with a dot), and triangle (marked with a triangle). The bottom staff includes: bass drum (marked with a dot), toms (marked with a dot), snare drum (marked with a dot), cowbells (marked with a dot), wood blocks (marked with a dot), hi hat (marked with an 'x'), and tam tam (marked with an 'x').

With large setups like this, it may be appropriate to alter the notation for different sections of the piece. For example, *Suspended Contact* features an extended passage for the suspended cymbals and hi-hat, during which those instruments could be consolidated onto one staff. As long as they are clearly labeled, these types of adjustments can and should be made.



Below is the instrument key for Steven Mackey's *Micro-Concerto*. The solo part was written with the assistance of percussionist Daniel Druckman. In preparation for this piece, Dan provided Steve with a number of small instruments with which he could experiment, so prior to and during the composition process, Steve was able to design his own unique sounds, playing techniques, and setup.

**Station 1: Percussion Map**

**Station 2: Percussion Map**

non-pitched:

Ord. Wood block low

2 Piccolo Wood blocks low ----> high

small Cowbell

Log Drum pitched at lowest Eb

mounted Castenet

Guiro small (piccolo)

Egg Shaker

mounted Tambourine jingles

Vibra Slap

sizzle cymbal

china cymbal

Crash Cymbal

Small Chinese Gong

different sized Cans

bean pod rattle

different sized Bottles

- Low Asian Drum: pitched much lower than Bongos and a bit higher than low tom-tom
- Conga, when struck with hand uses three types of attacks:  
tone (t) normal resonant palm strike, bass (b) heel of hand in center for low bass note.  
slap (s) for crisp high pitched snap.
- Clickers are toy noise makers sold in toy stores and party supply houses.  
They make sound when pressed and again when released.  
Typically, the "release" is pitched slightly lower than the "press."  
There is no notational distinction made between clickers in right or left hands.  
Occasionally the distinction is made between press= P and release = R  
If not indicated it is up to the performer:  
obviously two P's or two R's in a row indicates alternating hands.
- Small Cowbell: pitched above regular wood block  
"Clinky" not resonant.
- The bean pod rattle should have the smallest possible bean pods.  
so that the sound is more of a soft "crackle" than "rattle."

Pitched:

4 Crotales (sound up 2 octaves)

Marine Band Harmonica  
Pitched in D

Steve originally conceived these as two separate setups, but after working out the notation and diagrams, he realized that they might be consolidated (for example, by having the Asian drum in Station #2 be the medium tom in Station #1). While composing, he was able to set up and experiment with the instruments in Station #1; however, he did not have access to all of the instruments for Station #2 and could only guess at its exact arrangement. Below are the rough diagrams on which the notation was based, drawn with the knowledge that some adjustments would be necessary once Dan started working with the score.

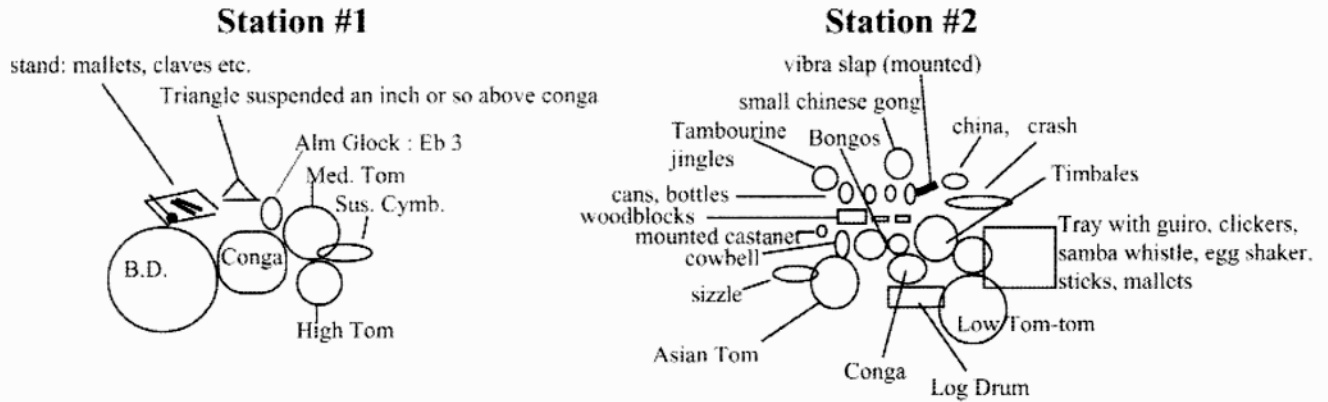

Ultimately, the two stations were consolidated; the low tom-tom and lower drum of the timbales in Station #2 became the medium and high tom-toms in Station #1. Many other instruments were rearranged as well, especially in Station #2. Station #1, the setup which Steve had while composing, remained almost entirely intact. Below is the diagram of the setup Dan designed.

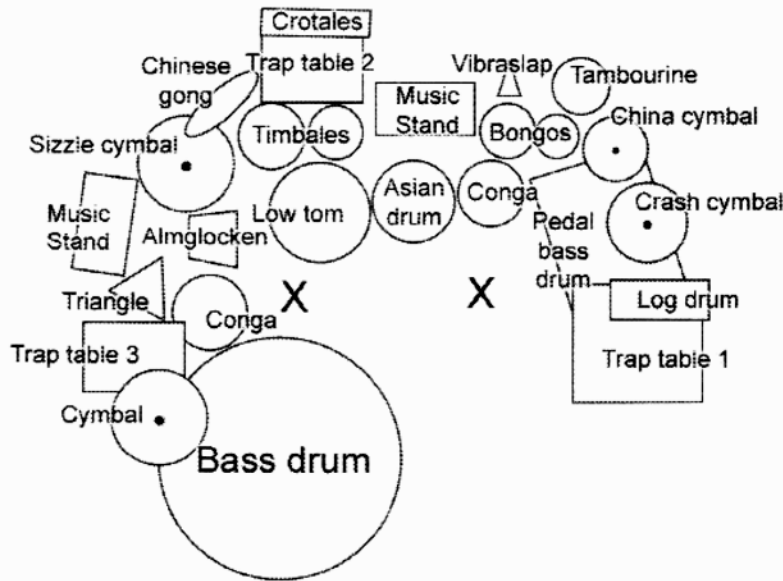

Most of the small instruments are mounted either on a stand or on a trap table; the few that must be held to be played are the claves, samba whistle, clickers, egg shaker, bean pod rattle, and harmonica. The crash cymbal is a suspended crash cymbal - not a pair of crash cymbals. The samba whistle, clickers, cowbell, castanet, guiro, and egg shaker rest on trap table 1, the cans, bottles, and woodblocks rest on trap table 2, and the claves and bean pod rattle rest on trap table 3.

During the transition from the first to the final setup, Steve and Dan worked together to tweak both the setup and some of the more complicated passages to fit each other. As a result, this setup is one which is closely linked with the writing but seemingly not so with the notation. Much of the music uses only small groups of instruments at a time, so an intuitive notation which represents the entire setup as one instrument (like those in many other examples in this appendix) is not necessary.

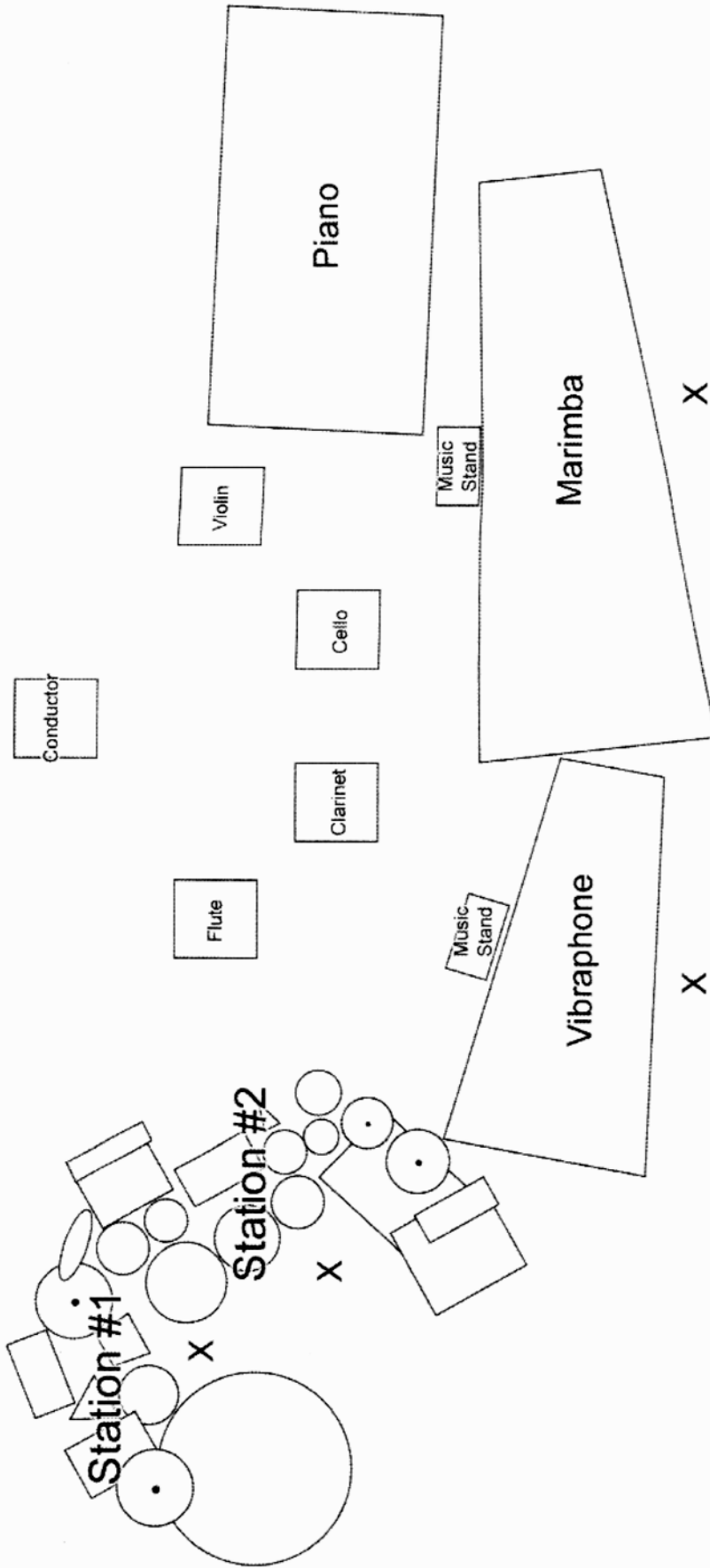

This is the entire setup for the *Micro-Concerto*. The piece is in five movements and the soloist uses the instruments as follows:

- Movement 1: Station #1
- Movement 2: Vibraphone
- Movement 3: Station #2
- Movement 4: Marimba
- Movement 5: both Stations #1 and #2

The vibraphone movement is played with the flute and the marimba with the cello, so those instruments are set up near each other to achieve the proper instrument pairings. The fourth and fifth movements are *attacca* so there is a rather quick switch between the marimba and unpitched instruments; however, this switch is not so fast that it is unreasonable to observe the instrument pairings. If the performer had less time to make the switch, the position of the marimba and vibraphone would have to be reversed.

# Appendix B

# scores with comments

This appendix presents excerpts from real scores with comments that unpack many behind-the-scenes details and give some insight into the composers' and percussionists' processes. My commentary is in the gray boxes

## Shawn Crouch, *Suspended Contact* for alto saxophone and percussion

©2001 HoneyRock Publishing, used by permission

Instrument key:

The image shows a musical score for a vibraphone and various percussion instruments. The vibraphone part is written on a single treble clef staff. Below it, two staves represent the percussion instruments. The first staff lists glasses, pans, cymbals, triangle, wood blocks, and cowbells. The second staff lists snare drum, gongs, toms, hi-hat, tam-tam, and bass drum. The hi-hat part includes markings for 'open' and 'closed'.

Setup diagram:

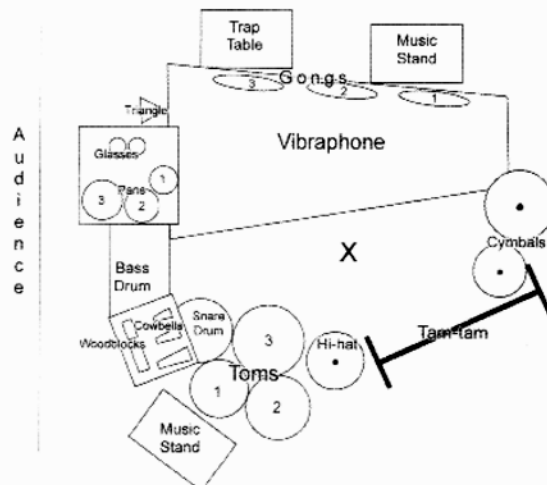

Please refer to this diagram (also on page 130) when reading descriptions of movement on the following pages.

Musical score for measures 30-32. The top staff is saxophone, the middle is piano, and the bottom is bass. Dynamics range from *mf* to *f*.

In this example, the topmost line is always saxophone.

Musical score for measures 33-36. Measure 33 is marked "extremely aggressive" and *ff*. The middle staff is labeled "sticks toms". Dynamics range from *mf* to *f*.

Musical score for measures 37-40. The bottom staff is marked with a forte *f* dynamic.

Throughout the piece, the snares of the snare drum vibrate sympathetically with other instruments. This is especially a problem in this section with the tom-toms.

Musical score for measures 41-44. The top staff has dynamics *f*, *ff*, *mf*. The middle staff has dynamics *mf*, *f*, *mf*, *f*, *mf*. The bottom staff has dynamics *mf*, *mf*, *f*. Instrument labels WB, SD, CB, and WB are present above the middle and bottom staves.

Even though there is an instrument key at the start of the score, the instrument name is still indicated above entrances. This makes the part considerably easier to learn.

45

*mf* ————— *f* *mf*

*mf* ————— *f* *f* *mf*

49

*f* ————— *ff*

*mf* *f* *mf* *f*

m49: This crescendo tends to not be smooth because it involves a few differently sounding instruments. The snare drum, toms, and wood blocks all speak at different dynamics. Percussionists will try to compensate in these situations by making the sounding dynamics consistent from instrument to instrument, but this can be difficult.

55

*f* ————— *ff*

*mf* *mf* *ff*

57

*ff* ————— *fff*

*f* ————— *fff*

m62: This is a very quick and difficult switch from sticks to mallets for which more time should normally be given. This is especially difficult because four mallets are required and both hands are needed immediately. If the switch was to only two mallets, it would take much less time. If the vibraphone passage started with only one or two notes instead of three, the performer could first focus on picking up mallets in just one hand and then begin playing with that hand while the other picks up the rest of the mallets. As it is, both hands have to pick up the mallets and get them into position immediately.

Beater indications were altered considerably after this piece was learned and performed. At the start, Shawn indicated many stick and mallet changes that he knew would not be possible with the hope that I would have some tricks that would realize, in practical ways, the sounds he was looking for. For example, in mm63 and 65, instead of using sticks on the cymbal, I suggested the shafts of the cord vibraphone mallets that I was already holding. Needless to say, if the composer plans on writing indications that are clearly impossible, he or she should make sure the performer has enough preparation time to find appropriate solutions.

with less aggression ♩ = 152

66

*mf* *f* *f*

cord pans

cord

put down 2 mallets

*mf* *mf*

sus. cym.

Indications like "put down 2 mallets" should only be added to a score, if at all, after it has been worked out by a percussionist.

69

*mp* *mp* *mf* *f*

cord pans

*mf* *mf*

cord toms

72

*mf* *f* *f* *f*

cord pans

*mf* *mf*

cord toms

*f* *f*

Tr.

It would be ideal to have these tom passages played with sticks in order to more clearly recall the music from the previous section, but there is no time to switch from the mallets that are required for the vibraphone. This is not such a problem because the dynamic is loud. With louder dynamics, the timbral difference between hard and soft beaters becomes less apparent, so the toms passages with mallets do not sound much differently than they would with sticks. With soft dynamics and with rolls (even at loud dynamics) this difference would be obvious.



165 *ff*

This excerpt begins much later in the piece.  $J=95$

CB. *f* pans CB. KD

169 *mf* *mf*

CB. *mp* pans *mf* *f*

This section is especially tricky. At the start of this passage (m172), the player is holding two cord vibraphone mallets.

173 *f* *f*

cord sticks on dome Tr. sticks pans *f*

2 sticks in rt. hand 2 mallets in lt. hand pick-up two sticks *f*

m174: The player puts the right-hand mallet into the left hand so the left hand is now holding two cord mallets. Then he or she picks up two sticks in the right hand and swings around to hit the dome of the cymbal. Because there is so little time to do this, the player cannot adjust the sticks in the right hand so they are individually usable (as with normal four-mallet technique), but rather they are held together and welded as one stick. In addition, when quickly picking up two sticks with one hand, the sticks will tend to clap together and make noise as the hand collects them from the trap table. To avoid this, the player must make sure that the sticks are exactly next to and touching each other on the trap table. This is done in mm160-1 (not shown).

mm174-5: Meanwhile, the right foot has made its way to the vibraphone pedal and the mallets in the left hand have been adjusted to prepare for the G and F on the vibraphone. After the right hand (with two sticks) strikes the dome of the cymbal, it moves to strike the triangle and at the same time adjusts the sticks into proper four-mallet position. The right hand is then ready to play the pans in m175.

177 *ff* *sub mp*  
left hand, cord

sticks  
cord

right hand, sticks  
on dome

*mp*  
*ff*  
*p* *mp*

mm178-180: Now the left hand with cord mallets plays the vibraphone, and the right hand with sticks plays the dome of the cymbal. To get into position for the following passage, the left foot moves to the vibraphone pedal and takes over for the right foot. The right foot then moves toward the hi-hat pedal so the body can be facing the cymbals.

181  
m181: The left hand drops the two cord mallets.

m182: The first beat of this bar is performed entirely by the right hand. During the eighth-note rest in the second beat of this bar, the left hand takes one of the sticks from the right hand. Now each hand has one stick. At the same time the left foot moves to the hi-hat pedal. The hi-hat has to be controlled by the left foot because the right foot needs to play the bass drum later. (The second beat of this bar originally contained all six notes of the sextuplet; the second and third articulations were removed to facilitate this transfer of one stick to the left hand.)

drop 2 mallets  
on edge

sus. cym on edge

hi-hat

*ff*  
*ff*

mm 184-5: The right foot moves to bass drum pedal.

185

CB

BD

*mf*  
*f*

189

Because the player's feet need to be positioned on the hi-hat and bass drum pedals, the hi-hat must be positioned where it is (see diagram on page 135). The ideal placement of the hi-hat for the writing starting in m182 would be near the suspended cymbals. This would make those figures much easier, but since the player must later reach the cowbells and bass drum, the hi-hat is moved closer to those instruments. This makes the hi-hat/cymbals passage a little more difficult, but it reduces the distance from the hi-hat to the cowbells and reduces the wide straddle between the two pedals (which would upset the performer's balance and make this next passage especially difficult).

## Jefferson Friedman, *Sacred Heart: Explosion* for orchestra

©Montana 59 Music, used by permission

### Instrumentation

3 Flutes [3rd doubling Piccolo]  
 3 Oboes [3rd doubling English Horn]  
 3 Clarinets [3rd doubling E♭ Clarinet & Bass Clarinet]  
 3 Bassoons [3rd doubling Contrabassoon]

4 Horns in F  
 4 Trumpets  
 2 Tenor Trombones [F trigger necessary]  
 1 Bass Trombone [E trigger necessary]  
 1 Tuba

5 Timpani [1 player]

Percussion [3 players]:

Player 1:

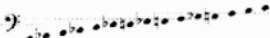
Suspended Cymbal  
 Toy Piano  
 Vibraphone  
 Tambourine  
 Sizzle Cymbal  
 4 Roto Toms:  
  
 15 Tuned Gongs:  
  
 Tam-tam

Player 2:

Bass Drum  
 Glockenspiel  
 Crotales  
 4 Tom-toms  
 Tambourine  
 Field Drum  
 Thunder Sheet

Player 3:

2 Sets of Chimes [Onstage & Offstage]  
 Bass Drum [Offstage]  
 Suspended Cymbal

2 Harps [Onstage & Offstage; 2 players]

Piano  
 Celesta  
 Harmonium } 1 Player

Violin I  
 Violin II  
 Viola  
 Cello  
 Contrabass } [at least 12-12-10-8-8]

**Player 3 (with the exception of the very end of the piece) is a dedicated offstage player. Special care is taken to allow this player enough time to move from the backstage area (for rhl. 17-22), to the back of the hall (behind the audience for rhl. 56) and then to the stage (for rhl. 64-end).**

### Setup

Setup is normal, with the following adjustments:

Celesta must be placed as far forward as possible, facing out toward the audience, so that its soli in the first half of the piece can be heard clearly.

Offstage Harp & Offstage Chimes should be placed to the conductor's left, with the harp as close as possible to the stage door and the chimes farther back, so that the two instruments' dynamic levels are balanced.

Offstage Bass Drum should be placed behind the audience, as close as possible to the doors of the auditorium and as close to center as possible.

Strings must be arranged as follows, so that the echo effects beginning at measure 94 and at measure 111 work properly, and so that the whispering beginning at measure 292 is seen as little as possible:

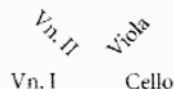

Trumpets 1-4 should be seated as close as possible to the Timpani for its passages beginning at measure 301.

Bass Trombone must be seated next to the Tuba for its passage beginning at measure 309.

Duration: ca. 14 minutes

\*Schoenhut Classic Baby Grand Toy Piano (Model #309) available on loan from Montana 59 Music for the cost of shipping. For more information, email montana59music@hotmail.com.

51

$\text{♩} = 80$

Timpani

Percussion 1

Percussion 2

Tuned Gongs:

Bass Drum:

This passage on the gongs is very awkward and difficult and requires quite a bit of choreography to execute properly. Fifteen tuned gongs would be mounted on at least two very large racks.

Timp.

Perc. 1

Perc. 2

52

*accel.*

(♩ = ca. 84)

Timp.

Perc. 1

Perc. 2

Glockenspiel:

\*Lowest possible note.

*(accel.)*

(♩ = ca. 88)

Timp.

Perc. 1

Perc. 2

(*accel.*) (♩ = ca. 92)

53

Timp.

Perc. 1

Perc. 2

(*accel.*)

Timp.

Perc. 1

Perc. 2

Gongs are large instruments and will require about one second of dampening with a hand to fully stop ringing; therefore, quite a bit of time must be allotted for the percussionist to dampen all fifteen gongs. In this case, the brass plays loudly at rhl. 54 so the sound of the gongs ringing over is not problematic. If a sudden silence was necessary, the gong player would have to start dampening earlier (see the final bar of this piece). Glockenspiel takes much less time to dampen, so here, player 2 has enough time to dampen the glock and get to the bass drum.

♩ = 96 *accel.* (♩ = ca. 104)

54

12 + 2 + 3

Timp.

Perc. 1

Perc. 2

// (stop gongs from ringing as quickly as possible)

// (stop glock. from ringing)

Bass Drum:

*fff*

(*accel.*) (♩ = ca. 112) (♩ = ca. 120)

55

Timp.

Perc. 2

56  $\text{♩} = 60$

Perc. 1 Bowed Sizzle Cymbal: arco  
vary length; from approx. 2" to 6"  
*pp* — *mp* — *pp*

Perc. 2 Thunder Sheet:  
vary length; from approx. 2" to 6"  
*ppp* — *p* — *ppp*

Perc. 3 Offstage Bass Drum\*: Percussion 3 to stage

*pppp* possible

\*Bass Drum should be placed behind the audience, as close as possible to the doors of the auditorium. Doors are to remain closed. The bass drum must be completely hidden from view before the performance and must not be set up until after the piece begins. The conductor holds the fermata at the end of the previous measure, and the percussionist hits the bass drum as soon as possible after the echo of the previous tutti dies away enough so that it will be heard clearly. It is of extreme importance that the conductor not cue the bass drum player in any way, so the timing of this should be worked out in rehearsal. Immediately after the bass drum hit, the conductor gives the downbeat to the next measure.

Timp.

*ppp*

Perc. 1

Perc. 2

\*Tremolo between lowest two timpani, tuned as low as possible. Move pedal up and down on the second lowest timpani as the diagonal lines indicate.

### A later excerpt...

64  $\text{♩} = 60$  65

Timpani

*mf* — *ff* — *f*

Percussion 1 Tam-tam: (x'ed noteheads) and Tuned Gongs:  
*mp* — *mf* — *mf*  
*l. v. sempre*

Percussion 2 Bass Drum:  
*mp* — *f* — *mf*

Percussion 3 Suspended Cymbal:  
*mp* — *f* — *mf*

In the pitched clef, the tam-tam is notated with an X notehead so it is clearly distinguishable from the tuned gongs.

66

Timp.

Perc. 1

Perc. 2

Perc. 3

67

Timp.

Perc. 1

Perc. 2

Perc. 3

Chimes (Onstage):

*poco rit.*

\*Play all available gongs as fast as possible in random order.

Timp.

Perc. 1

Perc. 2

Perc. 3

*poco rit.*

\*\*Stop hitting gongs just before downbeat. Stop gongs from ringing in the indicated order.

Here, the player is given time to muffle the gongs in preparation for the cutoff at the end.

# Ryan Streber, *Rondel* for two percussionists

(♩ = 80) **Adagio**

**Player 1**  
 Vibraphone *ff*  
*Red.*

**Player 2**  
 Marimba *pp* → *sfz*  
*sfz* *mf* *pp* *mf-p* → *pp* *poco*

Mallet dampening would be used to achieve the articulations on the G#'s and F while letting the chord ring through.

The E and E<sub>b</sub> are executed with a left-handed independent roll.

This is a very accurate clef for the glockenspiel. Normally, glockenspiel is written in this register with a regular treble clef, and a two octave transposition is assumed. This notation, although unnecessary, leaves nothing in question.

"+" and "o" mean "node" and "center." The dotted line indicates gradually moving from one position to the other. These notations are explained earlier in the part (not shown).

**Senza misura** ----- **Adagio, con rubato**

**Glock.**

**Vib.** *mp* *p* → *pp* *pp* *mf*

**Perc.** *pp* *High Sus. Cy.* *High Tam-tam* *dampen gradually* *pp* *w/ knuckle, on edge*

When holding four mallets, it is difficult to get the knuckle in position to strike the edge of the tam-tam. Since there is so little time to get into position, especially at the next occurrence three bars later, Player 1 may decide to strike the edge of the tam-tam with the vibraphone mallet instead of his or her knuckle. This is a similar sound and is considerably easier to execute.

**Mar.** *mf* → *p* *pp* *ppp* *secco* *ff* *pp*

**Gong** *p* *dampen gradually*

Here, Player 1 would switch from four vibraphone mallets to two vib and two glockenspiel mallets - one of each, held in each hand.

Even though the marimba is primarily played in its lowest octave, medium-hard mallets are required so these higher notes will speak well. This means that some of the rolls in the bass of the instrument will not sound as beautiful as they could with soft mallets.

Here, Player 2 would dampen gradually with his or her butt while rolling on the marimba.



Glock. *p*

Vib. The "tam-tam on edge" and "cymbals on dome" are both notated with diamond noteheads. This is appropriate because they are similar sul ponticello-like effects (see Tone Color).

Perc. *pp* *mf* *pp* (on the dome) *ppp*

Med. Sus. Cy. High Sus. Cy. Low Sus. Cy. Med. Sus. Cy.

Med. Tam-tam w/ knuckle, on edge

Mar. *pp* *ff* *pp* *ff* *pp*

Gong

The articulations on the single marimba notes are helpful, as it gives the performer the opportunity to use dampening or even dead strokes to differentiate between the staccato notes (like the B and E in this bar) and the i.v. notes (like the F# in the subsequent bar).

*Poco più mosso*

Glock.

Vib. Here, Player 1 would switch to four vibe mallets. *mp - dolce*

Perc. *ppp* *pochiss.*

Mar. *p* *pp* *pp* *mp*

Gong *p* *mp*

*Poco più mosso*

In this entire excerpt, there is just enough time before and after each gong attack for Player 2 to pick up/put down a large gong beater and get to/from the marimba. This is important because these pitches require large gongs which would sound very differently if struck with the much smaller marimba mallets.

Here, the glockenspiel is used as an extension of the vibraphone. In the second to last bar of this excerpt, both four note chords on the vibraphone and chords with three vibrate notes and one glock note appear. The chord with the C in the glock is arpeggiated which eliminates the worry of being able to strike both instruments comfortably together. The other chord, however, is struck together, so the glockenspiel has to be positioned closely enough to the vibraphone so one hand can strike both the top G of the vibraphone and the F of the glock. (See Stacked Instruments in Keyboard Percussion.)

This passage also requires some mallet considerations. The soft vibre mallets that are likely to be used for all previous music will not speak on glockenspiel, and glockenspiel mallets would not sound good on vibres. In the two previous bars, the player has an opportunity to switch the topmost mallet (mallet number 4) to a very hard vibraphone mallet - one which would speak on the glock and work on the vibraphone. This will make the final two chords possible, but will create voicing problems for the first two chords (i.e., the C# and A on the top of the vibres will sound much brighter than the rest of the chord). The player can compensate by playing those notes softer, but it may still be a problem. If the strange voicing is particularly noticeable, the player may want to start using the harder top mallet at the beginning of this phrase (at the *Poco piu mosso*) for consistency's sake.

Another and perhaps better solution would be to have Player 2 play those two glockenspiel notes. Player 2 has plenty of time to get the appropriate mallets, and he or she could have a separate glockenspiel or, depending on the setup, could even reach over and play Player 1's glockenspiel. This would ensure the proper balance of all the chords and make the passage considerably easier to execute.

The musical score consists of five staves. The top staff is for the Glockenspiel (Glock.), the second for the Vibraphone (Vib.), the third for Percussion (Perc.), the fourth for Maracas (Mar.), and the fifth for the Gong. The score is in 5/4 time and includes a *Rit.* (Ritardando) section. The Vibraphone part features dynamic markings of *p*, *mf*, and *p*. The Gong part features dynamic markings of *mf* and *p*. The Maracas part includes a triplet of eighth notes. The Percussion part has a *pp* (pianissimo) marking. The score is annotated with various musical symbols, including slurs, accents, and dynamic markings.

Nico Muhly, *Sustained Music* for five percussionists

Tam-tams are usually very large instruments. A secco tam-tam note like this requires the player to press a large part of his or her body against the instrument to muffle it.

"x" versus "+" clearly delineates a muffle (muffling the resonance without an attack) from a muffled stroke (striking while muffling the drum).

The score consists of five staves. The top staff is for Tambourine, followed by Tam-tam, Tom-toms, Crotales, and Vibraphone. The time signature is 3/4. The tempo is marked with a quarter note equal to 80. The score includes various dynamics such as *ff*, *p*, *f*, and *mf*. There are also articulation markings like 'secco' and '(damp)'. The Vibraphone part shows a melodic line with slurs and dynamic markings.

This type of dampening on the tom-tom would be performed by the non-striking hand, which will make soft articulations as it dampens. A rather large and resonant tom would be used to make this effect clear.

Here, a variety of vibraphone pedal indications are used:

- regular pedaling (like in piano music) - mm2-7
- phrase markings - mm8-10
- accurate note lengths (leaving it up to the performer to use pedaling and dampening) - mm16-27

The score consists of four staves: Tambourine, Tom-toms, Crotales, and Vibraphone. The time signature is 3/4. The score includes various dynamics such as *ff*, *mf*, and *ff*. There are also articulation markings like 'arco' and 'mfz'. The Vibraphone part shows a melodic line with slurs and dynamic markings. Annotations include 'dampen individual pitches' and 'pedal phrases'.

For many percussionists, consistency of notation is most important. If the composer uses pedal indications frequently in a given piece, they should be used throughout and consistently. In a piece that uses many specific indications for pedal, pedal usage will be questionable in passages that have only slurred notes or longer note values without pedal indications. Here, where notation changes, it is always explained; this leaves nothing in question.

Percussionists will instinctively pedal slur markings, but the written indication "pedal phrases" will leave no doubt. This can be important if other pedal notations are used (as are here in the previous bars). Slurs in the previous bars are executed dynamically as the *Ped.* notation overrides any slur pedal indications.

Vib.

sub. mp

cresc

sf

Here, each note is pedaled separately.

Tom-t.

Crot.

Vib.

15

(arco)

p

mf

f

(normale)

In this vibraphone passage, there are no specific pedal indications. Because it moves so quickly, the dampening of individual notes would not be necessary. If the pedal is retaken on each of the notes in the lower voice, this passage would be effectively realized.

These tambourine rolls would be executed as thumb rolls. Thumb rolls articulate the instrument much faster than shake rolls, so for these short notes, thumb rolls would sound fuller.

Tamb.

Tom-t.

Crot.

Vib.

20

ff

p

dampen

dampen

ff

p

espress.

Here, the dampening of individual notes is necessary to allow the longer notes to ring through. The pedal would be depressed at the C & E in m20 and then on the downbeats of mm22, 23, 25, 26, and 27. All intermediate notes would be dampened with a mallet head to ensure their written note length. In the case of m24, the pedal would be retaken on the last eighth note of m23 so the E<sub>5</sub> can ring over. Although this cuts off the C, D, & F chord too soon, this will not be problematic since the sustain of the vibraphone decays after the initial attack and the sound of these notes will already be rather soft.

It may be possible for this piece to be performed by only four players. The vibraphone part clearly requires one player's full attention. The tam-tam part is sparse, but since this instrument is so large, both of the player's hands and body are required to muffle it quickly for the secco strokes. The tom-tom part requires two hands for the striking, dampening, and rolls. One person, however, may be able to handle both the crotales and tambourine. If the tambourine is mounted, then the part could be played with one hand (even the thumb rolls at the end) which leaves the other hand free to play the crotales. For all the crotales passages, no more than one mallet or bow is used at a time, and the dampening at the end can be done with the same hand as that holding the mallet. The only difficult section would be m7 where the player would have to handle a bow for the crotales while playing the tambourine. This is somewhat tricky but possible. If the tambourine was played by a separate player, it would probably sound much better; one loses some control over articulation and dynamics with a mounted tambourine.

# Appendix C

# beaters

The following chart explains which beaters are most appropriate and/or possible on various instruments. This will be valuable to composers writing for setups involving instruments that require different mallets. For example, a composer writing for crotales, marimba, and tom-toms can use this chart to see that time must be allotted for the player to switch between the mallets used for the marimba and those used for the crotales, but both mallets can be used successfully on the toms (see **Chapter 3 - Beaters** for more information).

Numbers on the chart are defined as follows:

- 1 - best, most appropriate, most common sound
- 2 - acceptable, common but not ideal
- 3 - acceptable, an unusual sound, a special effect
- 4 - can be used, but sound will be of poor quality
- 5 - can be used, but may damage the instrument
- 6 - not acceptable

Numbers in parentheses next to those with additional qualifications apply to beaters outside of that qualification. For example, steel drums with soft rubber mallets is 1, but steel drums with harder rubber mallets is 5 (see chart).

The instruments listed are those that one might strike with a stick or mallet. Claves, in this case, would be mounted.

	yarn/cord mallets	snare sticks	felt mallets	rubber mallets	wood mallets	plastic mallets	brushes
	(marimba/vibe mallets)		(timpani mallets)			(xylo/glock mallets)	
timpani	2 - loud dynamics (4)	5	1	2	2	5	2
tom toms/snare drum	2	1	1	1	1	1	1
bass drum	2	2	1	2	1	2	2
bongos/congas	2	1	1	1	1	2	2
marimba	1	5	2	1	2 - upper register (5)	2 - upper register (5)	3
xylophone	2 - very hard mallets (4)	5	4	1	1	1	3
vibraphone	1	3	2	2	3	3	3
glockenspiel/crotales	4 - extremely hard mallets (6)	4	4	2 - hard mallets (4)	1	1	3
chimes	2	3	2	2	2	2	3
wood blocks	2	1	2	1	1	1	3
temple blocks	1	1	2	1	1	1	3
log drums	1	2	2	1	2	5	3
cajón	2 - soft mallets (5)	5	2	2 - soft mallets (5)	5	5	3
cymbals	1	1	1	1	1	1	1
gongs	2	3	2	2	3	3	3
Japanese temple bowls	1	1	1	1	1	1	3
triangle	4	3	4	4	4	2	4
cowbells/agogo bells	1	1	2	1	1	1	3
brake drums/pipes	2 - hard mallets (4)	2	2	1	1	1	3
thundersheet	2	2	2	2	2	2	3
steel drums	5	6	5	1 - soft mallets (5)	6	6	3
machine castanets	2	2	2	2	2	2	2
claves	4 - hard mallets (6)	4	4 - hard mallets (6)	2 - hard mallets (4)	1	1	6
crystal glasses	1	1	2	1	1	1	3
tambourine	2	2	2	2	2	2	2

	brass mallets	hands	triangle beater	bass drum beater	gong beater	chime hammers	rute
timpani	6	2	6	4	6	6	3
tom toms/snare drum	6	2	5	4	6	6	3
bass drum	6	2	5	1	2	2	3
bongos/congas	6	1	5	4	6	6	3
marimba	6	2	6	2 - in lower register (6)	6	6	5
xylophone	6	4	6	6	6	6	3
vibraphone	6	2	3	2 - in lower register (6)	6	6	3
glockenspiel/crotales	1	4	2	6	6	6	3
chimes	3	4	3	4	6	1	3
wood blocks	6	2	2	6	6	2 - soft dynamics (5)	3
temple blocks	6	2	2	6	6	2 - soft dynamics (5)	3
log drums	6	2	5	4	6	6	3
cajón	6	1	6	2	6	6	3
cymbals	2	2	2	4	6	4	3
gongs	3	2	3	1	1	2	3
Japanese temple bowls	2	2	2	6	6	6	3
triangle	2	6	1	6	6	6	3
cowbells/agogo bells	2	2	2	6	6	6	3
brake drums/pipes	1	4	2	6	6	1	3
thundersheet	2	1	2	1	1	1	3
steel drums	6	2	6	6	6	6	5
machine castanets	6	1	2	6	6	6	3
claves	6	6	2	6	6	6	6
crystal glasses	6	2	2	6	6	6	3
tambourine	6	1	5	4	6	6	3

1 - best, most appropriate, most common sound  
2 - acceptable, common but not ideal  
3 - acceptable, an unusual sound, a special effect  
4 - can be used, but sound will be of poor quality  
5 - can be used, but may damage the instrument  
6 - not acceptable

# Appendix D

## dynamics

There are many variables that influence the dynamic at which an instrument sounds, and there are also many variables that influence how a performer interprets a written dynamic. For these reasons, precise balance is difficult to prescribe before the music is actually played by an ensemble, and dynamics are often the least reliable markings in a new score. The following chart is a tool with which the composer can more accurately balance percussion sounds in an ensemble to create more effective orchestrations and well-blended sound combinations.

Just as *fortissimo* on tuba is very different than *fortissimo* on harp, the written/sounding dynamic relationship can be very different on different percussion instruments. This chart assumes a one-to-one relationship between the written and sounding dynamics of a six-foot grand piano (i.e., a written dynamic of *piano* will sound at *piano*, and *fortissimo* will sound at *fortissimo*). The six-foot grand's dynamic is used as a reference point to describe the sounding dynamic of percussion instruments interpreting the same written dynamic; for example, if a pianist plays music marked at *ff* on a six-foot grand piano, then a percussionist playing music marked at *ff* on snare drum with snare sticks will produce a sound louder than the piano (see chart).

Of course in performance percussionists reinterpret dynamics with respect to musical considerations; the dynamics listed here are out-of-context dynamics - dynamics that would be produced if the percussionist was not playing a piece of music and not playing with anyone else.

Also listed are the maximum and minimum dynamics under normal playing conditions with the most common beater. For this, *ffff* and *pppp* are the assumed maximum and minimum dynamics for the six-foot grand. These are approximate, general dynamic boundaries which can be broken. In some cases, the maximum and minimum dynamics would be played on two different instruments (like one large and one small ratchet) rather than played softer or louder on the same instrument.

This chart examines the most usual sounds. It assumes that the instrument, playing conditions, and beaters are the most common and usual. For example, one could use brushes on a frame drum but probably would not. For all beater possibilities, see **Appendix C**.

“Medium soft beater” means the yarn or felt mallet appropriate for that instrument. For marimba, it means yarn mallets; for bass drum it means felt bass drum beaters. “Hard beater” means plastic, hard rubber, or metal beaters appropriate for that instrument. For glockenspiel it means plastic mallets; for triangle it means a triangle beater. The others are self-explanatory.



written dynamic	<i>p</i>	<i>ff</i>	<i>p</i>	<i>ff</i>	snare drum sticks	hard beaters	hands	brushes	min dynamic	max dynamic
six-foot grand piano	<i>p</i>	<i>ff</i>	<i>p</i>	<i>ff</i>					<i>pppp</i>	<i>ffff</i>
marimba	<i>p</i>	<i>ff</i>	-	-			<i>pp</i>	<i>mp</i>	<i>n</i>	<i>ff</i>
vibraphone	<i>p</i>	<i>ff</i>	-	-			<i>pp</i>	<i>mp</i>	<i>n</i>	<i>ff</i>
xylophone	<i>pp</i>	<i>f</i>	-	<i>mp</i>		<i>fff</i>	<i>ppp</i>	<i>p</i>	<i>ppp</i>	<i>fff</i>
glockenspiel	-	-	-	<i>mp</i>		<i>fff</i>	<i>ppp</i>	<i>pp</i>	<i>ppp</i>	<i>fff</i>
crotales	-	-	-	<i>mp</i>		<i>fff</i>	<i>ppp</i>	<i>pp</i>	<i>pp</i>	<i>ffff</i>
chimes	<i>p</i>	<i>f</i>	<i>mp</i>	<i>p</i>	<i>f</i>	<i>ff</i>	<i>ppp</i>	<i>pp</i>	<i>ppppp</i>	<i>ffff</i>
timpani	<i>pp</i>	<i>fff</i>	-	-			<i>p</i>	<i>mp</i>	<i>n</i>	<i>ffff</i>
snare drum	<i>mp</i>	<i>fff</i>	<i>p</i>	<i>mp</i>	<i>ff</i>	<i>fff</i>	<i>pp</i>	<i>p</i>	<i>ppp</i>	<i>ffff</i>
tom-toms and other drums	<i>pp</i>	<i>fff</i>	<i>p</i>	<i>ff</i>	<i>fff</i>	<i>fff</i>	<i>pp</i>	<i>p</i>	<i>ppppp</i>	<i>ffff</i>
frame drum	-	-	-	-			<i>pp</i>	<i>f</i>	<i>n</i>	<i>ff</i>
djembe	-	-	-	-			<i>p</i>	<i>fff</i>	<i>n</i>	<i>ffff</i>
dumbek	-	-	-	-			<i>p</i>	<i>ff</i>	<i>n</i>	<i>ffff</i>
cymbals	<i>pp</i>	<i>ff</i>	<i>p</i>	<i>ff</i>	<i>ff</i>	<i>ff</i>	<i>pp</i>	<i>mf</i>	<i>n</i>	<i>ffff</i>
tam-tams	<i>pp</i>	<i>fff</i>	<i>p</i>	<i>ff</i>	<i>ff</i>	<i>fff</i>	<i>pp</i>	<i>mf</i>	<i>n</i>	<i>ffff</i>
nipple gongs	<i>p</i>	<i>ff</i>	<i>p</i>	<i>ff</i>	<i>ff</i>	<i>ff</i>	<i>pp</i>	<i>mp</i>	<i>n</i>	<i>ffff</i>
Chinese opera gongs	<i>p</i>	<i>fff</i>	<i>mp</i>	<i>fff</i>	<i>fff</i>	<i>fff</i>	<i>pp</i>	<i>f</i>	<i>n</i>	<i>fff</i>
triangle	-	-	-	<i>p</i>		<i>ff</i>	-	<i>ppp</i>	<i>mp</i>	<i>ff</i>
Japanese temple bowls/mixing bowls	<i>p</i>	<i>f</i>	<i>p</i>	<i>ff</i>	<i>ff</i>	<i>ff</i>	<i>p</i>	<i>mf</i>	<i>n</i>	<i>fff</i>
cowbells/agogo bells/almglocken	<i>p</i>	<i>ff</i>	<i>mp</i>	<i>fff</i>	<i>fff</i>	<i>fff</i>	<i>pp</i>	<i>mf</i>	<i>pppp</i>	<i>fff</i>
brake drums	<i>pp</i>	<i>f</i>	<i>mp</i>	<i>ff</i>	<i>ff</i>	<i>fff</i>	<i>pp</i>	<i>mp</i>	<i>n</i>	<i>ffff</i>
metal pipes	<i>pp</i>	<i>mf</i>	<i>p</i>	<i>ff</i>	<i>f</i>	<i>fff</i>	<i>ppp</i>	<i>mp</i>	<i>n</i>	<i>ffff</i>
thundersheet	<i>p</i>	<i>ff</i>	<i>p</i>	<i>ff</i>	<i>ff</i>	<i>fff</i>	<i>pp</i>	<i>mf</i>	<i>n</i>	<i>fff</i>
steel drums	<i>p</i>	<i>f</i>	-	-			<i>p</i>	<i>mf</i>	<i>n</i>	<i>ff</i>
wood blocks	<i>p</i>	<i>ff</i>	<i>p</i>	<i>fff</i>	<i>fff</i>	<i>fff</i>	<i>pp</i>	<i>mf</i>	<i>ppp</i>	<i>fff</i>
temple blocks	<i>p</i>	<i>ff</i>	<i>p</i>	<i>ff</i>	<i>ff</i>	<i>fff</i>	<i>pp</i>	<i>mf</i>	<i>ppp</i>	<i>fff</i>
log drums	<i>p</i>	<i>ff</i>	<i>p</i>	<i>ff</i>	<i>ff</i>		<i>pp</i>	<i>mp</i>	<i>pppp</i>	<i>fff</i>
wood drums	<i>p</i>	<i>ff</i>	<i>mp</i>	<i>fff</i>	<i>fff</i>	<i>fff</i>	<i>pp</i>	<i>f</i>	<i>pppp</i>	<i>ffff</i>
crystal glasses	<i>pp</i>	<i>mf</i>	-	-			<i>ppp</i>	<i>mp</i>	<i>pppp</i>	<i>mf</i>
tambourine	<i>mp</i>	<i>ff</i>	<i>mp</i>	<i>ff</i>	<i>ff</i>	<i>ff</i>	<i>mp</i>	<i>ff</i>	<i>mp</i>	<i>fff</i>
bell tree	-	-	-	<i>mp</i>		<i>ff</i>	-	<i>pp</i>	<i>mp</i>	<i>ff</i>

written dynamic	<i>p</i>	<i>ff</i>	min dynamic	max dynamic
six-foot grand piano	<i>p</i>	<i>ff</i>	<i>pppp</i>	<i>ffff</i>
	no beater			
castanets	<i>mp</i>	<i>ff</i>	<i>pp</i>	<i>ffff</i>
maracas/shakers	<i>mp</i>	<i>f</i>	<i>ppp</i>	<i>f</i>
guiro	<i>mp</i>	<i>ff</i>	<i>ppp</i>	<i>fff</i>
washboard	<i>mp</i>	<i>fff</i>	<i>pp</i>	<i>ffff</i>
claves	<i>p</i>	<i>ff</i>	<i>pppp</i>	<i>fff</i>
cabasa	<i>mp</i>	<i>f</i>	<i>p</i>	<i>f</i>
ratchet	<i>mf</i>	<i>ff</i>	<i>p</i>	<i>ff</i>
mark tree	<i>mp</i>	<i>mf</i>	<i>p</i>	<i>mf</i>
wind chimes	<i>mp</i>	<i>f</i>	<i>p</i>	<i>f</i>
finger cymbals	<i>p</i>	<i>mf</i>	<i>pppp</i>	<i>mf</i>
slapstick/whip	<i>mp</i>	<i>fff</i>	<i>ppp</i>	<i>fff</i>
vibraslap	<i>mf</i>	<i>ff</i>	<i>mp</i>	<i>f</i>
sleighbells	<i>p</i>	<i>f</i>	<i>ppp</i>	<i>f</i>
sandpaper blocks	<i>p</i>	<i>mf</i>	<i>pppp</i>	<i>f</i>
whistles	<i>mf</i>	<i>ff</i>	<i>p</i>	<i>fff</i>
sirens	<i>mp</i>	<i>fff</i>	<i>mp</i>	<i>fff</i>
conch shell	<i>mf</i>	<i>fff</i>	<i>mf</i>	<i>fff</i>
wind machine	<i>mp</i>	<i>ff</i>	<i>p</i>	<i>fff</i>
rainstick	<i>p</i>	<i>mf</i>	<i>pppp</i>	<i>f</i>
flexatone	<i>mf</i>	<i>ff</i>	<i>p</i>	<i>ff</i>
lion's roar	<i>mp</i>	<i>f</i>	<i>pppp</i>	<i>ff</i>
quica	<i>p</i>	<i>f</i>	<i>pppp</i>	<i>f</i>
friction roll/superball mallets	<i>pp</i>	<i>mf</i>	<i>pppp</i>	<i>f</i>

# Appendix E

## suggested works

This is an extensive list of pieces in which percussion is put to good use. It is strongly recommended that the composer study as many of these as possible. Scores and recordings of these works should be available at most music libraries.

All of these pieces use percussion sounds well; however, some are not well notated or do not use the instruments idiomatically.

Many of the annotations below make reference to “traditional” orchestral percussion instruments. Traditional instruments are those most often found in an orchestral percussion section (e.g., timpani, snare drum, bass drum, cymbals, triangle, tambourine, castanets, tam-tam, keyboard percussion, woodblock, etc.) and are usually used outside of a setup (i.e., one player per instrument).

### **Full orchestra:**

John Adams

*Harmonielehre, Short Ride in a Fast Machine, Chairman Dances*

Adams’s percussion perfectly compliments his powerful and shimmering orchestrations. These pieces feature large assortments of both pitched and unpitched instruments.

Louis Andriessen

*De Materie, De Tijd*

*De Materie* is a huge four-movement work for large orchestra which uses numerous percussion instruments in many varied musical settings. *De Tijd* is a 45 minute long single-movement work for orchestra and chorus in which long sustained chords are punctuated by wood and pitched metal percussion.

Samuel Barber

*Medea’s Meditation and Dance of Vengeance, 2nd Essay for Orchestra, Piano Concerto*

Barber’s percussion writing is simple but very effective. Note the xylophone solo in *Medea’s Meditation* and the timpani parts in all three pieces.

- Bela Bartók *Piano Concerti No. 2, 3, Violin Concerto No. 2, Concerto for Orchestra, Miraculous Mandarin*  
 Bartók's timpani writing is fantastic and often features these instruments in melodic solo roles. Percussion<sup>1</sup> is traditionally scored; it is often used sparsely but always very tastefully and effectively. Note the snare drum solo in the second movement of the *Concerto for Orchestra*.
- L. v. Beethoven *Symphonies No. 3, 5, 7, 8, 9*  
 Beethoven is one of the first great masters of timpani writing. The Ninth also includes bass drum, cymbals, and triangle in the last movement.
- Luciano Berio *Sinfonia*  
*Sinfonia* features a large orchestra with eight vocalists and a variety of pitched and unpitched percussion.
- Leonard Bernstein *Symphonic Dances from West Side Story*  
 Bernstein uses a large number of instruments and features them in passages of Jazz and Latin music. The percussion is notated in an undivided score part which is rather disorganized and is a bit of a challenge to properly divide among the individual players.
- Pierre Boulez *Pli selon Pli*  
*Pli selon Pli* is for orchestra and soprano with an enormous battery of keyboard percussion, pitched and unpitched metal instruments, timpani, and other drums.
- Benjamin Britten *War Requiem, Peter Grimes, Young Person's Guide to the Orchestra*  
 These pieces exhibit Britten's very skillful writing for traditional percussion instruments.
- Elliott Carter *Double Concerto, What Next?, Clarinet Concerto*  
 All three pieces use three or four percussionists with large setups of primarily unpitched instruments. *Double Concerto* is a concerto for piano and harpsichord; *What Next?* is an opera.
- Aaron Copland *Appalachian Spring, Symphony No. 3, Rodeo, Billy the Kid*  
 These pieces feature very effectively active percussion sections, traditionally scored.
- Claude Debussy *La Mer, Nocturnes*  
 Debussy's percussion sonorities are some of the earliest of its particular aesthetic. Note the second movement of *La Mer*.
- Jacob Druckman *Windows, Aureole*  
 Druckman fashions shimmering orchestrations and skilled sound combinations with a large and varied collection of percussion instruments.

1. Although timpani are percussion instruments, timpani and other percussion are usually treated as separate entities in an orchestral setting.

- Henri Dutilleux *Symphony No. 2, Violin Concerto, Cello Concerto*  
Dutilleux's writing is often sparse but very beautiful for both timpani and percussion.
- George Gershwin *An American in Paris, Porgy and Bess*  
Gershwin's percussion creates a fun, early-20<sup>th</sup>-century American jazz sound.
- Gustav Holst *The Planets*  
*The Planets* features a large battery of percussion with two timpanists playing melodies between them.
- Charles Ives *Three Places in New England, Symphony No. 4*  
Ives's percussion elicits images of haywire marching bands, late night barn dances, and views of the firmament.
- Gyorgy Ligeti *Piano Concerto, Violin Concerto, Hamburg Concerto*  
Percussion in these works is quirky and dance-like, often doubling or punctuating other instruments in the ensemble.
- Gustav Mahler *Symphonies*  
A master of symphonic percussion writing, Mahler uses traditional orchestral percussion instruments in roles that are often commanding and soloistic. Two timpanists are used in Symphonies No. 1, 2, 3, 6, and 8.
- Colin McPhee *Tabuh-Tabuhan*  
McPhee produces gamelan orchestra sounds from a traditional Western orchestration.
- Olivier Messiaen *Chronochromie, Turangalila-Symphonie, Oiseaux Exotiques*  
These are amazing works with extensive and brilliantly scored parts for keyboard percussion and metal instruments.
- Carl Nielsen *Symphony No. 4 "The Inextinguishable," Symphony No. 5, Clarinet Concerto*  
The 4th features a very involved timpani part, including a battle between two antiphonal timpanists in the last movement. The 5th has a snare drum cadenza which is executed out of time with the rest of the orchestra. The concerto features the snare drum in a very prominent roll as an antagonist of the solo clarinet.
- Sergei Prokofiev *Romeo and Juliet, Lieutenant Kijé Suite, Piano Concerto No. 3, Symphonies No. 5, 6*  
Prokofiev's percussion writing is very sensitive and tasteful. Bass drum is especially well used, and dynamics are notably well indicated.

E. suggested works

- Maurice Ravel *Daphnis et Chloe, La Valse, Alborada del Gracioso, Rhapsodie Espagnol*  
Ravel's use of percussion is always elegant. He evokes Spanish sounds in *Alborada del Gracioso* and *Rhapsodie Espagnol*.
- Christopher Rouse *Gorgon, Cello Concerto, Symphonies No. 1, 2, Phantasmata, Iscariot*  
These pieces feature very loud, powerful, and aggressive percussion, perfectly scored. Also note the more delicate subtle sounds in parts of *Gorgon* and especially in the *Cello Concerto*.
- Dimitri Shostakovich *Symphonies*  
Shostakovich is, alongside Mahler, one of the kings of traditional symphonic percussion writing. Note the snare drum parts of 5, 7, 10, and 11. Also note the clever instrument combinations at the end of 15.
- Jean Sibelius *Symphonies No. 1, 2, Violin Concerto*  
Sibelius's use of timpani is especially unique. Note the expansive rolls.
- Richard Strauss *Salome's Danse, Burleske*  
These two works feature great timpani writing.
- Igor Stravinsky *Rite of Spring, Petrouchka, Firebird*  
The *Rite* primarily uses drums (timpani and bass drum) to evoke its ritualistic terror. The other two ballets use a wider selection of instruments, often in rather playful orchestrations.
- Michael Torke *Green, Ecstatic Orange*  
Torke's percussion assists his very bright and lively American sound.
- Edgar Varèse *Amériques, Arcana*  
Sirens, lion's roar, and many other instruments dramatize Varèse's already very dramatic music.
- Anton Webern *Six Pieces op. 6, Five Pieces op. 10*  
These are very carefully and well orchestrated pieces from Webern's early period.
- Charles Wuorinen *Grand Procession*  
This is a striking piece with many pitched instruments as well as a standard orchestral assortment of drums, cymbals, and gongs.
- Frank Zappa *Dog Breath Variations/Uncle Meat*  
Delightfully playful percussion writing accompanies this orchestral setting of a pair of Zappa's early tunes.

### Smaller mixed ensembles:

- John Adams                      *Chamber Symphony*  
This is a tour de force for every instrument in the ensemble, including a drumset-like setup.
- George Antheil                      *Ballet Mechanique, A Jazz Symphony*  
*Ballet Mechanique* is for four pianos, percussion, two airplane propellers, and two alarm bells. *A Jazz Symphony* is for chamber orchestra. Both pieces have extensive xylophone parts and involved parts for other traditional orchestral percussion instruments.
- Bela Bartók                      *Sonata for Two Pianos and Percussion, Music for Strings, Percussion and Celeste*  
Bartók delivers significant innovations in timpani writing in both pieces and in percussion writing in the *Sonata*.
- Luciano Berio                      *Circles, Linea, Laborintus II*  
*Circles* is for mezzo-soprano, harp, and two percussionists with enormous setups. Some percussion is also played by the vocalist. *Linea* is for marimba, vibraphone, and two pianos. *Laborintus II* is for chamber orchestra, voices, and tape with two antiphonal drumsets.
- Pierre Boulez                      *Sur Incises*  
*Sur Incises* is for three pianos, three harps, and three percussionists playing pitched instruments (marimba, vibraphones, glockenspiel, chimes, crotales, steel drums, and timpani).
- George Crumb                      *Ancient Voices of Children, Music for a Summer Evening, Idyll for the Misbegotten, Madrigals*  
*Ancient Voices of Children* is for mezzo-soprano, boy soprano, oboe, mandolin, harp, musical saw, piano, and three percussionists (each with large setups). *Music for a Summer Evening* is for two pianos and two percussionists (each with very large setups). *Idyll for the Misbegotten* is for flute and three percussionists (two with similar setups of wood instruments and drums and the other with only one large bass drum). The *Madrigals* are a collection of songs for soprano with percussion (one player), flute, bass, and harp in various combinations. All of these works contain many unique sounds and playing techniques.
- Jacob Druckman                      *Animus II, Dark Upon the Harp, Come Round*  
*Animus II*, for soprano, two percussionists, and tape, is a theatrical piece with multiple large percussion setups around the concert hall. Some percussion is also played by the vocalist. *Dark Upon the Harp* is for two percussionists, brass quintet, and soprano. *Come Round* is for violin, cello, flute, clarinet, piano, and percussion (usually with one player but is sometimes done with two).

- Lou Harrison *Concerto for Violin and Percussion Orchestra*  
This piece, like many of Harrison's works, uses Western percussion instruments to evoke the sounds of a gamelan orchestra.
- Olivier Messiaen *Et Expecto Resurrectionem Mortuorum*  
This piece is for large wind ensemble with many gongs, cymbals, and keyboard percussion instruments (including extensive parts for chimes and almglocken).
- Darius Milhaud *La Création du Monde*  
This piece is for chamber orchestra with two percussionists: timpani (with pitches too high for normal timpani - often played on bongos or roto-toms) and a drumset-like setup.
- Steve Reich *Tehillim, Music for Eighteen Musicians*  
*Tehillim*, for chamber orchestra and four voices, uses tamborims tuned to specific pitches, clapping, maracas, vibraphone, marimba, and crotales. *Music for Eighteen Musicians* uses several keyboard percussion instruments, maracas, pianos, voices, clarinets, and strings. Both pieces have difficult maraca parts which challenge the performer's endurance.
- Alfred Schnittke *Hymn No. 1*  
*Hymn No. 1*, for cello, harp, and timpani, is very soft and delicate with melodic material for the timpani.
- Igor Stravinsky *Les Noces, Histoire du Soldat*  
*Les Noces* uses traditional orchestral percussion with chorus and four pianos; *Histoire du Soldat* uses a drumset-like setup with violin, bass, clarinet, trumpet, and trombone.
- Edgar Varèse *Hyperprism, Intégrales*  
These pieces exhibit Varèse's distinct percussion writing with brass and woodwinds.
- Charles Wuorinen *New York Notes, Grand Union, Spin Off, Percussion Duo*  
*New York Notes*, for violin, cello, flute, clarinet, piano, and percussion, has a percussion part written for one person which is so difficult that it is often played with two players. *Grand Union* is for cello and four drums; *Spin Off* is for violin, bass, and four congas; *Percussion Duo* is for piano and stacked marimba/vibraphone.
- John Zorn *For Your Eyes Only*  
This is a piece which, in under fourteen minutes, uses about 60% of the instruments discussed in this book within dozens of musical styles.



## Percussion ensemble:

- John Cage *Third Construction*  
This is a phenomenal percussion quartet which uses a variety of drums, tin cans, shakers, rattles, and other unpitched instruments.
- Sofia Gubaidulina *In the Beginning there was Rhythm*  
*In the Beginning there was Rhythm* is for timpani solo with percussion ensemble. The solo timpani part requests that the performer play with hands, fingers, and fingernails and also contains some carefully notated articulations and idiomatic melodic passages. The ensemble contains three additional timpanists (each with only one drum) as well as marimba played while wearing bell bracelets.
- Minoru Miki *Marimba Spiritual*  
This very Japanese piece is for marimba solo with three percussionists.
- Steve Reich *Sextet, Drumming*  
*Sextet* is a five movement piece with pianos, synthesizers, marimbas, vibraphones (with extensive bowing), crotales, bass drums, and stick clicks. *Drumming* is a phasing piece in four movements, each with its own instrumentation: 1) four pairs of tuned bongos, 2) three marimbas and two female voices, 3) three glockenspiels, piccolo, and whistling, 4) all the instruments combined.
- Christopher Rouse *Ku-Ka Ilimoku, Ogoun Badagris*  
Both of these pieces are extremely aggressive and ritualistic. *Ku-ka Ilimoku* is a quartet; *Ogoun Badagris* is a quintet.
- Toru Takemitsu *Rain Tree*  
This is a delicate trio with marimbas, vibraphone, and crotales. Takemitsu requests crotales out of the range of a normal set which must be specially made.
- Edgar Varèse *Ionisation*  
This is one of the first pieces written for percussion ensemble and requires an ensemble of 13 players playing a wide array of instruments.
- James Wood *Village Burial with Fire*  
*Village Burial with Fire* is a powerful ritualistic piece that uses many exotic instruments and requires the players to shout and stomp while wearing rattling ankle bracelets.
- Charles Wuorinen *Percussion Quartet*  
This is a dense serial piece which uses a large battery of pitched and unpitched instruments
- Iannis Xenakis *Pleiades, Persephassa, Ohko*  
*Pleiades* and *Persephassa* are huge works for percussion sextet. In both pieces, all six players have similar large setups. *Ohko* uses three players, each with one djembe.

**Percussion solo:**

Milton Babbitt

*Beaten Paths*

This is a very dense complex piece which, on the solo marimba, results in a delicate floaty aesthetic. Many mallet changes are requested where there is no time to do so; however, Babbitt indicates the player may take the necessary time to make the switch while attempting to maintain the metric orientation.

Elliott Carter

*Eight Pieces for Four Timpani*

These are the most important pieces in the solo timpani repertoire and served, for Carter, as a testing ground for his metric-modulation technique prior to its extensive debut in his First String Quartet. These pieces contain many special effects: different beating spots, dead strokes, harmonics, mutes, and unusual beaters.

Franco Donatoni

*Omar*

This piece for solo vibraphone explores many of the instrument's virtuosic and coloristic possibilities.

Jacob Druckman

*Reflections on the Nature of Water*

This is a marimba solo in six distinct movements which explores much of the marimba's color potential. The piece displays quite a bit of idiomatic writing with respect to both the way the instrument is played and the way the instrument sounds.

Morton Feldman

*The King of Denmark*

This study in instrumental color is notated graphically with a three part grid (indicating high, medium, and low pitches) that is peppered with numbers, letters, and symbols representing instruments and articulations. Instrument choice is almost entirely left up to the performer. The piece remains very quiet, and no sticks or mallets, only the performers hands, fingers, and arms can be used.

Vinko Globokar

*Toucher*

For this piece, the performer chooses a set of instruments, the sound of which imitate those of certain speech syllables. Excerpts from *Galileo Galilei* by Bertolt Brecht are recited (in French) and are accompanied by the percussion instruments. As the performer lowers the volume of his or her voice, the instruments are allowed to "speak" the text.

David Lang

*Anvil Chorus*

In this piece, overlapping ostinati are passed around a setup of somewhat open instrumentation: three resonant metals, four non-resonant metals, four pedal operated metals (with no additional specification), two wood blocks, and kick bass drum.

Steven Mackey

*See Ya Thursday*

This is a thoughtful and playful piece for marimba, written for a specific combination of mallets with different hardnesses. It also uses dead strokes to achieve short articulations.

- Minoru Miki      *Time*  
*Time* for marimba is a dark piece with haunting textures.
- Per Nørgård      *I Ching*  
This is a piece in four movements, each with its own large setup. The number of instruments required makes this piece especially difficult to perform outside of a conservatory.
- Frederick Rzewski      *To the Earth*  
*To the Earth* is for four flower pots and spoken voice. Specific pitches for the pots are requested; if those pitches are unavailable, pitches with the same relationships are acceptable. The text spoken is a Homeric poem. Unlike the Nørgård above, this piece is especially easy to transport and can be performed anywhere.
- Gunther Schuller      *Marimbology*  
This “study of the marimba” in four movements studies not just the many colors of the marimba but also the performer’s virtuosity. The demand on the performer is such that a successful realization is very difficult.
- Joseph Schwantner      *Velocities*  
This perpetual motion piece for solo marimba is another study of performer virtuosity. Schwantner makes frequent use of the sound of the mallet’s shaft on the edge of the bars.
- Paul Smadbeck      *Rhythm Song*  
*Rhythm Song* is a minimalist work for solo marimba which displays especially idiomatic writing.
- Karlheinz Stockhausen      *Zyklus*  
*Zyklus* features a large percussion setup and uses a very unique graphic notation.
- Andrew Thomas      *Merlin*  
*Merlin* is a two movement work for marimba - the first a slow, rolled choral, the second a rapid tour de force.
- Charles Wuorinen      *Janissary Music*  
This very difficult serial piece is scored for marimba, vibraphone, 12 unpitched metal instruments, 12 unpitched drums, and one timpano.
- Iannis Xenakis      *Rebonds, Psappha*  
*Rebonds* is in two movements (to be played in either order) with two slightly different setups - one of drums and woodblocks and one of just drums. Some of the material is more or less unplayable (too fast or too many voices), and performers are often forced to make significant compromises. *Psappha* is a single movement work which gives only guidelines for instrument choices, as timbre serves only to clarify the rhythmic structures. It is notated with points on a grid; *Rebonds* is notated traditionally.

**Percussion solo with orchestra:**

William Kraft

*Concerto for Timpani*

Kraft was a long time member of the Los Angeles Philharmonic as both a percussionist and a timpanist. His concerto is for five timpani (one player) and includes many interesting special effects: playing with leather and felt gloves, playing with small pocket scores of Haydn String Quartets on the drumheads, and playing with four timpani mallets. The writing for the percussionists in the orchestra is also very beautiful and interesting.

Steven Mackey

*Micro-Concerto*

This is a concerto for percussion with violin, cello, flute, clarinet, and piano. Although Mackey uses a large number of percussion instruments, he often focuses on one or two at a time and extracts numerous sounds from them. See also Appendix A.

James MacMillan

*Veni, Veni, Emmanuel*

This piece features a very large percussion setup with multiple stations. The orchestra also includes an active timpani part. At the end of the piece, every member of the orchestra plays a small metal instrument for a grand wind chime effect.

Christopher Rouse

*Der gerettete Alberich*

Influenced by Wagner and Rock 'n' Roll, this piece includes, among other things, a cadenza for guiro.

Joseph Schwantner

*Percussion Concerto*

The first and third movements of this piece feature a very supportive percussion section who play in unison (but on different instruments) nearly every note the soloist plays. The result is a very full rich complex sound, but one which does not exactly allow the soloist to be solo. In the entire second movement and in the improvised cadenza near the end of the piece, the soloist does get a chance to play without the percussion accompaniment.

Tan Dun

*Concerto for Water Percussion*

This is a dramatic piece which uses water both as an instrument and as a means to manipulate the pitch and tone of other instruments.

# Sources

- Adler, Samuel "The Study of Orchestration" WW Norton & Company,  
New York/London. 1982  
p328-362, 376-406
- Brindle, Reginald Smith "Contemporary Percussion" Oxford University Press,  
London/New York. 1991
- Burton, Steven Douglas "Orchestration" Prentice Hall, Inc.,  
Englewood Cliffs, NJ. 1982  
p196-243, 284-289, 494-498, 460-471
- Del Mar, Norman "Anatomy of the Orchestra" University of California Press,  
Berkeley/Los Angeles. 1981 p339-429
- Zeltsman, Nancy "Memo to Composers" [www.nancyzeltsman.com](http://www.nancyzeltsman.com) 2000

# index

## A

abbreviation, 23  
African music, 45  
Afro-Cuban music, 45  
afuche. *See* cabasa  
agogo bells, 38, 39, 41, 42, 45, 51, **98**  
almglocken, 31, 38, 39, 41, 42, 51, **98**  
antique cymbals. *See* crotales  
anvil, 42, **99**

## B

Balinese music, 45  
bass drum. *See* drums  
bass drum beaters, 38, 48, **52**, 96  
bass drum/cymbal attachment, 95  
bass drum pedal. *See* pedals  
bass tone, in hand drumming, 61, 71  
bell tree, 109  
bell, of cymbal, 56, 92  
    *See also* agogo bells  
    *See also* cowbell  
    *See also* glockenspiel  
    *See also* hand bell  
    *See also* sleighbells  
    *See also* chimes (tubular bells)  
bongos. *See* drums  
bottles, 103  
bow  
    bass or cello bow, 20, **39-41**, 44, 68, 84,  
        87, 97  
    bow of cymbal, 92

## bowls

    Japanese temple bowls, 18, 19, 38, 39, 41,  
        43, 45, 51, 68-69, **98**  
    rice bowls, 42, 51, **110**  
    mixing bowls, 43, 51, 98  
    timpani bowl, 11, 59, **68**  
brake drum, 42, 45, 51, **99**  
Brazilian music, 45  
Broadway musicals, 11  
brushes, 38, 45, **53-54**  
butt of beater, 49, 50-51

## C

cabasa, 104  
calf drum head. *See* drum head  
castanets, 42, 45, 51, **104**  
caxixi. *See* shakers  
celesta. *See* keyboard instruments  
center  
    of bar, 18, 20, 56, 86-87, 88  
    of drumhead, 56, 61, 62-63  
chimes, 15, 19, 21, 31, 33, 39, 43, 44, 54,  
    **77**, 78, 79, 82, 84, 88, 89  
    *See also* wind chimes  
    *See also* mark tree  
chime hammers, **54**, 82, 104  
chime pedal. *See* pedals  
china cymbal. *See* cymbals  
Chinese blocks. *See* temple blocks  
Chinese music, 45  
Chinese opera gongs. *See* gongs

Chinese tom-toms. *See* drums  
 chopsticks. *See* sticks  
 church bells, 89, **104**, 106  
 cimbalom, 10  
 claves, 42, 45, 54, 57, 88, **102**  
 clefs, 31, **32-33**, 65, 70, 75  
 clusters, 88  
 coconuts, 104  
 combo stick. *See* two-headed mallets  
 conch shell, 104  
 congas. *See* drums  
 conductor's score, 28  
 cowbells, 15, 38, 39, 41, 42, 45, 51, 56,  
**97-98**  
 crash cymbals. *See* cymbals  
 Crouch, Shawn, 22, 130-131, 135-141  
 cross stick. *See* rim click  
 crotales, 18, 19, 21, 31, 33, 38, 39, 43,  
 56, 68-69, **77**, 79, 80, 84, 85, 86-87, 88,  
 89, 100  
 crystal glasses, 20, 38, 39, 41, **105**  
 cues, 27  
 cuica. *See* quica  
 cup, of cymbal. *See* bell  
 cymbals, 17, 18, 19, 38, 39, 40-41, 43, 45,  
 50, 53, 55, 56, 58, 68, 73, **91-95**, 100  
 crash cymbals, 15, 45, 91, 92, **94-95**  
 hi-hat, 15, 58, **93-94**, 95  
 china, 92  
 sizzle, 92, 100

## D

dampening. *See* mutes  
 damper pedals. *See* pedals  
 dead stoke, 40, **41**, 61-62, 87  
 diagram. *See* setup diagram  
 dictionary of percussion terms, 3  
 djembe. *See* drums  
 dome, of cymbal. *See* bell  
 drag, 60

drums  
 tom-toms, 50, 64, **69-71**, 73  
 timpani, 11, 14, 18, 19, 27, 28, 31, 33,  
 41, 43, 48, 50, 59, 62-63, 64, **65-69**,  
 71, 87  
 snare drum, 15, 17, 19, 36, 42, 45,  
**69-70**, 73  
 tenor drum, 70  
 timbales, 45, 62, **70**  
 roto-toms, 18, 21, 31, 33, 63, 64, 67,  
**70-71**  
 bongos, 36, 45, 50, 64, 67, **71**  
 congas, 45, 50, 58, 61, 64, **71**  
 tamborim, 45, **71**  
 Chinese tom-toms, 45, **71**  
 bass drum, 38, 43, 44, 45, 48, 50, 55,  
**72-73**, 95  
 pedal bass drum, 15, 56, 65, **72-73**  
 frame drum, 45, 63, **72**  
 djembe, 45, 61, **72**  
 dumbek, 45, **72**  
 drumset, 45, 54, 60, **73**, 92, 110, 112  
 drum corps, 3  
 drum head, 18, 19, 20, 44, 50, 56, 59, 61-62,  
 62-64, 69, 70, 71, 73, 105, 109, 111, 112  
 drum sticks. *See* sticks  
 drumset. *See* drums  
 dulcimer. *See* cimbalom  
 dum, 61  
 dumbek. *See* drums  
 dynamics, 12, **14-15**, **34**, 41, 49, 51, 53-54,  
 55, 57, 58, 65, 69, 84, 102, 104, 105, 106,  
 107, 157-159

## E

edge  
 of drum head, 56, 61-63, 68  
 of cymbals and gongs, 38, 50-51, 56,  
 92, 105  
 of bar, 50, 56, 85, 86-87  
 electronic percussion, **9-10**, 16, 89

## F

felt mallet. *See* mallets  
field drum. *See* drums  
fight gongs. *See* gongs  
finger cymbal, 42, 45, 105  
flam, 60  
flexatone, 18, 39, 41, **105**  
flip stick. *See* two-headed mallets  
floor tom, 73  
frame drum. *See* drums  
French flam, 61  
friction roll, 18, 54, 62, **105**, 106, 112  
Friedman, Jefferson, 19, 28, 142-146  
Fuerst, Matthew, 81-82

## G

Gamelan, 45  
glissando, **18**, 19, 41, 63, **66**, **67**, 68, 70, **86**,  
87, 96, 100, 105, 108, 109  
glockenspiel, 18, 20, 43, **77**, 78, 80, 83, 84,  
85, 86, 88, 89  
*See also* keyboard glockenspiel  
gongs, 18, 38, 39, 40-41, 43, 45, 48, 51, 53,  
56, 91, **95-96**, 100  
tam-tam, 18, 19, 38, 48, 50-51, 55, 56, 58,  
**95**, 100  
nipple gong, 20, 21, 51, **96**  
wind gong, 96  
Chinese opera gong (fight gong), 18, **96**  
water gong, 18, 20, **100**  
gong beater, 48, 49, **52**  
gourd. *See* guiro  
guiro, 18, 45, 55, **106**

## H

hammer as used in Mahler  
Symphony No. 6, 106  
hammered dulcimer, 10  
hands, playing with: hand drumming, 14, 48,  
54, 55, **61-62**, 70, 71, 72, 102

hand bells, 106  
harmonics, 19, 55-58, 68, 87  
*See also* overtones  
hardware, 5  
harpsichord. *See* keyboard instruments  
head. *See* drum head  
headphones, 16  
hi-hat. *See* cymbals  
history of percussion, 3

## I

idiomatic writing, 14, 34  
for drums, 61, 64-65  
for keyboard instruments, 79-82  
indeterminate instrumentation, 34  
Indian music, 45  
instrument list, 12, **21**, 23, 24, 41, 115-134  
instrument key, **22**, 115-134

## J

Janissary band, 45  
Japanese temple bowls. *See* bowls  
Javanese gong. *See* nipple gongs  
Jazz, 45

## K

kalimba. *See* thumb piano  
keyboard instruments (piano, celesta,  
harpsichord), 10, 28  
keyboard glockenspiel, 89  
key signatures, 33  
kick drum. *See* pedal bass drum  
knitting needles, 53

## L

language, 3, 21, **23-24**  
lion's roar, 18, 105, **106**, 109  
log drum, 42, **101-102**



## M

- Mackey, Steven, 41, 49, 105, 113, 132-134, 168, 170
- mallets, **47-53**, 55, 61, 153-155
- mallet instruments, 14, 56, **75-89**
- mandolin roll, 38
- maracas, 8, 42, 45, **107**
- marching band, 45
- marimba, 9, 18, 19, 20, 36, 38, 39, 41, 42, 45, 48-49, 57, **75**, 78, 79, 80, 83-84, 84, 85, 86, 87, 88, 89
- marimshot, 88
- mark tree, 44, **108-109**
- mbira. *See* thumb piano
- Middle Eastern music, 45
- MIDI percussion, 9-10, 89
- military band. *See* marching band
- military drum. *See* snare drum
- mixing bowls. *See* bowls
- motor, of vibraphone, 18, **78**, 84
- mouth vibrato. *See* vibrato
- Muhly, Nico, 43, 150-151
- multiple percussionists, 10-11, 21, 22, 24, 28
- musical theater. *See* Broadway musicals
- mutes, muting (dampening), 20, 40, **41-44**, **56**, 61-62, 63, 87, 88, 94, 97, 100, 108

## N

- nipple gong. *See* gongs
- node, 56, 86-87
- non-percussionists, 12
- noteheads, 30, 67
- note length, 41-44, 57

## O

- ocarina, 113
- orchestra bells. *See* glockenspiel
- overtones, 18, 20, 55-58, 62, 68, 84, 87, 100, 107
- See also* harmonics

## P

- pandeiro, 45, **112**
- parts, 24-27
- pedals
- pedal operated instruments, 14, **15**, 32, 65
  - dampers pedals, 15, 19, **43-44**, 78, 83-84, 87, 88
  - See also* hi-hat
  - See also* timpani
- pedal bass drum. *See* drums
- piano. *See* keyboard instruments
- pipes, 38, 42, 45, **99**
- pitch bending, **18**, 20, 41, 63, 88, 96, 98, 103
- placement, of attack, 56
- on the drumhead, 62-63
  - on the bar, 86-87
- pop gun, 109
- prepared instruments, 11, 18, 19, 34, 68-69, 88, 92, 100

## Q

- quica, 18, 45, 106, **109**
- quinto, 71

## R

- rack, for gongs, 96
- rainstick, 109
- Ragtime, 45
- ranch triangle. *See* triangle
- ranges, 4
- keyboard instruments, 75-77, 79-80, 85, 89
  - timpani, 66-67
  - roto-toms, 71
  - drums, 63, 64
  - flexatone, 105
  - steel pans, 99
  - nipple gongs, 96
  - mouth vibrato, 87

ratchet, 17, **110**  
resonators, 19, 68-69, 78, 88  
rice bowls. *See* bowls  
ride cymbal. *See* cymbals  
rim, 50, 59-60, 61, 62, 68  
rim click, 60  
rimshot, 59-60  
rim tone, in hand drumming, 61-62  
ring time, 41-44, 91, 92, 94, 95, 96, 98, 108  
riq, 45, **112**  
rolls, 15, 18, **35-39**, 41, 44, 54, 58, 60,  
61, 62, 70, 84, 92, 94-95, 97, 104, 105,  
107, 112  
Rock 'n' roll, 45, 73, 112  
roto-toms. *See* drums  
ruff, 60  
rute, **54**, 71, **110**

## S

sandpaper blocks, 110  
saw, musical saw, 10, 105  
score  
    *See* conductor's score  
    *See* parts (score parts)  
scrape, 44, 53, 55, 78, 94, 100, 106, 110  
scrape tremolo, 53  
setup, 5, 7-34, 48, 64, 67, 71, 72, 73, 93,  
100, 107, 109, 115-135  
setup diagram, **23**, 115-134  
shakers, 8, 17, 42, 45, 73, **107-108**, 109  
shaft of beater, 48, 49, 50-51, 59-60, 85,  
88, 106  
shell, of drum, 17, 54, 62, 64, 69, 70,  
71, 110  
    *See also* conch shell  
side drum. *See* snare drum  
side stick. *See* rim click  
sirens, 18, 55, 110, 113  
six-mallet technique, 49  
sizzle cymbal. *See* cymbals

slap, in hand drumming, 61-62  
slap mallet, 53  
slapstick, 42, 111  
sleighbells, 8, 19, 73, **111**  
slide whistle. *See* whistles  
slit drum. *See* log drum  
snare drum. *See* drums  
Spanish music, 45  
speed, 12-14, 94  
splash cymbal. *See* cymbals  
stacked mallet instruments, 19, **83-84**  
staves, 28-31  
steel drums (steel pans), 10, **99-100**  
sticking, 5, 79-82  
stick tray. *See* trap table  
sticks, 35-36, 41, 47-48, 50, **51**, 54, 59-61,  
70, 92, 110  
stones, 111

Streber, Ryan, 31, 83, 147-149  
string drum. *See* lion's roar  
Superball mallets. *See* friction roll  
suspended cymbal. *See* cymbals  
symbol notation. *See* language  
sympathetic resonance, 18, **19**, 63, 68, 70,  
78, 87, 113

## T

tabla, 45  
tak, 61  
tam-tam. *See* gongs  
tam-tam beater. *See* mallets  
tambourine, 8, 19, 42, 45, 51, 72, 73 **111-112**  
tamborim. *See* drums  
tek. *See* tak  
temple blocks, 38, 42, 45, 51, 57, **101-102**  
temple bowls. *See* bowls  
tenor drum. *See* drums  
Thai gong. *See* nipple gongs  
thumb piano, 112  
timbales. *See* drums  
timpani. *See* drums  
timpani mallet. *See* mallets

tip, of stick. *See* sticks  
 Thumbs and pinkies, 79-82  
 thundersheet, 38, 39, 40-41, 51, 99  
 tom-toms. *See* drums  
 tone, in hand drumming, 61-62, 71  
 traps (trap kit). *See* drumset  
 trap table, 5  
 trap tray. *See* trap table  
 triangle, 18, 30, 38, 39, 41, 43, 44, 45, 51,  
 85, **97**, 100  
 triangle beater, 49, **53**, 54, 55, 100, 105,  
 106, 109  
 tubular bells. *See* chimes  
 tumba, 71  
 two-headed mallet, 38, 49, 52  
 two-toned mallet, 52

## U

unpitched instruments, 57

## V

vibes. *See* vibraphone  
 vibraphone, 15, 18, 19, 20, 36, 38, 39-40,  
 41, 42, 43, 44, 45, **76**, 78, 80, 83, 84, 85,  
 86, 87, 88, 89  
 vibraphone pedal. *See* pedals  
 vibraslap, 42, **113**  
 vibrato, **18**, 78, 87, 88, 97  
 vocal percussion, 45, 103

## W

washboard. *See* guiro  
 water gong. *See* gongs  
 wind chimes, 44, 89, **108-109**  
 wind gong. *See* gongs  
 wind machine, 18, **113**  
 whip. *See* slapstick  
 whistles (siren, bird, police, samba, slide,  
 train), 18, 45, 110, 113  
 wood blocks, 15, 42, 45, 51, 57, **101-102**  
 wood drums, 102  
 wood mallet. *See* mallets

## X

xylophone, 18, 20, 38, 39, 42, 45, **76**, 78, 80,  
 83, 84, 86, 88, 89  
 xyloimba, 89

## Y

yarn mallet. *See* mallets

Percussionist Samuel Z. Solomon has been responsible for dozens of world premieres of solo and small ensemble works. With saxophonist Eric Hewitt, he is co-founder of the Yesaroun' Duo; the Duo has been featured in recitals all over the northeast United States, in Italy, and in Cuba. Mr. Solomon made his Carnegie Hall debut in February of 2000, performing the world premiere of John Mackey's *Concerto for Percussion and Orchestra* as guest soloist with the New York Youth Symphony. In December 1999 he was featured in Lincoln Center's Alice Tully Hall, performing the American premiere of Iannis Xenakis's final composition, *O-Mega* for percussion solo and chamber orchestra, with the New Juilliard Ensemble. Mr. Solomon spent six summers at Tanglewood, three as a Fellow of the Tanglewood Music Center, and six years at Juilliard, receiving two degrees. He lives in New York City. Visit [www.szsolomon.com](http://www.szsolomon.com).



PHOTO: DAVID FOX