

GEOMETRÍA

⋮

Programa

Año 2012.

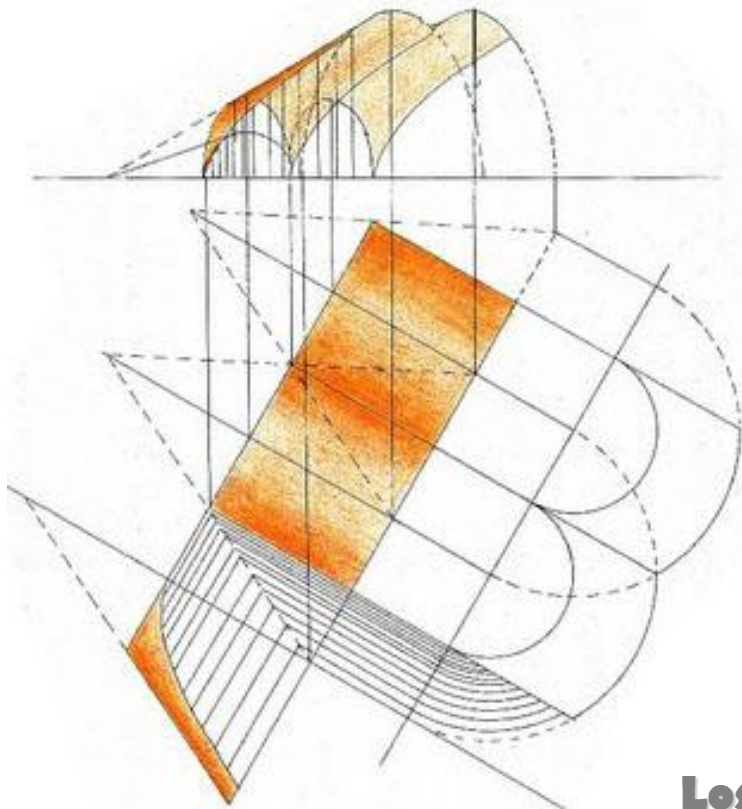

GEOMETRIA

IDIOMA

LENGUAJE

DEL DISEÑO

Las PALABRAS para el LENGUAJE

Las NOTAS para la MUSICA

Los NUMEROS para las MATEMATICAS

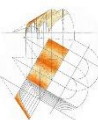

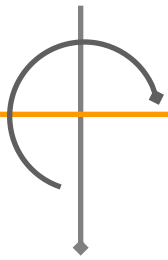

Geometría.

•Un lenguaje estructurado.

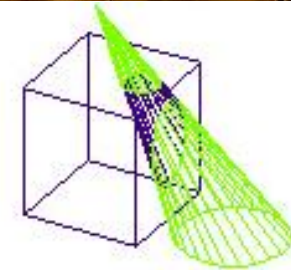
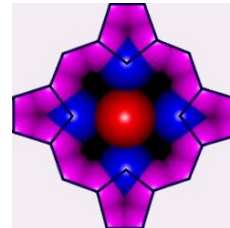
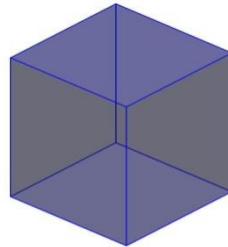
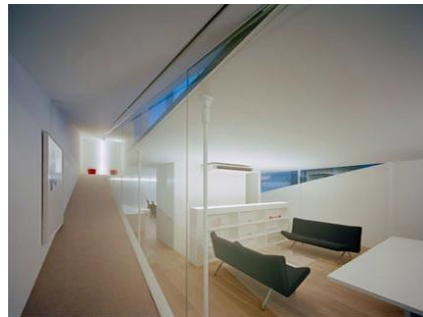

ESTRUCTURA Y LENGUAJE

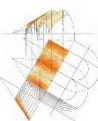

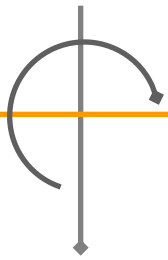

Lenguaje estructurado expresado en.

•Espacios Públicos.

■ Simetría

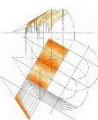
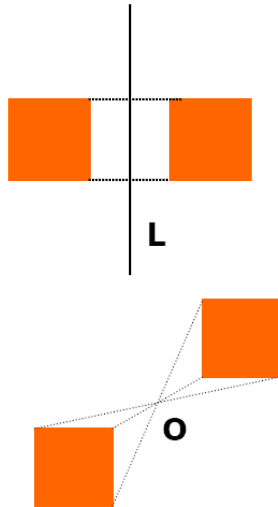

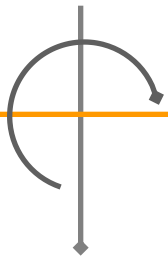

Lenguaje estructurado expresado en.

- Proporción Áurea.

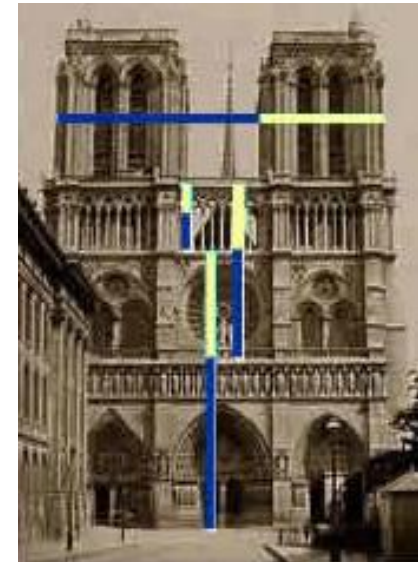
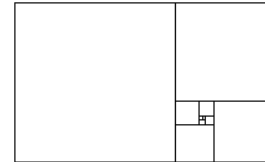
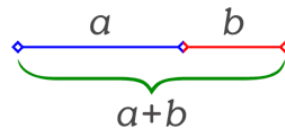

DIVINA PROPORCIÓN/ PROPORCIÓN AUREA

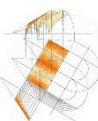

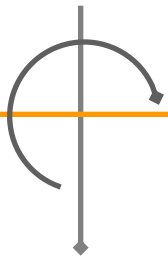

Lenguaje estructurado expresado en.

- Patrones Simétricos.

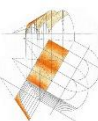
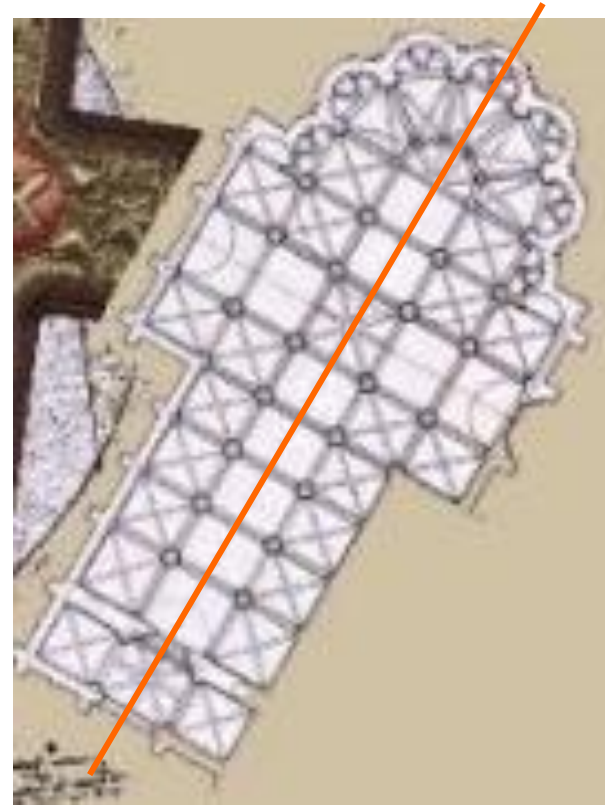
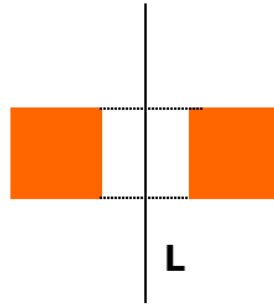

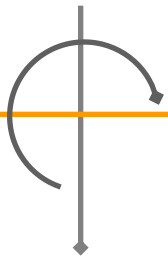

Lenguaje estructurado expresado en.

•Infraestructura.

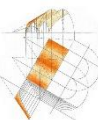
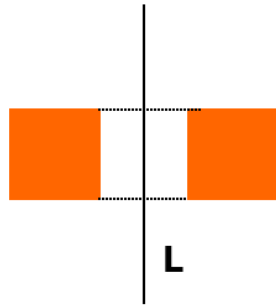

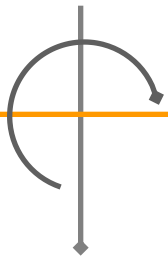

Lenguaje estructurado expresado en.

•Superficies regladas

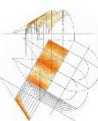
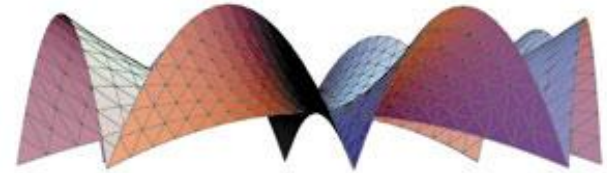
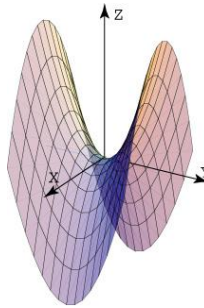
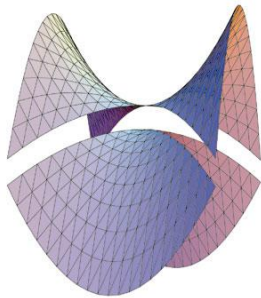



Lenguaje estructurado expresado en.

- Terminaciones.

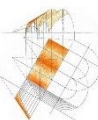
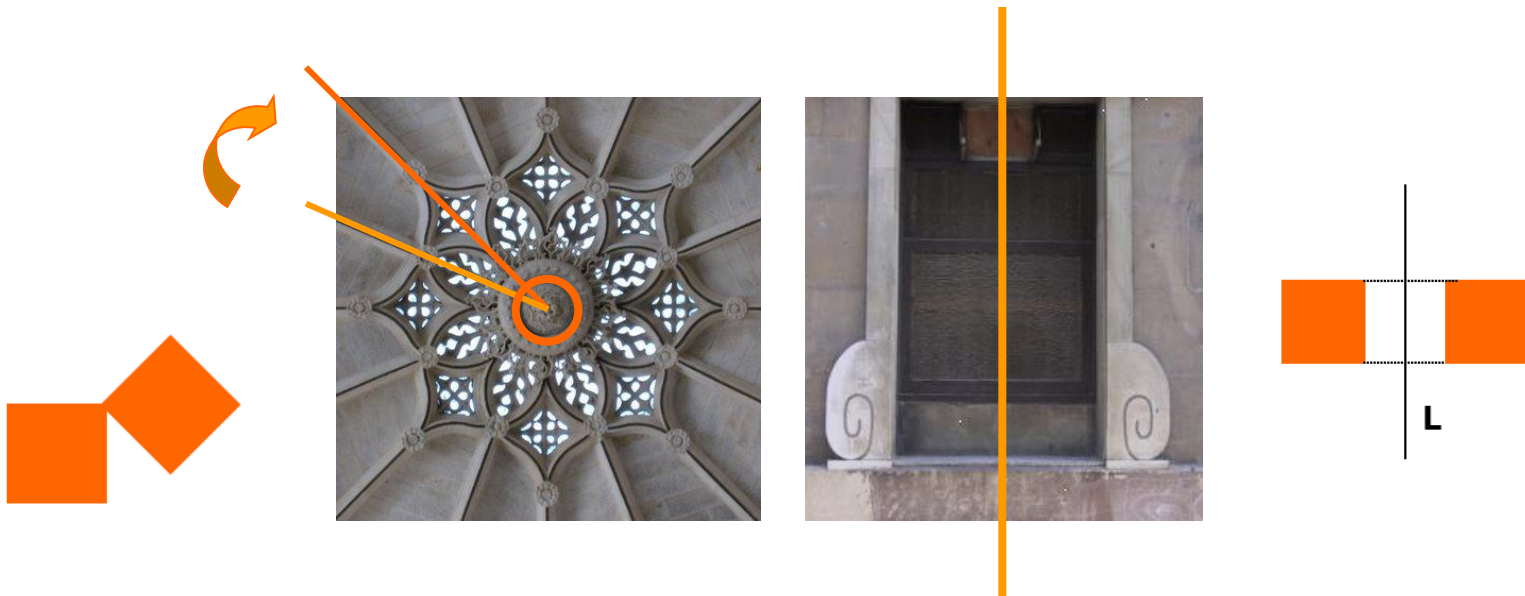

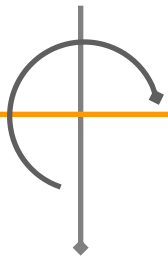

Lenguaje estructurado expresado en.

- Ornamentos.

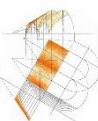
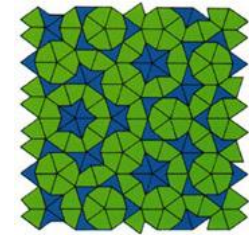
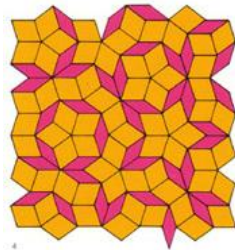

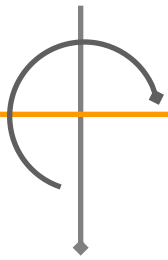

Lenguaje estructurado expresado en.

- Mobiliario.

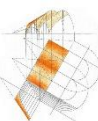

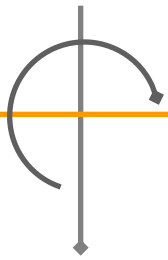

Lenguaje estructurado expresado en.

•Flora y Fauna

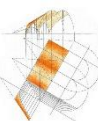
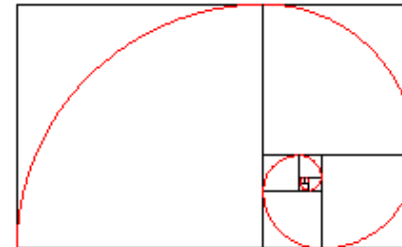

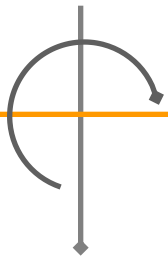

GEOMETRÍA



Programa Año 2012.

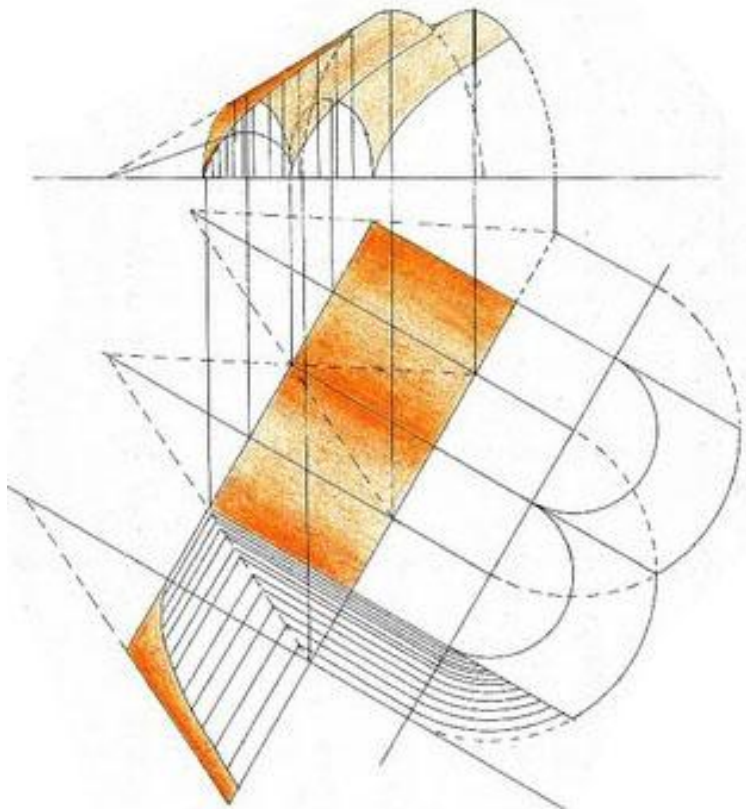

CONTENIDOS PROGRAMATICOS

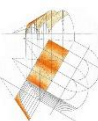

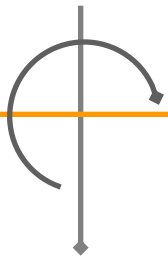

Descripción.

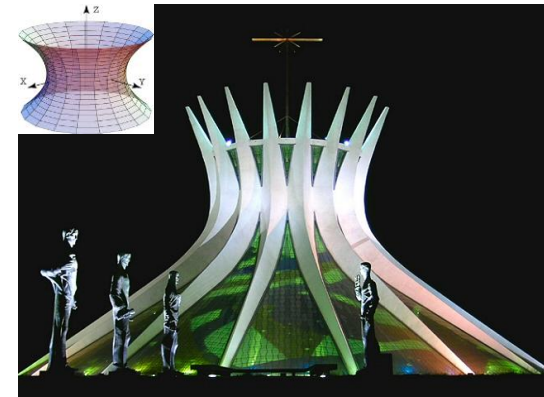
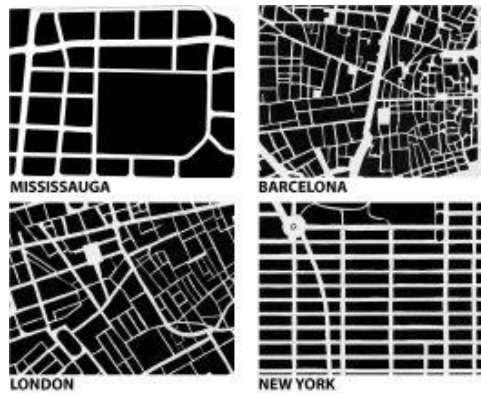

- Actividad graduada y orientada.

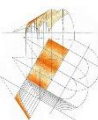

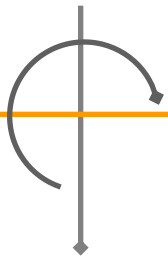

Objetivo Intelectual.

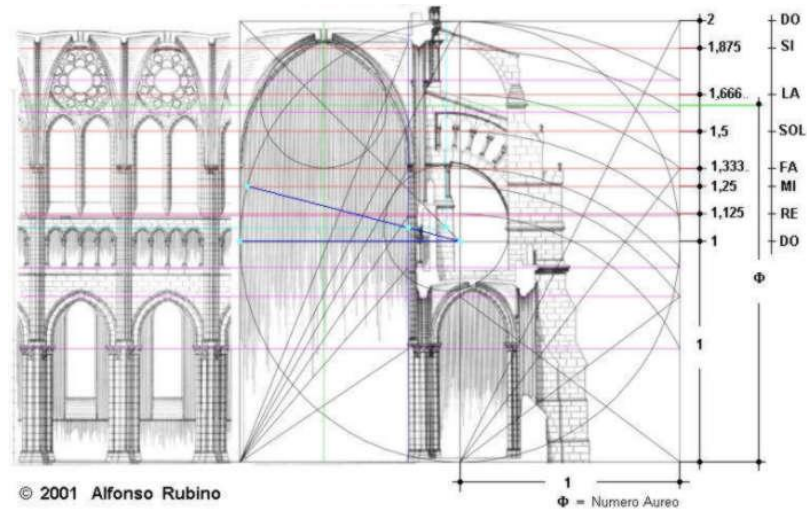
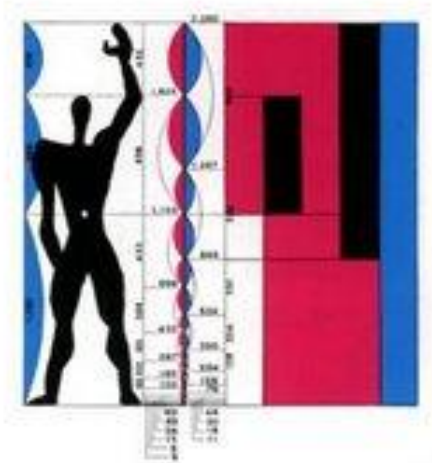

- Forma y orienta al concepto y la ley, a fin de medir e intuir el espacio.

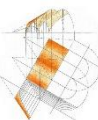

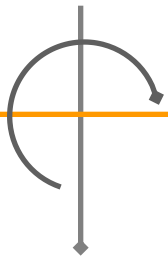

Objetivo Psicomotor.

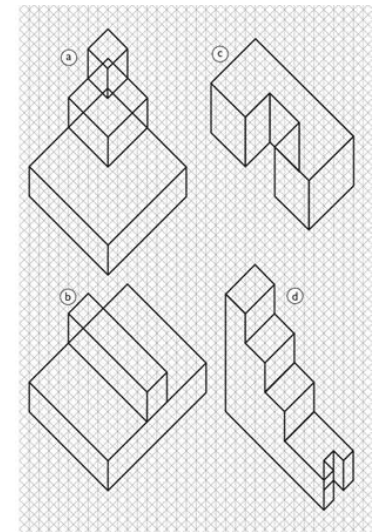
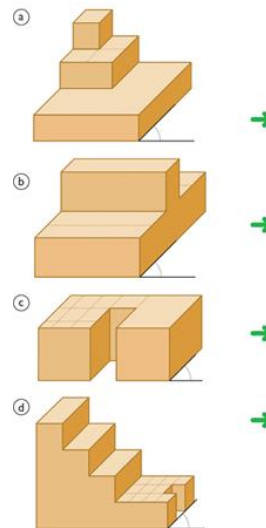
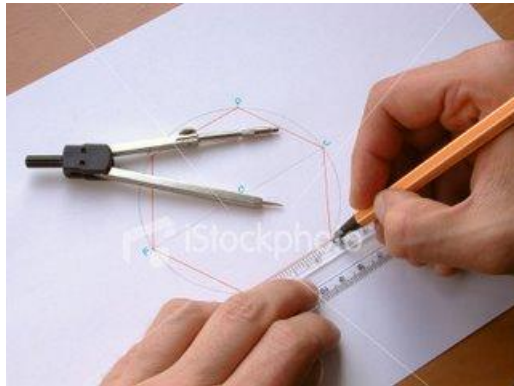

- Habilita entregando técnicas de representación espacial y manejo mecánico e instrumental.

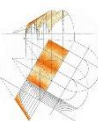



Objetivo Psicomotor.

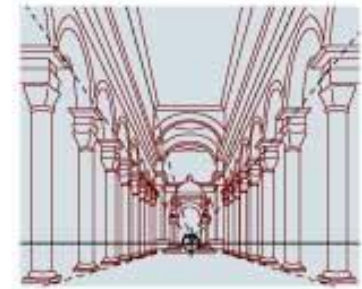
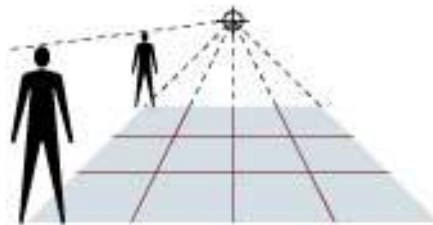

- Habilidad para expresar el espacio a través del lenguaje geométrico.

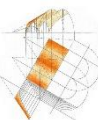

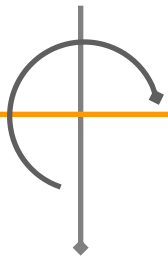

Objetivo Afectivo.

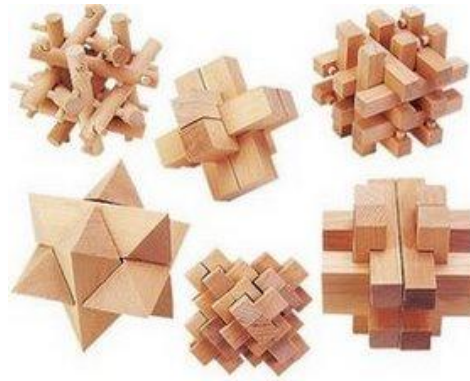
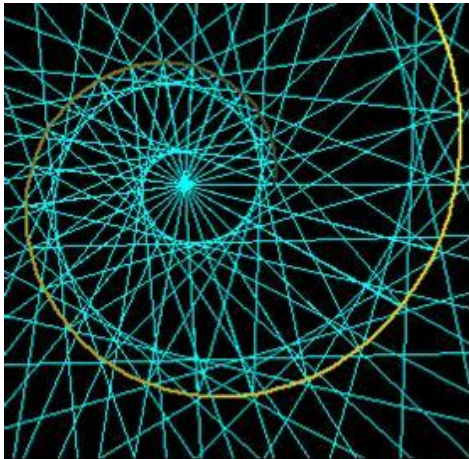

- Estimula la exploración de la forma y los espacios y los espacios geométricos .
- Estimula los procesos creativos.

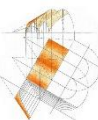

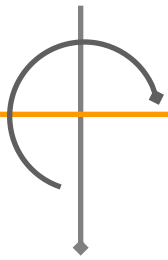

Unidades Temáticas.

- Teoría de las Transformaciones.
- Transformaciones Euclidianas.

- Transformaciones Proyectivas de 1º Categoría.

- Transformaciones Proyectivas de 2º Categoría.

1º Semestre.

- 1º CICLO.

- 2º CICLO.

- 3º CICLO.

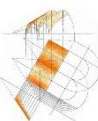

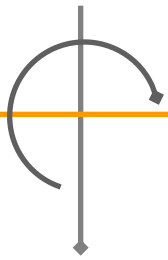

Unidades Temáticas.

• Proyección Afín Ortogonal

• Transformación de formas tridimensionales en formas bidimensionales.

• Transformaciones de elementos proyectantes

• Perspectiva.

2º Semestre.

• 4º CICLO.

• 5º CICLO.

• 6º CICLO.

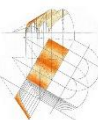

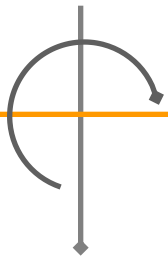

1º Ciclo.

- Teoremas.
- Definiciones y notaciones.



- Teoría de las Transformaciones.
- Isometrías, o Movimientos Rígidos.
- Isomórficas
- Anamórficas.

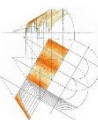
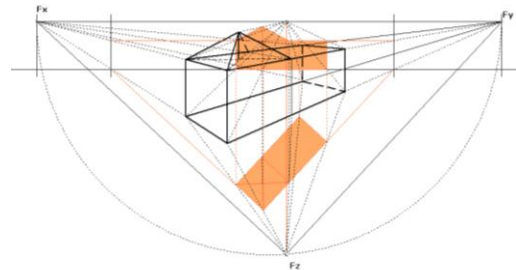
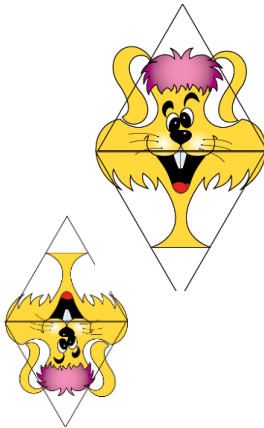

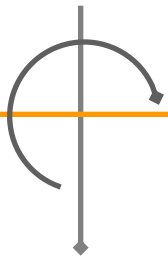

Isometrías.

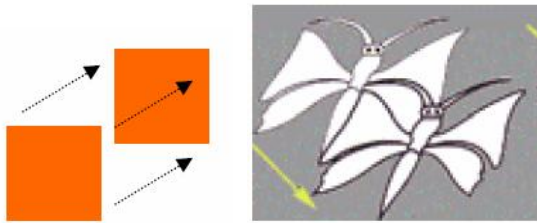

- Transformaciones que mantienen la forma. Formas congruentes .

- Traslaciones.

- Rotaciones.

- Reflexiones con respecto a un punto y a una recta.

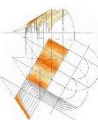
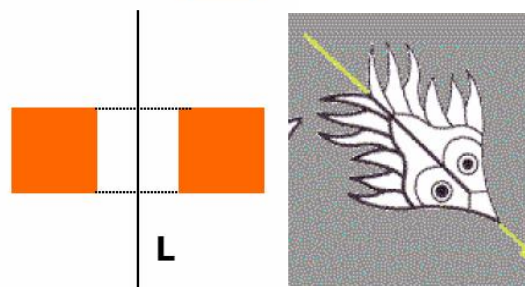
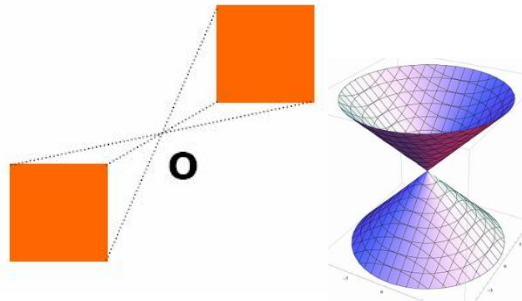

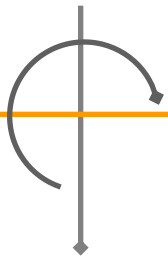

Transformaciones Isomórficas.

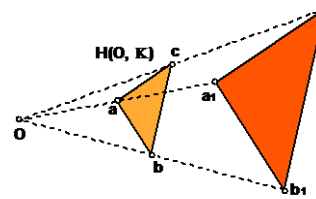

• Producto de Transformaciones que generan formas semejantes.

• Homotecia Directa, la forma aumenta de tamaño.

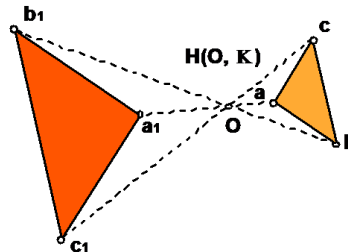

• Homotecia Inversa, la forma disminuye de tamaño.

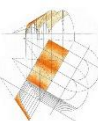

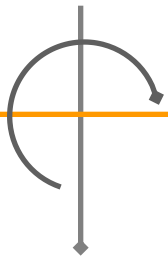

Combinación de Transformaciones.

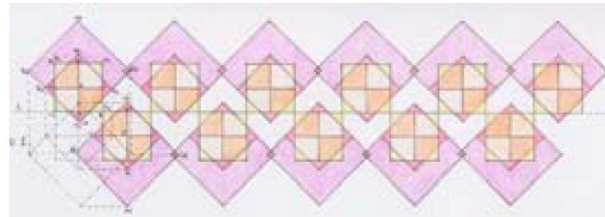
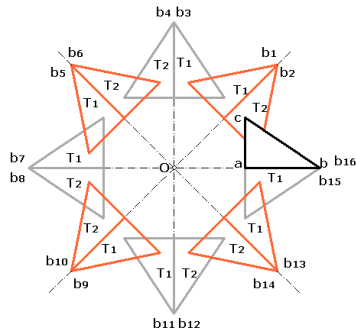

- Producto de Transformaciones que generan simetrías traslatorias y rotatorias.

- Simetrías donde intervienen transformaciones que dan origen solo a formas congruentes

- Simetrías donde interviene la transformación homotecia.

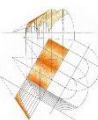
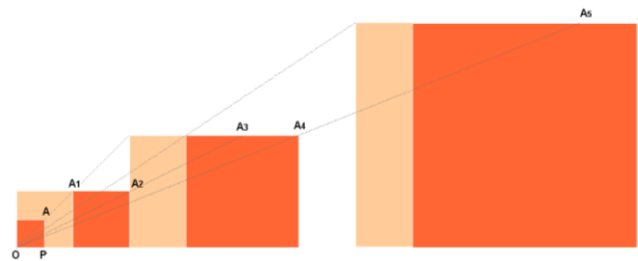
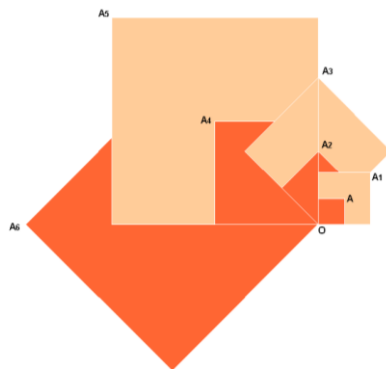



Transformaciones Anamórficas.

• Transformación involutiva.

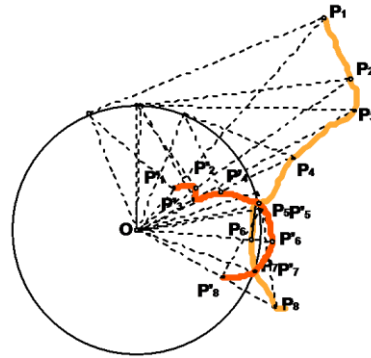

• Transformaciones que dan origen a nuevas formas.

• Inversión.

• Polos y Polares de Puntos y Curvas.

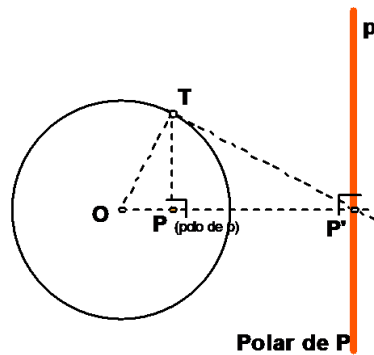

• Polo Polar

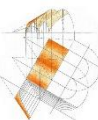

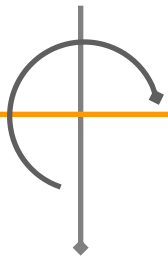

Transformación Inversión.

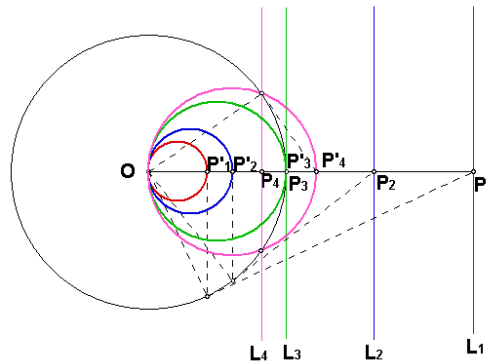
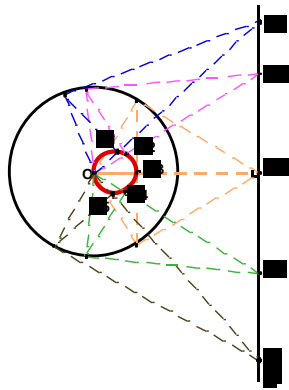

• Inversos de puntos y curvas.

• Rectas que se invierten en circunferencias.

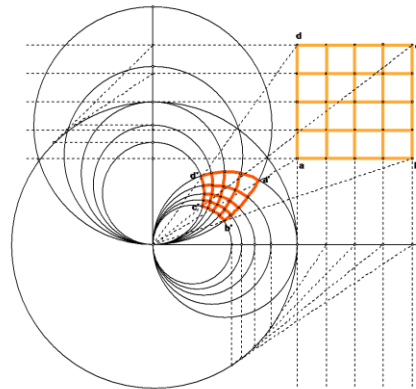
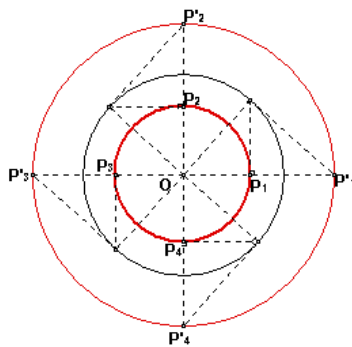

• Circunferencias que se invierten en circunferencias

• Aplicación.

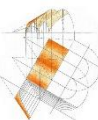

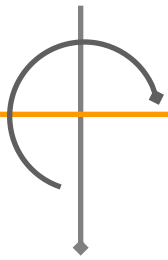

Transformación Polo Polar.

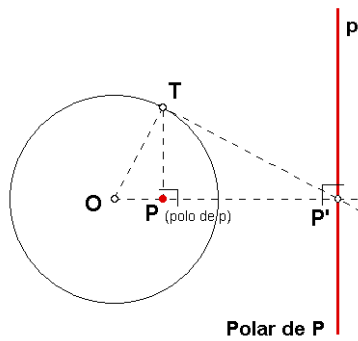

Polar de P

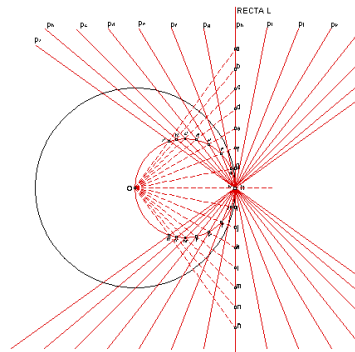

• Polares de puntos, rectas y circunferencias.

• Polar de un Punto.

• Polar de una Recta

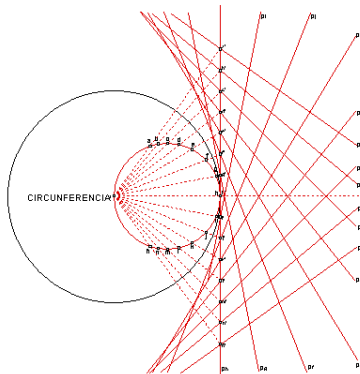

• Polar de una Circunferencia.

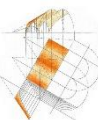

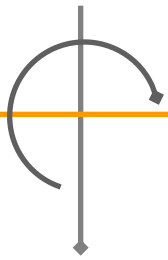

2º Ciclo.

- Plano y espacio proyectivo.

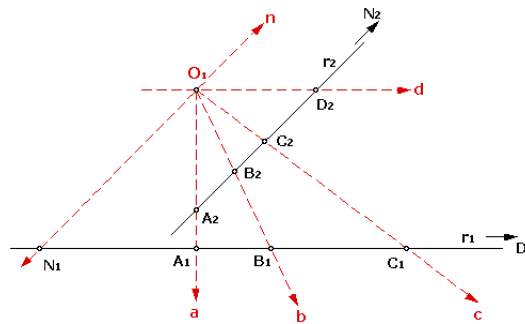

- Transformaciones Proyectivas de 1º Categoría.

- Alineación y Haces.

- Concepto Homología

- Definición de Cónicas.

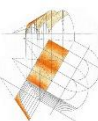
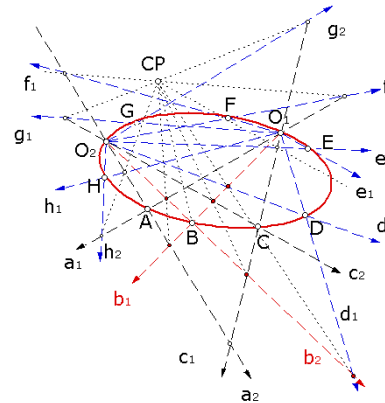
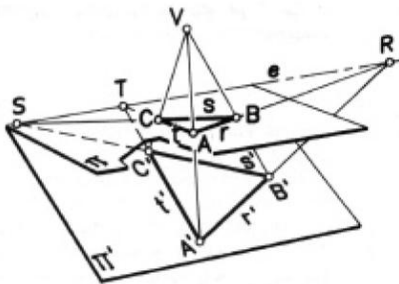

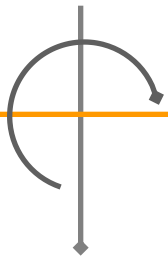

3º Ciclo.

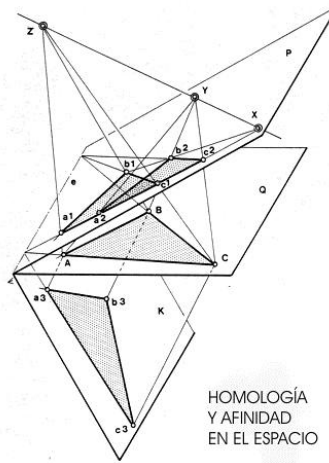
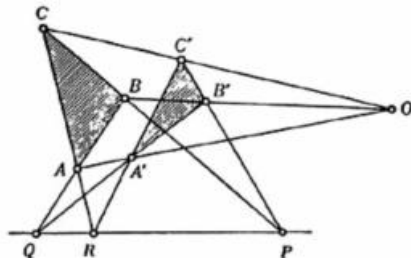

- Transformaciones Proyectivas de 2º Categoría.
- Teorema de Desargues.
- Definición Espacial de Homología
- Homología en su caso general.
- Homología de transformaciones Euclidianas.

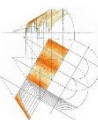
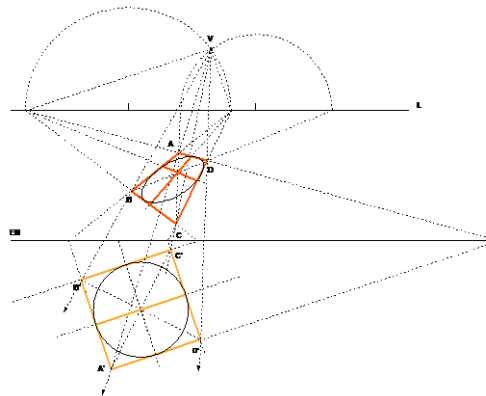
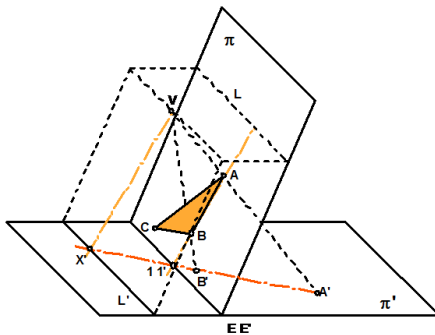

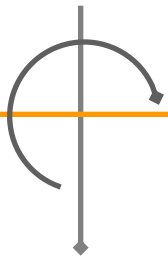

3º Ciclo.

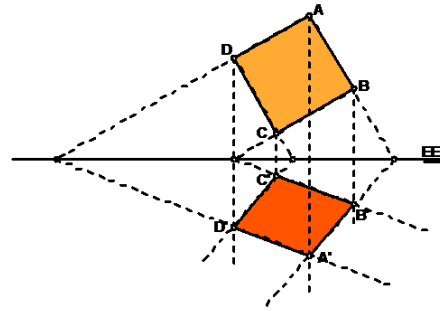
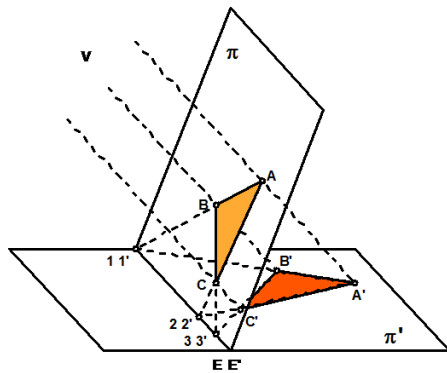

- Homología Afín.
- Homología Afín Recta
- Homología Afín Oblicua.
- Homología Afín Simétrica.

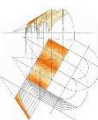
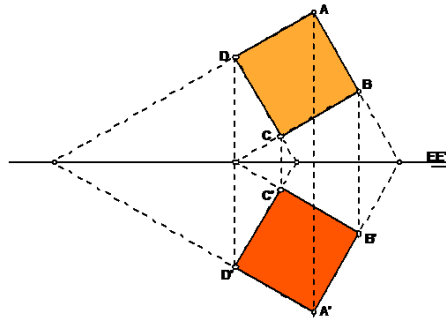
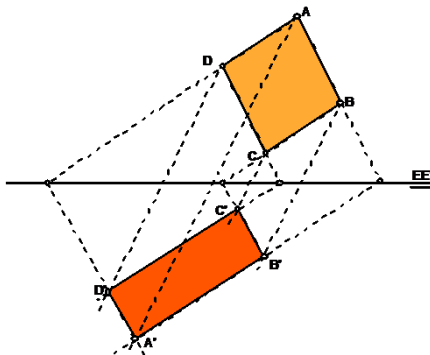

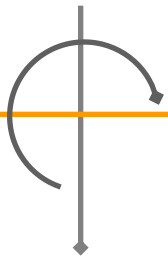

3º Ciclo.

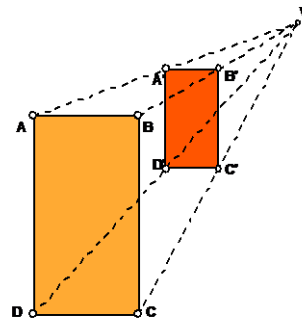
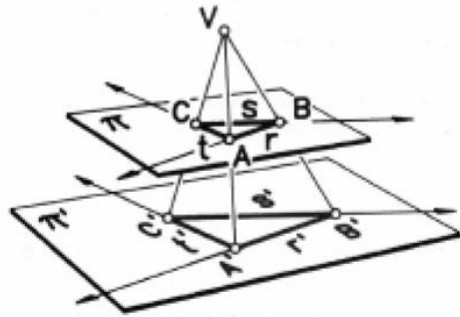

• Casos Particulares de Homologías.

• Homotecia.

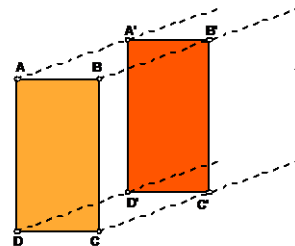
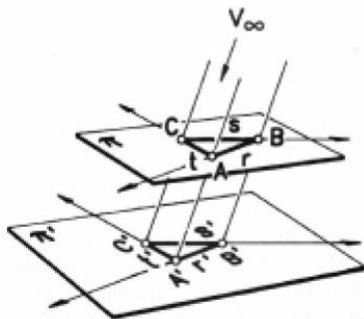

• Homotecia Paralela.

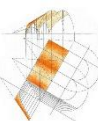

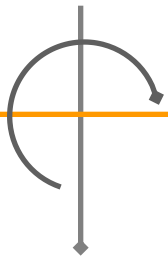

4º Ciclo.

- Transformación homológicas de formas tridimensionales en formas bidimensionales.

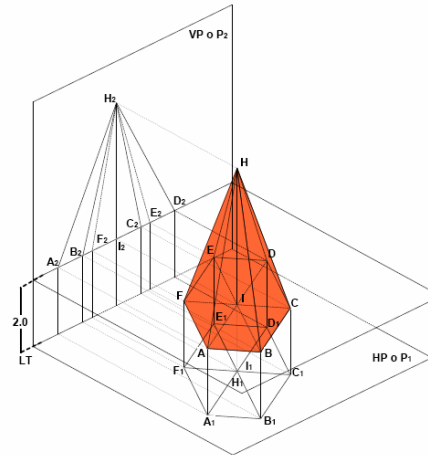



5º Ciclo.

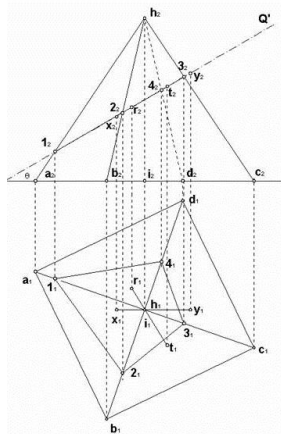
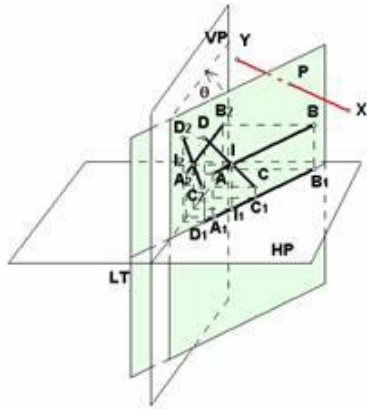

- Proyección Afín Ortogonal.
- Penetración de rectas en planos.
- Secciones Planas.
- Verdaderas Magnitudes.
- Intersección de Volúmenes

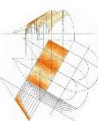
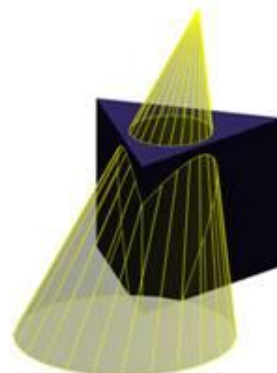
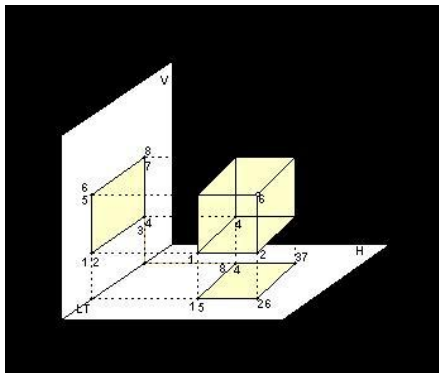

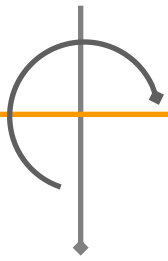

6º Ciclo.

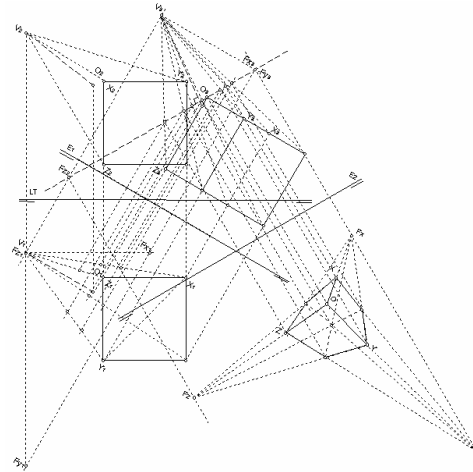
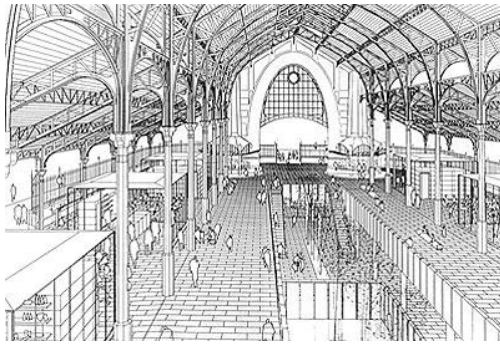

- Perspectiva.
- En su caso General.
- Perspectivas Particulares.

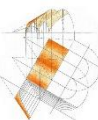
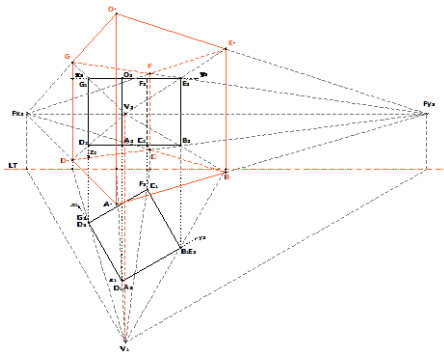

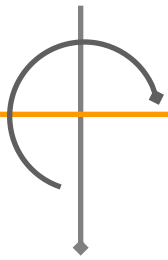

METODOLOGIA.

- CLASES EXPOSITIVAS: Trabajos individuales y grupales.
- CLASES PRÁCTICAS, con apoyo instrumental y computacional (Taller).

EVALUACIÓN.

1º SEMESTRE	%	FECHA	2º SEMESTRE	%	FECHA	EJERCICIOS/TAREAS	%
CONTROL N° 1	15	29/06/12	CONTROL N° 3	15	11/09/12	1º SEMESTRE	10
CONTROL N° 2	15	24/07/12	CONTROL N° 4	15	23/10/12	2º SEMESTRE	10
			CONTROL N° 5	20	04/12/12		
Total Controles	30%			50%		Total Ejercicios	20 %

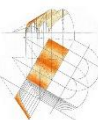

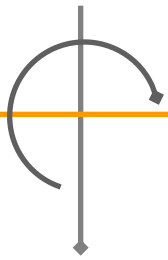

BIBLIOGRAFIA.

NOMBRE	AUTOR	EDITORIAL
Apuntes de Geometría	Marcelo Valenzuela V	Imprenta FAU.
Geometría Superior y Aplicada	Fernando Izquierdo Añenzi	Dossat
Geometría Descriptiva	Fernando Izquierdo Añenzi	Dossat
Dibujo Técnico	Gutiérrez Añenzi/Navarro Plascencia	Anaya
La composición Aurea en las Artes Plásticas	Pablo Tosto	Buenos Aires
Lecciones de Algebra y Geometría	C. Alsina y Trillas	Gustavo Gili.
Geometría Descriptiva	Mirror C. Hawk	McGraw Hill
Geometría Descriptiva y Aplicada	Kathryn Holliday Darr	I. Thomson Editores

