

SPECIFICATIONS &
APPLICATION HANDBOOK
Edition 31

April 2013



Please note that the performance information included in this book is for estimation purposes only. It is based on information that Komatsu Ltd. has but actual figures will vary with the operating conditions, including material characteristics, site conditions, operator efficiency, etc. Neither Komatsu Ltd. nor its dealers will guarantee that the machines will perform as estimated.

Materials and specifications are subject to change without notice.

© 2013 Komatsu
All Rights Reserved
Printed in Japan

KOMATSU

CONTENTS

INDEX

GENERAL	INFORMATION INDEX TABLE PREFACE THE KOMATSU PRODUCT LINE	
1 CRAWLER TYPE TRACTORS	1A CRAWLER-TYPE TRACTORS 1B BULLDOZERS 1C RIPPERS	1D TOWING WINCHES 1E PIPELAYERS 1F TRIMMING DOZERS
2 EXCAVATORS	2A EXCAVATORS (BACKHOE) 2B LIFTING CAPACITY 2C ATTACHMENTS 2D LOADING SHOVELS 2E WHEEL-TYPE EXCAVATORS	2F DEMOLITION 2G SCRAP & MATERIAL HANDLING 2H SPECIAL APPLICATION MACHINES
3 WHEEL LOADERS	3A WHEEL LOADERS 3B WHEEL DOZERS	
4 DUMP TRUCKS	4A RIGID DUMP TRUCKS 4B ARTICULATED DUMP TRUCKS	
5 ROAD MAINTENANCE EQUIPMENT	5 MOTOR GRADERS	
6 BACKHOE LOADERS	6 BACKHOE LOADERS	
7 COMPACT LOADERS	7A SKID STEER LOADERS 7B COMPACT TRACK LOADERS	
8 MOBILE CRUSHERS & RECYCLERS	8A MOBILE CRUSHERS & RECYCLERS	8B MOBILE SOIL RECYCLERS
9 FOREST MACHINES	9 FOREST MACHINES 9A HARVESTERS 9B FORWARDERS	9C TRACKED FELLER BUNCHERS & HARVESTERS 9D HARVESTER HEADS
10 GENERATOR SETS	10 GENERATOR SETS	
11 ENGINES	11 ENGINES	
12 TIRES	12 TIRES	
13 RECOMMENDATION	13A FOR SEVERE ENVIRONMENTS 13B FOR MINING	
14 PRODUCTIVITY	14A PRODUCTIVITY 14B EARTHMOVING DATA	
15 OWNING & OPERATING COSTS	15 OWNING & OPERATING COSTS	
16 UNIT CONVERSION TABLES	16 UNIT CONVERSION TABLES	
INDEX	INDEX	

More precise index is shown under each section.

From here go to appropriate sub-section index page

Product Sections	Major products					
Area of Information	Crawler Tractor	Hydraulic Excavator	Wheel Loader	Dump Truck	Motor Grader	Backhoe Loader
Features (description)	1A-2	2A-2	3A-2	4A-2	5-2	6-2
Specifications	1A-9	2A-12	3A-16	4A-5	5-4	6-3
Dimensions (shipping etc.)	1A-9, 1B-7	2A-35	3A-27	4A-9	5-6	6-4
Working Range	—	2A-49	3A-27	—	—	—
Travel Performance	1A-18	—	3A-134	4A-13	—	—
Component Dimensions	—	2A-60	—	—	—	—
Bucket (and Arm) Selection	—	2A-95	3A-156	—	—	—
Undercarriage-Shoes/Tires	1A-27	2A-80	3A-187	4A-44	—	—
Ground Pressure	1A-23	2A-85	—	—	—	—
Spec. Definitions	—	2A-94	3A-141	—	—	—
Teeth Selection	—	2A-112	—	—	—	—
Model Selection	—	2A-119	—	—	—	—
Attachments	1B (Bulldozer)	2C	3A-175 (Log att.)	4A-40	5-7, 5-13	—
	1C (Ripper)					
	1D (Winch)					
Loader-truck Combination	—	—	3A-190	—	—	—
Production	1B-27 (Bulldozer)	2A-128 (Backhoe)	3A-195	—	—	—
	1C-13 (Ripper)	2D-26 (L/Shovel)	—	—	—	—
Lifting Capacity	—	2B, 2E	—	—	—	—
Related Products (by model designation)	1E (Pipelayer)	2D (L/Shovel)	3B (WD)	4B (HM) (HM: Articulated Dump Truck)	—	—
	1F (Trimming)	2E (PW)	—	—	—	—
	—	—	—	—	—	—

Product Sections	Major products				
Area of Information	Skid Steer Loader	Mobile Crusher	Forest Machine	Generator	Engine
Benefits	—	8A-2	—	—	—
Features (description)	7A-2	8A-3	9A-2	10-2	11-2
Model and Application	—	8A-5	—	—	—
Specifications	7A-3	8A-6	9A-3	10-3	11-5
Dimensions (shipping etc.)	7A-4	8A-7	9A-4	—	—
Working Range	—	—	—	—	—
Travel Performance	—	—	—	—	—
Component Dimensions	—	—	—	—	—
Bucket (and Arm) Selection	—	—	—	—	—
Undercarriage-Shoes/Tires	—	—	—	—	—
Ground Pressure	—	—	—	—	—
Spec. Definitions	—	—	—	—	—
Attachments	—	—	—	—	—
Loader-truck Combination	—	—	—	—	—
Production	—	—	—	—	—
Lifting Capacity	—	—	—	—	—
Load Charts	—	—	—	—	—
Related Products (by model designation)	7B (CK) (CK: Compact Track Loader)	8B (BM: Mobile Soil Recycler)	9B (Forwarder)	—	—
	—	—	9C (Tracked Feller Buncher)	—	—
	—	—	9D (Harvester Head)	—	—
Engine used in KOMATSU Machines by Engine Model	—	—	—	—	11-6
High Altitude Deration	—	—	—	—	11-8

Only the first page of each section is shown in above table.

From here go to appropriate sub-section index page

Product Sections Area of Information	Application Information			
	Demolition	Trimming Dozer	Productivity	O & O Costs
Benefits	—	—	—	—
Features	—	1F-3	—	—
Model Selection	2F-2	1F-3	—	—
Model and Application	—	—	—	—
Specifications	2F-3	1F-7	—	—
Dimensions	—	—	—	—
Working Range	—	—	—	—
Undercarriage-Shoes/Tires	—	1F-6	—	15-23 Tire Life
Ground Pressure	—	—	—	—
Standard Equipment	—	1F-5	—	—
Attachment	2F-4	—	—	—
Production	—	—	14A Calc. Method	—
Related Products (by model designation)	—	—	—	—
	—	—	—	—
	—	—	—	—
	—	—	—	—
Construction Methods	2F-2	1F-2	—	—
Earthmoving Data	—	—	14B	—
Cost Calculations	—	—	—	15-6
Fuel Consumption	—	—	—	15-10
Lubricant Consumption	—	—	—	15-19
Conversion Charts	—	—	—	—
Recomendation	—	—	—	—

Only the first page of each section is shown in above table.

PREFACE

This handbook refers to machine specifications, productivity and owning & operation cost for construction equipment sold by Komatsu. It serves as a guide for the following cases:

- * Estimation of productivity for each machine
- * Estimation of owning & operating costs for each machine
- * Selection of machines for purchasing construction equipment
- * Selection of machines for performing construction job

The performance of a machine is determined by its production and operating costs. Important machine factors that influence production includes the horsepower, operating weight, capacity of work equipment, traveling speed and types of mechanical, hydraulic and electrical systems. They are referred to in the related section in the handbook. Some of the significant elements that comprise the operating cost factors are the consumption of fuel and lubricants, the service life of tires and undercarriage and the repair cost of components. These expenditures are discussed in the section entitled *Owning & Operating Costs*.

The data and tables in the handbook are based on Komatsu's bench and field tests, computer analysis and many years of experience. We continuously conduct tests to improve the reliability of the data. However, because of the complexity of factors influencing production costs and the deviations that may occur during the preparation of data, Komatsu does not guarantee that the data is exact and that the performance shown in the handbook is always obtainable with the given job conditions.

The basic performance data in the handbook are the values when machines are used at ideal efficiency. As performance varies with operator's skill, ground and weather conditions, etc., in reality, the basic data needs to be modified by using the various factors included in the handbook, resulting in different figures depending on the selection of these factors. Owning and operating cost also varies depending upon the machine usage, and the calculation result differs by what job condition and factors are applied for the calculation. Therefore, it should be understood that the calculated figures do not always completely match the actual measured data.

Nevertheless, handbook users will be able to make proper approximate calculations based on the data given in the handbook, their work experience and knowledge of local conditions.

This handbook is revised yearly. The data in the handbook is accurate at the time of printing; however, Komatsu may make changes in the specifications and materials without notice. Changes are made because of Komatsu's fundamental program of conducting continuous improvements on its products. Therefore, when you need the most updated information or specifications, obtain the latest catalogs through your distributor.

This handbook contains machine models produced in the various areas in the world. Specifications may vary depending upon production location; all models are not always available everywhere in the world.

The final objective for an owner of construction equipment is to perform the necessary construction job with the best efficiency and safety. It is desirable for an owner to understand the job efficiency factors and the machine use factors before utilizing this handbook.

They are as follows:

1. Job efficiency factors

1) Skill of operator

In order to obtain high productivity, the skill of the operator needs to match the performance of the machine. It is essential that the operator has the knowledge and skill to obtain high productivity from the machine.

Therefore, operators should be given education and training about machine operation, construction job operations and safety. The operator must read and understand the operator's manual. The operator must also read and understand the safety manual of the applicable manufacturers association in each area (AEM in USA, CECE in Europe, etc). The employer should assess the skill of each operator and assign the operator to an appropriate job. The operator should be given clear job instruction.

2) Selection of type of machine and specification

The contractor should select the kind, size and specification of machine that can obtain the optimum job efficiency. The contractor can use his past results and experience to select the most appropriate machine. If the contractor is uncertain about the proper machine selection, it is recommended that the contractor consult with the Komatsu distributor or the Komatsu application engineer. They have abundant information and experience and can provide valuable assistance in machine selection.

3) Selection of construction method

To attain the job objective, the contractor must select the proper method of construction or process. The contractor can choose the optimal method of construction and the optimal process by past actual result or experience. If the contractor is uncertain about the selection, it is recommended that the contractor consult a Komatsu application engineer. Komatsu has a program called OFR (Optimum Fleet Recommendation), which provides suitable recommendations for optimal method of construction and process.

4) Choice and use of attachments and optional parts

Care should be taken in the selection of attachments or optional parts since they affect work efficiency and safety. Typical attachments and optional parts are shown in this handbook. Komatsu has additional attachments and optional parts. You can consult with the distributor, salesman, or Komatsu application engineer for additional details.

5) Use of special application machine

This handbook includes relatively popular special application machines (modified machine for special application), but does not include every special application machine because of the limited number of pages. Komatsu will evaluate individual special application work which is not shown in this handbook and may create a special application machine to meet job requirements. You can consult with the distributor, salesman, or application engineer of Komatsu.

2. Machine use factors

1) Operator's protection from hazard

The employer has a duty to secure the safety of operators. They must not start work until they understand the machines to be used, method of construction and job site, and until they check and confirm that the operator is protected from all potential hazards.

- If an additional protection device is needed on the machine for operator protection, the Komatsu distributor should be consulted.
- The owner of a machine for the purpose of raising productivity and durability may want to modify a machine. In such a case, any modifications and attachment installations that may endanger the operator must not be carried out. For example, modifications that hinder an operator's field of view, hinder operation of a machine, hinder access to a machine or worsen the function of brake, steering and ROPS, stability of a machine, etc., must not be performed.

2) Protection from breakdown or lessening of machine life

In order to lower O&O cost, it is important to lengthen the economical life of a machine while reducing machine failure. Therefore, the owner of a machine needs to address the following items:

- Understand the method of construction and the condition of job site, and choose the type, size, and specification of machine that has ample strength for the job. Komatsu machines are equipped with the adequate strength and structure for typical work. However, when the machine is used in special applications, special strengthening and/or the addition of protection structures may be needed. In such a case, it is recommended that Komatsu should be consulted through the distributor. If the owner of the machine makes modification himself without consulting Komatsu, there are risks of generating problems in the performance, durability and safety of the machine.
- To increase production or durability, the owner of a machine may want to convert a main part of the machine or attachments himself, or may want to put attachments other than a Komatsu design which is procured locally, even if it is not a special application. In such a case, it is recommended that Komatsu be consulted through the distributor. Komatsu will propose through the distributor the proper means to respond to the request of a customer. If the owner of the machine makes modification himself without consulting Komatsu, there are risks of generating problems in the performance, durability and safety of the machine.

3) Prevention of fire

The owner and operator of a construction machine must follow the machine's maintenance guidelines and manage the job so that danger of fire will be minimized. A fire breaks out mainly by leakage of fuel, oil and grease; by electrical shorts caused from fatigue, loosening, or rubbing of electric parts and by ignition from engine high temperature parts contacting combustibles, such as plants and papers.

- The owner of a machine needs to maintain a machine by daily checks so that the causes described above do not exist.
- The operator must confirm by walk-around check before starting the machine that the above-mentioned hazards do not exist. If any problems are found, the machine must not be started until the problems are fixed.
- Equip a machine with a fire extinguisher in preparation for emergency.

4) Consideration of safety around the machine and environment.

Exercise care regarding safety, vibration, noise and flying debris (soil and stone) for the people who work around machines and for the surrounding area before putting a machine into a job site.

- Due to carelessness, the people working around the machine may suffer injury when the machine reverses, turns, and the attachment moves, etc. In order to prevent injuries, Komatsu can offer hazard alarm equipment and hazard detection equipment on its machines and the clothing of people working around the machine. The owner of the machine should evaluate whether the equipment on the machine are enough to cover the job site condition and should equip the machine and the people with additional equipment if needed.
- Komatsu sells machines that conform to the surrounding noise level regulation in the area sold. However, when it is necessary to have lower noise than a regulation level of the area, it is possible to reduce noise levels by modifying the machine. You are requested to consult Komatsu through its distributor.
- It is quite difficult to prevent the vibration of the land and flying debris by modification of the machine. Such problems should be solved by changing the work condition.

5) Compliance with regulations

Regulations pertaining to safety, noise, engine exhaust gas, etc. vary in different areas of the world. The owner of a machine has to recognize the regulations about the safety and environment legislated by each country and local government against construction machines, and has to use machines that conform to the applicable regulations. Although Komatsu supplies machines that conform to each regulation in the world, it is necessary to confirm through the Komatsu distributor if the machine conforms to all regulations in that area, before putting the machine to work.

Occasionally, a machine manufactured for another area in the world may be moved and relocated without Komatsu's knowledge. In this case, the machine may not have the specifications or structure to satisfy regulations of the area where the machine is located. In such a case, check in advance to determine if it conforms to the regulation of the area. If it does not conform, the owner must either make the necessary modifications to the machine to make it conform, or not operate the machine there.

6) Appropriate maintenance and management of a machine

The most important factor to maximize machine operation is performing maintenance and management of the machine correctly. It is essential to perform daily check & maintenance and periodic inspection & maintenance procedures shown in the operation manual of each machine.

● **BULLDOZERS**

Horsepower 32.4 to 858 kW (43.4 to 1150 HP)



D575A-3 SD



D575A-3



D475ASD-5E0



D475A-5E0



D375A-6 D375A-5
D375A-6R D375A-5R



D275A-5
D275AX-5E0
D275A-5R



D155A-5
D155A-6
D155AX-6
D155AX-7



D85EX-15E0
D85EX-15R



D85ESS-2
D85ESS-2A



D68ESS-12



D65E-12
D65EX-16
D65EX-17
D65WX-17



D63E-12



D61EX-15E0
D61EX-23



D51EX-22



D39EX-22
D39EX-23



D37EX-22
D37EX-23



D31EX-22



D21A-8E0

● **SWAMP BULLDOZERS**

Horsepower 32.4 to 168 kW (43.4 to 225 HP)



D85PX-15E0
D85PX-15R



D65P-12
D65PX-16
D65PX-17



D61PX-15E0
D61PX-23



D51PX-22



D39PX-22
D39PX-23



D37PX-22
D37PX-23



D31PX-22



D21P-8E0

● **PIPELAYERS**

Horsepower 168 to 269 kW (225 to 360 HP)



D355C-3



D155C-1



D85C-21

● HYDRAULIC EXCAVATORS (Back hoe)

Operating weight 890 to approx. 753,500 kg (1,960 to approx. 1,661,200 lb)

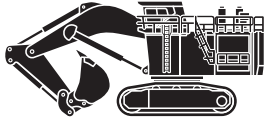

PC8000-6
PC8000E-6



PC5500-6
PC5500E-6

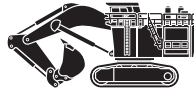

PC4000-6
PC4000E-6

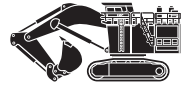

PC3000-6
PC3000E-6

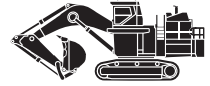

PC2000-8



PC1250-7, PC1250-8 (R)
PC1250LC-8



PC800-7, PC850-8E0 (R1)



PC750-7, PC800-8E0 (R1)
PC800LC-8E0 (R1)



PC700LC-8E0 (R)



PC600-7, PC600-8E0 (R1)
PC600LC-7, PC600LC-8E0 (R1)
PC650LC-8E0, PC600-8, PC600LC-8



PC550LC-8



PC450-7
PC450LC-7
PC450-8 (R)
PC450LC-8 (R)
PC490LC-10



PC400-7
PC400LC-7
PC400-8 (R)
PC400LC-8 (R)



PC360LC-10
PC360NLC-10
PC390LC-10



PC350-7
PC350LC-7
PC360-7
PC350-8
PC350LC-8



PC300-7
PC300LC-7
PC300-8
PC300LC-8



PC290LC-10
PC290NLC-10



PC270-7
PC270-8
PC270LC-8



PC240LC-8
PC240LC-10
PC240NLC-10



PC230NHD-8



PC220-7
PC220LC-7
PC220-8
PC220LC-8



PC220-8M0
PC220LC-8M0



HB205-1
HB215LC-1



PC210-8
PC210LC-8
PC210NLC-8
PC210-10
PC210LC-10



PC200-7, PC200-8
PC200LC-7, PC200LC-8
PC200-8M0, PC200LC-8M0



PC190LC-8
PC190NLC-8



PC160LC-8
PC160LC-7



PC130-7
PC130-8
PC130F-7



PC110-7



PC118MR-8



PC60-8
PC70-8
PC71-7



PC45MR-3
PC55MR-3



PC35MR-3
PC30MR-3
PC27MR-3



PC18MR-3
PC20MR-3
PC22MR-3
PC26MR-3



PC14R-3
PC16R-3



PC09-1



PC228US-8
PC228USLC-8



PC138US-8
PC138US-10
PC138USLC-10



PC88MR-8
PC80MR-3



PC78US-8

● HYDRAULIC EXCAVATORS (Loading shovel)

Operating weight 43,100 to approx. 743,200 kg (95,020 to approx. 1,638,500 lb)

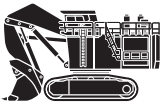

PC8000-6
PC8000E-6

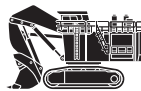

PC5500-6
PC5500E-6



PC4000-6
PC4000E-6



PC3000-6
PC3000E-6



PC2000-8



PC1250-7
PC1250-8 (R)



PC750-7
PC800-8E0 (R1)



PC600-7, PC600-8E0 (R1)
PC600LC-7, PC600LC-8E0 (R1)



PC400-7
PC400LC-7
PC400-8 (R)
PC400LC-8 (R)

● HYDRAULIC EXCAVATORS (Wheel type)

Operating weight 10,300 to 22,390 kg (22,710 to 49,360 lb)



PW220-7



PW200-7



PW180-7



PW160-8



PW148-8



PW118MR-8



PW98MR-8

● **WHEEL LOADERS**

Bucket capacity 0.6 to 20 m³ (0.8 to 26.2 yd³)
(C) indicates custom series.

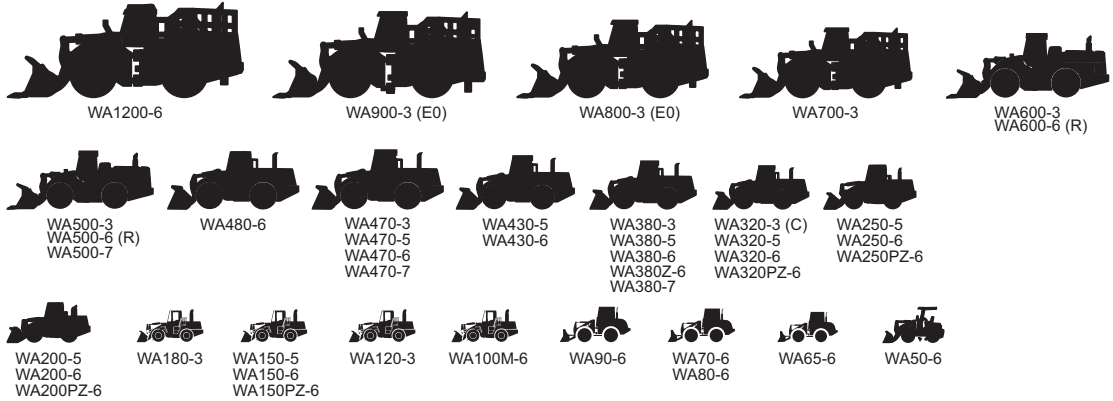

● **WHEEL DOZERS**

Horsepower 362 to 637 kW (485 to 853 HP)

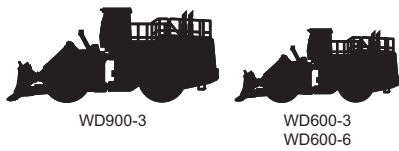

● **SKID STEER LOADERS**

Bucket capacity 0.23 to 0.40 m³ (0.30 to 0.52 yd³)



● **COMPACT TRACK LOADERS**

Bucket capacity 0.4 m³ (0.52 yd³)

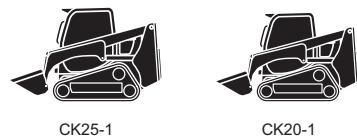

● **BACKHOE LOADERS**

Bucket capacity 1.03 to 1.10 m³ (1.35 to 1.43 yd³)

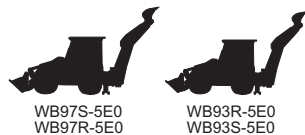

● **RIGID DUMP TRUCKS**

Hauling capacity 25 to 327 ton (28 to 360 US ton)

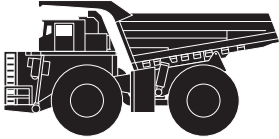

960E-2
960E-2K

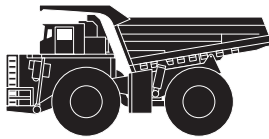

930E-4
930E-4SE



860E-1K



830E-AC



730E



HD1500-7



HD785-7



HD605-7E0
HD605-7R



HD465-7 (E0)
HD465-7R



HD405-6
HD405-7
HD405-7R



HD325-6
HD325-7
HD325-7R



HD255-5

● **ARTICULATED DUMP TRUCKS**

Hauling capacity 27.3 to 40 ton (30.1 to 44.1 US ton)



HM400-1
HM400-2
HM400-2R
HM400-3



HM350-1
HM350-2
HM350-2R



HM300-1
HM300-2
HM300-2R
HM300-3

● **MOTOR GRADERS**

Horsepower 101 to 209 kW (135 to 280 HP)



GD825A-2



GD755-5R



GD705A-4



GD675-5



GD663A-2



GD655-5



GD555-3
GD555-5



GD511A-1

● **HARVESTERS**

Horsepower 150 to 210 kW (204 to 285 HP)



941.1



931.1



911.5



901TX.1

● **FORWARDERS**

Max. permissible load 9 to 18 ton (9.9 to 19.8 U.S. ton)



890.3



865



855



840TX



830.3

● **TRACKED FELLER BUNCHERS**

Operating weight 27,290 to 31,520 kg (60,165 to 69,490 lb)



XT450L-2



XT445L-2



XT430-2
XT430L-2

● **MOBILE CRUSHER & RECYCLERS**

Horsepower 54 to 345 HP (40.5 to 257 kW)



BR580JG-1



BR380JG-1E0



BR100JG-2



BZ210-1

● **DIESEL GENERATOR SETS**

Rated output 41 to 1,000 kVA (33 to 800 kW)



EGS1200BS-6
EGS1200BS-6C
EGS1200BS-6CT
EGS1200-6



EGS1050BS-7
EGS1050-7



EGS1000BS-7
EGS1000-7



EGS850BS-6
EGS850BS-6C
EGS850-6



EGS760BS-6
EGS760-6



EGS630BS-6
EGS630-6



EGS500BS-6
EGS500-6



EGS380BS-6
EGS380-6



EGS360BS-6
EGS360-6



EGS300BS-6
EGS300-6



EGS240BS-6
EGS240-6



EGS160BS-7
EGS160-7



EGS120BS-6
EGS120-6



EGS65BS-6
EGS65-6



EGS45BS-6
EGS45-6

● **ENGINES**

Piston displacement 3.26 to 46.3 ltr (199 to 2825 cu in)



SA12V170E



SA12V140
SDA12V140



SA6D170E
SAA6D170E



S6D140E
SA6D140E
SAA6D140E



6D125E
S6D125E
SA6D125E
SAA6D125E



S6D114E
SA6D114E
SAA6D114E



S6D108E
SA6D108E
SAA6D108E



SAA4D107E
SAA6D107E



6D102E
S6D102E
SA6D102E
SAA6D102E



4D102E
S4D102E
SA4D102E
SAA4D102E



SAA6D95LE



4D95LE
S4D95LE
SAA4D95LE

CONTENTS

INDEX

SECTION

1

CRAWLER-TYPE TRACTORS Sec 1A

BULLDOZERS Sec 1B

RIPPERS Sec 1C

TOWING WINCHES Sec 1D

PIPELAYERS Sec 1E

TRIMMING DOZERS Sec 1F

CRAWLER-TYPE TRACTORS

CONTENTS

Features 1A-2

Specifications 1A-9

Specifications
(Low Ground Pressure Tractors) 1A-15

Drawbar Pull vs. Travel Speed 1A-18

Ground Pressure 1A-23

Shoe Application 1A-26

Shoe Selection 1A-27

Roller Guard Installation 1A-29

Upper Attachment 1A-31

■ Ecology features

● EPA Tier 4 Interim and EU Stage 3B emissions certified engine

(For details, see the page of engine features (Section 11))

● ecot 3 (EPA Tier 3, EU Stage 3A certified engine)

Komatsu develops and produces all major components, such as engines, electronics and hydraulic components in house.

With this “Komatsu Technology”, and adding customer feedback, Komatsu is achieving great advancements in technology.

To achieve high levels of productivity and ecology, Komatsu developed the main components with an advanced control system.

The result is a new generation of high performance and environment friendly machines.

● Fuel efficient electronic controlled engine

The engine is EPA Tier 3 and EU Stage 3A emission regulation certified. The engine is turbocharged and features Common Rail Injection system (CRI) and air-to-air aftercooling to maximize power, fuel efficiency and emission compliance.

To minimize noise and vibration, the engine is mounted to the main frame with rubber cushions.

● Hydraulic drive radiator cooling fan

The engine cooling fan rotation speed is electronically controlled. The fan rotation speed depends on engine coolant and hydraulic oil temperatures, the higher the temperature the higher the fan speed. This system increases fuel efficiency, reduces the operating noise levels and requires less horsepower than belt driven fan.

(D61-15E0, D65-16, D85-15E0, D155AX-6, D275AX-5E0, D375A-6)

■ ECO assistance

● ECO guidance

In order to support to optimum operation, the following 5 guidance is displayed for fuel saving operation

- 1) Avoid Excessive Engine Idling
- 2) Use Economy Mode to Save Fuel
- 3) Avoid Hydraulic Relief Pressure
- 4) Avoid Over Load
- 5) Use Automatic Shift Mode

● ECO gauge

In order to help the operator to perform in an environmentally friendly way and minimize energy consumption, an easy-to-read “ECO gauge” is displayed on the right of the multi-monitor screen.

● Fuel Consumption Display

Average fuel consumption during the day is displayed and updated every 10 seconds.
(D37-23, D39-23, D61-23, D65-17, D155AX-7)

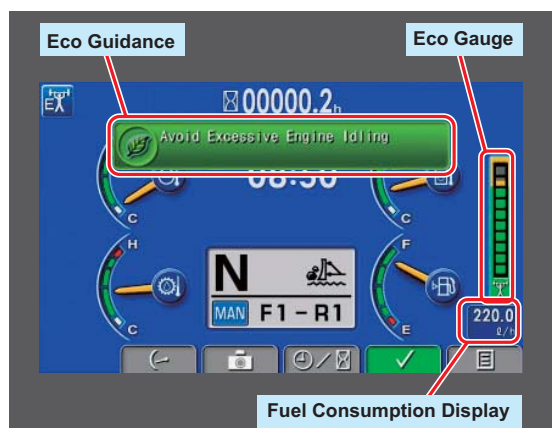

■ **High productivity**

The high-power engine, highly efficient power train, large drawbar pull provided by the conventional undercarriage, and the high performance work equipment provide high productivity.

● **Large capacity blade**

Large capacity blade, powerful digging force, large up-and-down movement of the blade, and high strength provided by high tensile steel.

● **Uniquely designed ripper**

The unique linkage design enables the ripper point to draw an ideal locus during cylinder tilting for effective excavation of embedded rocks.

● **Automatic lock-up torque converter**

When the lock-up clutch is engaged, the pump and the turbine are virtually connected and the internal power loss of the torque converter is minimized. (D65-17, D155AX, D275AX, D375A and D475A)

● **Resilient Equalized Undercarriage (REU)**

This highly advanced undercarriage system utilizes an X-shape bogie structure with an independent see-saw movement for the track rollers. This allows the shoes to always follow the contour of the ground for excellent traction. The bogies contact the track frame through rubber shock absorber reduces vibration and shock. (D155A-5, D155AX-5 and D575A)

● **SIGMADOZER**

Based on a completely new digging theory, SIGMADOZER dramatically improves dozing performance and increases productivity. A new frontal design concept adopted for digging and rolling up at the center of the blade increases soil holding capacity, simultaneously reducing sideways spillage. Reduced digging resistance produces smoother flow of earth, enabling the dozing of larger quantities of soil with less power. (D65-17, D155AX-7)

● **Automatic gearshift mode**

The mode for general dozing. When a load is applied, the gear automatically shifts down, and when the load is off, it automatically shifts up to a set maximum gear speed. This mode economizes both fuel and production where the torque converter lockup mechanism is actuated according to load, automatically selecting the optimum gear speed. (D65-17, D155AX-7)

● **Power Angle Tilt (PAT) dozer with adjustable pitch**

A power angle tilt dozer blade with adjustable blade pitch system is available. This dozer is available for the EX and PX machines.

The hydraulic blade tilt and angling function expands versatility and productivity in a variety of applications. The manually adjustable blade pitch further expands the versatility and productivity. (D21, D31, D37, D39, D51, D61)

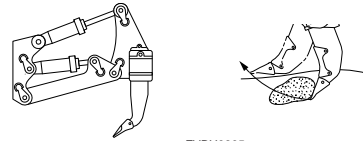
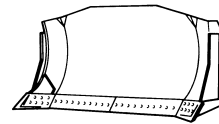

FVBH0305

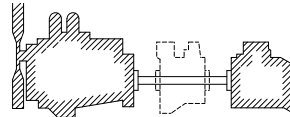

Lockup "ON"

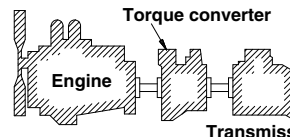

Lockup "OFF"

Transmission

FKD00444

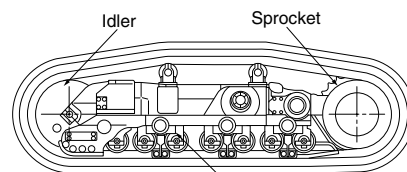

X-bogie system

FZD00685



SIGMADOZER (D155AX-7)

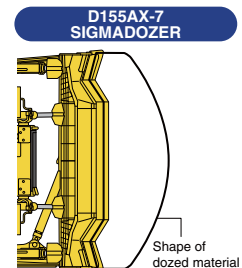

Shape of dozed material

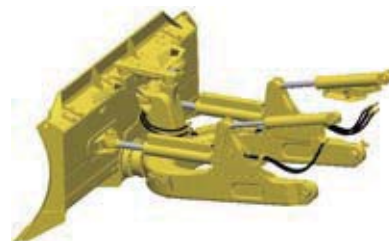

■ Dependable and high-performance components

- Komatsu's diesel engine delivers a strong horsepower and has a direct-injection system for fuel savings and cleaner exhaust.
- The TORQFLOW transmission not only ensures smooth and responsive power shifting, but also makes instant speed and directional changes by a single lever.
- The HYDROSHIFT transmission ensures not only efficient power transmitting ability for reduced fuel costs, but also a single-lever speed control and F/R directional changes for easy operation. (D21)
- Wet, multiple-disc type steering clutches and brakes ensure long service life and eliminate troublesome brake-lining adjustments. (D65 over)
- Double reduction final drives feature a large reduction ratio and minimize shocks to the power train components and extend the life of components.
[Except D21]
- Lubricated track links: Since the clearance between the link pin and bushing is lubricated, wear and pitch extensions are minimized for extended service life.
- Unique dust seals prevent dust from entering into pin-to-bushing clearance for extended service.
- Floating seals in the idlers and rollers keep dirt out and lubricant in for durable operation.
- Reduction of man-hours for turning over the bushings by employment of wedge ring. (Large Class)
- Strengthening of undercarriage by increase of press fitting width of pin. (Small-middle Class)
The most important matters for the undercarriage of a bulldozer are holding of the oil filled in the links and easiness of turning over the bushings. KOMATSU increased the rigidity and abrasion life of the links and lowered the press fitting force of the pins to reduce scuffing when the links are disassembled. As a result, the bushings are turned over extremely easily.
It's the link, the repair cost of the undercarriage of a bulldozer is the highest of all. You can reduce the repair cost with the turning over the bushings drastically.

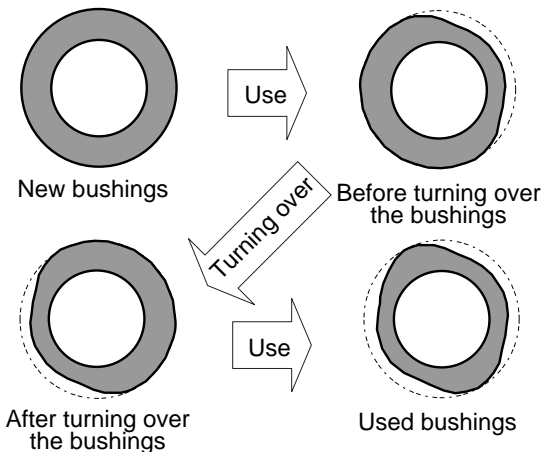
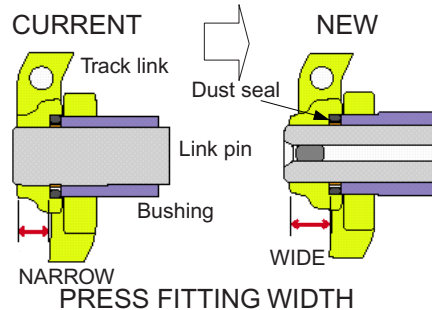
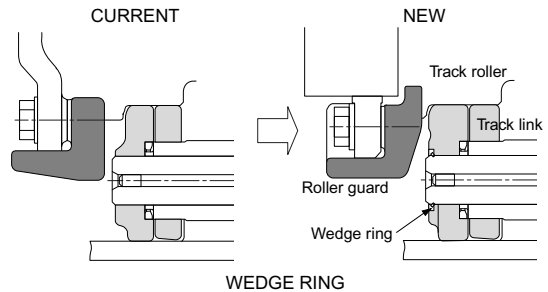
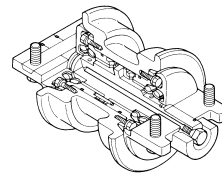
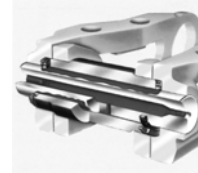
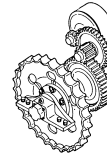
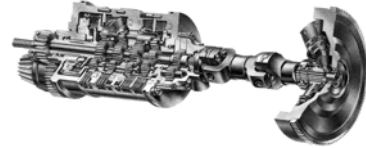
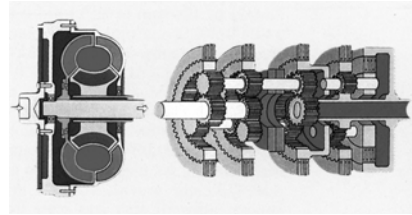

• **Parallel Link Undercarriage System (PLUS)**

Komatsu's new Parallel Link Undercarriage System (PLUS) provides less downtime plus longer wear with up to 40% lower undercarriage maintenance costs. Rotating bushings eliminate the cost and downtime for bushing turns, and strengthened rollers and links increase wear life up to two times. With PLUS, individual links can be replaced with common track tools. (D37/D39-23, D61-23, D65-17 (OPT))

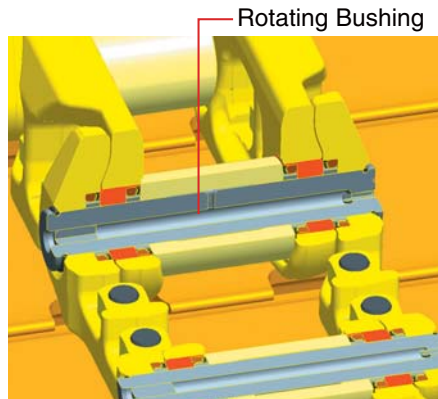

• **Modular design**

The sealed, modular design allows the power-train components to be mounted / dismantled without any oil spillage, making servicing work clean, smooth and easy.

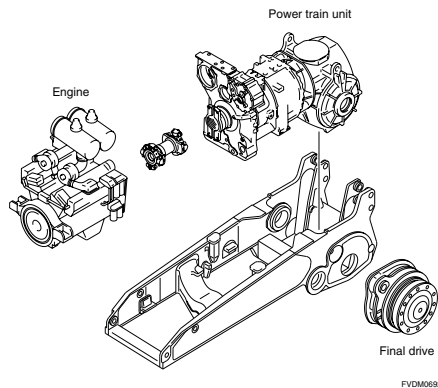

■ **Easy operation / operator comfort**

- Operator-oriented arrangement of control levers, pedals, instruments and operator seat.
- Walk-through operator compartment provides easy boarding and exiting.
- Operator seat can be adjusted to provide the most suitable operating posture.
- Steering clutches and brakes are interconnected for easy operation.
- Low profile design assures excellent machine balance and a low center of gravity, making machine dynamically stable and controllable, accounting for operator confidence and comfort.
- Oscillating type equalizer bar suspension absorbs vibrations and shocks for high mobility and comfortable ride even on rugged terrain. [Except D21, D31, D37 and D39]

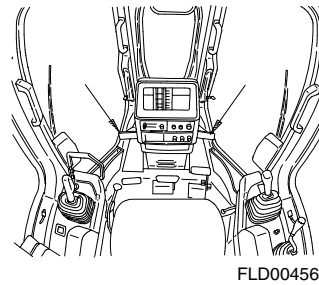

• **Wrist-control-type single lever for steering/directional and speed change**

All speed and directional changes, 1st to 3rd forward and reverse, and right-and left-hand steering are controlled with just a joystick single-lever on the left. (D21, D65 and D155A-5/D155AX)

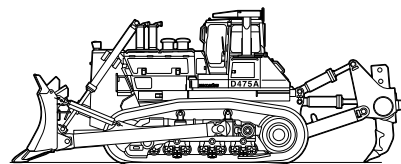

• **Blade control joystick**

Blade lift, angle and tilt operations are instantly accomplished with a joystick right single-lever. The introduction of this left and right "joystick" system permits simultaneous traveling and working, offering both ease and a shorter cycle time. (D21)

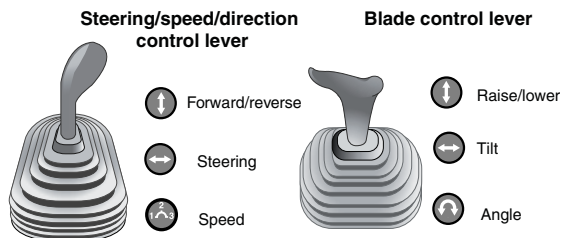

• **Hydrostatic Steering System (HSS)**

Engine power is ideally distributed to the left and right tracks in portion to lever movement each time the machine makes a turn; the outside track moves faster and the inside slower, providing a smooth and powerful turn. (D31/D37/D39-D51, D61, D65EX/PX, D85EX/PX, D155AX and D275AX)

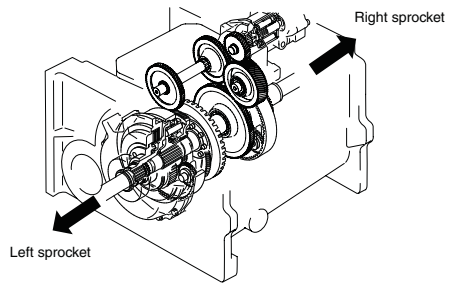

• **Palm Command Control System**

Palm Command Control System (PCCS) joystick controls for all directional movements. Pushing the joystick forward results in forward machine travel, while pulling it rearward reverses the machine.

Simply tilt the joystick to the left to make a left turn. Tilt it to the right for a right turn.

The travel speed is selected by pressing the shift button on the palm lever.

[Except D21 and D68]

PCCS travel control lever



- ⬆ Forward and reverse
- ↔ Right and left steering
- ⊙ First, to second, to third shifting

PCCS blade control lever



- ⬆ Lifting and lowering
- ↔ Tilting
- ⤵ Left and right angling

FVBH0229

• **Electronic controlled hydraulic system**

Electronic controlled palm commanded joystick provides precise blade control, by assistance of controller. New blade angling switch operation provides easier and predictable blade control.



• **New large multi-lingual LCD color monitor**

A large user-friendly color monitor enables safe, accurate and smooth work. Excellent screen visibility is achieved by use of TFT liquid crystal display that can easily be read at various angles and lighting conditions. Simple and easy to operate switches. Plus function keys facilitate multi-function operations.

Displays data in 25 languages to globally support operators around the world.

(D37, D39EX/PX-23, D61EX/PX-23, D65EX/PX/WX-17, D155AX-7)



• **Rear view monitoring system**

On the large LCD color monitor, the operator can view, through one camera, areas directly behind the machine. This camera can be synchronized with reverse operation. This system is to be used as an auxiliary device, and areas behind you should be checked with your own eyes.

(D37, D39EX/PX-23, D61EX/PX-23, D65EX/PX/WX-17, D155AX-7)

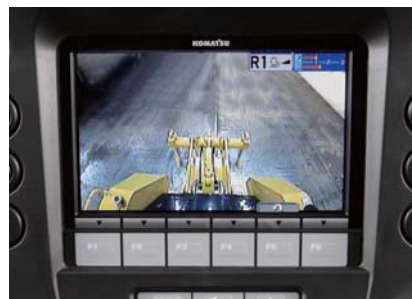

■ **Easy maintenance**

- Bolt-on type sprocket or segmented sprocket teeth for easy in- field replacement. [Except D21]
- Simple maintenance is promoted through adoption of spin-on type fuel and full-flow filters, an air cleaner with an automatic dust evacuator, and others.

• **Maintenance-free, wet, multiple-disc brakes**

To ensure long life and dependability maintenance-free, wet, multiple-disc brakes are utilized. (D61 over)

• **Centralized oil pressure inspection ports**

Oil pressure check ports are centralized on the left side of the chassis to make it easier to carry out inspection and maintenance.

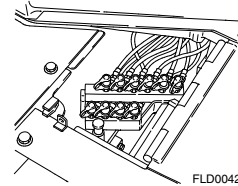
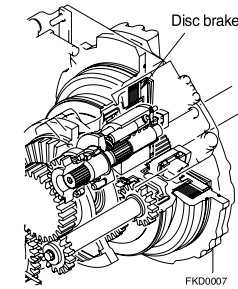

■ **KomStat hydrostatic transmission**

• **3-speed HST**

The D31/D37/D39/D51/D61 are equipped with Komatsu's exclusive KomStat Hydrostatic Transmission (HST) consists of dual-path and closed-circuit with two variable displacement piston pumps and two 3-speed variable capacity travel motors. The 3-speed variable capacity travel motors allow the operator to select the optimum speed to match specific jobs.

• **Automatic shift between 1st and 2nd speeds**

KomStat shifts automatically between 1st and 2nd speed depending on load or ground conditions to facilitate efficient operation.

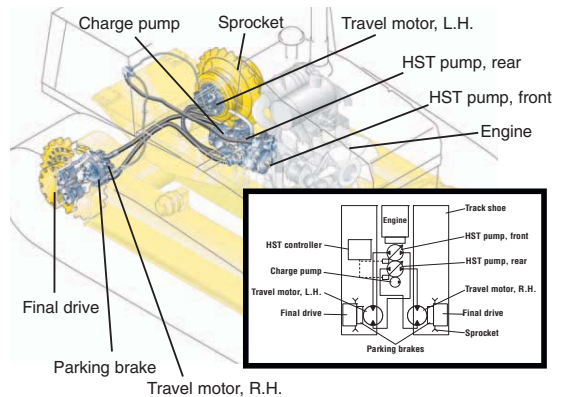

■ **KOMTRAX**

• **Ecological operation report for assistance**

KOMTRAX is Komatsu's remote equipment and fleet monitoring system. Wireless technology and a secure Webbased application gives you the information you need to make the best possible operation and management decisions, from location, actual hour worked, and fuel consumption to maintenance monitoring, abnormality codes, and load frequency, in simple to read and understand reports.

- Guidance to improve fuel consumption
- Ecological operation report.
- Report operation hours by operation mode(E or P mode)
- Service information for Tier 4 Interim (Regeneration, diagnostics information)

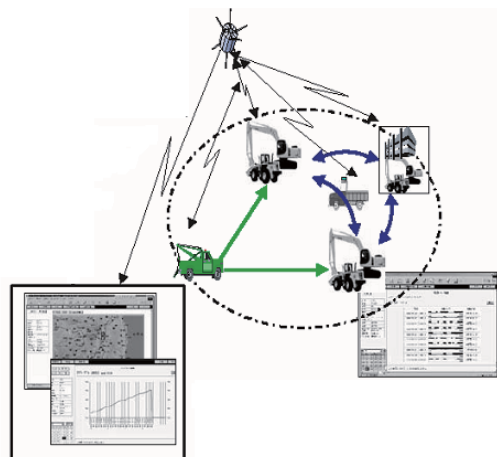

- **HST dynamic brakes**

KomStat uses HST dynamic brakes to ensure safe operation.

Parking brake is wet, multiple-disc type with a unique drag-prevention control to keep hydraulic oil clean.

(D31, D37 and D39)

- **K-Bogie undercarriage system (7-roller)**

K-Bogie undercarriage system retains prior advantages, with new additional features.

Features on K-Bogie Undercarriage System:

- K-bogies oscillate with two fulcrums, and track roller vertical travel is greatly increased. Impact loading on all undercarriage components has been reduced and durability of components is improved since track rollers are always in contact with tack link.
- Undercarriage life is improved due to better control of track chain alignment with track rollers.
- Riding comfort is improved by reducing vibration and shock when traveling over rough terrain. (D155AX-6, D155AX-7, D275A and D275AX)

- **K-Bogie undercarriage system (8-roller, oscillating idler)**

Features on new K-Bogie undercarriage system:

- New K-Bogies with front and rear single bogies are utilized providing increased length of track on ground to improve machine stability.
- The oscillating idler and increased sprocket lead angle improve riding comfort when traveling over rough terrain. (D375A-6, D375A-6R, D475A-5E0 and D475ASD-5E0)

- **Auto-shift down function**

Controller monitors engine speed, travel gear and travel speed.

When load is applied and machine travel speed is reduced, the controller automatically downshifts to optimize gear speed to provide high fuel efficiency. This function provides comfortable operation and high productivity without manual downshifting. (This function can be deactivated with cancel switch).

(D275, D375A and D575A SD)

- **Preset travel speed selection function**

Preset travel speed selection function is standard equipment, enabling the operator to select fore and aft travel speed among three preset patterns, F1-R2, F2-R2 and manual shift. When F1-R2 or F2-R2 preset pattern is selected, and travel control joystick moves from forward to reverse direction, the machine travels forward/reverse with F1/R2 or F2/R2 speed automatically. This function reduces gear shifting time during repeated round trip operations.

(D275, D375A and D575A SD)

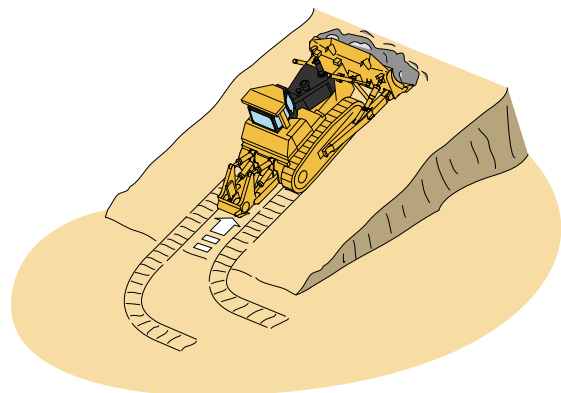
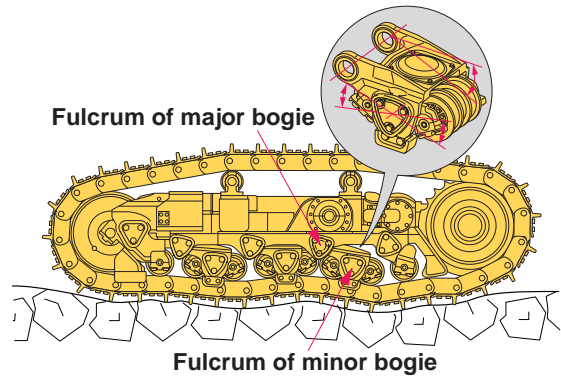

Specifications

CRAWLER-TYPE TRACTORS

Item	Model	D21A-8E0	•D31EX-22	•D31EX-22***	°D37EX-23
OPERATING WEIGHT*	kg (lb)	3710 (8,180)	7670 (16,910)	7670 (16,910)	8340 (18,390)
TRACTOR WEIGHT	kg (lb)	3160 (6,970)	6520 (14,370)	6520 (14,370)	7300 (16,090)
HORSEPOWER SAE J1995 Gross ISO9249/SAE J1349 Net Hyd. fan at max. speed Net	kW (HP)/RPM kW (HP)/RPM kW (HP)/RPM	32.4 (43.4)/2450	60 (80)/2200 58 (78)/2200 53 (71)/2200	60 (80)/2200 58 (78)/2200 53 (71)/2200	67.7 (90.7)/2200 66.1 (88.6)/2200 62.3 (83.5)/2200
PERFORMANCE:					
Travel speed Forward 1st	km/h (MPH)	2.6 (1.6)	3.4 (2.1)	0 to	3.4 (2.1)
2nd		4.4 (2.7)	5.6 (3.5)	8.5 (5.3)	5.6 (3.5)
3rd L/3rd		-	8.5 (5.3)	-	8.5 (5.3)
Reverse 1st		3.3 (2.1)	4.1 (2.5)	0 to	4.1 (2.5)
2nd		5.6 (3.5)	6.5 (4.0)	8.5 (5.3)	6.5 (4.0)
3rd L/3rd		-	8.5 (5.3)	-	8.5 (5.3)
Max. drawbar pull	kg (lb/kN)	4520 (9,970/44.3)	15300 (33,730/150)	15300 (33,730/150)	15300 (33,730/150)
DIMENSIONS:					
Overall length (tractor)*5	mm (ft.in)	2405 (7'11")	3220 (10'7")	3220 (10'7")	3270 (10'9")
Overall length*	mm (ft.in)	3250 (10'8")	4175 (13'8")	4175 (13'8")	4275 (14'0")
Overall width (w/o trunnion)	mm (ft.in)	1610 (5'3")	1910 (6'3")	1910 (6'3")	1970 (6'6")
Overall width (with blade)*	mm (ft.in)	2170 (7'1")	2550 (8'4")	2550 (8'4")	2710 (8'11")
Overall height (tractor)**	mm (ft.in)	1785 (5'10")	2760 (9'1")*6	2760 (9'1")*6	2775 (9'1")*6
Overall height*	mm (ft.in)	2135 (7'0")	2760 (9'1")	2760 (9'1")	2775 (9'1")
Track gauge	mm (ft.in)	1310 (4'4")	1510 (4'11")	1510 (4'11")	1570 (5'2")
Length of track on ground	mm (ft.in)	1685 (5'6")	2185 (7'2")	2185 (7'2")	2240 (7'4")
ENGINE:					
Model		KOMATSU 4D94LE-2	KOMATSU SAA4D95LE-5	KOMATSU SAA4D95LE-5	KOMATSU SAA4D95LE-6
No. of cylinders- bore × stroke	mm (in)	4-94 × 110 (3.70 × 4.33)	4-95 × 115 (3.74 × 4.53)	4-95 × 115 (3.74 × 4.53)	4-95 × 115 (3.74 × 4.53)
Piston displacement	ltr. (cu.in)	3.053 (186)	3.26 (199)	3.26 (199)	3.26 (199)
UNDERCARRIAGE:					
No. of rollers (carrier/track)		1/5	1/6	1/6	1/6
Width of standard shoe	mm (in)	300 (11.8)	400 (15.7)	400 (15.7)	400 (15.7)
FUEL TANK CAPACITY (Refilled):	ltr. (U.S.Gal)	60 (15.9)	195 (51.5)	195 (51.5)	
*) Spec conditions: Bulldozer Rear attachment Upper attachment		PAT - -	PAT - ROPS canopy	PAT - ROPS canopy	PAT - ROPS cab

Item	Model	°D37EX-23***	•D37EX-22	•D37EX-22***	°D39EX-23
OPERATING WEIGHT*	kg (lb)	8340 (18,390)	7890 (17,400)	7890 (17,400)	9270 (20,440)
TRACTOR WEIGHT	kg (lb)	7300 (16,090)	6710 (14,800)	6710 (14,800)	8160 (17,990)
HORSEPOWER SAE J1995 Gross ISO9249/SAE J1349 Net Hyd. fan at max. speed Net	kW (HP)/RPM kW (HP)/RPM kW (HP)/RPM	67.7 (90.7)/2200 66.1 (88.6)/2200 62.3 (83.5)/2200	68 (91)/2200 66 (89)/2200 59 (79)/2200	68 (91)/2200 66 (89)/2200 59 (79)/2200	80 (107)/2200 78.4 (105)/2200 72.9 (97.7)/2200
PERFORMANCE:					
Travel speed Forward 1st	km/h (MPH)	0 to	3.4 (2.1)	0 to	3.4 (2.1)
2nd		8.5 (5.3)	5.6 (3.5)	8.5 (5.3)	5.6 (3.5)
3rd L/3rd		-	8.5 (5.3)	-	8.5 (5.3)
Reverse 1st		0 to	4.1 (2.5)	0 to	4.1 (2.5)
2nd		8.5 (5.3)	6.5 (4.0)	8.5 (5.3)	6.5 (4.0)
3rd L/3rd		-	8.5 (5.3)	-	8.5 (5.3)
Max. drawbar pull	kg (lb/kN)	15300 (33,730/150)	15300 (33,730/150)	15300 (33,730/150)	14800 (32,630/145)
DIMENSIONS:					
Overall length (tractor)*5	mm (ft.in)	3270 (10'9")	3185 (10'5")	3185 (10'5")	3345 (11'0")
Overall length*	mm (ft.in)	4275 (14'0")	4190 (13'9")	4190 (13'9")	4385 (14'5")
Overall width (w/o trunnion)	mm (ft.in)	1970 (6'6")	1910 (6'3")	1910 (6'3")	2080 (6'10")
Overall width (with blade)*	mm (ft.in)	2710 (8'11")	2710 (8'11")	2710 (8'11")	2710 (8'11")
Overall height (tractor)**	mm (ft.in)	2775 (9'1")*6	2760 (9'1")*6	2760 (9'1")*6	2845 (9'4")*6
Overall height*	mm (ft.in)	2775 (9'1")	2760 (9'1")	2760 (9'1")	2845 (9'4")
Track gauge	mm (ft.in)	1570 (5'2")	1510 (4'11")	1510 (4'11")	1620 (5'4")
Length of track on ground	mm (ft.in)	2240 (7'4")	2240 (7'4")	2240 (7'4")	2360 (7'9")
ENGINE:					
Model		KOMATSU SAA4D95LE-6	KOMATSU SAA4D95LE-5	KOMATSU SAA4D95LE-5	KOMATSU SAA4D95LE-6
No. of cylinders- bore × stroke	mm (in)	4-95 × 115 (3.74 × 4.53)	4-95 × 115 (3.74 × 4.53)	4-95 × 115 (3.74 × 4.53)	4-95 × 115 (3.74 × 4.53)
Piston displacement	ltr. (cu.in)	3.26 (199)	3.26 (199)	3.26 (199)	3.26 (199)
UNDERCARRIAGE:					
No. of rollers (carrier/track)		1/6	1/6	1/6	1/6
Width of standard shoe	mm (in)	400 (15.7)	400 (15.7)	400 (15.7)	460 (18.1)
FUEL TANK CAPACITY (Refilled):	ltr. (U.S.Gal)	190 (50.2)	195 (51.5)	195 (51.5)	190 (50.2)
*) Spec conditions: Bulldozer Rear attachment Upper attachment		PAT - ROPS cab	PAT - ROPS canopy	PAT - ROPS canopy	PAT - ROPS cab

** : Without canopy, exhaust pipe, pre-cleaner cap or other easily removed encumbrances.

*** : With variable travel speed mode *6 : To top of ROPS cab

*4 : Wide track spec. *7 : Brazil source

*5 : With hitch *8 : Indonesia source

• : EPA Tier 3 and Stage 3A model

° : EPA Tier 4 Interim and Stage 3B model

Specifications

CRAWLER-TYPE TRACTORS

Item	Model	°D39EX-23***	°D39EX-22	°D39EX-22***	°D51EX-22
OPERATING WEIGHT*	kg (lb)	9270 (20,440)	9040 (19,930)	8520 (18,780)	12720 (28,040)
TRACTOR WEIGHT	kg (lb)	8160 (17,990)	7800 (17,200)	6950 (15,320)	11220 (24,740)
HORSEPOWER SAE J1995 Gross ISO9249/SAE J1349 Net Hyd. fan at max. speed Net	kW (HP)/RPM kW (HP)/RPM kW (HP)/RPM	80 (107)/2200 78.4 (105)/2200 72.9 (97.7)/2200	79.9 (107)/2200 79 (105)/2200 71 (95)/2200	71 (95)/2200	99 (133)/2200 97 (130)/2200 90 (120)/2200
PERFORMANCE:					
Travel speed Forward 1st	km/h (MPH)	0 to 8.5 (5.3) - 0 to 8.5 (5.3) - 14800 (32,630/145)	3.4 (2.1) 5.6 (3.5) 8.5 (5.3) 4.1 (2.5) 6.5 (4.1) 8.5 (5.3)	0 to 8.5 (5.3) - 0 to 8.5 (5.3) - 14800 (32,630/145)	3.4 (2.1) 5.6 (3.5) 9.0 (5.6) 4.1 (2.5) 6.5 (4.0) 9.0 (5.6)
2nd					
3rd L/3rd					
Reverse 1st					
2nd					
3rd L/3rd					
Max. drawbar pull	kg (lb/kN)				
DIMENSIONS:					
Overall length (tractor)	mm (ft.in)	3345 (11'0")	3295 (10'10")	3295 (10'10")	3665 (12'0")
Overall length*	mm (ft.in)	4385 (14'5")	4335 (14'3")	4335 (14'3")	4800 (15'8")
Overall width (w/o trunnion)	mm (ft.in)	2080 (6'10")	2110 (6'11")	2110 (6'11")	2300 (7'6")
Overall width (with blade)*	mm (ft.in)	2710 (8'11")	2710 (8'11")	2710 (8'11")	3045 (10'0")
Overall height (tractor)**	mm (ft.in)	2845 (9'4")*6	2825 (9'3")*6	2825 (9'3")*6	3002 (9'10")*6
Overall height*	mm (ft.in)	2845 (9'4")	2825 (9'3")	2825 (9'3")	3182 (10'5")
Track gauge	mm (ft.in)	1620 (5'4")	1650 (5'5")	1650 (5'5")	1790 (5'10")
Length of track on ground	mm (ft.in)	2360 (7'9")	2360 (7'9")	2360 (7'9")	2736 (9'0")
ENGINE:					
Model		KOMATSU SAA4D95LE-6	KOMATSU SAA4D107E-1	KOMATSU SAA4D107E-1	KOMATSU SAA6D107E-1
No. of cylinders- bore x stroke	mm (in)	4-95 x 115 (3.74 x 4.53)	4-107 x 124 (4.21 x 4.88)	4-107 x 124 (4.21 x 4.88)	6-107 x 124 (4.21 x 4.88)
Piston displacement	ltr. (cu.in)	3.26 (199)	4.46 (272)	4.46 (272)	6.69 (408)
UNDERCARRIAGE:					
No. of rollers (carrier/track)		1/6	1/6	1/6	2/7
Width of standard shoe	mm (in)	460 (18.1)	460 (18.1)	460 (18.1)	510 (20.1)
FUEL TANK CAPACITY (Refilled):	ltr. (U.S.Gal)	190 (50.2)	195 (51.5)	195 (51.5)	270 (71)
*) Spec conditions: Bulldozer Rear attachment Upper attachment		PAT - ROPS cab	PAT - ROPS canopy	PAT - ROPS canopy	PAT - ROPS cab

Item	Model	°D51EX-22*7	°D61EX-23	°D61EX-23***	°D61EX-15E0*7
OPERATING WEIGHT*	kg (lb)	14000 (30,860)	17700 (39,020)	17700 (39,020)	16710 (36,840)
TRACTOR WEIGHT	kg (lb)	12400 (27,340)	15530 (34,240)	15530 (34,240)	13920 (30,690)
HORSEPOWER SAE J1995 Gross ISO9249/SAE J1349 Net Hyd. fan at max. speed Net	kW (HP)/RPM kW (HP)/RPM kW (HP)/RPM	99 (133)/2200 97 (130)/2200 90 (120)/2200	127 (170)/2200 125 (168)/2200 113 (152)/2200	127 (170)/2200 125 (168)/2200 113 (152)/2200	127 (170)/1850 125 (168)/1850 116 (155)/1850
PERFORMANCE:					
Travel speed Forward 1st	km/h (MPH)	3.4 (2.1) 5.6 (3.5) 9.0 (5.6) 4.1 (2.5) 6.5 (4.0) 9.0 (5.6)	3.4 (2.1) 5.6 (3.5) 8.5 (5.3) 4.1 (2.5) 6.5 (4.0) 9.0 (5.6)	0 to 9.0 (5.6) - 0 to 9.0 (5.6) - 28100 (61,950/275.6)	3.2 (2.0) 5.6 (3.5) 8.7 (5.4) 4.3 (2.7) 7.2 (4.5) 11.0 (6.8)
2nd					
3rd L/3rd					
Reverse 1st					
2nd					
3rd L/3rd					
Max. drawbar pull	kg (lb/kN)				
DIMENSIONS:					
Overall length (tractor)	mm (ft.in)	3665 (12'0")	4165 (13'8")	4165 (13'8")	3920 (12'10")
Overall length*	mm (ft.in)	4795 (15'9")	5480 (18'0")	5480 (18'0")	5030 (16'6")
Overall width (w/o trunnion)	mm (ft.in)	2300 (7'6")	2500 (8'2")	2500 (8'2")	2500 (8'2")
Overall width (with blade)*	mm (ft.in)	3350 (11'0")	3250 (10'8")	3250 (10'8")	3275 (10'9")
Overall height (tractor)**	mm (ft.in)	3015 (9'11")*6	3180 (10'5")*6	3180 (10'5")*6	2270 (7'5")
Overall height*	mm (ft.in)	3000 (9'10")	3180 (10'5")	3180 (10'5")	3150 (10'4")
Track gauge	mm (ft.in)	1795 (5'11")	1900 (6'3")	1900 (6'3")	1900 (6'3")
Length of track on ground	mm (ft.in)	2751 (9'0")	3165 (10'5")	3165 (10'5")	2600 (8'6")
ENGINE:					
Model		KOMATSU SAA6D107E-1	KOMATSU SAA6D107E-2	KOMATSU SAA6D107E-2	KOMATSU SAA6D107E-1
No. of cylinders- bore x stroke	mm (in)	6-107 x 124 (4.21 x 4.88)	6-107 x 124 (4.21 x 4.88)	6-107 x 124 (4.21 x 4.88)	6-107 x 124 (4.21 x 4.88)
Piston displacement	ltr. (cu.in)	6.69 (408)	6.69 (408)	6.69 (408)	6.69 (408)
UNDERCARRIAGE:					
No. of rollers (carrier/track)		2/7	2/8	2/8	2/7
Width of standard shoe	mm (in)	510 (20)	600 (23.6)	600 (23.6)	600 (23.6)
FUEL TANK CAPACITY (Refilled):	ltr. (U.S.Gal)	270 (71)	372 (81.8)	372 (81.8)	390 (103)
*) Spec conditions: Bulldozer Rear attachment Upper attachment		PAT - ROPS cab	PAT - ROPS cab	PAT - ROPS cab	PAT - ROPS canopy

** : Without canopy, exhaust pipe, pre-cleaner cap or other easily removed encumbrances.

*** : With variable travel speed mode *6 : To top of ROPS cab

*4 : Wide track spec. *7 : Brazil source

*5 : With hitch *8 : Indonesia source

• : EPA Tier 3 and Stage 3A model

○ : EPA Tier 4 Interim and Stage 3B model

Specifications

CRAWLER-TYPE TRACTORS

Item	Model	•D61EX-15E0*7	D63E-12*9	D65E-12	•D65EX-16
OPERATING WEIGHT*	kg (lb)	19000 (41,890)	18500 (40,790)	19125 (42,160)	19510 (43,010)
TRACTOR WEIGHT	kg (lb)	13920 (30,690)	14645 (32,290)	15620 (34,440)	17120 (37,740)
HORSEPOWER SAE J1995 Gross ISO9249/SAE J1349 Net Hyd. fan at max. speed Net	kW (HP)/RPM kW (HP)/RPM kW (HP)/RPM	127 (170)/2200 125 (168)/2200 113 (152)/2200	127 (170)/1800 116 (155)/1800	135 (180)/1950	155 (207)/1950 153 (205)/1950 139 (186)/1950
PERFORMANCE:					
Travel speed Forward 1st	km/h (MPH)	3.2 (2.0) 5.6 (3.5) 8.7 (5.4) 4.3 (2.7) 7.2 (4.5) 11.0 (6.8)	3.4 (2.1) 5.8 (3.6) 9.0 (5.6) 4.4 (2.7) 7.5 (4.7) 11.0 (6.8)	3.9 (2.4) 6.8 (4.2) 10.6 (6.6) 5.0 (3.1) 8.6 (5.3) 13.4 (8.3)	3.6 (2.2) 5.5 (3.4) 7.2 (4.5)/11.2 (7.0) 4.4 (2.7) 6.6 (4.1) 8.6 (5.3)/13.4 (8.3)
2nd					
3rd L/3rd					
Reverse 1st					
2nd					
3rd L/3rd					
Max. drawbar pull	kg (lb/kN)	-	-	-	-
DIMENSIONS:					
Overall length (tractor)	mm (ft.in)	3920 (12'10")	3815 (12'6")	4365 (14'4")	4335 (14'3")
Overall length*	mm (ft.in)	5030 (16'6")	6510 (21'4")	5440 (17'10")	5490 (18'0")
Overall width (w/o trunnion)	mm (ft.in)	2500 (8'2")	2485 (8'2")	2390 (7'10")	2390 (7'10")
Overall width (with blade)*	mm (ft.in)	3860 (12'8")	3200 (10'6")	3460 (11'4")	3410 (11'2")
Overall height (tractor)**	mm (ft.in)	2270 (7'5")	2260 (7'5")	2330 (7'8")	3155 (10'4")*5
Overall height*	mm (ft.in)	3150 (10'4")	3140 (10'4")	3165 (10'5")	3155 (10'4")
Track gauge	mm (ft.in)	1900 (6'3")	1925 (6'4")	1880 (6'2")	1880 (6'2")
Length of track on ground	mm (ft.in)	2600 (8'6")	2725 (8'11")	2675 (8'9")	2980 (9'9")
ENGINE:					
Model		KOMATSU SAA6D107E-1	KOMATSU SA6D114E-2	KOMATSU 6D125E-2	KOMATSU SAA6D114E-3
No. of cylinders- bore x stroke	mm (in)	6-107 x 124 (4.21 x 4.88)	6-114 x 135 (4.49 x 5.31)	6-125 x 150 (4.92 x 5.91)	6-114 x 135 (4.49 x 5.31)
Piston displacement	ltr. (cu.in)	6.69 (408)	8.27 (505)	11.04 (674)	8.27 (505)
UNDERCARRIAGE:					
No. of rollers (carrier/track)		2/7	2/6	2/7	2/7
Width of standard shoe	mm (in)	600 (23.6)	560 (22.0)	510 (20.1)	510 (20.0)
FUEL TANK CAPACITY (Refilled):	ltr. (U.S.Gal)	390 (103)	315 (83.3)	406 (107)	415 (109.6)
*) Spec conditions: Bulldozer Rear attachment Upper attachment		PAT - ROPS cab	Semi-U tilt Single shank ripper Steel cab, ROPS	Semi-U tilt - ROPS canopy	SIGMADOZER - ROPS cab

Item	Model	•D65EX-16	○D65EX-17	○D65EX-17	○D65WX-17
OPERATING WEIGHT*	kg (lb)	19360 (42,680)	19680 (43,390)	21160 (46,650)	20530 (45,260)
TRACTOR WEIGHT	kg (lb)	17120 (37,740)	17290 (38,120)	18200 (40,120)	18030 (39,750)
HORSEPOWER SAE J1995 Gross ISO9249/SAE J1349 Net Hyd. fan at max. speed Net	kW (HP)/RPM kW (HP)/RPM kW (HP)/RPM	155 (207)/1950 153 (205)/1950 139 (186)/1950	155 (207)/1950 153 (205)/1950 139 (186)/1950	155 (207)/1950 153 (205)/1950 139 (186)/1950	155 (207)/1950 153 (205)/1950 139 (186)/1950
PERFORMANCE:					
Travel speed Forward 1st	km/h (MPH)	3.6 (2.2) 5.5 (3.5) 7.2(4.5)/11.2 (7.0) 4.4 (2.7) 6.6 (4.1) 8.6(5.3)/13.4 (8.3)	3.6 (2.2) 5.6 (3.5) 7.3(4.5)/11.3 (7.0) 4.5 (2.8) 6.7 (4.2) 8.7(5.4)/13.6 (8.5)	3.6 (2.2) 5.6 (3.5) 7.3(4.5)/11.3 (7.0) 4.5 (2.8) 6.7 (4.2) 8.7(5.4)/13.6 (8.5)	3.6 (2.2) 5.6 (3.5) 7.3(4.5)/11.3 (7.0) 4.5 (2.8) 6.7 (4.2) 8.7(5.4)/13.6 (8.5)
2nd					
3rd L/3rd					
Reverse 1st					
2nd					
3rd L/3rd					
Max. drawbar pull	kg (lb/kN)	-	-	-	-
DIMENSIONS:					
Overall length (tractor)	mm (ft.in)	4335 (14'3")	4335 (14'3")	4335 (14'3")	4335 (14'3")
Overall length*	mm (ft.in)	5310 (11'5")	5490 (18'0")	5790 (19'0")	5500 (18'1")
Overall width (w/o trunnion)	mm (ft.in)	2390 (7'10")	2390 (7'10")	2610 (8'7")	2810 (9'3")
Overall width (with blade)*	mm (ft.in)	3460 (11'4")	3410 (11'2")	3870 (12'8")	3580 (11'9")
Overall height (tractor)**	mm (ft.in)	3155 (10'4")*6	3155 (10'4")*6	3155 (10'4")*6	3155 (10'4")*6
Overall height*	mm (ft.in)	3155 (10'4")	3155 (10'4")	3155 (10'4")	3155 (10'4")
Track gauge	mm (ft.in)	1880 (6'2")	1880 (6'2")	2050 (6'9")	2050 (6'9")
Length of track on ground	mm (ft.in)	2980 (9'9")	2980 (9'9")	2980 (9'9")	2980 (9'9")
ENGINE:					
Model		KOMATSU SAA6D114E-5	KOMATSU SAA6D114E-5	KOMATSU SAA6D114E-5	KOMATSU SAA6D114E-5
No. of cylinders- bore x stroke	mm (in)	6-114 x 144.5 (4.49 x 5.69)	6-114 x 144.5 (4.49 x 5.69)	6-114 x 144.5 (4.49 x 5.69)	6-114 x 144.5 (4.49 x 5.69)
Piston displacement	ltr. (cu.in)	8.85 (540)	8.85 (540)	8.85 (540)	8.85 (540)
UNDERCARRIAGE:					
No. of rollers (carrier/track)		2/7	2/7	2/7	2/7
Width of standard shoe	mm (in)	510 (20)	510 (20)	510 (20)	510 (20)
FUEL TANK CAPACITY (Refilled):	ltr. (U.S.Gal)	415 (109.6)	415 (109.6)	415 (109.6)	415 (109.6)
*) Spec conditions: Bulldozer Rear attachment Upper attachment		Semi-U tilt - ROPS cab	SIGMADOZER - ROPS cab	PAT - ROPS cab	SIGMADOZER - ROPS cab

** : Without canopy, exhaust pipe, pre-cleaner cap or other easily removed encumbrances.

*** : With variable travel speed mode *7 : Brazil source

*4 : Wide track spec. *8 : Indonesia source

*5 : With hitch *9 : for Russia

*6 : To top of ROPS cab

• : EPA Tier 3 and Stage 3A model

○ : EPA Tier 4 Interim and Stage 3B model

Specifications

CRAWLER-TYPE TRACTORS

Item	Model	°D65WX-17	D68ESS-12* ⁸	D85ESS-2* ⁸	D85ESS-2A
OPERATING WEIGHT*	kg (lb)	22060 (48,630)	18800 (41,500)	21490 (47,380)	20670 (45,580)
TRACTOR WEIGHT	kg (lb)	19070 (42,040)	14280 (31,490)	15740 (34,700)	15420 (34,000)
HORSEPOWER SAE J1995 Gross ISO9249/SAE J1349 Net Hyd. fan at max. speed Net	kW (HP)/RPM kW (HP)/RPM kW (HP)/RPM	155 (207)/1950 153 (205)/1950 139 (186)/1950	116 (155)/1850	161 (215)/1950	149 (200)/1950
PERFORMANCE:					
Travel speed Forward 1st	km/h (MPH)	3.6 (2.2)	3.4 (2.1)	3.9 (2.4)	3.9 (2.4)
2nd		5.6 (3.5)	5.8 (3.6)	6.8 (4.2)	6.8 (4.2)
3rd L/3rd		7.3(4.5)/11.3 (7.0)	9.0 (6.0)	10.6 (6.6)	10.6 (6.6)
Reverse 1st		4.5 (2.8)	4.4 (2.7)	5.0 (3.1)	5.0 (3.1)
2nd		6.7 (4.2)	7.6 (4.7)	8.6 (5.3)	8.6 (5.3)
3rd L/3rd		8.7(5.4)/13.6 (8.5)	11.3 (7.0)	13.4 (8.3)	13.4 (8.3)
Max. drawbar pull	kg (lb/kN)	-	-	-	-
DIMENSIONS:					
Overall length (tractor)	mm (ft.in)	4335 (14'3")	4100 (13'5")	4135 (13'7")	4150 (13'7")
Overall length*	mm (ft.in)	5790 (19'0")	6120 (20'1")	5930 (19'5")	7150 (23'6")
Overall width (w/o trunnion)	mm (ft.in)	2990 (9'10")	2535 (8'4")	2660 (8'9")	2560 (8'5")
Overall width (with blade)*	mm (ft.in)	4010 (13'2")	3275 (10'9")	4370 (14'4")	4370 (14'4")
Overall height (tractor)**	mm (ft.in)	3155 (10'4")* ⁶	2305 (7'7")	2375 (7'10")	2375 (7'10")
Overall height*	mm (ft.in)	3155 (10'4")	3135 (10'3")	2560 (8'5")	3160 (10'4")
Track gauge	mm (ft.in)	2230 (7'4")	1925 (6'4")	2050 (6'9")	2050 (6'9")
Length of track on ground	mm (ft.in)	2980 (9'9")	2930 (9'7")	2980 (9'9")	2980 (9'9")
ENGINE:					
Model		KOMATSU SAA6D114E-5	KOMATSU S6D114E	KOMATSU S6D125-2	KOMATSU S6D125E-2
No. of cylinders- bore × stroke	mm (in)	6-114 × 144.5 (4.49 × 5.69)	4-114 × 135 (4.49 × 5.31)	6-125 × 150 (4.92 × 5.91)	6-125 × 150 (4.92 × 5.91)
Piston displacement	ltr. (cu.in)	8.85 (540)	8.27 (505)	11.04 (674)	11.04 (674)
UNDERCARRIAGE:					
No. of rollers (carrier/track)		2/7	2/6	2/8	2/8
Width of standard shoe	mm (in)	510 (20)	610 (24)	610 (24.0)	510 (20.1)
FUEL TANK CAPACITY (Refilled):	ltr. (U.S.Gal)	415 (109.6)	315 (93.3)	407 (107.5)	406 (107)
*) Spec conditions: Bulldozer Rear attachment Upper attachment		PAT - ROPS cab	PAT Winch Sweep canopy	Angledozer Winch Sweep canopy	Angledozer Multi-shank ripper Canopy

Item	Model	*D85EX-15E0	D85EX-15R	D155A-5	D155A-6
OPERATING WEIGHT*	kg (lb)	28100 (61,950)	28000 (61,730)	38700 (85,320)	41700 (91,930)
TRACTOR WEIGHT	kg (lb)	21220 (46,780)	21120 (46,560)	27900 (61,510)	32300 (71,200)
HORSEPOWER SAE J1995 Gross ISO9249/SAE J1349 Net Hyd. fan at max. speed Net	kW (HP)/RPM kW (HP)/RPM kW (HP)/RPM	199 (266)/1900 197 (264)/1900 179 (240)/1900	199 (266)/1900 197 (264)/1900 179 (240)/1900	225 (302)/1900	268 (360)/1900 264 (354)/1900 239 (320)/1900
PERFORMANCE:					
Travel speed Forward 1st	km/h (MPH)	3.3 (2.1)	3.3 (2.1)	3.7 (2.3)	3.9 (2.4)
2nd		6.1 (3.8)	6.1 (3.8)	6.7 (4.2)	5.7 (3.5)
3rd L/3rd		10.1 (6.3)	10.1 (6.3)	11.0 (6.8)	11.4 (7.1)
Reverse 1st		4.4 (2.7)	4.4 (2.7)	5.0 (3.1)	4.7 (2.9)
2nd		8.0 (5.0)	8.0 (5.0)	8.2 (5.1)	6.8 (4.2)
3rd L/3rd		13.0 (8.1)	13.0 (8.1)	13.9 (8.6)	13.7 (8.5)
Max. drawbar pull	kg (lb/kN)	-	-	-	-
DIMENSIONS:					
Overall length (tractor)	mm (ft.in)	5035 (16'6")	5035 (16'6")	4975 (16'4")	5030 (16'6")
Overall length*	mm (ft.in)	7255 (23'10")	7255 (23'10")	8155 (26'9")	8680 (28'6")
Overall width (w/o trunnion)	mm (ft.in)	2560 (8'5")	2560 (8'5")	2695 (8'10")	2765 (91")
Overall width (with blade)*	mm (ft.in)	3635 (11'11")	3635 (11'11")	3955 (13'0")	4130 (13'7")
Overall height (tractor)**	mm (ft.in)	3163 (10'5")* ⁴	3163 (10'5")* ⁴	2590 (8'6")	3395 (11'2")
Overall height*	mm (ft.in)	3330 (10'11")	3324 (10'11")	3500 (11'6")	3510 (11'6")
Track gauge	mm (ft.in)	2000 (6'7")	2000 (6'7")	2100 (6'11")	2140 (7'0")
Length of track on ground	mm (ft.in)	3050 (10')	3050 (10')	3210 (10'6")	3150 (10'4")
ENGINE:					
Model		KOMATSU SAA6D125E-5	KOMATSU SAA6D125E-5	KOMATSU SA6D140E-2	KOMATSU SAA6D140E-5
No. of cylinders- bore × stroke	mm (in)	6-125 × 150 (4.92 × 5.91)	6-125 × 150 (4.92 × 5.91)	6-140 × 165 (5.51 × 6.50)	6-140 × 165 (5.51 × 6.50)
Piston displacement	ltr. (cu.in)	11.04 (674)	11.04 (674)	15.24 (930)	15.24 (930)
UNDERCARRIAGE:					
No. of rollers (carrier/track)		2/7	2/7	2/6	2/7
Width of standard shoe	mm (in)	560 (22)	560 (22)	560 (22.0)	560 (22)
FUEL TANK CAPACITY (Refilled):	ltr. (U.S.Gal)	490 (129)	490 (129)	500 (132)	625 (165)
*) Spec conditions: Bulldozer Rear attachment Upper attachment		Semi-U tilt Multi-shank ripper Steel cab, ROPS	Semi-U tilt Multi-shank ripper Steel cab, ROPS	Semi-U tilt Multi-shank ripper Steel cab, ROPS	Semi-U tilt Giant ripper Steel cab, ROPS

** : Without canopy, exhaust pipe, pre-cleaner cap or other easily removed encumbrances.

*** : With variable travel speed mode *⁶ : To top of ROPS cab

*4 : Wide track spec.

*5 : With hitch

*7 : Brazil source

*8 : Indonesia source

• : EPA Tier 3 and Stage 3A model

○ : EPA Tier 4 Interim and Stage 3B model

Specifications

CRAWLER-TYPE TRACTORS

Item	Model	◊D155AX-7	•D155AX-6	D275A-5	D275A-5R
OPERATING WEIGHT*	kg (lb)	39500 (87,080)	39500 (87,100)	49850 (109,900)	50850 (112,100)
TRACTOR WEIGHT	kg (lb)	31700 (69,890)	31000 (68,350)	37680 (83,070)	37680 (83,070)
HORSEPOWER SAE J1995 Gross ISO9249/SAE J1349 Net Hyd. fan at max. speed Net	kW (HP)/RPM kW (HP)/RPM kW (HP)/RPM	268 (360)/1900 264 (354)/1900 239 (320)/1950	268 (360)/1900 264 (354)/1900 239 (320)/1900	306 (410)/2000	337 (452)/2000 335 (449)/2000 306 (410)/2000
PERFORMANCE:					
Travel speed Forward 1st	km/h (MPH)	3.5 (2.2) 5.6 (3.5) 7.5(4.7)/11.3 (7.2)	3.8 (2.4) 5.6 (3.5) 11.6 (7.2)	3.8 (2.4) 6.7 (4.2) 11.2 (7.0)	3.6 (2.2) 6.7 (4.2) 11.2 (7.0)
2nd					
3rd L/3rd					
Reverse 1st					
2nd					
3rd L/3rd					
Max. drawbar pull	kg (lb/kN)	9.2(5.7)/14.0 (8.7)	14.0 (8.7)	14.9 (9.3)	14.9 (9.3)
DIMENSIONS:					
Overall length (tractor)	mm (ft.in)	4975 (16'4")	4875 (16'0")	5255 (17'3")	5255 (17'3")
Overall length*	mm (ft.in)	8325 (27'4")	8225 (27")	9290 (30'6")	9290 (30'6")
Overall width (w/o trunnion)	mm (ft.in)	2700 (8'10")	2765 (9'1")	2925 (9'7")	2925 (9'7")
Overall width (with blade)*	mm (ft.in)	4060 (13'4")	4060 (13'4")	4300 (14'1")	4300 (14'1")
Overall height (tractor)**	mm (ft.in)	3390 (11'1") ⁶	2680 (8'10")	3160 (10'4")	3090 (10'2")
Overall height*	mm (ft.in)	3390 (11'1")	3395 (11'2")	3985 (13'1")	4015 (13'2")
Track gauge	mm (ft.in)	2140 (7'0")	2140 (7")	2260 (7'5")	2260 (7'5")
Length of track on ground	mm (ft.in)	2700 (8'10")	3275 (10'9")	3480 (11'5")	3480 (11'5")
ENGINE:					
Model		KOMATSU	KOMATSU	KOMATSU	KOMATSU
No. of cylinders- bore × stroke	mm (in)	6-140 × 165 (5.51 × 6.50)	6-140 × 165 (5.51 × 6.50)	6-140 × 165 (5.51 × 6.50)	6-140 × 165 (5.51 × 6.50)
Piston displacement	ltr. (cu.in)	15.24 (930)	15.24 (930)	15.24 (930)	15.24 (930)
UNDERCARRIAGE:					
No. of rollers (carrier/track)		2/7	2/7	2/7	2/7
Width of standard shoe	mm (in)	560 (22)	560 (22)	610 (24.0)	610 (24.0)
FUEL TANK CAPACITY (Refilled):	ltr. (U.S.Gal)	625 (165)	625 (165)	840 (222)	840 (222)
*) Spec conditions: Bulldozer Rear attachment Upper attachment		Strengthened SIGMADOZER Giant ripper ROPS cab	Strengthened SIGMADOZER Giant ripper ROPS cab	Semi-U tilt Giant ripper Steel cab, ROPS	Semi-U tilt Giant ripper Steel cab, ROPS

Item	Model	•D275AX-5E0	D375A-6	D375A-6R	D375A-5
OPERATING WEIGHT*	kg (lb)	49850 (109,900)	71640 (157,940)	70235 (154,840)	66990 (147,690)
TRACTOR WEIGHT	kg (lb)	37680 (83,070)	53200 (117,290)	51800 (114,200)	49800 (109,790)
HORSEPOWER SAE J1995 Gross ISO9249/SAE J1349 Net Hyd. fan at max. speed Net	kW (HP)/RPM kW (HP)/RPM kW (HP)/RPM	337 (452)/2000 335 (449)/2000 306 (410)/2000	474 (636)/1800 455 (610)/1800 433 (580)/1800	474 (636)/1800 455 (610)/1800 433 (580)/1800	391 (525)/1800
PERFORMANCE:					
Travel speed Forward 1st	km/h (MPH)	3.6 (2.2) 6.7 (4.2) 11.2 (7.0)	3.5 (2.2) 6.8 (4.2) 11.8 (7.3)	3.5 (2.2) 6.8 (4.2) 11.8 (7.3)	3.8 (2.4) 6.8 (4.2) 11.8 (7.3)
2nd					
3rd L/3rd					
Reverse 1st					
2nd					
3rd L/3rd					
Max. drawbar pull	kg (lb/kN)	14.9 (9.3)	15.8 (9.8)	15.8 (9.8)	15.8 (9.8)
DIMENSIONS:					
Overall length (tractor)	mm (ft.in)	5255 (17'3")	5905 (19'4")	5905 (19'4")	5770 (18'11")
Overall length*	mm (ft.in)	9260 (30'5")	10485 (34'5")	10515 (34'6")	10330 (33'11")
Overall width (w/o trunnion)	mm (ft.in)	2925 (9'7")	3240 (10'8")	3240 (10'8")	3220 (10'7")
Overall width (with blade)*	mm (ft.in)	4300 (14'1")	4695 (15'5")	4695 (15'5")	4695 (15'5")
Overall height (tractor)**	mm (ft.in)	3090 (10'2")	3365 (11'0")	3315 (10'11")	3280 (10'9")
Overall height*	mm (ft.in)	4010 (13'2")	4285 (14'1")	4235 (13'11")	4230 (13'11")
Track gauge	mm (ft.in)	2260 (7'5")	2500 (8'2")	2500 (8'2")	2500 (8'2")
Length of track on ground	mm (ft.in)	3480 (11'5")	3980 (13'1")	3840 (12'7")	3840 (12'7")
ENGINE:					
Model		KOMATSU	KOMATSU	KOMATSU	KOMATSU
No. of cylinders- bore × stroke	mm (in)	6-140 × 165 (5.51 × 6.50)	6-170 × 170 (6.69 × 6.69)	6-170 × 170 (6.69 × 6.69)	6-170 × 170 (6.69 × 6.69)
Piston displacement	ltr. (cu.in)	11.04 (674)	23.15 (1413)	23.15 (1413)	23.15 (1413)
UNDERCARRIAGE:					
No. of rollers (carrier/track)		2/7	2/8	2/7	2/7
Width of standard shoe	mm (in)	610 (24.0)	610 (24.0)	610 (24.0)	610 (24.0)
FUEL TANK CAPACITY (Refilled):	ltr. (U.S.Gal)	840 (222)	1200 (317)	1200 (317)	1050 (277)
*) Spec conditions: Bulldozer Rear attachment Upper attachment		Semi-U tilt Giant ripper Steel cab, ROPS	Semi-U tilt Giant ripper Steel cab, ROPS	Semi-U tilt Giant ripper Steel cab, ROPS	Semi-U tilt Giant ripper Steel cab, ROPS

** : Without canopy, exhaust pipe, pre-cleaner cap or other easily removed encumbrances.

*** : With variable travel speed mode *6 : To top of ROPS cab

*4 : Wide track spec.

*5 : With hitch

*7 : Brazil source

*8 : Indonesia source

• : EPA Tier 3 and Stage 3A model

◊ : EPA Tier 4 Interim and Stage 3B model

Specifications

CRAWLER-TYPE TRACTORS

Item	Model	D375A-5R	D475A-5E0	D475A-5E0 SD	D575A-3
OPERATING WEIGHT*	kg (lb)	68370 (150,730)	108390 (238,960)	113200 (249,560)	131350 (289,570)
TRACTOR WEIGHT	kg (lb)	50720 (111,820)	83590 (184,290)	84510 (186,310)	98450 (217,040)
HORSEPOWER SAE J1995 Gross ISO9249/SAE J1349 Net Hyd. fan at max. speed Net	kW (HP)/RPM kW (HP)/RPM kW (HP)/RPM	451 (605)/1800 391 (525)/1800 391 (525)/1800	671 (899)/2000 644 (890)/2000 641 (860)/2000	671 (899)/2000 664 (890)/2000 641 (860)/2000	783 (1050)/1800
PERFORMANCE:					
Travel speed Forward 1st	km/h (MPH)	3.5 (2.2) 6.8 (4.2) 11.8 (7.3) 4.6 (2.9) 9.2 (5.7) 15.8 (9.8)	3.3 (2.1) 6.2 (3.9) 11.2 (7.0)	3.3 (2.1) 6.2 (3.9) 11.2 (7.0)	3.7 (2.3) 6.6 (4.1) 11.6 (7.2) 4.3 (2.7) 7.7 (4.8) 13.3 (8.3)
2nd					
3rd L/3rd					
Reverse 1st					
2nd					
3rd L/3rd					
Max. drawbar pull	kg (lb/kN)	-	14.0 (8.7)	14.0 (8.7)	-
DIMENSIONS:					
Overall length (tractor)	mm (ft.in)	5905 (19'4")	6680 (21'11")	6680 (21'11")	7270 (23'10")
Overall length*	mm (ft.in)	10410 (34'2")	11565 (37'11")	10525 (34'6")	12095 (39'8")
Overall width (w/o trunnion)	mm (ft.in)	3225 (10'7")	3660 (12')	3610 (11'10")	4180 (13'9")
Overall width (with blade)*	mm (ft.in)	4695 (15'5")	5265 (17'3")	6465 (21'3")	5880 (19'3")
Overall height (tractor)**	mm (ft.in)	3475 (11'5")	3660 (12')	3660 (12')	3780 (12'5")
Overall height*	mm (ft.in)	4235 (13'11")	4646 (15'3")	4646 (15'3")	4880 (16'0")
Track gauge	mm (ft.in)	2500 (8'2")	2770 (9'1")	2770 (9'1")	3220 (10'7")
Length of track on ground	mm (ft.in)	3840 (12'7")	4524 (14'10")	4524 (14'10")	4530 (14'10")
ENGINE:					
Model		KOMATSU	KOMATSU	KOMATSU	KOMATSU
No. of cylinders- bore × stroke	mm (in)	SAA6D170E-5 6-170 × 170 (6.69 × 6.69)	SAA12V140E-3 12-140 × 165 (5.51 × 6.50)	SAA12V140E-5 12-140 × 165 (5.51 × 6.50)	SA12V170 12-170 × 170 (6.69 × 6.69)
Piston displacement	ltr. (cu.in)	23.15 (1413)	30.48 (1860)		46.3 (2825)
UNDERCARRIAGE:					
No. of rollers (carrier/track)		2/8	2/8	2/8	2/6
Width of standard shoe	mm (in)	610 (24.0)	710 (28.0)	810 (32.0)	860 (34.0)
FUEL TANK CAPACITY (Refilled):	ltr. (U.S.Gal)	1050 (277)	1670 (441)	1670 (441)	2100 (555)
*) Spec conditions: Bulldozer Rear attachment Upper attachment		Semi-U tilt Giant ripper Steel cab, ROPS	Semi-U tilt Giant ripper Steel cab, ROPS	Super dozer Counterweight Steel cab, ROPS	Semi-U dozer Giant ripper Steel cab, ROPS

Item	Model	D575A-3 SD			
OPERATING WEIGHT*	kg (lb)	152600 (336,420)			
TRACTOR WEIGHT	kg (lb)	114580 (252,600)			
HORSEPOWER SAE J1995 Gross ISO9249/SAE J1349 Net Hyd. fan at max. speed Net	kW (HP)/RPM kW (HP)/RPM kW (HP)/RPM	858 (1150)/1800			
PERFORMANCE:					
Travel speed Forward 1st	km/h (MPH)	3.7 (2.3) 6.6 (4.1) 11.6 (7.2) 4.3 (2.7) 7.7 (4.8) 13.3 (8.3)			
2nd					
3rd L/3rd					
Reverse 1st					
2nd					
3rd L/3rd					
Max. drawbar pull	kg (lb/kN)	-			
DIMENSIONS:					
Overall length (tractor)	mm (ft.in)	7695 (25'3")			
Overall length*	mm (ft.in)	11720 (38'5")			
Overall width (w/o trunnion)	mm (ft.in)	4180 (13'9")			
Overall width (with blade)*	mm (ft.in)	7400 (24'3")			
Overall height (tractor)**	mm (ft.in)	3780 (12'5")			
Overall height*	mm (ft.in)	4880 (16'0")			
Track gauge	mm (ft.in)	3220 (10'7")			
Length of track on ground	mm (ft.in)	5485 (18')			
ENGINE:					
Model		KOMATSU			
No. of cylinders- bore × stroke	mm (in)	SA12V170 12-170 × 170 (6.69 × 6.69)			
Piston displacement	ltr. (cu.in)	46.3 (2825)			
UNDERCARRIAGE:					
No. of rollers (carrier/track)		2/8			
Width of standard shoe	mm (in)	860 (33.9)			
FUEL TANK CAPACITY (Refilled):	ltr. (U.S.Gal)	2100 (555)			
*) Spec conditions: Bulldozer Rear attachment Upper attachment		Super dozer Counterweight Steel cab, ROPS			

** : Without canopy, exhaust pipe, pre-cleaner cap or other easily removed encumbrances.

*** : With variable travel speed mode *6 : To top of ROPS cab

*4 : Wide track spec.

*5 : With hitch

*7 : Brazil source

*8 : Indonesia source

• : EPA Tier 3 and Stage 3A model

○ : EPA Tier 4 Interim and Stage 3B model

Specifications (Low Ground Pressure Tractors)

CRAWLER-TYPE TRACTORS

Item	Model	D21P-8E0	•D31PX-22	•D31PX-22***	◊D37PX-23
OPERATING WEIGHT*	kg (lb)	4100 (9,040)	8130 (17,930)	8130 (17,930)	8340 (18,390)
TRACTOR WEIGHT	kg (lb)	3520 (7,760)	6910 (15,240)	6910 (15,240)	7300 (16,090)
HORSEPOWER SAE J1995 Gross ISO9249/SAE J1349 Net Hyd. fan at max. speed Net	kW (HP)/RPM kW (HP)/RPM kW (HP)/RPM	32.4 (43.4)/2450	60 (80)/2200 58 (78)/2200 53 (71)/2200	60 (80)/2200 58 (78)/2200 53 (71)/2200	67.7 (90.7)/2200 66.1 (88.6)/2200 62.3 (83.5)/2200
PERFORMANCE:					
Travel speed Forward 1st	km/h (MPH)	2.6 (1.6)	3.4 (2.1)	0 to	3.4 (2.1)
2nd		4.4 (2.7)	5.6 (3.5)	8.5 (5.3)	5.6 (3.5)
3rd L/3rd		-	8.5 (5.3)	-	8.5 (5.3)
Reverse 1st		3.3 (2.1)	4.1 (2.5)	0 to	4.1 (2.5)
2nd		5.6 (3.5)	6.5 (4.0)	8.5 (5.3)	6.5 (4.0)
3rd L/3rd		-	8.5 (5.3)	-	8.5 (5.3)
Max. drawbar pull	kg (lb/kN)	4480 (9,880/43.9)	15300 (33,730/150)	15300 (33,730/150)	15300 (33,730/150)
DIMENSIONS:					
Overall length (tractor)*4	mm (ft.in)	2430 (8'0")	3220 (10'7")	3220 (10'7")	3270 (10'9")
Overall length*	mm (ft.in)	3260 (10'8")	4155 (13'8")	4155 (13'8")	4275 (14'0")
Overall width (w/o trunnion)	mm (ft.in)	2000 (6'7")	2250 (7'5")	2250 (7'5")	1970 (6'6")
Overall width (with blade)*	mm (ft.in)	2560 (8'5")	3250 (10'8")	3250 (10'8")	2710 (8'11")
Overall height (tractor)**	mm (ft.in)	1810 (5'11")	2760 (9'1") ⁶	2760 (9'1") ⁶	2775 (9'1") ⁶
Overall height*	mm (ft.in)	2335 (7'8")	2775 (9'1")	2775 (9'1")	2775 (9'1")
Track gauge	mm (ft.in)	1490 (4'11")	1650 (5'5")	1650 (5'5")	1710 (5'7")
Length of track on ground	mm (ft.in)	1685 (5'6")	2185 (7'2")	2185 (7'2")	2240 (7'4")
ENGINE:					
Model		KOMATSU 4D94LE-2	KOMATSU SAA4D95LE-5	KOMATSU SAA4D95LE-5	KOMATSU SAA4D95LE-6
No. of cylinders- bore × stroke	mm (in)	4-94 × 110 (3.70 × 4.33)	4-95 × 115 (3.74 × 4.53)	4-95 × 115 (3.74 × 4.53)	4-95 × 115 (3.74 × 4.53)
Piston displacement	ltr. (cu.in)	3.053 (186)	3.26 (199)	3.26 (199)	3.26 (199)
UNDERCARRIAGE:					
No. of rollers (carrier/track)		1/5	1/6	1/6	1/6
Width of standard shoe	mm (in)	510 (20.1)	600 (23.6)	600 (23.6)	600 (23.6)
FUEL TANK CAPACITY (Refilled):	ltr. (U.S.Gal)	60 (15.9)	195 (51.5)	195 (51.5)	190 (50.2)
*) Spec conditions: Bulldozer Rear attachment Upper attachment		PAT - -	PAT - ROPS canopy	PAT - ROPS canopy	PAT - ROPS cab

Item	Model	◊D37PX-23***	•D37PX-22	•D37PX-22***	◊D39PX-23
OPERATING WEIGHT*	kg (lb)	8340 (18,390)	8240 (18,170)	8240 (18,170)	9270 (20,440)
TRACTOR WEIGHT	kg (lb)	7300 (16,090)	6990 (15,410)	6990 (15,410)	8160 (17,990)
HORSEPOWER SAE J1995 Gross ISO9249/SAE J1349 Net Hyd. fan at max. speed Net	kW (HP)/RPM kW (HP)/RPM kW (HP)/RPM	67.7 (90.7)/2200 66.1 (88.6)/2200 62.3 (83.5)/2200	68 (91)/2200 66 (89)/2200 59 (79)/2200	68 (91)/2200 66 (89)/2200 59 (79)/2200	80 (107)/2200 78.4 (105)/2200 72.9 (97.7)/2200
PERFORMANCE:					
Travel speed Forward 1st	km/h (MPH)	0 to	3.4 (2.1)	0 to	3.4 (2.1)
2nd		8.5 (5.3)	5.6 (3.5)	8.5 (5.3)	5.6 (3.5)
3rd L/3rd		-	8.5 (5.3)	-	8.5 (5.3)
Reverse 1st		0 to	4.1 (2.5)	0 to	4.1 (2.5)
2nd		8.5 (5.3)	6.5 (4.0)	8.5 (5.3)	6.5 (4.0)
3rd L/3rd		-	8.5 (5.3)	-	8.5 (5.3)
Max. drawbar pull	kg (lb/kN)	15300 (33,730/150)	15300 (33,730/150)	15300 (33,730/150)	14800 (32,630/145)
DIMENSIONS:					
Overall length (tractor)*4	mm (ft.in)	3270 (10'9")	3055 (10'2")	3055 (10'2")	3345 (11'0")
Overall length*	mm (ft.in)	4275 (14'0")	4175 (13'8")	4175 (13'8")	4385 (14'5")
Overall width (w/o trunnion)	mm (ft.in)	1970 (6'6")	2250 (7'5")	2250 (7'5")	2080 (6'10")
Overall width (with blade)*	mm (ft.in)	2710 (8'11")	3250 (10'8")	3250 (10'8")	2710 (8'11")
Overall height (tractor)**	mm (ft.in)	2775 (9'1") ⁶	2760 (9'1") ⁶	2760 (9'1") ⁶	2845 (9'4") ⁶
Overall height*	mm (ft.in)	2775 (9'1")	2775 (9'1")	2775 (9'1")	2845 (9'4")
Track gauge	mm (ft.in)	1710 (5'7")	1650 (5'5")	1650 (5'5")	1810 (5'11")
Length of track on ground	mm (ft.in)	2240 (7'4")	2240 (7'4")	2240 (7'4")	2360 (7'9")
ENGINE:					
Model		KOMATSU SAA4D95LE-6	KOMATSU SAA4D95LE-5	KOMATSU SAA4D95LE-5	KOMATSU SAA4D95LE-6
No. of cylinders- bore × stroke	mm (in)	4-95 × 115 (3.74 × 4.53)	4-95 × 115 (3.74 × 4.53)	4-95 × 115 (3.74 × 4.53)	4-95 × 115 (3.74 × 4.53)
Piston displacement	ltr. (cu.in)	3.26 (199)	3.26 (199)	3.26 (199)	3.26 (199)
UNDERCARRIAGE:					
No. of rollers (carrier/track)		1/6	1/6	1/6	1/6
Width of standard shoe	mm (in)	600 (23.6)	600 (23.6)	600 (23.6)	635 (25.0)
FUEL TANK CAPACITY (Refilled):	ltr. (U.S.Gal)	190 (50.2)	195 (51.5)	195 (51.5)	190 (50.2)
*) Spec conditions: Bulldozer Rear attachment Upper attachment		PAT - ROPS cab	PAT - ROPS canopy	PAT - ROPS canopy	PAT - ROPS cab

** : Without canopy, exhaust pipe, pre-cleaner cap or other easily removed encumbrances.

*** : With variable travel speed mode *6 : To top of ROPS cab

*4 : Wide track spec. *7 : Brazil source

*5 : With hitch *8 : Indonesia source

• : EPA Tier 3 and Stage 3A model

◊ : EPA Tier 4 Interim and Stage 3B model

Specifications (Low Ground Pressure Tractors)

CRAWLER-TYPE TRACTORS

Item	Model	°D39PX-23***	°D39PX-22	°D39PX-22***	°D51PX-22*7
OPERATING WEIGHT*	kg (lb)	9270 (20,440)	9480 (20,900)	8900 (19,620)	13220 (29,150)
TRACTOR WEIGHT	kg (lb)	8160 (17,990)	8160 (17,990)	8160 (17,990)	11620 (25,620)
HORSEPOWER SAE J1995 Gross ISO9249/SAE J1349 Net Hyd. fan at max. speed Net	kW (HP)/RPM kW (HP)/RPM kW (HP)/RPM	80 (107)/2200 78.4 (105)/2200 72.9 (97.7)/2200	79.9 (107)/2200 79 (105)/2200 71 (95)/2200	79.9 (107)/2200 79 (105)/2200 71 (95)/2200	99 (133)/2200 97 (130)/2200 90 (120)/2200
PERFORMANCE:					
Travel speed Forward 1st	km/h (MPH)	0 to	3.4 (2.1)	0 to	3.4 (2.1)
2nd		8.5 (5.3)	5.6 (3.5)	8.5 (5.3)	5.6 (3.5)
3rd L/3rd		-	8.5 (5.3)	-	9.0 (5.6)
Reverse 1st		0 to	4.1 (2.5)	0 to	4.1 (2.5)
2nd		8.5 (5.3)	6.5 (4.1)	8.5 (5.3)	6.5 (4.0)
3rd L/3rd		-	8.5 (5.3)	-	9.0 (5.6)
Max. drawbar pull	kg (lb/kN)	14800 (32,630/145)	14500 (32,630/145)	14500 (32,630/145)	-
DIMENSIONS:					
Overall length (tractor)*4	mm (ft.in)	3345 (11'0")	3295 (10'10")	3295 (10'10")	3665 (12'0")
Overall length*	mm (ft.in)	4385 (14'5")	4335 (14'3")	4335 (14'3")	4800 (15'8")
Overall width (w/o trunnion)	mm (ft.in)	2080 (6'10")	2425 (7'11")	2425 (7'11")	2590 (8'6")
Overall width (with blade)*	mm (ft.in)	2710 (8'11")	3250 (10'8")	3250 (10'8")	3350 (11'0")
Overall height (tractor)**	mm (ft.in)	2845 (9'4") ⁶	2825 (9'3") ⁶	2825 (9'3") ⁶	3002 (9'10") ⁶
Overall height*	mm (ft.in)	2845 (9'4")	2825 (9'3")	2825 (9'3")	3182 (10'5")
Track gauge	mm (ft.in)	1810 (5'11")	1790 (5'10")	1790 (5'10")	1880 (6'2")
Length of track on ground	mm (ft.in)	2360 (7'9")	2360 (7'9")	2360 (7'9")	2736 (9'0")
ENGINE:					
Model		KOMATSU SAA4D95LE-6	KOMATSU SAA4D107E-1	KOMATSU SAA4D107E-1	KOMATSU SAA6D107E-1
No. of cylinders- bore × stroke	mm (in)	4-95 x 115 (3.74 x 4.53)	4-107 x 124 (4.21 x 4.88)	4-107 x 124 (4.21 x 4.88)	6-107 x 124 (4.21 x 4.88)
Piston displacement	ltr. (cu.in)	3.26 (199)	4.46 (272)	4.46 (272)	6.69 (408)
UNDERCARRIAGE:					
No. of rollers (carrier/track)		1/6	1/6	1/6	2/7
Width of standard shoe	mm (in)	635 (25.0)	635 (25.0)	635 (25.0)	710 (28)
FUEL TANK CAPACITY (Refilled):	ltr. (U.S.Gal)	190 (50.2)	195 (51.5)	195 (51.5)	270 (71.3)
*) Spec conditions: Bulldozer Rear attachment Upper attachment		PAT - ROPS cab	PAT - ROPS canopy	PAT - ROPS canopy	PAT - ROPS cab

Item	Model	°D61PX-23	°D61PX-23***	°D61PX-15E0*7	D65P-12
OPERATING WEIGHT*	kg (lb)	17700 (29,020)	17700 (29,020)	18710 (41,250)	20185 (44,500)
TRACTOR WEIGHT	kg (lb)	15530 (34,240)	15530 (34,240)	15620 (34,440)	16940 (37,350)
HORSEPOWER SAE J1995 Gross ISO9249/SAE J1349 Net Hyd. fan at max. speed Net	kW (HP)/RPM kW (HP)/RPM kW (HP)/RPM	127 (170)/2200 125 (168)/2200 113 (152)/2200	127 (170)/2200 125 (168)/2200 113 (152)/2200	127 (170)/1850 125 (168)/1850 116 (155)/1850	142 (190)/1950
PERFORMANCE:					
Travel speed Forward 1st	km/h (MPH)	3.4 (2.1)	0 to	3.2 (2.0)	3.9 (2.4)
2nd		5.6 (3.5)	9.0 (5.6)	5.6 (3.5)	6.8 (4.2)
3rd L/3rd		8.5 (5.3)	-	8.7 (5.4)	10.6 (6.6)
Reverse 1st		4.1 (2.5)	0 to	4.3 (2.7)	5.0 (3.1)
2nd		6.5 (4.0)	9.0 (5.6)	7.2 (4.5)	8.6 (5.3)
3rd L/3rd		9.0 (5.6)	-	11.2 (6.8)	13.4 (8.3)
Max. drawbar pull	kg (lb/kN)	28100 (61,950/275.6)	-	-	-
DIMENSIONS:					
Overall length (tractor)*4	mm (ft.in)	4165 (13'8")	4165 (13'8")	4160 (13'8")	4425 (14'6")
Overall length*	mm (ft.in)	5480 (18'0")	5480 (18'0")	5440 (17'10")	5520 (18'1")
Overall width (w/o trunnion)	mm (ft.in)	2500 (8'2")	2500 (8'2")	3000 (9'10")	2965 (9'9")
Overall width (with blade)*	mm (ft.in)	3250 (10'8")	3250 (10'8")	3860 (12'8")	3970 (13'0")
Overall height (tractor)**	mm (ft.in)	3180 (10'5") ⁶	3180 (10'5") ⁶	2270 (7'5")	2300 (7'7")
Overall height*	mm (ft.in)	3180 (10'5")	3180 (10'5")	3150 (10'4")	3165 (10'5")
Track gauge	mm (ft.in)	2130 (7'0")	2130 (7'0")	2140 (7'0")	2050 (6'9")
Length of track on ground	mm (ft.in)	3165 (10'5")	3165 (10'5")	3170 (10'5")	3285 (10'9")
ENGINE:					
Model		KOMATSU SAA6D107E-2	KOMATSU SAA6D107E-2	KOMATSU SAA6D107E-1	KOMATSU S6D125E
No. of cylinders- bore × stroke	mm (in)	6-107 x 124 (4.21 x 4.88)	6-107 x 124 (4.21 x 4.88)	6-107 x 124 (4.21 x 4.88)	6-125 x 150 (4.92 x 5.91)
Piston displacement	ltr. (cu.in)	6.69 (408)	6.69 (408)	6.69 (408)	11.04 (674)
UNDERCARRIAGE:					
No. of rollers (carrier/track)		2/8	2/8	2/8	2/8
Width of standard shoe	mm (in)	600 (23.6)	600 (23.6)	860 (34)	915 (36.0)
FUEL TANK CAPACITY (Refilled):	ltr. (U.S.Gal)	372 (81.8)	372 (81.8)	390 (103)	406 (107.3)
*) Spec conditions: Bulldozer Rear attachment Upper attachment		PAT - ROPS cab	PAT - ROPS cab	PAT - ROPS canopy	Straight tilt - Steel cab, ROPS

** : Without canopy, exhaust pipe, pre-cleaner cap or other easily removed encumbrances.

*** : With variable travel speed mode *6 : To top of ROPS cab

*4 : Wide track spec. *7 : Brazil source

*5 : With hitch *8 : Indonesia source

• : EPA Tier 3 and Stage 3A model

○ : EPA Tier 4 Interim and Stage 3B model

Specifications (Low Ground Pressure Tractors)

CRAWLER-TYPE TRACTORS

Item	Model	•D65PX-16	•D65PX-16	◦D65PX-17	◦D65PX-17				
OPERATING WEIGHT*	kg (lb)	20990 (46,270)	21860 (48,190)	21160 (46,650)	22030 (48,570)				
TRACTOR WEIGHT	kg (lb)	18890 (41,640)	18870 (41,600)	19060 (42,020)	19040 (41,980)				
HORSEPOWER SAE J1995 Gross ISO9249/SAE J1349 Net Hyd. fan at max. speed Net	kW (HP)/RPM kW (HP)/RPM kW (HP)/RPM	155 (207)/1950 153 (205)/1950 139 (186)/1950	155 (207)/1950 153 (205)/1950 139 (186)/1950	155 (207)/1950 153 (205)/1950 139 (186)/1950	155 (207)/1950 153 (205)/1950 139 (186)/1950				
PERFORMANCE:									
Travel speed Forward 1st	km/h (MPH)	3.6 (2.2)	3.6 (2.2)	3.6 (2.2)	3.6 (2.2)				
2nd						5.5 (3.4)	5.5 (3.4)	5.6 (3.5)	5.6 (3.5)
3rd L/3rd						11.2 (7.0)	11.2 (7.0)	7.3(4.5)/11.3 (7.0)	7.3(4.5)/11.3 (7.0)
Reverse 1st						4.4 (2.7)	4.4 (2.7)	4.5 (2.8)	4.5 (2.8)
2nd						6.6 (4.1)	6.6 (4.1)	6.7 (4.2)	6.7 (4.2)
3rd L/3rd	13.4 (8.3)	13.4 (8.3)	8.7(5.4)/13.6 (8.5)	8.7(5.4)/13.6 (8.5)					
Max. drawbar pull	kg (lb/kN)	-	-	-	-				
DIMENSIONS:									
Overall length (tractor)*4	mm (ft.in)	4505 (14'9")	5130 (16'10")	4505 (14'9")	4505 (14'9")				
Overall length*	mm (ft.in)	5680 (18'8")	5790 (19'0")	5680 (18'8")	5790 (19'0")				
Overall width (w/o trunnion)	mm (ft.in)	2965 (9'8")	2990 (9'10")	2965 (9'8")	2990 (9'10")				
Overall width (with blade)*	mm (ft.in)	3970 (13' 0")	2990 (9'10")	3970 (13'0")	4010 (13'2")				
Overall height (tractor)**	mm (ft.in)	3155 (10'4") ⁶	3155 (10'4") ⁶	3155 (10'4") ⁶	3155 (10'4") ⁶				
Overall height*	mm (ft.in)	3155 (10'4")	3155 (10'4")	3155 (10'4")	3155 (10'4")				
Track gauge	mm (ft.in)	2050 (6' 9")	2230 (7' 4")	2050 (6'9")	2230 (7'4")				
Length of track on ground	mm (ft.in)	3285 (10'9")	3285 (10'9")	3285 (10'9")	2980 (9'9")				
ENGINE:									
Model		KOMATSU	KOMATSU	KOMATSU	KOMATSU				
No. of cylinders- bore × stroke	mm (in)	SAA6D114E-3 6-114 × 135 (4.49 × 5.31)	SAA6D114E-3 6-114 × 135 (4.49 × 5.31)	SAA6D114E-5 6-114 × 144.5 (4.49 × 5.69)	SAA6D114E-5 6-114 × 144.5 (4.49 × 5.69)				
Piston displacement	ltr. (cu.in)	8.27 (505)	8.27 (505)	8.85 (540)	8.85 (540)				
UNDERCARRIAGE:									
No. of rollers (carrier/track)		2/8	2/8	2/8	2/8				
Width of standard shoe	mm (in)	915 (36)	760 (30)	915 (36)	760 (30)				
FUEL TANK CAPACITY (Refilled):	ltr. (U.S.Gal)	415 (109.6)	415 (109.6)	415 (109.6)	415 (109.6)				
*) Spec conditions:									
Bulldozer		Straight tilt	PAT	Straight tilt	PAT				
Rear attachment		-	-	-	-				
Upper attachment		ROPS cab	ROPS cab	ROPS cab	ROPS cab				

Item	Model	•D85PX-15E0	D85PX-15R						
OPERATING WEIGHT*	kg (lb)	27650 (60,960)	27550 (60,740)						
TRACTOR WEIGHT	kg (lb)	23500 (51,810)	23400 (51,590)						
HORSEPOWER SAE J1995 Gross ISO9249/SAE J1349 Net Hyd. fan at max. speed Net	kW (HP)/RPM kW (HP)/RPM kW (HP)/RPM	199 (266)/1900 197 (264)/1900 179 (240)/1900	179 (240)/1900						
PERFORMANCE:									
Travel speed Forward 1st	km/h (MPH)	3.3 (2.1)	3.6 (2.2)						
2nd						6.0 (3.7)	6.0 (3.7)		
3rd L/3rd						10.0 (6.2)	10.0 (6.2)		
Reverse 1st						4.7 (2.9)	4.7 (2.9)		
2nd						7.9 (4.9)	7.9 (4.9)		
3rd L/3rd	12.7 (7.9)	12.7 (7.9)							
Max. drawbar pull	kg (lb/kN)	-	-						
DIMENSIONS:									
Overall length (tractor)*4	mm (ft.in)	4720 (15'6")	4720 (15'6")						
Overall length*	mm (ft.in)	6065 (19'11")	6065 (19'11")						
Overall width (w/o trunnion)	mm (ft.in)	3160 (10'4")	3160 (10'4")						
Overall width (with blade)*	mm (ft.in)	4365 (14'4")	4365 (14'4")						
Overall height (tractor)**	mm (ft.in)	3163 (10'5") ⁶	3163 (10'5") ⁶						
Overall height*	mm (ft.in)	3330 (10'11")	3324 (10'11")						
Track gauge	mm (ft.in)	2250 (7'5")	2250 (7'5")						
Length of track on ground	mm (ft.in)	3480 (11'5")	3480 (11'5")						
ENGINE:									
Model		KOMATSU	KOMATSU						
No. of cylinders- bore × stroke	mm (in)	SAA6D125E-5 6-125 × 150 (4.92 × 5.91)	SAA6D125E-5 6-125 × 150 (4.9 × 5.9)						
Piston displacement	ltr. (cu.in)	11.04 (674)	11.04 (674)						
UNDERCARRIAGE:									
No. of rollers (carrier/track)		2/8	2/8						
Width of standard shoe	mm (in)	910 (36)	910 (36)						
FUEL TANK CAPACITY (Refilled):	ltr. (U.S.Gal)	490 (129)	490 (129)						
*) Spec conditions:									
Bulldozer		Straight tilt	Straight tilt						
Rear attachment		-	-						
Upper attachment		Steel cab, ROPS	Steel cab, ROPS						

** : Without canopy, exhaust pipe, pre-cleaner cap or other easily removed encumbrances.

*** : With variable travel speed mode *6 : To top of ROPS cab

*4 : Wide track spec. *7 : Brazil source

*5 : With hitch *8 : Indonesia source

• : EPA Tier 3 and Stage 3A model

◦ : EPA Tier 4 Interim and Stage 3B model

Drawbar Pull vs. Travel Speed

CRAWLER-TYPE TRACTORS

D61EX-15E0

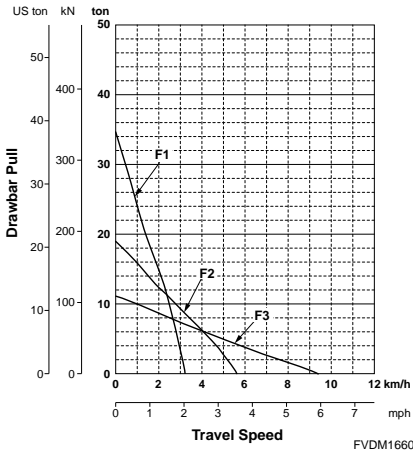

D61EX-23

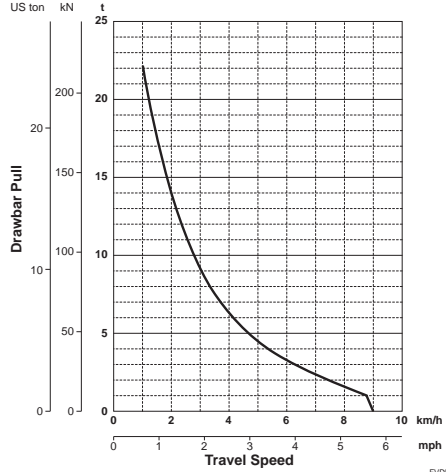

D63E-12

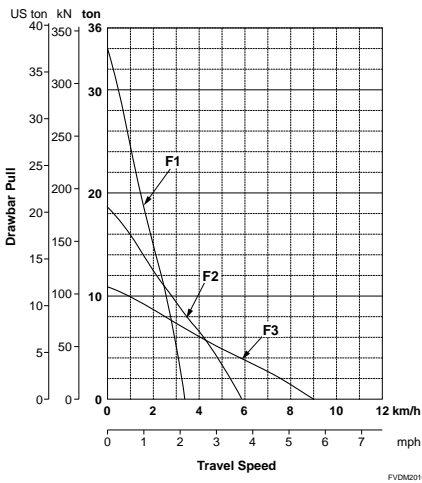

D65E-12

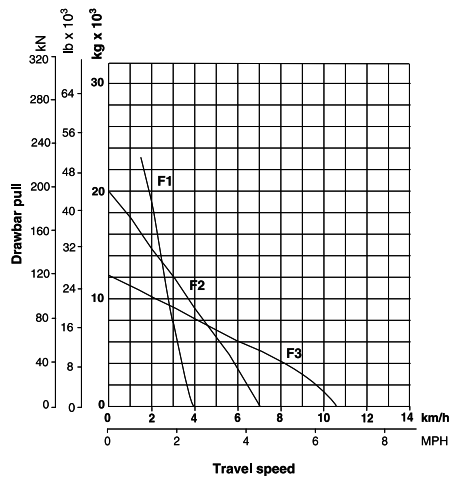

D65EX-16, D65WX-16

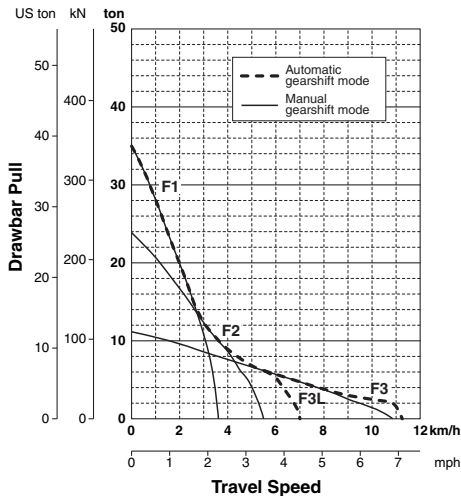

D65EX-17, D65WX-17

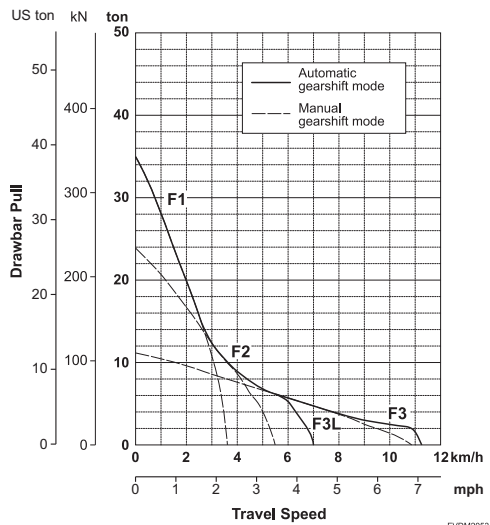

NOTE: THE DRAWBAR PULL AND TRAVEL SPEED MAY BE SUBJECT TO CHANGE DEPENDING ON THE GROUND CONDITIONS AND MACHINE WEIGHT.

Drawbar Pull vs. Travel Speed

CRAWLER-TYPE TRACTORS

D68ESS-12

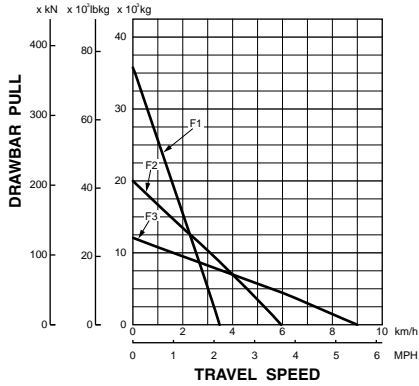

FVBH0265

D85ESS-2, D85ESS-2A

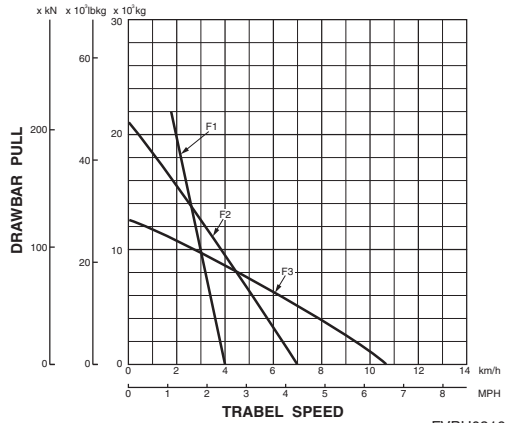

FVBH0316

**D85EX-15E0
D85EX-15R**

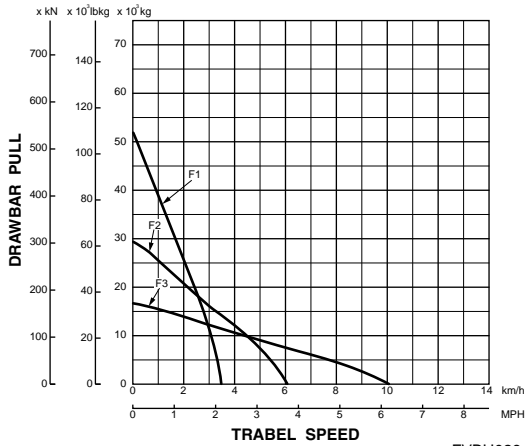

FVBH0264

D155A-5

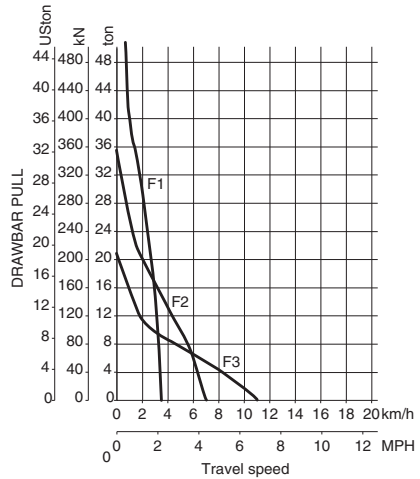

D155A-6

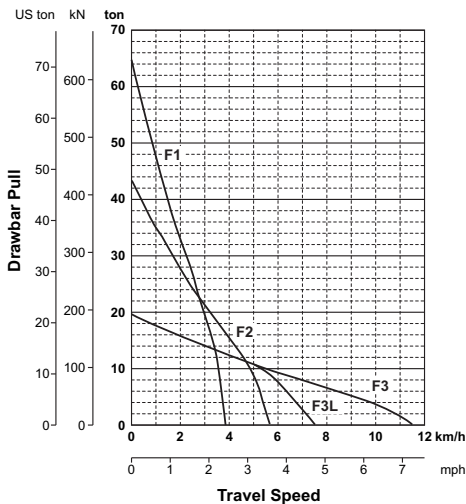

D155AX-6

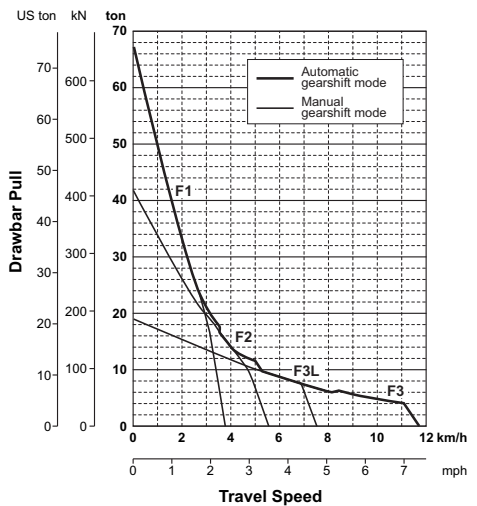

NOTE: THE DRAWBAR PULL AND TRAVEL SPEED MAY BE SUBJECT TO CHANGE DEPENDING ON THE GROUND CONDITIONS AND MACHINE WEIGHT.

Drawbar Pull vs. Travel Speed

CRAWLER-TYPE TRACTORS

D155AX-7

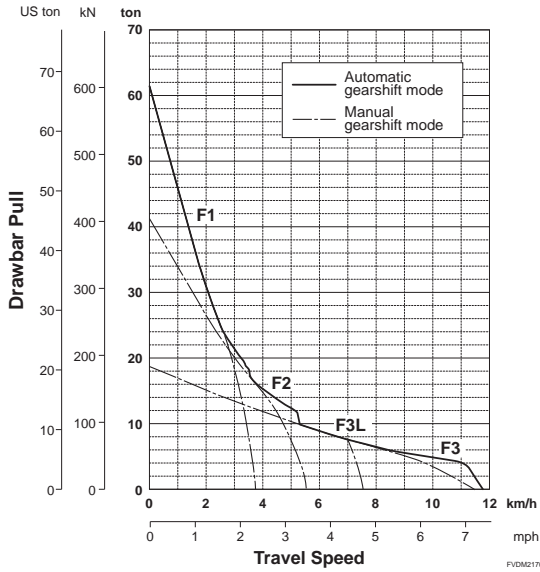

D275A-5, D275A-5R

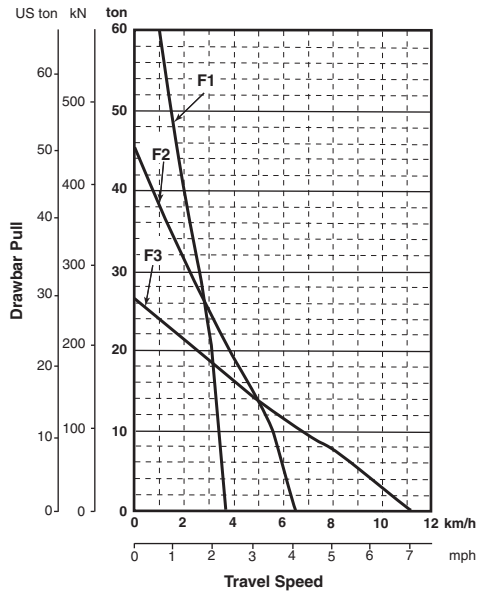

D275AX-5E0

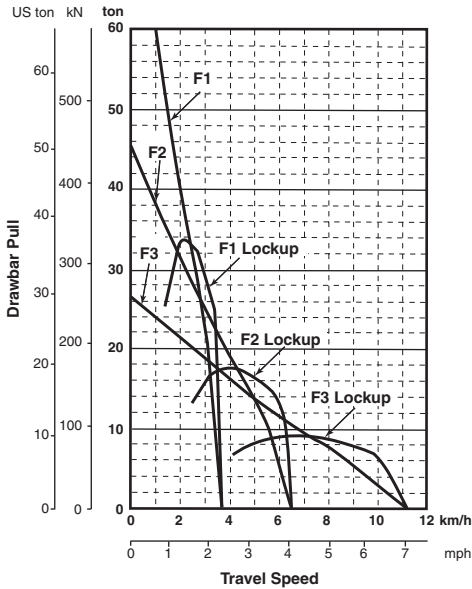

D375A-5, D375A-5R

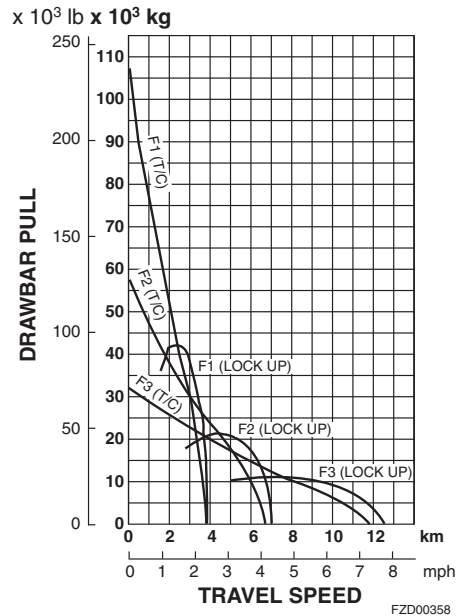

NOTE: THE DRAWBAR PULL AND TRAVEL SPEED MAY BE SUBJECT TO CHANGE DEPENDING ON THE GROUND CONDITIONS AND MACHINE WEIGHT.

Drawbar Pull vs. Travel Speed

CRAWLER-TYPE TRACTORS

D375A-6

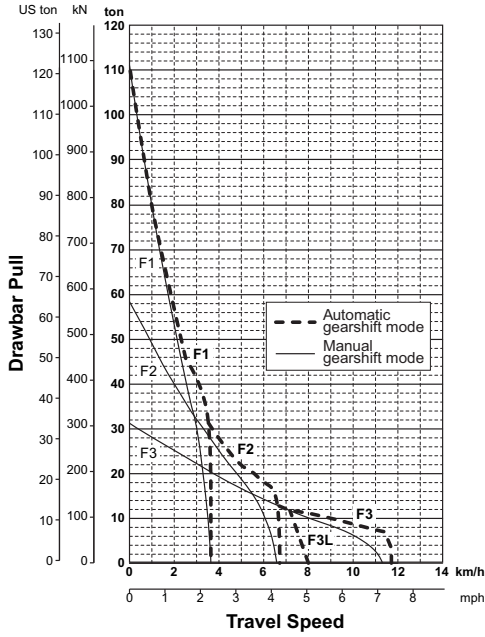

D475A-5E0, D475ASD-5E0

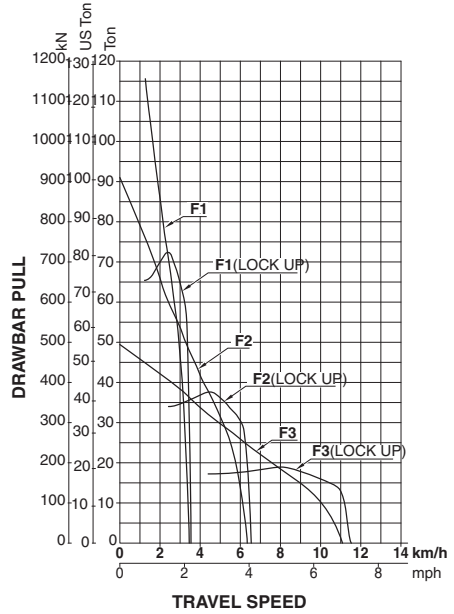

D575A-3

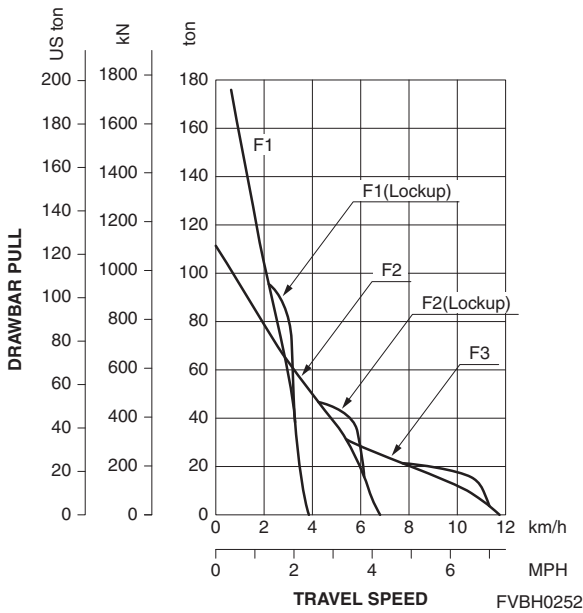

D575A-3 SD

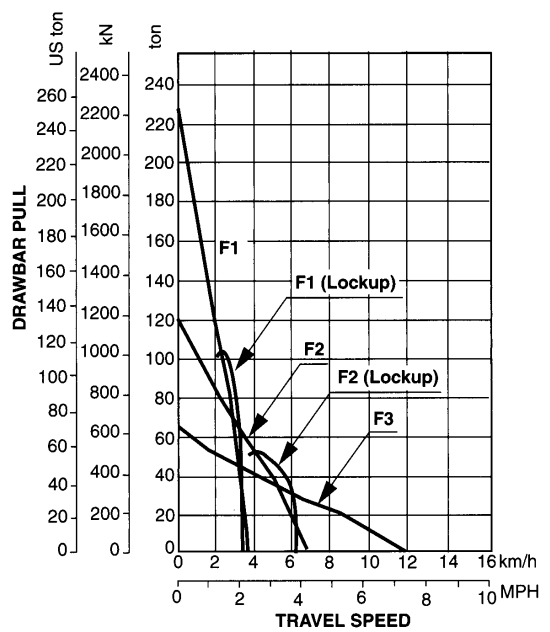

NOTE: THE DRAWBAR PULL AND TRAVEL SPEED MAY BE SUBJECT TO CHANGE DEPENDING ON THE GROUND CONDITIONS AND MACHINE WEIGHT.

Drawbar Pull vs. Travel Speed

CRAWLER-TYPE TRACTORS

D61PX-15E0

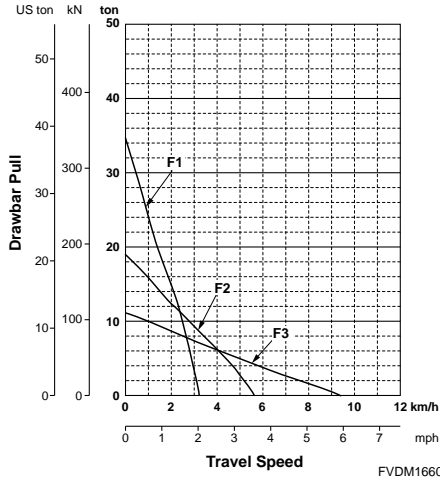

D61PX-23

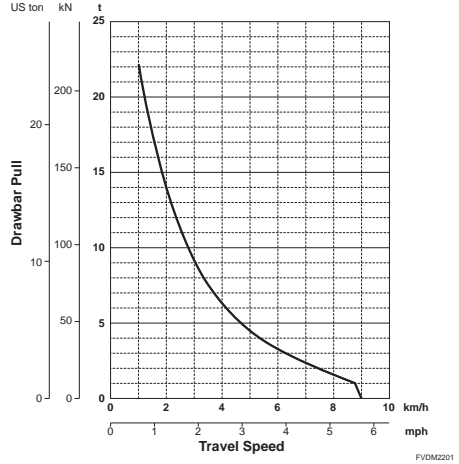

D65PX-16

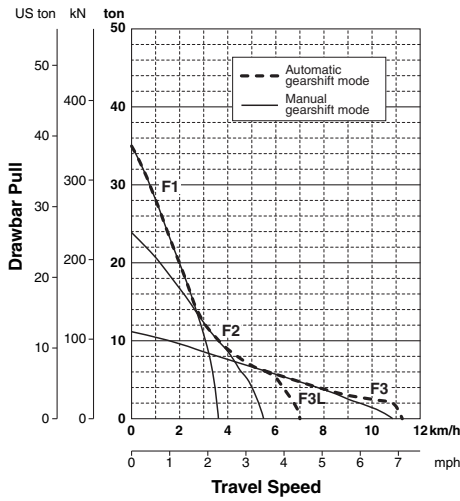

D65PX-17

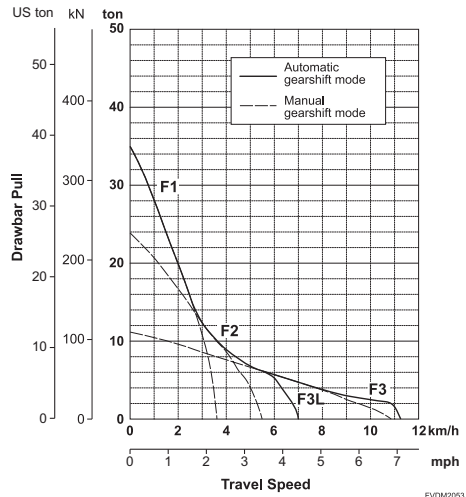

D85PX-15E0

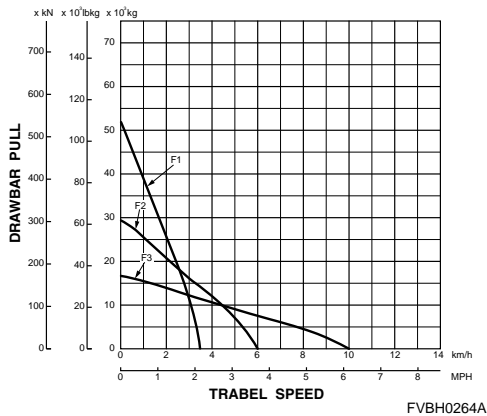

NOTE: THE DRAWBAR PULL AND TRAVEL SPEED MAY BE SUBJECT TO CHANGE DEPENDING ON THE GROUND CONDITIONS AND MACHINE WEIGHT.

Definition: Ground pressure = tractor machine operating weight / total ground contact area where;
total ground contact area = length of track on ground × shoe width × 2.

Single grouser shoe

Model	Shoe width mm (in)	Ground contact area cm ² (in ²)	Ground pressure kg/cm ² (PSI/kPa)	Change in operating weight kg (lb)	Application**
D21A-8E0	300 (12)*	10110 (1,570)	0.31 (4.41/30.4)	±0	B
	340 (13.4)	11460 (1,780)	0.28 (3.98/27.5)	+32 (71)	B
D21P-8E0	510 (20)*	17190 (2,664)	0.20 (2.84/19.6)	±0	C
D31EX-22	400 (15.7)*	17500 (2,713)	0.37 (5.26/36.3)	±0	B
D31PX-22	600 (23.6)*	26200 (4,061)	0.26 (3.70/25.5)	±0	C
D37EX-22	400 (15.7)*	17900 (2,775)	0.37 (5.26/36.3)	±0	B
D37PX-22	600 (23.6)*	26900 (4,170)	0.26 (3.70/25.5)	±0	C
D37EX-23	400 (15.7)*	17900 (2,775)	0.41 (5.83/40.2)	±0	B
	460 (18)	20610 (3,195)	0.36 (5.12/35.3)	+80 (176)	B
D37PX-23	600 (23.6)*	26900 (4,170)	0.28 (3.98/27.5)	±0	C
D39EX-22	460 (18)*	21710 (3,365)	0.36 (5.12/35.3)	±0	B
	510 (20)	24070 (3,731)	0.33 (4.69/32.4)	+90 (198)	B
D39PX-22	635 (25)*	29970 (4,645)	0.27 (3.84/26.5)	±0	B
	700 (27.6)	33040 (5,121)	0.25 (3.56/24.5)	+110 (245)	C
D39EX-23	460 (18)*	21710 (3,365)	0.38 (5.40/37.3)	±0	B
	510 (20)	24070 (3,731)	0.34 (4.83/33.3)	+90 (198)	B
D39PX-23	635 (25)*	29970 (4,645)	0.28 (3.98/27.5)	±0	B
	700 (27.6)	33040 (5,121)	0.26 (3.70/25.5)	+110 (245)	C
D51EX-22	510 (20)*	28000 (4,340)	0.45 (5.69/39.2)	±0	B
	560 (22)	30745 (4,765)			B
D51EX-22*4	510 (20)*	28000 (4,340)	0.45 (5.69/39.2)	±0	B
D51PX-22	710 (28)	38980 (6,042)	0.34 (4.82/33.3)	±0	C
D61EX-15E0	600 (23.6)*	31200 (4,836)	0.45 (6.40/44.1)	±0	B
D61EX-15E0*4	600 (23.6)*	31200 (4,836)	0.45 (6.40/44.1)	±0	B
D61EX-23	600 (23.6)*	37980 (5,887)	0.41 (5.83/40.2)	±0	B
D61PX-23	860 (33.9)*	54440 (5,887)	0.30 (4.27/29.4)	±0	C
D63E-12	510 (20)	27800 (4,308)	0.52 (7.39/51.0)	-120 (265)	B
	560 (22)*	30500 (4,730)	0.48 (6.83/47.1)	±0	B
	610 (24)	33200 (5,146)	0.44 (6.26/43.1)	+120 (265)	B
D65E-12	510 (20)*	27290 (4,230)	0.57 (8.11/55.9)	±0	B
	560 (22)	29970 (4,645)	0.53 (7.54/52.0)	+120 (265)	B
	610 (24)	32640 (5,059)	0.49 (6.97/48.1)	+230 (507)	B
	660 (26)	35320 (5,475)	0.45 (6.40/44.1)	+360 (794)	B
D65EX-16	510 (20)*	30400 (4,711)	0.56 (8.01/55.2)	±0	B
	560 (22)	33380 (5,174)	0.52 (7.35/51.0)	+130 (289)	B
	610 (24)	36360 (5,636)	0.48 (6.83/47.1)	+250 (551)	B
	660 (26)	39340 (6,100)	0.44 (6.26/43.1)	+380 (838)	B
D65PX-16	915 (36)*	60120 (9,319)	0.31 (4.47/30.8)	±0	C
D65WX-16	760 (30)*	45300 (7,021)	0.39 (5.61/38.2)	±0	C
D65P-12	915 (36)*	60120 (9,319)	0.28 (3.98/27.5)	±0	C
D65EX-17	510 (20)*	30400 (4,712)	0.55 (7.82/53.9)	±0	B
	560 (22)	33380 (5,174)	0.52 (7.39/51.0)	+130 (289)	B
	610 (24)	36360 (5,636)	0.48 (6.83/47.1)	+250 (551)	B
	660 (26)	39340 (6,098)	0.45 (6.40/44.1)	+380 (838)	B
D65PX-17	915 (36)*	60120 (9,319)	0.31 (4.41/30.4)	±0	C
D65WX-17	760 (30)*	45300 (7,021)	0.39 (5.61/38.2)	±0	C
D68ESS-12	610 (24)	35700 (5,635)	0.53 (7.54/52.0)	±0	B
D85ESS-2	610 (24)	36360 (5,635)	0.43 (6.11/42.2)	±0	B
D85ESS-2A	510 (20)*	30400 (4,711)	0.51 (7.25/50.0)	±0	A
	560 (22)	33380 (5,174)	0.47 (6.68/46.1)	+120 (265)	A
	610 (24)	36360 (5,636)	0.43 (6.11/42.2)	+230 (507)	B
	660 (26)	39340 (6,100)	0.40 (5.69/39.2)	+360 (794)	B
D85EX-15E0	560 (22)*	34160 (5,295)	0.47 (6.68/46.1)	±0	A
	610 (24)	39000 (6,045)	0.43 (6.11/42.2)	+340 (750)	B
D85EX-15R	660 (26)	40260 (6,240)	0.40 (5.69/39.2)	+530 (1168)	B
D85PX-15E0	910 (36)*	63340 (9,820)	0.44 (6.26/43.1)	±0	C
D85PX-15R					

* : Standard shoe

** : See the classification of shoe application

*** : Long track spec.

*4 : Brazil source

Model	Shoe width mm (in)	Ground contact area cm ² (in ²)	Ground pressure kg/cm ² (PSI/kPa)	Change in operating weight kg (lb)	Application**
D155A-5	560 (22)*	35950 (5,572)	0.78 (11.09/76.5)	±0	A
	610 (24)	39160 (6,070)	0.72 (10.23/70.6)	+210 (460)	B
	660 (26)	42370 (6,567)	0.67 (9.53/65.7)	+400 (880)	B
	710 (28)	45580 (7,056)	0.63 (8.96/61.8)	+620 (1370)	C
D155A-6	560 (22)*	35280 (5,468)	0.92 (13.1/90.2)	±0	A
	610 (24)	38430 (5,957)	0.85 (12.1/83.4)	+200 (440)	B
	660 (26)	41580 (6,445)	0.79 (11.2/77.5)	+410 (900)	B
	710 (28)	44730 (6,933)	0.74 (10.5/72.6)	+610 (1340)	C
D155AX-6	560 (22)*	36680 (5,685)	0.84 (11.9/82.4)	±0	A
	610 (24)	39960 (6,193)	0.78 (12.1/76.5)	+200 (440)	B
	660 (26)	43230 (6,700)	0.73 (10.4/71.6)	+410 (900)	B
	710 (28)	46500 (7,208)	0.68 (9.67/66.7)	+620 (1370)	C
D155AX-7	560 (22)*	36680 (5,685)	0.84 (11.9/82.4)	±0	A
	610 (24)	39960 (6,193)	0.78 (12.1/76.5)	+200 (440)	B
	660 (26)	43230 (6,700)	0.73 (10.4/71.6)	+410 (900)	B
	710 (28)	46510 (7,208)	0.68 (9.67/66.7)	+620 (1370)	C

* : Standard shoe

** : See the classification of shoe application

*** : Long track spec.

*4 : Brazil source

Definition: Ground pressure = tractor machine operating weight / total ground contact area where;
total ground contact area = length of track on ground × shoe width × 2.

Extreme service shoe

Model	Shoe width mm (in)	Ground contact area cm ² (in ²)	Ground pressure kg/cm ² (PSI/kPa)	Change in operating weight kg (lb)	Application**
D155A-5	560 (22)	35950 (5,572)	0.79 (11.23/77.5)	+460 (1,010)	A
	610 (24)	39160 (6,070)	0.73 (10.38/71.6)	+700 (1,540)	B
	660 (26)	42370 (6,567)	0.68 (9.67/66.1)	+940 (2,070)	B
D155A-6	560 (22)	36680 (5,685)	0.89 (12.7/87.3)	+450 (990)	A
	610 (24)	39960 (6,193)	0.83 (11.8/81.4)	+690 (1,520)	B
	660 (26)	43230 (6,700)	0.77 (10.9/75.5)	+920 (2,030)	B
D155AX-6	560 (22)	36680 (5,685)	0.85 (12.1/83.4)	+460 (1,010)	A
	610 (24)	39960 (6,193)	0.79 (11.2/77.5)	+700 (1,540)	B
	660 (26)	43230 (6,700)	0.74 (10.5/72.6)	+940 (2,070)	B
D155AX-7	560 (22)	36680 (5,685)	0.84 (11.9/82.4)	+460 (1,010)	A
	610 (24)	39960 (6,193)	0.78 (12.1/76.5)	+700 (1,540)	B
	660 (26)	43230 (6,700)	0.73 (10.4/71.6)	+940 (2,070)	B
D275A-5 D275A-5R	610 (24)*	42460 (6,580)	0.89 (12.7/87.3)	±0	A
	710 (28)	49420 (7,659)	0.77 (10.9/75.5)	+570 (1,260)	B
	760 (30)	52900 (8,199)	0.73 (10.4/71.6)	+850 (1,870)	B
D275AX-5E0	610 (24)*	42460 (6,580)	0.89 (12.7/87.3)	±0	A
	710 (28)	49420 (7,659)	0.77 (10.9/75.5)	+570 (1,260)	B
	760 (30)	52900 (8,199)	0.73 (10.4/71.6)	+850 (1,870)	B
D375A-5	610 (24)*	46850 (7,262)	1.06 (15.1/104)	±0	A
	710 (28)	54530 (8,452)	0.93 (13.2/91.2)	+660 (1,445)	B
	810 (32)	62210 (9,643)	0.82 (11.7/80.4)	+1330 (2,930)	C
D375A-5R	610 (24)*	46850 (7,262)	1.06 (15.1/104)	±0	A
	710 (28)	54530 (8,452)	0.93 (13.2/91.2)	+660 (1,445)	B
	810 (32)	62210 (9,643)	0.82 (11.7/80.4)	+1330 (2,930)	C
D375A-6	610 (24)*	48560 (7,527)	1.10 (15.6/108)	±0	A
	710 (28)	56520 (8,760)	0.95 (13.5/93.2)	+680 (1,500)	B
	810 (32)	64480 (9,990)	0.85 (12.1/83.4)	+1360 (3,000)	C
D375A-6R	610 (24)*	46850 (7,262)	1.11 (15.8/109)	±0	A
	710 (28)	54530 (8,452)	0.96 (13.7/94.1)	+660 (1,445)	B
	810 (32)	62210 (9,643)	0.85 (12.1/83.4)	+1330 (2,930)	C
D475A-5E0	710 (28)*	64240 (9,957)	1.30 (18.5/128)	±0	A
	810 (32)	73290 (11,360)	1.15 (16.4/113)	+920 (2,030)	B
	910 (36)	82340 (12,762)	1.04 (14.8/102)	+1830 (4,030)	C
D475ASD-5E0	810 (32)*	73290 (11,360)	1.15 (16.4/113)	±0	A,B
	910 (36)	82340 (12,762)	1.05 (14.9/103)	+1830 (4,030)	C

Model	Shoe width mm (in)	Ground contact area cm ² (in ²)	Ground pressure kg/cm ² (PSI/kPa)	Change in operating weight kg (lb)	Application**
D575A-3	760 (30)*	68860 (10670)	1.43 (20.3/140)	±0	A
	810 (32)	73390 (11,375)	1.35 (19.2/132)	+500 (1,100)	B
	860 (34)	77920 (12,080)	1.28 (18.2/126)	+1000 (2,210)	B
	910 (36)	82450 (12,780)	1.21 (17.2/119)	+1500 (3,310)	C
D575A-3 SD	860 (34)*	94340 (14,620)	1.21 (17.2/119)	±0	A,B
	910 (36)	99830 (15,430)	1.15 (16.4/113)	+570 (1,260)	B

Swamp shoe (Circular arc shape)

Model	Shoe width mm (in)	Ground contact area cm ² (in ²)	Ground pressure kg/cm ² (PSI/kPa)	Change in operating weight kg (lb)	Application**
D31PX-22	600 (23.6)	26200 (4,061)	0.27 (3.84/26.5)	+40 (88)	C
D37PX-22	600 (23.6)	26900 (4,170)	0.26 (3.70/25.5)	+40 (88)	C
D39PX-22	700 (27.6)	33040 (5,121)	0.25 (3.56/24.5)	-20 (44)	C
D61PX-15E0	860 (30)	54520 (8,451)	0.28 (3.98/27.5)	-400 (880)	C
D65P-12	950 (37.4)	62420 (9,675)	0.27 (3.84/26.5)	+50 (110)	C
D65PX-16	940 (37)	61760 (9,573)	0.31 (4.41/30.4)	+30 (70)	C
D65PX-17	940 (37)	61760 (9,573)	0.31 (4.41/30.4)	+30 (70)	C
D85PX-15E0	910 (36)	63340 (9,820)	0.37 (5.26/36.3)	-65 (143)	C
D85PX-15R					

* : Standard shoe

** : See the classification of shoe application



*** : Long track spec.

Classification of the applications:

Classification	Applicable terrain	Limitations
A	Rocky terrain, general terrain	These can be used over a wide range of general civil engineering work from crushed rock to preparation of residential land. There is no particular limitation on their use.
B	General or soft terrain	These are used for general earthmoving work where the main work is scraping operations and pushing operations when constructing golf courses, and overburden stripping operations in coal mines. They cannot be used on rocky ground. Be careful to avoid traveling over rocks when carrying out operations on job sites where there are scattered rocks.
C	Extremely soft terrain (swamps)	These are used on soft ground where B classification shoes would sink. These cannot be used on ground where there are scattered rocks.

NOTE: Select the proper shoe width for your customers, by taking the limitations described above into consideration, (especially on wide shoes "B" and "C").
Select the narrowest possible shoes, depending on the flotation and ground pressure of the machines. If the shoe is too wide, the load on the track shoe increases and results in bends in the shoes, cracks in the links, breakage and slipping out of the pins and loosening of the bolts.

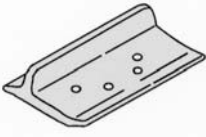
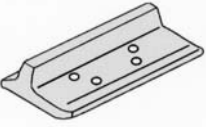
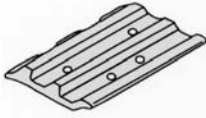
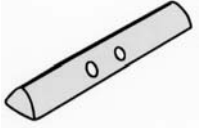
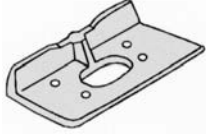
Applications of different shoes in accordance with soil characteristics and working conditions.

Type of shoe	Applicable soil and work	Advantages	Disadvantages	Remarks
<p>1 Single grouser shoe</p> 	<p>General soil excluding rocky ground (for bulldozer)</p>	<ul style="list-style-type: none"> Because the shape of the grouser is sharp, it easily bites into the ground and provides a large traction force. 	<ul style="list-style-type: none"> Strength is somewhat reduced on rocky ground, and bending and other damage may occur. The riding conform is a little inferior to the triple and double grouser shoes. The road surface is liable to be roughed. The turning resistance is large. 	<p>Is available in various widths to suit the softness of the soil.</p>
<p>2 Heavy duty shoe</p> 	<p>For rocky ground (for bulldozer)</p>	<ul style="list-style-type: none"> Compared to a single grouser shoe, the grouser and plate portions of this shoe are thicker and stronger, providing high bending resistance and wear resistance. 		
<p>3 • Tripple grouser shoe • Double grouser shoe</p> 	<p>Hard ground Suitable for both soft and hard ground (for hydraulic excavator and dozer shovel)</p>	<ul style="list-style-type: none"> The three grousers have the same height, hence turning ability is good. Good riding comfort is obtained as compared with a single grouser shoe. Rotating resistance is low. Because three beams are used, resistance to bending is high. 	<ul style="list-style-type: none"> This shoe does not readily bite into the ground, so the traction force is low. 	
<p>4 Swamp shoe</p> 	<p>Swamp areas (for swamp dozer)</p>	<ul style="list-style-type: none"> Because the cross-section of this shoe is an arc, the ground contact area is large, and buoyancy is easily obtained. This shoe is particularly suitable for use in swamp areas and areas with low ground pressure. The ground surface is not damaged when the machine travels over it, so it is suitable for soil compaction and leveling work. 	<ul style="list-style-type: none"> Unsuitable for ground other than swampy ground. When used off swampy ground, it is liable to bend due to its low strength. 	<p>Various widths are available to suit the degree of softness of the swampy ground.</p>
<p>5 Snow shoe</p> 	<p>On snow</p>	<ul style="list-style-type: none"> For use on snow To prevent transverse slip <ol style="list-style-type: none"> Is provided with rib. Grousers are stepped. For discharging ice and snow <ol style="list-style-type: none"> Holes are provided in plate portion. Tail of plate has been eliminated. 	<ul style="list-style-type: none"> Wear and damage occur rapidly when this shoe is used on general soil and rocky ground. 	
<p>6 Flat shoe</p> 	<p>Paved roads Indoor work</p>	<ul style="list-style-type: none"> Projections have been eliminated (heads of shoe bolts are recessed), permitting work on paved roads without damaging road surface. Turning resistance is very low, and tracks are highly wear resistant. 	<ul style="list-style-type: none"> Because there are no grousers, this shoe does not bite into the ground. 	

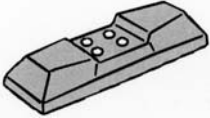
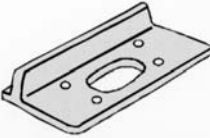
Type of shoe	Applicable soil and work	Advantages	Disadvantages	Remarks
<p>7 Road liner (rubber)</p> 	<p>Paved road Indoor work</p>	<ul style="list-style-type: none"> • The surface of the shoe in contact with the ground is made of rubber, so the machine can travel on paved roads without damaging the road surface. • Prevents noise when machine is traveling. 	<ul style="list-style-type: none"> • Use in the following places will shorten the cutting life of the rubber. <ol style="list-style-type: none"> (1) Rocky ground (2) Cold areas (below -25°C) (3) Hot areas (above 65°C) • Because there are no grouser, this shoe does not bite into the ground. 	
<p>8 Center hole shoe</p> 	<p>Soil which clogs</p>	<ul style="list-style-type: none"> • There is a hole in the plate to remove any mud or soil. • The sprocket removes any mud or soil collected between the track rails, so clogging of the track is reduced. 	<ul style="list-style-type: none"> • Strength is somewhat reduced on rocky ground, and crack and other damage may occur. 	

Roller guard installation (Bulldozer)

■ Small-middle Class

When using bulldozers, it is necessary to make most appropriate choices of the track roller guards fitting to respective working environments. Given below are the criterion for the choices.

This chart provides clearer criterion for the choices in consideration of respective functions of different types of track roller guards.

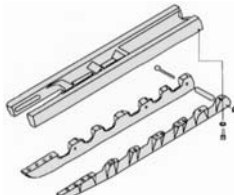
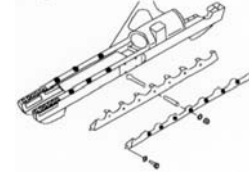
Types	Full roller guard	
	Integral structure full roller guard	3-part split type full roller guard
Determination criterion for different working environments		 Local add-on type
	Rocks and soil containing boulders and gravel (A and E)	The part is effective for prevention of catching pebbles.
	Sand and sandy soil (A, E and P)	The part is effective for prevention of pitch squeaking.
	Clayey soil (P and PL)	Be careful when using this part since the soil sets when dried. (Note 1)
	Swamp (PL and PLL)	The part is effective for prevention of snaking of the track. (Prevents side sliding of the track shoes.) (Note 1) The part is effective for prevention of disengagement of the track shoes.
	Slopes	The part is effective for prevention of disengagement of the track shoes. (Prevents side-sliding of the track shoes.)

(Note 1) Although soil and sand tend to enter less, once they enter, they may not be easily discharged depending on the type of soil, so make the choice in consideration of past experience with machines having been used in the subject area and of the working environments of the machine.

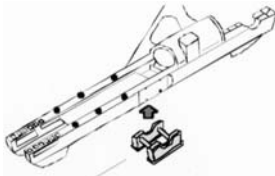
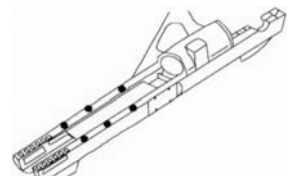
Types	Not full roller guard		
	Center and end section track guard	End section track guard	
Determination criterion for different working environments	 Short length guard for installation at the center section		
	Rocks and soil containing boulders and gravel (A and E)	The part is not suitable	The part is not suitable
	Sand and sandy soil (A, E and P)	No noticeable difference from use of the end-section only track guard	Although sand and soil tend to enter more, they can be easily discharged and this part is being employed.
	Clayey soil (P and PL)	The part is effective for prevention of disengagement or side-sliding of the track shoes	
	Swamp (PL and PLL)		
	Slopes	The part is not suitable	The part is not suitable

NOTE: Please consult your local distributor for availability of track rollers guard for the model that you require.

■ Large Class

When using bulldozers, it is necessary to make most appropriate choices of the track roller guards fitting to respective working environments. Given below are the criterion for the choices.

This chart provides clearer criterion for the choices in consideration of respective functions of different types of track roller guards.

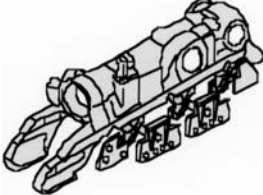
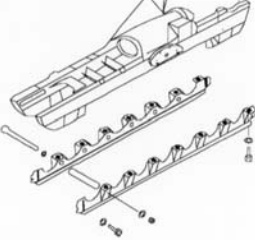
Types	Full roller guard	
	Bogie full roller guard	Split type full roller guard
Determination criterion for different working environments		
Rocks and soil containing boulders and gravel (A and E)	The part is effective for prevention of catching pebbles.	
Sand and sandy soil (A, E and P)	The part is effective for prevention of pitch squeaking.	
Clayey soil (A, E and P)	Be careful when using this part since the soil sets when dried. (Note 1)	
Slopes	The part is effective for prevention of disengagement of the track shoes. (Prevents side-sliding of the track shoes.)	

(Note 1) Although soil and sand tend to enter less, once they enter, they may not be easily discharged depending on the type of soil, so make the choice in consideration of past experience with machines having been used in the subject area and of the working environments of the machine.

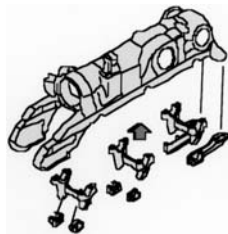
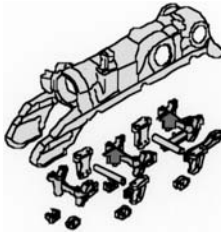
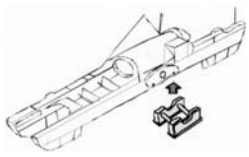
Types	Not full roller guard		
	Bogie roller guard	Add-on full roller guard	Center end section track guard
Determination criterion for different working environments			
Rocks and soil containing boulders and gravel (A and E)	Although sand and soil tend to enter more, they can be easily discharged and this part is being employed.	The part prevents stones from entering between rollers on the rocky soil	The part is not suitable
Sand and sandy soil (A, E and P)	The part is effective for prevention of disengagement or side-sliding of the track shoes.		Although sand and soil tend to enter more, they can be easily discharged and this part is being employed.
Clayey soil (A, E and P)			The part is effective for prevention of disengagement or side-sliding of the track shoes.
Slopes	The part is not suitable		The part is not suitable

NOTE: Please consult your local distributor for availability of track rollers guard for the model that you require.

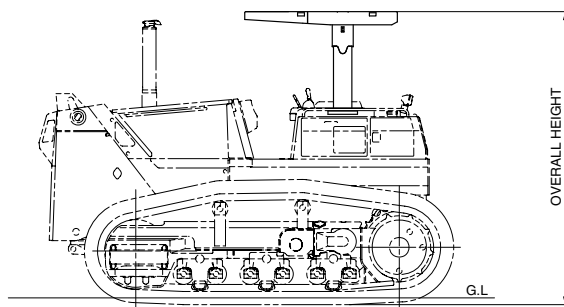

Mode	Item	Weight kg (lb)			Overall height mm (ft.in)		
		Canvas or plastic canopy	*ROPS canopy	*ROPS cab	Canvas or plastic canopy	ROPS canopy	ROPS cab
D21A-8E0	70 (150)	310 (680)	566 (1,250)	2475 (8'1")	2450 (8')	2450 (8')	
D21P-8E0				2500 (8'2")	2475 (8'1")	2475 (8'1")	
D31EX-22	—	310 (680)	650 (1,430)	—	2760 (9'1")	2760 (9'1")	
D31PX-22							
D37EX-22	—	310 (680)	650 (1,430)	—	2760 (9'1")	2760 (9'1")	
D37PX-22							
D37EX-23	—	—	—	—	—	2775 (9'1")	
D37PX-23							
D39EX-22	—	330 (730)	670 (1,480)	—	2825 (9'3")	2825 (9'3")	
D39PX-22							
D39EX-23	—	—	—	—	—	2845 (9'5")	
D39PX-23							
D51EX-22	—	—	1716 (3783)*5	—	—	3002 (9'10")	
D51PX-22							
D61EX-15E0	—	390 (860)***	710 (1,565) ⁴	—	3150 (10'4")	3150 (10'4")	
D61PX-15E0							
D61EX-23	—	—	—	—	—	3180 (10'5")	
D61PX-23							
D63E-12	—	250 (550)	285 (630)	—	3140 (10'4")	3025 (9'11")	
D65E, P-12	140 (310)	420 (930)***	760 (1,675) ⁴	2995 (9'10")	3165 (10'5")	3165 (10'5")	
D65EX-16	—	390 (860)***	810 (1,790) ⁶	—	3155 (10'4")	3155 (10'4")	
D65PX-16							
D65WX-16							
D65EX-17	—	—	—	—	—	3155 (10'4")	
D65PX-17							
D65WX-17							
D85ESS-2A	140 (310)	420 (930)***	760 (1,675) ⁴	2995 (9'10")	3160 (10'4")	3160 (10'4")	
D85EX-15E0	—	437 (970)***	781 (1,730) ⁴	—	3340 (10'11")	3324 (10'11")	
D85EX-15R							
D85PX-15E0							
D85PX-15R							
D155A-5	—	505 (1,110)***	790 (1,740)	—	3500 (11'6")	3500 (11'6")	
D155A-6	—	—	430 (950)	—	3395 (11'2")	3395 (11'2")	
D155AX-6	—	—	700 (1,545)	—	—	3395 (11'2")	
D155AX-7	—	—	1340 (2,954)	—	—	3390 (11'1")	
D275A-5	—	650 (1,430)***	1065 (2,350) ⁴	—	3990 (13'1")	—	
D275A-5R							
D375A-6	—	—	—	—	3990 (13'1")	—	
D375A-6R	—	—	—	—	4230 (13'11")	—	
D275AX-5E0	—	—	1060 (2,340)***	—	4285 (14'1")	—	
D375A-5	—	760 (1,680)***	1175 (2,590) ⁴	—	4285 (14'1")	—	
D375A-5E0	—	—	1270 (2,800)***	—	4235 (13'11")	—	
D475A-5E0	—	—	1395 (3070)***	—	4646 (15'3")	—	
D475ASD-5E0							
D575A-3	—	1970 (4,340)***	2450 (5,400)***	—	4880 (16'0")	—	
D575A-3 SD							

* : With ROPS brackets, except D65-12 and D85ESS-2A

*5 : Include floor sheet and air conditioner

** : With inside power angle-tilt dozer

*6 : Include floor sheet

*** : Two-pole type

*4 : ROPS & steel cab

SECTION 1B

BULLDOZERS

CONTENTS

Blade Selection	1B-2
Blade Availability	1B-4
Blade Specifications:	
Straight Tiltdozer	1B-7
Power-tilt Power-pitch Dozer	1B-9
Angle Dozer	1B-10
Power Angle Tiltdozer	1B-12
Semi-U Tiltdozer	1B-16
Dual Tilt Semi-U Dozer	1B-19
SIGMADOZER, Sigma Power-pitch Dozer	1B-20
U-tilt dozer	1B-22
Super Dozer	1B-25
Coal Dozer	1B-26
Production	1B-27

Straight-tilt dozer

Having a high HP/ cutting edge length, this blade has an aggressive penetration. This blade also has a high HP/loose cubic yards for easy handling of heavy materials. The tilting function of this blade increases production and versatility. With a sturdy construction, this blade is suitable for powerful cutting and dozing, especially heavy cutting on rocky ground.

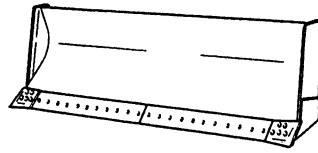
**Straight dozer**

This blade has the same structure and functions but is not equipped with a tilt-cylinder.

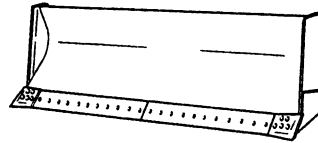
**Angle dozer**

The blade can be set straight or angled to both sides. Plowing earth or snow to one side is possible by angling the blade.

Useful for road construction, back filling etc.

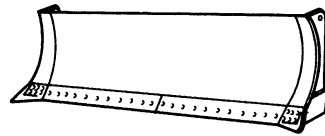
**Power angle-tilt dozer**

Power angling and tilting of the blade are possible from the operator seat. This blade is applicable for versatile works such as grading, back filling, spreading and light land clearing

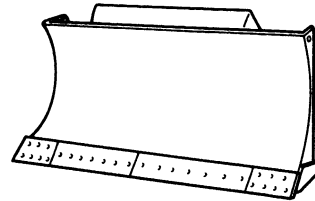
**Dual tilt dozer**

The blade has two tilt cylinders on both sides. An optimum blade cutting angle for all types of materials and ground inclinations can be selected for increased loads and consequently increased production. A fast tilt speed and a large tilt angle also concentrate blade force where maximum penetration is needed.

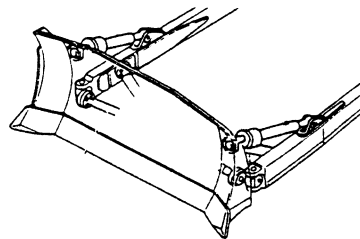
**Semi-U-tilt dozer**

The blade combines penetration ability of straight blade with increased load capacity provided by short wings which include only the end bits.

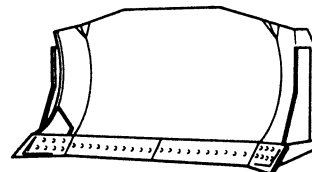

U-tilt dozer

The wings on this blade minimize material spillage. Since this blade has a lower HP/loose cubic yards than a straight-tilt dozer, this blade is suitable for moving lighter or loose materials over long distances. Suitable works are land reclamation, stockpiling and other similar jobs.

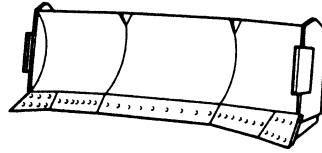
**Coal dozer**

Specialized blade for pushing coal, with larger width and deep angled wings.

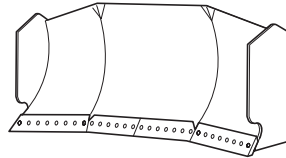
**Rake dozer**

Having teeth, this blade provides good penetration into the soil for removal of stumps, roots and rocks.

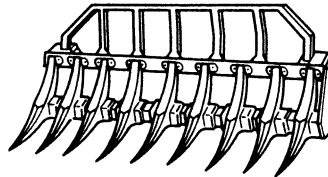
**SIGMADOZER**

A new frontal design concept adopted for digging and rolling up at the center of the blade increases soil holding capacity, simultaneously reducing sideways spillage. Reduced digging resistance produces smoother flow of earth, enabling the dozing of large quantities of soil with less power.

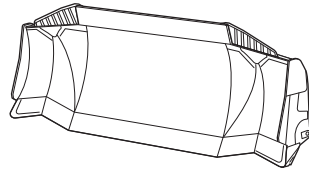

Attachment	Model	D21-8E0		D31-22		D37-22		D37-23		D39-22		D39-23	
		A	P	EX	PX	EX	PX	EX	PX	EX	PX	EX	PX
Straight-tiltdozer													
Strengthened straight-tiltdozer													
Straight dozer													
Strengthened straight dozer													
Angle dozer													
Strengthened angle dozer													
Power angle-tilt dozer		○	○	○	○	○	○	○	○	○	○	○	○
PAT (Narrow blade)									○				○
Wide power angle-tilt dozer													
Mechanical angle power tilt dozer													
Semi-U-tilt dozer													
Strengthened semi-U-tilt dozer													
U-tilt dozer													
Mechanical tilt coal dozer													
Power tilt coal dozer													
Welded type pusher plate													
Bolt-on type pusher plate													
Angle-rakedozer													
Straight-rakedozer													
Shear blade													
Trimming dozer					○								
Straight-rock rake dozer													
Power tilt and pitch dozer													

Attachment	Model	D51-22		D61-15E0		D61-23		D63-12		D65-12	
		EX	PX	EX	PX	EX	PX	E	P	E	P
Straight-tilt dozer								○		○	○
Strengthened straight-tilt dozer											
Straight dozer											
Strengthened straight dozer											
Angle dozer										○	
Strengthened angle dozer										○	
Power angle-tilt dozer		○	○	○	○	○	○				
Wide power angle-tilt dozer		○		○							
Mechanical angle power tilt dozer											
Semi-U-tilt dozer				○				○		○	
Strengthened semi-U-tilt dozer											
U-tilt dozer											
Strengthened U-tilt dozer											
Mechanical tilt coal dozer											
Power tilt coal dozer											
Welded type pusher plate											
Bolt-on type pusher plate											
Angle-rake dozer											
Straight-rake dozer										○	
Shear blade											
Trimming dozer								○		○	
Straight rock rake dozer											
Semi-U-dual tilt dozer											
Strengthened semi-U-dual tilt dozer											
U-dual tilt dozer											
Strengthened U-dual tilt dozer											
Power tilt power pitch dozer											○
SIGMADOZER											
Sigma power-pitch dozer											

Attachment	Model	D65-16		D65-17			D68-12	D85-2
		EX	PX	EX	PX	WX	ESS	ESS
Straight-tiltdozer		○	○	○	○			
Strengthened straight-tiltdozer								
Straight dozer								
Strengthened straight dozer								
Angle dozer		○		○			○	○
Strengthened angle dozer								
Power angle-tilt dozer		○	○	○	○	○	○	
Wide power angle-tilt dozer								
Mechanical angle power tilt dozer								
Semi-U-tilt dozer		○						
Strengthened semi-U-tilt dozer								
U-tilt dozer								
Strengthened U-tilt dozer								
Mechanical tilt coal dozer								
Power tilt coal dozer								
Welded type pusher plate								
Bolt-on type pusher plate								
Angle-rake dozer								
Straight-rake dozer								
Shear blade								
Trimming dozer								
Straight rock rake dozer								
Semi-U-dual tilt dozer								
Strengthened semi-U-dual tilt dozer								
U-dual tilt dozer								
Strengthened U-dual tilt dozer								
Power tilt power pitch dozer			○		○			
SIGMADOZER		○		○		○		
Sigma power-pitch dozer		○		○		○		

Attachment	Model	D85-15E0 D85-15R		D155-5	D155-6		D155-7	D275-5	D275-5E0	
		ESS	EX	PX	A	A	AX	AX	A	AX
Straight-tiltdozer		○	○	○						
Strengthened straight-tiltdozer										
Straight dozer										
Strengthened straight dozer										
Angle dozer		○	○		○	○	○			
Strengthened angle dozer										
Power angle-tilt dozer										
Mechanical angle power tilt dozer			○							
Semi-U-tilt dozer		○	○		○	○	○	○	○	○
Strengthened semi-U-tilt dozer					○	○	○	○	○	○
U-tilt dozer					○	○	○	○	○	○
Strengthened U-tilt dozer					○	○	○	○	○	○
Mechanical tilt coal dozer										
Power tilt coal dozer					○	○	○			
Welded type pusher plate					○	○	○	○	○	○
Bolt-on type pusher plate										
Angle-rake dozer										
Straight-rake dozer					○					
Shear Blade										
Trimming dozer			○							
Straight rock rake dozer					○			○		
Semi-U-dual tilt dozer							○	○	○	
Strengthened semi-U-dual tilt dozer							○	○	○	
U-dual tilt dozer							○	○	○	
Strengthened U-dual tilt dozer							○	○	○	
Super dozer										
SIGMADOZER						○	○	○**		
Strengthened SIGMADOZER						○	○	○**		
Dual SIGMADOZER						○	○	○**		
Strengthened dual SIGMADOZER							○	○		○

Attachment	Model	D275-5R	D375-5	D375-5R	D375-6R D375-6		D475-5E0		D575-3	
		A	A	A	A	A	A	A-5SD	A	A-3SD
Semi-U-tilt dozer		○	○	○	○				○	
Strengthened semi-U-tilt dozer		○	○	○	○		○		○	
U-tilt dozer		○	○	○					○	
Strengthened U-tilt dozer		○	○	○	○*		○		○	
Mechanical tilt coal dozer										
Power tilt coal dozer							○			
Welded type pusher plate		○	○	○	○		○			
Bolt-on type pusher plate										
Angle-rake dozer										
Straight-rake dozer										
Shear Blade										
Trimming dozer										
Straight rock rake dozer		○								
Dual tilt semi-U-dozer		○	○	○	○				○	
Strengthened dual tilt semi-U-dozer		○	○	○	○		○		○	
U-dual tilt dozer		○	○	○					○	
Strengthened dual tilt U-dozer		○	○	○	○*		○		○	
Super dozer								○		○
SIGMADOZER										
Strengthened SIGMADOZER		○								
Dual SIGMADOZER										
Strengthened dual SIGMADOZER		○								

* : With spill guard

** : These are available as optional settings, but strengthened dual SIGMADOZER is recommended.

Blade Specifications Straight Tiltdozer

BULLDOZERS

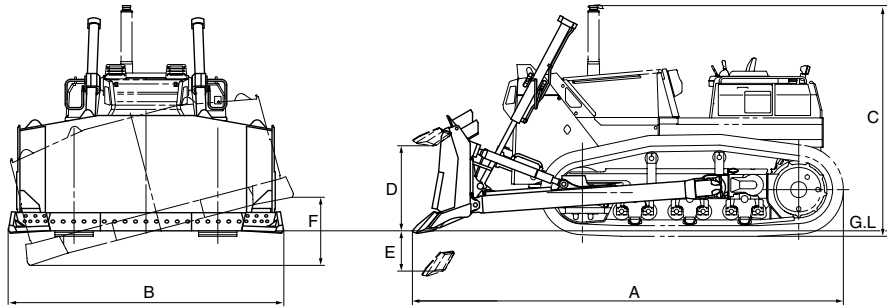

Item		Model	D63E-12***	D65E-12	D65P-12	D65EX-16	
OPERATING WEIGHT*		kg (lb)	16615 (36,630)	17620 (38,850)	18970 (41,820)	19180 (42,280)	
BLADE CAPACITY		LH2** SAE	m ³ (yd ³)	3.87 (5.06) 3.00 (3.92)	5.12 (6.70) 3.89 (5.09)	4.80 (6.28) 3.69 (4.83)	5.12 (6.70) 3.89 (5.09)
DIMENSION*							
A	Overall length	mm (ft.in)	5065 (16'7")	5260 (17'3")	5550 (18'3")	5420 (17' 9")	
B	Overall width	mm (ft.in)	3200 (10'6")	3415 (11'2")	3970 (13')	3415 (11' 2")	
C	Overall height	mm (ft.in)	2765 (9'1")	2980 (9'9")	3025 (9'11")	3155 (10'4")	
	Ground pressure	kg/cm ² (PSI)	0.54 (7.67)	0.65 (9.24)	0.32 (4.55)	0.63 (8.98)	
DOZER EQUIPMENT							
	Weight (Includes hydraulic control unit)	kg (lb)	1970 (4,340)	2600 (5,730)	2620 (5,780)	2060 (4540)	
	Length	mm (ft.in)	3200 (10'6")	3415 (11'2")	3970 (13')	3415 (11' 2")	
	Height	mm (ft.in)	1100 (3'7")	1225 (4'1")	1100 (3'7")	1225 (4'0")	
D	Max. lift above ground	mm (ft.in)	1005 (3'4")	1100 (3'7")	1200 (3'11")	1100 (3' 7")	
E	Max. drop below ground	mm (ft.in)	460 (1'6")	450 (1'6")	445 (1'6")	435 (1' 5")	
F	Max. tilting adjustment	mm (ft.in)	600 (2'3")	870 (2'10")	890 (2'11")	870 (2'10")	
	Digging angle	degree	56	55	57	55	
UPPER ATTACHMENT			-	-	-	ROPS cab	

Item		Model	D65PX-16	D65EX-17	D65PX-17	D85ESS-2A	
OPERATING WEIGHT*		kg (lb)	20990 (46,270)	19350 (42,660)	21160 (46,650)	18230 (40,190)	
BLADE CAPACITY		LH2** SAE	m ³ (yd ³)	4.80 (6.28) 3.69 (4.83)	5.12 (6.70) 3.89 (5.09)	4.80 (6.28) 3.69 (4.83)	6.1 (7.98) 4.4 (5.76)
DIMENSION*							
A	Overall length	mm (ft.in)	5825 (19'1")	5330 (17'6")	5680 (18'8")	5615 (18'5")	
B	Overall width	mm (ft.in)	3970 (13'0")	3415 (11'2")	3970 (13'0")	3620 (11'11")	
C	Overall height	mm (ft.in)	3155 (10'4")	3155 (10'4")	3155 (10'4")	2980 (9'9")	
	Ground pressure	kg/cm ² (PSI)	0.35 (4.98)	0.64 (9.10)	0.35 (4.98)	0.60 (8.53)	
DOZER EQUIPMENT							
	Weight (Includes hydraulic control unit)	kg (lb)	2100 (4,630)	2060 (4,540)	2100 (4,630)	2810 (6,190)	
	Length	mm (ft.in)	3970 (13'0")	3415 (11'2")	3970 (13'0")	3620 (11'11")	
	Height	mm (ft.in)	1100 (3'7")	1225 (4'0")	1100 (3'7")	1295 (4'3")	
D	Max. lift above ground	mm (ft.in)	1125 (3'8")	1100 (3'7")	1125 (3'8")	1070 (3'6")	
E	Max. drop below ground	mm (ft.in)	540 (1'9")	435 (1'5")	540 (1'9")	590 (1'11")	
F	Max. tilting adjustment	mm (ft.in)	890 (2'11")	870 (2'10")	890 (2'11")	920 (3')	
	Digging angle	degree	55	55	55	55	
UPPER ATTACHMENT			ROPS cab	ROPS cab	ROPS cab	-	

* : Including dozer equipment in addition to bare tractor, excluding ROPS and cab

** : L: Blade length H: Blade height

*** : for Russia

Blade Specifications Straight Tiltdozer

BULLDOZERS

Item		Model	D85EX-15E0	D85EX-15R	D85PX-15E0	D85PX-15R
OPERATING WEIGHT*		kg (lb)	24550 (54,120)	24450 (53,900)	26870 (59,240)	26780 (59,040)
BLADE CAPACITY LH2** SAE		m ³ (yd ³)	7.66 (10.02) 5.2 (6.8)	7.66 (10.02) 5.2 (6.8)	8.19 (10.72) 5.9 (7.7)	8.19 (10.72) 5.9 (7.7)
DIMENSION*						
A	Overall length	mm (ft.in)	5640 (18'6")	5640 (18'6")	6065 (19'11")	6065 (19'11")
B	Overall width	mm (ft.in)	3715 (12'2")	3715 (12'2")	4365 (14'4")	4365 (14'4")
C	Overall height	mm (ft.in)	3330 (10'11")	3330 (10'11")	3330 (10'11")	3330 (10'11")
	Ground pressure	kg/cm ² (PSI)	0.72 (10.21)	0.72 (10.21)	0.42 (6.03)	0.42 (5.97)
DOZER EQUIPMENT						
	Weight (Includes hydraulic control unit)	kg (lb)	3329 (7,343)	3329 (7,343)	3366 (7,421)	3366 (7,421)
	Length	mm (ft.in)	3715 (12'2")	3715 (12'2")	4365 (14'4")	4365 (14'4")
	Height	mm (ft.in)	1436 (4'9")	1436 (4'9")	1370 (4'6")	1370 (4'6")
D	Max. lift above ground	mm (ft.in)	1210 (4')	1210 (4')	1230 (4')	1230 (4'0")
E	Max. drop below ground	mm (ft.in)	540 (1'9")	540 (1'9")	570 (1'10")	570 (1'10")
F	Max. tilting adjustment	mm (ft.in)	750 (2'6")	750 (2'6")	500 (1'8")	500 (1'8")
	Digging angle	degree	55	55	55	55
UPPER ATTACHMENT			-	-	-	-

* : Including dozer equipment in addition to bare tractor, excluding ROPS and cab

** : L: Blade length H: Blade height

*** : for Russia

Blade Specifications Power-tilt Power-pitch Dozer

BULLDOZERS

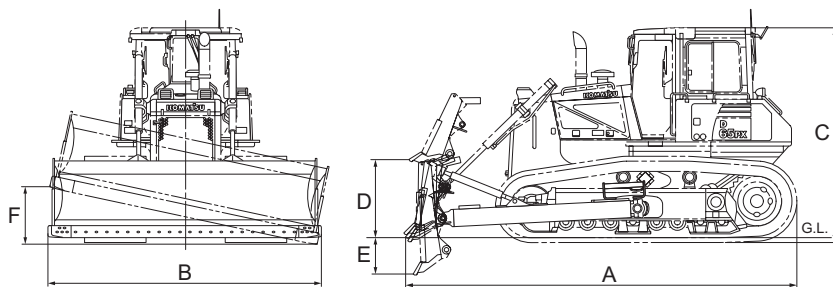

FVBH0456

Item		Model	D65P-12	D65PX-16	D65PX-17	
OPERATING WEIGHT*		kg (lb)	19670 (43,360)	21050 (46,410)	21220 (46,780)	
BLADE CAPACITY LH2** SAE		m ³ (yd ³)	4.80 (6.28) 3.69 (4.83)	4.80 (6.28) 3.69 (4.83)	4.80 (6.28) 3.69 (4.83)	
DIMENSION*						
A	Overall length	mm (ft.in)	5520 (18'1")	5680 (18'8")	5825 (19'1")	
B	Overall width	mm (ft.in)	3970 (13'0")	3970 (13'0")	3970 (13'0")	
C	Overall height	mm (ft.in)	2990 (9'10")	3155 (10'4")	3155 (10'4")	
	Ground pressure	kg/cm ² (PSI)	0.33 (4.69)	0.35 (4.98)	0.35 (4.98)	
DOZER EQUIPMENT						
D E F	Weight (Includes hydraulic control unit)	kg (lb)	2730 (6,020)	2160 (4,760)	2160 (4,760)	
	Length	mm (ft.in)	3970 (13'0")	3970 (13'0")	3970 (13'0")	
	Height	mm (ft.in)	1100 (3'7")	1100 (3'7")	1100 (3'7")	
	Max. lift above ground	mm (ft.in)	1105 (3'8")	1125 (3'8")	1125 (3'8")	
	Max. drop below ground	mm (ft.in)	540 (1'9")	540 (1'9")	540 (1'9")	
	Max. tilting adjustment Digging angle (Available stepless angle adjustment)	mm (ft.in) degree	890 (2'11") 50 to 66	890 (2'11") 49 to 61	890 (2'11") 55	
UPPER ATTACHMENT		-	-	ROPS cab	ROPS cab	

* : Including dozer equipment in addition to bare tractor, excluding ROPS and cab

** : L: Blade length H: Blade height

Blade Specifications Angle Dozer

BULLDOZERS

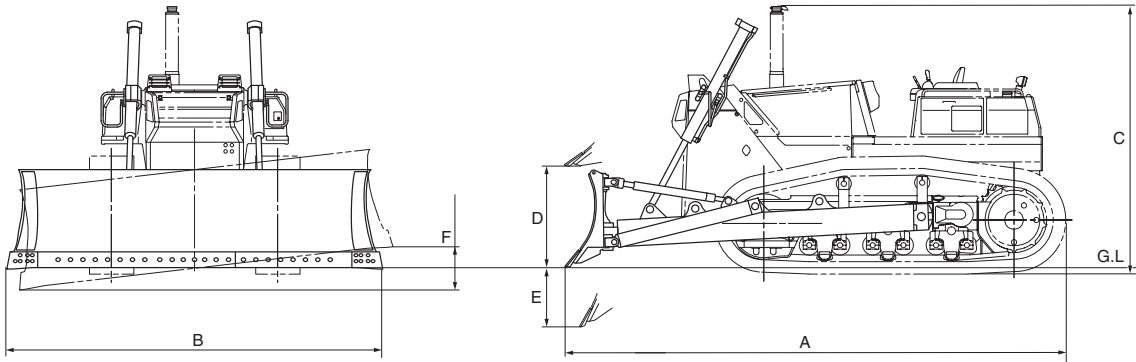

Item		Model	D65E-12	D65EX-16	D65EX-17	D68ESS-12
OPERATING WEIGHT*		kg (lb)	17690 (39,000)	19320 (42,590)	19490 (42,970)	16940 (37,350)
BLADE CAPACITY						
LH2**		m ³ (yd ³)	4.80 (6.28)	4.80 (6.28)	4.80 (6.28)	3.6 (4.71)
SAE			3.55 (4.64)	3.55 (4.64)	3.55 (4.64)	2.6 (3.40)
DIMENSION*						
A	Overall length	mm (ft.in)	5470 (17'11")	5630 (18'6")	5540 (18'2")	5930 (19'5")
B	Overall width	mm (ft.in)	3970 (13')	3970 (13'0")	3970 (13'0")	3970 (13')
C	Overall height	mm (ft.in)	2980 (9'9")	3155 (10'4")	3155 (10'4")	3140 (10'4")
	Ground pressure	kg/cm ² (PSI)	0.65 (9.2)	0.64 (9.10)	0.64 (9.10)	0.54 (7.68)
DOZER EQUIPMENT						
	Weight (Includes hydraulic control unit)	kg(lb)	2820 (6,220) 2930 (6,460)	2200 (4,850)	2200 (4,850)	2660 (5,860)
	Length	mm (ft.in)	3970 (13')	3970 (13'0")	3970 (13'0")	3970 (13')
	Height	mm (ft.in)	1100 (3'7")	1100 (3'7")	1100 (3'7")	950 (3'1")
D	Max. lift above ground	mm (ft.in)	1180 (3'10")	1175 (3'10")	1175 (3'10")	1205 (3'11")
E	Max. drop below ground	mm (ft.in)	460 (1'6")	445 (1'6")	445 (1'6")	535 (1'9")
F	Max. tilting adjustment	mm (ft.in)	400 (1'4")	400 (1'4")	400 (1'4")	400 (1'4")
	Digging angle	degree	56.5	56	56	55
UPPER ATTACHMENT		-	-	ROPS cab	ROPS cab	-

Item		Model	D85ESS-2	D85ESS-2A	D85EX-15E0	D85EX-15R
OPERATING WEIGHT*		kg (lb)	19170 (42,260)	18850 (41,560)	24804 (54,680)	24704 (54,460)
BLADE CAPACITY						
LH2**		m ³ (yd ³)	5.0 (6.54)	5.0 (6.54)	5.8 (7.6)	5.8 (7.6)
SAE			3.4 (4.45)	3.4 (4.45)	4.0 (5.2)	4.0 (5.2)
DIMENSION*						
A	Overall length	mm (ft.in)	5930 (19'5")	5930 (19'5")	6035 (19'10")	6035 (19'10")
B	Overall width	mm (ft.in)	4370 (14'4")	4370 (14'4")	4515 (14'10")	4515 (14'10")
C	Overall height	mm (ft.in)	2560 (8'5")	2980 (9'9")	3330 (10'11")	3330 (10'11")
	Ground pressure	kg/cm ² (PSI)	0.52 (7.39)	0.62 (8.82)	0.73 (10.39)	0.72 (10.24)
DOZER EQUIPMENT						
	Weight (Includes hydraulic control unit)	kg (lb)	2890 (6,370)	3430 (7,560)	3584 (7,900)	3584 (7,900)
	Length	mm (ft.in)	4370 (14'4")	4370 (14'4")	4515 (14'10")	4515 (14'10")
	Height	mm (ft.in)	1070 (3'6")	1070 (3'6")	1130 (3'8")	1130 (3'8")
D	Max. lift above ground	mm (ft.in)	1255 (4'1")	1255 (4'1")	1170 (3'10")	1170 (3'10")
E	Max. drop below ground	mm (ft.in)	485 (1'7")	485 (1'7")	755 (2'6")	755 (2'6")
F	Max. tilting adjustment	mm (ft.in)	400 (1'4")	400 (1'4")	520 (1'8")	520 (1'8")
	Digging angle	degree	56	56	55	55
UPPER ATTACHMENT		-	-	-	-	-

* : Including dozer equipment in addition to bare tractor, excluding ROPS and cab

** : L: Blade length H: Blade height

Blade Specifications Angle Dozer

BULLDOZERS

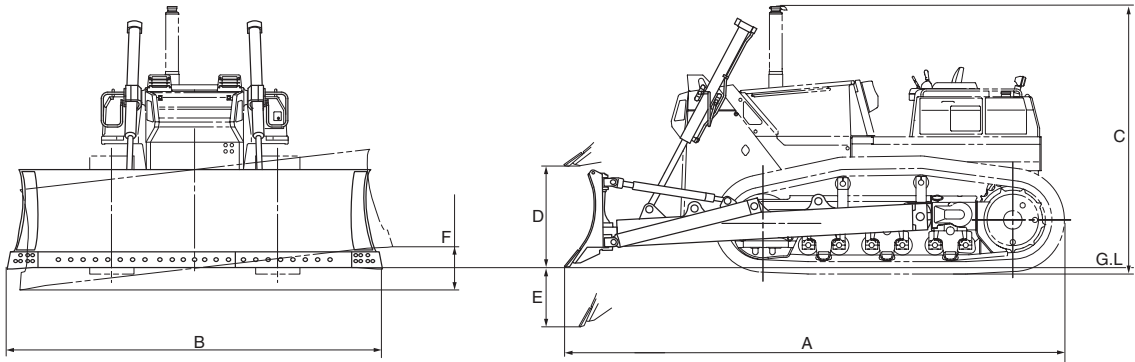

Item		Model	D155A-5	D155AX-6	D155A-6	
OPERATING WEIGHT*		kg (lb)	33040 (72,840)	36170 (79,750)	37470 (82,610)	
BLADE CAPACITY LH2** SAE		m ³ (yd ³)	7.04 (9.21) 4.9 (6.4)	7.04 (9.21) 4.6 (6.0)	6.64 (8.69) 4.6 (6.0)	
DIMENSION*						
A	Overall length	mm (ft.in)	6502 (21'4")	6743 (22'1")	6580 (21'7")	
B	Overall width	mm (ft.in)	4850 (15'11")	4850 (15'11")	4850 (15'11")	
C	Overall height	mm (ft.in)	3395 (11'2")	3385 (11'1")	3385 (11'1")	
	Ground pressure	kg/cm ² (PSI)	0.92 (13.1)	0.99 (14.02)	1.06 (15.07)	
DOZER EQUIPMENT						
	Weight (Includes hydraulic control unit)	kg (lb)	5140 (11,330)	5170 (11,400)	5170 (11,400)	
	Length	mm (ft.in)	4850 (15'11")	4850 (15'11")	4850 (15'11")	
	Height	mm (ft.in)	1205 (3'11")	1205 (3'11")	1170 (3'10")	
D	Max. lift above ground	mm (ft.in)	1295 (4'3")	1562 (5'1")	1560 (5'1")	
E	Max. drop below ground	mm (ft.in)	745 (2'5")	664 (2'2")	660 (2'2")	
F	Max. tilting adjustment	mm (ft.in)	520 (1'8")	520 (1'8")	520 (1'8")	
	Digging angle	degree	55	56	56	
UPPER ATTACHMENT			-	-	-	

* : Including dozer equipment in addition to bare tractor, excluding ROPS and cab

** : L: Blade length H: Blade height

Blade Specifications Power Angle Tiltdozer

BULLDOZERS

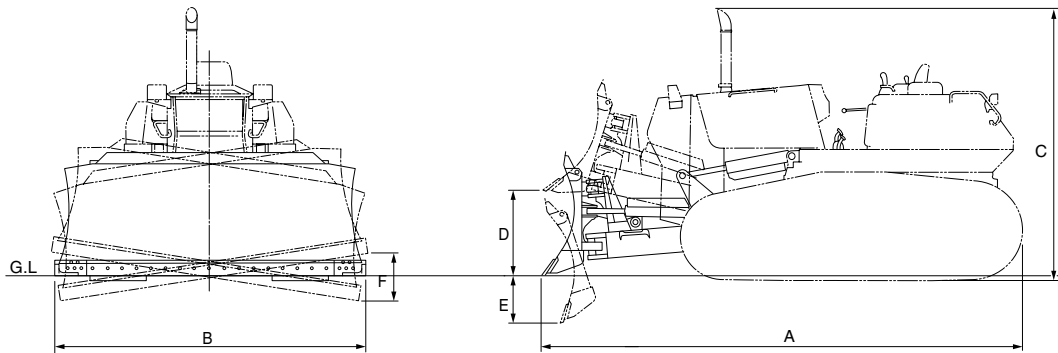

Item		Model	D21A-8E0	D21P-8E0	D31EX-22	D31PX-22
OPERATING WEIGHT*		kg (lb)	3710 (8,180)	4100 (9,040)	7670 (16,910)	8130 (17,930)
BLADE CAPACITY LH2** SAE		m ³ (yd ³)	0.76 (0.99) 0.57 (0.75)	0.89 (1.16) 0.68 (0.89)	1.80 (2.35) 1.61 (2.11)	1.83 (2.39) 1.61 (2.11)
DIMENSION*						
A	Overall length	mm (ft.in)	3250 (10'8")	3260 (10'8")	4175 (13'8")	4155 (13'8")
B	Overall width	mm (ft.in)	2170 (7'11")	2560 (8'5")	2550 (8'4")	3250 (10'8")
C	Overall height	mm (ft.in)	2315 (7'7")	2335 (7'8")	2760 (9'1")	2760 (9'1")
	Ground pressure	kg/cm ² (PSI)	0.37 (5.26)	0.24 (3.41)	0.44 (6.26)	0.31 (4.41)
DOZER EQUIPMENT						
	Type		Inside mount	Inside mount	Inside mount	Inside mount
	Weight (Includes hydraulic control unit)	kg (lb)	550 (1,210)	580 (1280)	1100 (2,430)	1220 (2,690)
	Length	mm (ft.in)	2170 (7'11")	2560 (8'5")	2550 (8'4")	3250 (10'8")
	Height	mm (ft.in)	590 (1'11")	590 (1'11")	840 (2'9")	750 (2'6")
D	Max. lift above ground	mm (ft.in)	790 (2'7")	850 (2'9")	870 (2'10")	860 (2'10")
E	Max. drop below ground	mm (ft.in)	385 (1'3")	325 (1'1")	390 (1'3")	380 (1'3")
F	Max. tilting adjustment	mm (ft.in)	250 (9'8")	280 (11")	350 (1'2")	440 (1'5")
	Angling angle (L/R)	degree	25/25	25/25	25/25	25/25
UPPER ATTACHMENT			-	-	ROPS canopy	ROPS canopy

Item		Model	D37EX-22	D37PX-22	D37EX-23	D37PX-23
OPERATING WEIGHT*		kg (lb)	7890 (17,400)	8240 (18,170)	8340 (18,390)	8640 (19,050)
BLADE CAPACITY LH2** SAE		m ³ (yd ³)	2.00 (2.62) 1.77 (2.32)	2.24 (3.52) 1.95 (2.55)	2.03 (2.66) 1.91 (2.50)	2.23 (2.92) 2.13 (2.79)
DIMENSION*						
A	Overall length	mm (ft.in)	4190 (13'9")	4175 (13'8")	4275 (14'0")	4275 (14'0")
B	Overall width	mm (ft.in)	2710 (8'11")	3250 (10'8")	2710 (8'11")	3200 (10'6")
C	Overall height	mm (ft.in)	2760 (9'1")	2760 (9'1")	2775 (9'1")	2775 (9'1")
	Ground pressure	kg/cm ² (PSI)	0.44 (6.26)	0.31 (4.41)	0.47 (6.68)	0.32 (4.55)
DOZER EQUIPMENT						
	Type		Inside mount	Inside mount	Inside mount	Inside mount
	Weight (Includes hydraulic control unit)	kg (lb)	1180 (2,600)	1250 (2,760)	1040 (2,290)	1060 (2,340)
	Length	mm (ft.in)	2710 (8'11")	3250 (10'8")	2710 (8'11")	3200 (10'6")
	Height	mm (ft.in)	860 (2'10")	830 (2'9")	865 (2'10")	835 (2'9")
D	Max. lift above ground	mm (ft.in)	880 (2'11")	870 (2'10")	880 (2'11")	880 (2'11")
E	Max. drop below ground	mm (ft.in)	400 (1'4")	390 (1'3")	390 (1'3")	390 (1'3")
F	Max. tilting adjustment	mm (ft.in)	370 (1'3")	440 (1'5")	370 (1'3")	435 (1'5")
	Angling angle (L/R)	degree	25/25	25/25	24/24	24/24
UPPER ATTACHMENT			ROPS canopy	ROPS canopy	ROPS cab	ROPS cab

* : Including dozer equipment in addition to bare tractor, excluding ROPS and cab

** : L: Blade length H: Blade height

*** : Wide blade

*4 : Brazil source

*5 : Mechanical angle-tiltadozer

Blade Specifications Power Angle Tiltdozer

BULLDOZERS

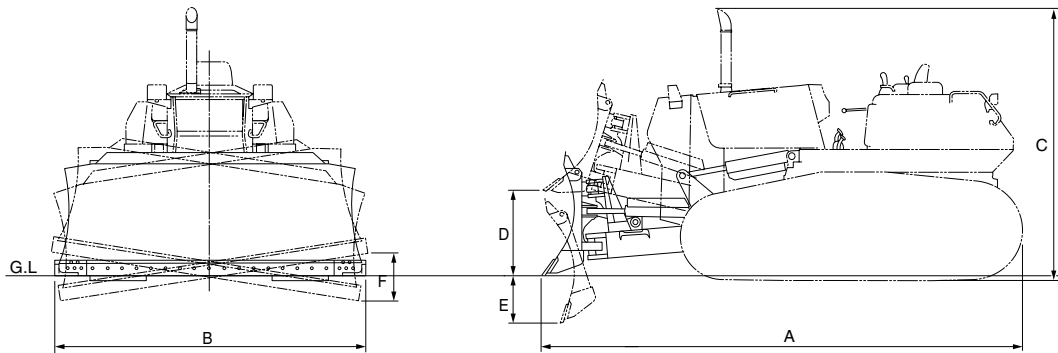

Item		Model	D37PX-23	D39EX-22	D39PX-22	D39EX-23	
OPERATING WEIGHT*		kg (lb)	8610 (18,980)	9040 (19,930)	9480 (20,900)	9270 (20,440)	
BLADE CAPACITY		LH2** SAE	m ³ (yd ³)	2.00 (2.62) 2.13 (2.79)	2.60 (3.40) 2.21 (2.89)	2.69 (3.52) 2.30 (3.00)	2.60 (3.40) 2.21 (2.89)
DIMENSION*							
A	Overall length	mm (ft.in)	4275 (14'0")	4335 (14'3")	4335 (13'3")	4385 (14'5")	
B	Overall width	mm (ft.in)	2875 (9'5")	2710 (8'11")	3250 (10'8")	2710 (8'11")	
C	Overall height	mm (ft.in)	2775 (9'1")	2835 (9'4")	2835 (9'4")	2845 (9'4")	
	Ground pressure	kg/cm ² (PSI)	0.32 (4.55)	0.42 (5.97)	0.32 (4.55)	0.43 (6.11)	
DOZER EQUIPMENT							
	Type		Narrow Blade Inside mount	Inside mount	Inside mount	Inside mount	
	Weight (Includes hydraulic control unit)	kg (lb)	1030 (2,270)	1240 (2,730)	1320 (2,910)	1110 (2,450)	
	Length	mm (ft.in)	2875 (9'5")	2710 (8'11")	3350 (11'0")	2710 (8'11")	
	Height	mm (ft.in)	835 (2'9")	980 (3'3")	910 (3'0")	980 (3'3")	
D	Max. lift above ground	mm (ft.in)	880 (2'11")	900 (2'11")	900 (2'11")	910 (3'0")	
E	Max. drop below ground	mm (ft.in)	390 (1'3")	450 (1'6")	450 (1'6")	450 (1'6")	
F	Max. tilting adjustment	mm (ft.in)	390 (1'3")	370 (1'3")	440 (1'5")	365 (1'2")	
	Angling angle (L/R)	degree	24/24	25/25	25/25	25/25	
UPPER ATTACHMENT			ROPS cab	ROPS canopy	ROPS canopy	ROPS cab	

Item		Model	D39PX-23	D39PX-23	D51EX-22	D51EX-22***	
OPERATING WEIGHT*		kg (lb)	9690 (21,360)	9645 (21,260)	12720 (28,040)	12820 (28,260)	
BLADE CAPACITY		LH2** SAE	m ³ (yd ³)	2.69 (3.52) 2.40 (3.14)	2.69 (3.52) 2.40 (3.14)	3.75 (4.91) 2.70 (3.53)	4.13 (5.4) 2.90 (3.8)
DIMENSION*							
A	Overall length	mm (ft.in)	4385 (14'5")	4385 (14'5")	4800 (15'8")	4800 (15'8")	
B	Overall width	mm (ft.in)	3250 (10'8")	3250 (10'8")	3045 (10'0")	3350 (10'0")	
C	Overall height	mm (ft.in)	2845 (9'4")	2845 (9'4")	3002 (9'10")	3002 (9'10")	
	Ground pressure	kg/cm ² (PSI)	0.33 (4.69)	0.33 (4.69)	0.45 (6.40)	0.46 (6.54)	
DOZER EQUIPMENT							
	Type		Inside mount	Narrow Blade Inside mount	Inside mount	Inside mount	
	Weight (Includes hydraulic control unit)	kg (lb)	1160 (2,560)	1115 (2,460)	1500 (3,310)	1600 (3,530)	
	Length	mm (ft.in)	3250 (10'8")	2980 (9'9")	3045 (10'0")	3350 (10'0")	
	Height	mm (ft.in)	910 (3'0")	910 (3'0")	1110 (3'8")	1110 (3'8")	
D	Max. lift above ground	mm (ft.in)	910 (3'0")	910 (3'0")	1107 (3'8")	1107 (3'8")	
E	Max. drop below ground	mm (ft.in)	450 (1'6")	450 (1'6")	456 (1'6")	456 (1'6")	
F	Max. tilting adjustment	mm (ft.in)	440 (1'5")	405 (1'4")	459 (1'6")	505 (1'8")	
	Angling angle (L/R)	degree	25/25	25/25	28.5/28.5	28.5/28.5	
UPPER ATTACHMENT		ROPS cab	ROPS cab	ROPS cab	ROPS cab	ROPS cab	

- * : Including dozer equipment in addition to bare tractor, excluding ROPS and cab
- ** : L: Blade length H: Blade height
- *** : Wide blade
- *4 : Brazil source
- *5 : Mechanical angle-tilt dozer

Blade Specifications Power Angle Tiltdozer

BULLDOZERS

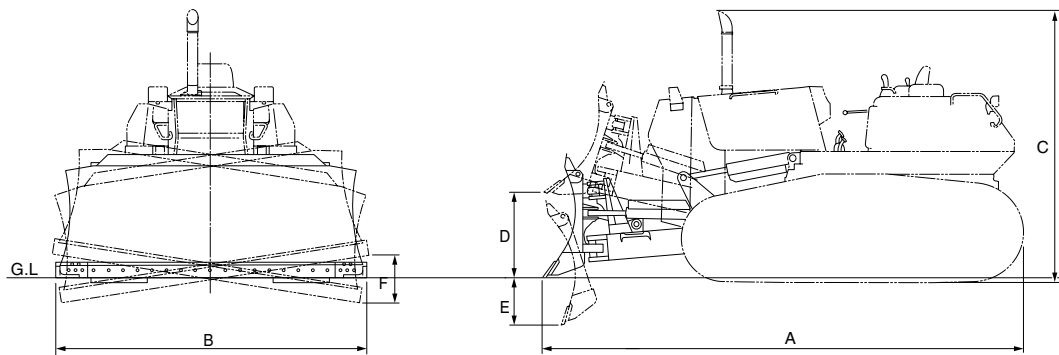

Item		Model	D51PX-22	D51EX-22*4	D61EX-15E0	D61EX-15E0***
OPERATING WEIGHT*		kg (lb)	13220 (29,150)	14000 (30,860)	16320 (35,980)	16480 (36,330)
BLADE CAPACITY LH2** SAE		m ³ (yd ³)	4.13 (5.4) 2.90 (3.8)	3.8 (5.0) 2.90 (3.8)	4.7 (6.1) 3.4 (4.4)	5.19 (6.79) 3.8 (5.0)
DIMENSION*						
A	Overall length	mm (ft.in)	4800 (15'8")	4795 (15'9")	5030 (16'6")	5030 (16'6")
B	Overall width	mm (ft.in)	3350 (10'0")	3350 (10'0")	3275 (10'9")	3860 (12'6")
C	Overall height	mm (ft.in)	3002 (9'10")	3015 (9'11")	3025 (9'11")	3025 (9'11")
	Ground pressure	kg/cm ² (PSI)	0.34 (4.82)	0.50 (7.11)	0.52 (7.39)	0.53 (7.54)
DOZER EQUIPMENT						
	Type		Inside mount	Inside mount	Inside mount	Inside mount
	Weight (Includes hydraulic control unit)	kg (lb)	1600 (3,530)	1600 (3,530)	2400 (5,290)	2560 (5,640)
	Length	mm (ft.in)	3350 (10'0")	3350 (10'0")	3275 (10'9")	3860 (12'8")
	Height	mm (ft.in)	1110 (3'8")	1110 (3'8")	1200 (3'11")	1160 (3'10")
D	Max. lift above ground	mm (ft.in)	1107 (3'8")	1107 (3'8")	980 (3'3")	980 (3'3")
E	Max. drop below ground	mm (ft.in)	456 (1'6")	461 (1'6")	465 (1'6")	465 (1'6")
F	Max. tilting adjustment	mm (ft.in)	505 (1'8")	505 (1'8")	510 (1'8")	600 (2'0")
	Angling angle (L/R)	degree	28.5/28.5	28.5/28.5	25/25	25/25
UPPER ATTACHMENT			ROPS cab	ROPS cab	-	-

Item		Model	D61PX-15E0	D61EX-23	D61PX-23	D65EX-16
OPERATING WEIGHT*		kg (lb)	18320 (40,390)	17700 (39,020)	18580 (40,960)	20990 (46,270)
BLADE CAPACITY LH2** SAE		m ³ (yd ³)	5.19 (6.79) 3.8 (5.0)	4.64 (6.07) 3.40 (4.45)	5.15 (6.74) 3.80 (4.97)	4.25 (5.56)
DIMENSION*						
A	Overall length	mm (ft.in)	5465 (17'11")	5480 (18'0")	5480 (18'0")	5790 (19'0")
B	Overall width	mm (ft.in)	3860 (12'8")	3250 (10'8")	3860 (12'8")	3870 (12'8")
C	Overall height	mm (ft.in)	3025 (9'11")	3180 (10'5")	3180 (10'5")	3155 (10'4")
	Ground pressure	kg/cm ² (PSI)	0.34 (4.83)	0.47 (6.68)	0.34 (4.83)	0.63 (8.96)
DOZER EQUIPMENT						
	Type		Inside mount	Inside mount	Inside mount	Inside mount
	Weight (Includes hydraulic control unit)	kg (lb)	2700 (5,950)	2170 (4,780)	2330 (5,140)	2960 (6,530)
	Length	mm (ft.in)	3860 (12'8")	3250 (10'8")	3860 (12'8")	3870 (12'8")
	Height	mm (ft.in)	1160 (3'10")	1195 (3'11")	1155 (3'9")	1235 (4'1")
D	Max. lift above ground	mm (ft.in)	1025 (3'4")	1025 (3'4")	1025 (3'4")	1165 (3'10")
E	Max. drop below ground	mm (ft.in)	580 (1'11")	580 (1'11")	580 (1'11")	700 (2'4")
F	Max. tilting adjustment	mm (ft.in)	600 (2'0")	435 (1'5")	515 (1'8")	500 (1'8")
	Angling angle (L/R)	degree	25/25	24/24	24/24	25/25
UPPER ATTACHMENT		ROPS cab	-	ROPS cab	ROPS cab	ROPS cab

* : Including dozer equipment in addition to bare tractor, excluding ROPS and cab

** : L: Blade length H: Blade height

*** : Wide blade

*4 : Brazil source

*5 : Mechanical angle-tilt dozer

Blade Specifications Power Angle Tiltdozer

BULLDOZERS

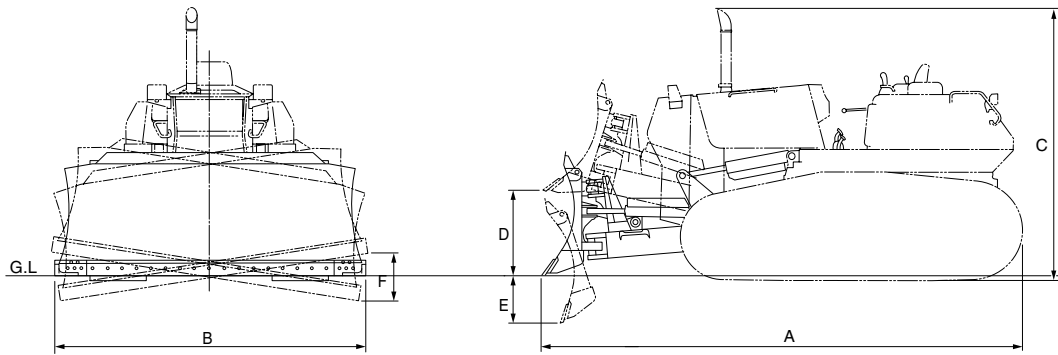

Item		Model	D65PX-16	D65EX-17	D65PX-17	D65WX-17
OPERATING WEIGHT*		kg (lb)	21860 (48,190)	21160 (46,650)	22030 (48,570)	22060 (48,630)
BLADE CAPACITY LH2** SAE		m ³ (yd ³)	4.42 (5.78)	5.90 (7.72) 4.25 (5.56)	5.90 (7.72) 4.25 (5.56)	6.12 (8.00) 4.42 (5.78)
DIMENSION*						
A	Overall length	mm (ft.in)	5790 (19'0")	5790 (19'0")	5790 (19'0")	5790 (19'0")
B	Overall width	mm (ft.in)	4010 (13'2")	3870 (12'8")	4010 (13'2")	4010 (13'2")
C	Overall height	mm (ft.in)	3155 (10'4")	3155 (10'4")	3155 (10'4")	3155 (10'4")
	Ground pressure	kg/cm ² (PSI)	0.44 (6.26)	0.63 (8.96)	0.37 (5.26)	0.49 (6.970)
DOZER EQUIPMENT						
	Type		Inside mount	Inside mount	Inside mount	Inside mount
	Weight (Includes hydraulic control unit)	kg (lb)	2990 (6,590)	2960 (6,530)	2990 (6,590)	2990 (6,590)
	Length	mm (ft.in)	4010 (13'2")	3870 (12'8")	4010 (13'2")	4010 (13'2")
	Height	mm (ft.in)	1235 (4'1")	1235 (4'1")	1235 (4'1")	1235 (4'1")
D	Max. lift above ground	mm (ft.in)	1165 (3'10")	1165 (3'10")	1165 (3'10")	1165 (3'10")
E	Max. drop below ground	mm (ft.in)	700 (2'4")	700 (2'4")	700 (2'4")	700 (2'4")
F	Max. tilting adjustment	mm (ft.in)	520 (1'8")	500 (1'8")	520 (1'8")	520 (1'8")
	Angling angle (L/R)	degree	25/25	25/25	25/25	25/25
UPPER ATTACHMENT			ROPS cab	ROPS cab	ROPS cab	ROPS cab

Item		Model	D68ESS-12*6	D85EX-15E0*5 D85EX-15R*5		
OPERATING WEIGHT*		kg (lb)	18,800 (41,500)	24970 (55,050) 24870 (54,830)		
BLADE CAPACITY LH2** SAE		m ³ (yd ³)	3.4 (4.45)	5.77 (7.55) 4.0 (5.2)		
DIMENSION*						
A	Overall length	mm (ft.in)	6,120 (20'1")	6035 (19'10")		
B	Overall width	mm (ft.in)	3,275 (10'9")	4515 (14'10")		
C	Overall height	mm (ft.in)	3,135 (10'3")	3330 (10'11")		
	Ground pressure	kg/cm ² (PSI)	0.53 (7.53)	0.73 (10.38) 0.73 (10.38)		
DOZER EQUIPMENT						
	Type		Inside mount	Outside mount		
	Weight (Includes hydraulic control unit)	kg (lb)	2,360 (5,205)	3754 (8,276)		
	Length	mm (ft.in)	3275 (10'9")	4515 (14'10")		
	Height	mm (ft.in)	1200 (3'11")	1130 (3'11")		
D	Max. lift above ground	mm (ft.in)	1055 (3'6")	1173 (3'10")		
E	Max. drop below ground	mm (ft.in)	560 (1'10")	760 (2'6")		
F	Max. tilting adjustment	mm (ft.in)	510 (1'9")	520 (1'8")		
	Angling angle (L/R)	degree	25/25	25/25		
UPPER ATTACHMENT			Sweep guard	-		

* : Including dozer equipment in addition to bare tractor, excluding ROPS and cab

** : L: Blade length H: Blade height

*** : Wide blade

*4 : Brazil source

*5 : Mechanical angle-tilt dozer

*6 : With sweep guard

Blade Specifications Semi-U Tiltedozer

BULLDOZERS

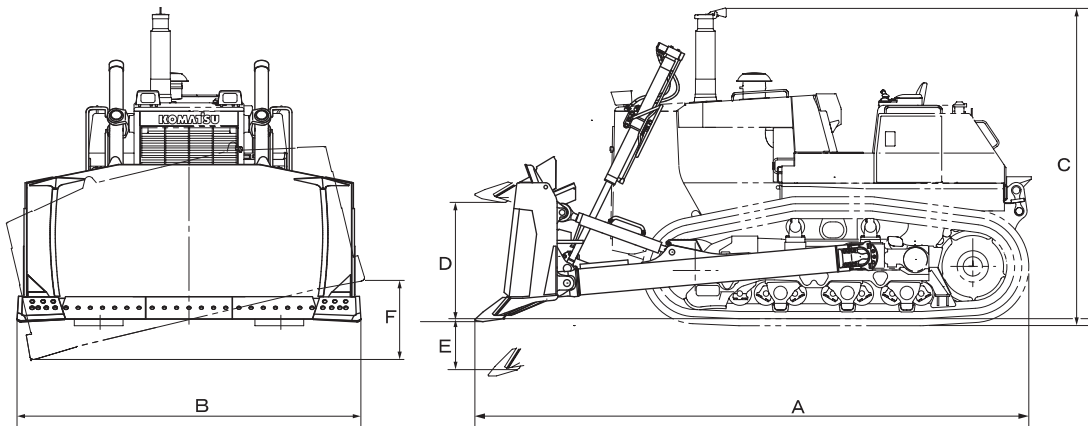

Item		Model	D61EX-15E0	D63E-12***	D65E-12	D65EX-16
OPERATING WEIGHT*		kg (lb)	16350 (36,050)	16705 (36,830)	18500 (40,780)	19360 (42,680)
BLADE CAPACITY LH2** SAE		m ³ (yd ³)	5.4 (7.1) 4.3 (5.6)	5.4 (7.1) 4.4 (5.6)	6.8 (8.9) 5.6 (7.3)	6.8 (8.9) 5.6 (7.3)
DIMENSION*						
A	Overall length	mm (ft.in)	5050 (16'7")	5260 (17'3")	5440 (17'10")	5310 (17'5")
B	Overall width	mm (ft.in)	3175 (10'5")	3200 (10'6")	3460 (11'4")	3460 (11'4")
C	Overall height	mm (ft.in)	2945 (8'2")	2700 (8'10")	2990 (9'10")	3155 (10'4")
	Ground pressure	kg/cm ² (PSI)	0.52 (7.39)	0.55 (7.8)	0.68 (9.7)	0.64 (9.1)
DOZER EQUIPMENT						
	Weight (Includes hydraulic control unit)	kg (lb)	2430 (5,360)	2060 (4,540)	2320 (5,115)	2320 (5,115)
	Length	mm (ft.in)	3175 (10'5")	3200 (10'6")	3460 (11'4")	3460 (11'4")
	Height	mm (ft.in)	1300 (4'3")	1300 (4'3")	1425 (4'8")	1425 (4'8")
D	Max. lift above ground	mm (ft.in)	970 (3'2")	1005 (3'4")	1105 (3'8")	1110 (3'8")
E	Max. drop below ground	mm (ft.in)	545 (1'9")	460 (1'6")	440 (1'5")	440 (1'5")
F	Max. tilting adjustment	mm (ft.in)	690 (2'3")	600 (2'3")	855 (2'10")	930 (3'1")
UPPER ATTACHMENT			-	-	-	ROPS cab

Item		Model	D85ESS-2A	D85EX-15E0 D85EX-15R	D155A-5	D155AX-6
OPERATING WEIGHT*		kg (lb)	18530 (40,850)	24820 (54,720) 24720 (54,500)	32800 (72,310)	35960 (79,280)
BLADE CAPACITY LH2** SAE		m ³ (yd ³)	8.90 (11.64) 6.8 (8.9)	9.07 (11.87) 7.0 (9.2)	11.7 (15.3) 8.8 (11.5)	13.23 (17.31) 9.4 (12.3)
DIMENSION*						
A	Overall length	mm (ft.in)	5770 (18'11")	5795 (19')	6300 (20'8")	6175 (20'3")
B	Overall width	mm (ft.in)	3640 (11'11")	3635 (11'11")	3955 (13')	4130 (13'7")
C	Overall height	mm (ft.in)	2980 (9'9")	3330 (10'11")	3395 (11'2")	3385 (11'1")
	Ground pressure	kg/cm ² (PSI)	0.61 (8.67)	0.73 (10.32)	0.91 (12.94)	0.98 (13.94)
DOZER EQUIPMENT						
	Weight (Includes hydraulic control unit)	kg (lb)	3110 (6,860)	3599 (7,943)	4900 (10,800)	4960 (10,936)
	Length	mm (ft.in)	3640 (11'11")	3635 (11'11")	3955 (13')	4130 (13'7")
	Height	mm (ft.in)	1565 (5'2")	1580 (5'2")	1720 (5'8")	1790 (5'10")
D	Max. lift above ground	mm (ft.in)	1070 (3'6")	1210 (4')	1250 (4'1")	1255 (4'1")
E	Max. drop below ground	mm (ft.in)	590 (1'11")	540 (1'9")	590 (1'11")	593 (1'11")
F	Max. tilting adjustment	mm (ft.in)	460 (1'6")	735 (2'5")	1000 (3'3")	953 (3')
UPPER ATTACHMENT			-	-	-	-

* : Including dozer equipment in addition to bare tractor, excluding ROPS and cab

** : L: Blade length H: Blade height

*** : for Russia

Blade Specifications Semi-U Tiltadozer

BULLDOZERS

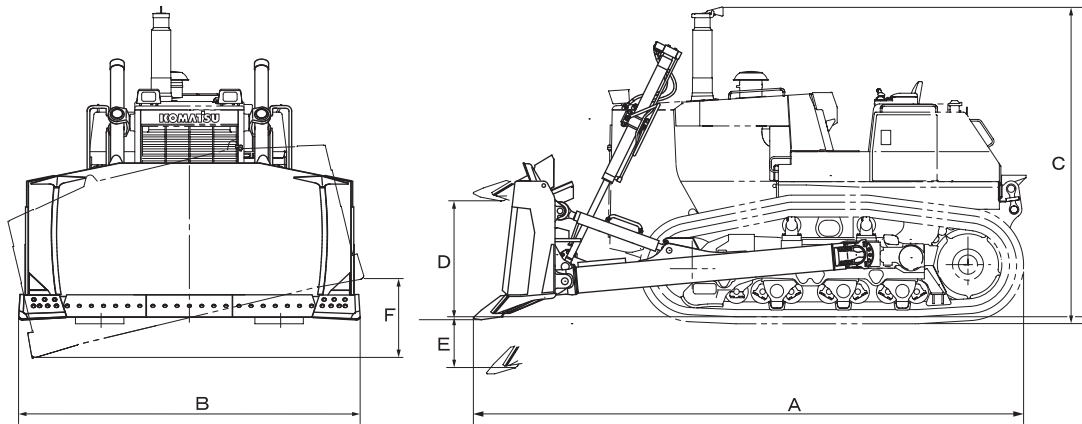

FVBH0229

Item		Model	D155A-6	D155AX-7	D275AX-5E0 D275A-5R	D275A-5
OPERATING WEIGHT*		kg (lb)	37260 (82,140) 37920(83,600)*4	36660 (80,820)	45190 (99,630)	45190 (99,630)
BLADE CAPACITY LH2** SAE		m ³ (yd ³)	13.2 (17.3) 9.4 (12.3)	13.2 (17.3) 9.4 (12.3)	16.5 (21.6) 13.7 (17.9)	16.5 (21.6) 13.7 (17.9)
DIMENSION*						
A	Overall length	mm (ft.in)	6010 (19'9")	6275 (20'7")	6930 (22'9")	6930 (22'9")
B	Overall width	mm (ft.in)	4130 (13'7")	4130 (13'7")	4300 (14'1")	4300 (14'1")
C	Overall height	mm (ft.in)	3385 (11'1")	3390 (11'1")	3940 (12'11")	3965 (13'0")
	Ground pressure	kg/cm ² (PSI)	1.06 (15.07) 1.07 (15.22)*4	1.0 (14.2)	1.06 (15.1)	1.06 (15.1)
DOZER EQUIPMENT						
	Weight (Includes hydraulic control unit)	kg (lb)	4960 (10,936)	4960 (10,940)	7507 (16,550)	7507 (16,550)
	Length	mm (ft.in)	4130 (13'7")	4130 (13'7")	4300 (14'1")	4300 (14'1")
	Height	mm (ft.in)	1790 (5'10")	1790 (5'10")	1960 (6'5")	1960 (6'5")
D	Max. lift above ground	mm (ft.in)	1250 (4'1")	1255 (4'1")	1475 (4'10")	1450 (4'9")
E	Max. drop below ground	mm (ft.in)	590 (1'11")	593 (1'11")	615 (2'0")	640 (2'1")
F	Max. tilting adjustment	mm (ft.in)	950 (3'1")	890 (2'11")	1000 (3'3")	1000 (3'3")
UPPER ATTACHMENT			-	ROPS cab	-	-

Item		Model	D275AX-5E0*** D275A-5R***	D275A-5***	D375A-5	D375A-5R
OPERATING WEIGHT*		kg (lb)	45270 (99,800)	45270 (99,800)	60340 (133,030)	61630 (135,870)
BLADE CAPACITY LH2** SAE		m ³ (yd ³)	16.5 (21.6) 13.7 (17.9)	16.5 (21.6) 13.7 (17.9)	24.0 (31.4) 18.5 (24.2)	24.0 (31.4) 18.5 (24.2)
DIMENSION*						
A	Overall length	mm (ft.in)	6930 (22'9")	6930 (22'9")	7635 (25'1")	7715 (25'4")
B	Overall width	mm (ft.in)	4300 (14'1")	4300 (14'1")	4695 (15'5")	4695 (15'5")
C	Overall height	mm (ft.in)	3940 (12'11")	3965 (13'0")	4035 (13'3")	4215 (13'10")
	Ground pressure	kg/cm ² (PSI)	1.09 (15.50)	1.09 (15.50)	1.29 (18.34)	1.32 (18.77)
DOZER EQUIPMENT						
	Weight (Includes hydraulic control unit)	kg (lb)	7590 (16,730)	7590 (16,730)	10540 (23,240)	10910 (24,050)
	Length	mm (ft.in)	4300 (14'1")	4300 (14'1")	4695 (15'5")	4695 (15'5")
	Height	mm (ft.in)	1960 (6'5")	1960 (6'5")	2265 (7'5")	2265 (7'5")
D	Max. lift above ground	mm (ft.in)	1475 (4'10")	1450 (4'9")	1660 (5'5")	1660 (5'5")
E	Max. drop below ground	mm (ft.in)	615 (2'0")	640 (2'1")	715 (2'4")	715 (2'4")
F	Max. tilting adjustment	mm (ft.in)	1140 (3'9")	1140 (3'9")	1065 (3'6")	1065 (3'6")
UPPER ATTACHMENT			-	-	-	-

* : Including dozer equipment in addition to bare tractor, excluding ROPS and cab

** : L: Blade length H: Blade height

*** : Dual tilt dozer

*4 : Strengthend type

Blade Specifications Semi-U Tiltadozer

BULLDOZERS

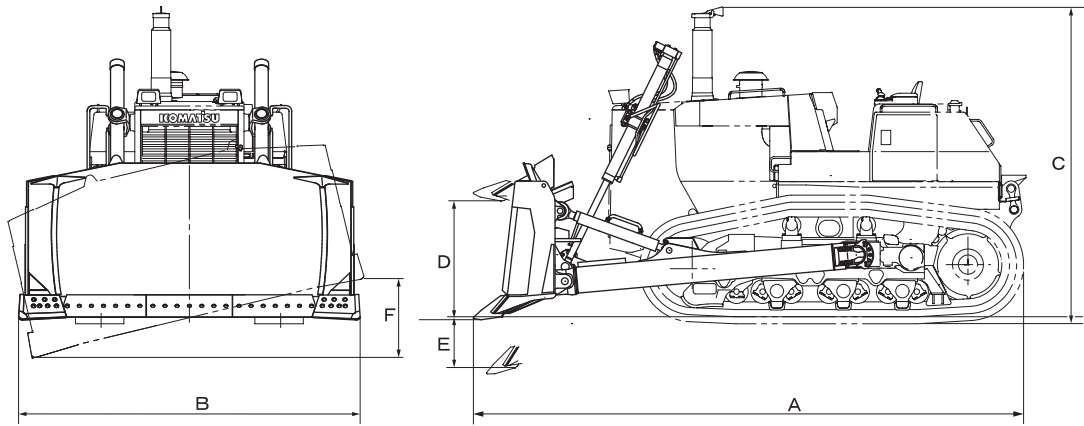

FVBH0229

Item		Model	D375A-6	D375A-6R	D475A-5E0*7	D575A-3*7
OPERATING WEIGHT*		kg (lb)	64165 (141,460)	62765 (138,370)	100090 (220,660)	118240 (260,670)
BLADE CAPACITY LH2** SAE		m ³ (yd ³)	24.0 (31.4) 18.5 (24.2)	24.0 (31.4) 18.5 (24.2)	38.1 (49.83) 27.2 (35.6)	44.1 (57.7) 34 (44.5)
DIMENSION*						
A	Overall length	mm (ft.in)	7780 (25'6")	7820 (25'8")	8705 (28'7")	9310 (30'7")
B	Overall width	mm (ft.in)	4695 (15'5")	4695 (15'5")	5265 (17'3")	5880 (19'3")
C	Overall height	mm (ft.in)	4265 (7'5")	4215 (13'10")	4546 (14'11")	4495 (14'9")
	Ground pressure	kg/cm ² (PSI)	1.32 (18.77)	1.34 (19.05)	1.37 (19.48)	1.72 (24.46)
DOZER EQUIPMENT						
	Weight (Includes hydraulic control unit)	kg (lb)	10965 (24,170)	10965 (24,170)	16500 (36,380)	19790 (43,630)
	Length	mm (ft.in)	4695 (15'5")	4695 (15'5")	5265 (17'3")	5880 (19'3")
	Height	mm (ft.in)	2265 (7'5")	2265 (7'5")	2690 (8'10")	2740 (9'0")
D	Max. lift above ground	mm (ft.in)	1690 (5'7")	1642 (5'5")	1620 (5'4")	1850 (6'1")
E	Max. drop below ground	mm (ft.in)	735 (2'5")	800 (2'7")	1010 (3'4")	900 (2'11")
F	Max. tilting adjustment	mm (ft.in)	970 (3'2")	970 (3'2")	770 (2'6")	1380 (4'6")
UPPER ATTACHMENT			-	-	-	-

Item		Model				
OPERATING WEIGHT*		kg (lb)				
BLADE CAPACITY LH2** SAE		m ³ (yd ³)				
DIMENSION*						
A	Overall length	mm (ft.in)				
B	Overall width	mm (ft.in)				
C	Overall height	mm (ft.in)				
	Ground pressure	kg/cm ² (PSI)				
DOZER EQUIPMENT						
	Weight (Includes hydraulic control unit)	kg (lb)				
	Length	mm (ft.in)				
	Height	mm (ft.in)				
D	Max. lift above ground	mm (ft.in)				
E	Max. drop below ground	mm (ft.in)				
F	Max. tilting adjustment	mm (ft.in)				
UPPER ATTACHMENT						

* : Including dozer equipment in addition to bare tractor, excluding ROPS and cab

** : L: Blade length H: Blade height

*** : Wide blade

*4 : Brazil source

*5 : Mechanical angle-tiltadozer

*6 : for Russia

*7 : Strengthened type

Blade Specifications Dual Tilt Semi-U Dozer

BULLDOZERS

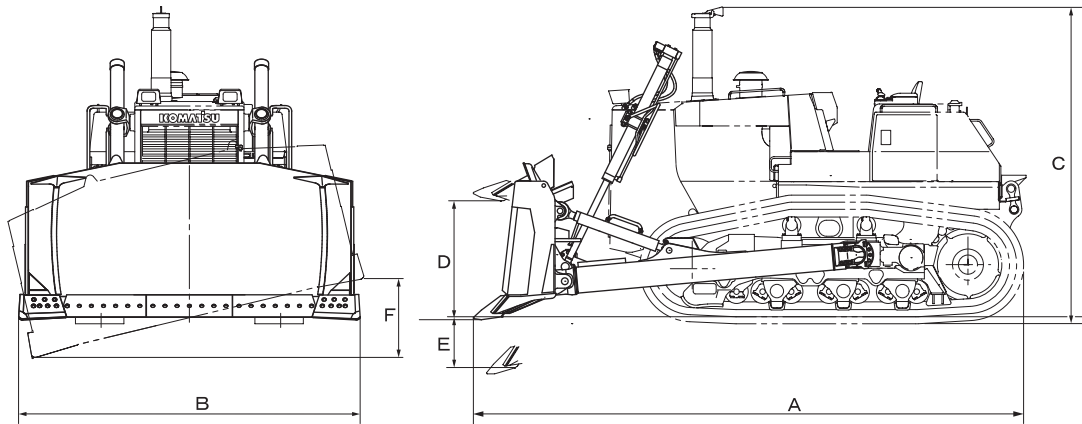

FVBH0229

Item		Model	D375A-5	D375A-5R	D375A-6	D375A-6R
OPERATING WEIGHT*		kg (lb)	61590 (135,780)	62010 (136,710)	64820 (142,900)	62950 (138,780)
BLADE CAPACITY LH2** SAE		m ³ (yd ³)	24.0 (31.4) 18.5 (24.2)	24.0 (31.4) 18.5 (24.2)	24.0 (31.4) 18.5 (24.2)	24.0 (31.4) 18.5 (24.2)
DIMENSION*						
A	Overall length	mm (ft.in)	7635 (25'1")	7715 (25'4")	7780 (25'6")	7820 (17240)
B	Overall width	mm (ft.in)	4695 (15'5")	4695 (15'5")	4695 (15'5")	4695 (15'5")
C	Overall height	mm (ft.in)	4035 (13'3")	4215 (13'10")	4265 (7'5")	4265 (7'5")
	Ground pressure	kg/cm ² (PSI)	1.31 (18.63)	1.32 (18.77)	1.33 (18.91)	1.34 (19.05)
DOZER EQUIPMENT						
	Weight (Includes hydraulic control unit)	kg (lb)	11790 (25,990)	11290 (24,890)	11620 (25,620)	11150 (24,580)
	Length	mm (ft.in)	4695 (15'5")	4695 (15'5")	4695 (15'5")	4695 (15'5")
	Height	mm (ft.in)	2265 (7'5")	2265 (7'5")	2265 (7'5")	2265 (7'5")
D	Max. lift above ground	mm (ft.in)	1660 (5'5")	1660 (5'5")	1690 (5'7")	1642 (5'5")
E	Max. drop below ground	mm (ft.in)	715 (2'4")	715 (2'4")	735 (2'5")	800 (2'7")
F	Max. tilting adjustment	mm (ft.in)	1165 (3'10")	1150 (3'9")	1185 (3'11")	1185 (3'11")
UPPER ATTACHMENT			-	-	-	-

Item		Model	D475A-5E0***	D575A-3		
OPERATING WEIGHT*		kg (lb)	100540 (221,658)	118810 (261,930)		
BLADE CAPACITY LH2** SAE		m ³ (yd ³)	38.1 (49.83) 27.2 (35.6)	44.1 (57.7) 34 (44.5)		
DIMENSION*						
A	Overall length	mm (ft.in)	8705 (28'7")	9310 (30'7")		
B	Overall width	mm (ft.in)	5265 (17'3")	5880 (19'3")		
C	Overall height	mm (ft.in)	4546 (14'11")	4495 (14'9")		
	Ground pressure	kg/cm ² (PSI)	1.57 (22.25)	1.73 (24.6)		
DOZER EQUIPMENT						
	Weight (Includes hydraulic control unit)	kg (lb)	16950 (37,370)	20360 (44,890)		
	Length	mm (ft.in)	5265 (17'3")	5880 (19'3")		
	Height	mm (ft.in)	2690 (8'10")	2740 (9'0")		
D	Max. lift above ground	mm (ft.in)	1620 (5'4")	1850 (6'1")		
E	Max. drop below ground	mm (ft.in)	1010 (3'4")	900 (2'11")		
F	Max. tilting adjustment	mm (ft.in)	1145 (3'9")	1640 (5'5")		
UPPER ATTACHMENT			-	-		

* : Including dozer equipment in addition to bare tractor, excluding ROPS and cab

** : L: Blade length H: Blade height

*** : Strengthened type

Blade Specifications SIGMADOZER, Sigma Power-pitch Dozer

BULLDOZERS

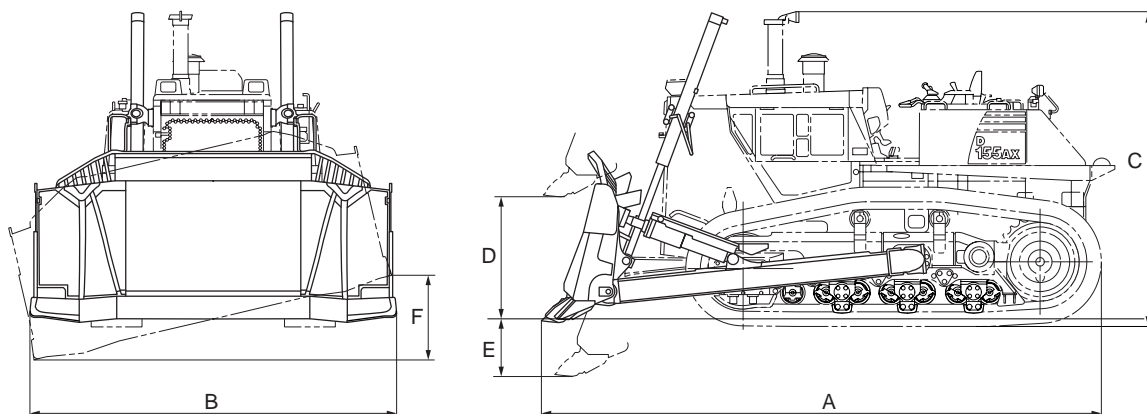

FVBH0387

Item		Model	D65EX-16	D65EX-16*6	D65EX-17	D65WX-17
OPERATING WEIGHT*		kg (lb)	19510 (43,010)	19560 (43,120)	19680 (43,390)	20530 (45,260)
BLADE CAPACITY LH2** SAE		m ³ (yd ³)	5.61 (7.34)	5.61 (7.34)	6.92 (9.05) 5.61 (7.34)	7.27 (9.51) 5.90 (7.72)
DIMENSION*						
A	Overall length	mm (ft.in)	5490 (18'0")	5490 (18'0")	5490 (18'0")	5500 (18'1")
B	Overall width	mm (ft.in)	3410 (11'2")	3410 (11'2")	3410 (11'2")	3580 (11'9")
C	Overall height	mm (ft.in)	3155 (10'4")	3155 (10'4")	3155 (10'4")	3155 (10'4")
	Ground pressure	kg/cm ² (PSI)	0.64 (9.10)	0.64 (9.10)	0.65 (9.2)	0.45 (6.4)
DOZER EQUIPMENT						
	Weight (Includes hydraulic control unit)	kg (lb)	2390 (5,270)	2440 (5,380)	2390 (5,270)	2500 (5,510)
	Length	mm (ft.in)	3410 (11'2")	3410 (11'2")	3410 (11'2")	3580 (11'9")
	Height	mm (ft.in)	1425 (4'8")	1425 (4'8")	1425 (4'8")	1425 (4'8")
D	Max. lift above ground	mm (ft.in)	1130 (3'8")	1130 (3'8")	1130 (3'8")	1130 (3'8")
E	Max. drop below ground	mm (ft.in)	505 (1'8")	505 (1'8")	505 (1'8")	505 (1'8")
F	Max. tilting adjustment	mm (ft.in)	870 (2'10")	870 (2'10")	870 (2'10")	770 (2'6")
	Digging angle	degree	46	46	46	46
UPPER ATTACHMENT			ROPS cab	ROPS cab	ROPS cab	ROPS cab

Item		Model	D155AX-6	D155AX-6***	D155AX-6*4	D155AX-6*5
OPERATING WEIGHT*		kg (lb)	35940 (79,240)	35940 (79,240)	36360 (80,160)	36360 (80,160)
BLADE CAPACITY LH2** SAE		m ³ (yd ³)	13.9 (18.17) 9.4 (12.3)	13.9 (18.17) 9.4 (12.3)	13.9 (18.17) 9.4 (12.3)	13.9 (18.17) 9.4 (12.3)
DIMENSION*						
A	Overall length	mm (ft.in)	6125 (20'1")	6125 (20'1")	6125 (20'1")	6125 (20'1")
B	Overall width	mm (ft.in)	4060 (13'4")	4060 (13'4")	4060 (13'4")	4060 (13'4")
C	Overall height	mm (ft.in)	3385 (11'1")	3385 (11'1")	3385 (11'1")	3385 (11'1")
	Ground pressure	kg/cm ² (PSI)	0.98 (13.92)	0.98 (13.92)	0.99 (14.1)	0.99 (14.1)
DOZER EQUIPMENT						
	Weight (Includes hydraulic control unit)	kg (lb)	4940 (10,890)	4940 (10,890)	5360 (11,820)	5360 (11,820)
	Length	mm (ft.in)	4060 (13'4")	4060 (13'4")	4060 (13'4")	4060 (13'4")
	Height	mm (ft.in)	1850 (6'1")	1850 (6'1")	1850 (6'1")	1850 (6'1")
D	Max. lift above ground	mm (ft.in)	1320 (4'4")	1320 (4'4")	1320 (4'4")	1320 (4'4")
E	Max. drop below ground	mm (ft.in)	617 (2')	617 (2')	617 (2')	617 (2')
F	Max. tilting adjustment	mm (ft.in)	920 (3')	920 (3')	920 (3')	920 (3')
	Digging angle	degree	46	46	46	46
UPPER ATTACHMENT			-	-	-	-

* : Including dozer equipment in addition to bare tractor, excluding ROPS and cab

** : L: Blade length H: Blade height

*** : Dual SIGMADOZER

*4 : Strengthened type

*5 : Strengthened dual SIGMADOZER

*6 : With sigma power-pitch dozer

Blade Specifications SIGMADOZER, Sigma Power-pitch Dozer

BULLDOZERS

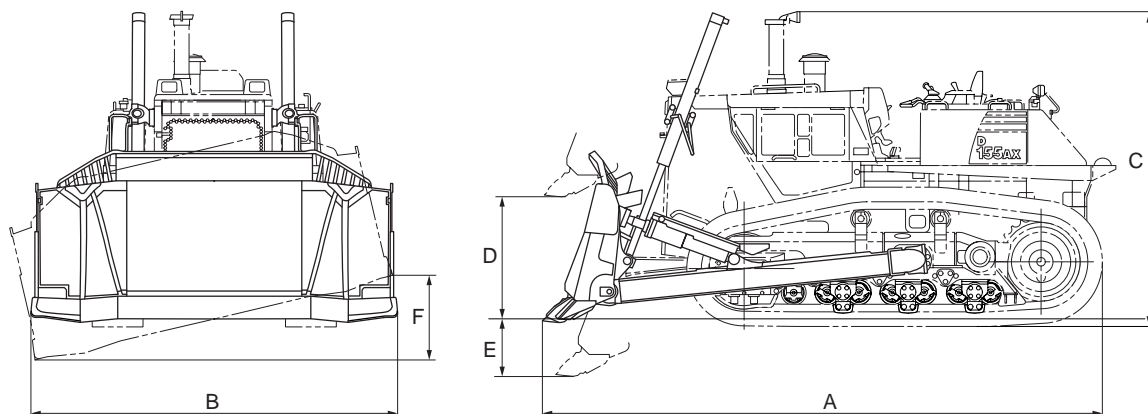

FVBH0387

Item		Model	D155A-6	D155A-6***	D155AX-7***	D155AX-7* ⁵
OPERATING WEIGHT*		kg (lb)	37240 (82,100)	37660 (83,030)	36640 (80,780)	37060 (81,700)
BLADE CAPACITY LH2** SAE		m ³ (yd ³)	13.9 (18.17) 9.4 (12.3)	13.9 (18.17) 9.4 (12.3)	13.2 (17.3) 9.4 (12.3)	13.2 (17.3) 9.4 (12.3)
DIMENSION*						
A	Overall length	mm (ft.in)	6125 (20'1")	6125 (20'1")	6225 (20'5")	6225 (20'5")
B	Overall width	mm (ft.in)	4060 (13'4")	4060 (13'4")	4060 (13'4")	4060 (13'4")
C	Overall height	mm (ft.in)	3385 (11'1")	3385 (11'1")	3390 (11'1")	3390 (11'1")
	Ground pressure	kg/cm ² (PSI)	1.06 (15.07)	1.06 (15.07)	1.0 (14.2)	1.0 (14.2)
DOZER EQUIPMENT						
	Weight (Includes hydraulic control unit)	kg (lb)	4940 (10,890)	4940 (10,890)	4940 (10,890)	4940 (10,890)
	Length	mm (ft.in)	4060 (13'4")	4060 (13'4")	4060 (13'4")	4060 (13'4")
	Height	mm (ft.in)	1850 (6'1")	1850 (6'1")	1850 (6'1")	1850 (6'1")
D	Max. lift above ground	mm (ft.in)	1320 (4'4")	1320 (4'4")	1320 (4'4")	1320 (4'4")
E	Max. drop below ground	mm (ft.in)	617 (2')	617 (2')	617 (2'0")	617 (2'0")
F	Max. tilting adjustment	mm (ft.in)	920 (3')	920 (3')	880 (2'11")	880 (2'11")
	Digging angle	degree	46	46	50	50
UPPER ATTACHMENT			-	-	ROPS cab	ROPS cab

Item		Model	D275AX-5E0* ⁴	D275AX-5E0* ⁵	D275A-5R* ⁴	D275A-5R* ⁵
OPERATING WEIGHT*		kg (lb)	46740 (103,040)	46825 (103,230)	46740 (103,040)	46825 (103,230)
BLADE CAPACITY LH2** SAE		m ³ (yd ³)	20.5 (26.8) 14.6 (19.1)	20.5 (26.8) 14.6 (19.1)	20.5 (26.8) 14.6 (19.1)	20.5 (26.8) 14.6 (19.1)
DIMENSION*						
A	Overall length	mm (ft.in)	6660 (21'10")	6660 (21'10")	6665 (21'10")	6665 (21'10")
B	Overall width	mm (ft.in)	4440 (14'7")	4440 (14'7")	4440 (14'7")	4440 (14'7")
C	Overall height	mm (ft.in)	3940 (12'11")	3940 (12'11")	3940 (12'11")	3940 (12'11")
	Ground pressure	kg/cm ² (PSI)	1.1 (15.6)	1.1 (15.6)	1.1 (15.6)	1.1 (15.6)
DOZER EQUIPMENT						
	Weight (Includes hydraulic control unit)	kg (lb)	9060 (19,970)	9145 (20,160)	9060 (19,970)	9145 (20,160)
	Length	mm (ft.in)	4440 (14'7")	4440 (14'7")	4440 (14'7")	4440 (14'7")
	Height	mm (ft.in)	2150 (7'1")	2150 (7'1")	2150 (7'1")	2150 (7'1")
D	Max. lift above ground	mm (ft.in)	1415 (4'8")	1415 (4'8")	1415 (4'8")	1415 (4'8")
E	Max. drop below ground	mm (ft.in)	715 (2'4")	715 (2'4")	720 (2'4")	720 (2'4")
F	Max. tilting adjustment	mm (ft.in)	1000 (3'3")	1070 (3'6")	1000 (3'3")	1070 (3'6")
	Digging angle	degree	46	46	46	46
UPPER ATTACHMENT			-	-	-	-

* : Including dozer equipment in addition to bare tractor, excluding ROPS and cab

** : L: Blade length H: Blade height

*** : Dual SIGMADOZER

*⁴ : Strengthened type

*⁵ : Strengthened dual SIGMADOZER

*⁶ : With sigma power-pitch dozer

Blade Specifications U-tiltdozer

BULLDOZERS

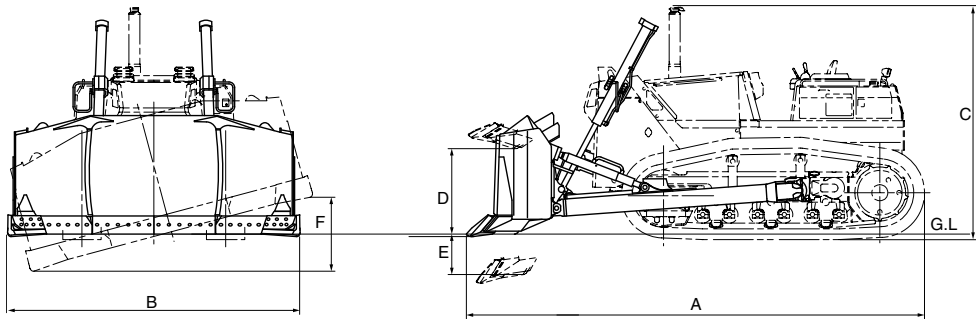

Item		Model	D155A-5	D155AX-6	D155A-6	D155AX-7
OPERATING WEIGHT*		kg (lb)	33500 (73,850)	36630 (80,770)	37930 (83,620)	37330 (82,300)
BLADE CAPACITY LH2** SAE		m ³ (yd ³)	13.2 (17.3) 11.8 (15.4)	13.5 (17.7) 11.9 (15.6)	13.5 (17.7) 11.9 (15.6)	13.5 (17.7) 11.9 (15.6)
DIMENSION*						
A	Overall length	mm (ft.in)	6695 (22')	6590 (21'7")	6430 (21'1")	6690 (21'11")
B	Overall width	mm (ft.in)	4265 (14')	4225 (13'10")	4225 (13'10")	4225 (13'10")
C	Overall height	mm (ft.in)	3395 (11'2")	3385 (11'1")	3385 (11'1")	3390 (11'1")
	Ground pressure	kg/cm ² (PSI)	0.93 (13.22) 0.97 (13.79)	1.00 (14.19)	1.08 (15.36)	1.02 (14.5)
DOZER EQUIPMENT						
	Weight (Includes hydraulic control unit)	kg (lb)	5600 (12,350)	5630 (12,420)	5630 (12,410)	5630 (12,410)
	Length	mm (ft.in)	4265 (14')	4225 (13'10")	4225 (13'10")	4225 (13'10")
	Height	mm (ft.in)	1760 (5'9")	1790 (5'10")	1790 (5'10")	1790 (5'10")
D	Max. lift above ground	mm (ft.in)	1250 (4'1")	1255 (4'1")	1250 (4'1")	1255 (4'1")
E	Max. drop below ground	mm (ft.in)	590 (1'11")	593 (1'11")	590 (1'11")	593 (1'11")
F	Max. tilting adjustment	mm (ft.in)	1080 (3'7")	970 (3'2")	970 (3'2")	930 (3'1")
UPPER ATTACHMENT			-	-	-	ROPS cab

Item		Model	D275A-5	D275AX-5E0 D275A-5R	D275A-5***	D275AX-5E0*** D275A-5R***
OPERATING WEIGHT*		kg (lb)	46110 (101,650)	46110 (101,650)	46200 (101,850)	46200 (101,850)
BLADE CAPACITY LH2** SAE		m ³ (yd ³)	18.0 (23.5) 16.6 (21.7)	18.0 (23.5) 16.6 (21.7)	18.0 (23.5) 16.6 (21.7)	18.0 (23.5) 16.6 (21.7)
DIMENSION*						
A	Overall length	mm (ft.in)	7265 (23'10")	7265 (23'10")	7265 (23'10")	7265 (23'10")
B	Overall width	mm (ft.in)	4615 (15'2")	4615 (15'2")	4615 (15'2")	4615 (15'2")
C	Overall height	mm (ft.in)	3965 (13'0")	3940 (12'11")	3965 (13'0")	3940 (12'11")
	Ground pressure	kg/cm ² (PSI)	1.09 (15.5)	1.09 (15.5)	1.09 (15.50)	1.09 (15.50)
DOZER EQUIPMENT						
	Weight (Includes hydraulic control unit)	kg (lb)	8433 (18,590)	8433 (18,590)	8516 (18,770)	8516 (18,770)
	Length	mm (ft.in)	4615 (15'2")	4615 (15'2")	4615 (15'2")	4615 (15'2")
	Height	mm (ft.in)	1973 (6'6")	1973 (6'6")	1973 (6'6")	1973 (6'6")
D	Max. lift above ground	mm (ft.in)	1450 (4'9")	1475 (4'10")	1450 (4'9")	1475 (4'10")
E	Max. drop below ground	mm (ft.in)	640 (2'1")	615 (2'0")	640 (2'1")	615 (2'0")
F	Max. tilting adjustment	mm (ft.in)	1070 (3'6")	1070 (3'6")	1220 (4'0")	1220 (4'0")
UPPER ATTACHMENT			-	-	-	-

* : Including dozer equipment in addition to bare tractor, excluding ROPS and cab

** : L: Blade length H: Blade height

*** : Dual tiltdozer

Blade Specifications U-tiltdozer

BULLDOZERS

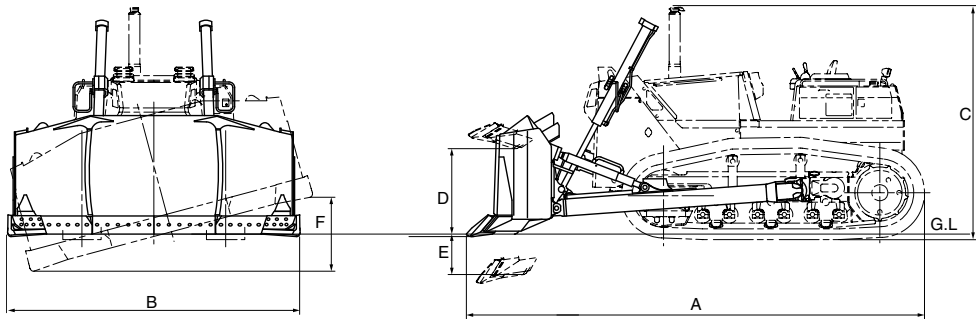

Item		Model	D375A-5	D375A-5***	D375A-5R	D375A-5R***
OPERATING WEIGHT*		kg (lb)	61590 (135,780)	61970 (136,620)	63140 (139,200)	63520 (140,040)
BLADE CAPACITY LH2** SAE		m ³ (yd ³)	26.3 (34.4) 22.0 (28.8)	26.3 (34.4) 22.0 (28.8)	26.3 (34.4) 22.0 (28.8)	26.3 (34.4) 22.0 (28.8)
DIMENSION*						
A	Overall length	mm (ft.in)	8000 (26'5")	8000 (26'5")	8130 (26'8")	8130 (26'8")
B	Overall width	mm (ft.in)	5140 (16'10")	5140 (16'10")	5140 (16'10")	5140 (16'10")
C	Overall height	mm (ft.in)	4035 (13'3")	4035 (13'3")	4215 (13'10")	4215 (13'10")
	Ground pressure	kg/cm ² (PSI)	1.31 (18.63)	1.32 (18.77)	1.35 (19.2)	1.36 (19.3)
DOZER EQUIPMENT						
	Weight (Includes hydraulic control unit)	kg (lb)	11790 (25,990)	12170 (26,830)	12420 (27380)	12800 (28,220)
	Length	mm (ft.in)	5140 (16'10")	5140 (16'10")	5140 (16'10")	5140 (16'10")
	Height	mm (ft.in)	2265 (7'5")	2265 (7'5")	2265 (7'5")	2265 (7'5")
D	Max. lift above ground	mm (ft.in)	1660 (5'5")	1660 (5'5")	1660 (5'5")	1660 (5'5")
E	Max. drop below ground	mm (ft.in)	715 (2'4")	715 (2'4")	715 (2'4")	715 (2'4")
F	Max. tilting adjustment	mm (ft.in)	1165 (3'10")	1260 (4'2")	1165 (3'10")	1260 (4'2")
UPPER ATTACHMENT			-	-	-	-

Item		Model	D375A-6*4	D375A-6*** *4	D375A-6R*4	D375A-6R*** *4
OPERATING WEIGHT*		kg (lb)	65665 (144,770)	65850 (145,170)	64265 (141,680)	64450 (142,090)
BLADE CAPACITY LH2** SAE		m ³ (yd ³)	26.3 (34.4) 22.0 (28.8)	26.3 (34.4) 22.0 (28.8)	26.3 (34.4) 22.0 (28.8)	26.3 (34.4) 22.0 (28.8)
DIMENSION*						
A	Overall length	mm (ft.in)	8140 (26'8")	8140 (26'8")	8180 (26'8")	8180 (26'8")
B	Overall width	mm (ft.in)	5140 (16'10")	5140 (16'10")	5140 (16'10")	5140 (16'10")
C	Overall height	mm (ft.in)	4265 (7'5")	4265 (7'5")	4215 (13'10")	4215 (13'10")
	Ground pressure	kg/cm ² (PSI)	1.35 (18.77)	1.36 (18.91)	1.37 (19.48)	1.38 (19.62)
DOZER EQUIPMENT						
	Weight (Includes hydraulic control unit)	kg (lb)	12465 (27,480)	12650 (27,890)	12465 (27,480)	12650 (27,890)
	Length	mm (ft.in)	5140 (16'10")	5140 (16'10")	5140 (16'10")	5140 (16'10")
	Height	mm (ft.in)	2265 (7'5")	2265 (7'5")	2265 (7'5")	2265 (7'5")
D	Max. lift above ground	mm (ft.in)	1690 (5'7")	1690 (5'7")	1642 (5'5")	1642 (5'5")
E	Max. drop below ground	mm (ft.in)	735 (2'5")	735 (2'5")	800 (2'7")	800 (2'7")
F	Max. tilting adjustment	mm (ft.in)	1065 (3'6")	1300 (4'3")	1065 (3'6")	1300 (4'3")
UPPER ATTACHMENT			-	-	-	-

* : Including dozer equipment in addition to bare tractor, excluding ROPS and cab

** : L: Blade length H: Blade height

*** : Dual tiltdozer

*4 : With spill guard

Blade Specifications U-tiltdozer

BULLDOZERS

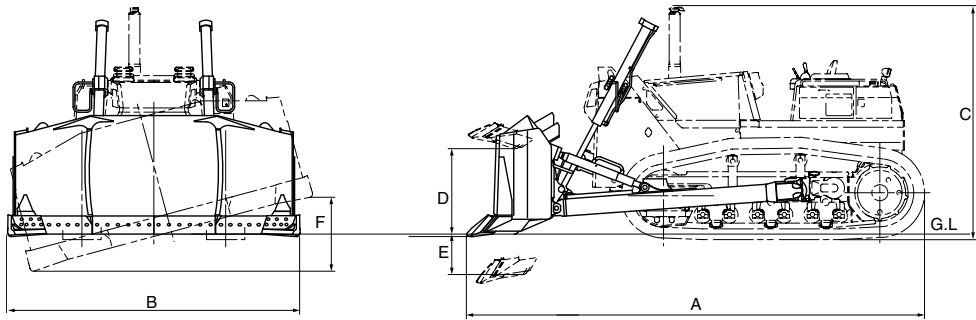

Item		Model	D475A-5E0	D475A-5E0***	D575A-3	
			kg (lb)	102390 (225,736)	102840 (226,730)	121835 (268,600)
OPERATING WEIGHT*		kg (lb)	102390 (225,736)	102840 (226,730)	121835 (268,600)	
BLADE CAPACITY LH2** SAE		m ³ (yd ³)	42.27 (55.3) 34.4 (45.0)	42.27 (55.28) 34.4 (45.0)	46.7 (61.1) 45 (58.9)	
DIMENSION*						
A	Overall length	mm (ft.in)	9205 (30'2")	9205 (30'2")	9815 (32'10")	
B	Overall width	mm (ft.in)	6205 (20'4")	6205 (20'4")	6800 (22'4")	
C	Overall height	mm (ft.in)		4546 (14'11")	4495 (14'9")	
	Ground pressure	kg/cm ² (PSI)	1.59 (22.65)	1.6 (22.75)	1.56 (22.18)	
DOZER EQUIPMENT						
	Weight (Includes hydraulic control unit)	kg (lb)	18800 (41,446)	19250 (42,440)	23385 (51,550)	
	Length	mm (ft.in)	6205 (20'4")	6205 (20'4")	6800 (22'4")	
	Height	mm (ft.in)	2610 (8'7")	2610 (8'7")	2600 (8'6")	
D	Max. lift above ground	mm (ft.in)	1620 (5'4")	1620 (5'4")	1850 (6'1")	
E	Max. drop below ground	mm (ft.in)	1010 (3'4")	1010 (3'4")	900 (2'11")	
F	Max. tilting adjustment	mm (ft.in)	905 (3')	1350 (4'5")	1600 (5'3")	
UPPER ATTACHMENT			-	-	-	

* : Including dozer equipment in addition to bare tractor, excluding ROPS and cab

** : L: Blade length H: Blade height

*** : Dual tiltdozer

Blade Specifications Super Dozer

BULLDOZERS

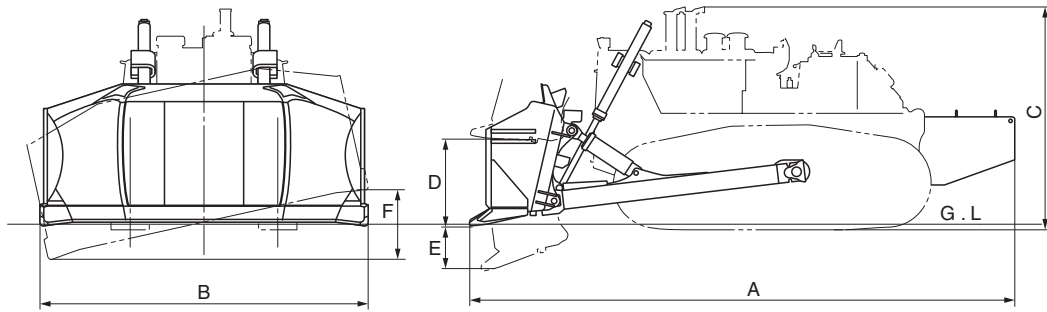

FVBH0333

Item		Model	D475ASD-5E0	D575A-3 SD		
OPERATING WEIGHT*		kg (lb)	112260 (247,490)	152410 (336,000)		
BLADE CAPACITY LH2** SAE		m ³ (yd ³)	45.0 (58.9)	69.0 (90.3) 60.0 (78.5)		
DIMENSION*						
A	Overall length	mm (ft.in)	10525 (34'6")	11720 (38'5")		
B	Overall width	mm (ft.in)	6465 (21'3")	7400 (24'3")		
C	Overall height	mm (ft.in)	4546 (14'11")	4495 (14'9")		
	Ground pressure	kg/cm ² (PSI)	1.53 (21.8)	1.50 (21.33)		
DOZER EQUIPMENT						
	Weight (Includes hydraulic control unit)	kg (lb)	21350 (47,070)	32430 (71,500)		
	Length	mm (ft.in)	6465 (21'3")	7400 (24'3")		
	Height	mm (ft.in)	2690 (8'10")	3250 (10'8")		
D	Max. lift above ground	mm (ft.in)	1960 (6'5")	1750 (5'9")		
E	Max. drop below ground	mm (ft.in)	860 (2'10")	805 (2'8")		
F	Max. tilting adjustment	mm (ft.in)	900 (2'11")	1000 (3'3")		
COUNTERWEIGHT		kg (lb)	6400 (14,110)	5400 (11,900)		
UPPER ATTACHMENT			-	-		

* : Including dozer equipment and counterweight in addition to bare tractor, excluding ROPS and cab

** : L: Blade length H: Blade height

Blade Specifications Coal Dozer

BULLDOZERS

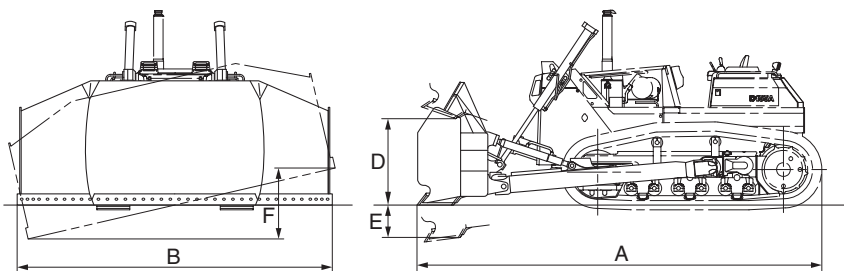

FVBH0200

Item		Model	D155A-5			
OPERATING WEIGHT*		kg (lb)	33330 (73,480)			
BLADE CAPACITY LH2** SAE		m ³ (yd ³)	21.5 (28.1)			
DIMENSION*						
A	Overall length	mm (ft.in)	6900 (22'8")			
B	Overall width	mm (ft.in)	5300 (17'5")			
C	Overall height	mm (ft.in)	3395 (11'2")			
	Ground pressure	kg/cm ² (PSI)	0.73 (10.5)***			
DOZER EQUIPMENT						
	Type		Coal dozer with power tilt			
	Weight (Includes hydraulic control unit)	kg (lb)	4930 (10,870)			
	Length	mm (ft.in)	5300 (17'5")			
	Height	mm (ft.in)	2125 (7'0")			
D	Max. lift above ground	mm (ft.in)	1495 (4'11")			
E	Max. drop below ground	mm (ft.in)	565 (1'10")			
F	Max. tilting adjustment	mm (ft.in)	1270 (4'2")			
UPPER ATTACHMENT			-			

* : Including dozer equipment in addition to bare tractor

** : L: Blade length H: Blade height

*** : With 710 mm (28") shoe

The estimated production curves give maximum production before correction and are based on the following conditions.

1. 100% efficiency
2. 0.05 min time fixed (for gear shifting)
3. Machine cuts for 15 m (50 ft), then drifts blade load.
4. Gear

Machines with F3/R3

- Cut : F1
- Carry : F2
- Return : R2

$$\text{Actual Production} = (\text{Estimated Production}) \times (\text{Blade Factor}) \times (\text{Job Efficiency}) \times (\text{Grade Factor})$$

Correction Factor

BLADE FACTOR	
• Easy	1.1~0.9
• Average	0.9~0.7
• Rather difficult	0.7~0.6
• Difficult	0.6~0.4
JOB EFFICIENCY	
• Good	0.83 (50 min out of an hour machine use)
• Average	0.75 (45 min out of an hour machine use)
• Rather poor	0.67 (40 min out of an hour machine use)
• Poor	0.58 (35 min out of an hour machine use)
GRADE FACTOR	See right table

GRADE FACTOR

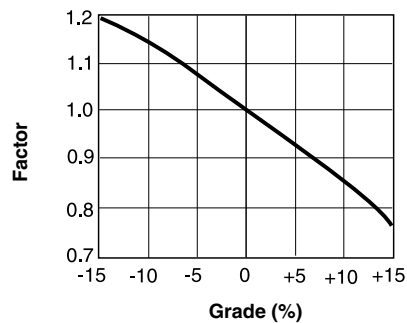

Estimated Dozing Production (Straight-tilt dozer, Power angle-tilt dozer*)

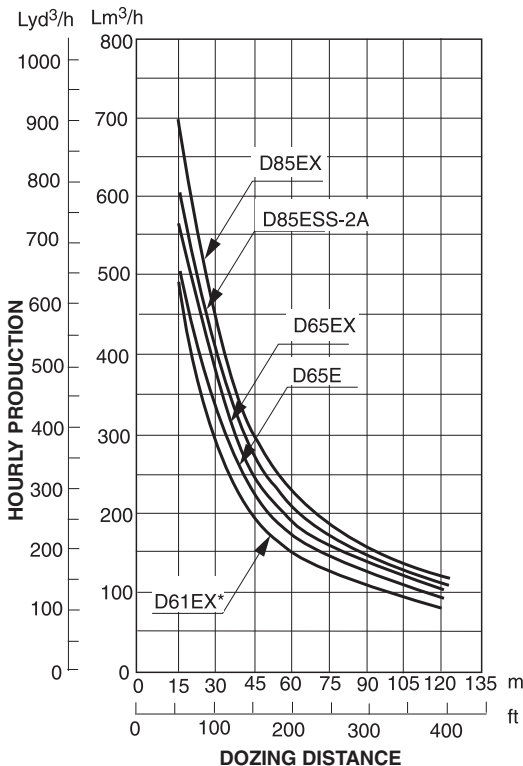

Estimated Dozing Production
(Semi-U-tilt dozer)

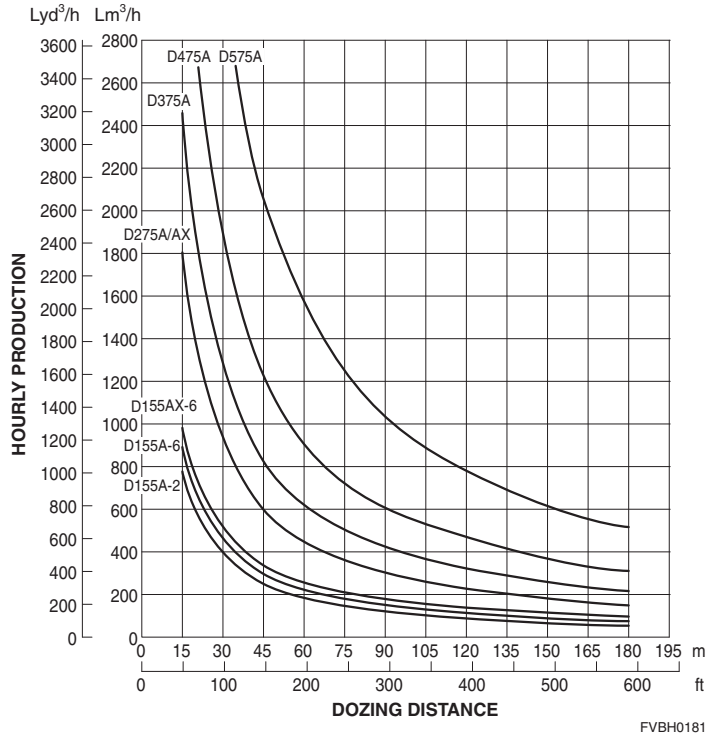

Estimated Dozing Production
(U-tilt dozer)

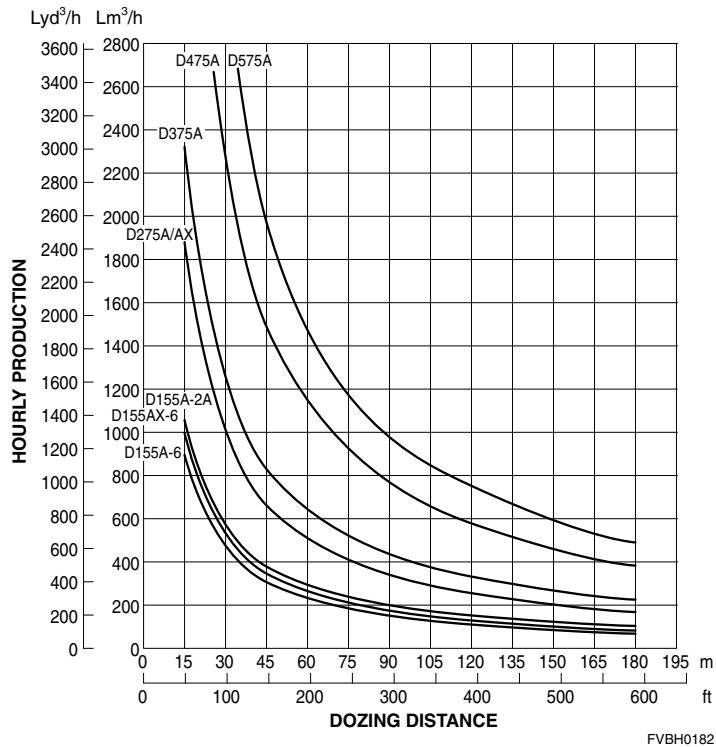

**Estimated Dozing Production
(Super Dozer)**

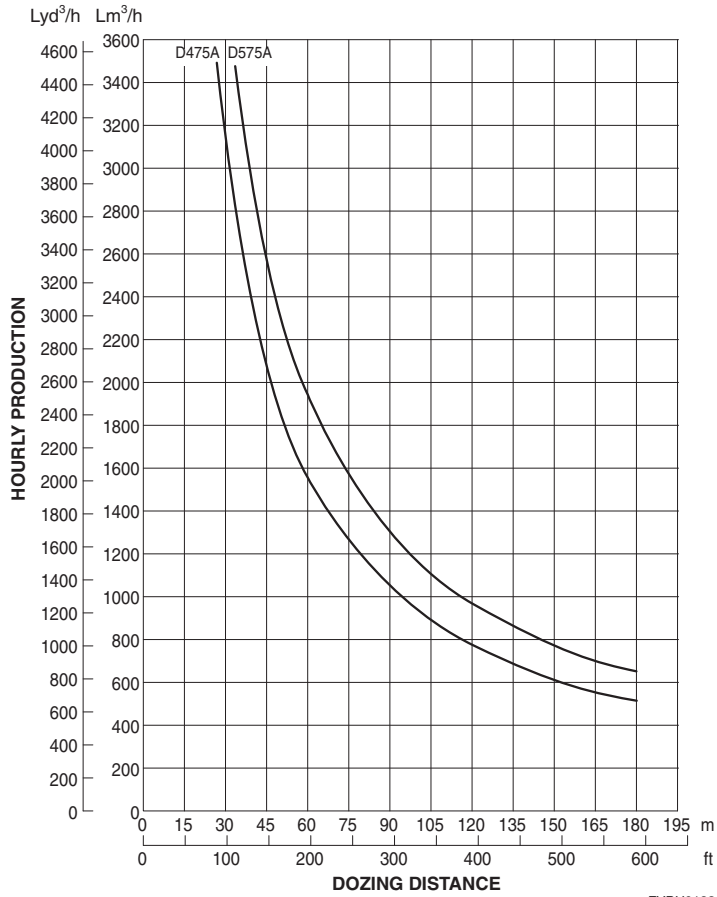

FVBH0183

**Estimated Dozing Production for Low Ground Pressure Bulldozers
(Straight-tiltdozer, Power Angle-tiltdozer*)**

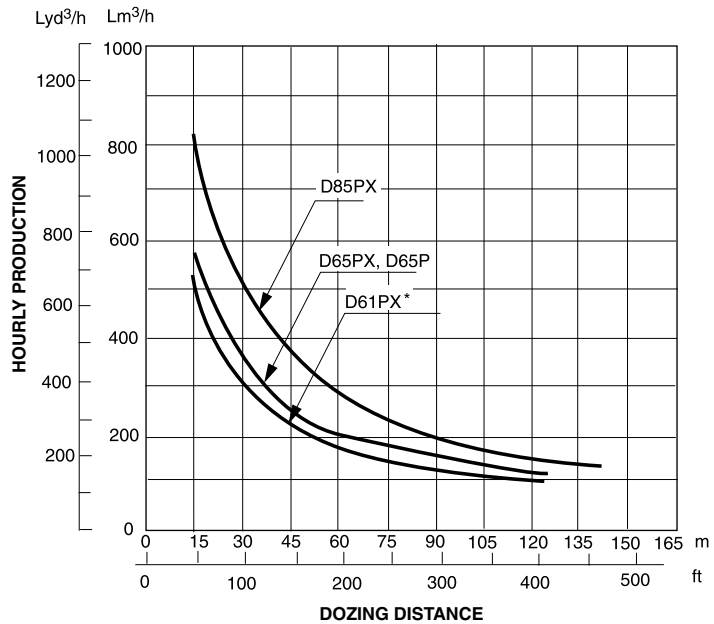

MEMO

A series of horizontal dashed lines for writing.

SECTION **1C**

RIPPERS

CONTENTS

Features 1C-2

Specification:

- Multi-shank Ripper (Rigid type)** 1C-3
- Multi-shank Ripper (Variable type)** 1C-5
- Giant Ripper (Variable type)** 1C-7

Ripper Selection 1C-9

Ripper Point Selection 1C-10

Production 1C-13

■ Outstanding productivity

1. Superior ripping performance is achieved through a large operating weight, high engine output and a conventional drive undercarriage.
2. Large maximum penetration depth provides high ripper production.
3. The unique linkage design enables the ripper point to draw an ideal locus during cylinder tilting for effective excavation of embedded rocks.

In the KOMATSU linkage, the lift cylinder is mounted on the beam, causing the point to make an ideal movement when the tilt cylinder is actuated.

Thus, the range of digging angles practically available is wider than the conventional type range, giving excellent digging force.

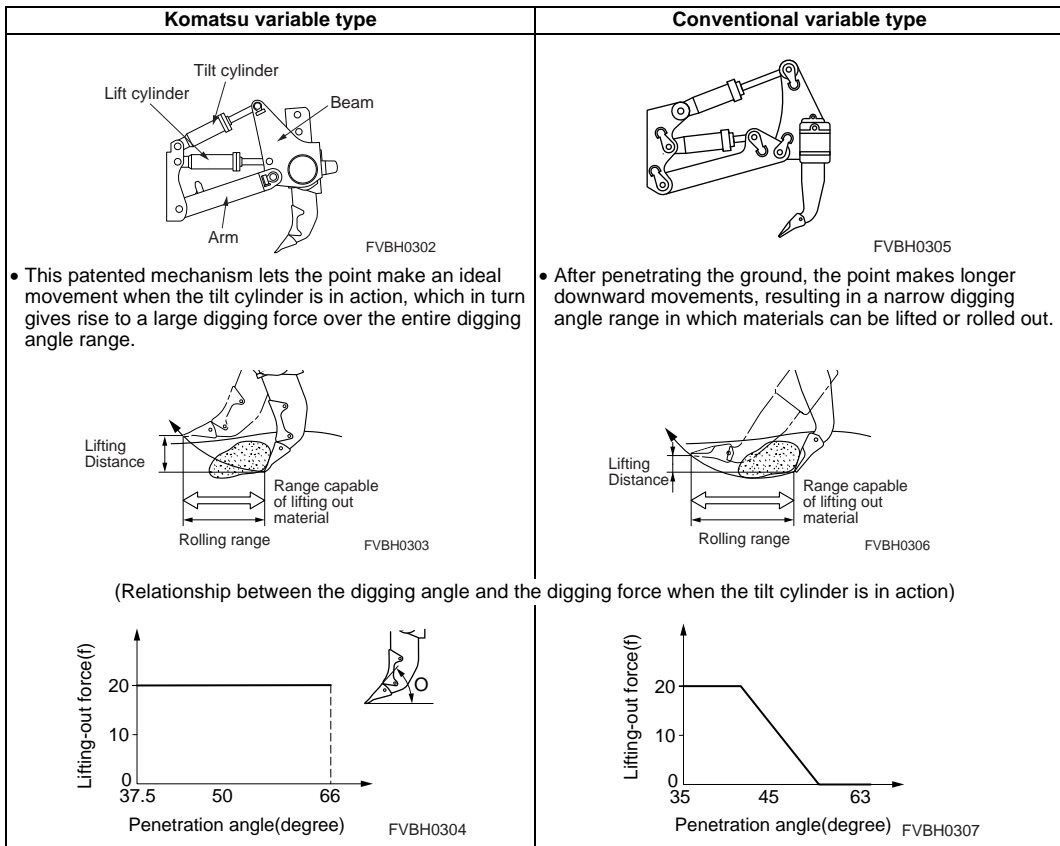

■ Minimum downtime

1. Large sectional area of the beam extends service life.
2. The forged ripper points are sharpened for excellent penetration and long service life.

■ Easy operation

1. Optional pin puller facilitates change in digging depth.

The optional pin puller mechanism functions to insert or remove the pin from its hole. This is accomplished with a hydraulic cylinder and can be accomplished by an experienced operator, from within the cab. This feature thus provides a time savings benefit.

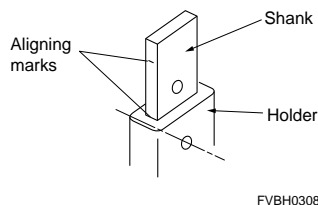
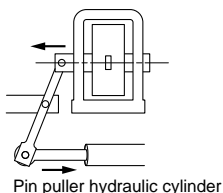

Specifications Multi-shank Ripper (Rigid type)

RIPPERS

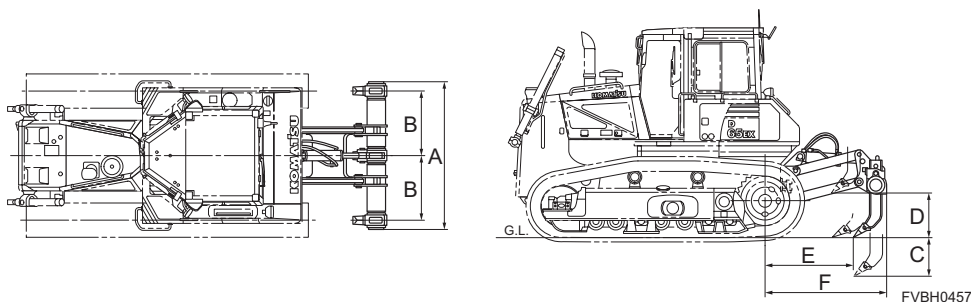

Item		Model	D31EX-22	D37EX-22	D37EX-23	D39EX-22
A	Weight**	kg (lb)	700 (1,540)* ⁴	700 (1,540)* ⁴	700 (1,540)* ⁴	700 (1,540)* ⁴
	Beam length	mm (ft.in)	1569 (5'2")	1569 (5'2")	1569 (5'2")	1569 (5'2")
B	No. of shanks		3	3	3	3
	Tooth point		Replaceable	Replaceable	Replaceable	Replaceable
	Pitch (3 shank)	mm (ft.in)	700 (2'4")	700 (2'4")	700 (2'4")	700 (2'4")
	Pitch (2 shank)	mm (ft.in)				
C	Digging angle	degree	Fixed	Fixed	Fixed	Fixed
	Digging depth		Fixed	Fixed	Fixed	Fixed
D	Max. digging depth	mm (ft.in)	339 (1'1")	339 (1'1")	326 (1'1")	273 (10.7")
E	Max. lift above ground	mm (ft.in)	387 (1'3")	387 (1'3")	369 (1'3")	453 (1'6")
F	Ripper point reach	mm (ft.in)	1363 (4'6")	1273 (4'2")	1272 (4'2")	1228 (4'0")
	Tail length	mm (ft.in)	1657 (5'5")	1567 (5'2")	1567 (5'2")	1522 (5'0")
HYDRAULIC CONTROL UNIT*		kg (lb)	20 (44)	20 (44)	20 (44)	20 (44)

Item		Model	D39EX-23	D61EX-15E0	D61EX-23	D63E-12***
A	Weight**	kg (lb)	700 (1,540)* ⁴	1645 (3,630)	1790 (3,950)	1645 (3,630)
	Beam length	mm (ft.in)	1569 (5'2")	2170 (7'1")	2170 (7'1")	2170 (7'1")
B	No. of shanks		3	3	3	3
	Tooth point		Replaceable	Replaceable	Replaceable	Replaceable
	Pitch (3 shank)	mm (ft.in)	700 (2'4")	950 (3'1")	950 (3'1")	950 (3'1")
	Pitch (2 shank)	mm (ft.in)		1900 (6'3")	1900 (6'3")	1900 (6'3")
C	Digging angle	degree	Fixed	55°, 45°	55°	55°, 45°
	Digging depth		Fixed	2-stage adjustable	3-stage adjustable	3-stage adjustable
D	Max. digging depth	mm (ft.in)	263 (10.4")	665 (2'2")	665 (2'2")	655 (2'2")
E	Max. lift above ground	mm (ft.in)	463 (1'6")	565 (1'10")	565 (1'10")	575 (1'10")
F	Ripper point reach	mm (ft.in)	1277 (4'2")	1295 (4'3")	1315 (4'4")	1295 (4'3")
	Tail length	mm (ft.in)	1572 (5'2")	1790 (5'10")	1805 (5'11")	1790 (5'10")
HYDRAULIC CONTROL UNIT*		kg (lb)	20 (44)	35 (77)	35 (77)	35 (77)

* : Including additional oil weight, except D85A

** : Including the hydraulic control unit

*** : for Russia

*⁴ : Including the ripper bracket

Specifications Multi-shank Ripper (Rigid type)

RIPPERS

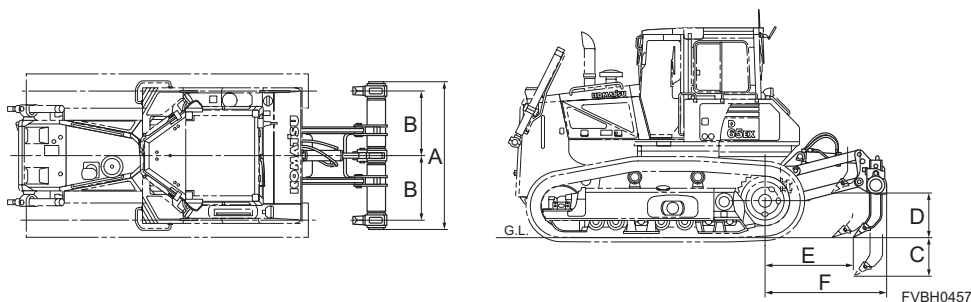

Item		Model	D65E-12	D65EX-16	D65EX-17	D85ESS-2A
A	RIPPER EQUIPMENT: Type		Parallelogram	Parallelogram	Parallelogram	Parallelogram
	Weight**	kg (lb)	1680 (3,700)	1770 (3,900)	1770 (3,900)	1680 (3,700)
B	Beam length	mm (ft.in)	2170 (7'1")	2170 (7'1")	2170 (7'1")	2170 (7'1")
	Shanks: No. of shanks		3	3	3	3
B	Tooth point		Replaceable	Replaceable	Replaceable	Replaceable
	Pitch (3 shank)	mm (ft.in)	950 (3'1")	950 (3'1")	950 (3'1")	950 (3'1")
	Pitch (2 shank)	mm (ft.in)	1900 (6'3")	1900 (6'3")	1900 (6'3")	1900 (6'3")
C	Digging angle	degree	55°, 45°	55°	55°	
	Digging depth		2-stage adjustable			2-stage adjustable
			3-stage adjustable	2-stage adjustable	2-stage adjustable	3-stage adjustable
C	Max. digging depth	mm (ft.in)	590 (1'11")	595 (1'11")	595 (1'11")	595 (1'11")
D	Max. lift above ground	mm (ft.in)	645 (2'1")	635 (2'1")	635 (2'1")	640 (2'1")
E	Ripper point reach	mm (ft.in)	1300 (4'3")	1300 (4'3")	1300 (4'3")	1295 (4'3")
F	Tail length	mm (ft.in)	1795 (5'11")	1795 (5'11")	1795 (5'11")	1790 (5'10")
HYDRAULIC CONTROL UNIT*		kg (lb)	70 (154)	24 (53)	24 (53)	70 (154)

Item		Model	D85EX-15E0 D85EX-15R			
A	RIPPER EQUIPMENT: Type		Parallelogram			
	Weight**	kg (lb)	2500 (5,520)			
B	Beam length	mm (ft.in)	2227 (7'4")			
	Shanks: No. of shanks		3			
B	Tooth point		Replaceable			
	Pitch (3 shank)	mm (ft.in)	1000 (3'3")			
	Pitch (2 shank)	mm (ft.in)	2000 (6'7")			
C	Digging angle	degree	54.5°			
	Digging depth		2-stage adjustable			
			adjustable			
C	Max. digging depth	mm (ft.in)	655 (2'2")			
D	Max. lift above ground	mm (ft.in)	565 (1'10")			
E	Ripper point reach	mm (ft.in)	1480 (4'10")			
F	Tail length	mm (ft.in)	2075 (6'10")			
HYDRAULIC CONTROL UNIT*		kg (lb)				

* : Including additional oil weight, except D85A

** : Including the hydraulic control unit

Specifications Multi-shank Ripper (Variable type)

RIPPERS

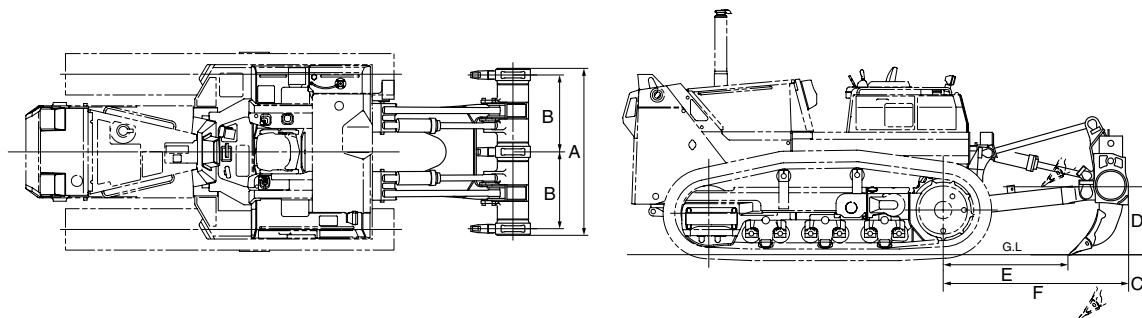

Item		Model	D155A-5	D155AX-6 D155A-6	D155AX-7	D275A-5 D275A-5E0 D275A-5R
A	RIPPER EQUIPMENT: Type		Variable digging angle type	Variable digging angle type	Variable digging angle type	Variable digging angle type
	Weight**	kg (lb)	3710 (8,180)	3760 (8,290)	3760 (8,290)	4462 (9,840)
B	Beam length	mm (ft.in)	2260 (7'5")	2320 (7' 7")	2320 (7'7")	2495 (8'2")
	Shanks:					
	No. of shanks		3	3	3	3
	Tooth point		Replaceable	Replaceable	Replaceable	Replaceable
C	Pitch (3 shank)	mm (ft.in)	1040 (3'5")	1070 (3'6")	1070 (3'6")	1130 (3'8")
	Pitch (2 shank)	mm (ft.in)	2080 (6'10")	2140 (7'0")	2140 (7'0")	2260 (7'5")
	Digging angle	degree	Std:49° Stepless adjustable	Std:49° Stepless adjustable	Std:49° Stepless adjustable	Std:51.7° Stepless adjustable
D	Digging depth		2-stage adjustable	2-stage adjustable	2-stage adjustable	2-stage adjustable
	Max. digging depth	mm (ft.in)	870 (2'10")	900 (2' 11")	900 (2'11")	900 (2'11")
E	Max. lift above ground	mm (ft.in)	925 (3')	950 (3' 1")	950 (3'1")	955 (3'2")
F	Ripper point reach	mm (ft.in)	1700 (5'7")	2100 (6'11")	2100 (6'11")	1905 (6'3")
	Tail length	mm (ft.in)	2510 (8'3")	2745 (9'0")	2745 (9'0")	2675 (8'9")
	HYDRAULIC CONTROL UNIT*	kg (lb)	90 (200)			120 (260)

Item		Model	D375A-5	D375A-5R	D375A-6	D375A-6R
A	RIPPER EQUIPMENT: Type		Variable digging angle type	Variable digging angle type	Variable digging angle type	Variable digging angle type
	Weight**	kg (lb)	6720 (14,810)	6720 (14,810)	6800 (14,990)	6800 (14,810)
B	Beam length	mm (ft.in)	2854 (9'4")	2854 (9'4")	2910 (9'7")	2910 (9'7")
	Shanks:					
	No. of shanks		3	3	3	3
	Tooth point		Replaceable	Replaceable	Replaceable	Replaceable
C	Pitch (3 shank)	mm (ft.in)	1320 (4'4")	1320 (4'4")	1320 (4'4")	1320 (4'4")
	Pitch (2 shank)	mm (ft.in)	2640 (8'8")	2640 (8'8")	2640 (8'8")	2640 (8'8")
	Digging angle	degree	Std:45° Stepless adjustable	Std:45° Stepless adjustable	Std:45° Stepless adjustable	Std:45° Stepless adjustable
D	Digging depth		2-stage adjustable	2-stage adjustable	2-stage adjustable	2-stage adjustable
	Max. digging depth	mm (ft.in)	1075 (3'6")	1170 (3'10")	1140 (3'9")	1190 (3'11")
E	Max. lift above ground	mm (ft.in)	1050 (3'5")	1090 (3'7")	1135 (3'9")	1082 (3'7")
F	Ripper point reach	mm (ft.in)	2365 (7'9")	2365 (7'9")	2345 (7'9")	2345 (7'9")
	Tail length	mm (ft.in)	3160 (10'4")	3160 (10'4")	3170 (10'5")	3165 (10'5")
	HYDRAULIC CONTROL UNIT*	kg (lb)	220 (490)	220 (490)		

* : Including additional oil weight

** : Including the hydraulic control unit

Specifications Multi-shank Ripper (Variable type)

RIPPERS

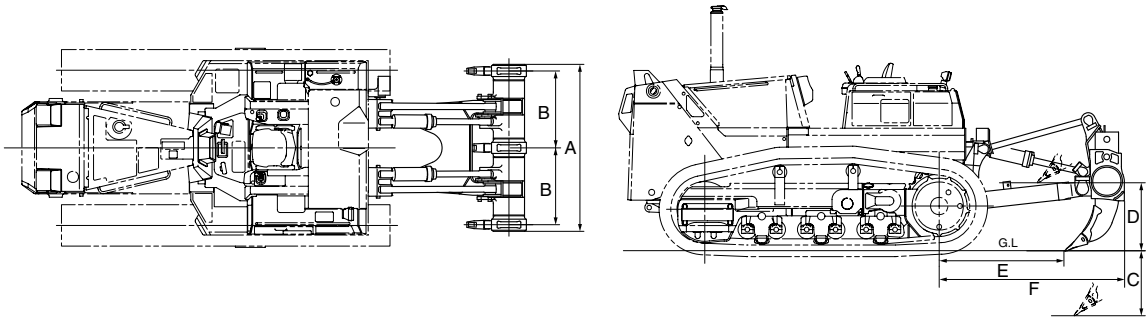

Item		Model	D475A-5E0			
	RIPPER EQUIPMENT: Type		Variable digging angle type			
A	Weight** Beam length	kg (lb) mm (ft.in)	9720 (21,430) 3085 (10' 1")			
	Shanks:					
	No. of shanks		3			
	Tooth point		Replaceable			
B	Pitch (3 shank)	mm (ft.in)	1385 (4'7")			
	Pitch (2 shank)	mm (ft.in)	2770 (9'1")			
	Digging angle	degree	Std:45° Stepless adjustable			
	Digging depth		2-stage adjustable			
C	Max. digging depth	mm (ft.in)	1124 (3' 8")			
D	Max. lift above ground	mm (ft.in)	1196 (3' 11")			
E	Ripper point reach	mm (ft.in)	2575 (8'5")			
F	Tail length	mm (ft.in)	3940 (11'5")			
	HYDRAULIC CONTROL UNIT*	kg (lb)	120 (260)			

Item		Model				
	RIPPER EQUIPMENT: Type					
A	Weight** Beam length	kg (lb) mm (ft.in)				
	Shanks:					
	No. of shanks					
	Tooth point					
B	Pitch (3 shank)	mm (ft.in)				
	Pitch (2 shank)	mm (ft.in)				
	Digging angle	degree				
	Digging depth					
C	Max. digging depth	mm (ft.in)				
D	Max. lift above ground	mm (ft.in)				
E	Ripper point reach	mm (ft.in)				
F	Tail length	mm (ft.in)				
	HYDRAULIC CONTROL UNIT*	kg (lb)				

* : Including additional oil weight
 ** : Including the hydraulic control unit

Specifications Giant Ripper (Variable type)

RIPPERS

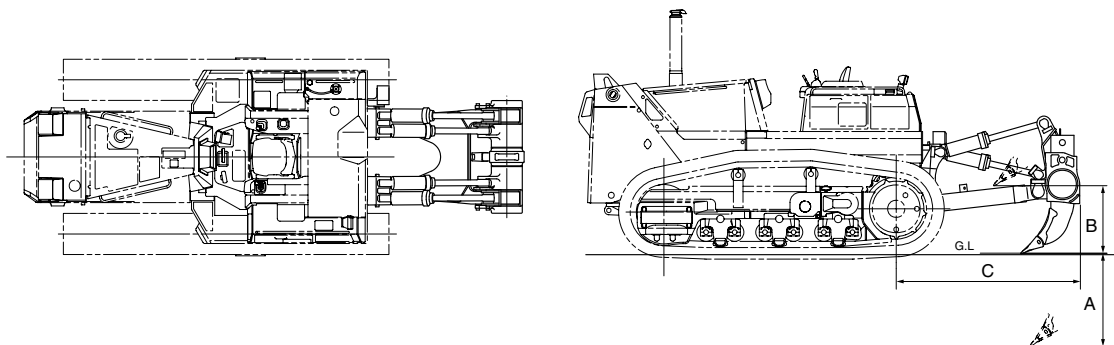

Item		Model	D155A-5	D155AX-6	D155AX-6***	D155A-6
	RIPPER EQUIPMENT: Type		Variable digging angle type	Variable digging angle type	Variable digging angle type	Variable digging angle type
	Weight**	kg (lb)	2760 (6,080)	2440 (5380)	3380 (7450)	3380 (7450)
	Shanks: No. of shanks Tooth point Digging angle	degree	1 Reversible Std:49° Stepless adjustable	1 Reversible Std:49° Stepless adjustable	1 Reversible Std:49° Stepless adjustable	1 Reversible Std:45° Stepless adjustable
	Digging depth		3-stage adjustable	3-stage adjustable	3-stage adjustable	3-stage adjustable
A	Max. digging depth	mm (ft.in)	1220 (4')	1240 (4'1")	1370 (4'6")	1370 (4'6")
B	Max. lift above ground	mm (ft.in)	925 (3')	950 (3'1")	945 (3'1")	900 (2'11")
C	Tail length	mm (ft.in)	2510 (8'3")	2745 (9'0")	3100 (10'2")	3100 (10'2")
	HYDRAULIC CONTROL UNIT*	kg (lb)	90 (200)			

Item		Model	D155AX-7	D275A-5 D275A-5R	D275AX-5E0	D375A-5
	RIPPER EQUIPMENT: Type		Variable digging angle type	Variable digging angle type	Variable digging angle type	Variable digging angle type
	Weight**	kg (lb)	2440 (5,380)	4600 (10,140)	3600 (7,940)	5470 (12,060)
	Shanks: No. of shanks Tooth point Digging angle	degree	1 Replaceable Std:49° Stepless adjustable	1 Replaceable Stepless adjustable	1 Replaceable Std:42.7° Stepless adjustable	1 Replaceable Std:45° Stepless adjustable
	Digging depth		3-stage adjustable	3-stage adjustable	3-stage adjustable	3-stage adjustable
A	Max. digging depth	mm (ft.in)	1240 (4'1")	1420 (4'8")	1300 (4'3")	1435 (4'8")
B	Max. lift above ground	mm (ft.in)	950 (3'1")	1195 (3'11")	870 (2'10")	1060 (3'6")
C	Tail length	mm (ft.in)	3045 (10'0")	3060 (10'0")	3030 (9'11")	3450 (11'4")
	HYDRAULIC CONTROL UNIT*	kg (lb)		120 (260)	120 (260)	60 (130)

* : Including additional oil weight , except D85A

** : Including the hydraulic control unit

Specifications Giant Ripper (Variable type)

RIPPERS

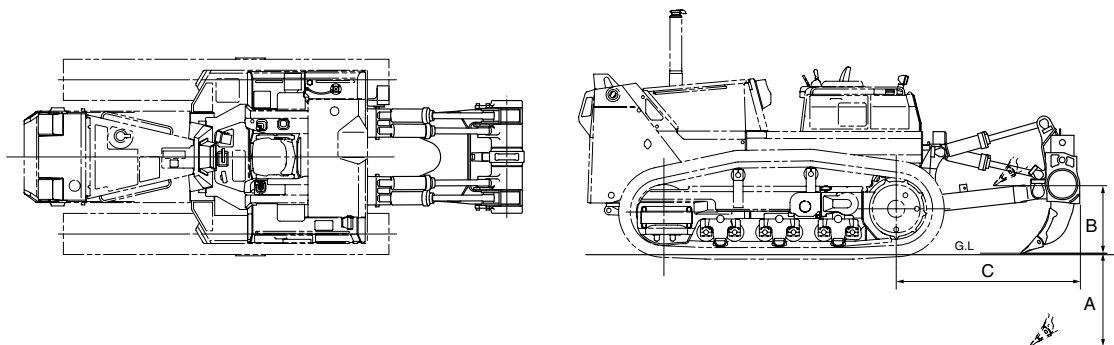

Item		Model	D375A-5R	D375A-6	D375A-6R	D475A-5E0
	RIPPER EQUIPMENT: Type		Variable digging angle type	Variable digging angle type	Variable digging angle type	Variable digging angle type
	Weight**	kg (lb)	5470 (12,060)	6200 (13,670)	6200 (13,670)	7360 (16,230)
	Shanks: No. of shanks Tooth point Digging angle	degree	1 Replaceable Std:45° Stepless adjustable	1 Replaceable Std:45° Stepless adjustable	1 Replaceable Std:45° Stepless adjustable	1 Replaceable Std:45° Stepless adjustable
	Digging depth		3-stage adjustable	2-stage adjustable	2-stage adjustable	4-stage adjustable
A	Max. digging depth	mm (ft.in)	1420 (4' 8")	1485 (4'10")	1538 (5'1")	1744 (5' 9")
B	Max. lift above ground	mm (ft.in)	1420 (4' 8")	1100 (3'7")	1050 (3'5")	1196 (3' 11")
C	Tail length	mm (ft.in)	3450 (11' 4")	3460 (11' 4")	3460 (11' 4")	3720 (12'2")
	HYDRAULIC CONTROL UNIT*	kg (lb)				

Item		Model	D575A-3			
	RIPPER EQUIPMENT: Type		Variable digging angle type			
	Weight**	kg (lb)	10530 (23,210)			
	Shanks: No. of shanks Tooth point Digging angle	degree	1 Replaceable Std:45° Stepless adjustable			
	Digging depth		5-stage adjustable			
A	Max. digging depth	mm (ft.in)	2050 (6' 9")			
B	Max. lift above ground	mm (ft.in)	1290 (4' 3")			
C	Tail length	mm (ft.in)	3755 (12' 4")			
	HYDRAULIC CONTROL UNIT*	kg (lb)	150 (330)			

* : Including additional oil weight , except D85A

** : Including the hydraulic control unit

Multi-shank rippers (Rigid type)

Highly efficient ripping of soft rock is possible with three shanks. The parallelogram ripper linkage maintains the shanks at the optimum digging angle during operation, regardless of the shank's penetrating depth.

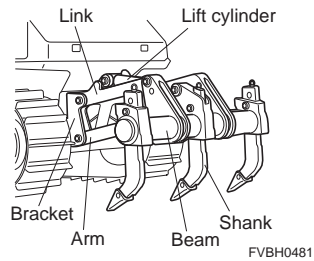

Multi-shank rippers (Variable type)

The ripper point angle can be varied hydraulically to suit the specific ground conditions.

The ideal movement of ripper points ensures powerful digging force throughout the entire digging angle range.

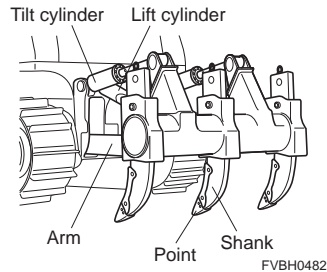

Giant rippers (Variable type)

Specially made to handle hard rock with reinforced beam and a shank.

The tilt angle of the ripper point is adjustable for better penetration and fragmentation.

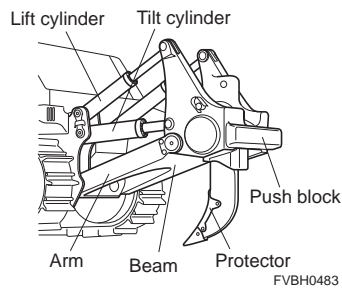

1. COMPARISON BETWEEN THE MULTI-SHANK AND GIANT (SINGLE SHANK) RIPPERS

Multi-shank Ripper		Giant Ripper	
M-1	Three tips provide high efficiency ripping of soft rock.	G-1	Sturdy construction. Suitable for harder rocks.
M-2	Foot of cliffs or slopes can be ripped by using the left or right tip.	G-2	Push plate allows tandem ripping.
M-3	Adaptable to hard or soft rock by increasing or decreasing the number of shanks.	G-3	Deep penetration and large distance from shank to rear of bulldozer make it possible to handle large rocks.
		G-4	Pin puller simplifies changing shank length.

2. COMPARISON BETWEEN THE RIGID AND VARIABLE TYPE RIPPERS

Rigid type Ripper		Variable type Ripper	
F-1	Simple construction and low price.	V-1	Digging angle can be adjusted to obtain optimum conditions for type of rock and slope of ground.
F-2	Constant digging angle.	V-2	Digs out boulders easily.
F-3	Simple hydraulic circuit means fewer oil leaks.	V-3	Tilting function makes it possible to cut roots.

Various types of ripper points are available, and the general standards for selection according to the type of use are given below.

1. Types of ripper points

Ripper points are categorized according to the following three items.

Material	There are two main types: Heat-resistant type and high-toughness type. These are distinguished with a red mark and yellow mark, respectively.
Point length	There are two types: Long and short
Shape	There are two types: A symmetric type that can be turned and the non-symmetric type that cannot be turned.

When combining of these categories, 4~7 types of points are available for each model.

2. Features of each type of point

Red	Has high resistance to wear from generation of heat at the point tip, but compared with the yellow point, it lacks toughness.
Yellow	Compared with the red point, this has excellent toughness, but it has inferior wear life when heat is generated at the point.

If the point does not dig into the rock, but slips on the rock surface, the friction heat between the point and rock causes an extreme rise in temperature of the point, thus reducing point hardness.

There is a close relationship between hardness and wear: The higher the hardness, the less the wear.

Also there is a close relationship between increased temperature of the point and excellent wear of the point (abnormal wear).

The red point has superior heat resistance, it retains its hardness better than the yellow point as the temperature increases. Thus, the red point is advantageous for hard rock applications, which is where extreme point temperatures are typically seen. The trade off is that due to the higher hardness of the point, it is more brittle, and thus more susceptible.

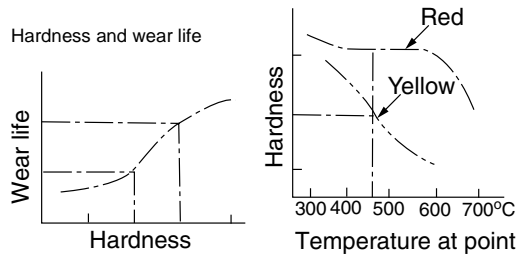

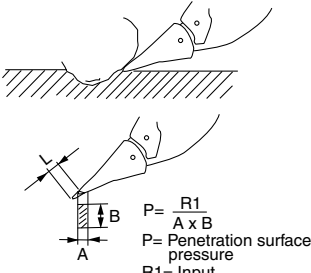
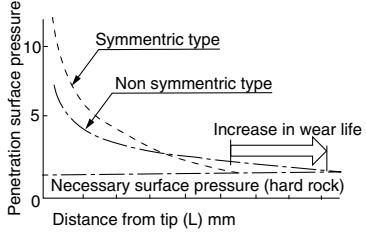
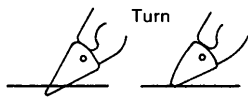
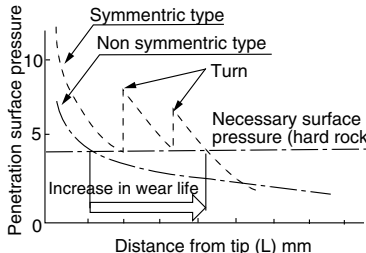
Long	Has a wear life 1.5 ~ 2.0 times greater than the short point, but its strength is inferior to the short point because of its extra length.
Short	Compared with the long point, it has superior strength, but has inferior wear life compare to the long point.
Non-symmetric type	<p>This has a self-sharpening shape, so it always retains its cutting edge, and provides a long life on jobsites where there is soft rock and penetration ability is not required. The rib provided only on the top surface wears gradually under the flow of the soil, and there is no change in the penetration surface pressure.</p>  <p> $P = \frac{R1}{A \times B}$ P = Penetration surface pressure R1 = Input </p> 
Symmetric type (can be turned)	<p>On hard rock where penetration ability is needed, it is possible to restore the penetration ability by turning the point.</p>  

The table below gives a summary of the features of each type of point.

Length	Color	Shape	Seismic velocity	Wear tolerance	Strength, resistance to impact	Abnormal wear	Penetration	Cost
Short	Yellow	Symmetric type	No particular limit	○	⊙	○	⊙	4
		Non symmetric type					○	
	Red	Symmetric type			○	⊙	⊙	2
		Non symmetric type			○	○		
Long	Yellow	Non symmetric type	(As a guideline) Max. 1500m/sec		○	○	○	3
	Red	Non symmetric type			△	⊙	○	1

Key ⊙: Good, ○: Average, △: Poor
 Cost: 1 (Most expensive), 4 (Least expensive)

Procedure for selection

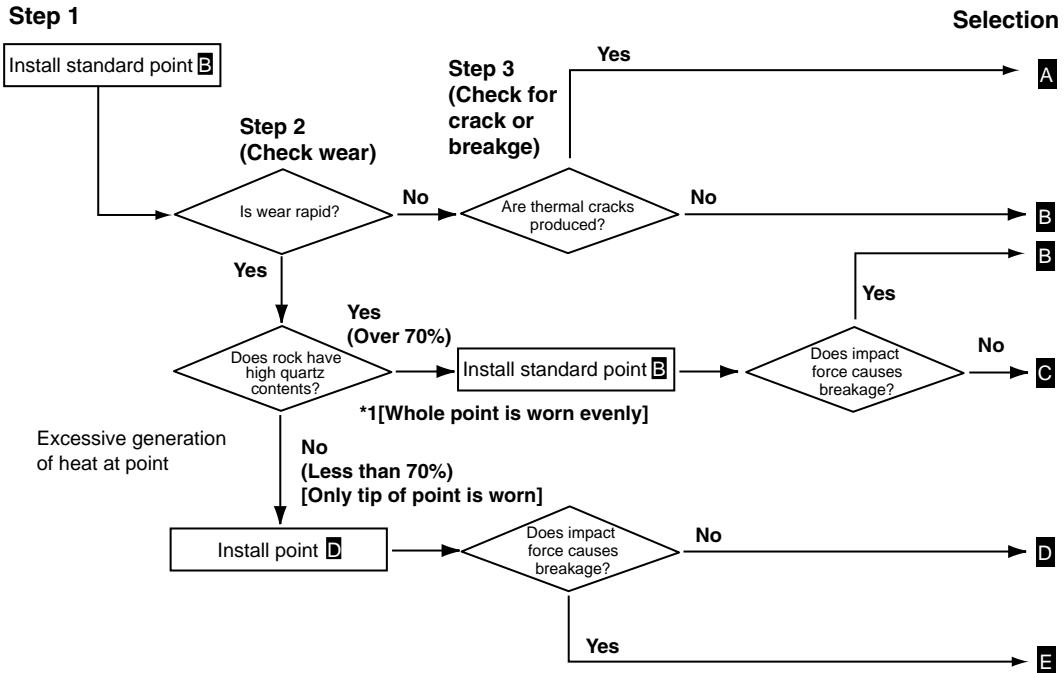

Selection	Typical rock			Suitable point		Availability								
	Hardness	Type of rock	Features		Shape	D85EX-15E0	D155AX-6	D155AX-7	D155A-6	D275AX-5E0	D275A-5R	D375A-6R	D375A-6	D475A-5E0
A	Soft ↕ Hard	Shale, lime stone	<ul style="list-style-type: none"> Little quartz, little wear Deposited in layers, so ripping is easy 	Point for limestone	<ul style="list-style-type: none"> Symmetric shape Yellow Short 									
B	Soft ↕ Hard	All types of general rock	—	Standard point	<ul style="list-style-type: none"> Symmetric shape Yellow Short 									
C	Soft ↕ Medium	Sandstone	<ul style="list-style-type: none"> Proportion of quartz is extremely high (70%-95%), point wears rapidly 	Non-symmetric Shape	<ul style="list-style-type: none"> Yellow Long 									
D	Soft ↕ Hard	Basalt andesite, granite, chert	<ul style="list-style-type: none"> Proportion of quartz is not so high (40%-70%) Rock is not composed of layers or seams, so heat is generated at point, point wears rapidly, ripping is difficult 	Non-Symmetric Shape	<ul style="list-style-type: none"> Red Long 									
E	Hard			Symmetric Shape	<ul style="list-style-type: none"> Red Short 									

* 1: When the point is worn uniformly, not only the tip of the point is worn, but also the thickness of the housing metal (place where shank enters) is also worn. On job sites where wear is rapid, it does not necessarily mean that the red point is suitable. There are many reasons why the point wears. Of these, rock hardness and the silica content are major causes. Therefore, even on soft rock, if there is a high silica content, there will be rapid wear of the point even though the temperature of the point does not rise greatly. As explained under the features of the red point, in such job sites, the advantages of the red point cannot be made use of. (On these job sites, there is no great difference in the wear life between the red and yellow points.)

Not all material can be ripped. Whether or not a rock can be ripped can be determined by any of the following methods:

- 1) By the type of rock
- 2) By an indoor rock test
- 3) By a field rock test
- 4) By a digging test with the ripper in the field.

Method 4) is most effective. If the user has no experience in ripping, an actual ripping operation should be demonstrated for the user by an operator experienced in ripping. Methods 1) and 3) are described below :

Determination of rippability by type of rock

Rocks are classified into sedimentary (aqueous), igneous, and metamorphic. The following general rules apply:

- 1) Sedimentary rocks such as sandstone, limestone, and shale can be ripped easily. Sedimentary rocks are usually found stratified in layers which vary in thickness. The thinner the layers, the easier it is to rip them.
- 2) Igneous rocks such as granite, basalt, and andesite are not found in distinct layers or cleavage planes, and this makes them difficult to rip.
- 3) Metamorphic rocks such as gneiss, schist, and quartzite vary in rippability according to the degree of stratification or cleavage.

Rippability depends not only on the type of rock, but also on the degree of weathering or fracturing.

Characteristics which determine the ease of rippability are summarized below.

<p>• Favorable rock for ripping</p> <ul style="list-style-type: none"> — Stratified — Weathered — Brittle, crystalline nature — High degree of laminations or thin layers. — Fractured — Faults or planes of weakness.
<p>• Unfavorable rock for ripping</p> <ul style="list-style-type: none"> — Fine-grained with a solid cementing agent. — Moisture, which tends to solidify the rock surface layer. — Lacking planes of weakness — Massive and homogeneous — Non-crystalline and not brittle

Determination of rippability by in-the-field rock test.

Seismic wave velocity tests are used to estimate the rippability of rock. In this test, an artificial earthquake is introduced and the travel speeds of seismic waves through different kinds of sub-surface materials are measured. Thus the degree of consolidation, thickness of sub-surface layers, hardness, degree of fracturing, stratification, and weathering can be determined .

The chart below compares ripper performance to seismic velocities. It should be used ONLY A ROUGH GUIDE, because ripper performance is subject to many other conditions.

D155A/D155AX Giant Ripper

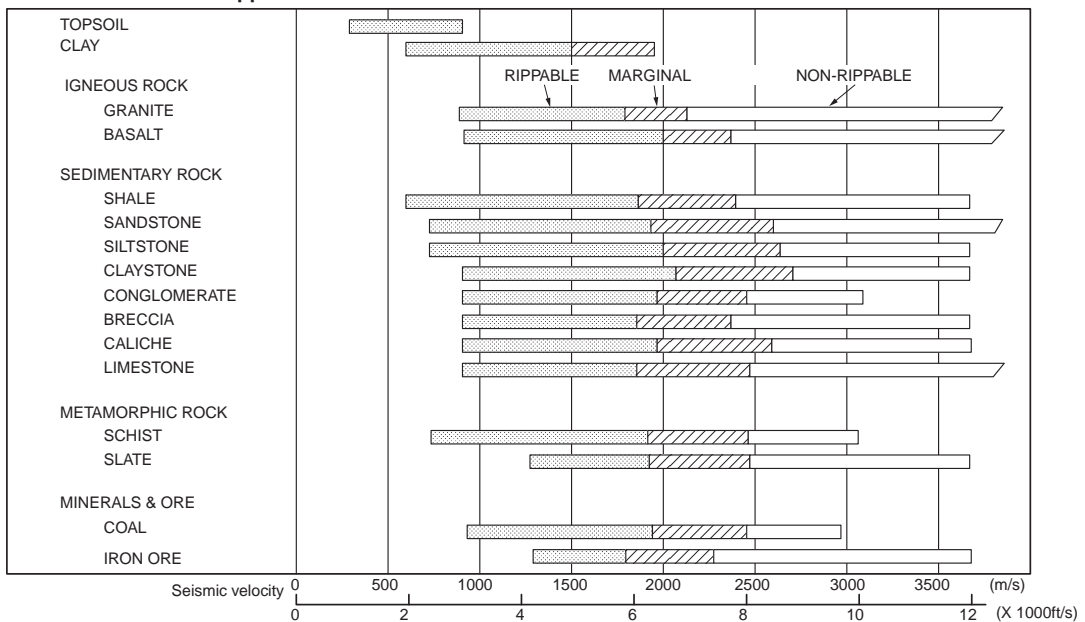

FVBH0259

The chart below compares ripper performance to seismic velocities. It should be used ONLY A ROUGH GUIDE, because ripper performance is subject to many other conditions.

D275A / D275AX Giant Ripper

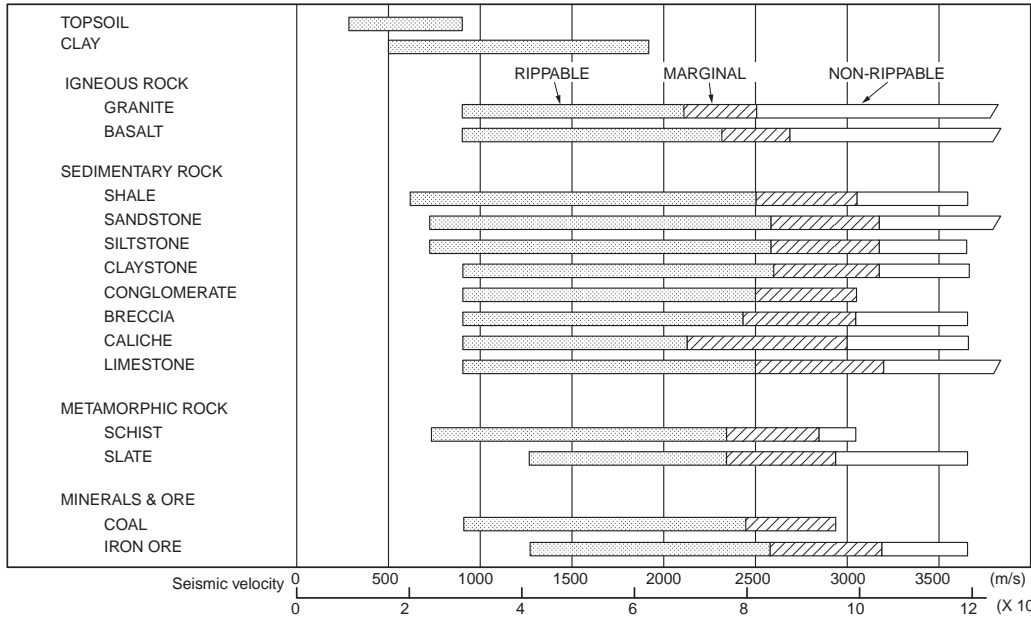

FVBH0260

D375A Giant Ripper

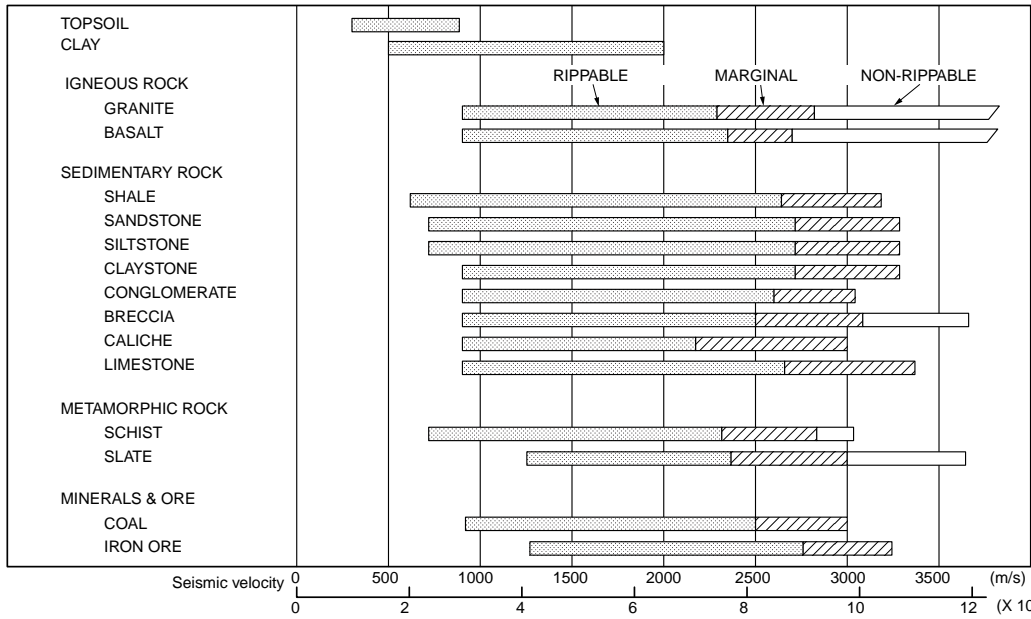

FVBH0261

D475A Giant Ripper

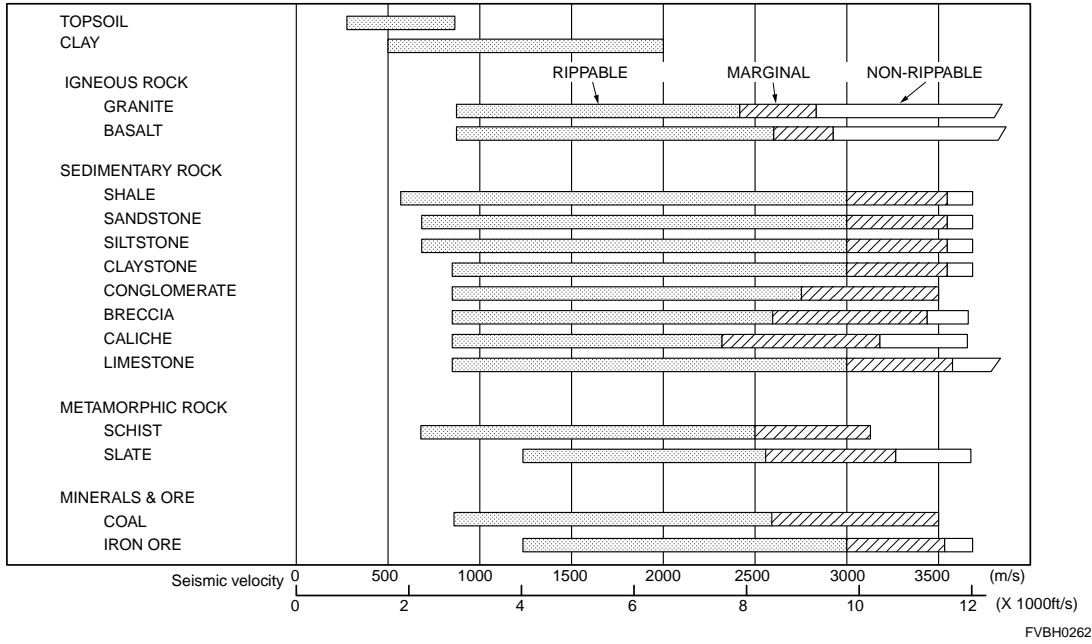

D575A Giant Ripper

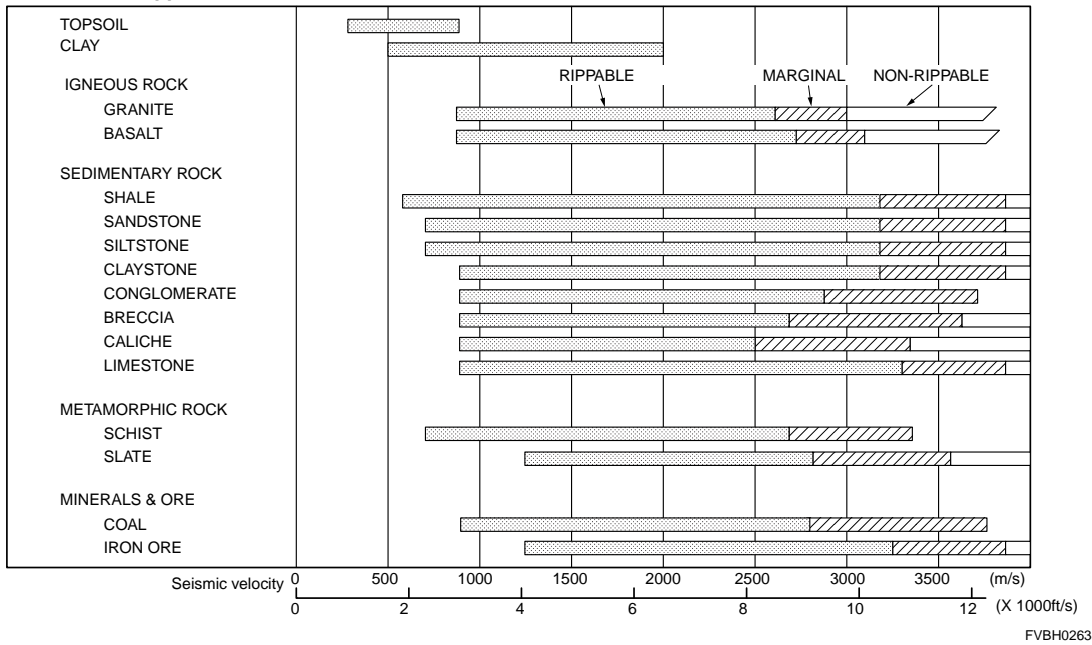

Since ripper performance varies considerably with the characteristics of the rocks, the work methods, and operator's skill, it is impossible to estimate performance accurately. However, based on accumulated data, the relationship between seismic wave velocity and production can be ESTIMATED ROUGHLY as shown in the graph. This graph applies only to ripping operations.

This graph is based on numerous field studies.

Actual production should be estimated as follows.

$$\text{Actual production} = (\text{Standard production}) \times (\text{Job efficiency})$$

Job Efficiency (E)

Operation conditions	E
Good	0.75 (45 min out of an hour use)
Average	0.58 (35 min out of an hour use)
Rather poor	0.50 (30 min out of an hour use)
Poor	0.40 (25 min out of an hour use)

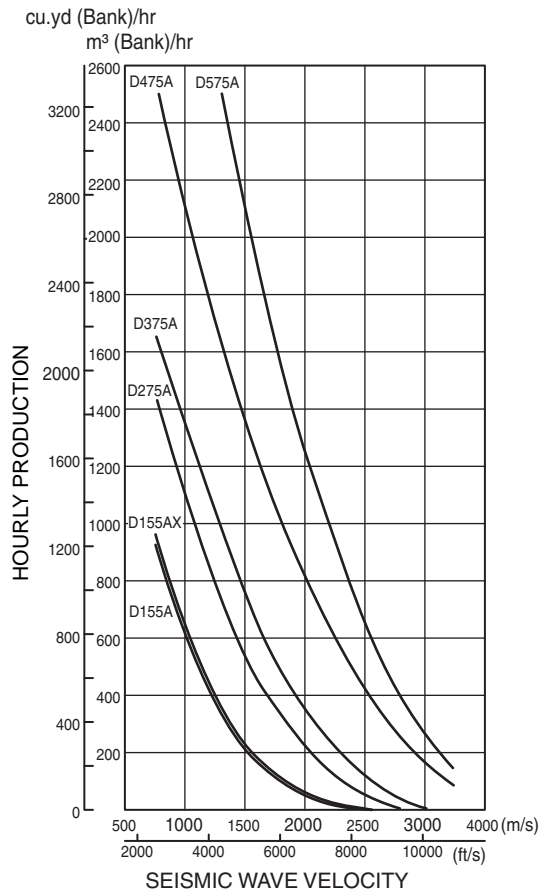

FVBH0184

Conditions

- 1) Ripping production only
- 2) Bulldozers with single shank rippers
- 3) 100% job efficiency

NOTE: Production is given in bank.

SECTION **1D**

TOWING WINCHES

CONTENTS

Specifications 1D-2

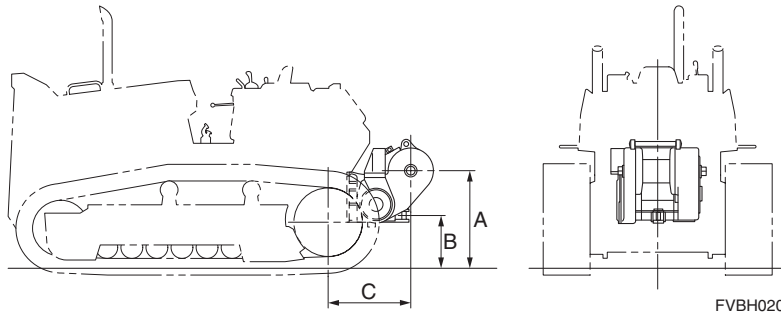

FVBH0201

Item	Model	D68ESS-12	D85ESS-2		
Type		Wet type	Wet type		
Weight	kg (lb)	1570 (3,455)	1290 (2,840)		
DIMENSION					
A: Ground to drum center	mm (ft.in)	1145 (3'9")	1201 (3'11")		
B: Ground to hitch center	mm (ft.in)	610 (2')	650 (2'2")		
C: Sprocket center to drum center	mm (ft.in)	945 (3'1")	1066 (3'6")		
Drum dimension:					
Length	mm (ft.in)	975 (3'2")	1005 (3'4")		
Width	mm (ft.in)	996 (3'3")	1070 (3'6")		
Height	mm (ft.in)	980 (3'3")	980 (3'3")		
Drum diameter	mm (ft.in)	254 (10")	254 (10")		
Flange diameter	mm (ft.in)	510 (1'8")	510 (1'8")		
Drum width	mm (ft.in)	320 (1'1")	320(1'1")		
Cable:					
Cable dia. × length	mm × m (in × ft)	28.6 × 50 (1.12 × 165)	26 × 73 (1.02 × 240)		
Performance:					
Line speed:					
Bare drum	m/min. (FPM)	F28 (92) R63 (207)	F28 (92) R63 (207)		
Full drum	m/min. (FPM)	F48 (157) R110 (361)	F48 (157) R110 (361)		
Line pull:					
Bare drum	kg (lb)	26910 (59,322)	31400 (69,220)		
Full drum	kg (lb)	15570 (34,323)	18200 (40,120)		

SECTION **1E**

PIPELAYERS

CONTENTS

Features	1E-2
Specifications	1E-3
Lifting Capacity	1E-4

Faster, effortless winch control

- Komatsu pipelayers require only three levers for winch control, one each for the transmission, hook and boom.
- Choice of hook speeds for raising and lowering facilitates stringing, cradling and lowering in.

Big lifting capacity

- Komatsu pipelayers have the largest lifting capacity in their respective classes.
- Adjustment of the counterweights is made hydraulically and conveniently by a lever beside the operator's seat for machine balance.

Safe operation

- Komatsu pipelayers offer safety features to keep operators working confidently.
- All machines are standardly equipped with an automatic boom maximum stopper device.
- There is a free-fall setting on the hook control lever for use during an emergency.
- Komatsu pipelayers have a closed-type winch brake that prevents slips during operation in wet weather.
- Because the hook wires are located away from the operator, danger in the event of a wire cut is minimized.

Proven, stable undercarriage

- Main components of these three machines are basically the same as those of the Komatsu D355A, D155A and D85A bulldozers. They have a proven record for reliable and durable performance, plus easy maintenance.
- A wide track gauge, large length of track on ground and counterweights give these pipelayers more stability to operate on steep slopes .

Item		Model	D85C-21	D155C-1	D355C-3
OPERATING WEIGHT	kg (lb)		30050 (66,250)	45800 (100,970)	57850 (127,540)
MAX. LIFTING CAPACITY	kg (lb/kN)		41000 (90,390/402)	70000 (154,320/686)	92000 (202,820/902)
HORSEPOWER	kW (HP)/RPM		168 (225)/2000	239 (320) /2000	269 (360)/2000
DIMENSIONS:					
Overall length	mm (ft.in)		4805 (15'9")	5840 (19'2")	6030 (19'9")
Overall width*	mm (ft.in)		3490 (11'5")	3760 (12'4")	4405 (14'5")
Overall height	mm (ft.in)		3640 (11'11")	3845 (12'7")	3925 (12'11")
Track gauge	mm (ft.in)		2250 (7'5")	2380 (7'10")	2550 (8'4")
Length of track on ground	mm (ft.in)		2730 (8'11")	3620 (11'11")	3750 (12'4")
Ground contact area	cm ² (sq.in)		33300 (5,160)	51400 (7,967)	64500 (10,000)
Ground pressure	kg/cm ² (PSI/kPa)		0.90 (12.8/88.3)	0.89 (12.66/87.3)	0.90 (12.8/88.3)
PIPELAYING EQUIPMENT:					
Hook speeds:(bare drum)	m/min (FPM)				
Raise	1st		9.6 (31.5)	6.0 (19.7)	5.5 (18.0)
Lower	1st		21.7 (71.2)	13.8 (45.3)	12.7 (41.7)
2nd	2nd		9.3 (30.5)	4.8 (15.7)	4.5 (14.8)
2nd	2nd		21.1 (69.2)	11.1 (36.4)	10.2 (33.5)
Boom: Length	mm (ft.in)		5500 (18'1")	6200 (20'4")	7300 (23'11")
Winch: Type			H.C**	H.C**	H.C**
ENGINE:					
Model			KOMATSU S6D125	KOMATSU SA6D140	KOMATSU SA6D140
No.of cylinders- bore × stroke	mm (in)		6-125 × 150 (4.92 × 5.91)	6-140 × 165 (5.51 × 6.50)	6-140 × 165 (5.51 × 6.50)
Piston displacement	ltr (cu.in)		11.04 (674)	15.24 (930)	15.24 (930)
PERFORMANCE:					
Travel speeds	km/h (MPH)				
Forward/Reverse	1st		3.5 (2.2)/4.7 (2.9)	3.6 (2.2)/4.4 (2.7)	3.3 (2.1)/3.9 (2.4)
2nd	2nd		6.5 (4.0)/8.3 (5.2)	6.6 (4.1)/7.8 (4.8)	5.9 (3.7)/7.0 (4.3)
3rd	3rd		10.7(6.6)/13.3(8.3)	11.2(7.0)/12.4(7.7)	9.8(6.1)/11.0(6.8)
UNDERCARRIAGE:					
No. of rollers	(Carrier/track)		2/6	2/8	2/8
Shoe width					
Standard	mm (in)		610 (24.0)	710 (28.0")	860 (34.0)
Optional	mm (in)		660 (26.0)	760 (30.0")	960 (38.0)
			710 (28.0)		1010 (40.0)

* : Counterweight retracted, excluding boom
 ** : Hydraulically-controlled double-drum, reversible

D155C-1

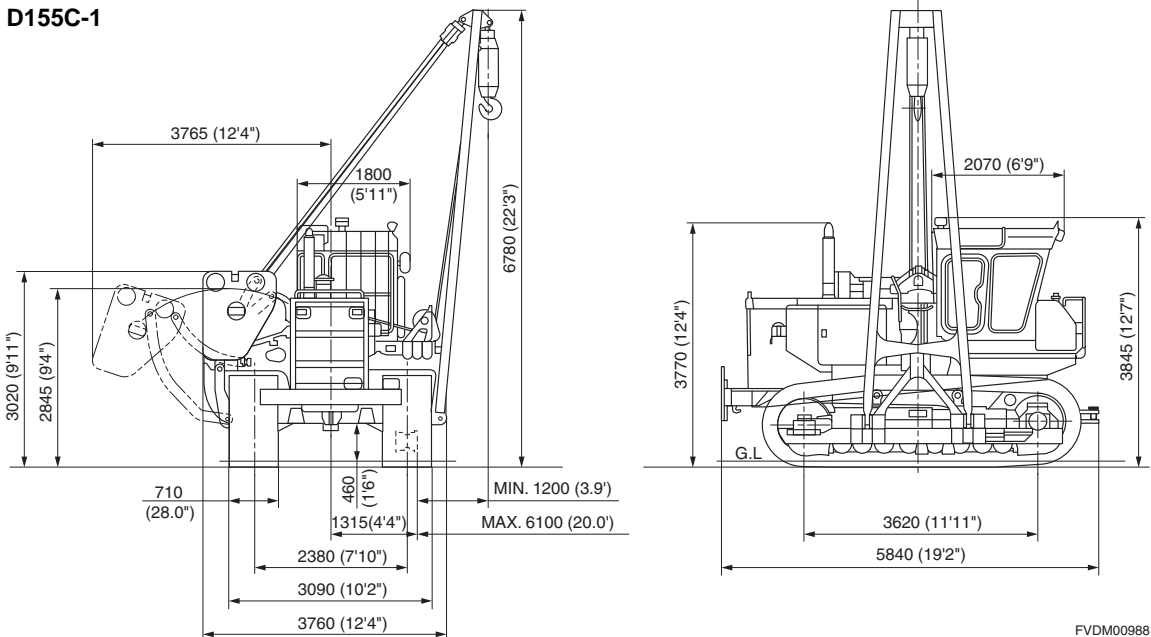

FVDM00988

D85C-21

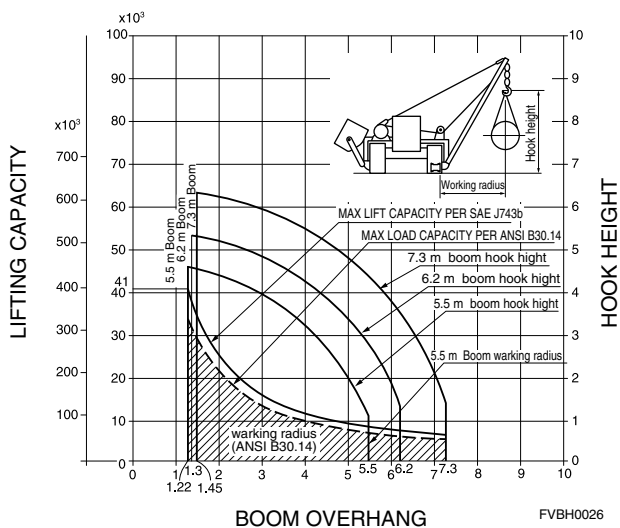

D155C-1

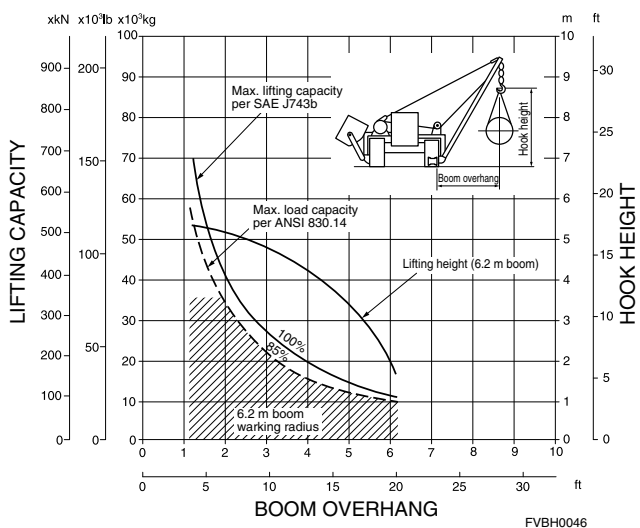

D355C-3

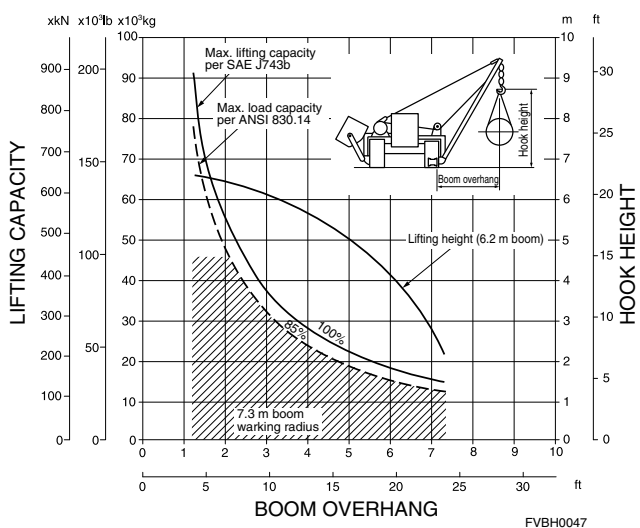

TRIMMING DOZERS

CONTENTS

Trimming Operation in Vessel1F-2
Design Features1F-3
Standard Equipment1F-5
Track Shoe Selection1F-6
Specifications1F-7

Trimming Operation in Vessel

TRIMMING DOZERS

Unloading clamshell buckets and pneumatic unloader have been conventionally used to unload bulk cargoes (grain, salt, sugar, coal, ore fertilizer, chips, etc.) from vessels. However, the bucket scooping amount or suction decreases when the unloading work progresses, resulting in a corresponding deterioration of unloading efficiency.

This reduced efficiency means that vessels must remain longer in port, leading to a direct lowering of vessel operating efficiency and a substantial increase in port charges. Consequently, it has become necessary to find an effective method to facilitate bulk unloading. The conventional method is bulk cargoes were raked manually has been replaced by the bulldozer, and a trimming dozer has now been developed specifically for the handling of bulk cargoes in vessels.

Wheel loaders have often been employed at the final stages of unloading to protect the bottom of the vessel hold, however these have been replaced quite recently by trimming dozers equipped with rubber crawler.

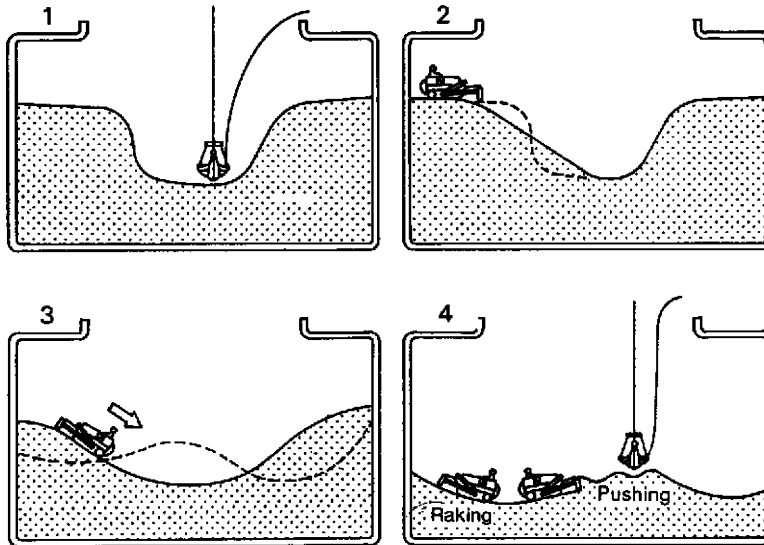

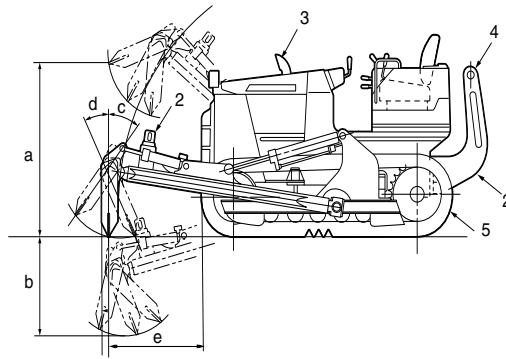

(1) Trimming blade

Since the maximum lift (a), maximum drop (b), forward pitch angle (c) and backward pitch angle (d) of the blade are larger than usual and the breast dimension (e) is longer, substantially greater amounts of the bulk cargo can be raked and pushed at a time.

(2) Rear protector

Even if the trimming dozer inadvertently touches the hold frame, shoring, etc., the protector effectively prevents damage to the fuel and hydraulic oil tanks.

(3) Short exhaust pipe

A short exhaust pipe has been fitted to the trimming dozer to reduce overall height.

(4) Slinging hooks

The trimming dozer is provided with slinging hooks to enable it to be lowered into the hold.

(5) Track coming off prevention

Bulk cargo material caught between the tracks and sprocket is released through holes provided in the shoes, and this prevents the tracks from coming off.

(6) Dust preventive measures

Exhaust gas remains inside the hold, and dust resulting from the operation of the blade and the tracks accumulates both inside and outside the trimming dozer. To counter this problem, various measures have been taken.

1) Washable air cleaner inner element

Since the interior of the hold is extremely dusty, the air cleaner element becomes quickly clogged. However, as the inner elements are made of no-woven cloth or urethane and can therefore be washed, maintenance cost is greatly reduced.

2) Facilitation of washing

The trimming dozer requires washing on completion of one operation in readiness for the next to prevent deposits from the first operation being mixed in with the subsequent one. Hinges have therefore been adopted for the radiator grille and undercover to facilitate washing.

(7) Corrosion preventive measures

Bulk cargoes such as salt and potassium chloride corrode the terminals of electrical equipment, leading to short-circuiting. Thus, corrosion-proof alternators and starting motors have been adopted for the trimming dozers, and terminals are coated with silicone compound.

(8) Safety measures

Trimming dozers are equipped with backup buzzers and red color lights to provide ample warning when moving in reverse.

The trimming dozers destined for in-vessel cargo work are selected so as that other cargo handling unloaders and derricks may function with good efficiency.

When selection is made on the models of trimming dozer, the structure of holds (hatch size, existence of twin deck, frame conditions, etc.), capacity of unloader (lifting capacity and cargo volume), and cargo material to be handled must be taken into consideration.

(1) Lifting capacity of derricks, unloaders, etc.(weight and height)

The most important factors to be taken into consideration for selecting the trimming dozer model are that the weight of the trimming dozer should be less than the capacity of derricks and unloaders that take them down to vessel hold.

(2) Hourly production

When trimming dozers are thrown into vessel cargo work theater, they have to work in cooperation with other unloading machines and other hold dozers, etc. It is necessary to grasp previously the treating capacity of each dozer, in order not only to elaborate the entire work schedule but also to study the economical of the work.

(3) Hatch opening area

Generally, the opening of vessels, hatch has sufficient dimensions for letting trimming dozers in and out of the hold, but it is advisable to check its dimensions prior to proceeding to actual work.

(4) Selection of track shoe

It is difficult to change the ground-pressure of the trimming dozer according to cargo to be handled. However, there exists a certain degree of adaptability to ground-pressure depending on the cargo. Therefore, it is recommended to take into consideration of the following table as a reference when selecting the shoe.

Standard Equipment

	D31E-P-20	D31PX-22M0	D63E-12
Air cleaner inner element, no-woven cloth made	○	○	○
Air cleaner inner element, urethane made			
Alternator, corrosion proof type	○	○	○
Backup buzzer	○	○	○
Backup lamp, red color	○	○	○
Cab		○	○
Electric terminals, silicon compound coated	○	○	○
Engine side covers, perforated	○	○	○
Engine under guard, hinged type	○		
Exhaust pipe, short	○		○
Fan, high speed	○		
Front lights, additional			
Fuel tank, large capacity			
Hydraulic cylinder rod, thick chrome plated	○	○	○
Intake manifold, cast iron made	○		
Oil pan, dual-bottom	○		
Oil pan, stainless steel made			
Radiator core protective grid			
Radiator mask, hinged type	○	○	○
Radiator, corrosion proof type			
Rear protector	○	○	○
Recoil spring, sealed type	○	○	○
Shoe, holed single grouser	○	○	
Shoe, holed triple grouser		○	○
Starting motor, corrosion proof type	○	○	○
Tachometer with mechanical drive service meter			
Track adjusting cylinders, thick chrome plated	○	○	○
Transmission oil cooler, tilttable	○		
Wear resistant pulley	○		

	D65E-12	D85EX-15
Air cleaner inner element, non-woven cloth made	○	
Air cleaner inner element, urethane made		
Air cleaner inner element, non-woven fabric made		○
Alternator, corrosion proof type	○	○
Backup buzzer	○	○
Backup lamp, red color	○	○
Cab		
Electric terminals, silicon compound coated	○	
Engine side covers, perforated	○	
Engine under guard, hinged type		
Exhaust pipe, elbow type		
Exhaust pipe, short		○
Exhaust pipe, straight type		○
Fan, high speed		
Front lights, additional		
Fuel tank, large capacity		○
Hydraulic cylinder rod, thick chrome plated		
Intake manifold, cast iron made		
Oil pan, dual-bottom		
Oil pan, stainless steel made		
Radiator core protective grid		
Radiator mask, hinged type		
Radiator, corrosion proof type		
Rear protector	○	○
Recoil spring, sealed type	○	
Shoe, holed single grouser		
Shoe, holed triple grouser		
Starting motor, corrosion proof type	○	○
Tachometer with mechanical drive service meter		
Track adjusting cylinders, thick chrome plated	○	
Transmission oil cooler, tilttable		
Under guard, hinged type		○
Wear resistant pulley		

Track Shoe Selection

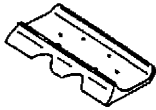

SINGLE GROUSER SHOE
A

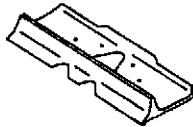

HOLED SINGLE GROUSER SHOE
B

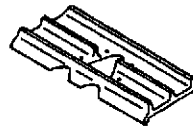

HOLED TRIPLE GROUSER SHOE
C

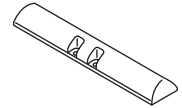

FVBH0241
SWAMP SHOE
D

Shoe width		D31E-20			D31P-20				D31PX-22M0			
		A	B	C	A	B	C	D	A	B	C	D
300 mm (11.8")												
340 mm (13.4")												
400 mm (15.7")			○	○		○				○	○	
460 mm (18.1")												
510 mm (20.0")												
560 mm (22.0")												
600 mm (23.6")						○		○		○		○
Material	Ore	0.8 kg/cm ² (11.4 PSI)		○	○						○	○
	Coal	0.8 kg/cm ² (11.4 PSI)		○	○				○		○	○
	Wooden chips	0.5 kg/cm ² (7.1 PSI)		○	○		○				○	○
	Salt	0.5 kg/cm ² (7.1 PSI)		○	○						○	○
	Sugar	0.5 kg/cm ² (7.1 PSI)		○			○				○	
	Grain	0.3 kg/cm ² (4.3 PSI)								○		
	Fertilizer	0.3 kg/cm ² (4.3 PSI)								○		

Shoe width		D63E-12			D65EX-12			D85EX-15		
		A	B	C	A	B	C	A	B	C
300 mm (11.8")										
340 mm (13.4")										
400 mm (15.7")										
460 mm (18.1")										
510 mm (20.0")		○		○	○		○			
560 mm (22.0")								○		○
600 mm (23.6")										
Material	Ore	0.8 kg/cm ² (11.4 PSI)				○		○	○	
	Coal	0.8 kg/cm ² (11.4 PSI)	○		○		○	○	○	
	Wooden chips	0.5 kg/cm ² (7.1 PSI)								
	Salt	0.5 kg/cm ² (7.1 PSI)				(○)			(○)	
	Sugar	0.5 kg/cm ² (7.1 PSI)								
	Grain	0.3 kg/cm ² (4.3 PSI)								
	Fertilizer	0.3 kg/cm ² (4.3 PSI)								

Note 1 : ○ : Currently available shoes which can be used. (○ means standard shoes.)

Note 2 : (○) : Ground pressures are greater than the target values but have been used so far.

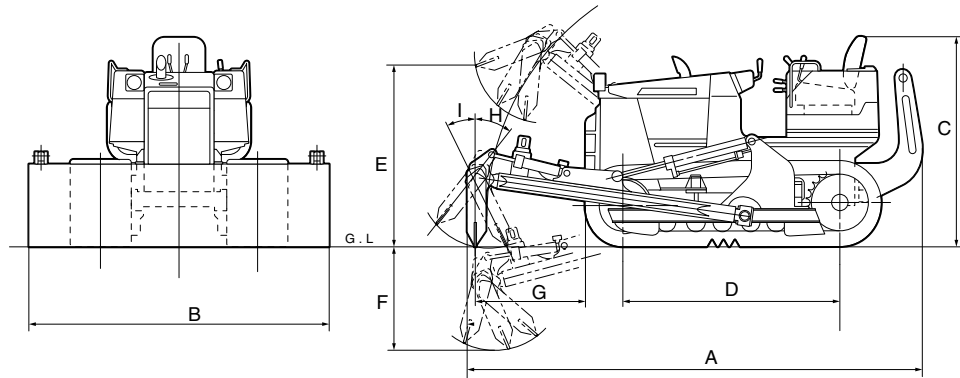

Item		Model	D31E-20	D31P-20	D31PX-22M0*5	D63E-12
OPERATING WEIGHT*		kg (lb)	7000 (15,430)	7660 (16,890)	9610 (21,190)	17600 (38,800)
HORSEPOWER		kW (HP)/RPM	52.3 (70)/2350	52.3 (70)/2350	58 (79)/2200	116 (155)/1800
PERFORMANCE:						
Travel speed						
Forward	1st	km/h (MPH)	2.2 (1.4)	2.2 (1.4)	3.4 (2.1)	3.4 (2.1)
	2nd		3.9 (2.4)	3.9 (2.4)	5.6 (3.5)	5.8 (3.6)
	3rd		6.5 (4.0)	6.5 (4.0)	8.5 (5.3)	9.0 (5.6)
Reverse	1st		2.4 (1.5)	2.4 (1.5)	4.1 (2.5)	4.4 (2.7)
	2nd		4.3 (2.7)	4.3 (2.7)	6.5 (4.0)	7.5 (4.7)
	3rd		7.1 (4.4)	7.1 (4.4)	8.5 (5.3)	11.0 (6.8)
DIMENSION*						
A	Overall length	mm (ft.in)	4540 (14'11")	4700 (15'5")	5080 (16'8")	5855 (19'3")
B	Overall width	mm (ft.in)	2480 (8'2")	2780 (9'1")	2880 (9'5")	3020 (9'11")
C	Overall height	mm (ft.in)	2025 (6'8")	2045 (6'9")	2800 (9'2")*4	2990 (9'10")***
D	Length of track on ground	mm (ft.in)	1880 (6'2")	2185 (7'2")	2185 (7'2")	2725 (8'11")
	Ground pressure	kg/cm ² (P.S.I)	0.47 (6.68)	0.29 (4.12)	0.37 (5.26)	0.63 (8.96)
DOZER EQUIPMENT						
	Weight (includes hydraulic control unit)	kg (lb)	1380 (3,040)	1280 (2820)		2550 (5,620)
	Length	mm (ft.in)	2480 (8'2")	2780 (9'1")	2880 (9'5")	3020 (9'11")
	Height	mm (ft.in)	760 (2'6")	760 (2'6")	760 (2'6")	960 (3'2")
E	Max. lift above ground	mm (ft.in)	1480 (4'10")	1630 (5'4")	1625 (5'4")	1655 (5'5")
F	Max. drop below ground	mm (ft.in)	710 (2'4")	650 (2'2")	655 (2'2")	735 (2'5")
G	Breast dimension	mm (ft.in)	1210 (4'0")	1370 (4'6")	1315 (4'4")	1565 (5'2")
	Max. pitch adjustment					
H	Forward	degree	38	37	37	45
I	Reverse	degree	24	26	26	26

Item		Model	D65E-12	D85EX-15*5		
OPERATING WEIGHT*		kg (lb)	19950 (43,980)**	26540 (58,510)		
HORSEPOWER		kW (HP)/RPM	135 (180)/1950	179 (240)/1900		
PERFORMANCE:						
Travel speed						
Forward	1st	km/h (MPH)	3.9 (2.4)	3.6 (2.2)		
	2nd		6.8 (4.2)	6.1 (3.8)		
	3rd		10.6 (6.6)	10.1 (6.3)		
Reverse	1st		5.0 (3.1)	4.7 (2.9)		
	2nd		8.6 (5.3)	8.0 (5.0)		
	3rd		13.4 (8.3)	13.0 (8.1)		
DIMENSION*						
A	Overall length	mm (ft.in)	6475 (21'3")	6690 (21'11")		
B	Overall width	mm (ft.in)	3210 (10'6")	3410 (11'2")		
C	Overall height	mm (ft.in)	3055 (10'0")***	3290 (10'10")*4		
D	Length of track on ground	mm (ft.in)	2675 (8'9")	3050 (10'0")		
	Ground pressure	kg/cm ² (P.S.I)	0.73 (10.38)	0.78 (11.1)		
DOZER EQUIPMENT						
	Weight (includes hydraulic control unit)	kg (lb)	4330 (9,550)	3810 (8,400)		
	Length	mm (ft.in)	3210 (10'6")	3410 (11'2")		
	Height	mm (ft.in)	1000 (3'3")	1185 (3'11")		
E	Max. lift above ground	mm (ft.in)	1610 (5'3")	1730 (5'8")		
F	Max. drop below ground	mm (ft.in)	685 (2'3")	900 (2'11")		
G	Breast dimension	mm (ft.in)	1610 (5'3")	1620 (5'4")		
	Max. pitch adjustment					
H	Forward	degree	29	35		
I	Reverse	degree	22	35		

* : Including dozer equipment in addition to bare tractor
 ** : Including cab and air conditioner
 *** : To top of cab

*4: To top of ROPS
 *5: With ROPS & cab

MEMO

A series of horizontal dashed lines for writing.

CONTENTS

INDEX

SECTION **2**

EXCAVATORS (BACKHOE)	Sec 2A
LIFTING CAPACITY	Sec 2B
ATTACHMENTS	Sec 2C
HYDRAULIC LOADING SHOVELS	Sec 2D
WHEEL-TYPE EXCAVATORS	Sec 2E
DEMOLITION	Sec 2F
SCRAP & MATERIAL HANDLING	Sec 2G
SPECIAL APPLICATION MACHINES	Sec 2H

SECTION **2A**

EXCAVATORS (BACKHOE)

CONTENTS

Features	2A-2
Specifications	2A-12
Dimensions	2A-35
Working Ranges and Digging Forces	2A-49
Component Dimensions and Weights	2A-60
Shoe Selection	2A-80
Shoe Application	2A-81
Ground Pressure	2A-85
Bucket Capacity Definition	2A-94
Bucket Selection	2A-95
Bucket and Arm Combinations	2A-97
Teeth Features and Teeth Selection	2A-112
Model Selection	2A-119
Production	2A-128

Ecology Features

EPA Tier 4 Interim and EU Stage 3B emissions certified engine

NOTE: For details of features, see the page of engine features (Section 11).

ecot3 (EPA Tier 3, EU Stage 3A certified engine)

Komatsu develops and produces all major components, such as engines, electronics and hydraulic components in house.

With this “Komatsu Technology”, and adding customer feedback, Komatsu is achieving great advancements in technology.

To achieve high levels of productivity and ecology, Komatsu developed the main components with an advanced control system.

The result is a new generation of high performance and environment friendly machines.



Fuel efficient electronic controlled engine

The engine is EPA Tier 3 and EU Stage 3A emission regulation certified. The engine is turbocharged and features Common Rail Injection System (CRI) and air-to-air aftercooling to maximize power, fuel efficiency and emission compliance.

To minimize noise and vibration, the engine is mounted to the main frame with rubber cushions.

(PC130-8, PC160LC-8, PC200-8 – PC290-8, PC300-8 – PC450-8, PC600-8, PC800/850-8, PC1250-8)

Hydraulic drive radiator cooling fan

The engine cooling fan rotation speed is electronically controlled. The fan rotation speed depends on engine coolant and hydraulic oil temperatures, the higher the temperature the higher the fan speed. This system increases fuel efficiency, reduces the operating noise levels and requires less horsepower than belt driven fan.

(PC600-8, PC800/850-8, PC1250-8)

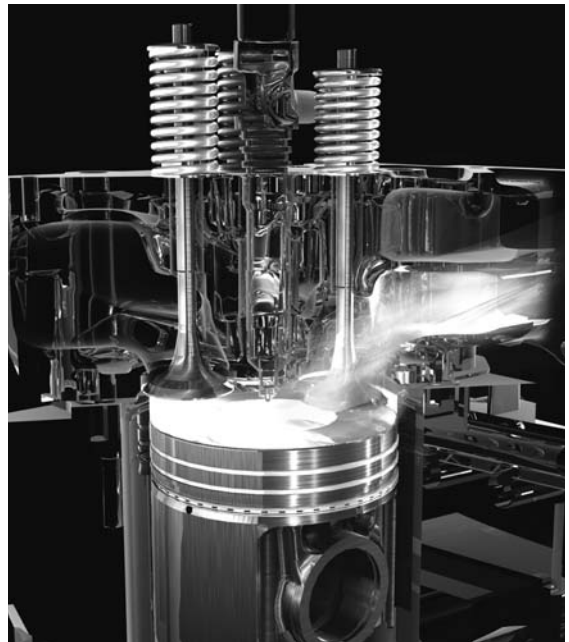

Dash-10 Series (PC138US-10 – PC490-10)

ROPS cab (ISO 12117-2)

The machine is equipped with a ROPS cab that conforms to ISO 12117-2 for excavators as standard equipment. The ROPS cab has high shock-absorption performance, featuring excellent durability and impact strength. It also satisfies the requirements of ISO OPG top guard level 1 for falling objects. Combined with the retractable seat belt, The ROPS cab protects the operator in case of tipping over and against falling objects.

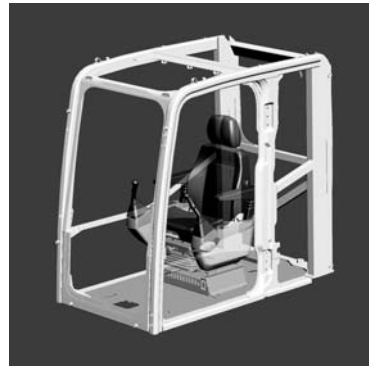
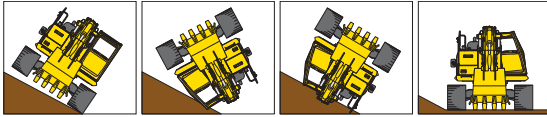

Rear view monitoring system

The operator can view the rear of the machine with a color monitor screen.



Rear view image on monitor

Large multi-lingual high resolution LCD monitor

A large user-friendly high resolution LCD color monitor enables safe, accurate and smooth work. Visibility and resolution are further improved compared with current 7-inch large TFT LCD. Simple and easy to operate switches. Function keys facilitate multi-function operations.

Displays data in 25 languages to globally support operators around the world.

Indicators

- | | |
|----------------------------------|-----------------------------------|
| 1 Auto-decelerator | 5 Hydraulic oil temperature gauge |
| 2 Working mode | 6 Fuel gauge |
| 3 Travel speed | 7 ECO-gauge |
| 4 Engine water temperature gauge | 8 Fuel consumption gauge |
| | 9 Function switches menu |

Basic operation switches

- | | |
|-------------------------|---------------------|
| 1 Auto-decelerator | 4 Buzzer cancel |
| 2 Working mode selector | 5 Wiper |
| 3 Traveling selector | 6 Windshield washer |

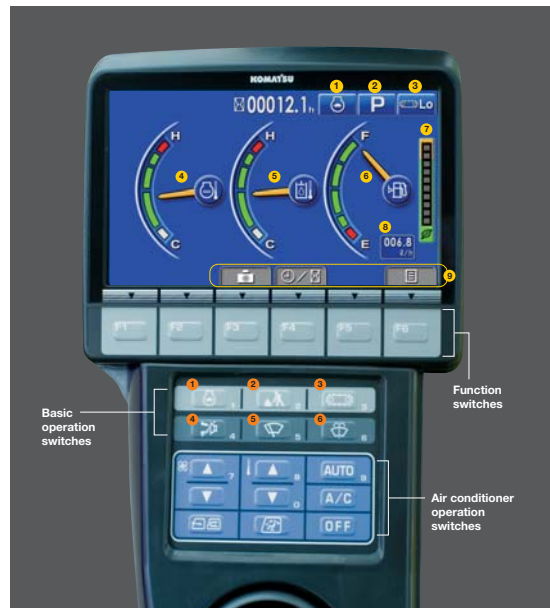

Supports efficiency improvement

The main screen displays advices for promoting energy-saving operations as needed. The operator can use the ECO guidance menu to check the operation records, ECO guidance records, average fuel consumption logs, etc.



Hand rails prevent accidental fall-off

Prevents fall-off from machine cab. During engine service, there is no need to move to counterweight area.



Heavier counterweight for higher lifting capacity and reinforced components

A reinforced undercarriage design provides additional strength and reliability. (PC490/LC-10)



1 Counterweight: Heavier for increased lift capacity
+ 450 kg **992 lb**

2 Swing circle: Reinforced
Increased swing bearing capacity
(Increased diameter)

3 Track shoe: Reinforced
Increased link height and tread width
Diameter of pin and bushing is increased
Shoe thickness and bolt strength is increased

4 Final drive
Track frame bolt and sprocket mounting bolt have higher axial tension

5 Sprocket
Material strength is increased
New tooth shape design

6 Center frame: Reinforced

7 Carrier rollers and idler: Reinforced
Increased tread width

8 Crawler frame: Reinforced

9 Revolving frame: Reinforced

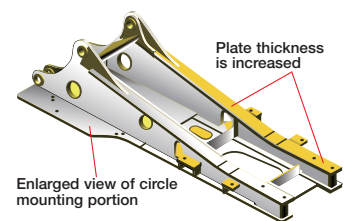

Dash-8 Series (PC130-8 – PC850-8E0)

Cab dedicated to hydraulic excavator

The cab is designed specifically for hydraulic excavators' and gains reinforced strength from the pipe-structured cab framework. The cab frame work provides the high durability and impact resistance with very high impact absorbency. The seat belt keeps the operator is the safety of the cab during a rollover.

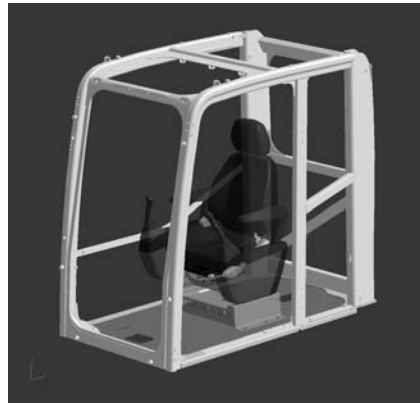

Large multi-lingual LCD monitor

A large user-friendly color monitor enables safe, accurate and smooth work. Improved screen visibility is achieved by use of TFT liquid crystal display that can easily be read at various angles and lighting conditions. Simple and easy to operate switches. Industry first function keys facilitate multi-function operations.

Displays data in 10 languages to globally support operators around the world.



Indicators

- | | |
|----------------------------------|-----------------------------------|
| 1 Auto-decelerator | 5 Hydraulic oil temperature gauge |
| 2 Working mode | 6 Fuel gauge |
| 3 Travel speed | 7 Eco-gauge |
| 4 Engine water temperature gauge | 8 Function switches menu |

Basic operation switches

- | | |
|-------------------------|---------------------|
| 1 Auto-decelerator | 4 Buzzer cancel |
| 2 Working mode selector | 5 Wiper |
| 3 Traveling selector | 6 Windshield washer |

Eco-gauge that assists energy-saving Operations

Equipped with the Eco-gauge that can be recognized at glance on the right of the multi-monitor for environment-friendly energy-saving operations.

Allows focus on operation in the green range with reduced CO₂ emissions and efficient fuel consumption.



Eco-gauge

Idling caution

To prevent unnecessary fuel consumption, an idling caution is displayed on the monitor, if the engine idles for 5 minutes or more.



Dash-7 Series

■ High production and low fuel consumption

• Working mode selection

Dash-7 excavators are equipped with three working modes (A, E and B mode).

Production is increased with larger output during Active mode while efficiency is further improved.

Working Mode	Application	Advantage
A	Active mode	<ul style="list-style-type: none"> • Maximum production/power • Fast cycle times
E	Economy mode	<ul style="list-style-type: none"> • Excellent fuel economy
B	Breaker operation	<ul style="list-style-type: none"> • Optimum engine rpm, hydraulic flow

• Larger digging power provides increased production

Bucket digging force and bucket digging speed are increased, so resulting total bucket digging force increased.

(PC200-7, PC220-7)

Example: PC200-7

Bucket Digging Force Bucket Digging Speed Bucket Digging Power

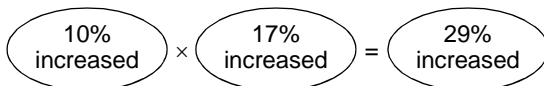

• Larger arm crowd force and digging force provide increased production (PC300-7, PC600-7)

• Large lifting capacity

Lateral stability is improved resulting in increased lifting capacity.

• Larger maximum drawbar pull

Maximum drawbar pull is increased, provides superb steering and slope climbing performance.

• Power max function

This function temporarily increases digging force by 7% for added power in tough situations.

• Two boom settings

Smooth mode provides easy operation for gathering blasted rock or scraping down operation. When maximum digging force is needed, switch to Power mode for more effective excavating. (PC300-7, PC800-7)

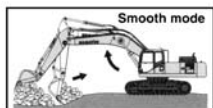

Boom floats upward, reducing lifting of machine front. This facilitates gathering blasted rock and scraping down operations.

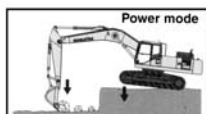

Boom pushing force is increased, ditch digging and box digging operation on hard ground are improved.

■ Harmony with environment

• Low emission engine

Komatsu Dash-7 Series engine meets EPA, EU and Japan Tier II emissions regulations.

• Environment oriented mode (Economy mode)

Economy mode offers the user fuel savings, quiet operation and less CO₂ emission.

■ Large comfortable cab

• Large-sized cab

New cab volume is increased by 14%.

• Pressurized cab

With optional air conditioner, air filter and higher internal air pressure prevent external dust from entering the cab.

• Low noise

Noise is reduced not only from the engine but also during swing and hydraulic relief.

• Low vibration with cab damper mounting

The new cab damper mounting combined with strengthened left and right side decks aids vibration reduction at operator seat.

• Automatic air conditioner (Optional)

A 6,900 kcal (SAE) air conditioner is utilized.

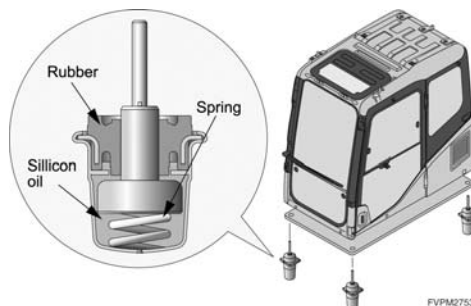
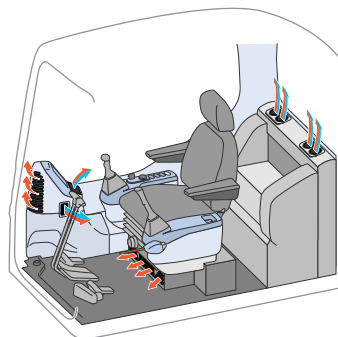

FVPM2753

■ Easy maintenance

• Hydraulic oil and filter/engine oil and filter replacement interval extended

Oil and filter change interval

Item	Model	Dash-7	Avance series
Engine oil	h	500	250
Engine oil filter	h	500	250
Hydraulic oil	h	5000	5000
Hydraulic oil filter	h	1000	500

• Easy radiator cleaning

Clearance between radiator and oil cooler is increased to facilitate radiator core cleaning with an air nozzle.

• Remote mounted engine oil filter and fuel drain valve for easy access

• Water separator is standard equipment

• Fuel tank capacity is increased

• SCSH bushings on work equipment extend lubricating interval from 100 hours to 500 hours (optional)

■ Multi-function color monitor (optional)

• Hydraulic pump oil flow adjustment system

When installing attachments (breaker, crusher, etc.) and B, A, or E mode is selected, it is possible to adjust engine and hydraulic pump discharge flow to match attachment characteristics.

• Lifting mode

When the Lifting mode is selected, lifting capacity is increased by 7% by raising hydraulic pressure.

• EMMS (Equipment Management Monitoring System)

• Monitor function

Controller monitors engine oil level, coolant level, engine oil pressure, coolant temperature, battery charge and air cleaner clogging, etc. If controller finds any abnormality, it is displayed on the LCD.

• Maintenance function

Monitor informs replacement time of oil and filters on LCD when the replacement interval is reached.

• Trouble data memory function

Monitor stores abnormalities for effective troubleshooting.

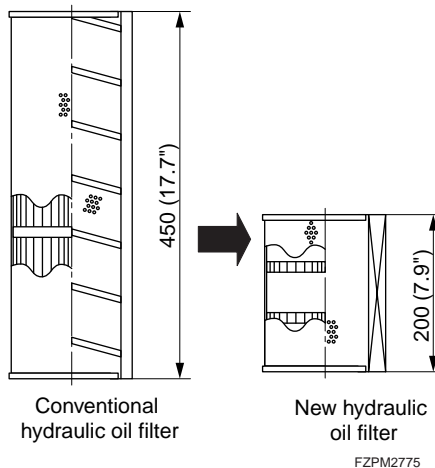

SCSH Bushing

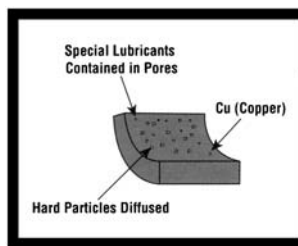

Deluxe spec monitor

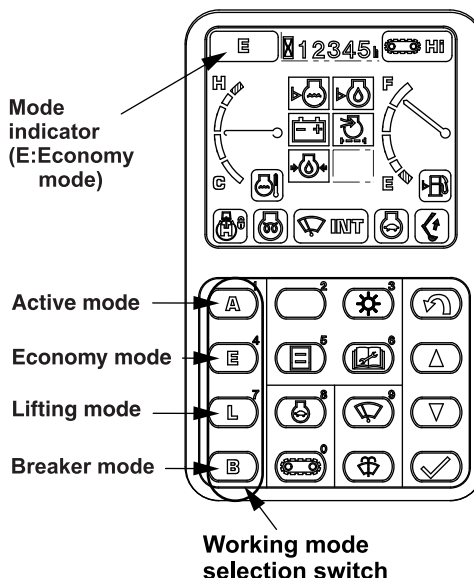

FZPM2902

VHMS (Vehicle Health Monitoring System)

VHMS controller monitors the health conditions of major components, enables remote analysis of the machine and its operation. This process is supported by the Komatsu distributors, factory and design team. This contributes to reduced repair costs and to maintaining maximum availability.

(PC1250-7, PC1250-8, PC2000-8)

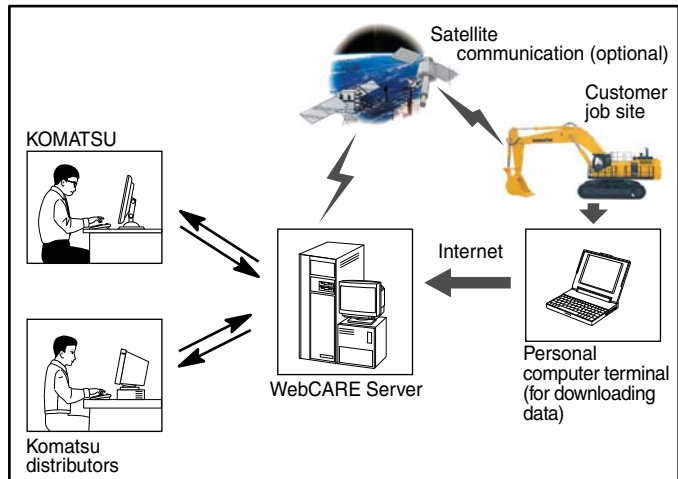

■ Merits of using VHMS

Diagnosis

- Machine health information that used to take approximately 1 hour to be measured can now be downloaded by personal computer in approximately 10 minutes, shortening the vehicle's down time.
- Furthermore, if the satellite communications function is equipped, the machine information can be gathered without stopping the vehicle at all. (Not available in some regions.)

Recommendation

- An appropriate recommendation can be made by viewing these data over the Internet.
 - Proper driving methods
 - Formulation of maintenance plans in advance that suit the customer's production schedule.

Customer's Benefit

- Sudden break down can be prevented through utilization of data trend (change over time).
- Ascertaining the facts and searching for the cause of the breakdown are simplified, thus enabling problems to be resolved quickly.
- Down time can be shortened by the systematic use of Reman components.
- Machine life can be extended significantly by proper operation and proper maintenance.

■ KOMTRAX

• Ecological operation report for assistance

KOMTRAX is Komatsu's remote equipment and fleet monitoring system. Wireless technology and a secure Webbased application gives you the information you need to make the best possible operation and management decisions, from location, actual hour worked, and fuel consumption to maintenance monitoring, abnormality codes, and load frequency, in simple to read and understand reports.

- Guidance to improve fuel consumption
- Ecological operation report.
- Report operation hours by operation mode(E or P mode)
- Service information for Tier 4 Interim (Regeneration, diagnostics information)

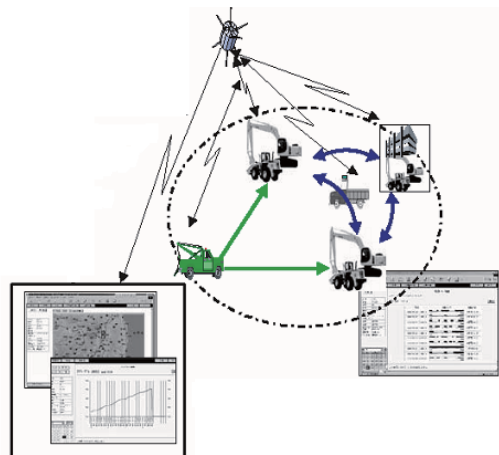

Rubber Crawler Excavators

■ Komatsu rubber crawler excavators for low noise, low vibration and less damage

Compared to steel, rubber crawlers emit much less traveling noise and transmit far less vibration to the ground.

Rubber crawlers enable you to move your equipment smoothly and easily over short distances, without a carrier. There's no need to lay any extra sheet over the road because rubber causes less damage to roads and other paved areas. In other words, rubber crawlers and pad shoes are safer for the environment, more comfortable for the operator and less disturbing to the neighborhood.

Smooth, quiet, damage-free machines are just what you need for reconstruction and redevelopment projects in busy streets and other urban areas.

• Rubber crawlers for mini hydraulic excavator

When mini hydraulic excavators ride on durable rubber crawlers, they can accomplish an even wider variety of jobs smoothly, quietly and over all types of pavement, without damage to the urban environment.

In addition, large metallic base embedded in rubber assures extended crawler life.

The rubber crawler is securely held in position by two flanges of track rollers, minimizing the chance of crawler removal from the undercarriage and enabling stable traveling.

Strong, durable rubber crawler construction

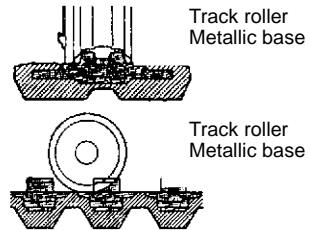
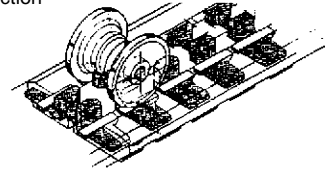

• Rubber pad shoes for medium-class hydraulic excavators

Rubber pad shoes provide the same strength as conventional tracks but with a smooth, quiet and gentle grip.

A blend of natural and synthetic rubbers assures maximum strength. This durable, hard material is baked onto the metallic triple-grouser shoe. As a result, the total shoe assembly is as strong as conventional shoes.

To assure lower maintenance costs, each rubber pad shoe is bolted on the track link in the same manner as standard steel shoes. So, shoe plates are completely interchangeable and only damaged shoes need to be replaced. What's more, rubber pad shoes offer extended service life because even after the rubber pad wears out, these shoes are still usable as the flat or triple-grouser shoes.

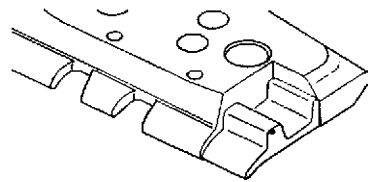

Bolt-on pad rubber shoe

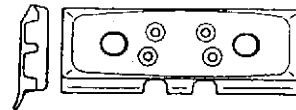

Komatsu Mining Shovel Features

High production with low running costs

High digging forces provide fast cycle times and low cost per tonnage

Environmental harmony

- Komatsu engines which meet EPA, EU and Japan emission regulations
- Extended oil change intervals and filter replacement intervals to reduce environmental impacts
- Long term experience in use of biological hydraulic oils and lubricants, as an option available

Large, comfortable and safe mining operator's cab

- Integrated FOPS structure according ISO 3449
- Internal floor area 4.2 m² (6510 sq.in)
- Large windows for good all around visibility
- Side sliding windows
- Pressurized to keep dust out
- Noise level in cab approx. 76 dB(A) according ISO 63096
- High intensive XENON working lights.
- Cab heating and air conditioner of 10 kW
- Comfortable multi-functional operator seat with internal heating
- Second swing out fold away seat for trainer
- Wash-hand basin
- Refrigerator

ECS or VHMS monitoring system for greater machine efficiency and low maintenance time

- Comprehensive overview of shovel functions with operator friendly display
- Optional data transfer possibility via Modular Mining System controller
- All important machine running datas are monitored and electronically stored, with down load facility
- Acoustic and visually alarms warn of machine malfunctions

Komatsu engine

- Latest engine technology compliant with emission regulations
- Engine life time self cleaning stainless steel engine oil filter (ELIMINATOR) to avoid filter change; only filter cleaning at every 1000 hour is required
- Engine oil management system (Reserve and Centinel system) to extend oil change intervals up to 4000 hours
- Fuel tank capacity for continuous work up to 24 hours

Electric drive as option

- Electric motor 6600/7200 V and 50 or 60 Hz available
- Squirrel cage motor with soft start
- Optimized electrical design for all international standards
- Compact design with low vibration and noise
- Cable drum with automatic tensioning, as option

Komatsu hydraulic system HYDRO-PILOT

- Multi-circuit hydraulic system with electronic load governor, pump flow summation capability, and oil flow priority based on demand, for fast working cycles and high productivity
- All main hydraulic circuits are run at one pressure level only, simplifying pressure adjustment and service
- Each circuit with connection facility for pressure check gauges
- Changing from front shovel to backhoe is simple
- Un-pressurized hydraulic tank with large pump suction lines and low pump speed prevents risk of cavitation
- Each hydraulic circuit protected with high pressure filters
- Full flow 10 µm return line filters for system safety and for supplementary circuits 3 µm by-pass filter to improve oil quality for long component lifetime
- Swing out hydraulic cooler for simple cleaning to keep the cooling efficiency

Heavy-duty shovel undercarriage design

- Komatsu Mining Germany track system with oscillating shoes for optimum response to rugged mining ground conditions
- Lifetime lubricated rollers
- Automatic track tensioning system
- Track shoes in high quality casting steel and engineered by finite element method
- Precision hard facing of contact surfaces for long term performance
- Different width of shoes available for best performance in softer mining ground conditions

Attachments

- Backhoe attachment available for all mining applications
- Closed box design combining steel plates and castings, engineered by finite element method for full lifetime
- Wide selection of buckets and customized options
- Bucket wear package ranges to meet all mining conditions
- Attachment pin sealing arrangement for reduced bearing wear-parts costs

Service

- Hydraulically assisted ladder for ease and convenience access
- Upper structure walkway allows safe access to all service points
- Walk in machinery house provides all weather protection for service attention
- Automatic central lubrication system for attachment and main swing bearing
- Swing down service arm for fast, ground level refilling and evacuation and the minimizing of leakages during service
- Complete machine delivered in pre-tested modules for fast erection on job side

Specifications

EXCAVATORS (BACKHOE)

Model		PC09-1	PC14R-3	PC16R-3	PC18MR-3	
Source		Japan	Italy	Italy	Japan	
OPERATING WEIGHT*		890 (1,960)	1440 (3,170)	1570 (3,460)	1780 (3,920)	
HORSEPOWER SAE J1995 Gross ISO9249 /SAE J1349 Net Hyd. fan at max. speed Net		kW (HP)/RPM kW (HP)/RPM kW (HP)/RPM	6.2 (8.4)/2800	11.2 (15.0)/2600	11.2 (15.0)/2600	11.2 (15.0)/2600
BUCKET CAPACITY RANGE (SAE)		m ³ (cu.yd)	0.017 ~ 0.025 (0.022) (0.033)	0.03 ~ 0.06 (0.04) (0.078)	0.03 ~ 0.06 (0.04) (0.078)	0.022 ~ 0.044 (0.029) (0.058)
PERFORMANCE: Swing speed Max travel speed		RPM km/h (MPH)	8.3 3.0 (1.9)	8.9 2 (1.2)	8.9 4.2 (2.6)	8.9 4.3 (2.7)
		Hi Mi Lo	1.5 (0.9)		2.2 (1.4)	2.3 (1.4)
DIMENSIONS: See the page of dimensions.						
ENGINE: Model No. of cylinders- bore × stroke Piston displacement		mm (in) ltr. (cu.in)	KOMATSU 2D68E 2-68 × 72 (2.68 × 2.83) 0.522 (31.9)	KOMATSU 3D67E 3-67 × 73.6 (2.64 × 2.90) 0.778 (47.5)	KOMATSU 3D67E-2A 3-67 × 73.6 (2.64 × 2.90) 0.778 (47.5)	KOMATSU 3D67E-2A 3-67 × 73.6 (2.64 × 2.90) 0.778 (47.0)
HYDRAULIC SYSTEM: Hydraulic pump Max. oil flow Max. oil pressure (Implement)		ltr. (U.S.Gal)/min. kg/cm ² (PSI)	Gear pumps 22 (5.8) 160 (2275)	Gear pumps 40.8 (10.8) 194 (2760)	1 × Variable Piston 40.8 (10.8) 214 (3040)	1 × Variable Piston+Gear pump 54.3 (14.3) 235 (3340)
Track shoe width/ ground pressure		mm (in)/ kg/cm ² (PSI)	180 (7)/ 0.28 (4.0)	230 (9)/ 0.27 (3.8)	230 (9)/ 0.30 (4.3)	230 (9)/ 0.29 (4.1)
CAPACITY (Refilled): Fuel tank Hydraulic oil tank		ltr. (U.S.Gal)	11 (2.9) 12 (3.2)	19 (5.0) 12 (3.2)	19 (5.0) 12 (3.2)	19 (5.0) 15.2 (4.0)
MACHINE SPEC: Boom Arm Bucket (SAE) Upper attachment		mm (ft.in) mm (ft.in) m ³ (cu.yd)	1357 (4'5") 684 (2'3") 0.022 (0.029)	1620 (5'4") 880 (2'11") 0.04 (0.05) Canopy	1760 (5'9") 965 (3'2") 0.04 (0.05) Canopy	1760 (5'9") 965 (3'2") 0.044 (0.058) ROPS Canopy

Model		PC18MR-3	PC20MR-3	PC22MR-3	PC26MR-3	
Source		Italy	Japan	Italy	Italy	
OPERATING WEIGHT*		1840 (4,060)	2155 (4,750)	2425 (5,350)	2710 (5,970)	
HORSEPOWER SAE J1995 Gross ISO9249 /SAE J1349 Net Hyd. fan at max. speed Net		kW (HP)/RPM kW (HP)/RPM kW (HP)/RPM	11.2 (15.0)/2600	15.5 (20.8)/2500	15.5 (20.8)/2500	15.5 (21)/2500
BUCKET CAPACITY RANGE (SAE)		m ³ (cu.yd)	0.03 ~ 0.06 (0.04) (0.078)	0.033 ~ 0.08 (0.043) (0.10)	0.035 ~ 0.085 (0.046) (0.11)	0.035 ~ 0.085 (0.046) (0.11)
PERFORMANCE: Swing speed Max travel speed		RPM km/h (MPH)	8.9 4.3 (2.7)	8.9 4.6 (2.9)	8.9 4.6 (2.9)	8.9 4.0 (2.5)
		Hi Mi Lo	2.3 (1.4)	2.8 (1.7)	2.8 (1.7)	2.5 (1.6)
DIMENSIONS: See the page of dimensions.						
ENGINE: Model No. of cylinders- bore × stroke Piston displacement		mm (in) ltr. (cu.in)	KOMATSU 3D67E-2A 3-67 × 73.6 (2.64 × 2.90) 0.778 (47.0)	KOMATSU 3D76E-6 3-76 × 78 (2.99 × 3.07) 1.115 (68.0)	KOMATSU 3D76E 3-76 × 82 (2.99 × 3.07) 1.115 (68.0)	KOMATSU 3D76E 3-76 × 78 (2.99 × 3.07) 1.115 (68.0)
HYDRAULIC SYSTEM: Hydraulic pump Max. oil flow Max. oil pressure (Implement)		ltr. (U.S. Gal)/min. kg/cm ² (PSI)	1 × Variable Piston+Gear pump 40.8 (10.8) 235 (3340)	1 × Variable Piston+Gear pump 68.9 (18.2) 250 (3555)	1 × Variable Piston+Gear pump 71 (18.8) 250 (3555)	1 × Variable Piston+Gear pump 69.1 (18.3) 250 (3555)
Track shoe width/ ground pressure		mm (in)/ kg/cm ² (PSI)	230 (9)/ 0.28 (3.98)	250 (10)/ 0.27 (3.8)	250 (10)/ 0.25 (3.56)	300 (12)/ 0.25 (3.6)
CAPACITY (Refilled): Fuel tank Hydraulic oil tank		ltr. (U.S.Gal)	19 (5.0) 15.2 (4.0)	28 (7.4) 19 (5.0)	28 (7.4) 29 (7.7)**	28 (7.4) 29 (7.7)
MACHINE SPEC: Boom Arm Bucket (SAE) Upper attachment		mm (ft.in) mm (ft.in) m ³ (cu.yd)	1760 (5'9") 965 (3'2") 0.04 (0.05) ROPS Canopy	1810 (5'11") 970 (3'2") 0.066 (0.86) ROPS Canopy	1810 (5'11") 970 (3'2") 0.07 (0.09) ROPS Cab	2200 (7'3") 1115 (3'8") 0.07 (0.09) ROPS Cab

* Operating weight includes coolant, lubricants, full fuel tank, operator 80kg (180lb) and, indicated implement, shoes and upper attachment.

** Full capacity

Specifications

EXCAVATORS (BACKHOE)

Model		PC27MR-3	PC30MR-3	PC30MR-3	PC35MR-3	
Source		Japan	Japan	Italy	Japan	
OPERATING WEIGHT*		2890 (6,370)	3140 (6,920)	3290 (7,250)	3575 (7,880)	
HORSEPOWER SAE J1995 Gross ISO9249 /SAE J1349 Net Hyd. fan at max. speed Net		kW (HP)/RPM kW (HP)/RPM kW (HP)/RPM	19.2 (25.7)/2600	21.4 (28.6)/2400	21.6 (29.0)/2400	21.4 (28.6)/2400
BUCKET CAPACITY RANGE (SAE)		m ³ (cu.yd)	0.035 ~ 0.09 (0.046) (0.12)	0.035 ~ 0.11 (0.045) (0.14)	0.035 ~ 0.13 (0.046) (0.17)	0.055 ~ 0.13 (0.07) (0.17)
PERFORMANCE: Swing speed Max travel speed		RPM km/h (MPH)	9.2 4.8 (3.0)	9.3 4.6 (2.9)	9.3 4.6 (2.9)	9 4.8 (3.0)
		Hi Mi Lo	2.6 (1.6)	2.5 (1.6)	2.5 (1.6)	2.8 (1.7)
DIMENSIONS: See the page of dimensions.						
ENGINE: Model No. of cylinders- bore × stroke Piston displacement		mm (in) ltr. (cu.in)	KOMATSU 3D82AE-6 3-82 × 84 (3.23 × 3.31) 1.33 (81.2)	KOMATSU 3D88E-6 3-88 × 90 (3.46 × 3.54) 1.642 (100)	KOMATSU 3D88E-6 3-88 × 90 (3.46 × 3.54) 1.642 (100)	KOMATSU 3D88E-6 3-88 × 90 (3.46 × 3.54) 1.642 (100)
HYDRAULIC SYSTEM: Hydraulic pump Max. oil flow Max. oil pressure (Implement)		ltr. (U.S. Gal)/min. kg/cm ² (PSI)	1 × Variable Piston+Gear pump 92 (24.3) 250 (3555)	1 × Variable Piston+Gear pump 89.6 (23.6) 265 (3770)	1 × Variable Piston+Gear pump 89.8 (23.7) 265 (3770)	2 × Variable Piston+Gear pump 92 (24.3) 265 (3770)
Track shoe width/ ground pressure		mm (in)/ kg/cm ² (PSI)	300 (12)/ 0.30 (4.3)	300 (12)/ 0.30 (4.3)	300 (12)/ 0.30 (4.27)	300 (12)/ 0.34 (4.8)
CAPACITY (Refilled): Fuel tank Hydraulic oil tank		ltr. (U.S.Gal)	44 (11.6) 14 (3.7)	44 (11.6) 14 (3.7)	44 (11.6) 34 (9.0)**	44 (11.6) 14 (3.7)
MACHINE SPEC: Boom Arm Bucket (SAE) Upper attachment		mm (ft.in) mm (ft.in) m ³ (cu.yd)	2180 (7'2") 1100 (3'7") 0.08 (0.105) ROPS Canopy	2285 (7'6") 1240 (4'1") 0.095 (0.12) ROPS Canopy	2285 (7'6") 1240 (4'1") 0.09 (0.12) ROPS Cab	2540 (8'4") 1370 (4'6") 0.11 (0.14) ROPS Canopy

Model		PC35MR-3	PC45MR-3	PC45MR-3	PC55MR-3	
Source		Italy	Japan	Italy	Japan	
OPERATING WEIGHT*		3725 (8,210)	4775 (10,480)	4715 (10,390)	5160 (11,380)	
HORSEPOWER SAE J1995 Gross ISO9249 /SAE J1349 Net Hyd. fan at max. speed Net		kW (HP)/RPM kW (HP)/RPM kW (HP)/RPM	21.6 (29.0)/2400	28.5 (38.2)/2400	28.5 (38.2)/2400	28.5 (38.2)/2400
BUCKET CAPACITY RANGE (SAE)		m ³ (cu.yd)	0.035 ~ 0.13 (0.046) (0.17)	0.055 ~ 0.16 (0.07) (0.21)	0.07 ~ 0.175 (0.09) (0.23)	0.055 ~ 0.16 (0.07) (0.21)
PERFORMANCE: Swing speed Max travel speed		RPM km/h (MPH)	9 4.8 (3.0)	9 4.8 (3.0)	9 4.6 (2.9)	9 4.6 (2.9)
		Hi Mi Lo	2.8 (1.7)	2.8 (1.7)	2.8 (1.7)	2.8 (1.7)
DIMENSIONS: See the page of dimensions.						
ENGINE: Model No. of cylinders- bore × stroke Piston displacement		mm (in) ltr. (cu.in)	KOMATSU 3D88E-6 3-88 × 90 (3.46 × 3.54) 1.642 (100)	KOMATSU 4D88E-6 4-88 × 90 (3.46 × 3.54) 2.189 (134)	KOMATSU 4D88E-6 4-88 × 90 (3.46 × 3.54) 2.189 (134)	KOMATSU 4D88E-6 4-88 × 90 (3.46 × 3.54) 2.189 (134)
HYDRAULIC SYSTEM: Hydraulic pump Max. oil flow Max. oil pressure (Implement)		ltr. (U.S. Gal)/min. kg/cm ² (PSI)	2 × Variable Piston+Gear pump 92 (24.3) 265 (3770)	2 × Variable Piston+Gear pump 140.8 (37.2) 270 (3840)	2 × Variable Piston+Gear pump 140.8 (37.2) 270 (3840)	2 × Variable Piston+Gear pump 140.8 (37.2) 270 (3840)
Track shoe width/ ground pressure		mm (in)/ kg/cm ² (PSI)	300 (12)/ 0.36 (5.12)	400 (16)/ 0.27 (3.8)	400 (16)/ 0.25 (3.56)	400 (16)/ 0.29 (4.1)
CAPACITY (Refilled): Fuel tank Hydraulic oil tank		ltr. (U.S.Gal)	44 (11.6) 39 (10.3)**	65 (17.2) 20 (5.3)	65 (17.2) 55 (14.5)**	65 (17.2) 20 (5.3)
MACHINE SPEC: Boom Arm Bucket (SAE) Upper attachment		mm (ft.in) mm (ft.in) m ³ (cu.yd)	2540 (8'4") 1370 (4'6") 0.12 (0.17) ROPS Cab	2640 (8'8") 1375 (4'6") 0.14 (0.18) ROPS Canopy	2640 (8'8") 1375 (4'6") 0.15 (0.20) ROPS Cab	2900 (9'6") 1640 (5'5") 0.16 (0.21) ROPS Canopy

* Operating weight includes coolant, lubricants, full fuel tank, operator 80kg (180lb) and, indicated implement, shoes and upper attachment.

** Full capacity

Specifications

EXCAVATORS (BACKHOE)

Item		Model	PC55MR-3	PC56-7
Source			Italy	China
OPERATING WEIGHT*		kg (lb)	5280 (11,640)	5300 (11,680)
HORSEPOWER SAE J1995 Gross ISO9249 /SAE J1349 Net Hyd. fan at max. speed Net		kW (HP)/RPM kW (HP)/RPM kW (HP)/RPM	28.5 (38.2)/2400	36.5 (48.9)/2300 34.6 (46.4)/2300
BUCKET CAPACITY RANGE (SAE)		m ³ (cu.yd)	0.07 – 0.175 (0.09) (0.23)	0.055 – 0.22 (0.072) (0.29)
PERFORMANCE: Swing speed Max travel speed		RPM km/h (MPH) Hi Mi Lo	9 4.6 (2.9) 2.8 (1.7)	9.0 4.2 (2.6) 2.6 (1.6)
DIMENSIONS: See the page of dimensions.				
ENGINE: Model No. of cylinders- bore × stroke Piston displacement		mm (in) ltr. (cu.in)	KOMATSU 4D88E-6 4-88 × 90 (3.46 × 3.54) 2.189 (134)	KOMATSU S4D87E-1 4-87 × 102.4 (3.43 × 4.03) 2.434 (149)
HYDRAULIC SYSTEM: Hydraulic pump Max. oil flow Max. oil pressure (Implement)		ltr. (U.S. Gal)/min. kg/cm ² (PSI)	2 × Variable Piston+Gear pump 140.8 (37.2) 270 (3840)	2 × Variable Piston+Gear pump 146 (38.6) 270 (3840)
Track shoe width/ ground pressure		mm (in)/ kg/cm ² (PSI)	400 (16)/ 0.25 (3.56)	400 (16)/ 0.31 (4.41)
CAPACITY (Refilled): Fuel tank Hydraulic oil tank		ltr. (U.S.Gal)	65 (17.2) 55 (14.5)**	120 (31.7) 37 (9.8)
MACHINE SPEC: Boom Arm Bucket (SAE) Upper attachment		mm (ft.in) mm (ft.in) m ³ (cu.yd)	2900 (9'6") 1640 (5'5") 0.15 (0.20) ROPS Cab	2900 (9'6") 1640 (5' 5") 0.2 (0.26) ROPS Cab

Item		Model	PC60-8	PC70-8	PC70-8	PC71-7
Source			China	Japan	China	India
OPERATING WEIGHT*		kg (lb)	6180 (13,620)	6590 (14,530)	6500 (14,330)	7050 (15,510)
HORSEPOWER SAE J1995 Gross ISO9249 /SAE J1349 Net Hyd. fan at max. speed Net		kW (HP)/RPM kW (HP)/RPM kW (HP)/RPM	42.8 (57.4)/1950 40.7 (54.2)/1950	50.7 (68)/1950 48.5 (65)/1950	48.5 (65)/1950	44.1 (60)/1900
BUCKET CAPACITY RANGE (SAE)		m ³ (cu.yd)	0.25 – 0.3 (0.33) (0.39)	0.30 – 0.37 (0.39) (0.48)	0.30 – 0.37 (0.39) (0.48)	0.09 – 0.35 (0.12) (0.47)
PERFORMANCE: Swing speed Max travel speed		RPM km/h (MPH) Hi Mi Lo	10.0 4.5 (2.8) 2.8 (1.7)	11.0 4.5 (2.8) 2.8 (1.7)	11.0 4.5 (2.8) 2.8 (1.7)	12.0 3.5 (2.2) 2.3 (1.4)
DIMENSIONS: See the page of dimensions.						
ENGINE: Model No. of cylinders- bore × stroke Piston displacement		mm (in) ltr. (cu.in)	KOMATSU SAA4D95LE-5 4-95 × 115 (3.74 × 4.53) 3.26 (199)	KOMATSU SAA4D95LE-5 4-95 × 115 (3.74 × 4.53) 3.26 (199)	KOMATSU SAA4D95LE-5-L 4-95 × 115 (3.74 × 4.53) 3.26 (199)	KOEL 4R-1040 4-105 × 120 (4.13 × 4.72) 4.16 (254)
HYDRAULIC SYSTEM: Hydraulic pump Max. oil flow Max. oil pressure (Implement)		ltr. (U.S. Gal)/min. kg/cm ² (PSI)	1 × Variable Piston 172 (45.4) 250 (3555)	1 × Variable Piston 172 (45.4) 250 (3555)	1 × Variable Piston 172 (45.4) 250 (3555)	1 × Variable Piston 155 (41.0) 250 (3555)
Track shoe width/ ground pressure		mm (in)/ kg/cm ² (PSI)	450 (18)/ 0.29 (4.12)	450 (18)/ 0.29 (4.12)	450 (18)/ 0.31 (4.41)	450 (18)/ 0.34 (4.82)
CAPACITY (Refilled): Fuel tank Hydraulic oil tank		ltr. (U.S.Gal)	130 (34.3) 61 (16.1)	130 (34.3) 61 (16.1)	130 (34.3) 57 (15.1)	130 (34.3) 57 (15.1)
MACHINE SPEC: Boom Arm Bucket (SAE)		mm (ft.in) mm (ft.in) m ³ (cu.yd)	3650 (12' 0") 1550 (5' 1") 0.25 (0.33)	3710 (12' 2") 1650 (5' 5") 0.30 (0.39)	3710 (12' 2") 1650 (5' 5") 0.30 (0.39)	3710 (12' 2") 1650 (5' 5") 0.30 (0.39)

* Operating weight includes coolant, lubricants, full fuel tank, operator 80kg (180lb) and, indicated implement, shoes and upper attachment.

** Full capacity

• EPA Tier 3 and EU Stage 3A model

Specifications

EXCAVATORS (BACKHOE)

Model		°PC78US-8	PC80MR-3	°PC88MR-8	°PC88MR-8	
Source		Japan	Italy	Japan	Italy	
OPERATING WEIGHT*		kg (lb)	6945 (15,315)	7618 (16,790)	8225 (18,130)	8225 (18,130)
HORSEPOWER SAE J1995 Gross ISO9249 /SAE J1349 Net Hyd. fan at max. speed Net		kW (HP)/RPM kW (HP)/RPM kW (HP)/RPM	42.8 (57)/1950 41.5 (55)/1950	45.6 (61.2)/2200	49 (65)/1950	49 (65)/1950
BUCKET CAPACITY RANGE (SAE)		m ³ (cu.yd)	0.09 ~ 0.34 (0.12) (0.45)	0.086 ~ 0.265 (0.11) (0.35)	0.09 ~ 0.34 (0.12) (0.45)	0.077 ~ 0.282 (0.10) (0.37)
PERFORMANCE: Swing speed Max travel speed		RPM km/h (MPH)	10.0 5.0 (3.1)	10.2 4.9 (3.0)	10.0 5.1 (3.2)	10.0 5.1 (3.2)
		Hi Mi Lo	2.9 (1.8)	2.9 (1.8)	2.9 (1.8)	2.9 (1.8)
DIMENSIONS: See the page of dimensions.						
ENGINE: Model No. of cylinders- bore × stroke Piston displacement		mm (in) ltr. (cu.in)	KOMATSU SAA4D95LE-5 4-95 × 115 (3.74 × 4.53) 3.26 (199)	KOMATSU 4D98E-3ZSFB 4-98 × 110 (3.86 × 4.33) 3.318 (202)	KOMATSU SAA4D95LE-5 4-95 × 115 (3.74 × 4.53) 3.26 (199)	KOMATSU SAA4D95LE-5 4-95 × 115 (3.74 × 4.53) 3.26 (199)
HYDRAULIC SYSTEM: Hydraulic pump Max. oil flow Max. oil pressure (Implement)		ltr. (U.S. Gal)/min. kg/cm ² (PSI)	2 × Variable Piston 223 (49.1) 270 (3840)	1 × Variable Piston+Gear pump 250 (66.1) 270 (3840)	1 × Variable Piston+Gear pump 230 (60.8) 270 (3840)	1 × Variable Piston+Gear pump 230 (60.8) 270 (3840)
Track shoe width/ ground pressure		mm (in)/ kg/cm ² (PSI)	450 (18)/ 0.32 (4.5)	450 (18)/ 0.34 (4.8)	450 (18)/ 0.37 (5.26)	450 (18)/ 0.37 (5.3)
CAPACITY (Refilled): Fuel tank Hydraulic oil tank		ltr. (U.S.Gal)	125 (33) 56 (14.8)	110 (29.1) 65 (17.2)	125 (33) 100 (26.4)	125 (33) 100 (26.4)
MACHINE SPEC: Boom Arm Bucket (SAE)		mm (ft.in) mm (ft.in) m ³ (cu.yd)	3710 (12'2") 1650 (5'5") 0.28 (0.37)	3200 (10'6") 1650 (5'5") 0.2 (0.26)	3405 (11' 2") 1650 (5' 5") 0.28 (0.37)	3405 (11' 2") 2100 (6'11") 0.282 (0.37)

Model		PC110-7	°PC118MR-8	°PC130-8	°PC130-8	
Source		China	Italy	Japan, Thailand	Brazil	
OPERATING WEIGHT*		kg (lb)	10980 (24,210)	11885 (26,200)	12380 (27,300)	12905 (28,450)
HORSEPOWER SAE J1995 Gross ISO9249 /SAE J1349 Net Hyd. fan at max. speed Net		kW (HP)/RPM kW (HP)/RPM kW (HP)/RPM	66 (88.7)/2200	68.4 (91.7)/2200	72.1 (96.6)/2200 68.4 (91.7)/2200	72 (97)/2200 68 (92)/2200
BUCKET CAPACITY RANGE (SAE)		m ³ (cu.yd)	0.48 (0.63)	0.093 ~ 0.40 (0.12) (0.52)	0.18 ~ 0.60 (0.24) (0.78)	0.50 ~ 0.60 (0.65) (0.78)
PERFORMANCE: Swing speed Max travel speed		RPM km/h (MPH)	11.0 5.5 (3.4)	8.5 4.5 (2.8)	11.0 5.5 (3.4)	11.0 5.5 (3.4)
		Hi Mi Lo	2.7 (1.7)	3.0 (1.9)	2.9 (1.8)	2.9 (1.8)
DIMENSIONS: See the page of dimensions.						
ENGINE: Model No. of cylinders- bore × stroke Piston displacement		mm (in) ltr. (cu.in)	KOMATSU SAA4D95LE-3 4-95 × 115 (3.74 × 4.53) 3.26 (199)	KOMATSU SAA4D95LE-5 4-95 × 115 (3.74 × 4.53) 3.26 (199)	KOMATSU SAA4D95LE-5 4-95 × 115 (3.74 × 4.53) 3.26 (199)	KOMATSU SAA4D95LE-5 4-95 × 115 (3.74 × 4.53) 3.26 (199)
HYDRAULIC SYSTEM: Hydraulic pump Max. oil flow Max. oil pressure (Implement)		ltr. (U.S. Gal)/min. kg/cm ² (PSI)	1 × Variable Piston+Gear pump 226 (59.7) 325 (4620)	1 × Variable Piston+Gear pump 278 (73.4) 300 (4270)	1 × Variable Piston 241.5 (63.8) 325 (4620)	1 × Variable Piston+Gear pump 242 (63.9) 325 (4620)
Track shoe width/ ground pressure		mm (in)/ kg/cm ² (PSI)	500 (20)/ 0.37 (5.26)	500 (20)/ 0.43 (6.11)	500 (20)/ 0.39 (5.6)	500 (20)/ 0.41 (5.83)
CAPACITY (Refilled): Fuel tank Hydraulic oil tank		ltr. (U.S.Gal)	247 (65.3) 90 (23.8)	150 (39.6) 80 (21.1)	247 (65.3) 90 (23.8)	247 (65.3) 90 (23.8)
MACHINE SPEC: Boom Arm Bucket (SAE)		mm (ft.in) mm (ft.in) m ³ (cu.yd)	4260 (14' 0") 2260 (7' 5") 0.48 (0.63)	3505 (11' 5") 2000 (6' 7") 0.38 (0.50)	4600 (15'1") 2500 (8'2") 0.50 (0.65)	4600 (15' 1") 2500 (8' 2") 0.6 (0.78)

* Operating weight includes coolant, lubricants, full fuel tank, operator 80kg (180lb) and, indicated implement, shoes and upper attachment.

- EPA Tier 3 and EU Stage 3A model
- EPA Tier 4 Interim and EU Stage 3B model

Specifications

EXCAVATORS (BACKHOE)

Item		Model	PC130-7	PC130-7	PC130F-7	•PC138US-8
Source			India	China	Indonesia	Japan
OPERATING WEIGHT*		kg (lb)	12600 (27,780)	12600 (27,780)	13975 (30,810)	13480 (29,720)
HORSEPOWER SAE J1995 Gross ISO9249 /SAE J1349 Net Hyd. fan at max. speed Net		kW (HP)/RPM kW (HP)/RPM kW (HP)/RPM	66 (89)/2200	66 (88)/2200	66 (88)/2200	72.1 (96.6)/2200 68.4 (91.7)/2200
BUCKET CAPACITY RANGE (SAE)		m ³ (cu.yd)	0.53 ~ 0.70 (0.69) (0.91)	0.36 ~ 0.64 (0.47) (0.84)	0.45 ~ 0.55 (0.59) (0.72)	0.18 ~ 0.60 (0.24) (0.78)
PERFORMANCE: Swing speed Max travel speed		RPM km/h (MPH) Hi Mi Lo	11.0 5.5 (3.4) 2.7 (1.67)	11.0 5.5 (3.4) 2.7 (1.7)	11.0 4.2 (2.6) 2.4 (1.5)	11.0 5.1 (3.2) 2.9 (1.8)
DIMENSIONS: See the page of dimensions.						
ENGINE: Model No. of cylinders- bore × stroke Piston displacement		mm (in) ltr. (cu.in)	KOMATSU SAA4D95LE-3 4-95 × 115 (3.74 × 4.53) 3.26 (199)	KOMATSU SAA4D95LE 4-95 × 115 (3.74 × 4.53) 3.26 (199)	KOMATSU SAA4D95LE-3 4-95 × 115 (3.74 × 4.53) 3.26 (199)	KOMATSU SAA4D95LE-5 4-95 × 115 (3.74 × 4.53) 3.26 (199)
HYDRAULIC SYSTEM: Hydraulic pump Max. oil flow Max. oil pressure (Implement)		ltr. (U.S. Gal)/min. kg/cm ² (PSI)	1 × Variable Piston+Gear pump 226 (59.7) 325 (4620)	1 × Variable Piston 226 (60) 355 (5050)	1 × Variable Piston+Gear pump 312 (82.4) 325 (4620)	1 × Variable Piston 241.5 (63.8) 355 (5050)
Track shoe width/ ground pressure		mm (in)/ kg/cm ² (PSI)	500 (20)/ 0.39 (5.54)	500 (20)/ 0.39 (5.5)	900 (35.4)/ 0.26 (3.70)	500 (20)/ 0.43 (6.1)
CAPACITY (Refilled): Fuel tank Hydraulic oil tank		ltr. (U.S.Gal)	247 (65.3) 90 (23.8)	247 (65.3) 90 (23.8)	247 (65.3) 90 (23.8)	195 (51.5) 69 (18.2)
MACHINE SPEC: Boom Arm Bucket (SAE)		mm (ft.in) mm (ft.in) m ³ (cu.yd)	4600 (15' 1") 2100 (6'10") 0.64 (0.83)	4600 (15'1") 2500 (8'2") 0.53 (0.69)	4260 (14' 0") 2360 (7' 9") 0.55 (0.72)	4600 (15'1") 2500 (8'2") 0.50 (0.65)

Item		Model	○PC138USLC-10	•PC160LC-8	•PC160LC-8	•PC160LC-8
Source			USA	Japan	UK	Thailand
OPERATING WEIGHT*		kg (lb)	14600 (32,190)	16680 (36,770)	17260 (38,050)	16760 (36,850)
HORSEPOWER SAE J1995 Gross ISO9249 /SAE J1349 Net Hyd. fan at max. speed Net		kW (HP)/RPM kW (HP)/RPM kW (HP)/RPM	72.6 (97.3)/2050 69.7 (93.5)/2050	90 (121)/2200 86 (115)/2200	90 (121)/2200 86 (115)/2200	90 (121)/2200 86 (115)/2200
BUCKET CAPACITY RANGE (SAE)		m ³ (cu.yd)	0.26 ~ 0.76 (0.34) (0.99)	0.60 ~ 0.70 (0.78) (0.92)	0.38 ~ 0.94 (0.50) (1.23)	0.60 ~ 0.74 (0.78) (0.97)
PERFORMANCE: Swing speed Max travel speed		RPM km/h (MPH) Hi Mi Lo	11.0 5.1 (3.2) 2.9 (1.8)	12.0 5.5 (3.4) 3.4 (2.1)	12.0 5.5 (3.4) 3.4 (2.1)	12.0 5.5 (3.4) 3.4 (2.1)
DIMENSIONS: See the page of dimensions.						
ENGINE: Model No. of cylinders- bore × stroke Piston displacement		mm (in) ltr. (cu.in)	KOMATSU SAA4D95LE-6 4-95 × 115 (3.74 × 4.53) 3.26 (199)	KOMATSU SAA4D107E-1 4-107 × 124 (4.21 × 4.88) 4.46 (272)	KOMATSU SAA4D107E-1 4-107 × 124 (4.21 × 4.88) 4.46 (272)	KOMATSU SAA4D107E-1 4-107 × 124 (4.21 × 4.88) 4.46 (272)
HYDRAULIC SYSTEM: Hydraulic pump Max. oil flow Max. oil pressure (Implement)		ltr. (U.S. Gal)/min. kg/cm ² (PSI)	1 × Variable Piston+Gear pump 242 (63.9) 355 (5050)	2 × Variable Piston 312 (82.4) 380 (5400)	2 × Variable Piston 312 (82.4) 380 (5400)	2 × Variable Piston 312 (82.4) 380 (5400)
Track shoe width/ ground pressure		mm (in)/ kg/cm ² (PSI)	600 (24)/ 0.36 (5.12)	500 (20)/ 0.49 (7.0)	500 (20)/ 0.53 (7.54)	500 (20)/ 0.49 (6.96)
CAPACITY (Refilled): Fuel tank Hydraulic oil tank		ltr. (U.S.Gal)	200 (52.8) 69 (18.2)	280 (74) 121 (32.0)	280 (74) 121 (32)	280 (74) 121 (32)
MACHINE SPEC: Boom Arm Bucket (SAE)		mm (ft.in) mm (ft.in) m ³ (cu.yd)	4600 (15' 1") 2500 (8' 2") 0.50 (0.65)	5150 (16'11") 2610 (8'7") 0.65 (0.85)	5150 (16'11") 2610 (8'7") 0.66 (0.86)	5150 (16'11") 2900 (9'6") 0.74 (0.97)

* Operating weight includes coolant, lubricants, full fuel tank, operator 80kg (180lb) and, indicated implement, shoes and upper attachment.

- EPA Tier 3 and EU Stage 3A model
- EPA Tier 4 Interim and EU Stage 3B model

Specifications

EXCAVATORS (BACKHOE)

Model		•PC160LC-8	PC160LC-7	•PC190LC-8	•PC190NLC-8
Source		Brazil	China	UK	UK
OPERATING WEIGHT*		17400 (38,360)	16400 (36,160)	19040 (41,980)	18820 (41,490)
HORSEPOWER SAE J1995 Gross ISO9249 /SAE J1349 Net Hyd. fan at max. speed Net		kW (HP)/RPM 90 (121)/2200 kW (HP)/RPM 86 (115)/2200	82.4 (111)/2200	92 (123)/2200	92 (123)/2200
BUCKET CAPACITY RANGE (SAE)		0.65 ~ 1.20 (0.85) (1.57)	0.65 ~ 0.75 (0.85) (0.98)	0.38 ~ 1.14 (0.50) (1.49)	0.38 ~ 1.14 (0.50) (1.49)
PERFORMANCE: Swing speed Max travel speed		RPM 12.0 km/h (MPH) 5.5 (3.4)	12.0 5.5 (3.4)	12.0 5.5 (3.4)	12.0 5.5 (3.4)
DIMENSIONS: See the page of dimensions.		3.4 (2.1)	3.4 (2.1)	3.4 (2.1)	3.4 (2.1)
ENGINE: Model No. of cylinders- bore × stroke Piston displacement		mm (in) ltr. (cu.in) KOMATSU SAA4D107E-1 4-107 × 124 (4.21 × 4.88) 4.46 (272)	mm (in) KOMATSU SAA4D102E-2 4-102 × 120 (4.05 × 4.72) 3.92 (239)	mm (in) KOMATSU SAA4D107E-1 4-107 × 124 (4.21 × 4.88) 4.46 (272)	mm (in) KOMATSU SAA4D107E-1 4-107 × 124 (4.21 × 4.88) 4.46 (272)
HYDRAULIC SYSTEM: Hydraulic pump Max. oil flow Max. oil pressure (Implement)		ltr. (U.S. Gal)/min. kg/cm ² (PSI) 312 (82.4) 380 (5400)	2 × Variable Piston 312 (82.4) 380 (5400)	2 × Variable Piston 312 (82.4) 380 (5400)	2 × Variable Piston 312 (82.4) 380 (5400)
Track shoe width/ ground pressure		mm (in)/ kg/cm ² (PSI) 700 (28)/ 0.36 (5.12)	500 (20)/ 0.47 (6.7)	600 (24)/ 0.44 (6.26)	500 (20)/ 0.50 (7.11)
CAPACITY (Refilled): Fuel tank Hydraulic oil tank		ltr. (U.S.Gal) 280 (74) 121 (32)	280 (74) 121 (32.0)	280 (74) 121 (32)	280 (74) 121 (32)
MACHINE SPEC: Boom Arm Bucket (SAE)		mm (ft.in) mm (ft.in) m ³ (cu.yd) 5150 (16'11") 2250 (7' 5") 0.80 (1.05)	5150 (16'11") 2610 (8'7") 0.65 (0.85)	5150 (16'11") 2610 (8'7") 0.75 (0.98)	5150 (16'11") 2610 (8'7") 0.75 (0.98)

Model		•HB205-1	•HB215LC-1	•HB215LC-1	•PC200-8
Source		Japan	Japan	UK	Japan, Russia
OPERATING WEIGHT*		20200 (44,530)	21600 (47,620)	21220 (46,780)	19500 (42,990)
HORSEPOWER SAE J1995 Gross ISO9249 /SAE J1349 Net Hyd. fan at max. speed Net		kW (HP)/RPM 110 (148)/2000 104 (139)/2000	110 (148)/2000 104 (139)/2000	110 (148)/2000 104 (139)/2000	116 (155)/2000 110 (148)/2000
BUCKET CAPACITY RANGE (SAE)		0.80 ~ 1.05 (1.05) (1.37)	0.80 ~ 1.05 (1.05) (1.37)	0.43 ~ 1.68 (0.56) (2.20)	0.50 ~ 1.17 (0.65) (1.53)
PERFORMANCE: Swing speed Max travel speed		RPM 12.4 km/h (MPH) 5.5 (3.4) 4.1 (2.5) 3.0 (1.9)	12.4 5.5 (3.4) 4.1 (2.5) 3.0 (1.9)	12.4 5.5 (3.4) 4.1 (2.5) 3.0 (1.9)	12.4 5.5 (3.4) 4.1 (2.5) 3.0 (1.9)
DIMENSIONS: See the page of dimensions.					
ENGINE: Model No. of cylinders- bore × stroke Piston displacement		mm (in) ltr. (cu.in) KOMATSU SAA4D107E-1-A 4-107 × 124 (4.21 × 4.88) 4.46 (272)	mm (in) KOMATSU SAA4D107E-1-A 4-107 × 124 (4.21 × 4.88) 4.46 (272)	mm (in) KOMATSU SAA4D107E-1-A 4-107 × 124 (4.21 × 4.88) 4.46 (272)	mm (in) KOMATSU SAA6D107E-1 6-107 × 124 (4.21 × 4.88) 6.69 (408)
HYDRAULIC SYSTEM: Hydraulic pump Max. oil flow Max. oil pressure (Implement)		ltr. (U.S. Gal)/min. kg/cm ² (PSI) 439 (116) 380 (5400)	2 × Variable Piston 439 (116) 380 (5400)	2 × Variable Piston 439 (116) 380 (5400)	2 × Variable Piston 439 (116) 380 (5400)
Track shoe width/ ground pressure		mm (in)/ kg/cm ² (PSI) 600 (24)/ 0.47 (6.68)	700 (28)/ 0.39 (5.55)	600 (24)/ 0.45 (6.40)	600 (24)/ 0.46 (6.54)
CAPACITY (Refilled): Fuel tank Hydraulic oil tank		ltr. (U.S.Gal) 400 (106) 135 (36)	400 (106) 135 (36)	400 (106) 135 (36)	400 (105.7) 135 (35.7)
MACHINE SPEC: Boom Arm Bucket (SAE)		mm (ft.in) mm (ft.in) m ³ (cu.yd) 5700 (18' 8") 2925 (9' 7") 0.80 (1.05)	5700 (18' 8") 2925 (9' 7") 0.80 (1.05)	5700 (18' 8") 2925 (9' 7") 0.80 (1.05)	5700 (18' 8") 2925 (9' 7") 0.80 (1.05)

- * Operating weight includes coolant, lubricants, full fuel tank, operator 80kg (180lb) and, indicated implement, shoes and upper attachment.
- EPA Tier 3 and EU Stage 3A model

Specifications

EXCAVATORS (BACKHOE)

Item		Model	PC200-8M0	•PC200-8	PC200-8M0	•PC200-8
Source			Japan	Indonesia	Thailand	China
OPERATING WEIGHT*		kg (lb)	19900 (43,870)	20010 (44,110)	19900 (43,870)	19900 (43,870)
HORSEPOWER		SAE J1995 Gross ISO9249 /SAE J1349 Net Hyd. fan at max. speed Net	kW (HP)/RPM 110 (147)/2000 103 (138)/2000	116 (155)/2000 110 (148)/2000	110 (147)/2000 103 (138)/2000	116 (155)/2000 110 (148)/2000
BUCKET CAPACITY RANGE (SAE)		m ³ (cu.yd)	0.50 ~ 1.17 (0.65) (1.53)	0.8 ~ 0.93 (1.05) (1.22)	0.50 ~ 1.17 (0.65) (1.53)	0.80 ~ 1.00 (1.05) (1.31)
PERFORMANCE:						
Swing speed		RPM	12.4	12.4	12.4	12.4
Max travel speed		Hi Mi Lo	5.5 (3.4) 4.1 (2.5) 3.0 (1.9)	5.5 (3.4) 4.1 (2.5) 3.0 (1.9)	5.5 (3.4) 4.1 (2.5) 3.0 (1.9)	5.5 (3.4) 4.1 (2.5) 3.0 (1.9)
DIMENSIONS: See the page of dimensions.						
ENGINE:						
Model			KOMATSU SAA4D107E-1	KOMATSU SAA6D107E-1	KOMATSU SAA4D107E-1	KOMATSU SAA6D107E-1
No. of cylinders- bore × stroke		mm (in)	4-107 × 124 (4.21 × 4.88)	6-107 × 124 (4.21 × 4.88)	4-107 × 124 (4.21 × 4.88)	6-107 × 124 (4.21 × 4.88)
Piston displacement		ltr. (cu.in)	4.46 (272)	6.69 (408)	4.46 (272)	6.69 (408)
HYDRAULIC SYSTEM:						
Hydraulic pump			2 × Variable Piston	2 × Variable Piston	2 × Variable Piston	2 × Variable Piston
Max. oil flow		ltr. (U.S. Gal)/min.	439 (116)	439 (116)	439 (116)	439 (116)
Max. oil pressure (Implement)		kg/cm ² (PSI)	380 (5400)	380 (5400)	380 (5400)	380 (5400)
Track shoe width/ ground pressure		mm (in)/ kg/cm ² (PSI)	600 (24)/ 0.47 (6.68)	800 (31.5)/ 0.35 (5.00)	600 (24)/ 0.47 (6.68)	600 (24)/ 0.46 (6.5)
CAPACITY (Refilled):						
Fuel tank		ltr. (U.S.Gal)	400 (106)	400 (106)	400 (106)	400 (105.7)
Hydraulic oil tank			135 (36)	135 (36)	135 (36)	135 (35.7)
MACHINE SPEC:						
Boom		mm (ft.in)	5700 (18' 8")	5700 (18' 8")	5700 (18' 8")	5700 (18' 8")
Arm		mm (ft.in)	2925 (9' 7")	2925 (9' 7")	2925 (9' 7")	2925 (9' 7")
Bucket (SAE)		m ³ (cu.yd)	0.80 (1.05)	0.80 (1.05)	0.80 (1.05)	0.8 (1.05)

Item		Model	•PC200-8	PC200-7	•PC200LC-8	PC200LC-8M0
Source			Brazil	Japan	Japan, Russia	Japan
OPERATING WEIGHT*		kg (lb)	21000 (46,300)	19500 (42,990)	20900 (46,080)	21100 (46,520)
HORSEPOWER		SAE J1995 Gross ISO9249 /SAE J1349 Net Hyd. fan at max. speed Net	kW (HP)/RPM 116 (155)/2000 110 (148)/2000	107 (143)/1950	116 (155)/2000 110 (148)/2000	110 (147)/2000 103 (138)/2000
BUCKET CAPACITY RANGE (SAE)		m ³ (cu.yd)	0.8 ~ 1.5 (1.05) (1.96)	0.50 ~ 1.17 (0.65) (1.53)	0.50 ~ 1.17 (0.65) (1.53)	0.50 ~ 1.17 (0.65) (1.53)
PERFORMANCE:						
Swing speed		RPM	12.4	12.4	12.4	12.4
Max travel speed		Hi Mi Lo	5.5 (3.4) 4.1 (2.5) 3.0 (1.9)	5.5 (3.4) 3.0 (1.9)	5.5 (3.4) 4.1 (2.5) 3.0 (1.9)	5.5 (3.4) 4.1 (2.5) 3.0 (1.9)
DIMENSIONS: See the page of dimensions.						
ENGINE:						
Model			KOMATSU SAA6D107E-1	KOMATSU SAA6D102E-2	KOMATSU SAA6D107E-1	KOMATSU SAA4D107E-1
No. of cylinders- bore × stroke		mm (in)	6-107 × 124 (4.21 × 4.88)	6-102 × 120 (4.02 × 4.72)	6-107 × 124 (4.21 × 4.88)	4-107 × 124 (4.21 × 4.88)
Piston displacement		ltr. (cu.in)	6.69 (408)	5.88 (359)	6.69 (408)	4.46 (272)
HYDRAULIC SYSTEM:						
Hydraulic pump			2 × Variable Piston	2 × Variable Piston	2 × Variable Piston	2 × Variable Piston
Max. oil flow		ltr. (U.S. Gal)/min.	438 (116)	428 (113)	439 (116)	439 (116)
Max. oil pressure (Implement)		kg/cm ² (PSI)	380 (5400)	380 (5400)	380 (5400)	380 (5400)
Track shoe width/ ground pressure		mm (in)/ kg/cm ² (PSI)	700 (28)/ 0.40 (5.69)	600 (24)/ 0.46 (6.5)	700 (28)/ 0.44 (6.26)	700 (28)/ 0.44 (6.26)
CAPACITY (Refilled):						
Fuel tank		ltr. (U.S.Gal)	400 (106)	400 (105.7)	400 (105.7)	400 (106)
Hydraulic oil tank			135 (36)	143 (37.8)	135 (35.7)	135 (36)
MACHINE SPEC:						
Boom		mm (ft.in)	5700 (18' 8")	5700 (18' 8")	5700 (18' 8")	5700 (18' 8")
Arm		mm (ft.in)	2410 (7'11")	2925 (9' 7")	2925 (9' 7")	2925 (9' 7")
Bucket (SAE)		m ³ (cu.yd)	1.2 (1.57)	0.80 (1.05)	0.80 (1.05)	0.80 (1.05)

* Operating weight includes coolant, lubricants, full fuel tank, operator 80kg (180lb) and, indicated implement, shoes and upper attachment.

- EPA Tier 3 and EU Stage 3A model

Specifications

EXCAVATORS (BACKHOE)

Item		Model	PC200LC-8M0	•PC200LC-8	•PC200LC-8	°PC210-10
Source			Thailand	China	Brazil	UK
OPERATING WEIGHT*		kg (lb)	21100 (46,520)	21300 (46,960)	22680 (500,000)	22020 (48,560)
HORSEPOWER		SAE J1995 Gross ISO9249 /SAE J1349 Net Hyd. fan at max. speed Net	kW (HP)/RPM 110 (147)/2000 kW (HP)/RPM 103 (138)/2000	116 (155)/2000 110 (148)/2000	116 (155)/2000 110 (148)/2000	123 (165)/2000 118 (158)/2000
BUCKET CAPACITY RANGE (SAE)		m ³ (cu.yd)	0.50 ~ 1.17 (0.65) (1.53)	0.80 ~ 1.00 (1.05) (1.31)	0.80 ~ 1.50 (1.05) (1.96)	0.43 ~ 1.68 (0.56) (2.20)
PERFORMANCE:						
Swing speed		RPM	12.4	12.4	12.4	12.4
Max travel speed		Hi Mi Lo	5.5 (3.4) 4.1 (2.5) 3.0 (1.9)	5.5 (3.4) 4.1 (2.5) 3.0 (1.9)	5.5 (3.4) 4.1 (2.5) 3.0 (1.9)	5.5 (3.4) 4.1 (2.5) 3.0 (1.9)
DIMENSIONS: See the page of dimensions.						
ENGINE:						
Model			KOMATSU SAA4D107E-1	KOMATSU SAA6D107E-1	KOMATSU SAA6D107E-1	KOMATSU SAA6D107E-2
No. of cylinders- bore × stroke		mm (in)	4-107 × 124 (4.21 × 4.88)	6-107 × 124 (4.21 × 4.88)	6-107 × 124 (4.21 × 4.88)	6-107 × 124 (4.21 × 4.88)
Piston displacement		ltr. (cu.in)	4.46 (272)	6.69 (408)	6.69 (408)	6.69 (408)
HYDRAULIC SYSTEM:						
Hydraulic pump			2 × Variable Piston	2 × Variable Piston	2 × Variable Piston	2 × Variable Piston
Max. oil flow		ltr. (U.S. Gal)/min.	439 (116)	439 (116)	438 (116)	475 (125.5)
Max. oil pressure (Implement)		kg/cm ² (PSI)	380 (5400)	380 (5400)	380 (5400)	380 (5400)
Track shoe width/ ground pressure		mm (in)/ kg/cm ² (PSI)	700 (28)/ 0.44 (6.26)	600 (24)/ 0.45 (6.4)	800 (31.5)/ 0.38 (5.40)	600 (24)/ 0.51 (7.25)
CAPACITY (Refilled):						
Fuel tank		ltr. (U.S.Gal)	400 (106)	400 (105.7)	400 (106)	400 (106)
Hydraulic oil tank			135 (36)	135 (35.7)	135 (36)	132 (35)
MACHINE SPEC:						
Boom		mm (ft.in)	5700 (18' 8")	5700 (18'8")	5200 (17' 1")	5700 (18' 8")
Arm		mm (ft.in)	2925 (9' 7")	2925 (9'7")	2410 (7'11")	2925 (9' 7")
Bucket (SAE)		m ³ (cu.yd)	0.80 (1.05)	0.80 (1.05)	1.5 (1.96)	0.84 (1.10)

Item		Model	•PC210-8	°PC210LC-10	°PC210LC-10	•PC210NLC-8
Source			China	USA	UK	UK
OPERATING WEIGHT*		kg (lb)	20000 (44,090)	23603 (52,036)	22620 (49,870)	21830 (48,130)
HORSEPOWER		SAE J1995 Gross ISO9249 /SAE J1349 Net Hyd. fan at max. speed Net	kW (HP)/RPM 116 (155)/2000 110 (148)/2000	123 (165)/2000 118 (158)/2000	123 (165)/2000 118 (158)/2000	116 (155)/2000 110 (148)/2000
BUCKET CAPACITY RANGE (SAE)		m ³ (cu.yd)	0.80 ~ 1.00 (1.05) (1.31)	0.50 ~ 1.20 (0.65) (1.57)	0.43 ~ 1.68 (0.56) (2.20)	0.43 ~ 1.68 (0.56) (2.20)
PERFORMANCE:						
Swing speed		RPM	12.4	12.4	12.4	12.4
Max travel speed		Hi Mi Lo	5.5 (3.4) 4.1 (2.5) 3.0 (1.9)	5.5 (3.4) 4.1 (2.5) 3.0 (1.9)	5.5 (3.4) 4.1 (2.5) 3.0 (1.9)	5.5 (3.4) 4.1 (2.5) 3.0 (1.9)
DIMENSIONS: See the page of dimensions.						
ENGINE:						
Model			KOMATSU SAA6D107E-1	KOMATSU SAA6D107E-2	KOMATSU SAA6D107E-2	KOMATSU SAA6D107E-1
No. of cylinders- bore × stroke		mm (in)	6-107 × 124 (4.21 × 4.88)	6-107 × 124 (4.21 × 4.88)	6-107 × 124 (4.21 × 4.88)	6-107 × 124 (4.21 × 4.88)
Piston displacement		ltr. (cu.in)	6.69 (408)	6.69 (408)	6.69 (408)	6.69 (408)
HYDRAULIC SYSTEM:						
Hydraulic pump			2 × Variable Piston	2 × Variable Piston	2 × Variable Piston	2 × Variable Piston
Max. oil flow		ltr. (U.S. Gal)/min.	439 (116)	475 (125.5)	475 (125.5)	439 (116)
Max. oil pressure (Implement)		kg/cm ² (PSI)	380 (5400)	380 (5400)	380 (5400)	380 (5400)
Track shoe width/ ground pressure		mm (in)/ kg/cm ² (PSI)	600 (24)/ 0.46 (6.5)	800 (32)/ 0.38 (5.5)	600 (24)/ 0.48 (6.83)	500 (20)/ 0.55 (7.82)
CAPACITY (Refilled):						
Fuel tank		ltr. (U.S.Gal)	400 (105.7)	400 (106)	400 (106)	325 (85.9)
Hydraulic oil tank			135 (35.7)	132 (35)	132 (35)	137 (36.2)
MACHINE SPEC:						
Boom		mm (ft.in)	5700 (18'8")	5700 (18' 8")	5700 (18' 8")	5700 (18' 8")
Arm		mm (ft.in)	2925 (9'7")	2925 (9' 7")	2925 (9' 7")	2925 (9' 7")
Bucket (SAE)		m ³ (cu.yd)	0.90 (1.18)	1.02 (1.34)	0.84 (1.10)	0.84 (1.10)

* Operating weight includes coolant, lubricants, full fuel tank, operator 80kg (180lb) and, indicated implement, shoes and upper attachment.

- EPA Tier 3 and EU Stage 3A model
- EPA Tier 4 Interim and EU Stage 3B model

Specifications

EXCAVATORS (BACKHOE)

Item		Model	•PC210LC-8	•PC210LC-8	•PC220-8	•PC220-8
Source			China	India	Japan, Russia	China
OPERATING WEIGHT*		kg (lb)	21400 (47,180)	21600 (47,620)	22900 (50,490)	23100 (50,930)
HORSEPOWER		SAE J1995 Gross ISO9249 /SAE J1349 Net Hyd. fan at max. speed Net	kW (HP)/RPM 116 (155)/2000 kW (HP)/RPM 110 (148)/2000	116 (155)/2000 110 (148)/2000	134 (179)/2000 125 (168)/2000	134 (179)/2000 125 (168)/2000
BUCKET CAPACITY RANGE (SAE)		m ³ (cu.yd)	0.80 ~ 1.00 (1.05) (1.31)	0.95 ~ 1.05 (1.24) (1.37)	0.72 ~ 1.26 (0.94) (1.65)	1.0 ~ 1.26 (1.31) (1.65)
PERFORMANCE:						
Swing speed		RPM	12.4	12.4	11.7	11.7
Max travel speed		Hi Mi Lo	5.5 (3.4) 4.1 (2.5) 3.0 (1.9)	5.5 (3.4) 4.1 (2.5) 3.0 (1.9)	5.5 (3.4) 4.2 (2.6) 3.1 (1.9)	5.5 (3.4) 4.2 (2.6) 3.1 (1.9)
DIMENSIONS: See the page of dimensions.						
ENGINE:						
Model			KOMATSU SAA6D107E-1	KOMATSU SAA6D107E-1	KOMATSU SAA6D107E-1	KOMATSU SAA6D107E-1
No. of cylinders- bore × stroke		mm (in)	6-107 × 120 (4.21 × 4.88)	6-107 × 124 (4.21 × 4.88)	6-107 × 124 (4.21 × 4.88)	6-107 × 120 (4.21 × 4.88)
Piston displacement		ltr. (cu.in)	6.69 (408)	6.69 (408)	6.69 (408)	6.69 (408)
HYDRAULIC SYSTEM:						
Hydraulic pump			2 × Variable Piston	2 × Variable Piston	2 × Variable Piston	2 × Variable Piston
Max. oil flow		ltr. (U.S. Gal)/min.	439 (116)	438 (116)	439 (116)	439 (116)
Max. oil pressure (Implement)		kg/cm ² (PSI)	380 (5400)	380 (5400)	380 (5400)	380 (5400)
Track shoe width/ ground pressure		mm (in)/ kg/cm ² (PSI)	600 (24)/ 0.45 (6.4)	600 (24)/ 0.47 (6.68)	600 (24)/ 0.51 (7.25)	600 (24)/ 0.5 (7.1)
CAPACITY (Refilled):						
Fuel tank		ltr. (U.S.Gal)	400 (105.7)	325 (86)	400 (105.7)	400 (105.7)
Hydraulic oil tank			135 (35.7)	137 (36)	135 (35.7)	135 (35.7)
MACHINE SPEC:						
Boom		mm (ft.in)	5700 (18'8")	5700 (18' 8")	5850 (19'2")	5850 (19'2")
Arm		mm (ft.in)	2925 (9'7")	2400 (7'10")	3045 (10'0")	3045 (10'0")
Bucket (SAE)		m ³ (cu.yd)	0.90 (1.18)	1.05 (1.37)	1.00 (1.31)	1.0 (1.31)

Item		Model	PC220-8M0	PC220-7	•PC220LC-8	PC220LC-8M0
Source			Japan	Japan	Japan, Russia	Japan
OPERATING WEIGHT*		kg (lb)	23200 (51,150)	22840 (50,350)	24330 (53,640)	24600 (54,230)
HORSEPOWER		SAE J1995 Gross ISO9249 /SAE J1349 Net Hyd. fan at max. speed Net	kW (HP)/RPM 129 (173)/2000 123 (164)/2000	129 (173)/2000 125 (168)/2200	134 (179)/2000 125 (168)/2000	129 (173)/2000 123 (164)/2000
BUCKET CAPACITY RANGE (SAE)		m ³ (cu.yd)	0.72 ~ 1.26 (0.94) (1.65)	0.72 ~ 1.26 (0.94) (1.65)	0.72 ~ 1.26 (0.94) (1.65)	0.72 ~ 1.26 (0.94) (1.65)
PERFORMANCE:						
Swing speed		RPM	11.7	11.7	11.7	11.7
Max travel speed		Hi Mi Lo	5.5 (3.4) 4.2 (2.6) 3.1 (1.9)	5.5 (3.4) 3.1 (1.9)	5.5 (3.4) 4.2 (2.6) 3.1 (1.9)	5.5 (3.4) 4.2 (2.6) 3.1 (1.9)
DIMENSIONS: See the page of dimensions.						
ENGINE:						
Model			KOMATSU SAA6D107E-1	KOMATSU SAA6D102E-2	KOMATSU SAA6D107E-1	KOMATSU SAA6D107E-1
No. of cylinders- bore × stroke		mm (in)	6-107 × 124 (4.21 × 4.88)	6-102 × 120 (4.02 × 4.72)	6-107 × 124 (4.21 × 4.88)	6-107 × 124 (4.21 × 4.88)
Piston displacement		ltr. (cu.in)	6.69 (408)	5.88 (359)	6.69 (408)	6.69 (408)
HYDRAULIC SYSTEM:						
Hydraulic pump			2 × Variable Piston	2 × Variable Piston	2 × Variable Piston	2 × Variable Piston
Max. oil flow		ltr. (U.S. Gal)/min.	439 (116)	439 (116)	439 (116)	439 (116)
Max. oil pressure (Implement)		kg/cm ² (PSI)	380 (5400)	380 (5400)	380 (5400)	380 (5400)
Track shoe width/ ground pressure		mm (in)/ kg/cm ² (PSI)	600 (24)/ 0.52 (7.39)	600 (24)/ 0.51 (7.3)	700 (28)/ 0.42 (5.97)	600 (24)/ 0.52 (7.39)
CAPACITY (Refilled):						
Fuel tank		ltr. (U.S.Gal)	400 (106)	400 (105.7)	400 (105.7)	400 (106)
Hydraulic oil tank			135 (36)	143 (37.8)	135 (35.7)	135 (36)
MACHINE SPEC:						
Boom		mm (ft.in)	5850 (19' 2")	5850 (19'2")	5850 (19'2")	5850 (19' 2")
Arm		mm (ft.in)	3045 (10' 0")	3045 (10'0")	3045 (10'0")	3045 (10' 0")
Bucket (SAE)		m ³ (cu.yd)	1.0 (1.31)	1.0 (1.31)	1.0 (1.31)	1.0 (1.31)

* Operating weight includes coolant, lubricants, full fuel tank, operator 80kg (180lb) and, indicated implement, shoes and upper attachment.

- EPA Tier 3 and EU Stage 3A model

Specifications

EXCAVATORS (BACKHOE)

Item		Model	PC220LC-7	•PC228US-8	•PC228USLC-8	•PC228USLC-8
Source			Japan	Japan	Japan	Japan (for USA)
OPERATING WEIGHT*		kg (lb)	24270 (53,510)	21900 (48,280)	23100 (50,930)	24675 (54,405)
HORSEPOWER		SAE J1995 Gross ISO9249 /SAE J1349 Net Hyd. fan at max. speed Net	kW (HP)/RPM kW (HP)/RPM kW (HP)/RPM	116 (155)/2000 110 (148)/2000	116 (155)/2000 110 (148)/2000	116 (155)/2000 110 (148)/2000
BUCKET CAPACITY RANGE (SAE)		m ³ (cu.yd)	0.72 ~ 1.26 (0.94) (1.65)	0.50 ~ 1.10 (0.65) (1.31)	0.50 ~ 1.10 (0.65) (1.31)	0.50 ~ 1.20 (0.65) (1.57)
PERFORMANCE:						
Swing speed		RPM	11.7	11.0	11.0	11.0
Max travel speed		Hi Mi Lo	5.5 (3.4)	5.5 (3.4) 4.1 (2.5) 3.0 (1.9)	5.5 (3.4) 4.1 (2.5) 3.0 (1.9)	5.5 (3.4) 4.1 (2.5) 3.0 (1.9)
DIMENSIONS: See the page of dimensions.						
ENGINE:						
Model			KOMATSU SAA6D102E-2	KOMATSU SAA6D107E-1	KOMATSU SAA6D107E-1	KOMATSU SAA6D107E-1
No. of cylinders- bore × stroke		mm (in)	6-107 × 120 (4.02 × 4.72)	6-107 × 124 (4.21 × 4.88)	6-107 × 124 (4.21 × 4.88)	6-107 × 124 (4.21 × 4.88)
Piston displacement		ltr. (cu.in)	5.88 (359)	6.69 (408)	6.69 (408)	6.69 (408)
HYDRAULIC SYSTEM:						
Hydraulic pump			2 × Variable Piston	2 × Variable Piston	2 × Variable Piston	2 × Variable Piston
Max. oil flow		ltr. (U.S. Gal)/min.	439 (116)	428 (113)	428 (113)	428 (113)
Max. oil pressure (Implement)		kg/cm ² (PSI)	380 (5400)	380 (5400)	380 (5400)	380 (5400)
Track shoe width/ ground pressure		mm (in)/ kg/cm ² (PSI)	700 (28)/ 0.42 (6.0)	600 (24)/ 0.51 (7.25)	700 (28)/ 0.42 (5.97)	800 (31.5)/ 0.39 (5.55)
CAPACITY (Refilled):						
Fuel tank		ltr. (U.S.Gal)	400 (105.7)	320 (84.5)	320 (84.5)	320 (84.5)
Hydraulic oil tank			143 (37.8)	126 (33.3)	126 (33.3)	126 (33.3)
MACHINE SPEC:						
Boom		mm (ft.in)	5850 (19.2)	5700 (18'8")	5700 (18'8")	5700 (18' 8")
Arm		mm (ft.in)	3045 (10'0")	2925 (9'7")	2925 (9'7")	2925 (9' 7")
Bucket (SAE)		m ³ (cu.yd)	1.0 (1.31)	0.80 (1.05)	0.80 (1.05)	0.80 (1.05)

Item		Model	•PC228USLC-8	•PC230NHD-8	◦PC240LC-10	◦PC240LC-10	
Source			Japan (for EU)	UK	USA	UK	
OPERATING WEIGHT*		kg (lb)	22730 (50,110)	22820 (50,310)	25006 (55,129)	25500 (56,220)	
HORSEPOWER		SAE J1995 Gross ISO9249 /SAE J1349 Net Hyd. fan at max. speed Net	kW (HP)/RPM kW (HP)/RPM kW (HP)/RPM	116 (155)/2000 110 (148)/2000	116 (155)/2000 110 (148)/2000	141 (189)/2000 132 (177)/2000	141 (189)/2000 132 (177)/2000
BUCKET CAPACITY RANGE (SAE)		m ³ (cu.yd)	0.48 ~ 1.68 (0.63) (2.20)	0.43 ~ 1.58 (0.56) (2.07)	0.58 ~ 1.41 (0.76) (1.85)	0.47 ~ 1.89 (0.61) (2.47)	
PERFORMANCE:							
Swing speed		RPM	11.0	12.4	11.7	11.7	
Max travel speed		Hi Mi Lo	5.5 (3.4) 4.1 (2.5) 3.0 (1.9)	5.4 (3.4) 3.6 (2.2) 2.6 (1.6)	5.5 (3.4) 4.1 (2.5) 3.0 (1.9)	5.5 (3.4) 4.1 (2.5) 3.0 (1.9)	
DIMENSIONS: See the page of dimensions.							
ENGINE:							
Model			KOMATSU SAA6D107E-1	KOMATSU SAA6D107E-1	KOMATSU SAA6D107E-2	KOMATSU SAA6D107E-2	
No. of cylinders- bore × stroke		mm (in)	6-107 × 124 (4.21 × 4.88)	6-107 × 124 (4.21 × 4.88)	6-107 × 124 (4.21 × 4.88)	6-107 × 124 (4.21 × 4.88)	
Piston displacement		ltr. (cu.in)	6.69 (408)	6.69 (415)	6.69 (408)	6.69 (408)	
HYDRAULIC SYSTEM:							
Hydraulic pump			2 × Variable Piston	2 × Variable Piston	2 × Variable Piston	2 × Variable Piston	
Max. oil flow		ltr. (U.S. Gal)/min.	438 (116)	438 (116)	475 (125.5)	475 (125.5)	
Max. oil pressure (Implement)		kg/cm ² (PSI)	380 (5400)	380 (5400)	380 (5400)	380 (5400)	
Track shoe width/ ground pressure		mm (in)/ kg/cm ² (PSI)	600 (24)/ 0.48 (6.83)	550 (22)/ 0.56 (8.0)	800 (31.5)/ 0.38 (5.40)	700 (28)/ 0.44 (6.26)	
CAPACITY (Refilled):							
Fuel tank		ltr. (U.S.Gal)	320 (84.5)	325 (85.9)	400 (105.7)	400 (105.7)	
Hydraulic oil tank			126 (33.3)	137 (36.2)	132 (34.9)	132 (34.9)	
MACHINE SPEC:							
Boom		mm (ft.in)	5700 (18'8")	5700 (18' 8")	5850 (19'2")	5850 (19'2")	
Arm		mm (ft.in)	2900 (9'7")	2400 (7' 10")	3045 (10'0")	3000 (10'0")	
Bucket (SAE)		m ³ (cu.yd)	0.80 (1.05)	1.16 (1.52)	1.2 (1.57)	1.0 (1.31)	

* Operating weight includes coolant, lubricants, full fuel tank, operator 80kg (180lb) and, indicated implement, shoes and upper attachment.

- EPA Tier 3 and EU Stage 3A model
- EPA Tier 4 Interim and EU Stage 3B model

Specifications

EXCAVATORS (BACKHOE)

Model		°PC240NLC-10	•PC240LC-8	°PC240LC-8	•PC270-8	
Source		UK	China	Brazil	Japan	
OPERATING WEIGHT*		kg (lb)	24600 (54,230)	25130 (55,400)	24850 (54,790)	27140 (59,830)
HORSEPOWER SAE J1995 Gross ISO9249 /SAE J1349 Net Hyd. fan at max. speed Net		kW (HP)/RPM kW (HP)/RPM kW (HP)/RPM	141 (189)/2000 132 (177)/2000	134 (179)/2000 125 (168)/2000	134 (180)/2000 125 (168)/2000	149 (200)/2050 140 (187)/2050
BUCKET CAPACITY RANGE (SAE)		m ³ (cu.yd)	0.47 ~ 1.89 (0.61) (2.49)	1.0 ~ 1.2 (1.31) (1.57)	0.72 ~ 1.73 (0.94) (2.26)	1.14 ~ 1.26 (1.49) (1.65)
PERFORMANCE: Swing speed Max travel speed		RPM km/h (MPH)	11.7 5.5 (3.4) 4.1 (2.5) 3.0 (1.9)	11.7 5.5 (3.4) 4.2 (2.6) 3.1 (1.9)	11.7 5.5 (3.4) 4.2 (2.6) 3.1 (1.9)	10.5 5.5 (3.4) 4.1 (2.5) 3.0 (1.9)
DIMENSIONS: See the page of dimensions.						
ENGINE: Model No. of cylinders- bore × stroke Piston displacement		mm (in) ltr. (cu.in)	KOMATSU SAA6D107E-2 6-107 × 124 (4.21 × 4.88) 6.69 (408)	KOMATSU SAA6D107E-1 6-107 × 124 (4.21 × 4.88) 6.69 (408)	KOMATSU SAA6D107E-1 6-107 × 124 (4.21 × 4.88) 6.69 (408)	KOMATSU SAA6D107E-1 6-107 × 124 (4.21 × 4.88) 6.69 (408)
HYDRAULIC SYSTEM: Hydraulic pump Max. oil flow Max. oil pressure (Implement)		ltr. (U.S. Gal)/min. kg/cm ² (PSI)	2 × Variable Piston 475 (125.5) 380 (5400)	2 × Variable Piston 439 (116) 380 (5400)	2 × Variable Piston 439 (116) 380 (5400)	2 × Variable Piston 450 (119) 380 (5400)
Track shoe width/ ground pressure		mm (in)/ kg/cm ² (PSI)	600 (24)/ 0.52 (7.39)	600 (24)/ 0.51 (7.25)	600 (24)/ 0.50 (7.11)	600 (24)/ 0.56 (7.96)
CAPACITY (Refilled): Fuel tank Hydraulic oil tank		ltr. (U.S.Gal)	400 (105.7) 132 (34.9)	400 (105.7) 135 (35.7)	400 (105.7) 135 (35.7)	400 (105.7) 132 (34.9)
MACHINE SPEC: Boom Arm Bucket (SAE)		mm (ft.in) mm (ft.in) m ³ (cu.yd)	5850 (19'2") 3000 (10'0") 1.0 (1.31)	5850 (19'2") 3045 (10'0") 1.0 (1.31)	5850 (19'2") 2500 (8'2") 1.73 (2.26)	5850 (19'2") 3045 (10'0") 1.26 (1.65)

Model		PC270-7	•PC270LC-8	°PC290LC-10	°PC290LC-10	
Source		China	Japan	USA	UK	
OPERATING WEIGHT*		kg (lb)	27350 (60,300)	28640 (63,140)	30950 (68,234)	30300 (66,800)
HORSEPOWER SAE J1995 Gross ISO9249 /SAE J1349 Net Hyd. fan at max. speed Net		kW (HP)/RPM kW (HP)/RPM kW (HP)/RPM	134 (179)/2050	149 (200)/2050 140 (187)/2050	159 (213)/2050 147 (196)/2050	159 (213)/2050 147 (196)/2050
BUCKET CAPACITY RANGE (SAE)		m ³ (cu.yd)	1.3 (1.7)	1.14 ~ 1.26 (1.49) (1.65)	0.58 ~ 1.63 (0.76) (2.13)	0.85 ~ 2.02 (1.11) (2.64)
PERFORMANCE: Swing speed Max travel speed		RPM km/h (MPH)	10.5 5.5 (3.4) 4.1 (2.6) 3.0 (1.9)	10.5 5.5 (3.4) 4.1 (2.5) 3.0 (1.9)	10.5 5.5 (3.4) 4.1 (2.5) 3.0 (1.9)	10.5 5.5 (3.4) 4.1 (2.5) 3.0 (1.9)
DIMENSIONS: See the page of dimensions.						
ENGINE: Model No. of cylinders- bore × stroke Piston displacement		mm (in) ltr. (cu.in)	KOMATSU SAA6D102E-2 6-102 × 120 (4.02 × 4.72) 5.88 (359)	KOMATSU SAA6D107E-1 6-107 × 124 (4.21 × 4.88) 6.69 (408)	KOMATSU SAA6D107E-2 6-107 × 124 (4.21 × 4.88) 6.69 (408)	KOMATSU SAA6D107E-2 6-107 × 124 (4.21 × 4.88) 6.69 (408)
HYDRAULIC SYSTEM: Hydraulic pump Max. oil flow Max. oil pressure (Implement)		ltr. (U.S. Gal)/min. kg/cm ² (PSI)	2 × Variable Piston 450 (119) 380 (5400)	2 × Variable Piston 450 (119) 380 (5400)	2 × Variable Piston 479 (126.5) 380 (5400)	2 × Variable Piston 479 (126.5) 380 (5400)
Track shoe width/ ground pressure		mm (in)/ kg/cm ² (PSI)	600 (24)/ 0.56 (8.0)	700 (28)/ 0.47 (6.68)	800 (31.5)/ 0.45 (6.40)	700 (28)/ 0.46 (6.54)
CAPACITY (Refilled): Fuel tank Hydraulic oil tank		ltr. (U.S.Gal)	400 (106) 143 (37.8)	400 (105.7) 132 (34.9)	400 (105.7) 132 (34.9)	400 (105.7) 132 (34.9)
MACHINE SPEC: Boom Arm Bucket (SAE)		mm (ft.in) mm (ft.in) m ³ (cu.yd)	5850 (19'2") 3045 (10'0") 1.3 (1.7)	5850 (19'2") 3045 (10'0") 1.26 (1.65)	6150 (20'2") 3200 (10'6") 1.41 (1.85)	6150 (20'2") 3200 (10'6") 1.20 (1.57)

* Operating weight includes coolant, lubricants, full fuel tank, operator 80kg (180lb) and, indicated implement, shoes and upper attachment.

- EPA Tier 3 and EU Stage 3A model
- EPA Tier 4 Interim and EU Stage 3B model

Specifications

EXCAVATORS (BACKHOE)

Model		°PC290NLC-10	°PC300-8	°PC300-8	°PC300-8 (SE spec.)
Source		UK	Japan, Russia	Indonesia	Indonesia
OPERATING WEIGHT*		29800 (65,700)	31100 (68,560)	31810 (70,130)	33790 (74,490)
HORSEPOWER SAE J1995 Gross ISO9249 /SAE J1349 Net Hyd. fan at max. speed Net		kW (HP)/RPM 159 (213)/2050 kW (HP)/RPM 147 (196)/2050	194 (260)/1950 184 (246)/1950	194 (260)/1950 184 (246)/1950	194 (260)/1950 184 (246)/1950
BUCKET CAPACITY RANGE (SAE)		m ³ (cu.yd) 0.85 ~ 2.02 (1.11) (2.64)	0.52 ~ 1.80 (0.68) (2.35)	0.52 ~ 2.30 (0.68) (3.01)	0.52 ~ 2.30 (0.68) (3.01)
PERFORMANCE: Swing speed Max travel speed		RPM 10.5 5.5 (3.4) 4.1 (2.5) 3.0 (1.9)	9.5 5.5 (3.4) 4.5 (2.8) 3.2 (2.0)	9.5 5.5 (3.4) 4.5 (2.8) 3.2 (2.0)	9.5 5.5 (3.4) 4.5 (2.8) 3.2 (2.0)
DIMENSIONS: See the page of dimensions.					
ENGINE: Model No. of cylinders- bore × stroke Piston displacement		mm (in) ltr. (cu.in) KOMATSU SAA6D107E-2 6-107 × 124 (4.21 × 4.88) 6.69 (408)	mm (in) KOMATSU SAA6D114E-3 6-114 × 135 (4.49 × 5.31) 8.27 (505)	mm (in) KOMATSU SAA6D114E-3 6-114 × 135 (4.49 × 5.31) 8.27 (505)	mm (in) KOMATSU SAA6D114E-3 6-114 × 135 (4.49 × 5.31) 8.27 (505)
HYDRAULIC SYSTEM: Hydraulic pump Max. oil flow Max. oil pressure (Implement)		ltr. (U.S. Gal)/min. kg/cm ² (PSI) 479 (126.5) 380 (5400)	2 × Variable Piston 535 (141) 380 (5400)	2 × Variable Piston 535 (141) 380 (5400)	2 × Variable Piston 535 (141) 380 (5400)
Track shoe width/ ground pressure		mm (in)/ kg/cm ² (PSI) 600 (24)/ 0.53 (7.54)	600 (24)/ 0.64 (9.1)	800 (31.5)/ 0.49 (6.97)	800 (31.5)/ 0.52 (7.39)
CAPACITY (Refilled): Fuel tank Hydraulic oil tank		ltr. (U.S.Gal) 400 (105.7) 132 (34.9)	605 (160) 188 (49.7)	605 (160) 188 (49.7)	605 (160) 188 (49.7)
MACHINE SPEC: Boom Arm Bucket (SAE)		mm (ft.in) mm (ft.in) m ³ (cu.yd) 6150 (20'2") 3200 (10'6") 1.20 (1.57)	6470 (21' 3") 3185 (10' 5") 1.4 (1.83)	6470 (21'3") 3185 (10'5") 1.4 (1.83)	6470 (21'3") 3185 (10'5") 1.4 (1.83)

Model		°PC300-8	PC300-7	PC300-7	°PC300LC-8
Source		Thailand	Japan	China	Japan, Russia
OPERATING WEIGHT*		31100 (68,560)	30800 (67,900)	31200 (68,780)	32200 (70,990)
HORSEPOWER SAE J1995 Gross ISO9249 /SAE J1349 Net Hyd. fan at max. speed Net		kW (HP)/RPM 194 (260)/1950 184 (246)/1950	180 (242)/1900	180 (242)/1900	194 (260)/1950 184 (246)/1950
BUCKET CAPACITY RANGE (SAE)		m ³ (cu.yd) 0.52 ~ 2.30 (0.68) (3.01)	0.52 ~ 1.80 (0.68) (1.83)	1.40 ~ 1.60 (1.83) (2.09)	0.52 ~ 1.80 (0.68) (2.35)
PERFORMANCE: Swing speed Max travel speed		RPM 9.5 5.5 (3.4) 4.5 (2.8) 3.2 (2.0)	9.5 5.5 (3.4) 3.2 (2.0)	9.5 5.5 (3.4) 4.5 (2.8) 3.2 (2.0)	9.5 5.5 (3.4) 4.5 (2.8) 3.2 (2.0)
DIMENSIONS: See the page of dimensions.					
ENGINE: Model No. of cylinders- bore × stroke Piston displacement		mm (in) ltr. (cu.in) KOMATSU SAA6D114E-3 6-114 × 135 (4.49 × 5.31) 8.27 (505)	mm (in) KOMATSU SAA6D114E-2 6-114 × 135 (4.49 × 5.31) 8.27 (505)	mm (in) KOMATSU SAA6D114E-2 6-114 × 135 (4.49 × 5.31) 8.27 (505)	mm (in) KOMATSU SAA6D114E-3 6-114 × 135 (4.49 × 5.31) 8.27 (505)
HYDRAULIC SYSTEM: Hydraulic pump Max. oil flow Max. oil pressure (Implement)		ltr. (U.S. Gal)/min. kg/cm ² (PSI) 535 (141) 380 (5400)	2 × Variable Piston 535 (141) 380 (5400)	2 × Variable Piston 535 (141) 380 (5400)	2 × Variable Piston 535 (141) 380 (5400)
Track shoe width/ ground pressure		mm (in)/ kg/cm ² (PSI) 600 (24)/ 0.64 (9.12)	600 (24)/ 0.64 (9.1)	600 (24)/ 0.65 (9.2)	700 (28)/ 0.53 (7.48)
CAPACITY (Refilled): Fuel tank Hydraulic oil tank		ltr. (U.S.Gal) 605 (160) 188 (49.7)	605 (160) 188 (49.7)	605 (160) 188 (49.7)	605 (160) 188 (49.7)
MACHINE SPEC: Boom Arm Bucket (SAE)		mm (ft.in) mm (ft.in) m ³ (cu.yd) 6470 (21'3") 3185 (10'5") 1.4 (1.83)	6470 (21'3") 3185 (10'5") 1.40 (1.83)	6470 (21'3") 3185 (10'5") 1.40 (1.83)	6470 (21'3") 3185 (10'5") 1.4 (1.83)

* Operating weight includes coolant, lubricants, full fuel tank, operator 80kg (180lb) and, indicated implement, shoes and upper attachment.

- EPA Tier 3 and EU Stage 3A model
- EPA Tier 4 Interim and EU Stage 3B model

Specifications

EXCAVATORS (BACKHOE)

Item		Model	•PC300LC-8	•PC300LC-8 (SE spec.)	•PC300LC-8	PC300LC-7
Source			Indonesia	Indonesia	Thailand	India
OPERATING WEIGHT*		kg (lb)	32580 (71,830)	34400 (75,840)	32200 (70,990)	33300 (73,410)
HORSEPOWER		SAE J1995 Gross ISO9249 /SAE J1349 Net Hyd. fan at max. speed Net	kW (HP)/RPM 194 (260)/1950 184 (246)/1950	kW (HP)/RPM 194 (260)/1950 184 (246)/1950	kW (HP)/RPM 194 (260)/1950 184 (246)/1950	kW (HP)/RPM 180 (242)/1900
BUCKET CAPACITY RANGE (SAE)		m ³ (cu.yd)	0.52 ~ 2.30 (0.68) (3.01)	0.52 ~ 2.30 (0.68) (3.01)	0.52 ~ 2.30 (0.68) (3.01)	1.4 ~ 2.1 (1.83) (2.75)
PERFORMANCE:						
Swing speed		RPM	9.5	9.5	9.5	9.5
Max travel speed		Hi Mi Lo	5.5 (3.4) 4.5 (2.8) 3.2 (2.0)	5.5 (3.4) 4.5 (2.8) 3.2 (2.0)	5.5 (3.4) 4.5 (2.8) 3.2 (2.0)	5.5 (3.4) 3.2 (2.0)
DIMENSIONS: See the page of dimensions.						
ENGINE:						
Model			KOMATSU SAA6D114E-3	KOMATSU SAA6D114E-3	KOMATSU SAA6D114E-3	KOMATSU SAA6D114E-2
No. of cylinders- bore × stroke		mm (in)	6-114 × 135 (4.49 × 5.31)	6-114 × 135 (4.49 × 5.31)	6-114 × 135 (4.49 × 5.31)	6-114 × 135 (4.49 × 5.31)
Piston displacement		ltr. (cu.in)	8.27 (505)	8.27 (505)	8.27 (505)	8.27 (505)
HYDRAULIC SYSTEM:						
Hydraulic pump			2 × Variable Piston	2 × Variable Piston	2 × Variable Piston	2 × Variable Piston
Max. oil flow		ltr. (U.S. Gal)/min.	535 (141)	535 (141)	535 (141)	535 (141)
Max. oil pressure (Implement)		kg/cm ² (PSI)	380 (5400)	380 (5400)	380 (5400)	380 (5400)
Track shoe width/ ground pressure		mm (in)/ kg/cm ² (PSI)	800 (31.5)/ 0.47 (6.68)	800 (31.5)/ 0.50 (7.11)	700 (28)/ 0.53 (7.48)	600 (24)/ 0.67 (9.53)
CAPACITY (Refilled):						
Fuel tank		ltr. (U.S.Gal)	605 (160)	605 (160)	605 (160)	605 (160)
Hydraulic oil tank			188 (49.7)	188 (49.7)	188 (49.7)	188 (49.7)
MACHINE SPEC:						
Boom		mm (ft.in)	6470 (21'3")	6470 (21'3")	6470 (21'3")	6470 (21'3")
Arm		mm (ft.in)	3185 (10'5")	3185 (10'5")	3185 (10'5")	3185 (10'5")
Bucket (SAE)		m ³ (cu.yd)	1.4 (1.83)	1.4 (1.83)	1.4 (1.83)	1.4 (1.83)

Item		Model	•PC350-8	PC350-7	•PC350LC-8	PC350LC-7
Source			Japan	Japan	Japan	Japan
OPERATING WEIGHT*		kg (lb)	32600 (71,870)	32300 (71,210)	33660 (74,210)	33400 (73,630)
HORSEPOWER		SAE J1995 Gross ISO9249 /SAE J1349 Net Hyd. fan at max. speed Net	kW (HP)/RPM 194 (260)/1950 184 (246)/1950	kW (HP)/RPM 180 (242)/1900	kW (HP)/RPM 194 (260)/1950 184 (246)/1950	kW (HP)/RPM 180 (242)/1900
BUCKET CAPACITY RANGE (SAE)		m ³ (cu.yd)	1.40 (1.83)	1.40 (1.83)	1.40 (1.83)	1.40 (1.83)
PERFORMANCE:						
Swing speed		RPM	9.5	9.5	9.5	9.5
Max travel speed		Hi Mi Lo	5.5 (3.4) 4.5 (2.8) 3.2 (2.0)	5.5 (3.4) 4.5 (2.8) 3.2 (2.0)	5.5 (3.4) 4.5 (2.8) 3.2 (2.0)	5.5 (3.4) 4.5 (2.8) 3.2 (2.0)
DIMENSIONS: See the page of dimensions.						
ENGINE:						
Model			KOMATSU SAA6D114E-3	KOMATSU SAA6D114E-2	KOMATSU SAA6D114E-3	KOMATSU SAA6D114E-2
No. of cylinders- bore × stroke		mm (in)	6-114 × 135 (4.49 × 5.31)	6-114 × 135 (4.49 × 5.31)	6-114 × 135 (4.49 × 5.31)	6-114 × 135 (4.49 × 5.31)
Piston displacement		ltr. (cu.in)	8.27 (505)	8.27 (505)	8.27 (505)	8.27 (505)
HYDRAULIC SYSTEM:						
Hydraulic pump			2 × Variable Piston	2 × Variable Piston	2 × Variable Piston	2 × Variable Piston
Max. oil flow		ltr. (U.S. Gal)/min.	535 (141)	535 (141)	535 (141)	535 (141)
Max. oil pressure (Implement)		kg/cm ² (PSI)	380 (5400)	380 (5400)	380 (5400)	380 (5400)
Track shoe width/ ground pressure		mm (in)/ kg/cm ² (PSI)	600 (24)/ 0.67 (9.52)	600 (24)/ 0.67 (9.5)	600 (24)/ 0.64 (9.12)	600 (24)/ 0.67 (9.52)
CAPACITY (Refilled):						
Fuel tank		ltr. (U.S.Gal)	605 (160)	605 (160)	605 (160)	605 (160)
Hydraulic oil tank			188 (49.7)	188 (49.7)	188 (49.7)	188 (49.7)
MACHINE SPEC:						
Boom		mm (ft.in)	6470 (21'3")	6470 (21'3")	6470 (21'3")	6470 (21'3")
Arm		mm (ft.in)	3185 (10'5")	3185 (10'3")	3185 (10'5")	3185 (10'3")
Bucket (SAE)		m ³ (cu.yd)	1.4 (1.83)	1.40 (1.83)	1.4 (1.83)	1.40 (1.83)

* Operating weight includes coolant, lubricants, full fuel tank, operator 80kg (180lb) and, indicated implement, shoes and upper attachment.

- EPA Tier 3 and EU Stage 3A model

Specifications

EXCAVATORS (BACKHOE)

Item		Model	•PC350LC-8	°PC360LC-10	°PC360LC-10	°PC360NLC-10	
Source			Brazil	USA	UK	UK	
OPERATING WEIGHT*		kg (lb)	35000 (77,160)	35876 (79,090)	35980 (79,320)	35490 (78,240)	
HORSEPOWER		SAE J1995 Gross ISO9249 /SAE J1349 Net Hyd. fan at max. speed Net	kW (HP)/RPM kW (HP)/RPM kW (HP)/RPM	194 (260)/1950 184 (246)/1950	202 (271)/1950 192 (257)/1950	202 (271)/1950 192 (257)/1950	202 (271)/1950 192 (257)/1950
BUCKET CAPACITY RANGE (SAE)		m ³ (cu.yd)	0.68 ~ 2.50 (0.89) (3.27)	0.68 ~ 1.96 (0.89) (2.56)	0.85 ~ 2.32 (1.11) (3.03)	0.85 ~ 2.32 (1.11) (3.03)	
PERFORMANCE:							
Swing speed		RPM	9.5	9.5	9.5	9.5	
Max travel speed		Hi Mi Lo	5.5 (3.4) 4.5 (2.8) 3.2 (2.0)	5.5 (3.4) 4.5 (2.8) 3.2 (2.0)	5.5 (3.4) 4.5 (2.8) 3.2 (2.0)	5.5 (3.4) 4.5 (2.8) 3.2 (2.0)	
DIMENSIONS: See the page of dimensions.							
ENGINE:							
Model			KOMATSU SAA6D114E-3	KOMATSU SAA6D114E-5	KOMATSU SAA6D114E-5	KOMATSU SAA6D114E-5	
No. of cylinders- bore × stroke		mm (in)	6-114 × 135 (4.49 × 5.31)	6-114 × 144.5 (4.49 × 5.69)	6-114 × 144.5 (4.49 × 5.69)	6-114 × 144.5 (4.49 × 5.69)	
Piston displacement		ltr. (cu.in)	8.27 (505)	8.85 (540)	8.85 (540)	8.85 (540)	
HYDRAULIC SYSTEM:							
Hydraulic pump			2 × Variable Piston	2 × Variable Piston	2 × Variable Piston	2 × Variable Piston	
Max. oil flow		ltr. (U.S. Gal)/min.	535 (141)	535 (141)	535 (141)	535 (141)	
Max. oil pressure (Implement)		kg/cm ² (PSI)	380 (5400)	380 (5400)	380 (5400)	380 (5400)	
Track shoe width/ ground pressure		mm (in)/ kg/cm ² (PSI)	600 (24)/ 0.67 (9.53)	800 (31.5)/ 0.52 (7.39)	700 (28)/ 0.59 (8.39)	600 (24)/ 0.68 (9.67)	
CAPACITY (Refilled):							
Fuel tank		ltr. (U.S.Gal)	605 (160)	605 (160)	605 (160)	605 (160)	
Hydraulic oil tank			188 (49.7)	188 (49.7)	188 (49.7)	188 (49.7)	
MACHINE SPEC:							
Boom		mm (ft.in)	6500 (21'4")	6500 (21'4")	6500 (21'4")	6500 (21'4")	
Arm		mm (ft.in)	2550 (8'4")	3185 (10'5")	3185 (10'5")	3185 (10'5")	
Bucket (SAE)		m ³ (cu.yd)	2.23 (2.92)	1.96 (2.56)	2.66 (3.48)	2.66 (3.48)	

Item		Model	PC360-7	°PC390LC-10	•PC400-8	•PC400-8
Source			China	USA	Japan	China
OPERATING WEIGHT*		kg (lb)	33000 (72,750)	39965 (88,110)	41740 (92,020)	42100 (92,810)
HORSEPOWER		SAE J1995 Gross ISO9249 /SAE J1349 Net Hyd. fan at max. speed Net	kW (HP)/RPM kW (HP)/RPM kW (HP)/RPM	202 (271)/1950 192 (257)/1950	270 (362)/1900 257 (345)/1900	257 (345)/1900
BUCKET CAPACITY RANGE (SAE)		m ³ (cu.yd)	1.60 (2.09)	0.68 ~ 2.22 (0.89) (2.91)	1.3 ~ 2.2 (1.70) (2.88)	1.9 (2.49)
PERFORMANCE:						
Swing speed		RPM	9.5	9.5	9.1	9.1
Max travel speed		Hi Mi Lo	5.5 (3.4) 4.5 (2.8) 3.2 (2.0)	5.5 (3.4) 4.4 (2.7) 3.0 (1.9)	5.5 (3.4) 4.0 (2.5) 3.0 (1.9)	5.5 (3.4) 4.0 (2.5) 3.0 (1.9)
DIMENSIONS: See the page of dimensions.						
ENGINE:						
Model			KOMATSU SAA6D114E-2	KOMATSU SAA6D114E-5	KOMATSU SAA6D125E-5	KOMATSU SAA6D125E-5
No. of cylinders- bore × stroke		mm (in)	6-114 × 135 (4.49 × 5.31)	6-114 × 144.5 (4.49 × 5.69)	6-125 × 150 (4.92 × 5.91)	6-125 × 150 (4.92 × 5.91)
Piston displacement		ltr. (cu.in)	8.27 (505)	8.85 (540)	11.04 (674)	11.04 (674)
HYDRAULIC SYSTEM:						
Hydraulic pump			2 × Variable Piston	2 × Variable Piston	2 × Variable Piston	2 × Variable Piston
Max. oil flow		ltr. (U.S. Gal)/min.	535 (141)	535 (141)	690 (182)	690 (182)
Max. oil pressure (Implement)		kg/cm ² (PSI)	380 (5400)	380 (5400)	380 (5400)	380 (5400)
Track shoe width/ ground pressure		mm (in)/ kg/cm ² (PSI)	600 (24)/ 0.69 (9.8)	800 (31.5)/ 0.52 (7.39)	600 (24)/ 0.79 (11.2)	600 (24)/ 0.80 (11.4)
CAPACITY (Refilled):						
Fuel tank		ltr. (U.S.Gal)	605 (160)	605 (160)	650 (172)	650 (172)
Hydraulic oil tank			188 (49.7)	188 (49.7)	248 (65.5)	248 (65.5)
MACHINE SPEC:						
Boom		mm (ft.in)	6470 (21'3")	6500 (21'4")	7060 (23'2")	7060 (23'2")
Arm		mm (ft.in)	3185 (10'3")	3185 (10'5")	3380 (11'1")	3380 (11'1")
Bucket (SAE)		m ³ (cu.yd)	1.60 (2.09)	1.96 (2.56)	1.9 (2.49)	1.9 (2.49)

* Operating weight includes coolant, lubricants, full fuel tank, operator 80kg (180lb) and, indicated implement, shoes and upper attachment.

- EPA Tier 3 and EU Stage 3A model
- ° EPA Tier 4 Interim and EU Stage 3B model

Specifications

EXCAVATORS (BACKHOE)

Item		Model	PC400-8R	PC400-8R (SE spec.)	PC400-7	*PC400LC-8	
Source			Japan	Indonesia	Japan, Russia	Japan	
OPERATING WEIGHT*		kg (lb)	41740 (92,020)	43480 (95,860)	41400 (91,270)	42740 (94,220)	
HORSEPOWER		SAE J1995 Gross ISO9249 /SAE J1349 Net Hyd. fan at max. speed Net	kW (HP)/RPM kW (HP)/RPM kW (HP)/RPM	270 (362)/1900 257 (345)/1900 257 (345)/1900	270 (362)/1900 257 (345)/1900 257 (345)/1900	246 (330)/1850	270 (362)/1900 257 (345)/1900 257 (345)/1900
BUCKET CAPACITY RANGE (SAE)		m ³ (cu.yd)	1.3 ~ 2.2 (1.70) (2.88)	1.3 ~ 3.0 (1.70) (3.90)	1.3 ~ 2.2 (1.7) (2.9)	1.3 ~ 2.2 (1.70) (2.88)	
PERFORMANCE:							
Swing speed		RPM	9.1	9.1	9.0	9.1	
Max travel speed		Hi Mi Lo km/h (MPH)	5.5 (3.4) 4.0 (2.5) 3.0 (1.9)	5.5 (3.4) 4.0 (2.5) 3.0 (1.9)	5.5 (3.4) 3.0 (1.9)	5.5 (3.4) 4.0 (2.5) 3.0 (1.9)	
DIMENSIONS: See the page of dimensions.							
ENGINE:							
Model			KOMATSU SAA6D125E-5	KOMATSU SAA6D125E-5	KOMATSU SAA6D125E-3	KOMATSU SAA6D125E-5	
No. of cylinders- bore × stroke		mm (in)	6-125 × 150 (4.92 × 5.91)	6-125 × 150 (4.92 × 5.91)	6-125 × 150 (4.92 × 5.90)	6-125 × 150 (4.92 × 5.91)	
Piston displacement		ltr. (cu.in)	11.04 (674)	11.04 (674)	11.04 (674)	11.04 (674)	
HYDRAULIC SYSTEM:							
Hydraulic pump			2 × Variable Piston	2 × Variable Piston	2 × Variable Piston	2 × Variable Piston	
Max. oil flow		ltr. (U.S. Gal)/min.	690 (182)	690 (182)	690 (182)	690 (182)	
Max. oil pressure (Implement)		kg/cm ² (PSI)	380 (5400)	380 (5400)	380 (5400)	380 (5400)	
Track shoe width/ ground pressure		mm (in)/ kg/cm ² (PSI)	600 (24)/ 0.79 (11.2)	800 (31.5)/ 0.62 (8.81)	600 (24)/ 0.79 (11.2)	700 (28)/ 0.65 (9.24)	
CAPACITY (Refilled):							
Fuel tank		ltr. (U.S.Gal)	650 (172)	650 (172)	650 (172)	650 (172)	
Hydraulic oil tank			248 (65.5)	248 (65.5)	248 (65.5)	248 (65.5)	
MACHINE SPEC:							
Boom		mm (ft.in)	7060 (23'2")	7060 (23'2")	7060 (23'2")	7060 (23'2")	
Arm		mm (ft.in)	3380 (11'1")	2400 (7'10")	3380 (11'1")	3380 (11'1")	
Bucket (SAE)		m ³ (cu.yd)	1.9 (2.49)	3.0 (3.90)	1.90 (2.49)	1.9 (2.49)	

Item		Model	PC400LC-8R	PC400LC-8R (SE spec.)	PC400LC-7	*PC450-8	
Source			Japan	Indonesia	Japan, Russia	Japan	
OPERATING WEIGHT*		kg (lb)	42740 (94,220)	44090 (97,200)	42850 (94,470)	43320 (95,500)	
HORSEPOWER		SAE J1995 Gross ISO9249 /SAE J1349 Net Hyd. fan at max. speed Net	kW (HP)/RPM kW (HP)/RPM kW (HP)/RPM	270 (362)/1900 257 (345)/1900 257 (345)/1900	270 (362)/1900 257 (345)/1900 257 (345)/1900	246 (330)/1850	270 (362)/1900 257 (345)/1900 257 (345)/1900
BUCKET CAPACITY RANGE (SAE)		m ³ (cu.yd)	1.3 ~ 2.2 (1.70) (2.88)	1.3 ~ 3.0 (1.70) (3.90)	1.3 ~ 2.2 (1.7) (2.9)	1.90 ~ 2.10 (2.49) (2.75)	
PERFORMANCE:							
Swing speed		RPM	9.1	9.1	9.0	9.1	
Max travel speed		Hi Mi Lo km/h (MPH)	5.5 (3.4) 4.0 (2.5) 3.0 (1.9)	5.5 (3.4) 4.0 (2.5) 3.0 (1.9)	5.5 (3.4) 3.0 (1.9)	5.5 (3.4) 4.0 (2.5) 3.0 (1.9)	
DIMENSIONS: See the page of dimensions.							
ENGINE:							
Model			KOMATSU SAA6D125E-5	KOMATSU SAA6D125E-5	KOMATSU SAA6D125E-3	KOMATSU SAA6D125E-5	
No. of cylinders- bore × stroke		mm (in)	6-125 × 150 (4.92 × 5.91)	6-125 × 150 (4.92 × 5.91)	6-125 × 150 (4.92 × 5.90)	6-125 × 150 (4.92 × 5.91)	
Piston displacement		ltr. (cu.in)	11.04 (674)	11.04 (674)	11.04 (674)	11.04 (674)	
HYDRAULIC SYSTEM:							
Hydraulic pump			2 × Variable Piston	2 × Variable Piston	2 × Variable Piston	1 × Variable Piston	
Max. oil flow		ltr. (U.S. Gal)/min.	690 (182)	690 (182)	690 (182)	690 (182)	
Max. oil pressure (Implement)		kg/cm ² (PSI)	380 (5400)	380 (5400)	380 (5400)	380 (5400)	
Track shoe width/ ground pressure		mm (in)/ kg/cm ² (PSI)	700 (28)/ 0.65 (9.24)	800 (31.5)/ 0.58 (8.3)	700 (28)/ 0.66 (9.4)	600 (24)/ 0.82 (11.7)	
CAPACITY (Refilled):							
Fuel tank		ltr. (U.S.Gal)	650 (172)	650 (172)	650 (172)	650 (172)	
Hydraulic oil tank			248 (65.5)	248 (65.5)	248 (65.5)	248 (65.5)	
MACHINE SPEC:							
Boom		mm (ft.in)	7060 (23'2")	7060 (23'2")	7060 (23'2")	7060 (23'2")	
Arm		mm (ft.in)	3380 (11'1")	2400 (7'10")	3380 (11'1")	3380 (11'1")	
Bucket (SAE)		m ³ (cu.yd)	1.9 (2.49)	3.0 (3.90)	1.90 (2.49)	1.9 (2.49)	

* Operating weight includes coolant, lubricants, full fuel tank, operator 80kg (180lb) and, indicated implement, shoes and upper attachment.

- EPA Tier 3 and EU Stage 3A model

Specifications

EXCAVATORS (BACKHOE)

Item		Model	PC450-8R	°PC450-8	PC450-7	°PC450LC-8
Source			Japan	China	Japan	Japan
OPERATING WEIGHT*		kg (lb)	43320 (95,500)	45125 (99,480)	43000 (94,800)	44320 (97,710)
HORSEPOWER SAE J1995 Gross ISO9249 /SAE J1349 Net Hyd. fan at max. speed Net		kW (HP)/RPM kW (HP)/RPM kW (HP)/RPM	270 (362)/1900 257 (345)/1900	257 (345)/1900	246 (330)/1850	270 (362)/1900 257 (345)/1900
BUCKET CAPACITY RANGE (SAE)		m ³ (cu.yd)	1.90 ~ 2.10 (2.49) (2.75)	2.1 (2.75)	1.90 ~ 2.10 (2.49) (2.75)	1.90 ~ 2.10 (2.49) (2.75)
PERFORMANCE: Swing speed Max travel speed		RPM km/h (MPH)	9.1 5.5 (3.4) 4.0 (2.5) 3.0 (1.9)	9.1 5.5 (3.4) 4.0 (2.5) 3.0 (1.9)	9.0 5.5 (3.4) 4.4 (2.7) 3.0 (1.9)	9.1 5.5 (3.4) 4.0 (2.5) 3.0 (1.9)
DIMENSIONS: See the page of dimensions.						
ENGINE: Model No. of cylinders- bore × stroke Piston displacement		mm (in) ltr. (cu.in)	KOMATSU SAA6D125E-5 6-125 × 150 (4.92 × 5.91) 11.04 (674)	KOMATSU SAA6D125E-5 6-125 × 150 (4.92 × 5.91) 11.04 (674)	KOMATSU SAA6D125E-3 6-125 × 150 (4.92 × 5.90) 11.04 (673)	KOMATSU SAA6D125E-5 6-125 × 150 (4.92 × 5.91) 11.04 (674)
HYDRAULIC SYSTEM: Hydraulic pump Max. oil flow Max. oil pressure (Implement)		ltr. (U.S. Gal)/min. kg/cm ² (PSI)	1 × Variable Piston 690 (182) 380 (5400)	2 × Variable Piston 690 (182) 380 (5400)	2 × Variable Piston 690 (182) 380 (5400)	2 × Variable Piston 690 (182) 380 (5400)
Track shoe width/ ground pressure		mm (in)/ kg/cm ² (PSI)	600 (24)/ 0.82 (11.7)	600 (24)/ 0.85 (12.1)	600 (24)/ 0.83 (11.8)	600 (24)/ 0.78 (11.1)
CAPACITY (Refilled): Fuel tank Hydraulic oil tank		ltr. (U.S.Gal)	650 (172) 248 (65.5)	650 (172) 248 (65.5)	650 (172) 248 (65.5)	650 (172) 248 (65.5)
MACHINE SPEC: Boom Arm Bucket (SAE)		mm (ft.in) mm (ft.in) m ³ (cu.yd)	7060 (23'2") 3380 (11'1") 1.9 (2.49)	7060 (23'2") 3380 (11'1") 2.1 (2.75)	7060 (23'2") 3380 (11'1") 1.90 (2.49)	7060 (23'2") 3380 (11'1") 1.9 (2.49)

Item		Model	PC450LC-8R	°PC490-10	°PC490LC-10	°PC490LC-10
Source			Japan	UK	USA	UK
OPERATING WEIGHT*		kg (lb)	44320 (97,710)	46630 (102,800)	47490 (104,700)	47410 (104,520)
HORSEPOWER SAE J1995 Gross ISO9249 /SAE J1349 Net Hyd. fan at max. speed Net		kW (HP)/RPM kW (HP)/RPM kW (HP)/RPM	270 (362)/1900 257 (345)/1900	268 (359)/1900	270 (362)/1900 268 (359)/1900	268 (359)/1900
BUCKET CAPACITY RANGE (SAE)		m ³ (cu.yd)	1.90 ~ 2.10 (2.49) (2.75)	1.34 ~ 2.76 (1.75) (3.61)	1.12 ~ 3.17 (1.47) (4.15)	1.34 ~ 2.76 (1.75) (3.61)
PERFORMANCE: Swing speed Max travel speed		RPM km/h (MPH)	9.1 5.5 (3.4) 4.0 (2.5) 3.0 (1.9)	9.4 5.5 (3.4) 4.2 (2.6) 3.0 (1.9)	9.1 5.5 (3.4) 4.2 (2.6) 3.0 (1.9)	9.4 5.5 (3.4) 4.2 (2.6) 3.0 (1.9)
DIMENSIONS: See the page of dimensions.						
ENGINE: Model No. of cylinders- bore × stroke Piston displacement		mm (in) ltr. (cu.in)	KOMATSU SAA6D125E-5 6-125 × 150 (4.92 × 5.91) 11.04 (674)	KOMATSU SAA6D125E-6-A 6-125 × 150 (4.92 × 5.91) 11.04 (674)	KOMATSU SAA6D125E-6-A 6-125 × 150 (4.92 × 5.91) 11.04 (674)	KOMATSU SAA6D125E-6-A 6-125 × 150 (4.92 × 5.91) 11.04 (674)
HYDRAULIC SYSTEM: Hydraulic pump Max. oil flow Max. oil pressure (Implement)		ltr. (U.S. Gal)/min. kg/cm ² (PSI)	2 × Variable Piston 690 (182) 380 (5400)	2 × Variable Piston 690 (182) 380 (5400)	2 × Variable Piston 695 (184) 380 (5400)	2 × Variable Piston 690 (182) 380 (5400)
Track shoe width/ ground pressure		mm (in)/ kg/cm ² (PSI)	600 (24)/ 0.78 (11.1)	600 (24)/ 0.89 (12.7)	700 (28)/ 0.72 (10.2)	700 (28)/ 0.72 (10.2)
CAPACITY (Refilled): Fuel tank Hydraulic oil tank		ltr. (U.S.Gal)	650 (172) 248 (65.5)	650 (172) 248 (65.5)	650 (172) 248 (65.5)	650 (172) 248 (65.5)
MACHINE SPEC: Boom Arm Bucket (SAE)		mm (ft.in) mm (ft.in) m ³ (cu.yd)	7060 (23'2") 3380 (11'1") 1.9 (2.49)	7060 (23'2") 3380 (11'1") 2.2 (2.88)	7060 (23'2") 3380 (11'1") 2.25 (2.94)	7060 (23'2") 3380 (11'1") 2.2 (2.88)

* Operating weight includes coolant, lubricants, full fuel tank, operator 80kg (180lb) and, indicated implement, shoes and upper attachment.

- EPA Tier 3 and EU Stage 3A model
- EPA Tier 4 Interim and EU Stage 3B model

Specifications

EXCAVATORS (BACKHOE)

Item		Model	•PC550LC-8	•PC600-8E0	PC600-8R1	•PC600-8
Source			Japan	Japan	Japan	UK
OPERATING WEIGHT*		kg (lb)	51130 (112,720)	59200 (130,510)	59200 (130,510)	57640 (127,070)
HORSEPOWER		SAE J1995 Gross ISO9249 /SAE J1349 Net Hyd. fan at max. speed Net	kW (HP)/RPM 270 (362)/1900 263 (353)/1900	323 (433)/1800 320 (429)/1800 288 (386)/1800	323 (433)/1800 320 (429)/1800 288 (386)/1800	323 (433)/1800 320 (429)/1800 288 (386)/1800
BUCKET CAPACITY RANGE (SAE)		m ³ (cu.yd)	3.05 (3.99)	2.0 ~ 3.5 (2.62) (4.58)	2.0 ~ 3.5 (2.62) (4.58)	2.4 ~ 3.5 (3.14) (4.58)
PERFORMANCE:						
Swing speed		RPM	9.1	8.3	8.3	8.3
Max travel speed		Hi Mi Lo km/h (MPH)	4.0 (2.5) 3.0 (1.9) 2.6 (1.6)	4.9 (3.0) 3.0 (1.9)	4.9 (3.0) 3.0 (3.9)	4.9 (3.0) 3.0 (1.9)
DIMENSIONS: See the page of dimensions.						
ENGINE:						
Model			KOMATSU SAA6D125E-5-A	KOMATSU SAA6D140E-5	KOMATSU SAA6D140E-5	KOMATSU SAA6D140E-5
No. of cylinders- bore × stroke		mm (in)	6-125 × 150 (4.92 × 5.91)	6-140 × 165 (5.51 × 6.50)	6-140 × 165 (5.51 × 6.50)	6-140 × 165 (5.51 × 6.50)
Piston displacement		ltr. (cu.in)	11.04 (674)	15.24 (930)	15.24 (930)	15.24 (930)
HYDRAULIC SYSTEM:						
Hydraulic pump			2 × Variable Piston	2 × Variable Piston	2 × Variable Piston	2 × Variable Piston
Max. oil flow		ltr. (U.S. Gal)/min.	690 (182)	820 (217)	820 (217)	820 (217)
Max. oil pressure (Implement)		kg/cm ² (PSI)	380 (5400)	325 (4620)	325 (4620)	325 (4620)
Track shoe width/ ground pressure		mm (in)/ kg/cm ² (PSI)	600 (24)/ 0.93 (13.2)	600 (24)/ 1.07 (15.2)	600 (24)/ 1.07 (15.2)	600 (24)/ 1.03 (14.6)
CAPACITY (Refilled):						
Fuel tank		ltr. (U.S.Gal)	650 (172)	880 (232)	880 (232)	880 (232)
Hydraulic oil tank			248 (65.5)	360 (95.0)	360 (95.0)	360 (95)
MACHINE SPEC:						
Boom		mm (ft.in)	6670 (21'11")	7660 (25'2")	7660 (25'2")	6600 (21'8")
Arm		mm (ft.in)	2400 (7'10")	3500 (11'6")	3500 (11'6")	2900 (9'6")
Bucket (SAE)		m ³ (cu.yd)	3.05 (3.99)	2.7 (3.53)	2.7 (3.53)	3.5 (4.58)

Item		Model	PC600-7	•PC600LC-8E0	PC600LC-8R1	•PC600LC-8
Source			Japan (for Russia)	Japan	Japan	UK
OPERATING WEIGHT*		kg (lb)	56600 (124,780)	60200 (132,720)	60200 (132,720)	58640 (129,280)
HORSEPOWER		SAE J1995 Gross ISO9249 /SAE J1349 Net Hyd. fan at max. speed Net	kW (HP)/RPM 287 (385)/180	323 (433)/1800 320 (429)/1800 288 (386)/1800	323 (433)/1800 320 (429)/1800 288 (386)/1800	323 (433)/1800 320 (429)/1800 288 (386)/1800
BUCKET CAPACITY RANGE (SAE)		m ³ (cu.yd)	2.0 ~ 3.5 (2.62) (4.58)	2.0 ~ 3.5 (2.62) (4.58)	2.0 ~ 3.5 (2.62) (4.58)	2.4 ~ 3.5 (3.14) (4.58)
PERFORMANCE:						
Swing speed		RPM	8.3	8.3	8.3	8.3
Max travel speed		Hi Mi Lo km/h (MPH)	4.9 (3.0) 3.0 (1.9)	4.9 (3.0) 3.0 (1.9)	4.9 (3.0) 3.0 (1.9)	4.9 (3.0) 3.0 (1.9)
DIMENSIONS: See the page of dimensions.						
ENGINE:						
Model			KOMATSU SA6D140E-3	KOMATSU SAA6D140E-5	KOMATSU SAA6D140E-5	KOMATSU SAA6D140E-5
No. of cylinders- bore × stroke		mm (in)	6-140 × 165 (5.51 × 6.50)	6-140 × 165 (5.51 × 6.50)	6-140 × 165 (5.51 × 6.50)	6-140 × 165 (5.51 × 6.50)
Piston displacement		ltr. (cu.in)	15.24 (930)	15.24 (930)	15.24 (930)	15.24 (930)
HYDRAULIC SYSTEM:						
Hydraulic pump			2 × Variable Piston	2 × Variable Piston	2 × Variable Piston	2 × Variable Piston
Max. oil flow		ltr. (U.S. Gal)/min.	820 (217)	820 (217)	820 (217)	820 (217)
Max. oil pressure (Implement)		kg/cm ² (PSI)	325 (4620)	325 (4620)	325 (4620)	325 (4620)
Track shoe width/ ground pressure		mm (in)/ kg/cm ² (PSI)	600 (24)/ 1.02 (14.5)	600 (24)/ 1.01 (14.4)	600 (24)/ 1.01 (14.4)	600 (24)/ 0.98 (13.9)
CAPACITY (Refilled):						
Fuel tank		ltr. (U.S.Gal)	880 (232)	880 (232)	880 (232)	880 (232)
Hydraulic oil tank			360 (95)	360 (95.0)	360 (95.0)	360 (95)
MACHINE SPEC:						
Boom		mm (ft.in)	7660 (25'2")	7660 (25'2")	7660 (25' 2")	6600 (21'8")
Arm		mm (ft.in)	3500 (11'6")	3500 (11'6")	3500 (11' 6")	2900 (9'6")
Bucket (SAE)		m ³ (cu.yd)	2.7 (3.53)	2.7 (3.53)	2.7 (3.53)	3.5 (4.58)

* Operating weight includes coolant, lubricants, full fuel tank, operator 80kg (180lb) and, indicated implement, shoes and upper attachment.

- EPA Tier 3 and EU Stage 3A model
- EPA Tier 4 Interim and EU Stage 3B model

Specifications

EXCAVATORS (BACKHOE)

Item		Model	PC600LC-7	*PC650LC-8E0	PC650LC-8R	*PC700LC-8E0
Source			Japan (for Russia)	Japan (for USA)	China	UK
OPERATING WEIGHT*		kg (lb)	57600 (126,990)	65050 (143,410)	59100 (130,290)	65640 (144,710)
HORSEPOWER		SAE J1995 Gross ISO9249 /SAE J1349 Net Hyd. fan at max. speed Net	kW (HP)/RPM kW (HP)/RPM kW (HP)/RPM	323 (433)/1800 320 (429)/1800 288 (386)/1800	323 (433)/1800 320 (429)/1800	323 (433)/1800 320 (429)/1800 288 (386)/1800
BUCKET CAPACITY RANGE (SAE)		m ³ (cu.yd)	2.0 ~ 3.5 (2.62) (4.58)	1.57 ~ 3.81 (2.05) (4.98)	3.1 (4.05)	2.4 ~ 3.5 (3.14) (4.58)
PERFORMANCE:						
Swing speed		RPM	8.3	8.3	8.3	8.3
Max travel speed		Hi Mi Lo km/h (MPH)	4.9 (3.0) 3.0 (1.9)	4.9 (3.0) 3.0 (1.9)	4.9 (3.0) 3.0 (1.9)	4.6 (2.9) 2.8 (1.7)
DIMENSIONS: See the page of dimensions.						
ENGINE:						
Model			KOMATSU SAA6D140E-3	KOMATSU SAA6D140E-5	KOMATSU SAA6D140E-5	KOMATSU SAA6D140E-5
No. of cylinders- bore × stroke		mm (in)	6-140 × 165 (5.51 × 6.50)	6-140 × 165 (5.51 × 6.50)	6-140 × 165 (5.51 × 6.50)	6-140 × 165 (5.51 × 6.50)
Piston displacement		ltr. (cu.in)	15.24 (930)	15.24 (930)	15.24 (930)	15.24 (930)
HYDRAULIC SYSTEM:						
Hydraulic pump			2 × Variable Piston	2 × Variable Piston	2 × Variable Piston	2 × Variable Piston
Max. oil flow		ltr. (U.S. Gal)/min.	820 (217)	820 (217)	820 (217)	820 (217)
Max. oil pressure (Implement)		kg/cm ² (PSI)	325 (4620)	325 (4620)	325 (4620)	325 (4620)
Track shoe width/ ground pressure		mm (in)/ kg/cm ² (PSI)	600 (24)/ 0.97 (13.8)	900 (35.4)/ 0.73 (10.3)	600 (24.5)/ 0.99 (14.1)	610 (24)/ 1.08 (15.4)
CAPACITY (Refilled):						
Fuel tank		ltr. (U.S.Gal)	880 (232)	880 (232)	880 (232)	880 (232)
Hydraulic oil tank			360 (95)	360 (95.0)	360 (95.0)	360 (95.0)
MACHINE SPEC:						
Boom		mm (ft.in)	7660 (25'2")	7660 (25'2")	7300 (23'11")	6600 (21'8")
Arm		mm (ft.in)	3500 (11'6")	3500 (11'6")	3500 (11' 6")	2900 (9' 6")
Bucket (SAE)		m ³ (cu.yd)	2.7 (3.53)	2.7 (3.53)	3.1 (4.05)	2.7 (3.53)

Item		Model	*PC700LC-8E0	PC700LC-8R	*PC700LC-8E0	PC750-7	
Source			Japan	Japan	China	Japan (for Russia)	
OPERATING WEIGHT*		kg (lb)	65700 (144,840)	65700 (144,840)	67300 (148,370)	72370 (159,550)	
HORSEPOWER		SAE J1995 Gross ISO9249 /SAE J1349 Net Hyd. fan at max. speed Net	kW (HP)/RPM kW (HP)/RPM kW (HP)/RPM	323 (433)/1800 320 (429)/1800 288 (386)/1800	323 (433)/1800 320 (429)/1800 288 (386)/1800	323 (433)/1800 320 (429)/1800	338 (454)/1800
BUCKET CAPACITY RANGE (SAE)		m ³ (cu.yd)	2.0 ~ 4.0 (2.62) (5.23)	2.0 ~ 4.0 (2.62) (5.23)	4.0 (5.23)	2.8 ~ 3.4 (3.66) (4.45)	
PERFORMANCE:							
Swing speed		RPM	8.3	8.3	8.3	6.8	
Max travel speed		Hi Mi Lo km/h (MPH)	4.6 (2.9) 2.8 (1.7)	4.6 (2.9) 2.8 (1.7)	4.6 (2.9) 2.8 (1.7)	4.2 (2.6) 2.8 (1.7)	
DIMENSIONS: See the page of dimensions.							
ENGINE (Electric Motor):							
Model			KOMATSU SAA6D140E-5	KOMATSU SAA6D140E-5	KOMATSU SAA6D140E-5	KOMATSU SAA6D140E-3	
No. of cylinders- bore × stroke		mm (in)	6-140 × 165 (5.51 × 6.50)	6-140 × 165 (5.51 × 6.50)	6-140 × 165 (5.51 × 6.50)	6-140 × 165 (5.51 × 6.50)	
Piston displacement		ltr. (cu.in)	15.24 (930)	15.24 (930)	15.24 (930)	15.24 (930)	
HYDRAULIC SYSTEM:							
Hydraulic pump			2 × Variable Piston	2 × Variable Piston	2 × Variable Piston	2 × Variable Piston	
Max. oil flow		ltr. (U.S. Gal)/min.	820 (217)	820 (217)	820 (217)	988 (261)	
Max. oil pressure (Implement)		kg/cm ² (PSI)	325 (4620)	325 (4620)	325 (4620)	325 (4550)	
Track shoe width/ ground pressure		mm (in)/ kg/cm ² (PSI)	610 (24)/ 1.09 (15.5)	610 (24)/ 1.09 (15.5)	610 (24)/ 1.11 (15.8)	610 (24)/ 1.20 (17.1)	
CAPACITY (Refilled):							
Fuel tank		ltr. (U.S.Gal)	880 (232)	880 (232)	880 (232)	880 (232)	
Hydraulic oil tank			360 (95.0)	360 (95.0)	360 (95.0)	440 (116)	
MACHINE SPEC:							
Boom		mm (ft.in)	7660 (25'2")	7660 (25'2")	6600 (21'9")	8200 (26'11")	
Arm		mm (ft.in)	3500 (11'6")	3500 (11'6")	3500 (11'6")	3600 (11'0")	
Bucket (SAE)		m ³ (cu.yd)	2.7 (3.53)	2.7 (3.53)	2.7 (3.53)	3.10 (4.05)	

* Operating weight includes coolant, lubricants, full fuel tank, operator 80kg (180lb) and, indicated implement, shoes and upper attachment.

- EPA Tier 3 and EU Stage 3A model

Specifications

EXCAVATORS (BACKHOE)

Model		PC750-7 (SE spec.)	*PC800-8E0	PC800-8R1	*PC800-8E0	
Source		Japan (for Russia)	Japan	Japan	UK	
OPERATING WEIGHT*		kg (lb)	73170 (161,310)	74500 (164,240)	74500 (164,240)	79700 (175,710)
HORSEPOWER SAE J1995 Gross ISO9249 /SAE J1349 Net Hyd. fan at max. speed Net		kW (HP)/RPM kW (HP)/RPM kW (HP)/RPM	370 (496)/1800 338 (454)/1800	370 (496)/1800 363 (487)/1800 338 (454)/1800	370 (496)/1800 363 (487)/1800 338 (454)/1800	370 (496)/1800 363 (487)/1800 338 (454)/1800
BUCKET CAPACITY RANGE (SAE)		m ³ (cu.yd)	4.0 ~ 4.5 (5.23) (5.89)	2.8 ~ 3.4 (3.66) (4.45)	2.8 ~ 3.4 (3.66) (4.45)	3.6 ~ 6.0 (4.71) (7.85)
PERFORMANCE: Swing speed Max travel speed		RPM km/h (MPH) Hi Mi Lo	6.8 4.2 (2.6) 2.8 (1.7)	6.8 4.2 (2.6) 2.8 (1.7)	6.8 4.2 (2.6) 2.8 (1.7)	6.8 4.2 (2.6) 2.8 (1.7)
DIMENSIONS: See the page of dimensions.						
ENGINE (Electric Motor): Model No. of cylinders- bore × stroke Piston displacement		mm (in) ltr. (cu.in)	KOMATSU SAA6D140E-3 6-140 × 165 (5.51 × 6.50) 15.24 (930)	KOMATSU SAA6D140E-5 6-140 × 165 (5.51 × 6.50) 15.24 (930)	KOMATSU SAA6D140E-5 6-140 × 165 (5.51 × 6.50) 15.24 (930)	KOMATSU SAA6D140E-5 6-140 × 165 (5.51 × 6.50) 15.24 (930)
HYDRAULIC SYSTEM: Hydraulic pump Max. oil flow Max. oil pressure (Implement)		ltr. (U.S. Gal)/min. kg/cm ² (PSI)	2 × Variable Piston 988 (261) 320 (4550)	2 × Variable Piston 988 (261) 320 (4550)	2 × Variable Piston 988 (261) 320 (4550)	2 × Variable Piston 988 (261) 320 (4550)
Track shoe width/ ground pressure		mm (in)/ kg/cm ² (PSI)	610 (24)/ 1.22 (17.3)	610 (24)/ 1.24 (17.6)	610 (24)/ 1.24 (17.6)	610 (24)/ 1.31 (18.6)
CAPACITY (Refilled): Fuel tank Hydraulic oil tank		ltr. (U.S.Gal)	880 (232) 440 (116)	980 (259) 470 (124)	980 (259) 470 (124)	980 (259) 470 (124)
MACHINE SPEC: Boom Arm Bucket (SAE)		mm (ft.in) mm (ft.in) m ³ (cu.yd)	7100 (23'4") 2945 (9'8") 4.0 (5.23)	8200 (26'11") 3600 (11'10") 3.1 (4.05)	8200 (26'11") 3600 (11'10") 3.1 (4.05)	8000 (26'3") 3400 (11'2") 3.4 (4.45)

Model		*PC800LC-8E0	*PC800LC-8E0	PC800LC-8R1	*PC800LC-8E0	
Source		Japan (for USA)	Japan	Japan	UK	
OPERATING WEIGHT*		kg (lb)	84180 (185,580)	77500 (170,860)	77500 (170,860)	81900 (180,560)
HORSEPOWER SAE J1995 Gross ISO9249 /SAE J1349 Net Hyd. fan at max. speed Net		kW (HP)/RPM kW (HP)/RPM kW (HP)/RPM	370 (496)/1800 363 (487)/1800 338 (454)/1800	370 (496)/1800 363 (487)/1800 338 (454)/1800	370 (496)/1800 363 (487)/1800 338 (454)/1800	370 (496)/1800 363 (487)/1800 338 (454)/1800
BUCKET CAPACITY RANGE (SAE)		m ³ (cu.yd)	1.7 ~ 4.53 (2.23) (5.93)	2.8 ~ 3.4 (3.66) (4.45)	2.8 ~ 3.4 (3.66) (4.45)	3.6 ~ 6.0 (4.71) (7.85)
PERFORMANCE: Swing speed Max travel speed		RPM km/h (MPH) Hi Mi Lo	6.8 4.2 (2.6) 2.8 (1.7)	6.8 4.2 (2.6) 2.8 (1.7)	6.8 4.2 (2.6) 2.8 (1.7)	6.8 4.2 (2.6) 2.8 (1.7)
DIMENSIONS: See the page of dimensions.						
ENGINE (Electric Motor): Model No. of cylinders- bore × stroke Piston displacement		mm (in) ltr. (cu.in)	KOMATSU SAA6D140E-5 6-140 × 165 (5.51 × 6.50) 15.24 (930)	KOMATSU SAA6D140E-5 6-140 × 165 (5.51 × 6.50) 15.24 (930)	KOMATSU SAA6D140E-5 6-140 × 165 (5.51 × 6.50) 15.24 (930)	KOMATSU SAA6D140E-5 6-140 × 165 (5.51 × 6.50) 15.24 (930)
HYDRAULIC SYSTEM: Hydraulic pump Max. oil flow Max. oil pressure (Implement)		ltr. (U.S. Gal)/min. kg/cm ² (PSI)	2 × Variable Piston 988 (261) 320 (4550)	2 × Variable Piston 988 (261) 320 (4550)	2 × Variable Piston 988 (261) 320 (4550)	2 × Variable Piston 988 (261) 320 (4550)
Track shoe width/ ground pressure		mm (in)/ kg/cm ² (PSI)	810 (32)/ 0.95 (13.5)	810 (32)/ 0.88 (12.5)	810 (32)/ 0.88 (12.5)	710 (28)/ 1.05 (14.9)
CAPACITY (Refilled): Fuel tank Hydraulic oil tank		ltr. (U.S.Gal)	980 (259) 470 (124)	980 (259) 470 (124)	980 (259) 470 (124)	980 (259) 470 (124)
MACHINE SPEC: Boom Arm Bucket (SAE)		mm (ft.in) mm (ft.in) m ³ (cu.yd)	8200 (26'11") 3600 (11'10") 3.1 (4.05)	8200 (26'11") 3600 (11'10") 3.1 (4.05)	8200 (26'11") 3600 (11'10") 3.1 (4.05)	8000 (26'3") 3400 (11'2") 3.4 (4.45)

* Operating weight includes coolant, lubricants, full fuel tank, operator 80kg (180lb) and, indicated implement, shoes and upper attachment.

- EPA Tier 3 and EU Stage 3A model

Specifications

EXCAVATORS (BACKHOE)

Item		Model	•PC800-8E0 (SE spec.)	PC800-8R1 (SE spec.)	•PC800LC-8E0 (SE spec.)	PC800LC-8R1 (SE spec.)
Source			Japan	Japan	Japan	Japan
OPERATING WEIGHT*		kg (lb)	75500 (166,450)	75500 (166,450)	76500 (168,650)	76500 (168,650)
HORSEPOWER	SAE J1995 Gross	kW (HP)/RPM	370 (496)/1800	370 (496)/1800	370 (496)/1800	370 (496)/1800
	ISO9249 /SAE J1349 Net	kW (HP)/RPM	363 (487)/1800	363 (487)/1800	363 (487)/1800	363 (487)/1800
	Hyd. fan at max. speed Net	kW (HP)/RPM	338 (454)/1800	338 (454)/1800	338 (454)/1800	338 (454)/1800
BUCKET CAPACITY RANGE (SAE)		m ³ (cu.yd)	4.0 ~ 4.5 (5.23) (5.89)	4.0 ~ 4.5 (5.23) (5.89)	4.0 ~ 4.5 (5.23) (5.89)	4.0 ~ 4.5 (5.23) (5.89)
PERFORMANCE:						
Swing speed		RPM	6.8	6.8	6.8	6.8
Max travel speed	Hi Mi Lo	km/h (MPH)	4.2 (2.6)	4.2 (2.6)	4.2 (2.6)	4.2 (2.6)
			2.8 (1.7)	2.8 (1.7)	2.8 (1.7)	2.8 (1.7)
DIMENSIONS: See the page of dimensions.						
ENGINE (Electric Motor):						
Model		mm	KOMATSU SAA6D140E-5	KOMATSU SAA6D140E-5	KOMATSU SAA6D140E-5	KOMATSU SAA6D140E-5
No. of cylinders-		(in)	6-140 × 165	6-140 × 165	6-140 × 165	6-140 × 165
bore × stroke			(5.51 × 6.50)	(5.51 × 6.50)	(5.51 × 6.50)	(5.51 × 6.50)
Piston displacement		ltr. (cu.in)	15.24 (930)	15.24 (930)	15.24 (930)	15.24 (930)
HYDRAULIC SYSTEM:						
Hydraulic pump		ltr. (U.S. Gal)/min.	2 × Variable Piston 988 (261)	2 × Variable Piston 988 (261)	2 × Variable Piston 988 (261)	2 × Variable Piston 988 (261)
Max. oil flow		kg/cm ² (PSI)	320 (4550)	320 (4550)	320 (4550)	320 (4550)
Max. oil pressure (Implement)						
Track shoe width/ ground pressure		mm (in)/	610 (24)/	610 (24)/	810 (32)/	810 (32)/
		kg/cm ² (PSI)	1.25 (17.8)	1.25 (17.8)	0.87 (12.4)	0.87 (12.4)
CAPACITY (Refilled):						
Fuel tank		ltr. (U.S.Gal)	980 (259)	980 (259)	980 (259)	980 (259)
Hydraulic oil tank			470 (124)	470 (124)	470 (124)	470 (124)
MACHINE SPEC:						
Boom		mm (ft.in)	7100 (23'4")	7100 (23'4")	7100 (23'4")	7100 (23'4")
Arm		mm (ft.in)	2945 (9'8")	2945 (9'8")	2945 (9'8")	2945 (9'8")
Bucket (SAE)		m ³ (cu.yd)	4.0 (5.23)	4.0 (5.23)	4.0 (5.23)	4.0 (5.23)

Item		Model	•PC850-8E0 (SE spec.)	PC850-8R1	PC800-7	•PC850-8E0 (SE spec.)
Source			Japan	Japan	Japan (for Russia)	Japan
OPERATING WEIGHT*		kg (lb)	79000 (17,420)	79000 (17,420)	76070 (167,700)	78600 (173,280)
HORSEPOWER	SAE J1995 Gross	kW (HP)/RPM	370 (496)/1800	370 (496)/1800		370 (496)/1800
	ISO9249 /SAE J1349 Net	kW (HP)/RPM	363 (487)/1800	363 (487)/1800	338 (454)/1800	363 (487)/1800
	Hyd. fan at max. speed Net	kW (HP)/RPM	338 (454)/1800	338 (454)/1800		338 (454)/1800
BUCKET CAPACITY RANGE (SAE)		m ³ (cu.yd)	3.4 (4.45)	3.4 (4.45)	3.4 (4.45)	4.0 ~ 4.5 (5.23) (5.89)
PERFORMANCE:						
Swing speed		RPM	6.8	6.8	6.8	6.8
Max travel speed	Hi Mi Lo	km/h (MPH)	4.2 (2.6)	4.2 (2.6)	4.2 (2.6)	4.2 (2.6)
			2.8 (1.7)	2.8 (1.7)	2.8 (1.7)	2.8 (1.7)
DIMENSIONS: See the page of dimensions.						
ENGINE (Electric Motor):						
Model		mm	KOMATSU SAA6D140E-5	KOMATSU SAA6D140E-5	KOMATSU SAA6D140E-3	KOMATSU SAA6D140E-5
No. of cylinders-		(in)	6-140 × 165	6-140 × 165	6-140 × 165	6-140 × 165
bore × stroke			(5.51 × 6.50)	(5.51 × 6.50)	(5.51 × 6.50)	(5.51 × 6.50)
Piston displacement		ltr. (cu.in)	15.24 (930)	15.24 (930)	15.24 (930)	15.24 (930)
HYDRAULIC SYSTEM:						
Hydraulic pump		ltr. (U.S. Gal)/min.	2 × Variable Piston 988 (261)	2 × Variable Piston 988 (261)	2 × Variable Piston 988 (261)	2 × Variable Piston 988 (261)
Max. oil flow		kg/cm ² (PSI)	320 (4550)	320 (4550)	320 (4550)	320 (4550)
Max. oil pressure (Implement)						
Track shoe width/ ground pressure		mm (in)/	610 (24)/	610 (24)/	610 (24)/	610 (24)/
		kg/cm ² (PSI)	1.31 (18.6)	1.31 (18.6)	1.27 (18.1)	1.31 (18.6)
CAPACITY (Refilled):						
Fuel tank		ltr. (U.S.Gal)	980 (259)	980 (259)	880 (232)	980 (259)
Hydraulic oil tank			470 (124)	470 (124)	440 (116)	470 (124)
MACHINE SPEC:						
Boom		mm (ft.in)	8040 (26'5")	8040 (26'5")	8040 (26'5")	7100 (23'4")
Arm		mm (ft.in)	3600 (11'10")	3600 (11'10")	3600 (11'10")	2945 (9'8")
Bucket (SAE)		m ³ (cu.yd)	3.4 (4.45)	3.4 (4.45)	3.4 (4.45)	4.3 (5.62)

* Operating weight includes coolant, lubricants, full fuel tank, operator 80kg (180lb) and, indicated implement, shoes and upper attachment.

- EPA Tier 3 and EU Stage 3A model

Specifications

EXCAVATORS (BACKHOE)

Item		Model	PC850-8R1 (SE spec.)	PC800-7 (SE spec.)	*PC1250-8	PC1250-8R
Source			Japan	Japan (for Russia)	Japan	Japan
OPERATING WEIGHT*		kg (lb)	78600 (173,280)	75570 (166,600)	106500 (234,790)	106500 (234,790)
HORSEPOWER		SAE J1995 Gross ISO9249 /SAE J1349 Net Hyd. fan at max. speed Net	kW (HP)/RPM 370 (496)/1800 363 (487)/1800 338 (454)/1800	338 (454)/1800	514 (688)/1800 502 (672)/1800 463 (620)/1800	514 (688)/1800 502 (672)/1800 463 (620)/1800
BUCKET CAPACITY RANGE (SAE)		m ³ (cu.yd)	4.0 ~ 4.5 (5.23) (5.89)	4.0 ~ 4.5 (5.23) (5.89)	3.4 ~ 5.2 (4.4) (6.8)	3.4 ~ 5.2 (4.4) (6.8)
PERFORMANCE:						
Swing speed		RPM	6.8	6.8	5.5	5.5
Max travel speed		Hi Mi Lo km/h (MPH)	4.2 (2.6)	4.2 (2.6)	3.2 (2.0)	3.2 (2.0)
DIMENSIONS: See the page of dimensions.			2.8 (1.7)	2.8 (1.7)	2.1 (1.3)	2.1 (1.3)
ENGINE (Electric Motor):						
Model			KOMATSU SAA6D140E-5	KOMATSU SAA6D140E-3	KOMATSU SAA6D170E-5	KOMATSU SAA6D170E-5
No. of cylinders- bore × stroke		mm (in)	6-140 × 165 (5.51 × 6.50)	6-140 × 165 (5.51 × 6.50)	6-170 × 170 (6.69 × 6.69)	6-170 × 170 (6.69 × 6.69)
Piston displacement		ltr. (cu.in)	15.24 (930)	15.24 (930)	23.15 (1413)	23.15 (1413)
HYDRAULIC SYSTEM:						
Hydraulic pump			2 × Variable Piston	2 × Variable Piston	3 × Variable Piston	3 × Variable Piston
Max. oil flow		ltr. (U.S. Gal)/min.	988 (261)	988 (261)	1588 (420)	1588 (420)
Max. oil pressure (Implement)		kg/cm ² (PSI)	320 (4550)	320 (4550)	320 (4550)	320 (4550)
Track shoe width/ ground pressure		mm (in)/ kg/cm ² (PSI)	610 (24)/ 1.31 (18.6)	610 (24)/ 1.25 (17.8)	700 (28)/ 1.39 (19.8)	700 (28)/ 1.39 (19.8)
CAPACITY (Refilled):						
Fuel tank		ltr. (U.S.Gal)	980 (259)	880 (232)	1360 (359)	1360 (359)
Hydraulic oil tank			470 (124)	440 (116)	670 (177)	670 (177)
MACHINE SPEC:						
Boom		mm (ft.in)	7100 (23'4")	7100 (23'4")	9100 (29'10")	9100 (29'10")
Arm		mm (ft.in)	2945 (9'8")	2945 (9'8")	3400 (11'2")	3400 (11'2")
Bucket (SAE)		m ³ (cu.yd)	4.3 (5.62)	4.3 (5.62)	5.0 (6.5)	5.0 (6.5)

Item		Model	PC1250-8R	PC1250-7	*PC1250LC-8	*PC1250-8 (SP spec.)
Source			Indonesia	Japan	Japan	Japan
OPERATING WEIGHT*		kg (lb)	106500 (234,790)	106700 (235,230)	113500 (250,150)	110700 (244,050)
HORSEPOWER		SAE J1995 Gross ISO9249 /SAE J1349 Net Hyd. fan at max. speed Net	kW (HP)/RPM 514 (688)/1800 502 (672)/1800 463 (620)/1800	485 (651)/1800	514 (688)/1800 502 (672)/1800 463 (620)/1800	514 (688)/1800 502 (672)/1800 463 (620)/1800
BUCKET CAPACITY RANGE (SAE)		m ³ (cu.yd)	6.7 (8.76)	3.4 ~ 5.2 (4.45) (6.80)	3.4 ~ 5.2 (5.23) (6.8)	6.7 (8.8)
PERFORMANCE:						
Swing speed		RPM	5.8	5.5	5.5	5.5
Max travel speed		Hi Mi Lo km/h (MPH)	3.2 (2.0)	3.2 (2.0)	3.2 (2.0)	3.2 (2.0)
DIMENSIONS: See the page of dimensions.			2.1 (1.3)	2.1 (1.3)	2.1 (1.3)	2.1 (1.3)
ENGINE (Electric Motor):						
Model			KOMATSU SAA6D170E-5	KOMATSU SAA6D170E-3	KOMATSU SAA6D170E-5	KOMATSU SAA6D170E-5
No. of cylinders- bore × stroke		mm (in)	6-170 × 170 (6.69 × 6.69)	6-170 × 170 (6.69 × 6.69)	6-170 × 170 (6.69 × 6.69)	6-170 × 170 (6.69 × 6.69)
Piston displacement		ltr. (cu.in)	23.15 (1423)	23.15 (1413)	23.15 (1413)	23.15 (1413)
HYDRAULIC SYSTEM:						
Hydraulic pump			3 × Variable Piston	3 × Variable Piston	3 × Variable Piston	3 × Variable Piston
Max. oil flow		ltr. (U.S. Gal)/min.	1588 (420)	1588 (420)	1588 (420)	1588 (420)
Max. oil pressure (Implement)		kg/cm ² (PSI)	320 (4550)	320 (4550)	320 (4550)	320 (4550)
Track shoe width/ ground pressure		mm (in)/ kg/cm ² (PSI)	700 (28)/ 1.39 (19.8)	700 (28)/ 1.38 (19.6)	1000 (39.4)/ 0.88 (12.5)	700 (28)/ 1.44 (20.4)
CAPACITY (Refilled):						
Fuel tank		ltr. (U.S.Gal)	1360 (359)	1360 (359)	1360 (359)	1360 (359)
Hydraulic oil tank			670 (177)	670 (177)	670 (177)	670 (177)
MACHINE SPEC:						
Boom		mm (ft.in)	7800 (25'7")	9100 (29'10")	9100 (29'10")	7800 (25'7")
Arm		mm (ft.in)	3400 (11'2")	3400 (11'2")	3400 (11' 2")	3400 (11'2")
Bucket (SAE)		m ³ (cu.yd)	6.7 (8.76)	5.0 (6.54)	5.0 (6.5)	6.7 (8.8)

* Operating weight includes coolant, lubricants, full fuel tank, operator 80kg (180lb) and, indicated implement, shoes and upper attachment.

- EPA Tier 3 and EU Stage 3A model

Specifications

EXCAVATORS (BACKHOE)

Item	Model	PC1250-8R (SP spec.)	PC1250-7 (SP spec)	PC2000-8	PC3000-6 Diesel Tier 1
Source		Japan	Japan	Japan, Indonesia	Japan, Germany
OPERATING WEIGHT*	kg (lb)	110700 (244,050)	109500 (241,400)	200000 (440,920)	252350 (556,300)
HORSEPOWER	SAE J1995 Gross ISO9249 /SAE J1349 Net Hyd. fan at max. speed Net	kW (HP)/RPM 514 (688)/1800 502 (672)/1800 463 (620)/1800	485 (651)/1800	728 (976)/1800 713 (956)/1800 679 (910)/1800	940 (1260)/1800 895 (1200)/1800
BUCKET CAPACITY RANGE (SAE)	m ³ (cu.yd)	6.7 (8.8)	6.7 (8.76)	12 ~ 13.7 (15.7) (17.9)	10 ~ 20 (13.1) (26.2)
PERFORMANCE:					
Swing speed	RPM	5.5	5.5	4.8	4.6
Max travel speed	Hi Mi Lo km/h (MPH)	3.2 (2.0) 2.1 (1.3)	3.2 (2.0) 2.1 (1.3)	2.7 (1.7)	2.4 (1.5)
DIMENSIONS: See the page of dimensions.					
ENGINE (Electric Motor):					
Model		KOMATSU SAA6D170E-5	KOMATSU SAA6D170E-3	KOMATSU SAA12V140E-3	KOMATSU SSA12V159
No. of cylinders- bore × stroke	mm (in)	6-170 × 170 (6.69 × 6.69)	6-170 × 170 (6.69 × 6.69)	12-140 × 165 (5.51 × 6.50)	12-159 × 159 (6.26 × 6.26)
Piston displacement	ltr. (cu.in)	23.15 (1413)	23.15 (1413)	30.48 (1860)	37.5 (2288)
HYDRAULIC SYSTEM:					
Hydraulic pump		3 × Variable Piston	3 × Variable Piston	2 × Variable Piston	3 × Variable Piston
Max. oil flow	ltr. (U.S. Gal)/min.	1588 (420)	1588 (420)	2317 (612)	2730 (721)
Max. oil pressure (Implement)	kg/cm ² (PSI)	320 (4550)	320 (4550)	300 (4270)	310 (4410)
Track shoe width/ ground pressure	mm (in)/ kg/cm ² (PSI)	700 (28)/ 1.44 (20.4)	700 (28)/ 1.43 (20.3)	810 (32)/ 1.94 (27.6)	800 (31.4)/ 2.37 (33.7)
CAPACITY (Refilled):					
Fuel tank	ltr. (U.S.Gal)	1360 (359)	1360 (359)	3400 (898)	4500 (1190)
Hydraulic oil tank		670 (177)	670 (177)	1300 (343)	2900 (765)
MACHINE SPEC:					
Boom	mm (ft.in)	7800 (257")	7800 (257")	8700 (287")	8600 (28'3")
Arm	mm (ft.in)	3400 (11'2")	3400 (11'2")	3900 (12'10")	4000 (13'1")
Bucket (SAE)	m ³ (cu.yd)	6.7 (8.8)	6.7 (8.76)	12 (15.7)	15 (19.5)

Item	Model	PC3000-6 Diesel Tier 2	PC3000E-6 Electric Drive	PC4000-6 Diesel Tier 1	PC4000-6 Diesel Tier 2
Source		Japan, Germany	Japan, Germany	Japan, Germany	Japan, Germany
OPERATING WEIGHT*	kg (lb)	252350 (556,300)	254250 (560,500)	394200 (869,000)	394200 (869,000)
HORSEPOWER	SAE J1995 Gross ISO9249 /SAE J1349 Net Hyd. fan at max. speed Net	kW (HP)/RPM 940 (1260)/1800 895 (1200)/1800	900 (1206)	1400 (1875)/1800 1324 (1775)/1800	1400 (1875)/1800 1324 (1775)/1800
BUCKET CAPACITY RANGE (SAE)	m ³ (cu.yd)	10 ~ 20 (13.1) (26.2)	10 ~ 20 (13.1) (26.2)	16 ~ 28 (20.9) (36.6)	16 ~ 28 (20.9) (36.6)
PERFORMANCE:					
Swing speed	RPM	4.6	4.6	4.0	4.0
Max travel speed	Hi Mi Lo km/h (MPH)	2.4 (1.5) 	2.4 (1.5) 	2.1 (1.3)	2.1 (1.3)
DIMENSIONS: See the page of dimensions.					
ENGINE (Electric Motor):					
Model		KOMATSU SSA12V159E-2	Siemens (6.6 kv) 1LA452	KOMATSU SDA16V160	KOMATSU SDA16V160E-2
No. of cylinders- bore × stroke	mm (in)	12-159 × 159 (6.26 × 6.26)		16-159 × 190 (6.26 × 7.48)	16-159 × 190 (6.26 × 7.48)
Piston displacement	ltr. (cu.in)	37.5 (2288)		60.2 (3673)	60.2 (3673)
HYDRAULIC SYSTEM:					
Hydraulic pump		3 × Variable Piston	3 × Variable Piston	4 × Variable Piston	4 × Variable Piston
Max. oil flow	ltr. (U.S. Gal)/min.	2730 (721)	2730 (721)	4140 (1094)	4140 (1094)
Max. oil pressure (Implement)	kg/cm ² (PSI)	310 (4410)	310 (4410)	310 (4410)	310 (4410)
Track shoe width/ ground pressure	mm (in)/ kg/cm ² (PSI)	800 (31.4)/ 2.37 (33.7)	800 (31.4)/ 2.38 (33.8)	1200 (47)/ 2.20 (31.3)	1200 (47)/ 2.20 (31.3)
CAPACITY (Refilled):					
Fuel tank	ltr. (U.S.Gal)	4500 (1190)	—	6400 (1690)	6400 (1690)
Hydraulic oil tank		2900 (765)	2900 (765)	3900 (1030)	3900 (1030)
MACHINE SPEC:					
Boom	mm (ft.in)	8600 (28'3")	8600 (28'3")	9750 (32'0")	9750 (32'0")
Arm	mm (ft.in)	4000 (13'1")	4000 (13'1")	4500 (14'9")	4500 (14'9")
Bucket (SAE)	m ³ (cu.yd)	15 (19.5)	15 (19.5)	22 (28.8)	22 (28.8)

* Operating weight includes coolant, lubricants, full fuel tank, operator 80kg (180lb) and, indicated implement, shoes and upper attachment.

Specifications

EXCAVATORS (BACKHOE)

Model		PC400E-6 Electric Drive	PC5500-6 Diesel Tier 1	PC5500-6 Diesel Tier 2	PC5500E-6 Electric Drive	
Source		Japan, Germany	Germany	Germany	Germany	
OPERATING WEIGHT*		kg (lb)	385850 (850,650)	536500 (1,182,800)	538000 (1,186,100)	531700 (1,172,200)
HORSEPOWER SAE J1995 Gross ISO9249 /SAE J1349 Net Hyd. fan at max. speed Net		kW (HP)/RPM kW (HP)/RPM kW (HP)/RPM	1350 (1809)	1880 (2520)/1800 1825 (2446)/1800	1880 (2520)/1800 1825 (2446)/1800	1800 (2412)
BUCKET CAPACITY RANGE (SAE)		m ³ (cu.yd)	16 ~ 28 (20.9) (36.6)	21 ~ 36 (27.5) (47.1)	21 ~ 36 (27.5) (47.1)	21 ~ 36 (27.5) (47.1)
PERFORMANCE: Swing speed Max travel speed		RPM km/h (MPH)	4.0 2.1 (1.3)	3.1 2.1 (1.3)	3.1 2.1 (1.3)	3.1 2.1 (1.3)
DIMENSIONS: See the page of dimensions.						
ENGINE (Electric Motor): Model No. of cylinders- bore × stroke Piston displacement		mm (in) ltr. (cu.in)	ABB (6.6 kV) AMA500L4A	KOMATSU SSA12V159 × 2 12-159 × 159 (6.26 × 6.26) 37.5 (2288) × 2	KOMATSU 2 × SDA12V159E-2 12-159 × 159 (6.26 × 6.26) 2 × 37.5 (2288)	ABB (6.6 kV) × 2 AHA450L4A
HYDRAULIC SYSTEM: Hydraulic pump Max. oil flow Max. oil pressure (Implement)		ltr. (U.S. Gal)/min. kg/cm ² (PSI)	4 × Variable Piston 4140 (1094) 310 (4410)	6 × Variable Piston 4200 (1110) 310 (4410)	6 × Variable Piston 4200 (1100) 310 (4410)	6 × Variable Piston 4200 (1100) 310 (4410)
Track shoe width/ ground pressure		mm (in)/ kg/cm ² (PSI)	1200 (47)/ 2.16 (30.7)	1350 (53)/ 2.41 (34.3)	1350 (53)/ 2.42 (34.4)	1350 (53)/ 2.39 (34.0)
CAPACITY (Refilled): Fuel tank Hydraulic oil tank		ltr. (U.S.Gal)	— 3900 (1030)	10800 (2853) 3800 (1004)	10800 (2853) 3800 (1004)	— 3800 (1004)
MACHINE SPEC: Boom Arm Bucket (SAE)		mm (ft.in) mm (ft.in) m ³ (cu.yd)	9750 (32'0") 4500 (14'9") 22 (28.8)	11000 (36'1") 5100 (16'9") 29 (37.9)	11000 (36'1") 5100 (16'9") 29 (37.9)	11000 (36'1") 5100 (16'9") 29 (37.9)

Model		PC8000-6 Diesel Tier 2	PC8000E-6 Electric Drive		
Source		Germany	Germany		
OPERATING WEIGHT*		kg (lb)	753500 (1,661,200)	735800 (1,622,150)	
HORSEPOWER SAE J1995 Gross ISO9249 /SAE J1349 Net Hyd. fan at max. speed Net		kW (HP)/RPM kW (HP)/RPM kW (HP)/RPM	3000 (4021)/1800 2882 (3863)/1800	2900 (3887)	
BUCKET CAPACITY RANGE (SAE)		m ³ (cu.yd)	28 ~ 50 (36.6) (65.4)	28 ~ 50 (36.6) (65.4)	
PERFORMANCE: Swing speed Max travel speed		RPM km/h (MPH)	2.7 2.4 (1.5)	2.7 2.4 (1.5)	
DIMENSIONS: See the page of dimensions.					
ENGINE (Electric Motor): Model No. of cylinders- bore × stroke Piston displacement		mm (in) ltr. (cu.in)	KOMATSU 2 × SDA16V160E-2	ABB (6.6kV) 2 × AMA500L4A	
HYDRAULIC SYSTEM: Hydraulic pump Max. oil flow Max. oil pressure (Implement)		ltr. (U.S. Gal)/min. kg/cm ² (PSI)	8 × Variable Piston 8280 (2188) 310 (4410)	8 × Variable Piston 8280 (2188) 310 (4410)	
Track shoe width/ ground pressure		mm (in)/ kg/cm ² (PSI)	1500 (59)/ 2.78 (39.5)	1500 (59)/ 2.72 (38.7)	
CAPACITY (Refilled): Fuel tank Hydraulic oil tank		ltr. (U.S.Gal)	14000 (3672) 8350 (2206)	— 8350 (2206)	
MACHINE SPEC: Boom Arm Bucket (SAE)		mm (ft.in) mm (ft.in) m ³ (cu.yd)	11500 (37'9") 5500 (18'1") 42 (55)	11500 (37'9") 5500 (18'1") 42 (55)	

* Operating weight includes coolant, lubricants, full fuel tank, operator 80kg (180lb) and, indicated implement, shoes and upper attachment.

Dimensions

EXCAVATORS (BACKHOE)

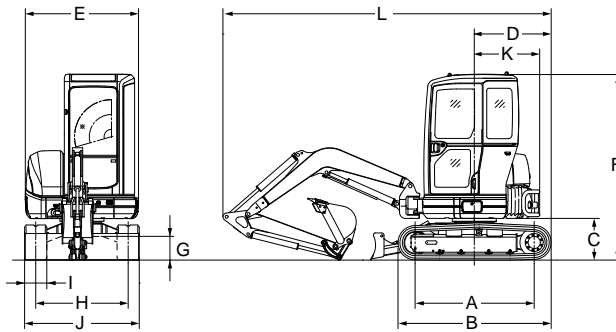

FVBH0017

	A mm (ft.in)	B mm (ft.in)	C mm (ft.in)	D mm (ft.in)	E mm (ft.in)	F mm (ft.in)	G mm (ft.in)	H mm (ft.in)	I mm (in)	J mm (ft.in)	K mm (ft.in)	L mm (ft.in)	Boom length m (ft.in)	Arm length m (ft.in)
PC09-1	900 (2'11")	1225 (4')	350 (1'2")	790 (2'7")	700 (2'4")	2100 (6'11")	180 (7.1")	520 (1'8")	180 (7")	700 (2'4")	—	2730 (8'11")	1.357 (4'5")	0.684 (2'3")
PC14R-3	1015 (3'4")	1380 (4'6")	430 (1'5")	—	980 (3'3")	2320 (7'7")	205 (8.1")	770 (2'6")	230 (9")	1000 (3'3")	825 (2'8")	3380 (11'1")	1.62 (5'4")	0.88 (2'11")
												3400 (11'2")		1.13 (3'8")
PC16R-3	1015 (3'4")	1380 (4'6")	430 (1'5")	—	980 (3'3")	2320 (7'7")	205 (8.1")	770 (2'6")	230 (9")	1000 (3'3")	825 (2'8")	3525 (11'7")	1.76 (5'9")	0.965 (3'2")
												3540 (11'7")		1.215 (4'0")
PC18MR-3	1212 (4'0")	1555 (5'1")	430 (1'5")	750 (2'6")	980 (3'3")	2410 (7'11")	170 (6.7")	750/ (2'6")	230 (9")	990/ (3'3")	715 (2'4")	3650 (12'0")	1.76 (5'9")	0.965 (3'2")
								1045 (3'5")				1280 (4'2")		3665 (12'0")
PC18MR-3**	1212 (4'0")	1555 (5'1")	430 (1'5")	750 (2'6")	980 (3'3")	2320 (7'7")	170 (6.7")	750/ (2'6")	230 (9")	980/ (3'11")	705 (2'4")	3650 (12'0")	1.76 (5'9")	0.965 (3'2")
								1070 (3'6")				1300 (4'3")		3665 (12'0")
PC20MR-3	1440 (4'9")	1880 (6'2")	530 (1'9")	920 (3'0")	1390 (4'7")	2520 (8'3")	285 (11.2")	1200 (3'11")	250 (10")	1450 (4'9")	805 (2'8")	3750 (12'4")	1.81 (5'11")	0.97 (3'2")
												3855 (12'8")		1.32 (4'4")
PC22MR-3**	1440 (4'9")	1880 (6'2")	530 (1'9")	920 (3'0")	1390 (4'7")	2485 (8'2")	285 (11.2")	1200 (3'11")	250 (10")	1450 (4'9")	800 (2'7")	3855 (12'8")	1.81 (5'11")	0.97 (3'2")
												3750 (12'4")		1.32 (4'4")
PC26MR-3**	1485 (4'10")	1950 (6'5")	544 (1'9")	955 (3'2")	1390 (4'7")	2497 (8'2")	285 (11.2")	1200 (3'11")	300 (12")	1500 (4'11")	810 (2'8")	4045 (13'3")	2.2 (7'3")	1.115 (3'8")
												4060 (13'4")		1.37 (4'6")
PC27MR-3	1485 (4'10")	1950 (6'5")	545 (1'9")	955 (3'2")	1485 (4'10")	2520 (8'3")	320 (12.6")	1250 (4'1")	300 (12")	1550 (5'1")	855 (2'10")	4240 (13'11")	2.18 (7'2")	1.10 (3'7")
												4275 (14'0")		1.37 (4'6")
PC30MR-3* PC30MR-3**	1650 (5'5")	2105 (6'11")	545 (1'9")	1050 (3'5")	1485 (4'10")	2520 (8'3")	305 (12.0")	1250 (4'1")	300 (12")	1550 (5'1")	855 (2'10")	4560 (15'0")	2.285 (7'6")	1.24 (4'1")
												4600 (15'1")		1.61 (5'3")
PC35MR-3* PC35MR-3**	1650 (5'5")	2105 (6'11")	545 (1'9")	1050 (3'5")	1485 (4'10")	2520 (8'3")	290 (11.4")	1440 (4'9")	300 (12")	1740 (5'9")	950 (3'1")	4825 (15'10")	2.54 (8'4")	1.37 (4'5")
												4905 (16'1")		1.72 (5'8")
PC45MR-3* PC45MR-3**	2000 (6'7")	2520 (8'3")	608 (2'0")	1265 (4'2")	1835 (6'0")	2550 (8'4")	290 (11.4")	1560 (5'1")	400 (16")	1960 (6'5")	1060 (3'6")	5220 (17'2")	2.64 (8'8")	1.375 (4'6")
												5450 (17'11")		1.77 (5'10")
PC55MR-3* PC55MR-3**	2000 (6'7")	2520 (8'3")	608 (2'0")	1265 (4'2")	1835 (6'0")	2550 (8'4")	290 (11.4")	1560 (5'1")	400 (16")	1960 (6'5")	1060 (3'6")	5550 (18'3")	2.9 (9'6")	1.64 (5'5")
												5615 (18'5")		2.0 (6'7")
PC56-7***	1980 (6'6")	2500 (8'2")	615 (2'0")	1255 (4'1")	1850 (6'1")	2550 (8'4")	320 (1'1")	1560 (5'1")	400 (16")	1960 (6'5")	1650 (5'5")	5935 (19'6")	2.9 (9'6")	1.64 (5'5")

* With ROPS & top guard canopy

** Italy source

*** China source

Dimensions

EXCAVATORS (BACKHOE)

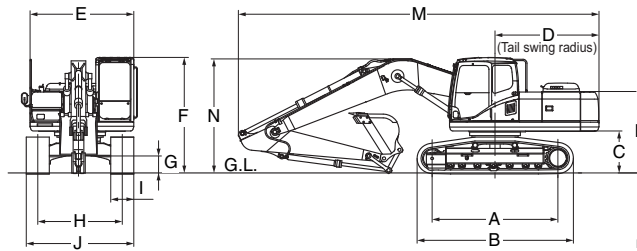

FVBH0313

	A mm (ft.in)	B mm (ft.in)	C mm (ft.in)	D mm (ft.in)	E mm (ft.in)	F mm (ft.in)	G mm (ft.in)	H mm (ft.in)	I mm (in)	J mm (ft.in)	K mm (ft.in)	M mm (ft.in)	N mm (ft.in)	Boom length m (ft.in)	Arm length m (ft.in)
PC60-8***	2130 (7'0")	2765 (9'1")	750 (2'6")	1750 (5'9")	2190 (7'2")	2620 (8'7")	350 (1'4")	1700 (5'7")	450 (18")	2150 (7'1")	1865 (6'1")	6035 (19'10")	2465 (8'1")	3.65 (12'0")	1.55 (5'1")
PC70-8	2130 (7'0")	2765 (9'1")	750 (2'6")	1750 (5'9")	2190 (7'2")	2640 (8'8")	350 (1'4")	1700 (5'7")	450 (18")	2150 (7'1")	1865 (6'1")	6080 (18'11")	2500 (8'2")	3.71 (12'2")	1.65 (5'5")
PC70-8***	2130 (7'0")	2765 (9'1")	750 (2'6")	1750 (5'9")	2180 (7'2")	2620 (8'7")	450 (18")	1700 (5'7")	450 (18")	2150 (7'1")	1865 (6'1")	6080 (18'11")	2500 (8'2")	3.71 (12'2")	1.65 (5'5")
PC78US-8	2235 (7'4")	2840 (9'4")	735 (2'5")	1240 (4'1")	2330 (7'8")	2730 (8'11")	360 (1'2")	1870 (6'2")	450 (18")	2320 (7'7")	1835 (6'0")	5770 (18'11")	2555 (8'5")	3.71 (12'2")	1.65 (5'5")
												6295 (20'8")	2870 (9'5")		2.25 (7'5")
PC80MR-3	2240 (7'4")	2878 (9'5")	755 (2'6")	1330 (4'4")	2200 (7'3")	2710 (8'11")	390 (1'3")	1800 (5'11")	450 (18")	2250 (7'5")	1780 (5'8")	6060 (19'11")	2132 (10'3")	3.2 (10'6")	1.65 (5'5")
															2.0 (6'7")
PC88MR-8	2235 (7'4")	2840 (9'4")	755 (2'6")	1335 (4'5")	2330 (7'8")	2730 (8'11")	360 (1'2")	1870 (6'2")	450 (18")	2320 (7'7")	1855 (6'1")	6175 (20'3")	2240 (7'4")	3.4 (11'2")	1.65 (5'5")
												6350 (20'10")	2615 (8'7")		2.1 (6'11")
PC88MR-8**	2235 (7'4")	2840 (9'4")	755 (2'6")	1335 (4'5")	2330 (7'8")	2730 (8'11")	360 (1'2")	1870 (6'2")	450 (18")	2320 (7'7")	1835 (6'0")	6175 (20'3")	2240 (7'4")	3.4 (11'2")	1.65 (5'5")
												6350 (20'10")	2615 (8'7")		2.1 (6'11")
PC110-7*4	2705 (8'11")	3435 (11'3")	855 (2'10")	2110 (6'11")	2490 (8'2")	2810 (9'3")	400 (1'4")	1990 (6'6")	500 (20")	2490 (7'2")	2190 (7'2")	7170 (23'6")	2810 (9'3")	4.26 (14'0")	2.26 (7'5")
PC118MR-8	2420 (7'11")	3150 (10'4")	863 (2'10")	1440 (4'9")	2390 (7'10")	2845 (9'4")	530 (1'9")	1900 (6'3")	500 (20")	2400 (7'10")	1943 (6'4")	6696 (22'0")	2550 (8'4")	3.5 (11'5")	2.0 (6'7")
												6787 (22'3")	2775 (9'1")		2.3 (7'7")
PC130-8 PC130-8*5	2880 (9'5")	3610 (11'10")	895 (2'11")	2190 (7'2")	2500 (8'2")	2855 (9'4")	400 (1'4")	1990 (6'6")	500 (20")	2490 (8'2")	1925 (6'4")	7590 (24'11")	2875 (9'5")	4.6 (15'1")	2.5 (8'2")
												7485 (24'7")	3185 (10'5")		3.0 (9'10")
PC130-8*6	2880 (9'5")	3610 (11'10")	895 (2'11")	2190 (7'2")	2500 (8'2")	2855 (9'4")	400 (1'4")	1990 (6'6")	500 (20")	2490 (8'2")	1925 (6'4")	7590 (24'11")	2875 (9'5")	4.6 (15'1")	2.5 (8'2")
PC130-7*4	2880 (9'5")	3610 (11'10")	855 (2'10")	2190 (7'2")	2490 (8'2")	2810 (9'3")	400 (1'4")	1990 (6'6")	500 (20")	2490 (8'2")	1885 (6'2")	7590 (24'11")	2620 (8'7")	4.6 (15'1")	2.1 (6'10")
												7595 (24'11")	2715 (8'11")		2.5 (8'2")
PC130-7***	2880 (9'5")	3610 (11'10")	855 (2'10")	2190 (7'2")	2490 (8'2")	2810 (9'3")	400 (1'4")	1990 (6'6")	500 (20")	2490 (8'2")	1885 (6'2")	7590 (24'11")	2620 (8'7")	4.6 (15'1")	2.1 (6'11")
												7595 (24'11")	2715 (8'11")		2.5 (8'2")
												7510 (24'8")	3075 (10'1")		3.0 (9'10")
PC130F-7	2890 (9'6")	3666 (12'0")	1120 (3'8")	2190 (7'2")	2490 (8'2")	3075 (10'1")	600 (2'0")	1960 (6'5")	900 (35.4")	2860 (9'5")	2150 (7'1")	7165 (23'6")	2720 (8'11")	4.26 (14'0")	2.36 (7'9")
												7510 (24'8")	3070 (10'1")		3.0 (9'10")
PC138US-8	2880 (9'5")	3610 (11'10")	900 (2'11")	1480 (4'10")	2490 (8'2")	2815 (9'3")	395 (1'4")	1990 (6'6")	500 (20")	2490 (8'2")	1980 (6'6")	7275 (23'10")	2690 (8'10")	4.6 (15'1")	2.1 (6'11")
												7260 (23'10")	2850 (9'4")		2.5 (8'2")
												7160 (23'6")	3210 (10'6")		3.0 (9'10")
PC138USLC -10*9	3140 (10'4")	3870 (12'8")	900 (2'11")	1545 (5'1")	2490 (8'2")	2815 (9'3")	395 (1'4")	1990 (6'6")	600 (24")	2590 (8'6")	2140 (7'0")	7385 (24'3")	2850 (9'4")	4.6 (15'1")	2.5 (8'2")
												7285 (23'11")	3210 (10'6")		3.0 (9'10")

*: USA source
 **: UK source
 ***: China source
 *4: India source
 *5: Thailand source
 *6: Brazil source

*7: Russia source
 *8: Indonesia source
 *9: for USA
 *10: for UK
 *11: for Russia
 *12: Top of engine cover

*13: When retracted
 *14: When expanded
 *15: Top of exhaust pipe
 *16: with OPG top guard
 *17: Include step

Dimensions

EXCAVATORS (BACKHOE)

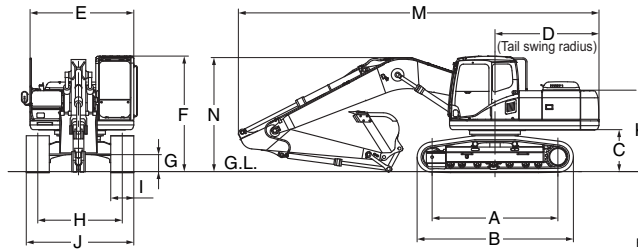

FVBH0313

	A mm (ft.in)	B mm (ft.in)	C mm (ft.in)	D mm (ft.in)	E mm (ft.in)	F mm (ft.in)	G mm (ft.in)	H mm (ft.in)	I mm (in)	J mm (ft.in)	K mm (ft.in)	M mm (ft.in)	N mm (ft.in)	Boom length m (ft.in)	Arm length m (ft.in)
PC160LC-8 PC160LC-8*5	3170 (10'5")	3965 (13'0")	1055 (3'6")	2435 (8'0")	2490 (8'2")	3030*18 (9'11")	440 (1'5")	1990 (6'6")	500 (20")	2490 (8'2")	2065 (6'9")	8565 (28'1")	3015**18 (9'11")	5.15 (16'11")	2.25 (7'5")
												8565 (28'1")	3025**18 (9'11")		2.61 (8'7")
												8565 (28'1")	3125**18 (10'3")		2.9 (9'6")
PC160LC-8**	3170 (10'5")	3965 (13'0")	1055 (3'6")	2435 (8'0")	2490 (8'2")	2970 (9'9")	440 (1'5")	1990 (6'6")	500 (20")	2490 (8'2")	2090 (6'10")	8565 (28'1")	2990 (9'10")	5.15 (16'11")	2.25 (7'5")
												8565 (28'1")	3000 (9'10")		2.6 (8'6")
												8565 (28'1")	3100 (10'2")		2.9 (9'6")
PC160LC-8** (Two-piece boom)	3170 (10'5")	3965 (13'0")	1055 (3'6")	2435 (8'0")	2490 (8'2")	2970 (9'9")	440 (1'5")	1990 (6'6")	500 (20")	2490 (8'2")	2090 (6'10")	8490 (27'10")	2940 (9'8")	5.15 (16'11")	2.25 (7'5")
												8490 (27'10")	2980 (9'9")		2.6 (8'6")
												8475 (27'10")	3030 (9'11")		2.9 (9'6")
PC160LC-8*6	3170 (10'5")	3965 (13'0")	1055 (3'6")	2435 (8'0")	2490 (8'2")	3030 (9'11")	440 (1'5")	1990 (6'6")	700 (28")	2690 (8'10")	2065 (6'9")	8565 (28'1")	3015 (9'11")	5.15 (16'11")	2.25 (7'5")
												8565 (28'1")	3125 (10'3")		2.9 (9'6")
PC160LC-7***	3170 (10'5")	3965 (13'0")	1055 (3'6")	2435 (8'0")	2490 (8'2")	2970 (9'9")	440 (1'5")	1990 (6'6")	500 (20")	2490 (8'2")	2090 (6'10")	8565 (28'1")	2990 (9'10")	5.15 (16'11")	2.25 (7'5")
												8565 (28'1")	3000 (9'10")		2.61 (8'7")
												8565 (28'1")	3100 (10'2")		2.9 (9'6")
PC190LC-8	3275 (10'9")	4065 (13'4")	1055 (3'6")	2435 (8'0")	2490 (8'2")	3030 (9'11")	440 (1'5")	2200 (7'3")	600 (24")	2800 (9'2")	2090 (6'10")	8770 (28'9")	3055 (10'0")	5.35 (17'7")	2.25 (7'5")
												8770 (28'9")	3090 (10'2")		2.6 (8'6")
												8770 (28'9")	3170 (10'5")		2.9 (9'6")
PC190LC-8 (Two-piece boom)	3275 (10'9")	4065 (13'4")	1055 (3'6")	2435 (8'0")	2490 (8'2")	3030 (9'11")	440 (1'5")	2200 (7'3")	600 (24")	2800 (9'2")	2090 (6'10")	8490 (27'10")	2940 (9'8")	5.07 (16'8")	2.25 (7'5")
												8490 (27'10")	2980 (9'9")		2.6 (8'6")
												8480 (27'10")	3030 (9'11")		2.9 (9'6")
PC190NLC-8	3275 (10'9")	4065 (13'4")	1055 (3'6")	2435 (8'0")	2490 (8'2")	3030 (9'11")	440 (1'5")	2040 (6'8")	500 (20")	2540 (8'4")	2090 (6'10")	8770 (28'9")	3055 (10'0")	5.35 (17'7")	2.25 (7'5")
												8770 (28'9")	3090 (10'2")		2.6 (8'6")
												8770 (28'9")	3170 (10'5")		2.9 (9'6")
PC190NLC-8 (Two-piece boom)	3275 (10'9")	4065 (13'4")	1055 (3'6")	2435 (8'0")	2490 (8'2")	3030 (9'11")	440 (1'5")	2040 (6'8")	500 (20")	2540 (8'4")	2090 (6'10")	8490 (27'10")	2940 (9'8")	5.07 (16'8")	2.25 (7'5")
												8490 (27'10")	2980 (9'9")		2.6 (8'6")
												8480 (27'10")	3030 (9'11")		2.9 (9'6")
HB205-1	3275 (10'9")	4070 (13'4")	1085 (3'7")	2750 (9'0")	2710 (8'11")	3040 (10'0")	440 (1'5")	2200 (7'3")	600 (24")	2800 (9'2")	2090 (6'10")	9425 (30'11")	2970 (9'9")	5.7 (18'8")	2.925 (9'7")
HB215LC-1	3655 (12'0")	4450 (14'7")	1085 (3'7")	2750 (9'0")	2710 (8'11")	3040 (10'0")	440 (1'5")	2380 (7'10")	700 (28")	3080 (10'1")	2090 (6'10")	9425 (30'11")	2970 (9'9")	5.7 (18'8")	2.925 (9'7")
HB215LC-1**	3655 (12'0")	4450 (14'7")	1085 (3'7")	2750 (9'0")	2710 (8'11")	3040 (10'0")	440 (1'5")	2380 (7'10")	600 (24")	2980 (9'9")	2095 (6'10")	9425 (30'11")	2970 (9'9")	5.7 (18'8")	2.925 (9'7")

*: USA source

** : UK source

***: China source

*4: India source

*5: Thailand source

*6: Brazil source

*7: Russia source

*8: Indonesia source

*9: for USA

*10: for UK

*11: for Russia

*12: Top of engine cover

*13: When retracted

*14: When expanded

*15: Top of exhaust pipe

*16: with OPG top guard

*17: Include step

*18: Including grouser height

Dimensions

EXCAVATORS (BACKHOE)

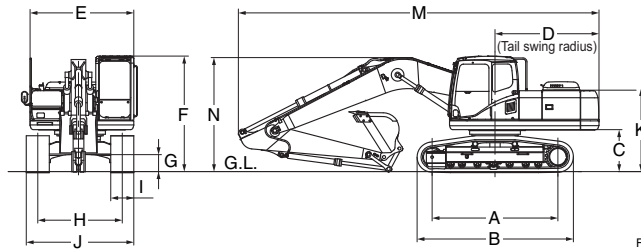

FVBH0313

	A mm (ft.in)	B mm (ft.in)	C mm (ft.in)	D mm (ft.in)	E mm (ft.in)	F mm (ft.in)	G mm (ft.in)	H mm (ft.in)	I mm (in)	J mm (ft.in)	K mm (ft.in)	M mm (ft.in)	N mm (ft.in)	Boom length m (ft.in)	Arm length m (ft.in)
PC200-8 PC200-8M0 PC200-8*** PC200-8*7 PC200-8M0*5	3275 (10'9")	4070 (13'4")	1085 (3'7")	2750 (9'0")	2710 (8'11")	3040 (10'0")	440 (1'5")	2200 (7'3")	600 (24")	2800 (9'2")	2095 (6'10")	9480 (31'1")	2985 (9'10")	5.7 (18'8")	1.84 (6'0")
												9495 (31'2")	3190 (10'6")		2.41 (7'11")
												9425 (30'11")	2970 (9'9")		2.925 (9'7")
PC200-8*8	3275 (10'9")	4070 (13'4")	1085 (3'7")	2750 (9'0")	2710 (8'11")	3040 (10'0")	440 (1'5")	2200 (7'3")	800 (31.5")	3000 (9'10")	2095 (6'10")	9425 (30'11")	2970 (9'9")	5.7 (18'8")	2.925 (9'7")
PC200-8*6	3275 (10'9")	4070 (13'4")	1085 (3'7")	2750 (9'0")	2710 (8'11")	3040 (10'0")	440 (1'5")	2200 (7'3")	700 (28")	2900 (9'6")	2095 (6'10")	9425 (30'11")	3160 (10'4")	5.7 (18'8")	2.41 (7'11")
												9425 (30'11")	2940 (9'8")		2.93 (9'7")
PC200-7	3270 (10'9")	4080 (13'5")	1085 (3'7")	2750 (9'0")	2710 (8'11")	3000 (9'10")	440 (1'5")	2200 (7'3")	600 (24")	2800 (9'2")	2095 (6'10")	9480 (31'1")	2985 (9'10")	5.7 (18'8")	1.84 (6'0")
												9495 (32'2")	3190 (10'6")		2.41 (7'11")
												9425 (30'11")	2970 (9'9")		2.925 (9'7")
PC200LC-8 PC200LC-8M0 PC200LC-8*** PC200LC-8*7 PC200LC-8M0*5	3655 (12'0")	4450 (14'7")	1085 (3'7")	2750 (9'0")	2710 (8'11")	3040 (10'0")	440 (1'5")	2380 (7'10")	700 (28")	3080 (10'1")	2095 (6'10")	9480 (31'1")	2985 (9'10")	5.7 (18'8")	1.84 (6'0")
												9495 (31'2")	3190 (10'6")		2.41 (7'11")
												9425 (30'11")	2970 (9'9")		2.925 (9'7")
PC200LC-8*6	3655 (12'0")	4450 (14'7")	1085 (3'7")	2750 (9'0")	2710 (8'11")	3040 (10'0")	440 (1'5")	2380 (7'10")	800 (31.5")	3180 (10'5")	2095 (6'10")	8990 (59'6")	3040 (10'0")	5.2 (17'1")	2.41 (7'11")
PC210-10**	3275 (10'9")	4080 (13'5")	1085 (3'7")	2940 (9'8")	2850 (9'4")	3045 (10'0")	440 (1'5")	2200 (7'3")	600 (24")	2800 (9'2")	2250 (7'5")	9695 (31'10")	3135 (10'3")	5.7 (18'8")	2.41 (7'11")
												9625 (31'7")	3135 (10'3")		2.93 (9'7")
PC210-8***	3275 (10'9")	4080 (13'5")	1100 (3'7")	2800 (9'2")	2500 (8'2")	3035 (9'11")	440 (1'5")	2200 (7'3")	600 (24")	2800 (9'2")	2110 (6'11")	9540 (31'1")	2985 (9'10")	5.7 (18'8")	1.84 (6'0")
												9555 (31'4")	3190 (10'6")		2.41 (7'11")
												9485 (31'1")	2970 (9'9")		2.925 (9'7")
PC210LC-10*	3655 (12'0")	4450 (14'7")	1085 (3'7")	2940 (9'8")	2850 (9'4")	3045 (10'0")	440 (1'5")	2380 (7'10")	800 (31.5")	3180 (10'5")	2605*12 (8'7")	8990 (59'6")	3040 (10'0")	5.2 (17'1")	2.41 (7'11")
PC210LC-10**	3655 (12'0")	4450 (14'7")	1085 (3'7")	2940 (9'8")	2850 (9'4")	3045 (10'0")	440 (1'5")	2380 (7'10")	600 (24")	2980 (9'9")	2250 (7'5")	9695 (31'10")	3135 (10'3")	5.7 (18'8")	2.41 (7'11")
												9625 (31'7")	3135 (10'3")		2.93 (9'7")
PC210NLC-8**	3655 (12'0")	4450 (14'7")	1100 (3'7")	2800 (9'2")	2500 (8'2")	3035 (9'11")	440 (1'5")	2040 (6'8")	500 (20")	2540 (8'4")	2110 (6'11")	9540 (31'1")	2985 (9'10")	5.7 (18'8")	1.84 (6'0")
												9555 (31'4")	3190 (10'6")		2.41 (7'11")
												9485 (31'1")	2970 (9'9")		2.925 (9'7")
PC210LC-8*4	3655 (12'0")	4450 (14'7")	1100 (3'7")	2800 (9'2")	2500 (8'2")	3035 (9'11")	440 (1'5")	2380 (7'10")	600 (24")	2980 (9'9")	2110 (6'11")	9555 (31'4")	3190 (10'6")	5.7 (18'8")	2.4 (7'10")
												9485 (31'1")	2970 (9'9")		2.9 (9'6")
PC220-8 PC220-8*4 PC220-8M0 PC220-8*	3460 (11'4")	4260 (14'0")	1100 (3'7")	2940 (9'8")	2710 (8'11")	3055 (10'0")	440 (1'5")	2380 (7'10")	600 (24")	2980 (9'9")	2110 (6'11")	9865 (32'4")	3220 (10'7")	5.8 (19'2")	2.00 (6'5")
												9960 (32'8")	3295 (10'10")		2.50 (8'2")
												9885 (32'5")	3185 (10'5")		3.05 (10'0")

*: USA source
 **: UK source
 ***: China source
 *: India source
 *: Thailand source
 *: Brazil source

*7: Russia source
 *8: Indonesia source
 *9: for USA
 *10: for UK
 *11: for Russia
 *12: Top of engine cover

*13: When retracted
 *14: When expanded
 *15: Top of exhaust pipe
 *16: with OPG top guard
 *17: Include step

Dimensions

EXCAVATORS (BACKHOE)

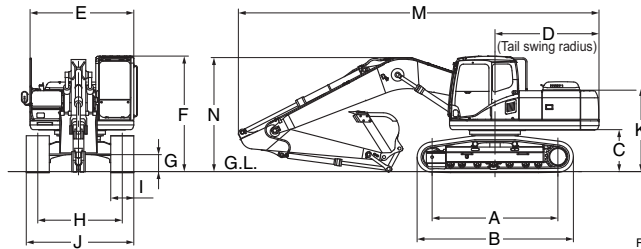

FVBH0313

	A mm (ft.in)	B mm (ft.in)	C mm (ft.in)	D mm (ft.in)	E mm (ft.in)	F mm (ft.in)	G mm (ft.in)	H mm (ft.in)	I mm (in)	J mm (ft.in)	K mm (ft.in)	M mm (ft.in)	N mm (ft.in)	Boom length m (ft.in)	Arm length m (ft.in)
PC220-7	3460 (11'4")	4265 (14'0")	1100 (3'7")	2940 (9'8")	2710 (8'11")	3015 (9'11")	440 (1'5")	2380 (7'10")	600 (24")	2980 (9'9")	2110 (6'11")	9865 (32'4")	3220 (10'7")	5.85 (19'2")	2.0 (6'7")
												9960 (32'8")	3295 (10'10")		2.5 (8'2")
												9885 (32'5")	3160 (10'4")		3.045 (10'0")
PC220LC-8 PC220LC-8M0 PC220LC-8*4	3845 (12'7")	4640 (15'3")	1100 (3'7")	2940 (9'8")	2710 (8'11")	3055 (10'0")	440 (1'5")	2580 (8'6")	700 (28")	3280 (10'9")	2110 (6'11")	9865 (32'4")	3220 (10'7")	5.8 (19'2")	2.0 (6'7")
												9960 (32'8")	3295 (10'10")		2.5 (8'2")
												9885 (32'5")	3185 (10'5")		3.05 (10'0")
PC220LC-7	3845 (12'7")	4640 (15'3")	1100 (3'7")	2940 (9'8")	2710 (8'11")	3015 (9'11")	440 (1'5")	2580 (8'6")	700 (28")	3280 (10'9")	2110 (6'11")	9865 (32'4")	3220 (10'7")	5.85 (19'2")	2.0 (6'7")
												9960 (32'8")	3295 (10'10")		2.5 (8'2")
												9885 (32'4")	3160 (10'4")		3.045 (10'0")
PC228US-8	3275 (10'9")	4070 (13'4")	1060 (3'6")	1680 (5'6")	2980 (9'9")	3050 (10'0")	440 (1'5")	2200 (7'3")	600 (24")	2800 (9'2")	2285 (7'6")	8700 (28'7")	2980 (9'9")	5.7 (18'8")	2.925 (9'7")
PC228USLC-8	3655 (12'0")	4450 (14'7")	1060 (3'6")	1680 (5'6")	2980 (9'9")	3050 (10'0")	440 (1'5")	2380 (7'10")	700 (28")	3080 (10'1")	2285 (7'6")	8890 (29'2")	2980 (9'9")	5.7 (18'8")	2.925 (9'7")
PC228USLC-8*9	3655 (12'0")	4450 (14'7")	1060 (3'6")	1810 (5'11")	2980 (9'9")	3050 (10'0")	440 (1'5")	2380 (7'10")	800 (31.5")	3180 (10'5")	2285 (7'6")	8890 (29'2")	2980 (9'9")	5.7 (18'8")	2.925 (9'7")
PC228USLC-8*10	3275 (10'9")	4070 (13'4")	1060 (3'6")	1680 (5'6")	2980 (9'9")	3050 (10'0")	440 (1'5")	2380 (7'10")	600 (24")	2800 (9'2")	2400*12 (7'10")	8950 (29'4")	3170 (10'5")	5.7 (18'8")	2.40 (7'10")
												8890 (29'2")	2980 (9'9")		2.9 (9'7")
PC230NHD-8	3460 (11'4")	4305 (14'1")	1125 (3'8")	2800 (9'2")	2500 (8'2")	3060 (10'0")	465 (1'6")	1990 (6'6")	550 (22")	2540 (8'4")	2135 (7'0")	9540 (31'4")	2985 (9'10")	5.7 (18'8")	1.8 (5'11")
												9555 (31'4")	3190 (10'6")		2.4 (7'10")
												9485 (31'1")	2970 (9'9")		2.9 (9'6")
PC240LC-10*	3845 (12'7")	4640 (15'3")	1100 (3'7")	2940 (9'8")	2850 (9'4")	3055 (10'0")	440 (1'5")	2580 (8'6")	800 (31.5")	3380 (11'1")	2265 (7'5")	9885 (32'5")	3185 (10'5")	5.85 (19'8")	3.045 (10'0")
												9910 (32'6")	3270 (10'9")		3.5 (11'6")
PC240LC-10**	3845 (12'7")	4640 (15'3")	1100 (3'7")	2940 (9'8")	2850 (9'4")	3055 (10'0")	440 (1'5")	2590 (8'6")	700 (28")	3290 (10'10")	2265 (7'5")	9865 (32'4")	3220 (10'7")	5.85 (19'8")	2.0 (6'7")
												9960 (32'8")	3295 (10'10")		2.5 (8'2")
												9885 (32'5")	3160 (10'4")		3.0 (10'0")
												9910 (32'6")	3270 (10'9")		3.5 (11'6")
PC240NLC-10**	3655 (12'0")	4450 (14'7")	1100 (3'7")	2940 (9'8")	2850 (9'4")	3055 (10'0")	440 (1'5")	2390 (7'10")	600 (24")	2990 (9'10")	2265 (7'5")	9865 (32'4")	3220 (10'7")	5.85 (19'8")	2.0 (6'7")
												9960 (32'8")	3295 (10'10")		2.5 (8'2")
												9885 (32'5")	3160 (10'4")		3.0 (10'0")
												9910 (32'6")	3270 (10'9")		3.5 (11'6")
PC240LC-8***	3845 (12'7")	4640 (15'3")	1100 (3'7")	2940 (9'8")	2710 (8'11")	3055 (10'0")	440 (1'5")	2580 (8'6")	600 (24")	3180 (10'5")	2110 (6'11")	9885 (32'5")	3185 (10'5")	5.8 (19'2")	3.05 (10'0")

*: USA source
 **: UK source
 ***: China source
 *4: India source
 *5: Thailand source
 *6: Brazil source

*7: Russia source
 *8: Indonesia source
 *9: for USA
 *10: for UK
 *11: for Russia
 *12: Top of engine cover

*13: When retracted
 *14: When expanded
 *15: Top of exhaust pipe
 *16: with OPG top guard
 *17: Include step

Dimensions

EXCAVATORS (BACKHOE)

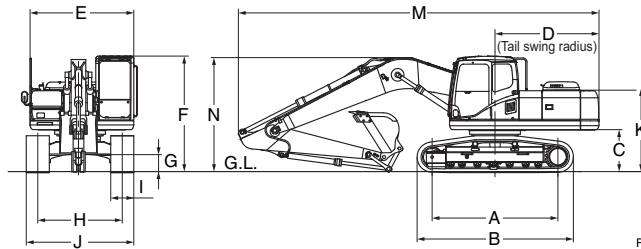

FVBH0313

	A mm (ft.in)	B mm (ft.in)	C mm (ft.in)	D mm (ft.in)	E mm (ft.in)	F mm (ft.in)	G mm (ft.in)	H mm (ft.in)	I mm (in)	J mm (ft.in)	K mm (ft.in)	M mm (ft.in)	N mm (ft.in)	Boom length m (ft.in)	Arm length m (ft.in)
PC240LC-8*6	3845 (12'7")	4640 (15'3")	1100 (3'7")	2940 (9'8")	2710 (8'11")	3055 (10'0")	440 (1'5")	2580 (8'6")	600 (24")	3180 (10'5")	2110 (6'11")	9865 (32'4")	3220 (10'7")	5.8 (19'2")	2.00 (6'7")
												9960 (32'8")	3295 (10'10")		2.5 (8'2")
												9885 (32'5")	3185 (10'5")		3.0 (10'0")
PC270-8	3700 (12'2")	4625 (15'2")	1215 (4'0")	2940 (9'8")	2710 (8'11")	3175 (10'5")	498 (1'8")	2590 (8'6")	600 (24")	3190 (10'6")	2225 (7'4")	9940 (32'7")	3310 (10'10")	5.9 (19'2")	2.50 (8'2")
												9860 (32'4")	3200 (10'6")		3.05 (10'0")
												9890 (32'5")	3280 (10'9")		3.5 (11'6")
PC270-7***	3700 (12'2")	4625 (15'2")	1186 (3'11")	2940 (9'8")	2710 (8'11")	3100 (10'2")	498 (1'8")	2590 (8'6")	600 (24")	3190 (10'6")	2200 (7'3")	9790 (32'1")	3210 (10'6")	5.85 (19'2")	3.05 (10'0")
PC270LC-8	4030 (13'3")	4955 (16'2")	1215 (4'0")	2940 (9'8")	2710 (8'11")	3180 (10'5")	498 (1'8")	2590 (8'6")	700 (28")	3290 (10'10")	2225 (7'4")	9940 (32'7")	3310 (10'10")	5.9 (19'2")	2.50 (8'2")
												9860 (32'4")	3205 (10'6")		3.05 (10'0")
												9890 (32'5")	3280 (10'9")		3.5 (11'6")
PC290LC-10*	4030 (13'3")	4955 (16'3")	1215 (4'0")	2940 (9'8")	2850 (9'4")	3180 (10'5")	498 (1'8")	2590 (8'6")	800 (31.5")	3390 (11'1")	2380 (7'10")	10185 (33'5")	3340 (11'0")	6.15 (20'2")	3.2 (10'6")
												10195 (33'5")	3375 (11'1")		3.5 (11'6")
PC290LC-10**	4030 (13'3")	4955 (16'3")	1215 (4'0")	2940 (9'8")	2850 (9'4")	3180 (10'5")	500 (1'8")	2590 (8'6")	700 (28")	3290 (10'10")	2380 (7'10")	10080 (33'5")	3160 (11'0")	6.15 (20'2")	2.0 (6'7")
												10240 (33'7")	3425 (11'3")		2.65 (8'8")
												10185 (33'5")	3340 (11'0")		3.2 (10'6")
												10195 (33'5")	3375 (11'1")		3.5 (11'6")
PC290NLC-10**	4030 (13'3")	4955 (16'3")	1215 (4'0")	2940 (9'8")	2850 (9'4")	3180 (10'5")	500 (1'8")	2390 (7'10")	600 (24")	2990 (10'10")	2380 (7'10")	10080 (33'5")	3160 (11'0")	6.15 (20'2")	2.0 (6'7")
												10240 (33'7")	3425 (11'3")		2.65 (8'8")
												10185 (33'5")	3340 (11'0")		3.2 (10'6")
												10195 (33'5")	3375 (11'1")		3.5 (11'6")
PC300-8 PC300-8*5 PC300-8*7	3700 (12'2")	4625 (15'2")	1185 (3'11")	3450 (11'4")	3090 (10'2")	3145 (10'4")	500 (1'8")	2590 (8'6")	600 (24")	3190 (10'6")	2585*12 (8'6")	11300 (37'1")	3480 (11'5")	6.47 (21'3")	2.22 (7'3")
												11180 (36'8")	3450 (11'4")		2.55 (8'4")
												11140 (36'7")	3285 (10'9")		3.185 (10'5")
												11170 (36'8")	3760 (12'4")		4.02 (13'2")
PC300-8*8 PC300-8*8 (SE spec.)	3700 (12'2")	4625 (15'2")	1185 (3'11")	3450 (11'4")	3090 (10'2")	3145 (10'4")	500 (1'8")	2590 (8'6")	800 (31.5")	3390 (11'1")	2585*12 (8'6")	11300 (37'1")	3480 (11'5")	6.47 (21'3")	2.22 (7'3")
												11180 (36'8")	3450 (11'4")		2.55 (8'4")
												11140 (36'7")	3285 (10'9")		3.185 (10'5")

*: USA source
 **: UK source
 ***: China source
 *: India source
 *: Thailand source
 *: Brazil source

*7: Russia source
 *8: Indonesia source
 *9: for USA
 *10: for UK
 *11: for Russia
 *12: Top of engine cover

*13: When retracted
 *14: When expanded
 *15: Top of exhaust pipe
 *16: with OPG top guard
 *17: Include step

Dimensions

EXCAVATORS (BACKHOE)

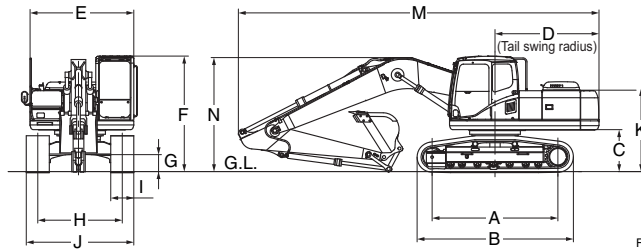

FVBH0313

	A mm (ft.in)	B mm (ft.in)	C mm (ft.in)	D mm (ft.in)	E mm (ft.in)	F mm (ft.in)	G mm (ft.in)	H mm (ft.in)	I mm (in)	J mm (ft.in)	K mm (ft.in)	M mm (ft.in)	N mm (ft.in)	Boom length m (ft.in)	Arm length m (ft.in)
PC300-7 PC300-7*** PC360-7***	3700 (12'2")	4625 (15'2")	1185 (3'11")	3450 (11'4")	2995 (9'10")	3130 (10'3")	500 (1'8")	2590 (8'6")	600 (24")	3190 (10'6")	2580*12 (8'6")	11290 (37'1")	3400 (11'2")	6.47 (21'3")	2.22 (7'3")
												11180 (36'8")	3410 (11'2")		2.55 (8'4")
												11140 (36'7")	3285 (10'9")		3.185 (10'5")
												11170 (36'8")	3760 (12'4")		4.02 (13'2")
PC300LC-8 PC300LC-8*7	4030 (13'3")	4955 (16'3")	1185 (3'11")	3450 (11'4")	3090 (10'2")	3145 (10'4")	500 (1'8")	2590 (8'6")	700 (28")	3290 (10'10")	2585*12 (8'6")	11300 (37'1")	3480 (11'5")	6.47 (21'3")	2.22 (7'3")
												11180 (36'8")	3450 (11'4")		2.55 (8'4")
												11140 (36'7")	3285 (10'9")		3.185 (10'5")
												11170 (36'8")	3760 (12'4")		4.02 (13'2")
PC300LC-8*8 PC300LC-8*8 (SE spec.)	4030 (13'3")	4955 (16'3")	1185 (3'11")	3450 (11'4")	3090 (10'2")	3145 (10'4")	500 (1'8")	2590 (8'6")	800 (31.5")	3390 (11'2")	2585*12 (8'6")	11300 (37'1")	3480 (11'5")	6.47 (21'3")	2.22 (7'3")
												11180 (36'8")	3450 (11'4")		2.55 (8'4")
												11140 (36'7")	3285 (10'9")		3.185 (10'5")
												11170 (36'8")	3760 (12'4")		4.02 (13'2")
PC300LC-7*4	4030 (13'3")	4955 (16'3")	1185 (3'11")	3450 (11'4")	2995 (9'10")	3130 (10'3")	500 (1'8")	2590 (8'6")	600 (24")	3190 (10'6")	2585*12 (8'6")	11290 (37'1")	3400 (11'2")	6.47 (21'3")	2.22 (7'3")
PC350-8	3700 (12'2")	4625 (15'2")	1185 (3'11")	3450 (11'4")	3165 (10'5")	3145 (10'4")	500 (1'8")	2590 (8'6")	600 (24")	3190 (10'6")	2585*12 (8'6")	11140 (36'7")	3285 (10'9")	6.5 (21'3")	3.185 (10'5")
PC350-7	3700 (12'2")	4625 (15'2")	1185 (3'11")	3450 (11'4")	3145 (10'4")	3130 (10'3")	500 (1'8")	2590 (8'6")	600 (24")	3190 (10'6")	2580*12 (8'6")	11140 (36'7")	3285 (10'9")	6.47 (21'3")	3.185 (10'5")
PC350LC-8	4030 (13'3")	4955 (16'3")	1186 (3'11")	3450 (11'4")	2995 (9'10")	3100 (10'2")	498 (1'8")	2590 (8'6")	700 (28")	3290 (10'10")	2580*12 (8'6")	11290 (37'1")	3400 (11'2")	6.5 (21'3")	2.2 (7'3")
												11180 (36'8")	3410 (11'2")		2.6 (8'6")
												11140 (36'7")	3280 (10'9")		3.2 (10'6")
												11170 (36'8")	3760 (12'4")		4.0 (13'1")
PC350LC-8	4030 (13'3")	4955 (16'3")	1186 (3'11")	3450 (11'4")	2995 (9'10")	3100 (10'2")	498 (1'8")	2390 (7'10")	600 (24")	2990 (9'10")	2580*12 (8'6")	11290 (37'1")	3400 (11'2")	6.5 (21'3")	2.22 (7'3")
												11180 (36'8")	3410 (11'2")		2.55 (8'4")
												11140 (36'7")	3280 (10'9")		3.185 (10'5")
												11170 (36'8")	3760 (12'4")		4.02 (13'2")
PC350LC-8*6	4030 (13'3")	4955 (16'3")	1185 (3'11")	3450 (11'4")	3165 (10'5")	3130 (10'3")	500 (1'8")	2590 (8'6")	600 (24")	3190 (10'6")	2585*12 (8'6")	11310 (37'1")	3480 (11'5")	6.47 (21'3")	2.22 (7'3")
												11190 (36'9")	3295 (10'10")		2.55 (8'4")
												11150 (36'7")	3285 (10'9")		3.185 (10'5")
												11180 (36'8")	3760 (12'4")		4.02 (13'2")

*: USA source
 **: UK source
 ***: China source
 *4: India source
 *5: Thailand source
 *6: Brazil source

*7: Russia source
 *8: Indonesia source
 *9: for USA
 *10: for UK
 *11: for Russia
 *12: Top of engine cover

*13: When retracted
 *14: When expanded
 *15: Top of exhaust pipe
 *16: with OPG top guard
 *17: Include step

Dimensions

EXCAVATORS (BACKHOE)

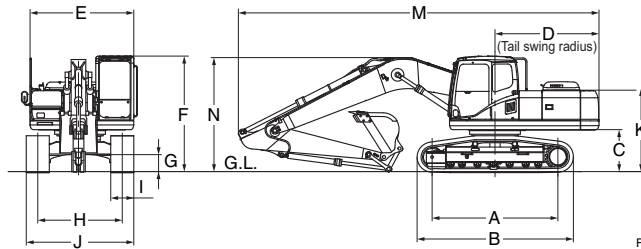

FVBH0313

	A mm (ft.in)	B mm (ft.in)	C mm (ft.in)	D mm (ft.in)	E mm (ft.in)	F mm (ft.in)	G mm (ft.in)	H mm (ft.in)	I mm (in)	J mm (ft.in)	K mm (ft.in)	M mm (ft.in)	N mm (ft.in)	Boom length m (ft.in)	Arm length m (ft.in)
PC360LC-10*	4030 (13'3")	4955 (16'3")	1185 (3'11")	3445 (11'4")	3145 (10'4")	3160 (10'4")	498 (1'8")	2590 (8'6")	800 (31.5")	3390 (11'1")	2750*12 (9'0")	11180	3410	6.5 (21'3")	2.54
												(36'8")	(11'2")		3.185
												11145	3285		3.185
												(36'7")	(10'9")		(10'5")
PC360LC-10**	4030 (13'3")	4955 (16'3")	1185 (3'11")	3445 (11'4")	2995 (9'10")	3160 (10'4")	500 (1'8")	2590 (8'6")	700 (28")	3290 (10'10")	2360 (7'9")	11290	3400	6.5 (21'3")	2.2
												(37'1")	(11'2")		(7'3")
												11180	3410		2.6
												(36'8")	(11'2")		(8'6")
PC360NLC-10**	4030 (13'3")	4955 (16'3")	1185 (3'11")	3445 (11'4")	2995 (9'10")	3160 (10'4")	500 (1'8")	2390 (7'10")	600 (24")	2990 (9'10")	2360 (7'9")	11140	3280	6.5 (21'3")	3.2
												(36'7")	(10'9")		(10'6")
												11170	3760		4.0
												(36'8")	(12'4")		(13'1")
PC390LC-10*	4350 (14'3")	5355 (17'7")	1320 (4'4")	3445 (11'4")	3145 (10'4")	3230 (10'7")	550 (1'10")	2740 (9'0")	800 (31.5")	3540 (11'7")	2858*12 (9'5")	11130	3245	6.5 (21'3")	2.54
												(36'6")	(10'8")		(8'4")
												11170	3420		3.185
												(36'8")	(11'3")		(10'5")
PC400-8 PC400-8R	4020 (13'2")	5055 (16'7")	1320 (4'4")	3645 (12'0")	3090 (10'2")	3285 (10'9")	555 (1'10")	2740 (9'0")	600 (24")	3340 (11'0")	2885*12 (9'6")	11230	3690	7.1 (23'2")	4.02
												(36'10")	(12'1")		(13'2")
												11905	3850		2.4
												(39'1")	(12'8")		(7'10")
PC400-8***	4020 (13'2")	5055 (16'7")	1320 (4'4")	3645 (12'0")	2995 (9'10")	3285 (10'9")	567 (1'10")	2740 (9')	600 (24")	3340 (11')	2920*12 (9'7")	11995	3745	7.06 (23'2")	2.9
												(39'4")	(12'3")		(9'6")
												11940	3635		3.38
												(39'2")	(11'11")		(11'1")
PC400-8*8 PC400-8R*8 (SE spec)	4020 (13'2")	5055 (16'7")	1320 (4'4")	3645 (12'0")	3090 (10'2")	3285 (10'9")	555 (1'10")	2740 (9')	600 (24")	3340 (11')	2920*12 (9'7")	11950	3885	7.06 (23'2")	4.0
												(39'2")	(12'9")		(13'1")
												11905	3850		2.4
												(39'1")	(12'8")		(7'10")
PC400-7 PC400-7*7	4020 (13'2")	5055 (16'7")	1320 (4'4")	3645 (12'0")	2995 (9'10")	3265 (10'9")	555 (1'10")	2740 (9')	600 (24")	3340 (11')	2715*12 (8'11")	11995	3745	7.06 (23'2")	2.9
												(39'4")	(12'3")		(9'6")
												11940	3635		3.38
												(39'2")	(12'0")		(11'1")
PC400-7*7	4020 (13'2")	5055 (16'7")	1320 (4'4")	3645 (12'0")	2995 (9'10")	3265 (10'9")	555 (1'10")	2740 (9')	600 (24")	3340 (11')	2715*12 (8'11")	11950	3885	7.06 (23'2")	4.0
												(39'2")	(12'9")		(13'1")
												11905	3850		2.4
												(39'1")	(12'8")		(7'10")

*: USA source
 **: UK source
 ***: China source
 *4: India source
 *5: Thailand source
 *6: Brazil source

*7: Russia source
 *8: Indonesia source
 *9: for USA
 *10: for UK
 *11: for Russia
 *12: Top of engine cover

*13: When retracted
 *14: When expanded
 *15: Top of exhaust pipe
 *16: with OPG top guard
 *17: Include step

Dimensions

EXCAVATORS (BACKHOE)

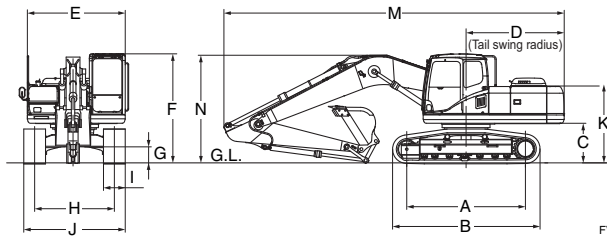

FVBH0313

	A mm (ft.in)	B mm (ft.in)	C mm (ft.in)	D mm (ft.in)	E mm (ft.in)	F mm (ft.in)	G mm (ft.in)	H mm (ft.in)	I mm (in)	J mm (ft.in)	K mm (ft.in)	M mm (ft.in)	N mm (ft.in)	Boom length m (ft.in)	Arm length m (ft.in)											
PC400LC-8 PC400LC-8R	4350 (14'3")	5385 (17'8")	1320 (4'4")	3645 (12'0")	3090 (10'2")	3285 (10'9")	550 (1'10")	2740 (9'0")	700 (28")	3440 (11'3")	2920*12 (9'7")	11905 (39'1")	3850 (12'8")	7.1 (23'2")	2.4 (7'10")											
												11995 (39'4")	3745 (12'3")		2.9 (9'6")											
												11940 (39'2")	3635 (11'11")		3.38 (11'1")											
												11950 (39'2")	3885 (12'9")		4.0 (13'1")											
PC400LC-8*8 PC400LC-8R*8 (SE spec)	4350 (14'3")	5385 (17'8")	1320 (4'4")	3645 (12'0")	3090 (10'2")	3285 (10'9")	550 (1'10")	2740 (9'0")	800 (31.5")	3540 (11'6")	2920*12 (9'7")	11905 (39'1")	3850 (12'8")	7.1 (23'2")	2.4 (7'10")											
												11995 (39'4")	3745 (12'3")		2.9 (9'6")											
												11940 (39'2")	3635 (11'11")		3.38 (11'1")											
												11950 (39'2")	3885 (12'9")		4.0 (13'1")											
PC400LC-7 PC400LC-7*7	4350 (14'3")	5385 (17'8")	1320 (4'4")	3645 (12'0")	2995 (9'10")	3265 (10'9")	550 (1'10")	2740 (9')	700 (28")	3440 (11'3")	2715*12 (8'11")	11905 (39'1")	3850 (12'8")	7.06 (23'2")	2.4 (7'10")											
												11995 (39'4")	3745 (12'3")		2.9 (9'6")											
												11940 (39'2")	3635 (11'11")		3.38 (11'1")											
												11950 (39'2")	3885 (12'9")		4.0 (13'1")											
PC450-8 PC450-8R	4020 (13'2")	5055 (16'7")	1320 (4'4")	3645 (12'0")	3165 (10'5")	3265 (10'9")	555 (1'10")	2740 (9'0")	600 (24")	3340 (11'0")	2920*12 (9'7")	12040 (39'6")	3660 (12'0")	7.1 (23'2")	3.38 (11'1")											
PC450-8***	4020 (13'2")	5055 (16'7")	1320 (4'4")	3645 (12'0")	3165 (10'4")	3285 (10'9")	685 (2'3")	2890 (9'6")	600 (24")	3490 (11'5")	2920*12 (9'7")	12040 (39'6")	3660 (12'0")	7.06 (23'2")	3.38 (11'1")											
PC450-7	4020 (13'2")	5055 (16'7")	1320 (4'4")	3645 (12'0")	3145 (10'4")	3265 (10'9")	555 (1'10")	2740 (9')	600 (24")	3340 (11')	2715*12 (8'11")	12040 (39'6")	3660 (12'0")	7.06 (23'2")	3.38 (11'1")											
PC450LC-8 PC450LC-8R	4350 (14'3")	5385 (17'8")	1320 (4'4")	3645 (12'0")	3145 (10'4")	3265 (10'9")	550 (1'10")	2740 (9'0")	600 (24")	3340 (11'0")	2885*12 (9'6")	12040 (39'6")	3660 (12'0")	7.1 (23'2")	3380 (11'1")											
PC490LC-10*	4350 (14'3")	5385 (17'8")	1385 (4'7")	3645 (12'0")	3145 (10'4")	3360 (11'0")	550 (1'10")	2740 (9'0")	700 (28")	3440 (11'3")	3105*12 (10'2")	11995 (39'4")	3745 (12'3")	7.0 (23'2")	2.9 (9'6")											
												11930 (39'2")	3635 (11'11")		3.38 (11'1")											
												11950 (39'2")	3885 (12'9")		4.0 (13'1")											
												11795 (38'8")	4435 (14'7")		4.8 (15'9")											
PC490-10**	4020 (13'2")	5055 (16'7")	1385 (4'7")	3645 (12'0")	2995 (9'10")	3360 (11'0")	700 (2'4")	2890 (9'6")	600 (24")	3490 (11'5")	2490 (8'2")	11470 (37'8")	3630 (11'11")	6.7 (22'0")	2.4 (7'10")											
												11570 (38'0")	3710 (12'2")		2.9 (9'6")											
												11910 (39'1")	3875 (12'9")		2.4 (7'10")											
																							12000 (39'4")	3760 (12'4")	7.1 (23'4")	2.9 (9'6")
																							11930 (39'2")	3635 (11'11")		3.4 (11'2")
																							11950 (39'2")	3885 (12'9")		4.0 (13'1")
																							11825 (39'0")	4435 (14'7")		4.8 (15'9")

*: USA source
 **: UK source
 ***: China source
 *4: India source
 *5: Thailand source
 *6: Brazil source

*7: Russia source
 *8: Indonesia source
 *9: for USA
 *10: for UK
 *11: for Russia
 *12: Top of engine cover

*13: When retracted
 *14: When expanded
 *15: Top of exhaust pipe
 *16: with OPG top guard
 *17: Include step

Dimensions

EXCAVATORS (BACKHOE)

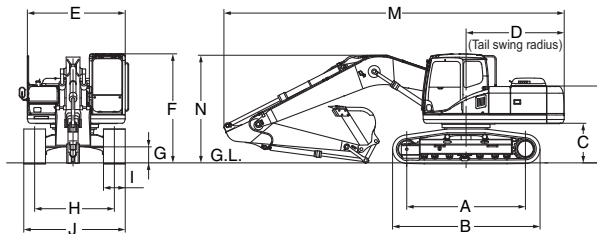

FVBH0313

	A mm (ft.in)	B mm (ft.in)	C mm (ft.in)	D mm (ft.in)	E mm (ft.in)	F mm (ft.in)	G mm (ft.in)	H mm (ft.in)	I mm (in)	J mm (ft.in)	K mm (ft.in)	M mm (ft.in)	N mm (ft.in)	Boom length m (ft.in)	Arm length m (ft.in)			
PC490LC-10**	4350 (14'3")	5385 (17'8")	1385 (4'7")	3645 (12'0")	2995 (9'10")	3360 (11'0")	700 (2'4")	2890 (9'6")	700 (28")	3590 (11'9") 3090*13 (10'2")	2490 (8'2")	11470 (37'8")	3630 (11'11")	6.7 (22'0")	2.4 (7'10")			
												11570 (38'0")	3710 (12'2")		2.9 (9'6")			
												11910 (39'2")	3875 (12'9")	7.0 (23'2")	2.4 (7'10")			
												12000 (39'4")	3760 (12'4")		2.9 (9'6")			
												11930 (39'2")	3635 (11'11")		3.4 (11'2")			
												11950 (39'2")	3885 (12'9")		4.0 (13'1")			
												11825 (38'10")	4435 (14'7")		4.8 (15'9")			
PC550LC-8	4250 (13'11")	5340 (17'6")	1480 (4'10")	3645 (12'0")	3070 (10'1")	3445 (11'4")	780 (2'7")	2340 (7'8") 2890*14 (9'6")	600 (24")	3490 (11'5")	3050*12 (10'0")	11635 (38'2")	3720 (12'2")	6.67 (21'11")	2.4 (7'10")			
PC600-8E0 PC600-8R1	4250 (13'11")	5340 (17'6")	1365 (4'6")	3950 (13'0")	3170 (10'5")	3290 (10'10")	780 (2'7")	2590 (8'6")	600 (24")	3190 (10'6")	3435*15 (11'3")	12910 (42'4")	4300 (14'1")	7.7 (25'2")	3.5 (11'6")			
												12830 (42'1")	4655 (15'3")		4.3 (14'1")			
												12535 (41'2")	5235 (17'2")		5.2 (17'1")			
												12540 (41'2")	4280 (14'1")		3.5 (11'6")			
												11930 (39'2")	4600 (15'1")		2.9 (9'6")			
PC600-8**	4250 (13'11")	5340 (17'6")	1365 (4'6")	3800 (12'6")	3195 (10'6")	3290 (10'10")	780 (2'7")	2590 (8'6")	600 (24")	3190 (10'6")	3435*15 (11'3")	12440 (40'10")	4280 (14'1")	7.3 (23'11")	3.5 (11'6")			
												11830 (38'10")	4600 (15'1")	6.6 (21'8")	2.9 (9'6")			
PC600-7*11	4250 (13'11")	5340 (17'6")	1365 (4'6")	3800 (12'6")	3195 (10'6")	3290 (10'10")	780 (2'7")	2590 (8'6")	600 (24")	3190 (10'6")	3435*15 (11'3")	12810 (42'0")	4300 (14'1")	7.66 (25'2")	3.5 (11'6")			
															12440 (40'10")	4280 (14'1")	7.3 (23'11")	3.5 (11'6")
															12730 (41'9")	4655 (15'3")	7.66 (25'2")	4.3 (14'1")
															12435 (40'10")	5235 (17'2")	5.2 (17'1")	
															12910 (42'4")	4300 (14'1")	3.5 (11'6")	
PC600LC-8E0 PC600LC-8R1	4600 (15'1")	5690 (18'8")	1365 (4'6")	3900 (12'10")	3195 (10'6")	3290 (10'10")	780 (2'7")	2590 (8'6")	600 (24")	3190 (10'6")	3435*15 (11'3")	12535 (41'2")	5235 (17'2")	7.66 (25'2")	4.3 (14'1")			
															12830 (42'1")	4655 (15'3")	5.2 (17'1")	
															12540 (41'2")	4280 (14'1")	3.5 (11'6")	
															11930 (39'2")	4600 (15'1")	2.9 (9'6")	
															12910 (42'4")	4300 (14'1")	3.5 (11'6")	
PC700LC-8**	4600 (15'1")	5690 (18'8")	1365 (4'6")	3800 (12'6")	3195 (10'6")	3290 (10'10")	780 (2'7")	2590 (8'6")	600 (24")	3190 (10'6")	3435*15 (11'3")	12810 (42'0")	4300 (14'1")	7.66 (25'2")	3.5 (11'6")			
															3900*14 (12'10")	3.5 (11'6")		

*: USA source
 **: UK source
 ***: China source
 *4: India source
 *5: Thailand source
 *6: Brazil source

*7: Russia source
 *8: Indonesia source
 *9: for USA
 *10: for UK
 *11: for Russia
 *12: Top of engine cover

*13: When retracted
 *14: When expanded
 *15: Top of exhaust pipe
 *16: with OPG top guard
 *17: Include step

Dimensions

EXCAVATORS (BACKHOE)

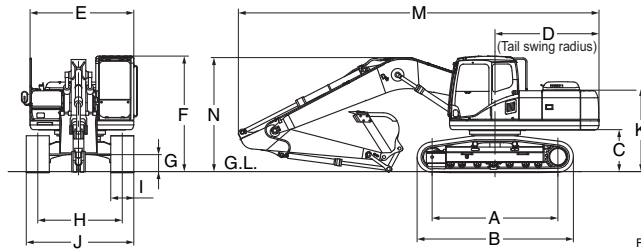

FVBH0313

	A mm (ft.in)	B mm (ft.in)	C mm (ft.in)	D mm (ft.in)	E mm (ft.in)	F mm (ft.in)	G mm (ft.in)	H mm (ft.in)	I mm (in)	J mm (ft.in)	K mm (ft.in)	M mm (ft.in)	N mm (ft.in)	Boom length m (ft.in)	Arm length m (ft.in)	
PC600LC-7*11	4600 (15'1")	5690 (18'8")	1365 (4'6")	3800 (12'6")	3195 (10'6")	3290 (10'10")	780 (2'7")	2590 (8'6")	600 (24")	3190 (10'6")	3435*15 (11'3")	11830 (38'10")	4600 (15'1")	6.6 (21'8")	2.9 (9'6")	
								3300*14 (10'10")		3900*14 (12'10")		12440 (40'10")	4280 (14'1")	7.3 (23'11")	3.5 (11'6")	
												12810 (42'0")	4300 (14'1")		3.5 (11'6")	
												12730 (41'9")	4655 (15'3")	7.66 (25'2")	4.3 (14'1")	
												12435 (40'10")	5235 (17'2")		5.2 (17'1")	
PC650LC-8E0*9	4600 (15'1")	5690 (18'8")	1365 (4'6")	3950 (13'0")	3170 (10'5")	3290 (10'10")	780 (2'7")	2590 (8'6")	900 (35.5")	3490 (11'6")	3435*15 (11'3")	12960 (42'6")	4300 (14'1")	7.66 (25'2")	3.5 (11'6")	
								3300*14 (10'10")		4200*14 (13'10")		12880 (42'3")	4655 (15'3")		4.3 (14'1")	
												12585 (41'3")	5235 (17'2")		5.2 (17'1")	
PC650LC-8R***	4600 (15'1")	5690 (18'8")	1365 (4'6")	3950 (13'0")	3170 (10'5")	3290 (10'10")	780 (2'7")	3300 (10'10")	600 (24")	3190 (10'6")	3435*15 (11'3")	12540 (41'2")	4280 (14'1")	7.3 (23'11")	3.5 (11'6")	
PC700LC-8E0**	4500 (14'9")	5810 (19'1")	1550 (5'1")	3950 (13'0")	3170 (10'5")	3595*16 (11'10")	830 (2'9")	3300 (10'10")	610 (24")	3910 (12'10")	3620*15 (11'11")	11990 (39'4")	4670 (15'4")	6.6 (21'8")	2.9 (9'6")	
						3475 (11'5")							12960 (42'6")	4280 (14'1")	7.3 (23'11")	3.5 (11'6")
													12540 (41'2")	4350 (14'3")	7.6 (24'11")	3.5 (11'6")
PC700LC-8E0 PC700LC-8R	4500 (14'9")	5810 (19'1")	1550 (5'1")	3950 (13'0")	3170 (10'5")	3475 (11'5")	830 (2'9")	2590 (8'6")	610 (24")	3190 (10'6")	3620*15 (11'11")	12960 (42'6")	4350 (14'3")	7.66 (25'2")	3.5 (11'6")	
												12930 (42'5")	4690 (15'5")		4.3 (14'1")	
												12700 (41'8")	5230 (17'2")		5.2 (17'1")	
												12580 (41'3")	4280 (14'1")	7.3 (23'11")	3.5 (11'6")	
		11990 (39'4")	4670 (15'4")	6.6 (21'8")	2.9 (9'6")											
PC700LC-8E0***	4500 (14'9")	5810 (19'1")	1550 (5'1")	3950 (13'0")	3170 (10'5")	3595*16 (11'10")	830 (2'9")	2590 (8'6")	610 (24")	3190 (10'6")	3620*15 (11'11")	11990 (39'4")	4670 (15'4")	6.6 (21'8")	2.9 (9'6")	
PC800-8E0 PC800-8R1	4500 (14'9")	5810 (19'1")	1560 (5'1")	4400 (14'5")	3195 (10'6")	3570 (11'9")	840 (2'9")	3500 (11'6")	610 (24")	4110 (13'6")	3670*12 (12')	14405 (47'3")	4690 (15'5")	8.2 (26'11")	3.6 (11'10")	
								3390*13 (11'1")					14435 (47'4")		5630 (18'6")	4.6 (15'1")
													14115 (46'4")		6260 (20'6")	5.6 (18'4")
PC800-8E0 (SE spec) PC800-8R1 (SE spec)	4500 (14'9")	5810 (19'1")	1560 (5'1")	4400 (14'5")	3195 (10'6")	3570 (11'9")	840 (2'9")	3500 (11'6")	610 (24")	4110 (13'6")	3670*12 (12')	13130 (43'1")	4615 (15'2")	7.1 (26'11")	2.945 (9'8")	
PC800-8E0**	4500 (14'9")	5810 (19'1")	1560 (5'1")	4400 (14'5")	3265 (10'9")	3720 (12'2")	840 (2'7")	3500 (11'6")	610 (24")	4110 (13'6")	3665*12 (12')	13995 (45'1")	4850 (15'1")	8.0 (26'3")	3.6 (11'10")	
								3390*13 (11'1")				13130 (43'9")	4615 (15'2")	7.1 (23'4")	2.9 (9'6")	

*: USA source
 **: UK source
 ***: China source
 *4: India source
 *5: Thailand source
 *6: Brazil source

*7: Russia source
 *8: Indonesia source
 *9: for USA
 *10: for UK
 *11: for Russia
 *12: Top of engine cover

*13: When retracted
 *14: When expanded
 *15: Top of exhaust pipe
 *16: with OPG top guard
 *17: Include step

Dimensions

EXCAVATORS (BACKHOE)

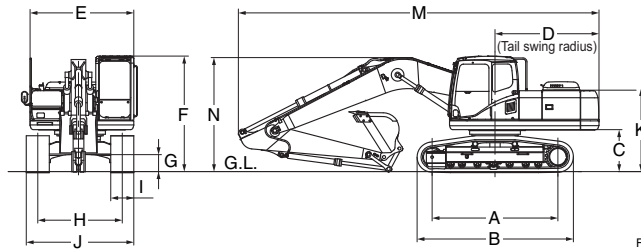

FVBH0313

	A mm (ft.in)	B mm (ft.in)	C mm (ft.in)	D mm (ft.in)	E mm (ft.in)	F mm (ft.in)	G mm (ft.in)	H mm (ft.in)	I mm (in)	J mm (ft.in)	K mm (ft.in)	M mm (ft.in)	N mm (ft.in)	Boom length m (ft.in)	Arm length m (ft.in)
PC750-7*11	4500 (14'9")	5810 (19'1")	1560 (5'1")	4300 (14'1")	3195 (10'6")	3560 (11'8")	840 (2'9")	3500 (11'6")	610 (24")	4110 (13'6")	3445*12 (11'4")	14305 (46'11")	4660 (15'3")	8.2 (26'11")	3.6 (11'10")
												13955 (45'9")	5970 (19'7")		4.6 (15'1")
												13530 (44'5")	6560 (21'6")		5.6 (18'4")
PC750-7*11 (SE spec)	4500 (14'9")	5810 (19'1")	1560 (5'1")	4300 (14'1")	3195 (10'6")	3640 (11'11")	840 (2'9")	3500 (11'6")	610 (24")	4110 (13'6")	3445*12 (11'4")	13130 (43'1")	4615 (15'2")	7.1 (23'4")	2.945 (9'8")
PC800LC-8E0 PC800LC-8R1	5020 (16'6")	6330 (20'9")	1560 (5'1")	4400 (14'5")	3195 (10'6")	3570 (11'9")	840 (2'9")	3500 (11'6")	810 (32")	4310 (14'2")	3670*12 (12'0")	14405 (47'3")	4690 (15'5")	8.2 (26'11")	3.6 (11'10")
												14435 (47'4")	5630 (18'6")		4.6 (15'1")
												14115 (46'4")	6260 (20'6")		5.6 (18'4")
PC800LC-8E0*9	5020 (16'6")	6330 (20'9")	1560 (5'1")	4400 (14'5")	3195 (10'6")	3570 (11'9")	840 (2'9")	3500 (11'6")	810 (32")	4310 (14'2")	3670*12 (12'0")	14405 (47'3")	4690 (15'5")	8.2 (26'11")	3.6 (11'10")
PC800LC-8E0*9 (SE spec)	5020 (16'6")	6330 (20'9")	1560 (5'1")	4400 (14'5")	3195 (10'6")	3570 (11'9")	840 (2'9")	3500 (11'6")	810 (32")	4310 (14'2")	3670*12 (12'0")	13130 (43'1")	4615 (15'2")	7.1 (23'4")	2.945 (9'8")
												14435 (47'4")	5630 (18'6")		4.6 (15'1")
												14115 (46'4")	6260 (20'6")		5.6 (18'4")
PC800LC-8E0**	5020 (16'6")	6327 (20'9")	1560 (5'1")	4400 (14'5")	3265 (10'9")	3720 (12'2")	840 (2'9")	3500 (11'6")	710 (28")	4210 (13'10")	3670*12 (12'0")	13995 (45'11")	4850 (15'11")	8 (26'3")	3.6 (11'10")
												13130 (43'1")	4615 (15'2")		2.9 (9'6")
												14115 (46'4")	6260 (20'6")		5.6 (18'4")
PC800LC-8E0 (SE spec) PC800LC-8R1 (SE spec)	5020 (16'6")	6330 (20'9")	1560 (5'1")	4400 (14'5")	3195 (10'6")	3570 (11'9")	840 (2'9")	3500 (11'6")	810 (32")	4310 (14'2")	3670*12 (12'0")	13130 (43'1")	4615 (15'2")	7.1 (23'4")	2.945 (9'8")
												14435 (47'4")	5630 (18'6")		4.6 (15'1")
												14115 (46'4")	6260 (20'6")		5.6 (18'4")
PC850-8E0 PC850-8R1	4500 (14'9")	5810 (19'1")	1560 (5'1")	4400 (14'5")	3195 (10'6")	3640 (11'11")	840 (2'9")	3500 (11'6")	610 (24")	4110 (13'6")	3670*12 (12'0")	13995 (45'11")	4850 (15'11")	8.04 (26'5")	3.6 (11'10")
												3390*13 (11'1")			
												4110 (13'6")	3670*12 (12'0")		13130 (43'1")
PC850-8E0 (SE spec) PC850-8R1 (SE spec)	4500 (14'9")	5810 (19'1")	1560 (5'1")	4400 (14'5")	3195 (10'6")	3640 (11'11")	840 (2'9")	3500 (11'6")	610 (24")	4110 (13'6")	3670*12 (12'0")	13130 (43'1")	4615 (15'2")	7.1 (23'4")	2.9 (9'6")
												3390*13 (11'1")			
												4110 (13'6")	3670*12 (12'0")		13130 (43'1")
PC800-7*7	4500 (14'9")	5810 (19'1")	1560 (5'1")	4300 (14'1")	3195 (10'6")	3640 (11'11")	840 (2'9")	3500 (11'6")	610 (24")	4110 (13'6")	3445*12 (11'4")	13895 (45'7")	4850 (15'11")	8.04 (26'5")	3.6 (11'10")
												3390*13 (11'1")			
												4110 (13'6")	3445*12 (11'4")		13030 (42'9")
PC800-7*7 (SE spec)	4500 (14'9")	5810 (19'1")	1560 (5'1")	4300 (14'1")	3195 (10'6")	3640 (11'11")	840 (2'9")	3500 (11'6")	610 (24")	4110 (13'6")	3445*12 (11'4")	13030 (42'9")	4615 (15'2")	7.1 (23'4")	2.9 (9'6")

*: USA source

** : UK source

***: China source

*4: India source

*5: Thailand source

*6: Brazil source

*7: Russia source

*8: Indonesia source

*9: for USA

*10: for UK

*11: for Russia

*12: Top of engine cover

*13: When retracted

*14: When expanded

*15: Top of exhaust pipe

*16: with OPG top guard

*17: Include step

Dimensions

EXCAVATORS (BACKHOE)

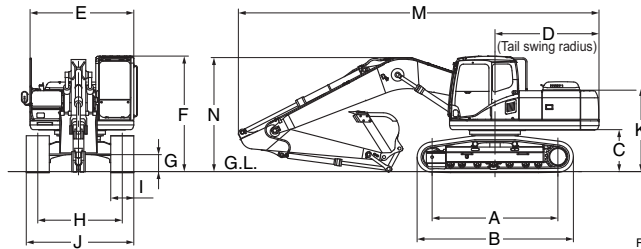

FVBH0313

	A mm (ft.in)	B mm (ft.in)	C mm (ft.in)	D mm (ft.in)	E mm (ft.in)	F mm (ft.in)	G mm (ft.in)	H mm (ft.in)	I mm (in)	J mm (ft.in)	K mm (ft.in)	M mm (ft.in)	N mm (ft.in)	Boom length m (ft.in)	Arm length m (ft.in)	
PC1250-8 PC1250-8R	4995 (16'5")	6425 (21'1")	1790 (5'11")	4870 (16'0")	3470 (11'5")	4120 (13'6")	990 (3'3")	3900 (12'9")	700 (28")	4600 (15'1")	4075 ^{*12} (13'4")	16020 (52'7")	6040 (19'10")	9.1 (29'10")	3.4 (11'2")	
												16050 (52'8")	6460 (21'2")		4.5 (14'9")	
												15840 (52'0")	6990 (22'11")		5.7 (18'8")	
PC1250-8R^{*8}	4995 (16'5")	6425 (21'1")	1790 (5'11")	4870 (16'0")	3470 (11'5")	4120 (13'6")	990 (3'3")	3900 (12'9")	700 (28")	4600 (15'1")	4075 ^{*12} (13'4")	14790 (48'6")	6040 (19'10")	7.8 (25'7")	3.4 (11'2")	
																4965 ^{*17} (16'3")
PC1250-7	4995 (16'5")	6425 (21'1")	1790 (5'11")	4870 (16'0")	3470 (11'5")	4120 (13'6")	990 (3'3")	3900 (12'9")	700 (28")	4600 (15'1")	3925 ^{*12} (12'11")	16020 (52'7")	6040 (19'10")	9.1 (29'10")	3.4 (11'2")	
												16050 (52'8")	6500 (21'4")		4.5 (14'9")	
												15840 (52'0")	6990 (22'11")		5.7 (18'8")	
PC1250LC-8	5970 (19'7")	7400 (24'3")	1790 (5'11")	4870 (16'0")	3470 (11'5")	4120 (13'6")	990 (3'3")	3900 (12'9")	1000 (39")	4900 (16'1")	4075 ^{*12} (13'4")	16020 (52'7")	6040 (19'10")	9.1 (29'10")	3.4 (11'2")	
												5265 ^{*17} (17'3")	16050 (52'8")		6460 (21'2")	4.5 (14'9")
													15840 (52'0")		6990 (22'11")	5.7 (18'8")
PC1250-8 (SP spec) PC1250-8R (SP spec)	4995 (16'5")	6425 (21'1")	1790 (5'11")	4870 (16'0")	3470 (11'5")	4120 (13'6")	990 (3'3")	3900 (12'9")	700 (28")	4600 (15'1")	4075 ^{*12} (13'4")	14790 (48'6")	6265 (20'7")	7.8 (25'7")	3.4 (11'2")	
PC1250-7 (SP spec.)	4995 (16'5")	6425 (21'1")	1790 (5'11")	4810 (15'9")	3470 (11'5")	4120 (13'6")	990 (3'3")	3900 (12'9")	700 (28")	4600 (15'1")	3925 ^{*12} (12'11")	14790 (48'6")	6265 (20'7")	7.8 (25'7")	3.4 (11'2")	
PC2000-8 PC2000-8^{*8}	5780 (19')	7445 (24'5")	2095 (6'10")	5980 (19'7")	7490 (24'7")	7030 (23'1")	825 (28")	4600 (15'1")	810 (32")	5410 (17'9")	5970 ^{*12} (19'7")	17030 (55'11")	7135 (23'5")	8.7 (28'7")	3.9 (12'10")	

*: USA source
 **: UK source
 ***: China source
 *4: India source
 *5: Thailand source
 *6: Brazil source

*7: Russia source
 *8: Indonesia source
 *9: for USA
 *10: for UK
 *11: for Russia
 *12: Top of engine cover

*13: When retracted
 *14: When expanded
 *15: Top of exhaust pipe
 *16: with OPG top guard
 *17: Include step

Dimensions

EXCAVATORS (BACKHOE)

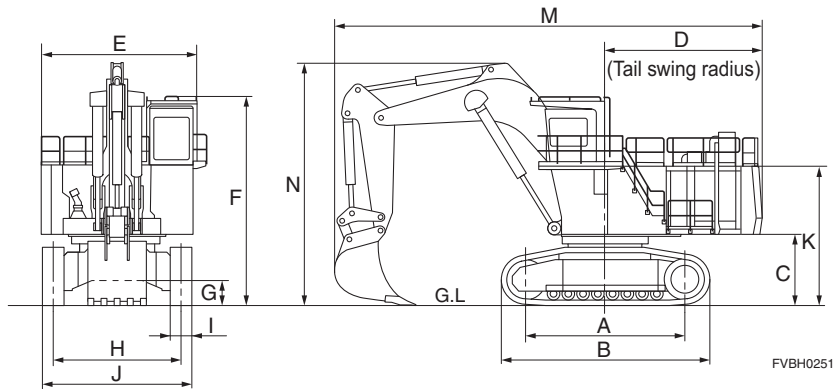

	A mm (ft.in)	B mm (ft.in)	C mm (ft.in)	D mm (ft.in)	E mm (ft.in)	F mm (ft.in)	G mm (ft.in)	H mm (ft.in)	I mm (in)	J mm (ft.in)	K mm (ft.in)	M mm (ft.in)	N mm (ft.in)	Boom length m (ft.in)	Arm length m (ft.in)
PC3000-6	6000 (19'8")	7930 (26'0")	2670 (8'9")	6410 (21'0")	6070 (19'11")	7455 (24'6")	935 (3'1")	4800 (15'9")	800 (31.5")	5600 (18'4")	5255 (17'3")	16700 (54'10")	8300 (27'3")	8.6 (28'3")	4.0 (13'1")
PC4000-6	6700 (22'0")	8842 (29'0")	3017 (9'11")	6500 (21'4")	7399 (24'3")	8300 (27'3")	930 (3'1")	5550 (18'3")	1200 (47")	8300 (27'3")	6102 (20'0")	18000 (59'1")	10000 (32'10")	9.75 (32'0")	4.5 (14'9")
PC5500-6	7424 (24'4")	9720 (31'11")	3310 (10'10")	7550 (24'9")	7270 (23'10")	8610 (28'3")	995 (3'3")	6190 (20'4")	1350 (53")	7540 (24'9")	6410 (21'0")	20800 (68'3")	11100 (36'5")	11.0 (36'1")	5.1 (16'9")
PC8000-6	8100 (26'7")	10735 (35'3")	3615 (11'10")	8710 (28'7")	8300 (27'3")	9655 (31'8")	1065 (3'6")	6830 (22'5")	1500 (59")	8330 (27'4")	7115 (23'4")	23200 (76'1")	13000 (42'8")	11.5 (37'9")	5.5 (18'1")

Working Ranges and Digging Forces

EXCAVATORS (BACKHOE)

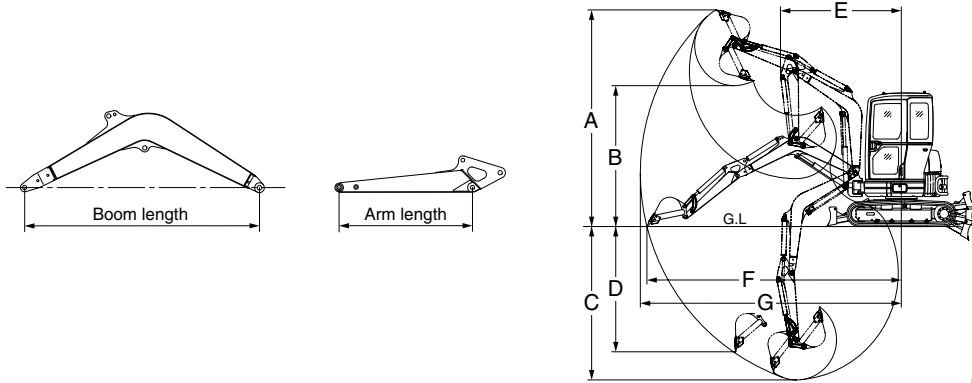

FVBH0016

	Boom length m (ft.in)	Arm length m (ft.in)	A mm (ft.in)	B mm (ft.in)	C mm (ft.in)	D mm (ft.in)	E mm (ft.in)	F mm (ft.in)	G mm (ft.in)	Bucket digging force kg (lb/kN)*	Arm crowd force kg (lb/kN)*
PC09-1	1.357 (4'5")	0.684 (2'3")	2790 (9'2")	1990 (6'6")	1500 (4'11")	1170 (3'10")	1050 (3'5")	2760 (9'1")	2840 (9'4")	1075 (2,370/10.5)	600 (1,320/5.9)
PC14R-3**	1.62 (5'4")	0.88 (2'11")	3285 (10'9")	2295 (7'6")	2000 (6'7")	1450 (4'9")	1485 (4'10")	3545 (11'8")	3635 (11'11")	1210 (2,680/11.9)	750 (1,650/7.35)
		1.13 (3'8")	3430 (11'3")	2440 (8'0")	2250 (7'5")	1810 (5'11")	1540 (5'1")	3785 (12'5")	3865 (12'8")		585 (1,290/5.7)
PC16R-3**	1.76 (5'9")	0.965 (3'2")	3610 (11'10")	2610 (8'7")	2160 (7'1")	1785 (5'10")	1470 (4'10")	3735 (12'3")	3825 (12'7")	1450 (3,190/14.2)	920 (2,020/9.0)
		1.215 (4'0")	3820 (12'6")	2815 (9'3")	2410 (7'11")	2000 (6'7")	1570 (5'2")	3990 (13'1")	4070 (13'4")		730 (1,610/7.16)
PC18MR-3	1.76 (5'9")	0.965 (3'2")	3615 (11'10")	2610 (8'8")	2160 (7'1")	1785 (5'10")	1670 (5'6")	3935 (12'11")	4025 (13'2")	1620 (3,570/15.9)	1010 (2,225/9.9)
		1.215 (4'0")	3820 (12'6")	2815 (9'3")	2410 (7'11")	2000 (6'7")	1770 (5'10")	4190 (13'9")	4270 (14'0")		865 (1,910/8.5)
PC18MR-3**	1.76 (5'9")	0.965 (3'2")	3615 (11'10")	2610 (8'8")	2160 (7'1")	1785 (5'10")	1670 (5'6")	3935 (12'11")	4025 (13'2")	1620 (3,570/15.9)	1010 (2,230/9.9)
		1.215 (4'0")	3820 (12'6")	2815 (9'3")	2410 (7'11")	2000 (6'7")	1770 (5'10")	4190 (13'9")	4270 (14'0")		865 (1,910/8.5)
PC20MR-3	1.81 (5'11")	0.97 (3'2")	4000 (13'1")	2760 (9'1")	2280 (7'6")	1860 (6'1")	1790 (5'10")	4000 (13'1")	4150 (13'7")	1920 (4,230/18.8)	1390 (3,065/13.6)
		1.32 (4'4")	4300 (14'1")	3020 (9'11")	2580 (8'6")	2215 (7'3")	1940 (6'4")	4350 (14'3")	4500 (14'9")		1140 (2,510/11.2)
PC22MR-3**	1.81 (5'11")	0.97 (3'2")	4000 (13'1")	2760 (9'1")	2280 (7'6")	1860 (6'1")	1790 (5'10")	4000 (13'1")	4150 (13'7")	1920 (4,230/18.8)	1390 (3,065/13.6)
		1.32 (4'4")	4300 (14'1")	3020 (9'11")	2580 (8'6")	2215 (7'3")	1940 (6'4")	4350 (14'3")	4500 (14'9")		1150 (2,540/11.3)
PC26MR-3**	2.2 (7'3")	1.115 (3'8")	4170 (13'8")	2960 (9'9")	2740 (8'1")	1540 (5'1")	1960 (6'5")	4280 (14'1")	4430 (14'6")	2245 (4,950/22.0)	1430 (3,150/14.0)
		1.37 (4'6")	4340 (14'3")	3120 (10'3")	2720 (8'11")	1760 (5'9")	2060 (6'9")	4530 (14'10")	4660 (15'3")		1235 (2,720/12.1)
PC27MR-3	2.18 (7'2")	1.10 (3'8")	4480 (14'8")	3190 (10'6")	2550 (8'4")	2080 (6'10")	1980 (6'6")	4550 (14'11")	4650 (15'3")	2230 (4,920/21.9)	1500 (3,310/14.7)
		1.37 (4'6")	4690 (15'5")	3390 (11'1")	2840 (9'4")	2370 (7'9")	2030 (6'8")	4840 (15'11")	4930 (16'2")		1243 (2,840/12.1)
PC30MR-3	2.285 (7'6")	1.24 (4'1")	4840 (15'11")	3350 (11'0")	2760 (9'1")	2400 (7'10")	2055 (6'9")	4910 (16'1")	5050 (16'7")	3000 (6,615/29.4)	1800 (3,970/17.7)
		1.61 (5'5")	5070 (16'8")	3580 (11'9")	3130 (10'3")	2770 (9'1")	2190 (7'2")	5215 (17'1")	5390 (17'8")		1500 (3,310/14.7)
PC30MR-3**	2.285 (7'6")	1.24 (4'1")	4840 (15'11")	3350 (11'0")	2760 (9'1")	2400 (7'10")	2055 (6'9")	4910 (16'1")	5050 (16'7")	3000 (6,615/29.4)	1800 (3,970/17.7)
		1.61 (5'5")	5070 (16'8")	3580 (11'9")	3130 (10'3")	2770 (9'1")	2190 (7'2")	5215 (17'1")	5390 (17'8")		1520 (3,350/14.9)
PC35MR-3	2.54 (8'4")	1.37 (4'6")	5000 (16'5")	3530 (11'7")	3110 (10'2")	2690 (8'10")	2030 (6'8")	5170 (17'0")	5300 (17'5")	3050 (6,725/29.9)	2100 (4,630/20.6)
		1.72 (5'8")	5270 (17'3")	3790 (12'5")	3455 (11'4")	3120 (10'3")	2140 (7'0")	5520 (18'1")	5640 (18'6")		1760 (3,880/17.3)
PC35MR-3**	2.54 (8'4")	1.37 (4'6")	5000 (16'5")	3530 (11'7")	3110 (10'2")	2690 (8'10")	2030 (6'8")	5170 (17'0")	5300 (17'5")	3050 (6,725/29.9)	2100 (4,630/20.6)
		1.72 (5'8")	5270 (17'3")	3790 (12'5")	3455 (11'4")	3120 (10'3")	2140 (7'0")	5520 (18'1")	5640 (18'6")		1670 (3,680/16.4)
PC45MR-3	2.64 (8'8")	1.375 (4'6")	5515 (18'1")	3785 (12'5")	3350 (11'0")	2645 (8'8")	2340 (7'8")	5575 (18'3")	5735 (18'10")	3460 (7,630/33.9)	2200 (4,850/21.6)
		1.77 (6'0")	5780 (19'0")	4060 (13'4")	3770 (12'4")	3060 (10'0")	2410 (7'11")	5980 (19'7")	6130 (20'1")		1980 (4,370/19.4)
PC45MR-3**	2.64 (8'8")	1.375 (4'6")	5515 (18'1")	3785 (12'5")	3350 (11'0")	2645 (8'8")	2340 (7'8")	5575 (18'3")	5735 (18'10")	3460 (7,630/33.9)	2200 (4,850/21.6)
		1.77 (6'0")	5780 (19'0")	4060 (13'4")	3770 (12'4")	3060 (10'0")	2410 (7'11")	5980 (19'7")	6130 (20'1")		2000 (4,410/19.6)

* ISO rating
 ** Italy source
 *** China source

Working Ranges and Digging Forces

EXCAVATORS (BACKHOE)

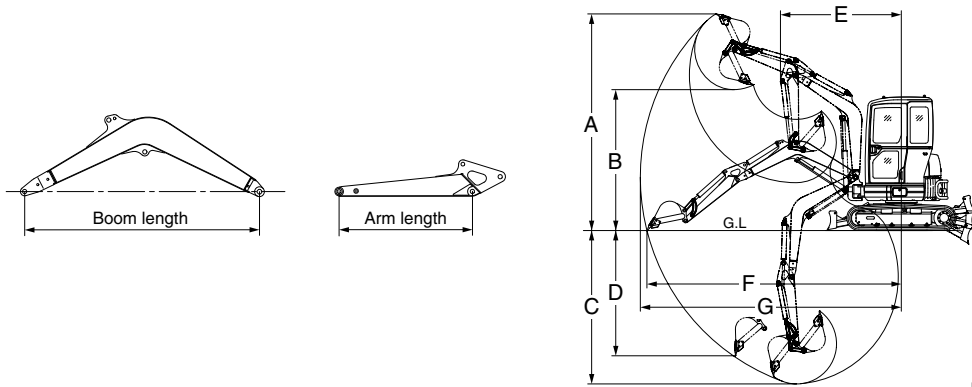

FVBH0016

	Boom length m (ft.in)	Arm length m (ft.in)	A mm (ft.in)	B mm (ft.in)	C mm (ft.in)	D mm (ft.in)	E mm (ft.in)	F mm (ft.in)	G mm (ft.in)	Bucket digging force kg (lb/kN)*	Arm crowd force kg (lb/kN)*
PC55MR-3	2.90 (9'6")	1.64 (5'5")	5945 (19'6")	4230 (13'11")	3800 (12'6")	3020 (9'11")	2270 (7'5")	6070 (19'11")	6220 (20'5")	3980 (8,775/39.0)	2440 (5,380/23.9)
		2.0 (6'3")	6215 (20'5")	4495 (14'9")	4160 (13'8")	3380 (11'1")	2380 (7'10")	6430 (21'1")	6570 (21'7")		2150 (4,740/23.9)
PC55MR-3**	2.90 (9'6")	1.64 (5'5")	5945 (19'6")	4230 (13'11")	3800 (12'6")	3020 (9'11")	2270 (7'5")	6070 (19'11")	6220 (20'5")	3980 (8,775/39.0)	2440 (5,380/23.9)
		2.0 (6'3")	6215 (20'5")	4495 (14'9")	4160 (13'8")	3380 (11'1")	2380 (7'10")	6430 (21'1")	6570 (21'7")		2270 (5,000/22.3)
PC56-7***	2.9 (9'6")	1.64 (5'5")	5850 (19'2")	4160 (13'8")	3800 (12'6")	3020 (9'11")	2340 (7'8")	5950 (19'6")	6120 (20'1")	3980 (8,770/39.0)	2440 (5,380/23.9)

- * ISO rating
- ** Italy source
- *** China source

Working Ranges and Digging Forces

EXCAVATORS (BACKHOE)

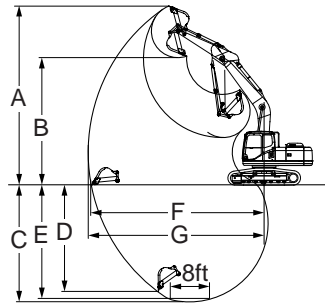
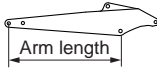
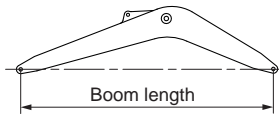

FVBH0312

	Boom length m (ft.in)	Arm length m (ft.in)	A mm (ft.in)	B mm (ft.in)	C mm (ft.in)	D mm (ft.in)	E mm (ft.in)	F mm (ft.in)	G mm (ft.in)	Bucket digging force*1 kg (lb/kN)	Arm crowd force*1 kg (lb/kN)	
PC60-8***	3.65 (12'0")	1.55 (5'1")	7030 (23'1")	4925 (16'2")	3900 (12'10")	3350 (11'0")	3555 (11'8")	6045 (19'10")	6190 (20'4")	5590 ^{*2} (12,320/54.8)	4060 ^{*2} (8,950/39.8)	
PC70-8 PC70-8***	3.71 (12'2")	1.65 (5'5")	7150 (23'5")	5015 (16'5")	4100 (13'5")	3505 (11'6")	3755 (12'4")	6220 (20'5")	6360 (20'10")	5590 ^{*2} (12,320/54.8)	3900 ^{*2} (8,600/38.2)	
PC71-7	3.71 (12'2")	1.65 (5'5")	7150 (23'5")	5015 (16'5")	4100 (13'5")	3505 (11'6")	3755 (12'4")	6220 (20'5")	6360 (20'10")	4800 ^{*2} (10,580/47.1)	3600 ^{*2} (7,940/35.3)	
		2.25 (7'5")	7515 (24'8")	5420 (17'9")	4690 (15'5")	3265 (10'9")	4460 (14'8")	6770 (22'3")	6900 (22'8")		3050 ^{*2} (6,720/29.9)	
PC78US-8	3.71 (12'2")	1.65 (5'5")	7300 (23'11")	5180 (17'0")	4100 (13'5")	3610 (11'10")	3770 (12'4")	6240 (20'6")	6380 (20'11")	6250 ^{*2} (13,780/61.3)	4230 ^{*2} (9,330/41.5)	
		2.25 (7'5")	7600 (24'11")	5500 (18'0")	4710 (15'5")	4030 (13'3")	4430 (14'6")	6790 (22'3")	6920 (22'8")		3520 ^{*2} (7,760/34.5)	
PC80MR-3	3.2 (10'6")	1.65 (5'5")	6298 (20'8")	4429 (14'6")	4000 (13'1")	2584 (8'6")	3609 (11'10")	6614 (21'8")	6792 (22'3")	5970 ^{*2} (13,160/58.6)	3990 ^{*2} (8,800/39.1)	
		2.0 (6'7")	6520 (21'5")	4631 (15'2")	4350 (14'3")	2890 (9'6")		6958 (22'10")	7126 (23'5")			
PC88MR-8	3.4 (11'2")	1.65 (5'5")	6570 (21'7")	4515 (14'10")	4160 (13'8")	2900 (9'6")	3765 (12'4")	6725 (22'1")	6935 (22'9")	6250 ^{*2} (13,780/61.3)	4230 ^{*2} (9,330/41.5)	
		2.1 (6'11")	6750 (22'2")	4720 (15'6")	4615 (15'2")	3165 (10'5")	4250 (13'11")	7150 (23'5")	7345 (24'1")		3700 ^{*2} (8,160/36.3)	
PC88MR-8⁹	3.4 (11'2")	1.65 (5'5")	6570 (21'7")	4515 (14'10")	4160 (13'8")	2900 (9'6")	3765 (12'4")	6725 (22'1")	6935 (22'9")	6525 ^{*2} (14,390/64.0)	4230 ^{*2} (9,330/41.5)	
		2.1 (6'11")	6750 (22'2")	4720 (15'6")	4615 (15'2")	3165 (10'5")	4250 (13'11")	7150 (23'5")	7345 (24'1")		3700 ^{*2} (8,160/36.3)	
PC110-7***	4.26 (14'0")	2.26 (7'5")	7910 (25'11")	5650 (18'6")	5060 (16'7")	4570 (15'0")	4730 (15'6")	7600 (24'11")	7730 (25'4")	9400 ^{*2} (20,720/92.2)	6100 ^{*2} (13,450/59.8)	
PC118MR-8	3.5 (11'5")	2.0 (6'7")	6590 (21'7")	4920 (16'2")	4450 (14'7")	2522 (8'3")	-	7285 (23'11")	7515 (24'8")	7310 ^{*2} (16,120/71.7)	4700 ^{*2} (10,360/46.1)	
		2.3 (7'7")	6740 (22'1")	5070 (16'8")	4750 (15'7")	2800 (9'2")	-	7575 (24'10")	7795 (25'7")		4170 ^{*2} (9,190/41)	
PC118MR-8 (Two-piece boom)	3.855 (12'6")	2.0 (6'7")	8250 (27'1")	3135 (10'3")	4520 (14'10")	3490 (11'5")	-	7750 (25'5")	7950 (26'1")	7310 ^{*2} (16,120/71.7)	4700 ^{*2} (10,360/46.1)	
		2.3 (7'7")	8390 (27'6")	3235 (10'7")	4670 (15'4")	3635 (11'11")	-	7900 (25'11")	8100 (26'7")		4170 ^{*2} (9,190/41)	
PC130-8⁵ PC130-8⁵	4.6 (15'1")	2.5 (8'2")	8650 (28'5")	6210 (20'5")	5520 (18'1")	4980 (16'4")	5320 (17'5")	8170 (26'10")	8290 (27'2")	9520 (21,000/93.4)	6880 (15,170/67.5)	
		3.0 (9'10")	8930 (29'4")	6615 (21'8")	5955 (19'6")	5365 (17'7")	5775 (18'11")	8595 (28'2")	8720 (28'7")		6050 (13,340/59.3)	
PC130-8⁶	4.6 (15'1")	2.5 (8'2")	8650 (28'5")	6210 (20'5")	5520 (18'1")	4980 (16'4")	5320 (17'5")	8170 (26'10")	8290 (27'2")	9520 (21,000/93.4)	6050 (13,340/59.3)	
PC130-7⁴	4.6 (15'1")	2.1 (6'11")	8345 (27'4")	5905 (19'4")	5115 (16'9")	4520 (14'9")	4875 (15'11")	7795 (25'6")	7925 (26'0")	9500 (20,940/93.2)	7900 (17,420/77.5)	
		2.5 (8'2")	8610 (28'3")	6170 (20'3")	5520 (18'1")	4940 (16'2")	5315 (17'5")	8170 (26'10")	8290 (27'2")		6900 (15,210/67.7)	
PC130-7***	4.6 (15'1")	2.1 (6'11")	8345 (27'5")	5905 (19'4")	5115 (16'9")	4520 (14'10")	4875 (16)	7795 (25'7")	7925 (26)	9500 (20,940/93.2)	7900 (17,420/77.5)	
		2.5 (8'2")	8610 (28'3")	6170 (20'3")	5520 (18'1")	4940 (16'2")	5315 (17'5")	8170 (26'10")	8290 (27'2")		6900 (15,210/67.7)	
		2.9 (9'6")	8970 (29'5")	6535 (21'5")	6015 (19'9")	5360 (17'7")	5835 (19'2")	8665 (28'5")	8785 (28'10")		6200 (13,670/60.8)	
PC130F-7	4.26 (14'0")	2.36 (7'9")	7970 (26'2")	5700 (18'8")	5060 (16'7")	4500 (14'9")		7750 (25'5")	7875 (25'10")			
		3.0 (9'10")	8790 (28'10")	6535 (21'5")	6015 (19'9")	5360 (17'7")		8665 (28'5")	8785 (28'10")			
PC138US-8 PC138USLC-8	4.6 (15'1")	2.1 (6'11")	9020 (29'7")	6525 (21'5")	5070 (16'8")	4490 (14'9")	4830 (15'10")	7805 (25'7")	7930 (26'0")	9000 ^{*2} (19,840/88.3)	7300 ^{*2} (16,090/71.6)	
		2.5 (8'2")	9340 (30'8")	6840 (22'5")	5480 (18'0")	4900 (16'1")	5265 (17'3")	8180 (26'10")	8300 (27'0")		9500 ^{*2} (20,950/93.2)	6300 ^{*2} (13,890/61.8)
		3.0 (9'10")	9700 (31'10")	7350 (24'1")	5900 (19'4")	5340 (17'6")	5715 (18'9")	8600 (28'3")	8720 (28'7")		9000 ^{*2} (19,840/88.3)	5700 ^{*2} (12,750/55.9)
PC138USLC-10⁹	4.6 (15'1")	2.5 (8'2")	9340 (30'8")	6840 (22'5")	5480 (18'0")	4900 (16'1")	5265 (17'3")	8180 (26'10")	8300 (27'3")	9500 ^{*2} (20,940/93.2)	6300 ^{*2} (13,890/61.8)	
		3.0 (9'10")	9700 (31'10")	7350 (24'1")	5900 (19'4")	5340 (17'6")	5715 (18'9")	8600 (28'3")	8720 (28'7")		9000 ^{*2} (19,840/88.3)	5700 ^{*2} (12,750/55.9)

* : USA source *6 : Brazil source *11 : for UK *1 : Using Power Max. function and ISO rating
** : UK source *7 : Russia source *12 : for Russia *2 : Normal digging force
*** : China source *8 : Indonesia source
*4 : India source *9 : Italy source
*5 : Thailand source *10 : for USA

Working Ranges and Digging Forces

EXCAVATORS (BACKHOE)

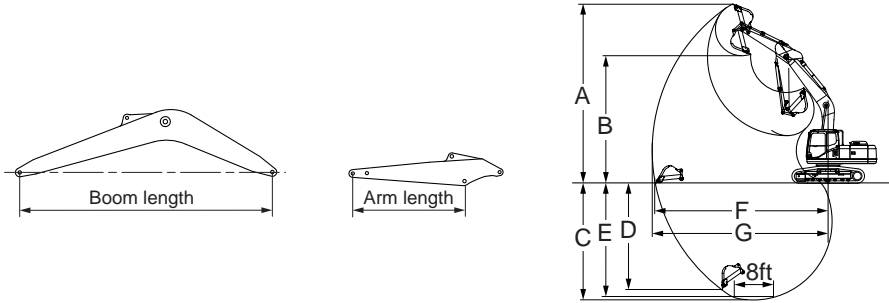

FVBH0312

	Boom length m (ft.in)	Arm length m (ft.in)	A mm (ft.in)	B mm (ft.in)	C mm (ft.in)	D mm (ft.in)	E mm (ft.in)	F mm (ft.in)	G mm (ft.in)	Bucket digging force*1 kg (lb/kN)	Arm crowd force*1 kg (lb/kN)
PC160LC-8 PC160LC-8** PC160LC-8 ⁵	5.15 (16'11")	2.25 (7'5")	8910 (29'3")	6280 (20'7")	5610 (18'5")	4860 (15'11")	5375 (17'8")	8510 (27'11")	8680 (28'6")	12500 (27,560/123)	9700 (21,380/95.1)
		2.61 (8'6")	8980 (29'6")	6370 (20'11")	5960 (19'6")	5040 (16'6")	5740 (18'10")	8800 (28'10")	8960 (29'6")		8800 (19,400/86.3)
		2.9 (9'6")	9130 (29'11")	6525 (21'5")	6250 (20'6")	5320 (17'5")	6050 (19'10")	9075 (29'9")	9235 (30'4")		8100 (17,860/79.4)
PC160LC-7***	5.15 (16'11")	2.25 (7'5")	8910 (29'3")	6280 (20'7")	5610 (18'5")	4860 (15'11")	5375 (17'8")	8510 (27'11")	8680 (28'6")	12500 (27,560/123)	9700 (21,380/95.1)
		2.61 (8'6")	8980 (29'6")	6370 (20'11")	5960 (19'6")	5040 (16'6")	5740 (18'10")	8800 (28'10")	8960 (29'6")		8800 (19,400/86.3)
		2.9 (9'6")	9130 (29'11")	6525 (21'5")	6250 (20'6")	5320 (17'5")	6050 (19'10")	9075 (29'9")	9235 (30'4")		8100 (17,860/79.4)
PC190LC-8	5.35 (17'7")	2.25 (7'5")	9030 (29'8")	6415 (21'1")	5630 (18'6")	4990 (16'4")	5410 (17'9")	8730 (28'8")	8890 (29'2")	12500 (27,560/123)	9700 (21,380/95.1)
		2.6 (8'6")	9105 (29'10")	6505 (21'4")	5985 (19'8")	5180 (17'0")	5780 (19'0")	9020 (29'7")	9180 (30'1")		8800 (19,400/86.3)
		2.9 (9'6")	9255 (30'4")	6655 (21'10")	6275 (20'7")	5475 (18'0")	6090 (20'0")	9295 (30'6")	9445 (31'0")		8100 (17,860/79.4)
PC190LC-8 (Two-piece boom)	5.07 (16'8")	2.25 (7'5")	9420 (30'11")	6755 (22'2")	5185 (17'0")	4225 (13'10")	5060 (17'7")	8465 (27'9")	8635 (28'4")	12500 (27,560/123)	9700 (21,380/95.1)
		2.6 (8'6")	9575 (31'5")	6910 (22'8")	5515 (18'1")	4530 (14'10")	5400 (17'9")	8765 (28'9")	8930 (29'4")		8800 (19,400/86.3)
		2.9 (9'6")	9760 (32'0")	7100 (23'4")	5800 (29'0")	4845 (15'11")	5690 (18'8")	9040 (29'8")	9200 (30'2")		8100 (17,860/79.4)
HB205-1 HB215LC-1 HB215LC-1**	5.7 (18'8")	2.925 (9'7")	10000 (32'10")	7110 (23'4")	6620 (21'9")	5980 (19'7")	6370 (20'11")	9700 (31'10")	9875 (32'5")	15200 (33,510/149)	11000 (24,250/108)
PC200-8 PC200LC-8 PC200-8** PC200LC-8 ⁷	5.7 (18'8")	1.84 (6'0")	9500 (31'2")	6630 (21'9")	5380 (17'8")	4630 (15'2")	5130 (16'0")	8660 (28'5")	8850 (29'1")	15200 (33,510/149)	18000*3 (39,680/177)
		2.41 (7'11")	9800 (32'2")	6890 (22'7")	6095 (20'0")	5430 (17'10")	5780 (19'0")	9190 (30'2")	9380 (30'9")		13000 (28,660/127)
		2.925 (9'7")	10000 (32'10")	7110 (23'4")	6620 (21'9")	5980 (19'7")	6370 (20'11")	9700 (31'10")	9875 (32'5")		11000 (24,250/108)
PC200-8 ⁸	5.7 (18'8")	2.925 (9'7")	10000 (32'10")	7110 (23'4")	6620 (21'9")	5980 (19'7")	6370 (20'11")	9700 (31'10")	9875 (32'5")	15200 (33,510/149)	11000 (24,250/108)
PC200-8M0 PC200LC-8M0 PC200-8M0 ⁵ PC200LC-8M0 ⁵	5.7 (18'8")	1.84 (6'0")	9500 (31'2")	6630 (21'9")	5380 (17'8")	4630 (15'2")	5130 (16'0")	8660 (28'5")	8850 (29'1")	15200 (33,510/149)	18000*3 (39,680/177)
		2.41 (7'11")	9800 (32'2")	6890 (22'7")	6095 (20'0")	5430 (17'10")	5780 (19'0")	9190 (30'2")	9380 (30'9")		13000 (28,660/127)
		2.925 (9'7")	10000 (32'10")	7110 (23'4")	6620 (21'9")	5980 (19'7")	6370 (20'11")	9700 (31'10")	9875 (32'5")		11000 (24,250/108)
PC200-8*** PC200LC-8*** PC210-8*** PC210LC-8***	5.7 (18'8")	1.84 (6'0")	9500 (31'2")	6630 (21'9")	5380 (17'8")	4630 (15'2")	5130 (16'0")	8660 (28'5")	8850 (29'1")	15200 (33,510/149)	18000*3 (39,680/177)
		2.41 (7'11")	9800 (32'2")	6890 (22'7")	6095 (20'0")	5430 (17'10")	5780 (19'0")	9190 (30'2")	9380 (30'9")		13000 (28,660/127)
		2.925 (9'7")	10000 (32'10")	7110 (23'4")	6620 (21'9")	5980 (19'7")	6370 (20'11")	9700 (31'10")	9875 (32'5")		11000 (24,250/108)
PC200-8 ⁶	5.7 (18'8")	2.41 (7'11")	9800 (32'2")	6890 (22'7")	6095 (20'0")	5430 (17'10")	5780 (19'0")	9190 (30'2")	9380 (30'9")	15200 (33,510/149)	13000 (28,660/127)
		2.925 (9'7")	10000 (32'10")	7110 (23'4")	6620 (21'9")	5980 (19'7")	6370 (20'11")	9700 (31'10")	9875 (32'5")		11000 (24,250/108)
		2.41 (7'11")	9800 (32'2")	6890 (22'7")	6095 (20'0")	5430 (17'10")	5780 (19'0")	9190 (30'2")	9380 (30'9")		13000 (28,660/127)
PC200LC-8 ⁶	5.7 (18'8")	2.41 (7'11")	9800 (32'2")	6890 (22'7")	6095 (20'0")	5430 (17'10")	5780 (19'0")	9190 (30'2")	9380 (30'9")	15200 (33,510/149)	13000 (28,660/127)
PC200-7	5.7 (18'8")	1.84 (6'0")	9500 (31'2")	6630 (21'9")	5380 (17'8")	4630 (15'2")	5130 (16'0")	8660 (28'5")	8850 (29'1")	15200 (33,510/149)	18000*3 (39,680/177)
		2.41 (7'11")	9800 (32'2")	6890 (22'7")	6095 (20'0")	5430 (17'10")	5780 (19'0")	9190 (30'2")	9380 (30'9")		13000 (28,660/127)
		2.925 (9'7")	10000 (32'10")	7110 (23'4")	6620 (21'9")	5980 (19'7")	6370 (20'11")	9700 (31'10")	9875 (32'5")		11000 (24,250/108)
PC210-10** PC210LC-10**	5.7 (18'8")	2.4 (7'10")	9800 (32'2")	6890 (22'7")	6095 (20'0")	5430 (17'10")	5780 (19'0")	9190 (30'2")	9380 (30'9")	17500*3 (38,580/172)	13000 (28,660/127)
		2.9 (9'6")	10000 (32'10")	7110 (23'4")	6620 (21'9")	5980 (19'7")	6370 (20'11")	9700 (31'10")	9875 (32'5")		11000 (24,250/108)
		2.4 (7'10")	9800 (32'2")	6890 (22'7")	6095 (20'0")	5430 (17'10")	5780 (19'0")	9190 (30'2")	9380 (30'9")		13000 (28,660/127)

*: USA source
 **: UK source
 ***: China source
 *4: India source
 *5: Thailand source

*6: Brazil source
 *7: Russia source
 *8: Indonesia source
 *9: Italy source
 *10: for USA

*11: for UK
 *12: for Russia

*1: Using Power Max. function and ISO rating
 *3: Optional bucket cylinder is required.

Working Ranges and Digging Forces

EXCAVATORS (BACKHOE)

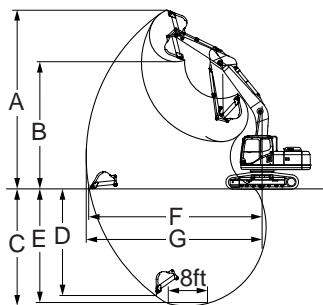
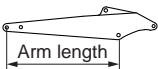
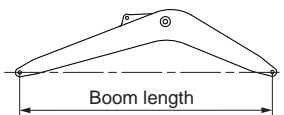

FVBH0312

	Boom length m (ft.in)	Arm length m (ft.in)	A mm (ft.in)	B mm (ft.in)	C mm (ft.in)	D mm (ft.in)	E mm (ft.in)	F mm (ft.in)	G mm (ft.in)	Bucket digging force*1 kg (lb/kN)	Arm crowd force*1 kg (lb/kN)	
PC210LC-8*4	5.7 (18'8")	2.4 (7'10") 2.9 (9'6")	9830 (32'3")	9660 (22'10")	6000 (19'8")	5080 (16'8")	5760 (19'0")	9195 (30'2")	9390 (30'10")	15200 (33,510/149)	13000 (28,660/127)	
			10000 (32'10")	7110 (23'4")	6620 (21'9")	5980 (19'7")	6370 (20'11")	9700 (31'10")	9875 (32'5")		11000 (24,250/108)	
PC210LC-10*	5.7 (18'8")	2.925 (9'7")	10000 (32'10")	7110 (23'4")	6620 (21'9")	5980 (19'7")	6370 (20'11")	9700 (31'10")	9875 (32'5")	15200 (33,510/149)	11000 (24,250/108)	
PC210NLC-8**	5.7 (18'8")	1.84 (6'0") 2.41 (7'11") 2.925 (9'7")	9500 (31'2")	6630 (21'9")	5380 (17'8")	4630 (15'2")	5130 (16'0")	8660 (28'5")	8850 (29'1")	17500*3 (38,580/172)	14800 (32,630/145)	
			9800 (32'2")	6890 (22'7")	6095 (20'0")	5430 (17'10")	5780 (19'0")	9190 (30'2")	9380 (30'9")		13000 (28,660/127)	
			10000 (32'10")	7110 (23'4")	6620 (21'9")	5980 (19'7")	6370 (20'11")	9700 (31'10")	9875 (32'5")		15200 (33,510/149)	11000 (24,250/108)
PC220-8 PC220LC-8 PC220-8*7 PC220LC-8*7	5.9 (19'2")	2.00 (6'7") 2.50 (8'2") 3.05 (10'0")	9665 (31'9")	6715 (22'0")	5825 (19'1")	4750 (15'7")	5585 (18'4")	9070 (29'9")	9270 (30'5")	20100*3 (44,310/197)	15800 (34,830/155)	
			9790 (32'1")	6860 (22'6")	6320 (20'9")	5130 (16'10")	6100 (20'0")	9480 (31'1")	9670 (31'9")		17500 (38,580/172)	15100 (33,290/148)
			10000 (32'10")	7035 (23'1")	6920 (22'8")	6010 (19'9")	6700 (22'0")	10020 (32'10")	10180 (33'5")		13200 (29,100/129)	
PC220-8***	5.9 (19'2")	2.00 (6'7") 2.50 (8'2") 3.05 (10'0")	9665 (31'9")	6715 (22'0")	5825 (19'1")	4750 (15'7")	5585 (18'4")	9070 (29'9")	9270 (30'5")	20100*3 (44,310/197)	16400 (36,160/161)	
			9790 (32'1")	6860 (22'6")	6320 (20'9")	5130 (16'10")	6100 (20'0")	9480 (31'1")	9670 (31'9")		17500 (38,580/172)	15100 (33,290/148)
			10000 (32'10")	7035 (23'1")	6920 (22'8")	6010 (19'9")	6700 (22'0")	10020 (32'10")	10180 (33'5")		13200 (29,100/129)	
PC220-8M0 PC220LC-8M0	5.85 (19'2")	2.00 (6'7") 2.50 (8'2") 3.05 (10'0")	9665 (31'9")	6715 (22'0")	5825 (19'1")	4750 (15'7")	5585 (18'4")	9070 (29'9")	9270 (30'5")	20100*3 (44,310/197)	15800 (34,830/155)	
			9790 (32'1")	6860 (22'6")	6320 (20'9")	5130 (16'10")	6100 (20'0")	9480 (31'1")	9670 (31'9")		17500 (38,580/172)	15100 (33,290/148)
			10000 (32'10")	7035 (23'1")	6920 (22'8")	6010 (19'9")	6700 (22'0")	10020 (32'10")	10180 (33'5")		13200 (29,100/129)	
PC220-7 PC220LC-7	5.9 (19'2")	2.00 (6'7") 2.50 (8'2") 3.05 (10'0")	9665 (31'9")	6715 (22'0")	5825 (19'1")	4750 (15'7")	5585 (18'4")	9070 (29'9")	9270 (30'5")	20100*3 (44,310/197)	16400 (36,160/161)	
			9790 (32'1")	6860 (22'6")	6320 (20'9")	5130 (16'10")	6100 (20'0")	9480 (31'1")	9670 (31'9")		17500 (38,580/172)	15100 (33,290/148)
			10000 (32'10")	7035 (23'1")	6920 (22'8")	6010 (19'9")	6700 (22'0")	10020 (32'10")	10180 (33'5")		13200 (29,100/129)	
PC228US-8 PC228USLC-8	5.7 (18'8")	2.925 (9'6")	10700 (35'1")	7825 (25'8")	6620 (21'9")	5980 (19'7")	6370 (20'11")	9700 (31'10")	9875 (32'5")	15200 (33,510/149)	11000 (24,250/108)	
PC228USLC-8*10	5.7 (18'8")	2.925 (9'6")	10700 (35'1")	7825 (25'8")	6620 (21'9")	5980 (19'7")	6370 (20'11")	9700 (31'10")	9875 (32'5")	15200 (33,510/149)	11000 (24,250/108)	
PC228USLC-8*11	5.7 (18'8")	2.4 (7'10") 2.9 (9'7")	10380 (34'1")	7470 (24'6")	6095 (20'0")	5315 (17'5")	5840 (19'20")	9205 (30'2")	9395 (30'10")	17500*3 (38,580/172)	13000 (28,660/127)	
			10700 (35'1")	7825 (25'8")	6620 (21'9")	5980 (19'7")	6370 (20'11")	9700 (31'10")	9875 (32'5")		15200 (33,510/149)	11000 (24,250/108)
PC230NHD-8	5.7 (18'8")	1.80 (5'11") 2.40 (7'10") 2.90 (9'6")	9525 (31'3")	6655 (21'10")	5355 (17'7")	4605 (15'1")	5105 (16'9")	8660 (28'5")	8850 (29'0")	17500*3 (38,580/172)	14800 (32,630/145)	
			9825 (32'3")	6915 (22'8")	6070 (19'11")	5405 (17'9")	5755 (18'10")	9190 (30'2")	9380 (30'9")		13000 (28,660/127.5)	
			10025 (32'11")	7135 (23'5")	6595 (21'8")	5955 (19'6")	6345 (20'10")	9700 (31'10")	9875 (32'5")		15200 (33,510/149)	11000 (24,250/108)
PC240LC-10*	5.85 (19'2")	3.05 (10'0") 3.5 (11'6")	10000 (32'10")	7035 (23'1")	6920 (22'8")	6010 (19'9")	6700 (22'0")	10020 (32'10")	10180 (33'5")	17500 (38,580/172)	13200 (29,100/130)	
			10300 (33'10")	7360 (24'2")	7320 (24'0")	6230 (20'5")	7150 (23'5")	10420 (34'2")	10580 (34'8")		11200 (24,690/110)	
PC240LC-10** PC240NLC-10**	5.85 (19'2")	2.0 (6'7") 2.5 (8'2") 3.0 (10'0") 3.50 (11'6")	9665 (31'9")	6715 (22'0")	5825 (19'1")	4750 (15'7")	5585 (18'4")	9070 (29'9")	9270 (30'5")	20100*3 (44,310/197)	16400 (36,160/161)	
			9790 (32'1")	6860 (22'6")	6320 (20'9")	5130 (16'10")	6100 (20'0")	9480 (31'1")	9670 (31'9")		15100 (33,290/148)	
			10000 (32'10")	7035 (23'1")	6920 (22'8")	6010 (19'9")	6700 (22'0")	10020 (32'10")	10180 (33'5")		13200 (29,100/129)	
			10300 (33'10")	7360 (24'2")	7320 (24'0")	6230 (20'5")	7150 (23'5")	10420 (34'2")	10580 (34'8")		11200 (24,690/110)	

*: USA source
 **: UK source
 ***: China source
 *4: India source
 *5: Thailand source

*6: Brazil source
 *7: Russia source
 *8: Indonesia source
 *9: Italy source
 *10: for USA

*11: for UK
 *12: for Russia

*1: Using Power Max. function and ISO rating
 *3: Optional bucket cylinder is required.

Working Ranges and Digging Forces

EXCAVATORS (BACKHOE)

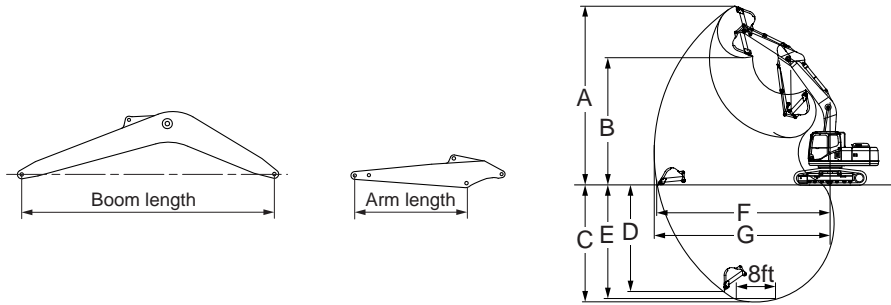

FVBH0312

	Boom length m (ft.in)	Arm length m (ft.in)	A mm (ft.in)	B mm (ft.in)	C mm (ft.in)	D mm (ft.in)	E mm (ft.in)	F mm (ft.in)	G mm (ft.in)	Bucket digging force*1 kg (lb/kN)	Arm crowd force*1 kg (lb/kN)
PC240LC-8***	5.85 (19'2")	3.05 (10'0")	10000 (32'10")	7035 (23'1")	6920 (22'8")	6010 (19'9")	6700 (22'0")	10020 (32'10")	10180 (33'5")	17500 (38,580/172)	13200 (29,100/129)
PC240LC-10*6	5.85 (19'2")	2.0 (6'7")	9590 (31'6")	6550 (21'6")	5875 (19'3")	4490 (14'9")	5710 (18'9")	9200 (30'2")	9270 (30'5")	20100*3 (44,310/197)	16400 (36,160/161)
		2.5 (8'2")	9845 (32'4")	6850 (22'6")	6340 (20'10")	5025 (16'6")	6120 (20'1")	9500 (31'2")	9685 (31'9")	17500 (38,580/172)	15100 (33,290/148)
		3.0 (10'0")	10060 (33'0")	7010 (23'0")	6915 (22'8")	5485 (18'0")	6780 (22'3")	10125 (33'3")	10180 (33'5")		13200 (29,100/130)
PC270-8 PC270LC-8	5.9 (19'2")	2.50 (8'2")	9620 (31'7")	6720 (22'1")	5940 (19'6")	4800 (15'9")	5750 (18'10")	9450 (31'0")	9650 (31'8")	20200 (44,530/198)	17300 (38,140/170)
		3.05 (10'0")	10000 (32'10")	7035 (23'1")	6460 (21'2")	5650 (18'6")	6320 (20'9")	9990 (32'9")	10100 (33'2")		14100 (31,080/138)
		3.50 (11'6")	10130 (33'3")	7200 (23'7")	6940 (22'9")	5930 (19'5")	6790 (22'3")	10390 (34'1")	10570 (34'8")		12800 (28,220/126)
PC270-7***	5.85 (19'2")	3.05 (10'0")	10000 (32'10")	7035 (23'1")	6460 (21'2")	5650 (18'6")	6320 (20'9")	9990 (32'9")	10100 (33'2")	20200 (44,530/198)	15100 (33,290/148)
PC290LC-10*	6.15 (20'2")	3.2 (10'6")	10345 (34'3")	7370 (23'2")	6915 (22'8")	6135 (20'2")	6755 (22'2")	10455 (34'4")	10635 (34'11")	20200 (44,530/198)	13620 (30,030/134)
		3.5 (11'6")	10355 (34'0")	7435 (24'5")	7220 (23'8")	6440 (21'2")	7070 (23'2")	10175 (35'9")	10890 (34'8")		12790 (28,190/125)
PC290LC-10** PC290NLC-10**	6.15 (20'2")	2.0 (6'7")	9780 (32'1")	6830 (22'5")	5720 (18'9")	3910 (12'10")	5500 (18'1")	9370 (31'11")	9570 (31'5")	23100*3 (50,930/227)	18800 (41,450/184)
		2.65 (8'2")	9985 (32'9")	7040 (23'1")	6360 (20'10")	5365 (17'7")	6175 (20'3")	9905 (32'6")	10095 (33'1")		16320 (35,980/160)
		3.2 (10'6")	10345 (34'3")	7370 (23'2")	6915 (22'8")	6135 (20'2")	6755 (22'2")	10455 (34'4")	10635 (34'11")	20200 (44,530/198)	14370 (31,680/141)
		3.5 (11'6")	10355 (34'0")	7435 (24'5")	7220 (23'8")	6440 (21'2")	7070 (23'2")	10175 (35'9")	10890 (34'8")		12800 (28,220/126)
PC300-8 PC300LC-8 PC300-8*7 PC300LC-8*7	6.47 (21'3")	2.22 (7'3")	9460 (31'0")	6520 (21'5")	6400 (21'0")	4890 (16'1")	6130 (20'1")	9910 (32'6")	10120 (33'2")	26400*3 (58,200/259)	24000 (52,910/235)
		2.55 (8'4")	9965 (32'8")	6895 (22'7")	6750 (22'2")	5880 (19'4")	6520 (21'5")	10355 (34'0")	10550 (34'7")		20500 (45,190/201)
		3.185 (10'5")	10100 (33'2")	7050 (23'4")	7380 (24'3")	6400 (21'0")	7180 (23'7")	10920 (35'10")	11100 (36'5")	23100 (50,930/227)	17400 (38,360/171)
		4.02 (13'2")	10550 (34'7")	7490 (24'7")	8200 (26'11")	7280 (23'11")	8045 (26'5")	11730 (38'6")	11900 (39'1")		14700 (32,410/144)
PC300-8*8 (SE spec) PC300LC-8*8 (SE spec)	6.47 (21'3")	2.22 (7'3")	9460 (31'0")	6520 (21'5")	6400 (21'0")	4890 (16'1")	6130 (20'1")	9910 (32'6")	10120 (33'2")	26400*3 (58,200/259)	24000 (52,910/235)
		2.55 (8'4")	9965 (32'8")	6895 (22'7")	6750 (22'2")	5880 (19'4")	6520 (21'5")	10355 (34'0")	10550 (34'7")		20500 (45,190/201)
		3.185 (10'5")	10100 (33'2")	7050 (23'4")	7380 (24'3")	6400 (21'0")	7180 (23'7")	10920 (35'10")	11100 (36'5")	23100 (50,930/227)	17400 (38,360/171)
PC300-8*5 (SE spec) PC300LC-8*5 (SE spec)	6.47 (21'3")	2.22 (7'3")	9460 (31'0")	6520 (21'5")	6400 (21'0")	4890 (16'1")	6130 (20'1")	9910 (32'6")	10120 (33'2")	26400*3 (58,200/259)	24000 (52,910/235)
		2.55 (8'4")	9965 (32'8")	6895 (22'7")	6705 (22'0")	5880 (19'4")	6520 (21'5")	10355 (34'0")	10550 (34'7")		20500 (45,190/201)
		3.185 (10'5")	10100 (33'2")	7050 (23'4")	7380 (24'3")	6400 (21'0")	7180 (23'7")	10920 (35'10")	11100 (36'5")	23100 (50,930/227)	17400 (38,360/171)
		4.02 (13'2")	10550 (34'7")	7490 (24'7")	8180 (26'10")	7280 (23'11")	8045 (26'5")	11730 (38'6")	11900 (39'1")		14700 (32,410/144)
PC300-7	6.5 (21'3")	2.22 (7'3")	9580 (31'5")	6595 (21'8")	6355 (20'10")	5120 (16'10")	6130 (20'1")	9950 (32'8")	10155 (33'4")	26400*3 (58,200/259)	24000 (52,910/235)
		2.55 (8'4")	9965 (32'8")	6895 (22'7")	6705 (22'0")	5880 (19'4")	6520 (21'5")	10355 (34'0")	10550 (34'7")		20500 (45,190/201)
		3.185 (10'5")	10100 (33'2")	7050 (23'4")	7380 (24'3")	6400 (21'0")	7180 (23'7")	10920 (35'10")	11100 (36'5")	23100 (50,930/227)	17400 (38,360/171)
		4.02 (13'2")	10550 (34'7")	7490 (24'7")	8180 (26'10")	7280 (23'11")	8045 (26'5")	11730 (38'6")	11900 (39'1")		14700 (32,410/144)
PC300-7*** PC360-7***	6.47 (21'3")	2.2 (7'3")	9580 (31'5")	6595 (21'8")	6355 (20'10")	5120 (16'10")	6130 (20'1")	9950 (32'8")	10155 (33'4")	26400*3 (58,200/259)	24000 (52,910/235)
		2.55 (8'4")	9965 (32'8")	6895 (22'7")	6705 (22)	5880 (19'4")	6520 (21'5")	10355 (34)	10550 (34'7")		20500 (45,190/201)
		3.185 (10'5")	10100 (33'2")	7050 (23'4")	7380 (24'3")	6400 (21'0")	7180 (23'7")	10920 (35'10")	11100 (36'5")	23100 (50,930/227)	17400 (38,360/171)
		4.02 (13'2")	10550 (34'7")	7490 (24'7")	8180 (26'10")	7280 (23'11")	8045 (26'5")	11730 (38'6")	11900 (39'1")		14700 (32,410/144)

* : USA source
 ** : UK source
 *** : China source
 *4 : India source
 *5 : Thailand source
 *6 : Brazil source
 *7 : Russia source
 *8 : Indonesia source
 *9 : Italy source
 *10 : for USA
 *11 : for UK
 *12 : for Russia
 *1 : Using Power Max. function and ISO rating
 *3 : Optional bucket cylinder is required.

Working Ranges and Digging Forces

EXCAVATORS (BACKHOE)

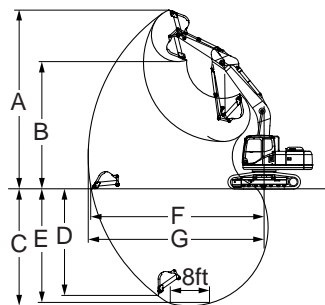
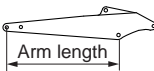
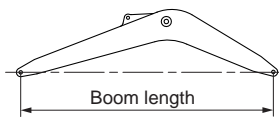

FVBH0312

	Boom length m (ft.in)	Arm length m (ft.in)	A mm (ft.in)	B mm (ft.in)	C mm (ft.in)	D mm (ft.in)	E mm (ft.in)	F mm (ft.in)	G mm (ft.in)	Bucket digging force*1 kg (lb/kN)	Arm crowd force*1 kg (lb/kN)	
PC300LC-7*4	6.47 (21'3")	2.22 (7'3")	9580 (31'5")	6595 (21'8")	6355 (20'10")	5120 (16'10")	6130 (20'1")	9950 (32'8")	10155 (33'4")	26400*3 (58,200/256)	24000 (52,910/235)	
		3.185 (10'6")	10210 (33'6")	7110 (23'4")	7380 (24'3")	6400 (21'3")	7180 (23'7")	10920 (35'10")	11100 (36'5")	23200 (51,150/228)	17400 (38,360/171)	
PC350-8 PC350LC-8	6.47 (21'3")	3.185 (10'5")	10100 (33'2")	7050 (23'2")	7380 (24'3")	6400 (21'0")	7180 (23'7")	10920 (35'10")	11100 (36'5")	23200 (51,150/228)	17400 (38,360/171)	
PC350-7 PC350LC-7	6.47 (21'3")	3.185 (10'5")	10100 (33'2")	7050 (23'2")	7380 (24'3")	6400 (21'0")	7180 (23'7")	10920 (35'10")	11100 (36'5")	23200 (51,150/228)	17400 (38,360/171)	
PC350LC-8*6	6.47 (21'3")	2.2	9580	6595	6355	5120	6130	9950	10155	27100*3 (51,150/266)	24000	
		2.55 (8'4")	10025 (32'11")	6930 (22'9")	6710 (22'0")	5880 (19'4")	6530 (21'5")	10300 (33'10")	10535 (34'7")		20700 (45,640/203)	
		3.185 (10'5")	10210 (33'6")	7110 (23'4")	7380 (24'3")	6480 (21'3")	7180 (23'7")	10920 (35'10")	11100 (36'5")	23100 (50,930/227)	17400 (38,360/171)	
		4.02 (13'2")	10550 (34'7")	7490 (24'7")	8180 (26'10")	7280 (23'11")	8045 (26'5")	11730 (38'6")	11900 (39'1")		14700 (32,410/144)	
PC360LC-10*	6.5 (21'3")	2.54 (8'4")	9965 (32'8")	6895 (22'7")	6705 (22'0")	5880 (19'3")	6520 (21'5")	10355 (34'0")	10550 (34'7")	26400*3 (58,200/259)	20500 (45,190/201)	
		3.185 (10'5")	10210 (33'6")	7110 (23'4")	7380 (24'3")	6480 (21'3")	7180 (23'7")	10920 (35'10")	11100 (36'5")	23200 (51,150/228)	17400 (38,360/171)	
		4.02 (13'2")	10550 (34'7")	7490 (24'7")	8180 (26'10")	7280 (23'11")	8045 (26'5")	11730 (38'6")	11900 (39'1")	23100 (50,930/227)	14700 (32,410/144)	
		2.2	9580	6595	6355	5120	6130	9950	10155	26400*3 (58,200/259)	24000	
2.6 (8'6")	9965 (32'8")	6895 (22'7")	6705 (22'0")	5880 (19'3")	6520 (21'5")	10355 (34'0")	10550 (34'7")	20500 (45,190/201)				
PC360LC-10** PC360NLC-10**	6.5 (21'3")	3.2 (10'6")	10210 (33'6")	7110 (23'4")	7380 (24'3")	6480 (21'3")	7180 (23'7")	10920 (35'10")	11100 (36'5")	23100 (50,930/227)	17400 (38,360/171)	
		4.02 (13'2")	10550 (34'7")	7490 (24'7")	8180 (26'10")	7280 (23'11")	8045 (26'5")	11730 (38'6")	11900 (39'1")		14700 (32,410/144)	
		2.54 (8'4")	10070 (33'4")	7005 (23'0")	6640 (21'9")	5795 (19'0")	6455 (21'2")	10315 (33'10")	10550 (34'7")	26400*3 (58,200/259)	20500 (45,190/201)	
		3.185 (10'5")	10260 (33'7")	7155 (23'6")	7265 (23'10")	6235 (20'6")	7100 (23'3")	10870 (35'8")	11100 (36'5")	23200 (51,150/228)	17400 (38,360/171)	
PC390LC-10*	6.5 (21'3")	4.02 (13'2")	10660 (35'0")	7600 (24'11")	8100 (26'7")	7145 (23'5")	7975 (26'2")	11705 (38'5")	11895 (39'0")	23100 (50,930/227)	14700 (32,410/144)	
		2.4	10310 (33'10")	7070 (23'2")	6845 (22'6")	5305 (17'5")	6650 (21'10")	10855 (35'7")	11080 (36'4")	28200 (62,170/277)	25900 (57,100/254)	
		2.9 (9'6")	10285 (33'9")	7080 (23'3")	7345 (24'1")	5700 (18'8")	7155 (23'6")	11230 (36'10")	11445 (37'7")		28100 (61,950/276)	26200 (57,760/257)
PC400-8 PC400LC-8 PC400-8R PC400LC-8R	7.06 (23'2")	3.38 (11'1")	10915 (35'10")	7565 (24'10")	7820 (25'8")	6870 (22'6")	7680 (25'2")	11820 (38'9")	12025 (39'5")	28000 (61,730/275)	21800 (48,060/214)	
		4.0 (13'1")	11025 (36'2")	7715 (25'4")	8445 (27'8")	7285 (23'11")	8315 (27'3")	12365 (40'7")	12565 (41'3")	27500 (60,630/270)	19400 (42,770/190)	
		PC400-8*** PC450-8***	7.06 (23'2")	3.38 (11'1")	10925 (35'10")	7625 (25'0")	7790 (25'7")	6600 (21'8")	11800 (38'9")	12005 (39'5")	28300 (62,340/278)	23800 (52,470/233)
		PC400-8R*8 (SE spec) PC400LC-8R*8 (SE spec)	7.06 (23'2")	2.4 (7'10")	10310 (33'10")	7070 (23'2")	6845 (22'6")	5305 (17'5")	6650 (21'10")	10855 (35'7")	11080 (36'4")	28200 (62,170/277)
2.9 (9'6")	10285 (33'9")			7080 (23'3")	7345 (24'1")	5700 (18'8")	7155 (23'6")	11230 (36'10")	11445 (37'7")	28100 (61,950/276)	26200 (57,760/257)	
3.38 (11'1")	10915 (35'10")			7565 (24'10")	7820 (25'8")	6870 (22'6")	7680 (25'2")	11820 (38'9")	12025 (39'5")	28000 (61,730/275)	21800 (48,060/214)	
4.0 (13'1")	11025 (36'2")			7715 (25'4")	8445 (27'8")	7285 (23'11")	8315 (27'3")	12365 (40'10")	12565 (41'3")	27500 (60,630/270)	19400 (42,770/190)	
PC400-7 PC400LC-7 PC400-7*7 PC400LC-7*7	7.06 (23'2")	2.4 (7'10")	10310 (33'10")	7070 (23'2")	6845 (22'6")	5305 (17'5")	6650 (21'10")	10855 (35'7")	11080 (36'4")	28200 (62,170/277)	25900 (57,100/254)	
		2.9 (9'6")	10285 (33'9")	7080 (23'3")	7345 (24'1")	5700 (18'8")	7155 (23'6")	11230 (36'10")	11445 (37'7")		28100 (61,950/276)	26200 (57,760/257)
		3.38 (11'1")	10915 (35'10")	7565 (24'10")	7820 (25'8")	6870 (22'6")	7680 (25'2")	11820 (38'9")	12025 (39'5")	28000 (61,730/275)	21800 (48,060/214)	
		4.0 (13'1")	11025 (36'2")	7715 (25'4")	8445 (27'8")	7285 (23'11")	8315 (27'3")	12365 (40'7")	12565 (41'3")	27500 (60,630/270)	19400 (42,770/190)	

*: USA source
 **: UK source
 ***: China source
 *4: India source
 *5: Thailand source

*6: Brazil source
 *7: Russia source
 *8: Indonesia source
 *9: Italy source
 *10: for USA

*11: for UK
 *12: for Russia

*1: Using Power Max. function and ISO rating
 *3: Optional bucket cylinder is required.

Working Ranges and Digging Forces

EXCAVATORS (BACKHOE)

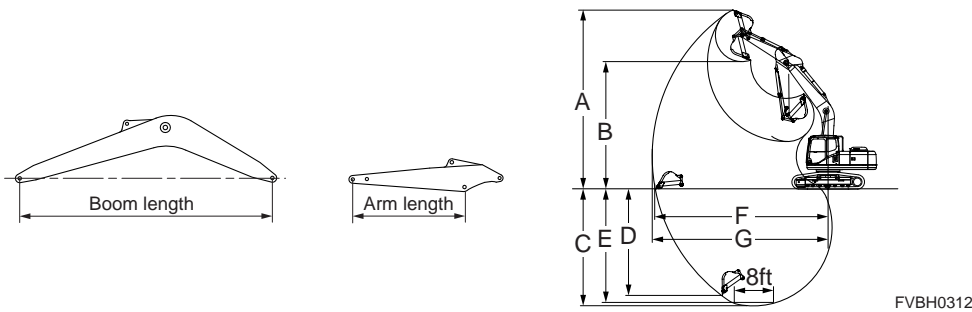

FVBH0312

	Boom length m (ft.in)	Arm length m (ft.in)	A mm (ft.in)	B mm (ft.in)	C mm (ft.in)	D mm (ft.in)	E mm (ft.in)	F mm (ft.in)	G mm (ft.in)	Bucket digging force*1 kg (lb/kN)	Arm crowd force*1 kg (lb/kN)		
PC450-8 PC450-8R PC450LC-8 PC450LC-8R	7.06 (23'2")	3380 (11'1")	10925 (35'10")	7625 (25'0")	7790 (25'7")	6600 (21'8")	7650 (25'1")	11800 (38'9")	12005 (39'5")	28300 (62,390/278)	23800 (52,470/233)		
PC490LC-10*	7.06 (23'2")	2.9 (9'6")	10350 (34'0")	7145 (23'5")	7280 (23'11")	5635 (18'6")	7090 (23'3")	11230 (36'10")	11445 (37'7")	28000 (61,730/275)	26200 (57,760/257)		
		3.38 (11'1")	10980 (36'0")	7630 (25'0")	7755 (25'5")	6805 (22'4")	7615 (25'0")	11810 (38'9")	12030 (39'6")		21800 (48,060/214)		
		4.0 (13'1")	11090 (36'5")	7780 (25'6")	8380 (27'6")	7220 (23'8")	8250 (27'0")	12365 (40'7")	12565 (41'3")		19400 (42,770/190)		
		4.8 (15'9")	11550 (37'11")	8210 (26'11")	9190 (30'2")	8085 (26'6")	9080 (29'10")	13180 (43'3")	13365 (43'10")		17000 (37,480/167)		
PC490-10** PC490LC-10**	7.1 (23'4")	2.4 (7'10")	10375 (33'10")	7135 (23'2")	6780 (22'3")	5240 (17'3")	6585 (21'7")	10840 (35'7")	11080 (36'4")	28000 (61,730/275)	25900 (57,100/254)		
		2.9 (9'6")	10350 (33'11")	7145 (23'5")	7280 (23'11")	5635 (18'6")	7090 (23'3")	11215 (36'10")	11445 (37'7")		26200 (57,760/257)		
		3.38 (11'1")	10980 (36'0")	7630 (25'0")	7755 (25'5")	6805 (22'4")	7615 (25'0")	11810 (38'9")	12030 (39'6")		21800 (48,060/214)		
		4.0 (13'1")	11090 (36'5")	7780 (25'6")	8380 (27'6")	7220 (23'8")	8250 (27'1")	12355 (40'6")	12565 (41'3")		19400 (42,770/190)		
	6.7 (22'0")	4.8 (15'9")	11550 (37'11")	8210 (26'11")	9190 (30'2")	8085 (26'6")	9080 (29'9")	13170 (43'3")	13365 (43'10")	28000 (61,730/275)	17000 (37,480/167)		
		2.4 (7'10")	10510 (34'6")	7075 (23'3")	6365 (20'11")	4365 (14'4")	5630 (18'6")	10360 (34'0")	10605 (34'10")		25900 (57,100/254)		
		2.9 (9'6")	10550 (34'7")	7115 (23'4")	7865 (25'10")	4950 (16'3")	6710 (22'0")	10750 (35'3")	10985 (36'0")		26200 (57,760/257)		
		6.6 (21'11")	2.4 (7'10")	10300 (33'10")	6760 (22'2")	6595 (21'8")	4470 (14'8")	6420 (21'1")	10720 (35'2")		10975 (36'0")	32600 (71,870/320)	27600 (60,850/271)
PC600-8E0 PC600LC-8E0 PC600-8R1 PC600LC-8R1	7.7 (25'2")	3.5 (11'6")	11880 (39'0")	7960 (26'1")	8490 (27'10")	7510 (24'8")	8360 (27'5")	12800 (42'0")	13020 (42'9")	32300 (71,210/317)	25100 (55,340/246)		
		4.3 (14'1")	12180 (40'0")	8245 (27'1")	9275 (30'5")	8375 (27'6")	9175 (30'1")	13555 (44'6")	13740 (45'1")		22200 (48,940/218)		
		5.2 (17'1")	12560 (41'3")	8600 (28'3")	10225 (33'7")	9275 (30'5")	10125 (33'3")	14435 (47'4")	14630 (48'0")		19300 (42,550/189)		
	7.3 (23'11")	3.5 (11'6")	11475 (37'8")	7650 (25'1")	8165 (26'9")	6660 (21'10")	8030 (26'4")	12385 (40'8")	12615 (41'5")	36900 (81,350/362)	25100 (55,340/246)		
		6.6 (21'8")	2.9 (9'6")	11140 (36'7")	7210 (23'8")	7060 (23'2")	5630 (18'6")	6910 (22'8")	11300 (37'1")		11550 (37'11")	32300 (71,210/317)	25100 (55,340/246)
		6.6 (21'8")	2.9 (9'6")	11140 (36'7")	7210 (23'8")	7060 (23'2")	5630 (18'6")	6910 (22'8")	11300 (37'1")		11550 (37'11")	32300 (71,210/317)	25100 (55,340/246)
PC600-8**	7.3 (23'11")	3.5 (11'6")	11475 (37'8")	7650 (25'1")	8165 (26'9")	6660 (21'10")	8030 (26'4")	12385 (40'8")	12615 (41'5")	32300 (71,210/317)	25100 (55,340/246)		
	7.66 (25'2")	3.5 (11'6")	11880 (39'0")	7960 (26'1")	8490 (27'10")	7510 (24'8")	8360 (27'5")	12800 (42'0")	13020 (42'9")	32300 (71,210/317)	25100 (55,340/246)		
PC600-7*12 PC600LC-7*12	7.7 (25'2")	3.5 (11'6")	11880 (39'0")	7960 (26'1")	8490 (27'10")	7510 (24'8")	8360 (27'5")	12800 (42'0")	13020 (42'9")	32300 (71,210/317)	25100 (55,340/246)		
		4.3 (14'1")	12180 (40'0")	8245 (27'1")	9275 (30'5")	8375 (27'6")	9175 (30'1")	13555 (44'6")	13740 (45'1")		22200 (48,940/218)		
		5.2 (17'1")	12560 (41'3")	8600 (28'3")	10225 (33'7")	9275 (30'5")	10125 (33'3")	14435 (47'4")	14630 (48'0")		19300 (42,550/189)		
	7.3 (23'11")	3.5 (11'6")	11475 (37'8")	7650 (25'1")	8165 (26'9")	6660 (21'10")	8030 (26'4")	12385 (40'8")	12615 (41'5")	36900 (81,350/362)	25100 (55,340/246)		
		6.6 (21'8")	2.9 (9'6")	11140 (36'7")	7210 (23'8")	7060 (23'2")	5630 (18'6")	6910 (22'8")	11300 (37'1")		11550 (37'11")	32300 (71,210/317)	25100 (55,340/246)
PC650LC-8*10	7.66 (25'2")	3.5 (11'6")	11880 (39'0")	7960 (26'1")	8490 (27'10")	7510 (24'8")	8360 (27'5")	12800 (42'0")	13020 (42'9")	32300 (71,210/317)	25100 (55,340/246)		
		4.3 (14'1")	12180 (40'0")	8245 (27'1")	9275 (30'5")	8375 (27'6")	9175 (30'1")	13555 (44'6")	13740 (45'1")		22200 (48,940/218)		
		5.2 (17'1")	12560 (41'3")	8600 (28'3")	10225 (33'7")	9275 (30'5")	10125 (33'3")	14435 (47'4")	14630 (48'0")		19300 (42,550/189)		
		7.3 (23'11")	3.5 (11'6")	11475 (37'8")	7650 (25'1")	8165 (26'9")	6660 (21'10")	8030 (26'4")	12385 (40'8")		12615 (41'5")	36900 (81,350/362)	29900 (65,920/293)
PC650LC-8***	7.3 (23'11")	3.5 (11'6")	11475 (37'8")	7650 (25'1")	8165 (26'9")	6660 (21'10")	8030 (26'4")	12385 (40'8")	12615 (41'5")	32300 (71,210/317)	25100 (55,340/246)		

* : USA source
 ** : UK source
 *** : China source
 *4 : India source
 *5 : Thailand source

*6 : Brazil source
 *7 : Russia source
 *8 : Indonesia source
 *9 : Italy source
 *10 : for USA

*11 : for UK
 *12 : for Russia

*1 : Using Power Max. function and ISO rating

Working Ranges and Digging Forces

EXCAVATORS (BACKHOE)

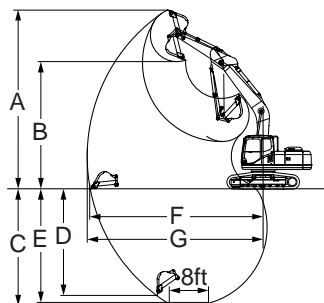
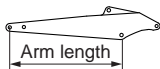
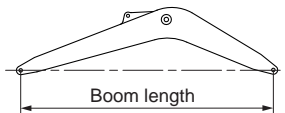

FVBH0312

	Boom length m (ft.in)	Arm length m (ft.in)	A mm (ft.in)	B mm (ft.in)	C mm (ft.in)	D mm (ft.in)	E mm (ft.in)	F mm (ft.in)	G mm (ft.in)	Bucket digging force*1 kg (lb/kN)	Arm crowd force*1 kg (lb/kN)
PC700LC-8E0 PC700LC-8R	7.66 (25'2")	3.5 (11'6")	12085 (39'8")	8120 (26'8")	8325 (27'4")	7340 (24'1")	8190 (26'10")	12785 (41'11")	13030 (42'9")	32300 (71,210/317)	25100 (55,340/246)
		4.3 (14'1")	12390 (40'8")	8425 (27'8")	9115 (29'11")	7730 (25'4")	8995 (29'6")	13520 (44'4")	13760 (45'2")		22200 (48,940/218)
		5.2 (17'1")	12750 (41'10")	8790 (28'10")	10045 (32'11")	8620 (28'3")	9940 (32'7")	14405 (47'3")	14630 (48'0")		19300 (42,550/189)
	7.3 (23'11")	3.5 (11'6")	11680 (38'4")	7810 (25'7")	8010 (26'3")	6480 (21'3")	7880 (25'10")	12380 (40'7")	12640 (41'6")	36900 (81,350/362)	25100 (55,340/246)
	6.6 (21'8")	2.9 (9'6")	11350 (37'3")	7360 (24'2")	6910 (22'8")	5470 (17'11")	6765 (22'2")	11295 (37'1")	11585 (38'0")		29900 (65,920/293)
PC700LC-8E0**	6.6 (21'8")	2.9 (9'6")	11350 (37'3")	7360 (24'2")	6910 (22'8")	5470 (17'11")	6765 (22'2")	11295 (37'1")	11585 (38'0")	32300 (71,210/317)	29900 (65,920/293)
	7.3 (23'11")	3.5 (11'6")	11680 (38'4")	7810 (25'7")	8010 (26'3")	6480 (21'3")	7880 (25'10")	12380 (40'7")	12640 (41'6")		25100 (55,340/246)
	7.6 (24'11")	3.5 (11'6")	12085 (39'8")	8120 (26'8")	8325 (27'4")	7340 (24'1")	8190 (26'10")	12785 (41'11")	13030 (42'9")		25100 (55,340/246)
PC700LC-8E0***	6.6 (21'8")	2.9 (9'6")	11350 (37'3")	7360 (24'2")	6910 (22'8")	5470 (17'11")	6765 (22'2")	11295 (37'1")	11585 (38'0")	36900 (81,350/362)	29900 (65,920/293)
PC800-8E0 PC800LC-8E0 PC800-8R1 PC800LC-8R1	8.2 (26'11")	3.6 (11'10")	11840 (38'10")	8145 (26'9")	8600 (28'3")	5575 (18'3")	8445 (27'8")	13460 (44'2")	13740 (45'1")	34000 (74,960/333)	25500 (56,220/250)
		4.6 (15'1")	12000 (39'4")	8295 (27'3")	9590 (31'6")	6575 (21'7")	9455 (31'0")	14310 (46'11")	14575 (47'1")		22600 (49,820/222)
		5.6 (18'4")	12690 (41'8")	8890 (29'2")	10595 (34'9")	7920 (26'0")	10500 (34'5")	15385 (50'6")	15635 (51'3")		19100 (42,110/183)
PC800-8E0,R1 (SE spec)	7.1 (23'4")	2.945 (9'6")	11330 (37'2")	7525 (24'8")	3130 (23'5")	4080 (13'5")	6980 (22'11")	11945 (39'2")	12265 (40'3")	48000 (105,820/471)	38100 (84,000/373)
PC800-8E0**	7.1 (23'4")	2.9 (9'6")	11330 (37'2")	7525 (24'8")	3130 (23'5")	4080 (13'5")	6980 (22'11")	11945 (39'2")	12265 (40'3")	48000 (105,820/471)	38100 (84,000/373)
PC800LC-8E0**	8.0 (26'3")	3.6 (11'10")	11955 (39'3")	8235 (27'0")	8445 (27'8")	5230 (17'2")	8310 (27'3")	13400 (44'0")	13660 (44'10")	40500 (89,290/397)	33300 (73,410/327)
PC800LC-8E0*	8.2 (26'11")	3.6 (11'10")	11840 (38'10")	8145 (26'7")	8600 (28'3")	5575 (18'3")	8445 (27'8")	13460 (44'2")	13740 (45'1")	37200 (80,010/364)	27900 (61,510/273)
		4.6 (15'1")	12000 (39'4")	8295 (27'3")	9590 (31'6")	6575 (21'7")	9455 (31'0")	14310 (46'11")	14575 (47'1")		24700 (54,450/242)
		5.6 (18'4")	12690 (41'8")	8890 (29'2")	10595 (34'9")	7920 (26'0")	10500 (34'5")	15385 (50'6")	15635 (51'4")		20900 (46,080/205)
PC800LC-8E0* (Super Digger)	8.04 (26'5")	3.6 (11'10")	11840 (38'10")	8145 (26'7")	8600 (28'3")	5575 (18'3")	8445 (27'8")	13460 (44'2")	13740 (45'1")	40500 (89,290/397)	33300 (73,410/327)
PC800LC-8E0* (SE spec)	7.1 (23'4")	2.945 (9'8")	11330 (37'2")	7525 (24'8")	3130 (23'5")	4080 (13'5")	6980 (22'11")	11945 (39'2")	12265 (40'3")	48000 (105,820/471)	38100 (84,000/373)
PC750-7*12	8.2 (26'11")	3.6 (11'10")	11840 (38'10")	8145 (26'7")	8600 (28'3")	5575 (18'3")	8445 (27'8")	13460 (44'2")	13740 (45'1")	34000 (74,960/333)	25500 (56,220/250)
		4.6 (15'1")	12000 (39'4")	8295 (27'3")	9590 (31'6")	6575 (21'7")	9455 (31'0")	14310 (46'11")	14575 (47'1")		22600 (49,820/222)
		5.6 (18'4")	12690 (41'8")	8890 (29'2")	10595 (34'9")	7920 (26'0")	10500 (34'5")	15385 (50'6")	15635 (51'4")		19100 (42,110/183)
PC750-7*12 (SE spec)	7.1 (23'4")	2.945 (9'8")	11330 (37'2")	7525 (24'8")	3130 (23'5")	4080 (13'5")	6980 (22'11")	11945 (39'2")	12265 (40'3")	43900 (96,780/431)	34800 (76,720/341)
PC800-7*12	8.04 (26'5")	3.6 (11'10")	11955 (39'3")	8235 (27'0")	8445 (27'8")	5230 (17'2")	8310 (27'3")	13400 (44'0")	13660 (44'10")	37000 (81,570/363)	30400 (67,020/298)
PC800-7*12 (SE spec)	7.1 (23'4")	2.945 (9'8")	11330 (37'2")	7525 (24'8")	3130 (23'5")	4080 (13'5")	6980 (22'11")	11945 (39'2")	12265 (40'3")	43900 (96,780/431)	34800 (76,720/341)
		3.6 (11'10")	11055 (36'3")	7430 (24'5")	7790 (25'7")	4260 (14'0")	7680 (25'2")	12400 (40'8")	12710 (41'8")		37000 (81,570/363)
PC850-8E0 PC850-8R1	8.04 (26'5")	3.6 (11'10")	11955 (39'3")	8235 (27'0")	8445 (27'8")	5230 (17'2")	8310 (27'3")	13400 (44'0")	13660 (44'10")	40500 (89,290/397)	33300 (73,410/327)
PC850-8E0 (SE spec) PC850-8R1 (SE spec)	7.1 (23'4")	2.945 (9'8")	11330 (37'2")	7525 (24'8")	3130 (23'5")	4080 (13'5")	6980 (22'11")	11945 (39'2")	12265 (40'3")	48000 (105,820/471)	38100 (84,000/373)
		3.6 (11'11")	11055 (36'3")	7430 (24'5")	7790 (25'7")	4260 (14'0")	7680 (25'2")	12400 (40'8")	12710 (41'8")		40500 (89,290/397)

* : USA source
 ** : UK source
 *** : China source
 *4 : India source
 *5 : Thailand source

*6 : Brazil source
 *7 : Russia source
 *8 : Indonesia source
 *9 : Italy source
 *10 : for USA

*11 : for UK
 *12 : for Russia

*1 : Using Power Max. function and ISO rating

Working Ranges and Digging Forces

EXCAVATORS (BACKHOE)

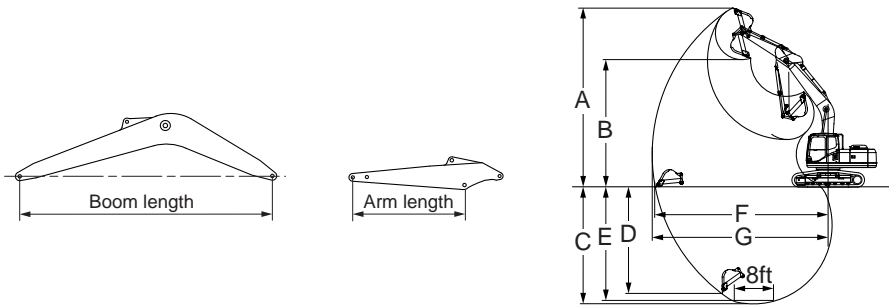

FVBH0312

	Boom length m (ft.in)	Arm length m (ft.in)	A mm (ft.in)	B mm (ft.in)	C mm (ft.in)	D mm (ft.in)	E mm (ft.in)	F mm (ft.in)	G mm (ft.in)	Bucket digging force*1 kg (lb/kN)	Arm crowd force*1 kg (lb/kN)
PC1250-8 PC1250-8R PC1250LC-8	9.1 (29'10")	3.4 (11'2")	13400 (44'0")	8680 (28'6")	9350 (30'8")	7610 (25'0")	9220 (30'3")	15000 (49'3")	15350 (50'4")	48800 (10,7590/479)	42000 (92,590/412)
		4.5 (14'9")	13490 (44'3")	9000 (29'6")	10440 (34'3")	8490 (27'10")	10340 (33'11")	16000 (52'6")	16340 (53'7")		34400 (75,840/337)
		5.7 (18'8")	13910 (45'8")	9440 (31'0")	11590 (38'0")	9480 (31'1")	11500 (37'9")	17130 (56'2")	17450 (57'3")		39700 (87,520/389)
PC1250-8 PC1250-8R PC1250LC-8	9.1 (29'10")	3.4 (11'2")	13400 (44'0")	8680 (28'6")	9350 (30'8")	7610 (25'0")	9220 (30'3")	15000 (49'3")	15350 (50'4")	48800 (10,7590/479)	42000 (92,590/412)
		4.5 (14'9")	13490 (44'3")	9000 (29'6")	10440 (34'3")	8490 (27'10")	10340 (33'11")	16000 (52'6")	16340 (53'7")		34400 (75,840/337)
		5.7 (18'8")	13910 (45'8")	9440 (31'0")	11590 (38'0")	9480 (31'1")	11500 (37'9")	17130 (56'2")	17450 (57'3")		39700 (87,520/389)
PC1250-8R*8	7.8 (25'7")	3.4 (11'2")	13000 (42'8")	8450 (27'9")	7900 (25'11")	5025 (16'6")	7745 (25'5")	13670 (44'10")	14070 (46'2")	58100 (128,110/570)	42000 (92,590/412)
PC1250-7	9.1 (29'10")	3.4 (11'2")	13400 (44'0")	8680 (28'6")	9350 (30'8")	7610 (25'0")	9220 (30'3")	15000 (49'3")	15350 (50'4")	48800 (10,7590/479)	42000 (92,590/412)
		4.5 (14'9")	13490 (44'3")	9000 (29'6")	10440 (34'3")	8490 (27'10")	10340 (33'11")	16000 (52'6")	16340 (53'7")		34400 (75,840/337)
		5.7 (18'8")	13910 (45'8")	9440 (31'0")	11590 (38'0")	9480 (31'1")	11500 (37'9")	17130 (56'2")	17450 (57'3")		39700 (87,520/389)
PC1250-8 (SP spec) PC1250-8R (SP spec)	7.8 (25'7")	3.4 (11'2")	13000 (42'8")	8450 (27'9")	7900 (25'11")	5025 (16'6")	7745 (25'5")	13670 (44'10")	14070 (46'2")	58100 (128,110/570)	42000 (92,590/412)
PC1250-7 (SP spec)	7.8 (25'7")	3.4 (11'2")	13000 (42'8")	8450 (27'9")	7900 (25'11")	5025 (16'6")	7740 (25'5")	13670 (44'10")	14070 (46'2")	58100 (128,110/570)	42000 (92,590/412)
PC2000-8 PC2000-8*8	8.7 (28'7")	3.9 (12'10")	13410 (44'0")	8650 (28'5")	9235 (30'4")	2710 (8'11")	9115 (29'11")	15305 (50'3")	15780 (51'9")	71100 (156,750/697)	59800 (131,840/586)

* : USA source
 ** : UK source
 *** : China source
 *4 : India source
 *5 : Thailand source

*6 : Brazil source
 *7 : Russia source
 *8 : Indonesia source
 *9 : Italy source
 *10 : for USA

*11 : for UK
 *12 : for Russia

*1 : Using Power Max. function and ISO rating

Working Ranges and Digging Forces

EXCAVATORS (BACKHOE)

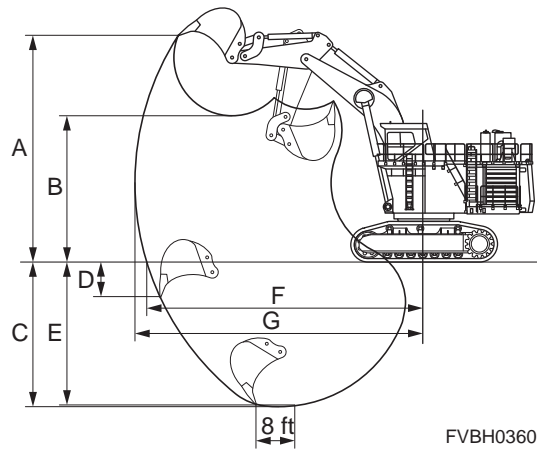
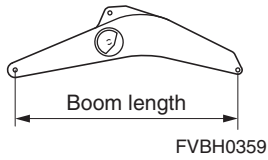
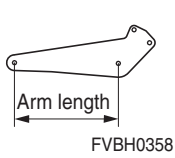

	Boom length m (ft.in)	Arm length m (ft.in)	A mm (ft.in)	B mm (ft.in)	C mm (ft.in)	D mm (ft.in)	E mm (ft.in)	F mm (ft.in)	G mm (ft.in)	Bucket digging force* ton (US ton/kN)	Arm crowd force* ton (US ton/kN)
PC3000-6	8.6 (28'3")	4.0 (13'1")	14100 (46'3")	9000 (29'6")	7900 (25'11")	3200 (10'6")	7800 (25'7")	15600 (51'2")	16200 (53'2")	86.6 (95.5/850)	81.5 (89.8/800)
PC4000-6	9.75 (32'0")	4.5 (14'9")	15000 (49'3")	9700 (31'10")	8000 (26'3")	3000 (9'10")	7900 (25'11")	16650 (54'8")	17500 (57'5")	117.7 (129.7/1155)	107 (117.9/1050)
PC5500-6	11.0 (36'1")	5.1 (16'9")	15000 (49'3")	10100 (33'2")	8300 (27'3")	3000 (9'10")	8200 (26'11")	18700 (61'4")	19800 (65'0")	147.8 (163.0/1450)	131.5 (145.0/1290)
PC8000-6	11.5 (37'9")	5.5 (18'1")	16900 (55'5")	11200 (36'9")	8000 (26'3")	2500 (8'2")	7900 (25'11")	19600 (64'4")	20700 (67'11")	203.8 (224.6/2000)	183.5 (202.3/1800)

* DIN rating

Component Dimensions and Weights

EXCAVATORS (BACKHOE)

Base machine

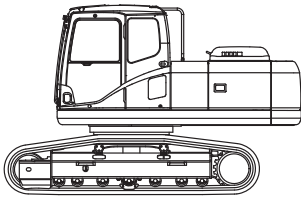

Boom with arm cylinder

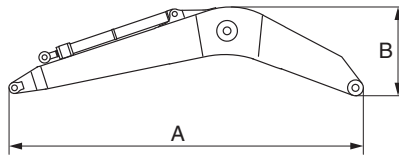

Arm with bucket cylinder

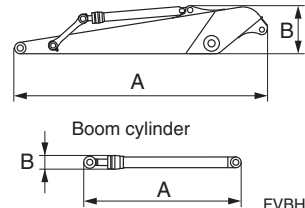

FVBH0173

Item			Model	PC200-8	PC200-7	PC220-8	PC220-7
Basic machine	Weight	STD	kg (lb)	15920 (35,100)	15720 (34,660)	18410 (40,590)	18250 (40,230)
		LC		17320 (38,180)	17120 (37,740)	19840 (43,740)	19680 (43,390)
		NLC		—	—	—	—
Boom with arm cylinder	A	mm (ft.in)	5900 (19'4")	5900 (19'4")	6045 (19'10")	6045 (19'10")	
	B	mm (ft.in)	1530 (5'0")	1530 (5'0")	1615 (5'4")	1615 (5'4")	
	Weight	kg (lb)	1410 (3,130)	1410 (3,130)	1830 (4,030)	1830 (4,030)	
	Arm size	m (ft.in)	1.84 (6'0")	1.84 (6'0")	2.0 (6'7")	2.0 (6'7")	
Arm with bucket cylinder and linkage	A	mm (ft.in)	2775 (9'1")	2775 (9'1")	3065 (10'1")	3065 (10'1")	
	B	mm (ft.in)	875 (2'10")	875 (2'10")	975 (3'2")	975 (3'2")	
	Weight	kg (lb)	911 (2,010)	911 (2,010)	1205 (2,660)	1205 (2,660)	
	Arm size	m (ft.in)	2.41 (7'11")	2.41 (7'11")	2.5 (8'2")	2.5 (8'2")	
	A	mm (ft.in)	3430 (11'3")	3430 (11'3")	3625 (11'11")	3625 (11'11")	
	B	mm (ft.in)	890 (2'11")	890 (2'11")	925 (3'0")	925 (3'0")	
	Weight	kg (lb)	930 (2,050)	930 (2,050)	1235 (2,720)	1235 (2,720)	
	Arm size	m (ft.in)	2.93 (9'7")	2.93 (9'7")	3.05 (10'0")	3.05 (10'0")	
	A	mm (ft.in)	3925 (12'11")	3925 (12'11")	4135 (13'7")	4135 (13'7")	
	B	mm (ft.in)	770 (2'6")	770 (2'6")	815 (2'8")	815 (2'8")	
	Weight	kg (lb)	955 (2,110)	955 (2,110)	1215 (2,680)	1215 (2,680)	
	Boom cylinder (Total weight)	A	mm (ft.in)	2005 (6'7")	2005 (6'7")	2015 (6'7")	2015 (6'7")
B		mm (ft.in)	337 (7'43)**	337 (7'43)**	340 (1'1")**	340 (1'1")**	
Weight		kg (lb)	—	—	200 × 2 (440 × 2)	200 × 2 (440 × 2)	
Weight		kg (lb)	—	—	—	—	
Backhoe bucket				See bucket arm combination			

Item			Model	PC228US-3 PC228US-3E0	PC240-8	PC300-7	PC350-7
Basic machine	Weight	STD	kg (lb)	18210 (40,150)	—	24600 (54,230)	25550 (56,330)
		LC		19510 (43,010)	20800 (45,860)	25700 (56,660)	26650 (58,750)
		NLC		—	20500 (45,190)	—	—
Boom with arm cylinder	A	mm (ft.in)	5875 (19'3")	6040 (19'10")	6715 (22'0")	6715 (22'0")	
	B	mm (ft.in)	1450 (4'9")	1555 (5'1")	1625 (5'4")	1625 (5'4")	
	Weight	kg (lb)	1720 (3,790)	2060 (4,540)	2510 (5,530)	2510 (5,530)	
	Arm size	m (ft.in)	2.93 (9'7")	2.0 (6'7")	2.22 (7'3")	3.2 (10'6")	
Arm with bucket cylinder and linkage	A	mm (ft.in)	3905 (12'10")	3050 (10')	3455 (11'4")	4380 (14'4")	
	B	mm (ft.in)	725 (2'5")	920 (3')	1150 (3'9")	990 (3'3")	
	Weight	kg (lb)	950 (2,090)	1140 (2,510)	1705 (3,760)	1805 (3,980)	
	Arm size	m (ft.in)	—	2.5 (8'2")	2.55 (8'4")	—	
	A	mm (ft.in)	—	3600 (11'10")	3735 (12'3")	—	
	B	mm (ft.in)	—	860 (2'10")	1040 (3'5")	—	
	Weight	kg (lb)	—	1020 (2,250)	1650 (3,640)	—	
	Arm size	m (ft.in)	—	3.05 (10')	3.2 (10'6")	—	
	A	mm (ft.in)	—	4105 (13'6")	4380 (14'4")	—	
	B	mm (ft.in)	—	770 (2'6")	955 (3'2")	—	
	Weight	kg (lb)	—	1125 (2,480)	1700 (3,750)	—	
	Boom cylinder (Total weight)	A	mm (ft.in)	2005 (6'7")	2040 (6'8")	2215 (7'3")	2215 (7'3")
B		mm (ft.in)	250 (9.8")	280 (11")	405 (1'4")**	405 (1'4")**	
Weight		kg (lb)	180 × 2 (410 × 2)	253 × 2 (560 × 2)	225 × 2 (496 × 2)	225 × 2 (496 × 2)	
Weight		kg (lb)	—	—	—	—	
Backhoe bucket				See bucket arm combination			

* UK source
** With piping

Component Dimensions and Weights

EXCAVATORS (BACKHOE)

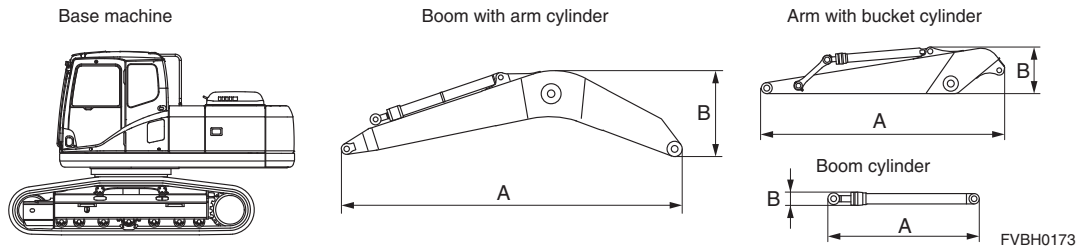

FVBH0173



Item			Model	PC300-8	PC350-8	PC400-8 PC400-8R	PC400-7
Basic machine	Weight	STD	kg (lb)	24950 (55,000)	25750 (56,770)	33740 (74,380)	33160 (73,100)
		LC		26050 (57,430)	26810 (59,110)	34740 (76,590)	34810 (76,740)
		NLC		—	—	—	—
Boom with arm cylinder	A	mm (ft.in)	6715 (22'0")	6715 (22'0")	7290 (23'11")	7290 (23'11")	
	B	mm (ft.in)	1625 (5'4")	1625 (5'4")	1695 (5'7")	1695 (5'7")	
	Weight	kg (lb)	2510 (5,530)	2510 (5,530)	4000 (8,820)	4000 (8,820)	
	Arm size	m (ft.in)	2.22 (7'3")	3.2 (10'6")	2.4 (7'10")	2.4 (7'10")	
	A	mm (ft.in)	3455 (11'4")	4380 (14'4")	3705 (12'2")	3705 (12'2")	
	B	mm (ft.in)	1150 (3'9")	990 (3'3")	1080 (3'7")	1080 (3'7")	
	Weight	kg (lb)	1705 (3,760)	1805 (3,980)	2030 (4,480)	2030 (4,480)	
	Arm size	m (ft.in)	2.55 (8'4")	—	2.9 (9'6")	2.9 (9'6")	
	A	mm (ft.in)	3735 (12'3")	—	4215 (13'10")	4215 (13'10")	
	B	mm (ft.in)	1040 (3'5")	—	995 (3'4")	995 (3'4")	
	Weight	kg (lb)	1650 (3,640)	—	2150 (4,740)	2150 (4,740)	
	Arm size	m (ft.in)	3.2 (10'6")	—	3.38 (11'1")	3.38 (11'1")	
	A	mm (ft.in)	4380 (14'4")	—	4615 (15'2")	4615 (15'2")	
	B	mm (ft.in)	955 (3'2")	—	975 (3'2")	975 (3'2")	
	Weight	kg (lb)	1700 (3,750)	—	2200 (4,850)	2200 (4,850)	
	Arm size	m (ft.in)	4.02 (13'2")	—	4.0 (13'1")	4.0 (13'1")	
	A	mm (ft.in)	5205 (17'1")	—	5235 (17'2")	5235 (17'2")	
	B	mm (ft.in)	945 (3'1")	—	965 (3'2")	965 (3'2")	
	Weight	kg (lb)	1980 (4,365)	—	2440 (5,380)	2440 (5,380)	
	A	m (ft.in)	—	—	—	—	
	B	mm (ft.in)	—	—	—	—	
	Weight	mm (ft.in) kg (lb)	— —	— —	— —	— —	
Boom cylinder (Total weight)	A	mm (ft.in)	2215 (7'3")	2215 (7'3")	2445 (8'1")	2445 (8'1")	
	B	mm (ft.in)	405 (1'4")**	405 (1'4")**	225 (8.9")	225 (8.9")	
	Weight	kg (lb)	225 × 2 (496 × 2)	225 × 2 (496 × 2)	400 × 2 (880 × 2)	400 × 2 (880 × 2)	
Backhoe bucket				See bucket arm combination			

Item			Model	PC450-7	PC450-8 PC450-8R		
Basic machine	Weight	STD	kg (lb)	33620 (74,120)	34320 (75,660)		
		LC		34620 (76,320)	35320 (77,870)		
		NLC		—	—		
Boom with arm cylinder	A	mm (ft.in)	7290 (23'11")	7290 (23'11")			
	B	mm (ft.in)	1695 (5'7")	1695 (5'7")			
	Weight	kg (lb)	4200 (9,260)	4200 (9,260)			
	Arm size	m (ft.in)	3.38 (11'1")	3.38 (11'1")			
	A	mm (ft.in)	4705 (15'5")	4705 (15'5")			
	B	mm (ft.in)	1055 (3'6")	1055 (3'6")			
	Weight	kg (lb)	2400 (5,290)	2400 (5,290)			
	Arm size	m (ft.in)	—	—			
	A	mm (ft.in)	—	—			
	B	mm (ft.in)	—	—			
	Weight	kg (lb)	—	—			
	Arm size	m (ft.in)	—	—			
	A	mm (ft.in)	—	—			
	B	mm (ft.in)	—	—			
	Weight	kg (lb)	—	—			
	A	m (ft.in)	—	—			
	B	mm (ft.in)	—	—			
	Weight	mm (ft.in) kg (lb)	— —	— —			
Boom cylinder (Total weight)	A	mm (ft.in)	2445 (8'1")	2445 (8'1")			
	B	mm (ft.in)	225 (8.9")	225 (8.9")			
	Weight	kg (lb)	400 × 2 (880 × 2)	400 × 2 (880 × 2)			
Backhoe bucket				See bucket arm combination			

** With piping

PC600 / 600LC-8E0, PC600/600LC-8R1

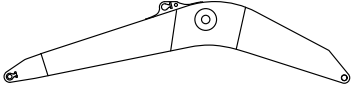
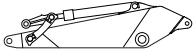
Unit: mm (ft.in)

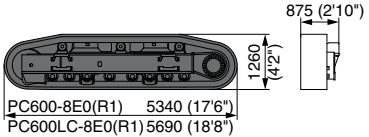
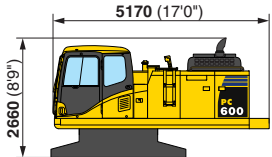
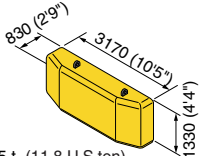
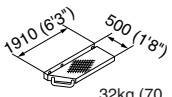
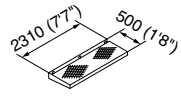
Four-part transportation	
<p>(1) Work equipment assembly</p> <div style="display: flex; flex-direction: column; gap: 10px;"> <div style="display: flex; align-items: center;"> <div style="margin-right: 10px;">Boom</div>  <div style="margin-left: 10px; font-size: small;">FVPM3162</div> </div> <div style="display: flex; align-items: center;"> <div style="margin-right: 10px;">Arm</div>  <div style="margin-left: 10px; font-size: small;">FVPM3163</div> </div> <div style="display: flex; justify-content: space-around; align-items: center;"> <div style="display: flex; flex-direction: column; gap: 5px;"> <div style="margin-right: 10px;">Bucket</div>  <div style="margin-right: 10px; font-size: small;">FVPM3164</div> </div> <div style="display: flex; flex-direction: column; gap: 5px;"> <div style="margin-right: 10px;">Boom & arm cylinder</div>  <div style="margin-left: 10px; font-size: small;">FVPM3164</div> </div> </div> </div>	<p>(3) Undercarriage</p>  <p style="font-size: small; margin-top: 5px;">PC600-8E0(R1) 5340 (17'6") PC600LC-8E0(R1) 5690 (18'8")</p> <div style="text-align: right; font-size: small;">FVPM3166A</div>
<p>(2) Upper structure</p> <div style="display: flex; justify-content: space-between; align-items: center;"> <div style="text-align: center;">  </div> <div style="text-align: right;"> <p>Width: 3170 (10'5")</p> </div> </div>	<p>(4) Others</p> <div style="display: flex; flex-direction: column; gap: 20px;"> <div style="display: flex; align-items: center;">  <div style="margin-left: 10px;"> <p>10.75 t (11.8 U.S.ton)</p> </div> </div> <div style="display: flex; justify-content: space-around;"> <div style="display: flex; align-items: center;">  <div style="margin-left: 10px;"> <p>32kg (70 lb)</p> </div> </div> <div style="display: flex; align-items: center;">  <div style="margin-left: 10px;"> <p>37kg (82 lb)</p> </div> </div> </div> <div style="text-align: right; font-size: small;">FVPM3167A</div> </div>

Three-part transportation

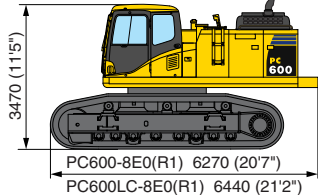
<p>(1) Work equipment assembly</p> <p style="text-align: center; font-size: large;">The same as four-part transportation</p>	<p>(3) Others</p> <p style="text-align: center; font-size: large;">The same as four-part transportation</p>
<p>(2) Base machine</p> <div style="display: flex; justify-content: space-between; align-items: center;"> <div style="text-align: center;">  </div> <div style="text-align: right;"> <p>Max. width: 3195 (10'6")</p> </div> </div>	

* KOMTRAX (optional) with an antenna when mounted

Component Dimensions and Weights

EXCAVATORS (BACKHOE)

PC600/600LC-8E0, PC600/600LC-8R1

Specification Table for Transportation

No. of Part for Transportation		Item		Related Specifications		PC600-8E0(R1)	PC600-8E0(R1) (Quarry spec.)	PC600LC-8E0(R1)	PC600-8E0(R1) (SE spec.)	
Four-part	(1)	Work Equipment	Boom	Overall length	mm (fi.in)	7920 (26'0")	7530 (24'8")	7920 (26'0")	6870 (22'6")	
				Overall width	mm (fi.in)	1190 (3'11")	1190 (3'11")	1190 (3'11")	1190 (3'11")	
				Overall height	mm (fi.in)	2040 (6'8")	1960 (6'5")	2040 (6'8")	2090 (6'10")	
				Weight	ton (US. ton)	4.9 (5.4)	4.7 (5.2)	4.9 (5.4)	4.8 (5.3)	
			Arm	Overall length	mm (fi.in)	4870 (16'0")	4870 (16'0")	4870 (16'0")	4230 (13'11")	
				Overall width	mm (fi.in)	650 (2'2")	650 (2'2")	650 (2'2")	650 (2'2")	
				Overall height	mm (fi.in)	1210 (4'0")	1240 (4'1")	1210 (4'0")	1490 (4'11")	
				Weight	ton (US. ton)	3.3 (3.6)	3.3 (3.6)	3.3 (3.6)	3.5 (3.9)	
			Bucket	Overall length	mm (fi.in)	2150 (7'1")	2150 (7'1")	2150 (7'1")	2150 (7'1")	
				Overall width	mm (fi.in)	1780 (5'10")	1920 (6'4")	1780 (5'10")	2040 (6'8")	
				Overall height	mm (fi.in)	1780 (5'10")	1780 (5'10")	1780 (5'10")	1780 (5'10")	
				Weight	ton (US. ton)	2.5 (2.8)	3.1 (3.4)	2.5 (2.8)	3.4 (3.7)	
		Cylinder	Overall length	mm (fi.in)	3110 (10'2")	3110 (10'2")	3110 (10'2")	3110 (10'2")		
			Weight	ton (US. ton)	1.7 (1.9)	1.7 (1.9)	1.7 (1.9)	1.7 (1.9)		
		(2)	Upper Structure	Overall length	mm (fi.in)	5170 (17'0")	5170 (17'0")	5170 (17'0")	5170 (17'0")	
				Overall width	mm (fi.in)	3170 (10'5")	3170 (10'5")	3170 (10'5")	3170 (10'5")	
	Overall height			mm (fi.in)	2660 (8'8")	2660 (8'8")	2660 (8'8")	2660 (8'8")		
	Weight			ton (US. ton)	18.4 (20.3)	18.5 (20.4)	18.4 (20.3)	18.4 (20.3)		
	(3)	Undercarriage	Overall length	mm (fi.in)	5340 (17'6")	5340 (17'6")	5690 (18'8")	5340 (17'6")		
			Overall width	mm (fi.in)	875 (2'11")	875 (2'11")	875 (2'11")	875 (2'11")		
			Overall height	mm (fi.in)	1260 (4'2")	1260 (4'2")	1260 (4'2")	1260 (4'2")		
			Weight	ton (US. ton)	16.0 (17.6)	16.0 (17.6)	17.0 (18.7)	16.0 (17.6)		
	(4)	Others (Counterweight)	Overall length	mm (fi.in)	3170 (10'5")	3170 (10'5")	3170 (10'5")	3170 (10'5")		
			Overall width	mm (fi.in)	830 (2'9")	830 (2'9")	830 (2'9")	830 (2'9")		
			Overall height	mm (fi.in)	1330 (4'4")	1330 (4'4")	1330 (4'4")	1330 (4'4")		
			Weight	ton (US. ton)	10.75 (11.8)	10.75 (11.8)	10.75 (11.8)	10.75 (11.8)		
	Three-part	(1)	Work Equipment	The same as four-part transportation						
		(2)	Base Machine	Overall length	mm (fi.in)	6270 (20'7")	6270 (20'7")	6440 (21'2")	6270 (20'7")	
Overall width				mm (fi.in)	3195 (10'6")	3195 (10'6")	3195 (10'6")	3195 (10'6")		
Overall height				mm (fi.in)	3470 (11'5")	3470 (11'5")	3470 (11'5")	3470 (11'5")		
Weight				ton (US. ton)	34.4 (37.9)	34.5 (38.0)	35.4 (39.0)	34.4 (37.9)		
(3)		Others (Counterweight)	The same as four-part transportation							

PC600/600LC-8 (UK source)

Base machine

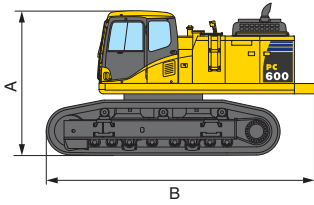

		PC600-8	PC600LC-8
Overall width	mm (ft.in)	3195 (10'6")	3195 (10'6")
A	mm (ft.in)	3330 (10'11")	3330 (10'11")
B	mm (ft.in)	6170 (20'3")	6340 (20'10")
Weight	ton (U.S. ton)	34.24 (37.7)	35.24 (38.8)

Undercarriage

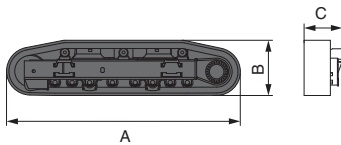

		PC600-8	PC600LC-8
A	mm (ft.in)	5340 (17'6")	5690 (18'8")
B	mm (ft.in)	1260 (4'2")	1260 (4'2")
C	mm (ft.in)	875 (2'10")	875 (2'10")
Weight	ton (U.S. ton)	16.4 (18.1)	17.4 (19.2)

Work equipment

Boom

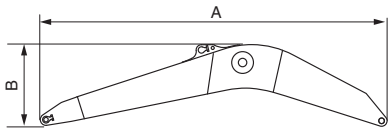

Boom length	mm (ft.in)	6600 (21'8")	7300 (23'11")	7600 (24'11")
Overall width	mm (ft.in)	1190 (3'11")	1190 (3'11")	1190 (3'11")
A	mm (ft.in)	6870 (22'6")	7545 (24'9")	7925 (26'0")
B	mm (ft.in)	2095 (6'10")	1960 (6'5")	2040 (6'8")
Weight (incl. arm cylinder)	ton (U.S. ton)	5.3 (5.8)	5.3 (5.8)	5.4 (5.95)

Arm

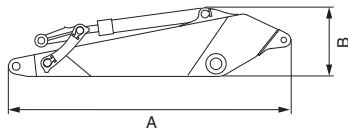

Arm length	mm (ft.in)	2900 (9'6")	3500 (11'6")
Overall width	mm (ft.in)	480 (1'7")	480 (1'7")
A	mm (ft.in)	4285 (14'1")	4885 (16'0")
B	mm (ft.in)	1430 (4'8")	1240 (4'1")
Weight (incl. bucket cylinder & linkage)	ton (U.S. ton)	3.4 (3.7)	3.3 (3.6)

Counterweight

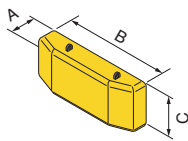

A	mm (ft.in)	680 (2'3")
B	mm (ft.in)	3195 (10'6")
C	mm (ft.in)	1330 (4'4")
Weight	ton (U.S. ton)	10.75 (11.8)

Cylinders

Boom & arm cylinders

Weight	ton (U.S. ton)	1.8 (2.0)
--------	----------------	-----------

PC600/600LC-7 (for Russia)

Four-part transportation

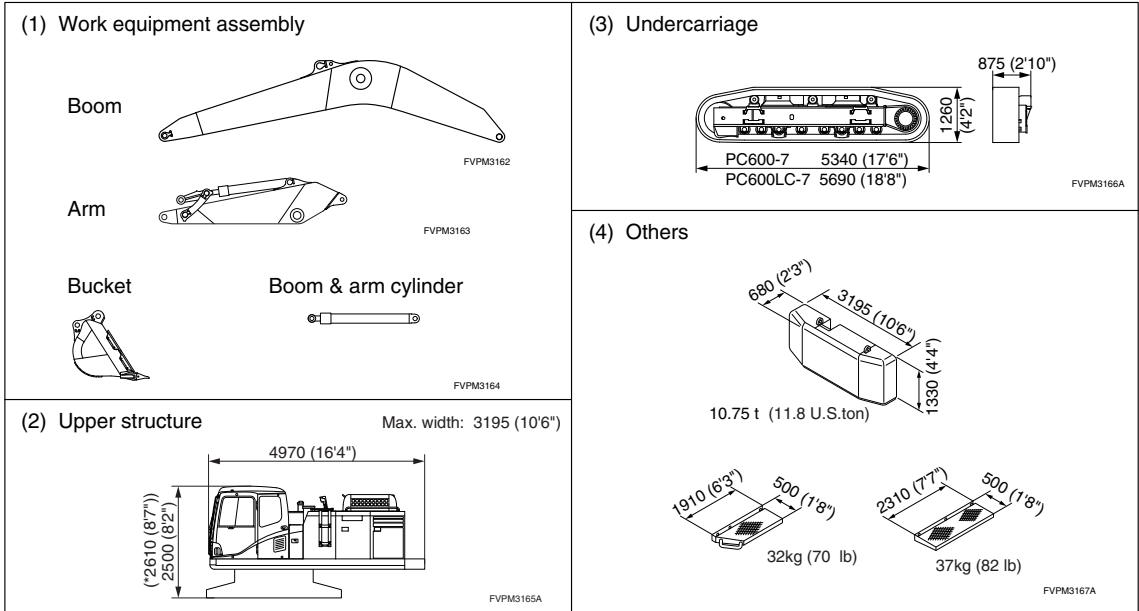

Three-part transportation

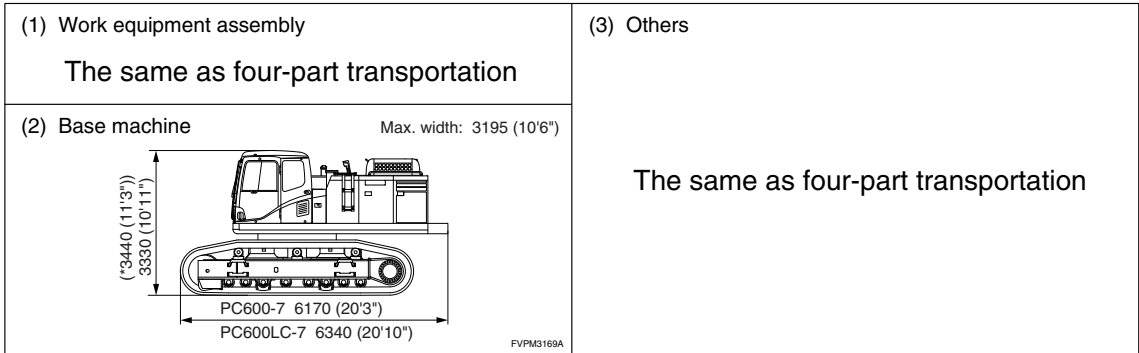

* KOMTRAX (optional) with an antenna when mounted

Component Dimensions and Weights

EXCAVATORS (BACKHOE)

PC600/600LC-7 (for Russia)

Specification Table for Transportation

No. of Part for Transportation		Item	Related Specifications	PC600-7	PC600-7 (Quarry spec.)	PC600LC-7	PC600-7 (SE spec.)		
Four-part	(1)	Work Equipment	Boom	Overall length	mm (fi.in)	7920 (26'0")	7530 (24'8")	7920 (26'0")	6870 (22'6")
				Overall width	mm (fi.in)	1190 (3'11")	1190 (3'11")	1190 (3'11")	1190 (3'11")
				Overall height	mm (fi.in)	2040 (6'8")	1960 (6'5")	2040 (6'8")	2090 (6'10")
				Weight	ton (US. ton)	4.8 (5.3)	4.7 (5.2)	4.8 (5.3)	4.7 (5.0)
		Arm	Overall length	mm (fi.in)	4870 (16'0")	4870 (16'0")	4870 (16'0")	4230 (13'11")	
			Overall width	mm (fi.in)	480 (1'7")	480 (1'7")	480 (1'7")	480 (1'7")	
			Overall height	mm (fi.in)	1210 (4'0")	1240 (4'1")	1210 (4'0")	1430 (4'8")	
			Weight	ton (US. ton)	3.2 (3.5)	3.3 (3.6)	3.2 (3.5)	3.4 (3.7)	
		Bucket	Overall length	mm (fi.in)	2040 (6'8")	2040 (6'8")	2040 (6'8")	2260 (7'5")	
			Overall width	mm (fi.in)	1790 (5'10")	1870 (6'2")	1790 (5'10")	2120 (6'11")	
			Overall height	mm (fi.in)	1870 (6'2")	1880 (6'2")	1870 (6'2")	1800 (5'11")	
			Weight	ton (US. ton)	2.5 (2.8)	3.0 (3.3)	2.5 (2.8)	3.4 (3.7)	
		Cylinder	Overall length	mm (fi.in)	3110 (10'2")	3110 (10'2")	3110 (10'2")	3110 (10'2")	
			Weight	ton (US. ton)	1.8 (2.0)	1.8 (2.0)	1.8 (2.0)	1.8 (2.0)	
		(2)	Upper Structure	Overall length	mm (fi.in)	4970 (16'4")	4970 (16'4")	4970 (16'4")	4970 (16'4")
				Overall width	mm (fi.in)	3195 (10'6")	3195 (10'6")	3195 (10'6")	3195 (10'6")
	Overall height			mm (fi.in)	2500 (8'2")	2500 (8'2")	2500 (8'2")	2500 (8'2")	
	Weight			ton (US. ton)	16.8 (18.5)	16.9 (18.6)	16.8 (18.5)	16.8 (18.5)	
	(3)	Undercarriage	Overall length	mm (fi.in)	5340 (17'6")	5370 (17'7")	5690 (18'8")	5340 (17'6")	
			Overall width	mm (fi.in)	875 (2'11")	875 (2'11")	875 (2'11")	875 (2'11")	
			Overall height	mm (fi.in)	1260 (4'2")	1290 (4'3")	1260 (4'2")	1260 (4'2")	
			Weight	ton (US. ton)	16.4 (18.1)	17.4 (19.2)	17.4 (19.2)	16.4 (18.1)	
	(4)	Others (Counterweight)	Overall length	mm (fi.in)	3195 (10'6")	3195 (10'6")	3195 (10'6")	3195 (10'6")	
			Overall width	mm (fi.in)	680 (2'3")	680 (2'3")	680 (2'3")	680 (2'3")	
			Overall height	mm (fi.in)	1330 (4'4")	1330 (4'4")	1330 (4'4")	1330 (4'4")	
			Weight	ton (US. ton)	10.75 (11.8)	10.75 (11.8)	10.75 (11.8)	10.75 (11.8)	
	Three-part	(1)	Work Equipment	The same as four-part transportation					
		(2)	Base Machine	Overall length	mm (fi.in)	6170 (20'3")	6180 (20'4")	6340 (20'10")	6170 (20'3")
Overall width				mm (fi.in)	3195 (10'6")	3195 (10'6")	3195 (10'6")	3195 (10'6")	
Overall height				mm (fi.in)	3330 (10'11")	3340 (11'0")	3330 (10'11")	3330 (10'11")	
Weight				ton (US. ton)	33.2 (36.6)	34.3 (37.8)	34.2 (37.7)	33.2 (36.6)	
(3)		Others (Counterweight)	The same as four-part transportation						

PC700LC-8E0, PC700LC-8R

Four-part transportation

Unit: mm (ft.in)

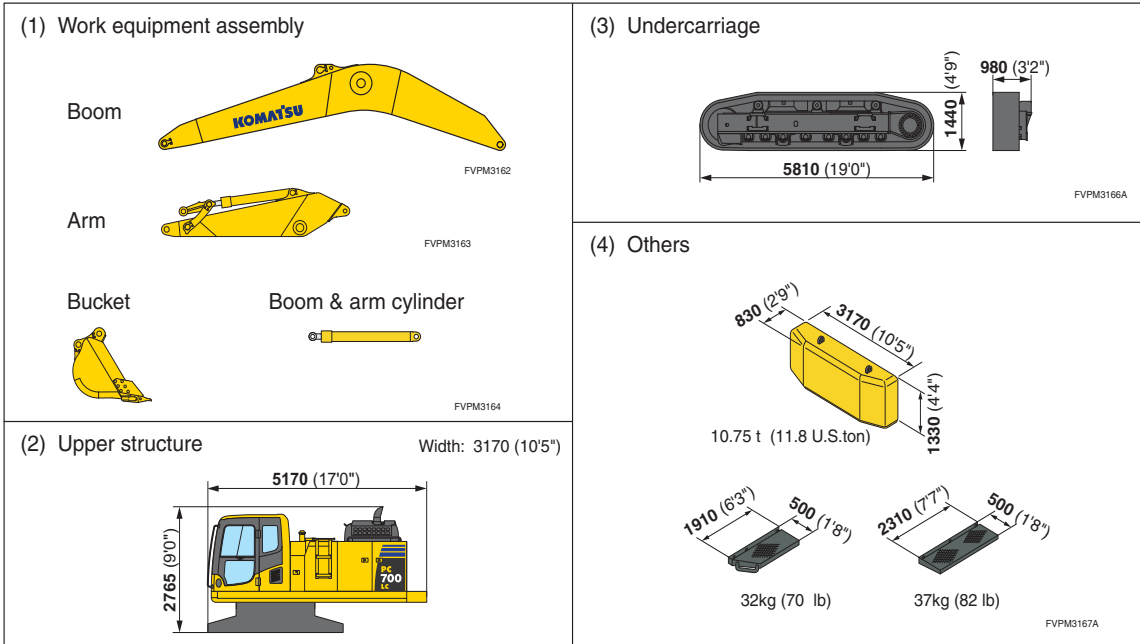

Three-part transportation

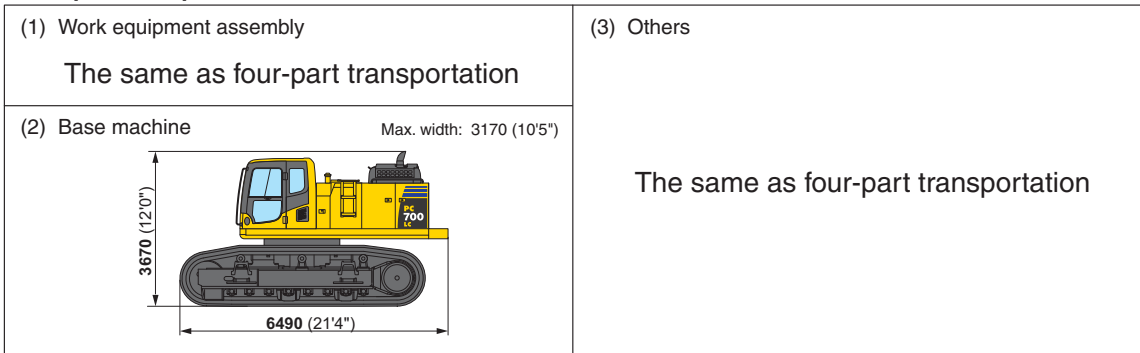

* KOMTRAX (optional) with an antenna when mounted

	Boom length mm (ft.in)	Arm length mm (ft.in)	Bucket capacity m ³ (cu.yd)	Shoes width mm (in)
PC700LC-8E0, PC700LC-8R	7660 (25'2")	3500 (11'6")	2.7 (3.53)	610 (24") Double
PC700LC-8E0, PC700LC-8R (HD Spec.)	7330 (23'11")	3500 (11'6")	2.8 (3.66)	610 (24") Double
PC700LC-8E0, PC700LC-8R (SE Spec.)	6600 (21'8")	2900 (9'6")	3.5 (4.58)	610 (24") Double

Work Equipment	Length mm (ft.in)	Height mm (ft.in)	Width mm (ft.in)	Weight ton (US ton)	
PC700LC-8E0, PC700LC-8R	Boom	7920 (26'0")	2040 (6'8")	4.9 (5.4)	
	Arm	4870 (16'0")	1210 (16'0")	3.3 (3.6)	
	Bucket	2150 (7'1")	1780 (5'8")	2.5 (2.8)	
PC700LC-8E0, PC700LC-8R (HD Spec.)	Boom	7530 (24'8")	1960 (6'5")	4.7 (5.2)	
	Arm	4870 (16'0")	1240 (4'0")	3.3 (3.6)	
	Bucket	2150 (7'1")	1780 (5'10")	1920 (6'4")	3.1 (3.4)
PC700LC-8E0, PC700LC-8R (SE Spec.)	Boom	6870 (22'6")	2090 (6'10")	4.8 (5.3)	
	Arm	4230 (13'10")	1490 (4'11")	650 (2'2")	3.5 (3.9)
	Bucket	2150 (7'1")	1780 (5'8")	2040 (6'8")	3.4 (3.7)

PC750/800-7 (for Russia)

Four-part transportation

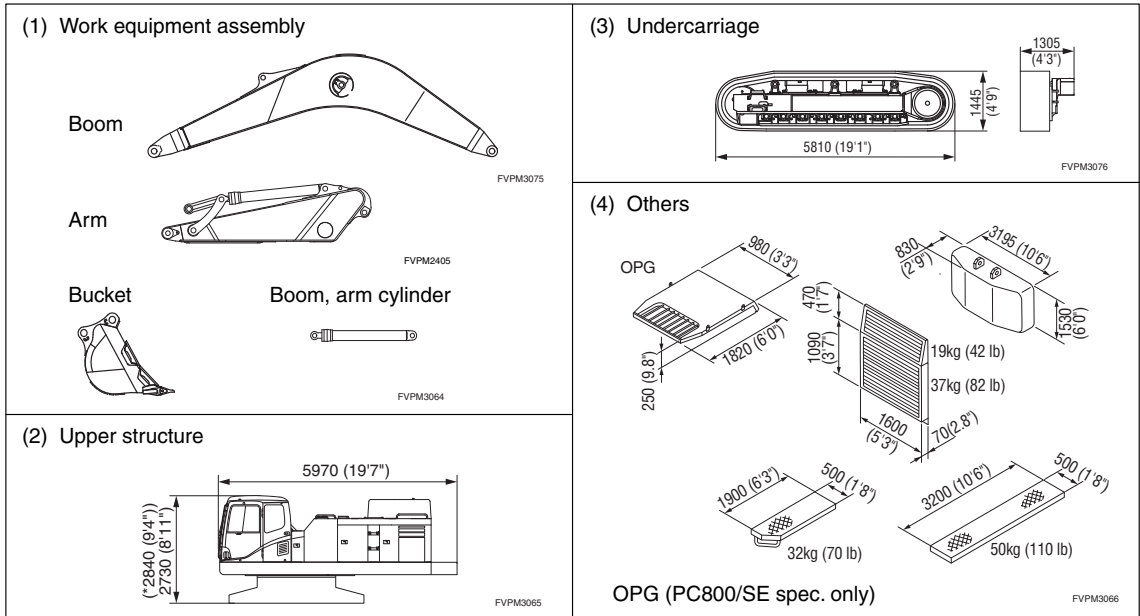

Three-part transportation

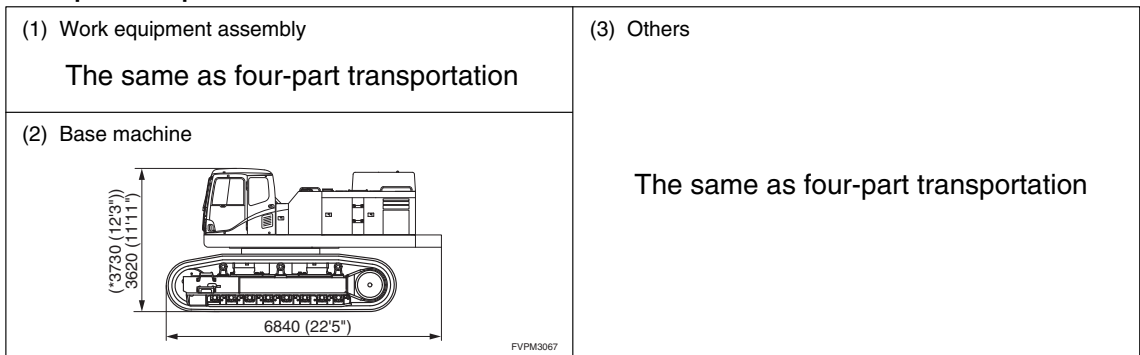

* KOMTRAX (optional) with an antenna when mounted

Component Dimensions and Weights

EXCAVATORS (BACKHOE)

PC750-7, PC750-7 (SE spec.) (for Russia)

Four-part transportation

		Length mm (ft.in)	Width mm (ft.in)	Height mm (ft.in)	Weight ton (US ton)	
1. Work equipment.						
Backhoe	Boom	PC750-7	8505 (27'11")	1500 (4'11")	2610 (8'7")	7.4 (8.2)
		PC750-7 (SE spec.)	7405 (24'4")	1500 (4'11")	2465 (8'1")	6.8 (7.6)
	Arm	PC750-7	5105 (16'9")	750 (2'6")	1325 (4'4")	4.0 (4.4)
		PC750-7 (SE spec.)	4075 (13'4")	755 (2'6")	1695 (5'7")	4.9 (5.4)
	Bucket	PC750-7	2365 (7'9")	1845 (6'1")	1850 (6'1")	3.0 (3.3)
		PC750-7 (SE spec.)	2200 (7'3")	2105 (6'11")	1950 (6'5")	3.4 (3.7)
	Boom cylinder	PC750-7/PC750 (SE spec.)	3235 (10'7")	—	—	0.79 × 2 (0.87 × 2)
	Arm cylinder	PC750-7	3580 (11'9")	—	—	0.88 (0.97)
PC750-7 (SE spec.)		2595 (8'6")	—	—	0.5 × 2 (0.55 × 1)	
2. Upper structure		5970 (19'7")	3195 (10'6")	2730 (8'11")*	24.8 (27.3)	
3. Undercarriage		PC750-7/PC750-7 (SE spec.)	5810 (19'1")	1305 (4'3")	1445 (4'9")	20.7 (22.8)
4. Other (counterweight, etc.)		—	—	—	10.0 (11.0)	

* With KOMTRAX (optional) antenna: 2840 (9' 4")

Three-part transportation

		Length mm (ft.in)	Width mm (ft.in)	Height mm (ft.in)	Weight ton (US ton)
1. Work equipment		The same as four-part structure			
2. Base machine	PC750-7/PC750-7 (SE spec.)	6840 (22'5")	3390 (11'1")	3620 (11'1")	45.5 (50.2)
3. Other		The same as four-part structure			

* With KOMTRAX (optional) antenna: 3730 (12' 3")

PC800-7, PC800-7 (SE spec.)

Four-part transportation

		Length mm (ft.in)	Width mm (ft.in)	Height mm (ft.in)	Weight ton (US ton)	
1. Work equipment						
Backhoe	Boom	PC800-7	8345 (27'5")	1500 (4'11")	2600 (8'6")	7.7 (8.5)
		PC800-7 (SE spec.)	7405 (24'4")	1500 (4'11")	2465 (8'1")	6.9 (7.6)
	Arm	PC800-7	4800 (15'9")	750 (2'6")	1410 (4'8")	4.5 (5.0)
		PC800-7 (SE spec.)	4075 (13'4")	755 (2'6")	1695 (5'7")	4.9 (5.4)
	Bucket	PC800-7	2390 (7'10")	1870 (6'2")	1850 (6'1")	3.5 (3.9)
		PC800-7 (SE spec.)	2200 (7'2")	2255 (7'5")	1950 (6'5")	3.9 (4.3)
	Boom cylinder	PC800-7/PC800-7 (SE spec.)	3235 (10'7")	—	—	0.79 × 2 (0.87 × 2)
	Arm cylinder	PC800-7/PC800-7 (SE spec.)	2595 (8'6")	—	—	0.5 × 2 (0.55 × 1)
2. Upper structure		5970 (19'7")	3195 (10'6")	2730 (8'11")	24.9 (27.4)	
3. Undercarriage		5810 (19'1")	1305 (4'3")	1445 (4'9")	21.2 (23.4)	
4. Other (counterweight, etc.)		—	—	—	12.2 (13.4)	

Three-part transportation

		Length mm (ft.in)	Width mm (ft.in)	Height mm (ft.in)	Weight ton (US ton)
1. Work equipment		The same as four-part structure			
2. Base machine		6840 (22'5")	3390 (11'1")	3620 (11'1")	46.1 (50.8)
3. Other		The same as four-part structure			

PC800/850-8E0, PC800/850-8R1

Four-part transportation

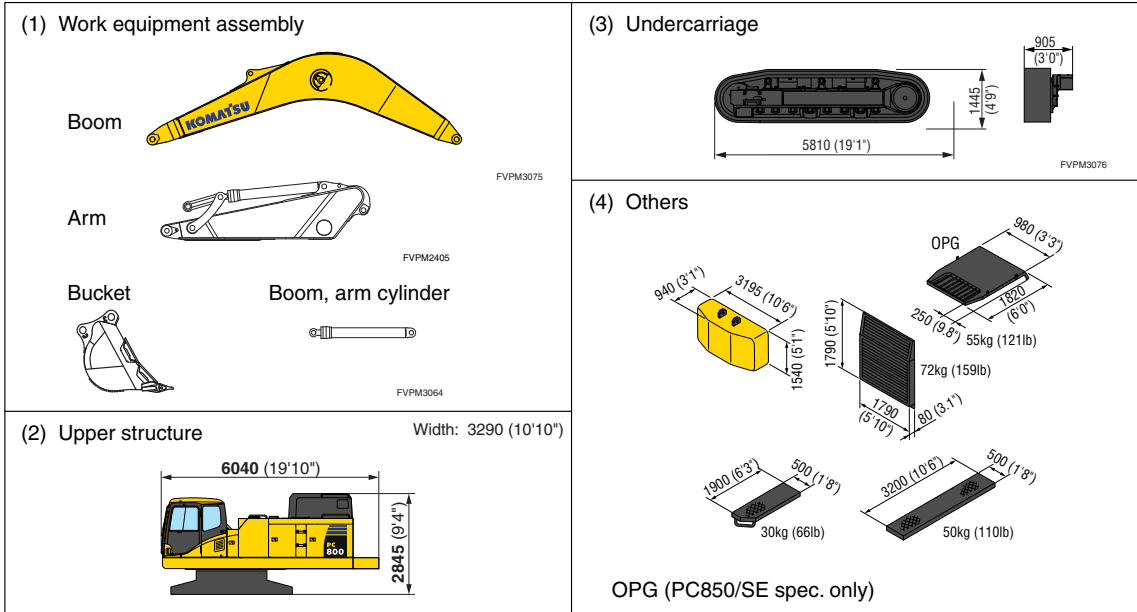

Three-part transportation

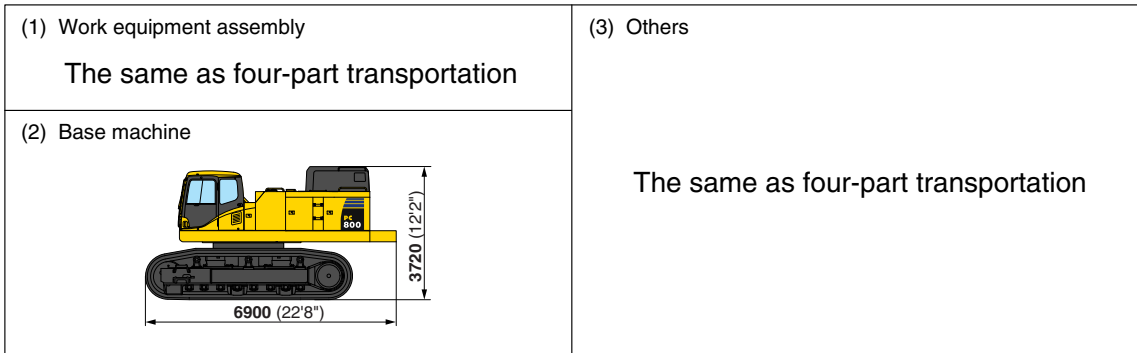

* KOMTRAX (optional) with an antenna when mounted

Component Dimensions and Weights

EXCAVATORS (BACKHOE)

PC800/850-8E0, PC800/850-8R1

Specification Table for Transportation

No. of Part for Transportation		Item		Related Specifications		PC800-8E0 PC800-8R1	PC800-8E0, R1 (SE spec.)	PC850-8E0 PC850-8R1	PC850-8E0, R1 (SE spec.)
Four-part	(1)	Work Equipment	Boom	Overall length	mm (fi.in)	8530 (28'0")	7430 (24'5")	8370 (27'6")	7430 (24'5")
				Overall width	mm (fi.in)	1500 (4'11")	1500 (4'11")	1500 (4'11")	1500 (4'11")
				Overall height	mm (fi.in)	2615 (8'7")	2480 (8'2")	2695 (8'10")	2480 (8'2")
				Weight	ton (US. ton)	7.9 (8.7)	7.3 (8.0)	8.1 (8.9)	7.3 (8.0)
			Arm	Overall length	mm (fi.in)	5115 (16'9")	4075 (13'4")	4765 (15'8")	4075 (13'4")
				Overall width	mm (fi.in)	710 (2'4")	715 (2'4")	710 (2'4")	715 (2'4")
				Overall height	mm (fi.in)	1365 (4'6")	1690 (5'7")	1450 (4'9")	1690 (5'7")
				Weight	ton (US. ton)	4.0 (4.4)	4.9 (5.4)	4.5 (5.0)	4.9 (5.4)
			Bucket	Overall length	mm (fi.in)	2430 (8'0")	2280 (7'6")	2470 (7'9")	2280 (7'6")
				Overall width	mm (fi.in)	1875 (6'2")	2100 (6'11")	2070 (6'9")	2250 (7'5")
				Overall height	mm (fi.in)	1855 (6'1")	1950 (6'5")	1880 (6'2")	1950 (6'5")
				Weight	ton (US. ton)	2.9 (3.2)	3.4 (3.7)	3.8 (4.2)	3.8 (4.2)
	Cylinder	Overall length	mm (fi.in)	3580 (11'9")	3235 (10'7")	3235 (10'7")	3235 (10'7")		
		Weight	ton (US. ton)	2.3 (2.5)	2.5 (2.8)	2.3 (2.5)	2.5 (2.8)		
	(2)	Upper Structure	Overall length	mm (fi.in)	6040 (19'10")	6040 (19'10")	6040 (19'10")	6040 (19'10")	
			Overall width	mm (fi.in)	3225 (10'7")	3225 (10'7")	3225 (10'7")	3225 (10'7")	
			Overall height	mm (fi.in)	2845 (9'4")	2845 (9'4")	2845 (9'4")	2845 (9'4")	
			Weight	ton (US. ton)	26.3 (29.0)	26.3 (29.0)	26.4 (29.1)	26.4 (29.1)	
	(3)	Undercarriage	Overall length	mm (fi.in)	5810 (19'1")	5810 (19'1")	5810 (19'1")	5810 (19'1")	
			Overall width	mm (fi.in)	905 (3'0")	905 (3'0")	1000 (3'3")	1000 (3'3")	
Overall height			mm (fi.in)	1445 (4'9")	1445 (4'9")	1445 (4'9")	1445 (4'9")		
Weight			ton (US. ton)	21.2 (23.4)	21.2 (23.4)	21.7 (23.9)	21.7 (23.9)		
(4)	Others (Counterweight)	Overall length	mm (fi.in)	3195 (10'6")	3195 (10'6")	3195 (10'6")	3195 (10'6")		
		Overall width	mm (fi.in)	940 (3'1")	940 (3'1")	940 (3'1")	940 (3'1")		
		Overall height	mm (fi.in)	1540 (5'1")	1540 (5'1")	1540 (5'1")	1540 (5'1")		
		Weight	ton (US. ton)	10.3 (11.4)	10.3 (11.4)	12.4 (13.7)	12.4 (13.7)		
Three-part	(1)	Work Equipment	The same as four-part transportation						
	(2)	Base Machine	Overall length	mm (fi.in)	6900 (22'8")	6900 (22'8")	6900 (22'8")	6900 (22'8")	
			Overall width	mm (fi.in)	3390 (11'1")	3390 (11'1")	3390 (11'1")	3390 (11'1")	
			Overall height	mm (fi.in)	3720 (12'2")	3720 (12'2")	3720 (12'2")	3720 (12'2")	
			Weight	ton (US. ton)	47.1 (51.9)	47.1 (51.9)	47.7 (52.6)	47.7 (52.6)	
(3)	Others (Counterweight)	The same as four-part transportation							

PC800/850-8 (UK source)

Base machine

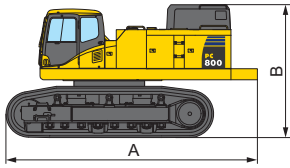

		PC800-8	PC800LC-8
A	mm (ft.in)	6900 (22'8")	7160 (23'6")
B	mm (ft.in)	3890 (12'9")	3890 (12'9")
Overall width	mm (ft.in)	3535 (11'7")	3535 (11'7")
Weight	ton (U.S. ton)	49.5 (54.6)	51.7 (57.0)

Upper structure

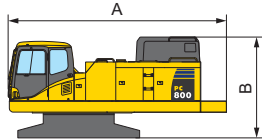

A	mm (ft.in)	6040 (19'10")
B	mm (ft.in)	3005 (9'10")
Overall width	mm (ft.in)	3295 (10'10")
Weight	ton (U.S. ton)	27.0 (29.8)

Undercarriage

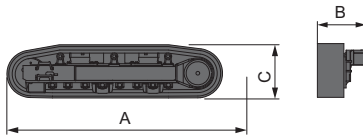

		PC800-8	PC800LC-8
Quantity		2	2
A	mm (ft.in)	5810 (19'1")	6330 (20'9")
B	mm (ft.in)	1000 (3'3")	1000 (3'3")
C	mm (ft.in)	1445 (4'9")	1445 (4'9")
Weight	ton (U.S. ton)	22.0 (24.3) {2 x 11.0 (12.1)}	24.2 (26.7) {2 x 12.1 (13.3)}

Boom

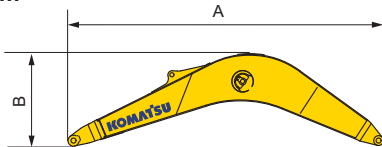

Boom length	m (ft.in)	7.1 (23'4")	8.0 (26'3")
A	mm (ft.in)	7430 (24'5")	8380 (27'6")
B	mm (ft.in)	2695 (8'10")	2695 (8'10")
Overall width	mm (ft.in)	1500 (4'11")	1500 (4'11")
Weight	ton (U.S. ton)	7.3 (8.0)	8.2 (9.0)

Arm

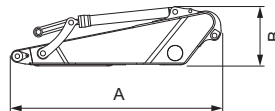

Arm length	m (ft.in)	2.9 (9'6")	3.6 (11'10")
A	mm (ft.in)	4080 (13'5")	5120 (16'10")
B	mm (ft.in)	1695 (5'7")	1420 (4'8")
Overall width	mm (ft.in)	750 (2'6")	750 (2'6")
Weight	ton (U.S. ton)	4.9 (5.4)	4.9 (5.4)

Counterweight

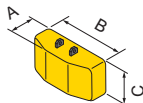

A	mm (ft.in)	950 (3'1")
B	mm (ft.in)	3195 (10'6")
C	mm (ft.in)	1540 (5'1")
Weight	ton (U.S. ton)	11.85 (13.1)

Cylinders

Boom cylinder

A	mm (ft.in)	3235 (10'7")
Weight	kg (lb)	1550 (3,420) {2 x 755 (1,660)}



Arm cylinder

A	mm (ft.in)	2595 (8'6")
Weight	kg (lb)	990 (2,180) {2 x 495 (1,090)}

PC1250/1250 (SP spec.)/1250LC-8, PC1250/1250-8R (SP spec.)

1. Work equipment ass'y (Backhoe)

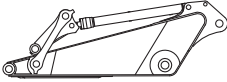
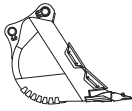
PC1250: 25.3t (27.9 US.ton)
PC1250 (SP spec.): 27.7t (30.5 US.ton)

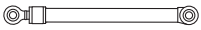
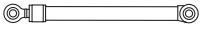
Boom	
PC1250: 11.2t (12.3USt) 9475x2894x1474 (31'1"x9'6"x4'10") PC1250 (SP spec.): 11.1t (12.2USt) 8170x3095x1474 (26'10"x10'2"x4'10")	FVBH0174
Arm	
PC1250: 5.9t (6.5USt) 4895x1626x890 (16'1"x5'4"x2'11") :6.2t (6.8USt) (Heavy-duty version) PC1250 (SP spec.): 6.4t (7.1USt) 4914x1683x890 (16'1"x5'6"x2'11")	FVBH0175
Bucket	
PC1250: 4.3t (4.7USt) 2700x2100x2050 (8'10"x6'11"x6'9") :5.5t (6.1USt) 2580x2276x2250 (8'6"x7'6"x7'5") (Heavy-duty version) PC1250 (SP spec.): 5.9t (6.5USt) 2527x2420x2520 (8'3"x7'11"x8'3")	FVBH0176
Arm cylinder 1.5t (1.7USt)	 Length: 3950 (13'0")
Boom cylinder 2.4t [1.2x2] (2.64USt) [1.32UStx2]	  Length: 3810 (12'6")

2. Upper structure

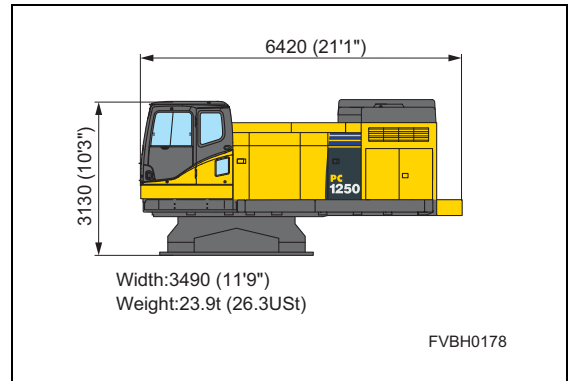

3. Undercarriage

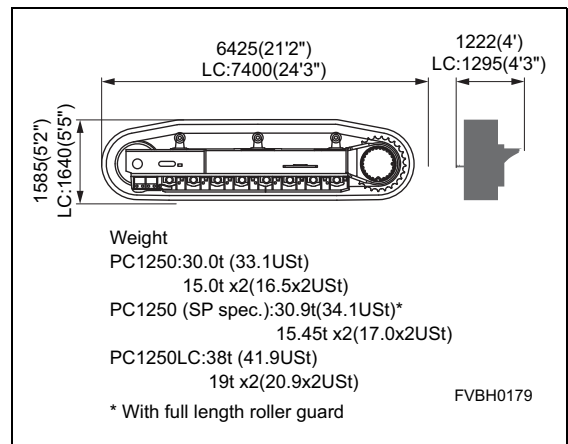

4. Others

18.4t (20.3 US.ton)

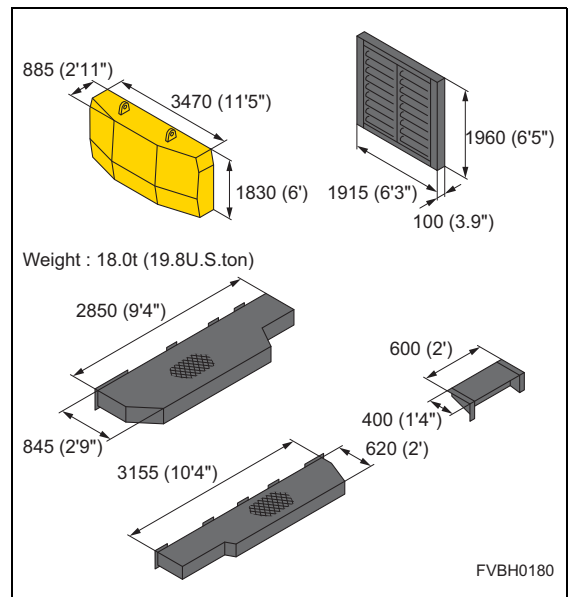



PC1250/1250-7 (SP spec.)

1. Work equipment ass'y (Backhoe)

PC1250: 25.1t (27.7 US.ton)

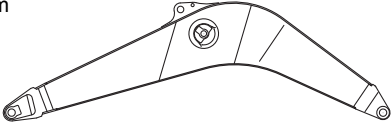
PC1250 (SP spec.): 27.0t (29.8 US.ton)

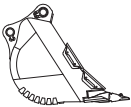
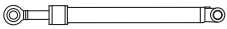
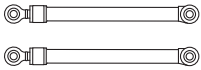
<p>Boom</p>  <p>PC1250: 11.0t 9475x2894x1474 (12.1USt) (31'1")x(9'6")x(4'10") PC1250 (SP spec.): 10.9t 8170x3095x1474 (12.0USt) (26'10")x(10'2")x(4'10") FVBH0174</p>	
<p>Arm</p>  <p>PC1250: 5.9t 4895x1626x890 (6.5USt) (16'1")x(5'4")x(2'11") PC1250 (SP spec.): 6.3t 4914x1683x890 (6.9USt) (16'1")x(5'6")x(2'11") FVBH0175</p>	
<p>Bucket</p>  <p>PC1250: 4.3t 2700x2100x2050 (4.7USt) (8'10")x(6'11")x(6'9") PC1250 (SP spec.): 5.9t 2527x2420x2520 (6.5USt) (8'3")x(7'11")x(8'3") FVBH0176</p>	
<p>Arm cylinder</p> <p>1.5t (1.7USt)</p> 	
<p>Boom cylinder</p> <p>2.4t [1.2tx2] (2.64USt) (1.32UStx2)</p> 	

2. Upper structure

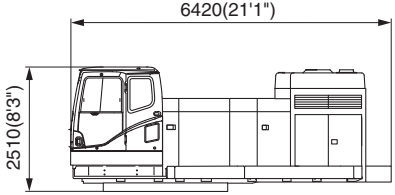

6420(21'1")

2510(8'3")

Width: 3490 (11'9")
Weight: 23.9t (26.3USt)

FVBH0178

3. Undercarriage

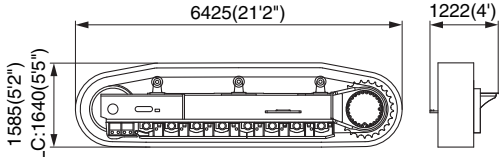

6425(21'2")

1585(5'2")
LC: 1640(5'5")

1222(4')

Weight
PC1250: 30.0t (33.1USt)
15.0t x2(16.5x2USt)
PC1250 (SP spec.): 30.9t(34.1USt)*
15.45t x2(17.0x2USt)

* With full length roller guard

FVBH0179

4. Others

27.7t (30.5 US.ton)

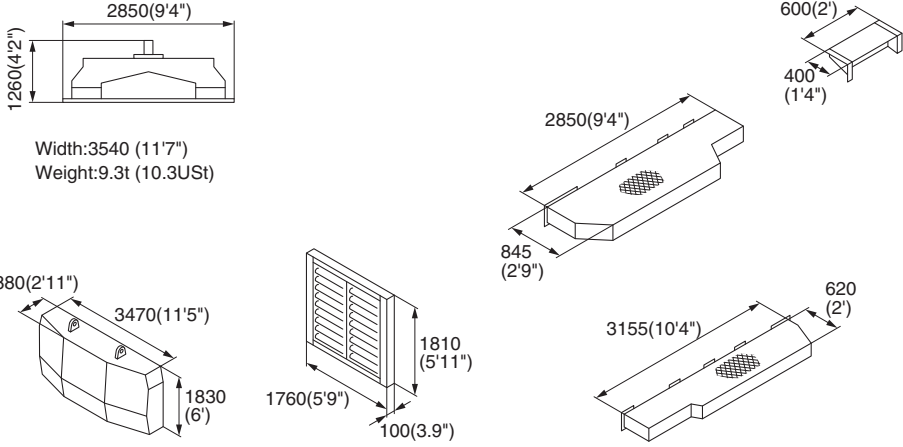

2850(9'4")

1260(4'2")

Width: 3540 (11'7")
Weight: 9.3t (10.3USt)

600(2')

400(1'4')

2850(9'4")

845(2'9")

3155(10'4")

620(2')

1810(5'11")

1760(5'9")

100(3.9")

880(2'11")

3470(11'5")

1830(6')







18.0t(19.8USt)

FVBH0180

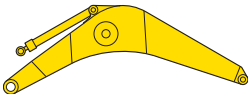
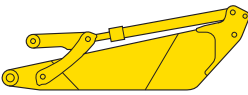
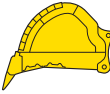
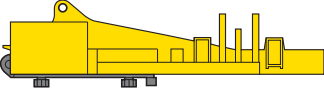
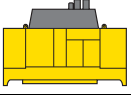
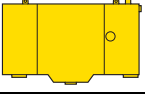
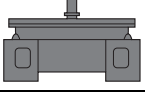
Component Dimensions and Weights

EXCAVATORS (BACKHOE)







PC2000-8

Unit name	Dimension	Length mm (ft.in.)	Width mm (ft.in.)	Height mm (ft.in.)	Weight ton (U.S. ton)
1. Boom		9170 (30'1")	2065 (6'9")	3195 (10'6")	20.9 (23.0)
2. Arm		5495 (18'0")	1605 (5'3")	2055 (6'9")	12.9 (14.2)
3. Bucket		3540 (11'7")	2790 (9'2")	2320 (7'7")	9.7 (10.7)
4. Revolving frame		7575 (24'10")	3180 (10'5")	2640 (8'8")	26.5 (29.2)
5. Power module		2515 (17'1")	2455 (8'1")	3195 (10'6")	16.1 (17.7)
6. Fuel tank		3100 (10'2")	875 (2'10")	2070 (6'10")	2.4 (2.65)
7. Center frame		3815 (12'6")	3190 (10'6")	2210 (7'3")	18.0 (19.8)
8. Undercarriage		7435 (24'5")	1720 (5'8")	1920 (6'4")	26.0 × 2 (28.1 × 2)
9. Cab base		3660 (12'0")	2505 (8'3")	2700 (8'10")	2.5 (2.8)
10. Operator cab		2885 (9'6")	1880 (6'2")	2520 (8'3")	1.8 (1.98)
11. Counterweight		6420 (21'1")	1115 (3'8")	1505 (4'11")	24.5 (27.0)
12. Hydraulic tank		1860 (6'1")	1115 (3'8")	2125 (7'0")	3.5 (3.86)
13. Cylinders and Others					9.7 (10.7)

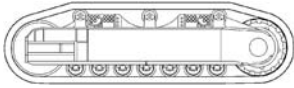
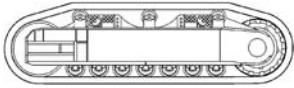
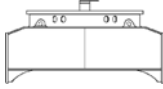
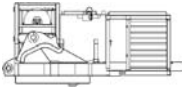
Component Dimensions and Weights

EXCAVATORS (BACKHOE)

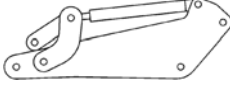





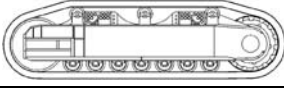
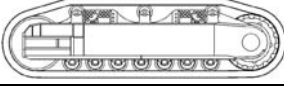
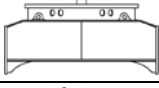
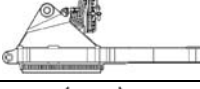

PC3000-6

Unit name	Dimension	Length mm (ft.in.)	Width mm (ft.in.)	Height mm (ft.in.)	Weight ton (U.S. ton)
Left Crawler Side Frame with 800 mm (31.5") Tracks		7930 (26'0")	1600 (5'3")	2210 (7'3")	31.9 (35.2)
Right Crawler Side Frame with 800 mm (31.5") Tracks		7930 (26'0")	1600 (5'3")	2210 (7'3")	31.9 (35.2)
Carbody with Rotary Joint		4020 (13'2")	3630 (11'11")	2130 (7'0")	19.5 (21.5)
Superstructure Platform with Machine House incl. 1 Diesel Engine, Hydraulic Tank and Hydraulic Cooler		7950 (26'1")	5250 (17'3")	3600 (11'10")	70 (77.2)
Counterweight		5050 (16'7")	1050 (3'5")	2840 (9'4")	30.5 (33.6)
Fuel Tank		2220 (7'3")	1600 (5'3")	2790 (9'2")	2.3 (2.5)
Cab Base		2520 (8'3")	2300 (7'7")	2800 (9'2")	3.25 (3.6)
Boom 8.6 m (28'3")		9200 (30'2")	2450 (8'0")	3100 (10'2")	26.3 (29.0)
Arm 4.0 m (13'1") with 2 cylinders, link and rod		5670 (18'7")	2010 (6'7")	2100 (6'11")	9.25 (10.2)
Backhoe Bucket 15 m ³ (19.6 cu.yd) SAE incl. Standard Wear Package WP 2		3580 (11'9")	3530 (11'7")	3120 (10'3")	16.1 (17.7)
Case with Accessories		3500 (11'6")	2400 (7'10")	3150 (10'4")	3.8 (4.2)
Case with Accessories		5800 (19'0")	2500 (8'2")	2000 (6'7")	4 (4.4)
Case with Accessories		4900 (16'1")	1300 (4'3")	1540 (5'1")	5.3 (5.8)
Case with Accessories		4900 (16'1")	1300 (4'3")	1540 (5'1")	7 (7.7)

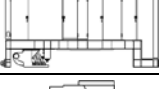
Component Dimensions and Weights

EXCAVATORS (BACKHOE)









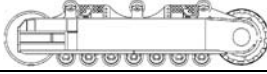

PC4000-6

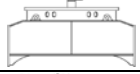
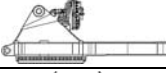
Unit name	Dimension	Length mm (ft.in.)	Width mm (ft.in.)	Height mm (ft.in.)	Weight ton (U.S. ton)
Left Crawler Side Frame with 1200 mm (47.2") Tracks		8850 (290")	1600 (5'3")	2500 (8'2")	58.0 (63.9)
Right Crawler Side Frame with 1200 mm (47.2") Tracks		8850 (290")	1600 (5'3")	2500 (8'2")	58.0 (63.9)
Carbody with Rotary Joint		4670 (15'4")	4070 (13'4")	2270 (7'5")	30.1 (33.2)
Superstructure Platform		8430 (27'8")	4435 (14'7")	3930 (12'11")	50.3 (55.4)
Counterweight		6100 (20'0")	950 (3'1")	3320 (10'11")	37 (40.8)
Main Machinery House incl. 1 Diesel Engine		6500 (21'4")	2750 (9'0")	3250 (10'8")	30.4 (33.5)
Fuel Tank		2390 (7'10")	2060 (6'9")	3280 (10'9")	3.5 (3.9)
Hydraulic Tank		2400 (7'10")	1370 (4'6")	3300 (10'10")	3.4 (3.7)
Cab Base		2400 (7'10")	2060 (6'9")	3020 (9'11")	3.8 (4.2)
Boom 9.75 m (32')		10450 (34'3")	2700 (8'10")	3700 (12'2")	34.1 (37.6)
Arm 4.5 m (14'9") with 2 cylinders, linkage and rod		6300 (20'8")	1900 (6'3")	2500 (8'2")	25.2 (27.8)
Backhoe Bucket 22 m ³ (28.8 cu.yd) SAE incl. Standard Wear Package WP 2		3800 (12'6")	4000 (13'1")	3600 (11'10")	23.4 (25.9)
Case with Oil Cooler		5770 (18'11")	2490 (8'2")	1980 (6'6")	3.4 (3.7)
Case with Driver's Cab and with intermediate base		3890 (12'9")	3290 (10'10")	3280 (10'9")	5 (5.5)
Case with Accessories		5800 (19'0")	2500 (8'2")	2100 (6'11")	4 (4.4)
Case with Accessories		5870 (19'3")	1290 (4'3")	1480 (4'10")	6 (6.6)
Case with Accessories		5870 (19'3")	1290 (4'3")	1480 (4'10")	9 (9.9)

Component Dimensions and Weights

EXCAVATORS (BACKHOE)









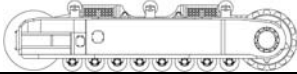

PC5500-6

Unit name	Dimension	Length mm (ft.in.)	Width mm (ft.in.)	Height mm (ft.in.)	Weight ton (U.S. ton)
Left Crawler Side Frame without Tracks		9300 (30'6")	1500 (4'11")	2300 (7'7")	40 (44.1)
Right Crawler Side Frame without Tracks		9300 (30'6")	1500 (4'11")	2300 (7'7")	40 (44.1)
6 x 1 Chain with 12 Track Shoes 1350 mm (53") each 8.55 t (9.4 US ton)		6000 (19'8")	1350 (4'5")	400 (1'4")	51.3 (56.5)
2 x 1 Chain with 10 Track Shoes 1350 mm (53") each 7.1 t (7.8 US ton)		5050 (16'7")	1350 (4'5")	400 (1'4")	14.2 (15.7)
Carbody with Rotary Joint		5130 (16'10")	4690 (15'7")	2380 (7'10")	45 (49.6)
Superstructure Platform		9650 (31'7")	4510 (14'10")	4400 (14'5")	85 (93.6)
Counterweight		6600 (21'8")	1140 (3'9")	3320 (10'11")	42 (46.3)
Main Machinery House incl. 2 Diesel Engines		7100 (23'4")	4050 (13'3")	3300 (10'10")	46.5 (51)
Fuel Tank		2800 (9'2")	2250 (7'5")	3300 (10'10")	7 (7.7)
Hydraulic Tank		2390 (7'10")	1300 (4'3")	3300 (10'10")	3.4 (3.7)
Cab Base		2200 (7'3")	1950 (6'5")	3050 (10'0")	3.8 (4.2)
Boom 11 m (36'1")		11800 (38'8")	3300 (10'10")	3000 (9'10")	51.1 (56.3)
Arm 5.1 m (18'1")		7200 (23'8")	2200 (7'2")	2300 (7'7")	32.5 (35.7)
Backhoe 29 m ³ (37.9 cu.yd) SAE incl. Standard Wear Package WP 2		4400 (14'5")	4400 (14'5")	3800 (12'6")	33.5 (36.9)
Case with Oil Cooler		4000 (13'1")	2700 (8'10")	2300 (7'7")	5.4 (6.0)
Case with Driver's Cab and with Intermediate Base		4000 (13'1")	3300 (10'10")	3200 (10'6")	6.6 (7.3)
Case with 2 Gear Boxes		5600 (18'4")	2700 (8'10")	2250 (7'5")	16.6 (18.3)
Case with 2 Boom Cylinders		6400 (21'0")	1400 (4'7")	1520 (5'0")	12.3 (13.6)
Case with 2 Stick Cylinders		5600 (18'4")	1300 (4'3")	1520 (5'0")	8.7 (9.6)
Case with Accessories		3900 (12'10")	2500 (8'2")	2550 (8'4")	3.2 (3.5)
Case with Accessories		5800 (19'0")	2500 (8'2")	2150 (7'1")	3.50 (3.9)

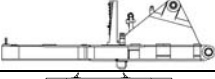
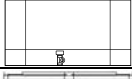
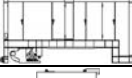
Component Dimensions and Weights

EXCAVATORS (BACKHOE)

PC8000-6

Unit name	Dimension	Length mm (ft.in.)	Width mm (ft.in.)	Height mm (ft.in.)	Weight ton (U.S. ton)
Left Crawler Side Frame without Tracks		10200 (33'6")	1600 (5'2")	2450 (8'0")	55 (60.6)
Right Crawler Side Frame without Tracks		10200 (33'0")	1600 (5'2")	2450 (8'0")	55 (60.6)
9 x 1 Chain with 10 Track Shoes 1500 mm (59")		5040 (16'6")	1500 (4'11")	400 (1'4")	91 (100.3)
1 Chain with 8-Track Shoes 1500 mm (59")		4070 (13'4")	1500 (4'11")	400 (1'4")	8.1 (8.9)
Carbody with Rotary Joint		5750 (18'10")	5060 (16'7")	2730 (8'11")	59 (65.0)
Superstructure Platform		11300 (37'1")	4750 (15'7")	4000 (13'1")	94 (103.6)
Counterweight		6800 (22'3")	1250 (4'1")	3850 (12'8")	52.3 (57.7)
Main Machinery House incl. 2 Diesel Engines		8000 (26'3")	5000 (16'5")	3900 (12'10")	62 (68.3)
Fuel Tank		3400 (11'1")	1800 (5'11")	3760 (12'4")	5.6 (6.2)
Hydraulic Tank		2710 (8'11")	1910 (6'3")	3730 (12'3")	7.2 (7.9)
Cab Base		2600 (8'6")	2000 (6'6")	3800 (12'5")	5.4 (6.0)
Boom 11.5 m (37'10")		12500 (41'0")	2800 (9'2")	5100 (16'9")	64.8 (71.4)
Arm 5.5 m (18'1")		7750 (25'5")	2950 (9'8")	3300 (10'9")	45.2 (49.8)
Backhoe Bucket 42 m ³ (54.9 cu.yd) SAE incl. Standard Wear Package WP 2		4500 (14'9")	4700 (15'5")	4500 (14'9")	48 (52.9)
Case with Oil Cooler		6500 (21'4")	2700 (8'10")	2500 (8'2")	11.5 (12.7)
Case with Slew Ring		4950 (16'3")	4910 (16'1")	1015 (3'4")	21 (23.1)
Case with Cab		4000 (13'1")	3030 (9'11")	3150 (10'4")	7 (7.7)
20' OT Container (belong to shipper) with Accessories					8.5 (9.4)
20' OT Container (belong to shipper) with Accessories					13.4 (14.8)
20' OT Container (belong to shipper) with Accessories					20.3 (22.4)
40' OT Container (belong to shipper) with Accessories					24.3 (26.8)

Applications of different shoes in accordance with soil characteristics and working conditions.

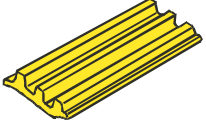
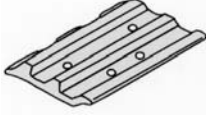
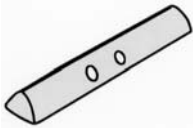
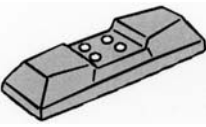
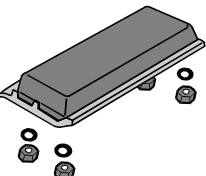
Type of shoe	Applicable soil and work	Advantages	Disadvantages	Remarks
<p>1 • Tripple grouser shoe</p>  <p>• Double grouser shoe</p> 	<p>Hard ground Suitable for both soft and hard ground</p>	<ul style="list-style-type: none"> • The three grousers have the same height, hence turning ability is good. • Good riding comfort is obtained as compared with a single grouser shoe. • Rotating resistance is low. • Because three beams are used, resistance to bending is high. 	<ul style="list-style-type: none"> • This shoe does not readily bite into the ground, so the traction force is low. 	
<p>2 Swamp shoe</p> 	<p>Swamp areas</p>	<ul style="list-style-type: none"> • Because the cross-section of this shoe is an arc, the ground contact area is large, and buoyancy is easily obtained. • This shoe is particularly suitable for use in swamp areas and areas with low ground pressure. The ground surface is not damaged when the machine travels over it, so it is suitable for soil compaction and leveling work. 	<ul style="list-style-type: none"> • Unsuitable for ground other than swampy ground. When used off swampy ground, it is liable to bend due to its low strength. 	
<p>3 • Road liner (rubber)</p>  <p>• Rubber pad</p> 	<p>Paved road Indoor work</p>	<ul style="list-style-type: none"> • The surface of the shoe in contact with the ground is made of rubber, so the machine can travel on paved roads without damaging the road surface. • Prevents noise when machine is traveling. 	<ul style="list-style-type: none"> • Use in the following places will shorten the cutting life of the rubber. <ol style="list-style-type: none"> (1) Rocky ground (2) Cold areas (below -25°C) (3) Hot areas (above 65°C) • Because there are no grouser, this shoe does not bite into the ground. 	

Model	Shoe type	Shoe width mm (in.)	Application**
PC60-8	Triple-grouser	450 (18")*	A
PC70-8	Triple-grouser	450 (18")*	A
PC71-7	Triple-grouser	450 (18")*	A
PC78US-8	Triple-grouser	450 (18")*	A
	Rubber pad	600 (24")	B
PC80MR-3	Triple-grouser	450 (18")*	A
		600 (24")	B
	Road liner	450 (18")	D
PC88MR-8	Triple-grouser	450 (18")*	A
		600 (24")	B
	Rubber pad	450 (18")	D
PC88MR-8*11	Triple-grouser	450 (18")*	A
		600 (24")	B
	Rubber pad	450 (18")	D
	Road liner	450 (18")	A
PC110-7	Triple-grouser	500 (20")*	A
		600 (24")	B
PC118MR-8	Triple-grouser	500 (20")*	A
	Road liner	500 (20")	D
PC130-8 PC130-8*7 PC130-8*8	Triple-grouser	500 (20")*	A
		600 (24")	B
		700 (28")	C
PC130-7*9	Triple-grouser	500 (20")*	A
PC130-7*5	Triple-grouser	500 (20")*	A
		600 (24")	B
		700 (28")	C
PC130F-7	Triple-grouser	900 (35.5")*	C
	Single-grouser	960 (39")	C
PC138US-8	Triple-grouser	500 (20")*	A
		600 (24")	B
	Road liner	700 (28")	C
PC138USLC-10*12	Triple-grouser	500 (20")*	A
		600 (24")	B
		700 (28")	C
	Road liner	500 (20")	D
PC160LC-8 PC160LC-8*7	Triple-grouser	500 (20")*	A
		600 (24")	B
		700 (28")	C
PC160LC-8*4	Triple-grouser	500 (20")*	A
		600 (24")	B
		700 (28")	C
		800 (31.5")	C
PC160LC-8*8	Triple-grouser	500 (20")	A
		600 (24")	B
		700 (28")*	C
PC190LC-8	Triple-grouser	600 (24")*	A
		700 (28")	B
		800 (31.5")	C
PC190NLC-8	Triple-grouser	500 (20")*	A
		600 (24")*	A
HB205-1	Triple-grouser	700 (28")	B
		800 (31.5")	C

* Standard shoe
 ** See classification of the application
 *** USA source
 *4 UK source
 *5 China source
 *6 Indonesia source
 *7 Thailand source
 *8 Brazil source
 *9 India source
 *10 Russia source
 *11 Italy source
 *12 for USA
 *13 for UK
 *14 for Russia

Model	Shoe type	Shoe width mm (in.)	Application**
HB215LC-1	Triple-grouser	600 (24")	A
		700 (28")*	B
		800 (31.5")	C
HB215LC-1*4	Triple-grouser	600 (24")*	A
PC200-8 PC200-8M0 PC200-8*5 PC200-8M0*7 PC200-8*10	Triple-grouser	500 (20")	A
		600 (24")*	A
		700 (28")	B
		800 (31.5")	C
PC200-8*6	Triple-grouser	800 (31.5")*	C
PC200-8*8	Triple-grouser	700 (28")*	B
		800 (31.5")	C
		500 (20")	A
PC200-7	Triple-grouser	600 (24")*	A
		700 (28")	B
		800 (31.5")	C
		600 (24")	A
PC200LC-8 PC200LC-8M0 PC200LC-8*5 PC200LC-8M0*7 PC200LC-8*10	Triple-grouser	700 (28")*	B
		800 (31.5")	C
		900 (35.5")	C
		700 (28")	B
PC200LC-8*8	Triple-grouser	800 (31.5")*	C
		600 (24")*	A
PC210-10*4	Triple-grouser	700 (28")	B
		800 (31.5")	C
		500 (20")	A
PC210-8*5	Triple-grouser	600 (24")*	A
		700 (28")	B
		800 (31.5")	C
		600 (24")*	A
PC210LC-8*9	Triple-grouser	600 (24")*	A
PC210LC-8***	Triple-grouser	700 (28")	B
		800 (31.5")*	C
		600 (24")*	A
PC210LC-10*4	Triple-grouser	700 (28")	B
		800 (31.5")	C
		900 (35.5")	C
		500 (20")*	A
PC210NLC-8	Triple-grouser	600 (24")	B
		700 (28")	C
		600 (24")*	A
PC210LC-8*5	Triple-grouser	700 (28")	B
		800 (31.5")	C
		600 (24")*	A
PC220-8 PC220-8M0 PC220-8*5 PC220-8*10 PC220-7	Triple-grouser	600 (24")*	A
		700 (28")	B
		800 (31.5")	C
		600 (24")	A
PC220LC-8 PC220LC-8M0 PC220LC-8*10 PC220LC-7	Triple-grouser	700 (28")*	B
		800 (31.5")	C
		600 (24")*	A
PC228US-8	Triple-grouser	700 (28")	B
		800 (31.5")	C
		600 (24")	A
PC228USLC-8	Triple-grouser	700 (28")*	B
		800 (31.5")	C
		600 (24")	A
PC228USLC-8*12	Triple-grouser	700 (28")	B
		800 (31.5")*	C
		600 (24")	D
		600 (24")*	A
PC228USLC-8*13	Triple-grouser	700 (28")	B
		800 (31.5")	C
		600 (24")	D
PC230NHD-8	Triple-grouser	550 (22")*	A
PC240LC-10***	Triple-grouser	700 (28")	B
		800 (31.5")*	C

Model	Shoe type	Shoe width mm (in.)	Application**
PC240LC-10*4	Triple-grouser	600 (24")	A
		700 (28")*	B
		800 (31.5")	C
		900 (35.5")	C
PC240NLC-10*4	Triple-grouser	600 (24")*	A
		700 (28")	B
		800 (31.5")	C
PC240LC-8*5	Triple-grouser	600 (24")*	A
		700 (28")	B
		800 (31.5")	C
		900 (35.5")	C
PC240LC-8*8	Triple-grouser	600 (24")*	A
		700 (28")	B
		800 (31.5")	C
PC270LC-8	Triple-grouser	600 (24")*	A
		700 (28")	B
		800 (31.5")	C
PC290LC-10***	Triple-grouser	700 (28")	B
		800 (31.5")*	C
		850 (33.5")	C
PC290LC-10*4	Triple-grouser	600 (24")	A
		700 (28")*	B
		800 (31.5")	C
		850 (33.5")	C
PC290NLC-10*4	Triple-grouser	600 (24")	A
		700 (28")*	B
		800 (31.5")	C
		850 (33.5")	C
PC300-8 PC300-8*7 PC300-8*7 (SE spec) PC300-8*10	Triple-grouser	600 (24")*	A
		700 (28")	B
		800 (31.5")	C
PC300-8*6 PC300-8*6 (SE spec)	Triple-grouser	600 (24")	A
		700 (28")	B
		800 (31.5")*	C
PC300-7	Triple-grouser	600 (24")*	A
		700 (28")	B
		800 (31.5")	C
PC300-7*5	Triple-grouser	600 (24")*	A
		700 (28")	B
PC300LC-8 PC300LC-8*10 PC300LC-8*7 PC300LC-8*7 (SE Spec)	Triple-grouser	600 (24")	A
		700 (28")*	B
		800 (31.5")	C
PC300LC-8*6 PC300LC-8*6 (SEspec)	Triple-grouser	600 (24")	A
		700 (28")	B
		800 (31.5")*	C
PC300LC-7*9	Triple-grouser	600 (24")*	A,B
		800 (31.5")	C
PC350LC-8*8	Triple-grouser	600 (24")*	A
		700 (28")	B
		800 (31.5")	C
PC360LC-10***	Triple-grouser	700 (28")*	B
		800 (31.5")	C
		850 (33.5")	C

Model	Shoe type	Shoe width mm (in.)	Application**	
PC360LC-10*4	Triple-grouser	600 (24")	A	
		700 (28")*	B	
		800 (31.5")	C	
		850 (33.5")	C	
PC360NLC-10*4	Triple-grouser	600 (24")*	A	
		700 (28")	B	
		800 (31.5")	C	
PC360-7*5	Triple-grouser	600 (24")*	A	
PC390LC-10***	Triple-grouser	700 (28")	B	
		800 (31.5")*	C	
		900 (35.5")	C	
PC400-8 PC400-8R PC400-8*5	Triple-grouser	600 (24")*	A	
		700 (28")	B	
		800 (31.5")	C	
PC400-8R*6 PC400-8R*6 (SE spec)	Triple-grouser	600 (24")*	A	
		700 (28")	B	
		800 (31.5")	C	
PC400-7 PC400-7*10	Triple-grouser	600 (24")*	A	
		700 (28")	B	
		800 (31.5")	C	
PC400LC-8 PC400LC-8R	Triple-grouser	600 (24")	A	
		700 (28")*	B	
		800 (31.5")	C	
PC400LC-7 PC400LC-7*10	Triple-grouser	600 (24")*	A	
		700 (28")	B	
		800 (31.5")	C	
PC400LC-8R*6 PC400LC-8R*6 (SE spec)	Triple-grouser	600 (24")*	A	
		700 (28")	B	
		800 (31.5")*	C	
PC450-8 PC450-8R PC450-7	Triple-grouser	600 (24")*	A	
		700 (28")	B	
PC450-8*5	Triple-grouser	600 (24")*	A	
PC450LC-8 PC450LC-8R	Triple-grouser	600 (24")*	A	
		700 (28")	B	
PC490LC-10***	Triple-grouser	700 (28")	B	
		800 (31.5")*	C	
		900 (35.5")	C	
PC490-10*4	Triple-grouser	600 (24")*	A	
		700 (28")	B	
		800 (31.5")	C	
PC490-10*4	Double-grouser	600 (24")	A	
	Triple-grouser	600 (24")	A	
700 (28")*		B		
800 (31.5")		C		
900 (35.5")		C		
PC490LC-10*4	Triple-grouser	600 (24")	A	
		700 (28")*	B	
PC490LC-10*4	Double-grouser	600 (24")	A	
		700 (28")*	B	
PC550LC-8	Triple-grouser	600 (24")*	A	
		750 (29.5")	B	
		600 (24")*	A	
PC600-8E0 PC600-8R1 PC600-8*4 PC600-7*14	Triple-grouser	750 (29.5")	B	
		Triple-grouser	600 (24")*	A
			750 (29.5")	B
PC600LC-8E0 PC600LC-8R1 PC600LC-8*4 PC600LC-7*14 PC600LC-7*10	Triple-grouser		600 (24")*	A
		750 (29.5")	B	
		900 (35.5")	C	
PC650LC-8*12	Double-grouser	750 (29.5")*	A,B	
		900 (35.5")	C	
PC650LC-8R*5	Double-grouser	600 (24")*	A,B	
PC700LC-8E0 PC700LC-8R PC700LC-8E0*5	Double-grouser	610 (24")*	A	
		710 (28")	B	

* Standard shoe
 ** See classification of the application
 *** USA source
 *4 UK source
 *5 China source
 *6 Indonesia source
 *7 Thailand source
 *8 Brazil source
 *9 India source
 *10 Russia source
 *11 Italy source
 *12 for USA
 *13 for UK
 *14 for Russia

Model	Shoe type	Shoe width mm (in.)	Application**
PC700LC-8E0*4	Double-grouser	610 (24")*	A
		710 (28")	A
		810 (32")	B
		910 (36")	C
PC800-8E0 (SE spec) PC800-8R1 (SE spec) PC750-7*14 (SE spec)	Double-grouser	610 (24")*	A
		710 (28")	A
		810 (32")	B
		910 (36")	B
		1010 (40")	C
PC800-8E0*4	Double-grouser	610 (24")*	A
		710 (28")	A
		810 (32")	B
		910 (36")	B
PC800LC-8E0 (SE spec) PC800LC-8R1 (SE spec) PC800LC-8E0***	Double-grouser	810 (32")*	A,B
		1010 (40")	C
PC800LC-8E0*4	Double-grouser	710 (28")*	A
		810 (32")	B
		910 (36")	B
		1010 (40")	C
		1110 (44")	C
PC850-8E0 (SE spec) PC850-8R1 (SE spec) PC800-7*14 (SE spec)	Double-grouser	610 (24")*	A
		710 (28")	A
PC1250-8 PC1250-8R PC1250-7	Double-grouser	700 (28")*	A
		1000 (39.4")	B
PC1250-8 PC1250-8R PC1250-7 (SP spec)	Double-grouser	700 (28")*	A,B
PC1250-8R*6	Double-grouser	700 (28")*	A
PC1250LC-8	Double-grouser	1000 (39.4")*	B
		1200 (47.2")	B
PC2000-8	Double-grouser	810 (32")*	A
		1010 (40")	B
PC3000-6	Double-grouser	800 (31.4")*	A
		1000 (39.3")	B
		1200 (47.2")	B
PC4000-6	Double-grouser	1200 (47.2")*	A
		1500 (59")	B
PC5500-6	Double-grouser	1350 (53")*	A
		1800 (71")	B
PC8000-6	Double-grouser	1500 (59")*	A
		1900 (75")	B

* Standard shoe

** See classification of the application

*** USA source

*4 UK source

*5 China source

*6 Indonesia source

*7 Thailand source

*8 Brazil source

*9 India source

*10 Russia source

*11 Italy source

*12 for USA

*13 for UK

*14 for Russia

Classification of the applications:

Classification	Applicable terrain	Limitations
A	Rocky terrain, river banks, & general terrain	1. Use low gear for traveling over harsh terrain with various obstacles such as rolling stones and fallen trees.
B	General or soft terrain	1. Not applicable for traveling over harsh terrain with rolling stones and fallen trees. 2. Travel in high gear only on flat ground ; use half speed in low gear for going over the obstacles, if they are unavoidable.
C	Extremely soft terrain (swamps)	1. Applicable only when "A" & "B" sink. 2. Not applicable for traveling over harsh terrain with rolling stones and fallen trees. 3. Travel in high gear only on flat terrain ; use half speed in low gear for going over the obstacles if they are unavoidable.
D	Paved road	1. Rubber pad shoes must be used mainly in machine operation on paved road surfaces. If used on unpaved surfaces, shoe durability will be badly deteriorated due to rubber cracks, cutouts etc. The following operations must be avoided. (a) Work on broken concrete, gravel, etc. (b) Work on sharp projections like reinforcing iron rods, glass, etc. (c) Riding on concrete road shoulder, operation on bedrock and in rivers with abundance of stones, pebbles, etc. 2. In operation on roads covered with water, ice, snow, gravel etc. be careful to avoid the shoes slipping, especially in carrying or unloading operation of a machine on or from a truck. 3. In operation at high temperature (65°C or higher) or at low temp. (-25°C or lower), the rubber will be liable to damage because of the changes in the physical properties.

NOTE: Select the narrowest possible shoes, depending on the flotation and ground pressure of the machines. If the shoe is too wide, the load on the track shoe increases and results in bends in the shoes, cracks in the links, breakage and slipping out of the pins and loosening of the bolts.

Definition: Ground pressure = machine operating weight / total ground contact area
where ; total ground contact area = (L + 0.35H) × shoe width × 2

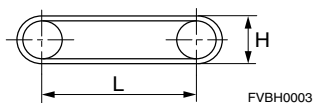

H = Track height
L = Distance between centers of sprocket and front idler

	Shoe type	Shoe width mm (in)	Ground contact area cm ² (sq.in)	Ground pressure kg/cm ² (PSI)	Change in operating weight kg (lb)	Boom Arm Bucket
PC18MR-3	Double-grouser	230 (9")	6080 (942)	0.30 (4.27)	+60 (132)	:1.76 m (5'9")
	Rubber	230 (9")*	6080 (942)	0.29 (4.12)	±0	:0.965 m (3'2") :0.044 m ³ (0.058 cu.yd)
PC20MR-3	Double-grouser	250 (10")	7980 (1225)	0.28 (4.6)	+104 (229)	:1.81 m (5'11")
	Rubber	250 (10")*	7980 (1225)	0.27(3.84)	±0	:0.97 m (3'2")
	Rubber pad	250 (10")	7980 (1225)			:0.066 m ³ (0.86 cu.yd)
PC27MR-3	Double-grouser	300 (12")	9550 (1480)	0.31 (4.6)	+86 (190)	:2.18 m (7'2")
	Rubber	300 (12")*	9550 (1480)	0.30 (4.6)	±0	:1.11 m (3'2")
	Rubber pad	300 (12")	9550 (1480)	0.32 (4.6)	+143 (315)	:0.08 m ³ (0.10 cu.yd)
	Road liner	300 (12")	9550 (1480)		+130 (287)	
PC30MR-3	Double-grouser	300 (12")	10530 (1632)	0.31 (4.41)	+118 (260)	:2.285 m (7'6")
	Rubber	300 (12")*	10530 (1632)	0.30 (4.27)	±0	:1.24 m (4'1")
	Road liner	300 (12")	10530 (1632)	0.31 (4.41)	+170 (375)	:0.09 m ³ (0.12 cu.yd)
	Rubber pad	300 (12")	10530 (1632)	0.31 (4.41)	+162 (357)	
PC35MR-3	Double-grouser	300 (12")	10530 (1632)	0.35 (5.0)	+88 (194)	:2.54 m (8'5")
	Rubber	300 (12")*	10530 (1632)	0.34 (4.83)	±0	:1.37 m (4'5")
	Rubber pad	300 (12")	10530 (1632)	0.36 (5.12)	+170 (375)	:0.11 m ³ (0.14 cu.yd)
	Road liner	300 (12")	10530 (1632)	0.35 (5.0)	+162 (357)	
PC45MR-3	Triple-grouser	400 (16")	17540 (2719)	0.28 (4.0)	+70 (154)	:2.74 m (9'0")
	Rubber	400 (16")*	17540 (2719)	0.27 (3.8)	±0	:1.44 m (4'9")
	Rubber pad	400 (16")	17540 (2719)	0.29 (4.1)	+250 (551)	:0.14 m ³ (0.18 cu.yd)
	Road liner	400 (16")	17540 (2719)	0.28 (4.0)	+90 (198)	
PC55MR-3	Triple-grouser	400 (16")	17540 (2719)	0.29 (4.1)	+70 (154)	:2.9 m (9'6")
	Rubber	400 (16")*	17540 (2719)	0.29 (4.1)	±0	:1.64 m (5'5")
	Rubber pad	400 (16")	17540 (2719)	0.30 (4.3)	+250 (551)	:0.16 m ³ (0.21 cu.yd)
	Road liner	400 (16")	17540 (2719)	0.29 (4.1)	+90 (198)	
PC60-8	Triple-grouser	450 (18")*	21070 (3266)	0.29 (4.12)	±0	:3.65 m (12'0") :1.55 m (5'1") :0.25m ³ (0.33 cu.yd)
PC70-8 PC70-8*4	Triple-grouser	450 (18")*	21070 (3266)	0.31 (4.41)	±0	:3.71 m (12'2") :1.65 m (5'5") :0.30m ³ (0.39 cu.yd)
PC71-7	Triple-grouser	450 (18")*	21070 (3266)	0.34 (4.83)	±0	:3.71 m (12'2") :1.65 m (5'5") :0.30m ³ (0.39 cu.yd)
PC78US-8	Triple-grouser	450 (18")*	22200 (3441)	0.32 (4.55)	±0	:3.71 m (12'2")
	Rubber pad	600 (24")	29600 (4588)	0.24 (3.41)	+170 (375)	:1.65 m (5'5")
PC80MR-3	Triple-grouser	450 (18")*	22200 (3441)	0.32 (4.55)	+80 (176)	:0.28 m ³ (0.37 cu.yd)
		600 (24")	29600 (4586)	0.26 (3.70)	+170 (375)	:1.65 m (5'5")
	Rubber	450 (24")	22200 (3441)	0.35 (4.98)	+80 (176)	:0.2 m ³ (0.26 cu.yd)
PC88MR-8 PC88MR-8*9	Triple-grouser	450 (18")*	22200 (3441)	0.37 (5.26)	±0	:3.4 m (11'2")
		600 (24")	30460 (4721)	0.28 (3.98)	+170 (375)	:1.65 m (5'5")
	Rubber	450 (18")	22200 (3441)	0.37 (5.26)	-66 (146)	:0.28 m ³ (0.37 cu.yd)
	Road liner	450 (18")	22200 (3441)	0.38 (5.40)	+150 (330)	
PC110-7	Triple-grouser	500 (20")*	28770 (4459)	0.37 (5.26)	±0	:4.26 m (14'0")
		600 (24")	34520 (5351)	0.33 (4.69)	+280 (617)	:2.26 m (7'5")
	Swamp	700 (28")	40280 (6243)			:0.48 m ³ (0.63 cu.yd)

- * Standard shoe
- ** USA source
- *** UK source
- *4 China source
- *5 India source
- *6 Thailand source
- *7 Indonesia source
- *8 Brazil source
- *9 Italy source
- *10 for USA
- *11 for UK
- *12 for Russia

NOTE: The shoe for the long-track excavator (L and LC), wide shoe (excluding the narrowest shoe for a model) and swamp shoe are provided with low ground pressure. These shoes should be used on soft and swampy terrain where the standard excavator with standard shoe is not usable due to sinkage of the tracks. If such shoes are used in swampy fields with stones, stumps and roots, bending of the shoe plates, cracks in the links, breakage of pins, loosening of shoe bolts and other damage may result. Therefore, the job site must be studied carefully, to provide the customer with correct instructions and advice.

Ground Pressure

EXCAVATORS (BACKHOE)

	Shoe type	Shoe width mm (in)	Ground contact area cm ² (sq.in)	Ground pressure kg/cm ² (PSI)	Change in operating weight kg (lb)	Boom Arm Bucket
PC118MR-8	Triple-grouser	500 (20")		0.43 (6.11)	±0	:3.5 m (11'5")
	Road liner	500 (20")			+120 (265)	:2.0 m (6'7") :0.38 m ³ (0.5 cu.yd)
PC130-8 PC130-8*6	Triple-grouser	500 (20")*	31285 (4849)	0.39 (5.55)	±0	:4.6 m (15'1")
		600 (24")	37540 (5819)	0.33 (4.69)	+180 (397)	:2.5 m (8'2")
		700 (28")	43800 (6789)	0.29 (4.12)	+360 (794)	:0.5 m ³ (0.65 cu.yd)
PC130-8*8	Triple-grouser	500 (20")*	31285 (4849)	0.41 (5.83)	±0	:4.6 m (15'1")
		600 (24")	37540 (5819)	0.35 (4.98)	+180 (397)	:2.5 m (8'2")
		700 (28")	43800 (6789)	0.30 (4.27)	+360 (794)	:0.6 m ³ (0.78 cu.yd)
PC130-7*5	Triple-grouser	500 (20")*	31285 (4849)	0.39 (5.55)	±0	:4.6 m (15'1")
						:2.1 m (6'11") :0.64 m ³ (0.83 cu.yd)
PC130F-7	Triple-grouser	900 (35.4")*	56310 (8728)	0.26 (3.70)	±0	:4.26 m (14'0")
	Single-grouser	960 (37.8")	60070 (9311)	0.25 (3.56)	+335 (739)	:2.36 m (7'9") :0.50 m ³ (0.65 cu.yd)
PC138US-8	Triple-grouser	500 (20")*	31600 (4898)	0.43 (6.11)	±0	:4.6 m (15'1")
		600 (24")	37920 (5878)	0.36 (5.12)	+190 (419)	:2.5 m (8'2")
		700 (28")	44240 (6857)	0.31 (4.41)	+370 (408)	:0.50 m ³ (0.65 cu.yd)
PC138USLC-10*10	Triple-grouser	500 (20")*	31600 (4898)	0.43 (6.11)	±0	:4.6 m (15'1")
		600 (24")	37920 (5878)	0.36 (5.12)	+180 (397)	:2.5 m (8'2")
		700 (28")	44240 (6857)	0.31 (4.41)	+380 (838)	:0.50 m ³ (0.65 cu.yd)
PC160LC-8	Triple-grouser	500 (20")*	34750 (5386)	0.49 (6.97)	±0	:5.15 m (16'11")
		600 (24")	41700 (6464)	0.41 (5.83)	+220 (485)	:2.61 m (8'7")
		700 (28")	48650 (7541)	0.36 (5.12)	+440 (970)	:0.65 m ³ (0.85 cu.yd)
PC160LC-8***	Triple-grouser	500 (20")*	34750 (5386)	0.51 (7.25)	±0	:5.15 m (16'11")
		600 (24")	41700 (6464)	0.43 (6.11)	+220 (485)	:2.6 m (8'6")
		700 (28")	48650 (7541)	0.37 (5.26)	+440 (970)	:0.66 m ³ (0.86 cu.yd)
		800 (31.5")	55600 (8618)	0.33 (4.69)	+660 (1455)	
PC160LC-8*6	Triple-grouser	500 (20")*	34750 (5386)	0.49 (6.97)	±0	:5.15 m (16'11")
		600 (24")	41700 (6464)	0.41 (5.83)	+220 (485)	:2.6 m (8'6")
		700 (28")	48650 (7541)	0.36 (5.12)	+440 (970)	:0.74 m ³ (0.97 cu.yd)
PC160LC-8*8	Triple-grouser	500 (20")*	34750 (5386)	0.48 (6.83)	±0	:5.15 m (16'11")
		600 (24")	41700 (6464)	0.41 (5.83)	+220 (485)	:2.25 m (7'5")
		700 (28")	48650 (7541)	0.36 (5.12)	+440 (970)	:0.80 m ³ (1.05 cu.yd)
PC160LC-7*4	Triple-grouser	500 (20")*	34750 (5386)	0.47 (6.68)	±0	:5.15 m (16'11")
		600 (24")	41700 (6464)	0.40 (5.69)	+220 (485)	:2.61 m (8'7")
		700 (28")	48650 (7541)	0.35 (4.98)	+440 (970)	:0.65 m ³ (0.85 cu.yd)
PC190LC-8	Triple-grouser	600 (24")	43170 (6691)	0.44 (6.23)	±0	:5.15 m (16'11")
		700 (28")	50365 (7807)	0.38 (5.40)	+220 (485)	:2.6 m (8'6")
		800 (31.5")	57560 (8922)	0.34 (4.83)	+440 (970)	:0.66 m ³ (0.86 cu.yd)
PC190NLC-8	Triple-grouser	500 (20")*	35975 (5576)	0.52 (7.39)	±0	:5.15 m (16'11")
						:2.6 m (8'6") :0.66 m ³ (0.86 cu.yd)
HB205-1	Triple-grouser	600 (24")	42790 (6632)	0.47 (6.68)	±0	:5.7 m (18'8")
		700 (28")	49920 (7738)	0.41 (5.83)	+380 (840)	:2.925 m (9'7")
		800 (31.5")	57050 (8843)	0.37 (5.26)	+630 (1390)	:0.80 m ³ (1.05 cu.yd)
HB215LC-1	Triple-grouser	600 (24")	47350 (7339)	0.45 (6.40)	±0	:5.7 m (18'8")
		700 (28")	55240 (8562)	0.39 (5.55)	+380 (840)	:2.925 m (9'7")
		800 (31.5")	63130 (9785)	0.35 (4.98)	+630 (1390)	:0.80 m ³ (1.05 cu.yd)
HB215LC-1***	Triple-grouser	600 (24")	47350 (7339)	0.47 (6.68)	±0	:5.7 m (18'8")
						:2.925 m (9'7") :0.80 m ³ (1.05 cu.yd)
PC200-8 PC200-8*11 PC200-7	Triple-grouser	500 (20")	35660 (5527)	0.54 (7.68)	-100 (220)	:5.7 m (18'8")
		600 (24")*	42790 (6632)	0.46 (6.54)	±0	:2.925 m (9'7")
		700 (28")	49920 (7738)	0.40 (5.69)	+250 (551)	:0.80 m ³ (1.05 cu.yd)
		800 (31.5")	57050 (8843)	0.35 (4.98)	+510 (1124)	

* Standard shoe *4 China source *8 Brazil source *12 for Russia
** USA source *5 India source *9 Italy source
*** UK source *6 Thailand source *10 for USA
 *7 Indonesia source *11 for UK

NOTE: The shoe for the long-track excavator (L and LC), wide shoe (excluding the narrowest shoe for a model) and swamp shoe are provided with low ground pressure. These shoes should be used on soft and swampy terrain where the standard excavator with standard shoe is not usable due to sinkage of the tracks. If such shoes are used in swampy fields with stones, stumps and roots, bending of the shoe plates, cracks in the links, breakage of pins, loosening of shoe bolts and other damage may result. Therefore, the job site must be studied carefully, to provide the customer with correct instructions and advice.

	Shoe type	Shoe width mm (in)	Ground contact area cm ² (sq.in)	Ground pressure kg/cm ² (PSI)	Change in operating weight kg (lb)	Boom Arm Bucket
PC200-8M0 PC200-8M0*6	Triple-grouser	500 (20")	35660 (5527)	0.55 (7.82)	-100 (220)	:5.7 m (18'8")
		600 (24")*	42790 (6632)	0.47 (6.68)	±0	:2.925 m (9'7")
		700 (28")	49920 (7738)	0.41 (5.83)	+250 (551)	:0.80 m ³ (1.05 cu.yd)
		800 (31.5")	57050 (8843)	0.37 (5.26)	+510 (1124)	
PC200-8*7	Triple-grouser	800 (31.5")	57050 (8843)	0.35 (4.98)	±0	:5.7 m (18'8")
						:2.925 m (9'7")
						:0.80 m ³ (1.05 cu.yd)
PC200-8*4	Triple-grouser	600 (24")*	42790 (6632)	0.46 (6.54)	±0	:5.7 m (18'8")
		800 (31.5")	57050 (8843)	0.36 (5.12)	+630 (1390)	:2.925 m (7'11")
						:0.80 m ³ (1.05 cu.yd)
PC200-8*8	Triple-grouser	700 (28")*	49920 (7738)	0.42 (5.97)	±0	:5.7 m (18'8")
		800 (31.5")	57050 (8843)	0.37 (5.26)	+250 (550)	:2.41 m (9'7")
						:1.20 m ³ (1.57 cu.yd)
PC200LC-8 PC200LC-8*11	Triple-grouser	600 (24")	47350 (7339)	0.44 (6.26)	-270 (595)	:5.7 m (18'8")
		700 (28")*	55240 (8562)	0.38 (5.40)	±0	:2.925 m (9'7")
		800 (31.5")	63130 (9785)	0.34 (4.83)	+280 (617)	:0.80 m ³ (1.05 cu.yd)
		900 (35.4")	71020 (11008)	0.30 (4.27)	+560 (1235)	
PC200LC-8M0 PC200LC-8M0*6	Triple-grouser	600 (24")	47350 (7339)	0.45 (6.40)	-270 (595)	:5.7 m (18'8")
		700 (28")*	55240 (8562)	0.39 (5.55)	±0	:2.925 m (9'7")
		800 (31.5")	63130 (9785)	0.35 (4.98)	+280 (617)	:0.80 m ³ (1.05 cu.yd)
		900 (35.4")	71020 (11008)	0.30 (4.27)	+560 (1235)	
PC200LC-8*4	Triple-grouser	600 (24")*	47350 (7339)	0.45 (6.40)	±0	:5.7 m (18'8")
		800 (31.5")	63130 (9785)	0.35 (4.98)	+690 (1521)	:2.925 m (9'7")
						:0.80 m ³ (1.05 cu.yd)
PC200LC-8*8	Triple-grouser	700 (28")*	55240 (8562)	0.41 (5.83)	±0	:5.2 m (17'1")
		800 (31.5")	63130 (9785)	0.36 (5.12)	+280 (617)	:2.41 m (7'11")
						:1.50 m ³ (1.96 cu.yd)
PC210-10***	Triple-grouser	600 (24")*	42790 (6632)	0.51 (7.25)	±0	:5.7 m (18'8")
		700 (28")	49920 (7738)	0.44 (6.26)	+250 (550)	:2.9 m (9'7")
		800 (31.5")	57050 (8843)	0.39 (5.55)	+540 (1190)	:0.80 m ³ (1.05 cu.yd)
PC210-8*4	Triple-grouser	600 (24")*	42790 (6632)	0.46 (6.54)	±0	:5.7 m (18'8")
		800 (31.5")	57050 (8843)	0.36 (5.12)	+700 (1545)	:2.925 m (9'7")
						:0.90 m ³ (1.18 cu.yd)
PC210LC-10**	Triple-grouser	700 (28")*	55240 (8562)	0.42 (5.976.11)	±0	:5.7 m (18'8")
		800 (31.5")	63130 (9785)	0.37 (5.26)	+280 (615)	:2.925 m (9'7")
						:1.02 m ³ (1.34 cu.yd)
PC210LC-10***	Triple-grouser	600 (24")*	47350 (7339)	0.48 (6.83)	±0	:5.7 m (18'8")
		700 (28")	55240 (8562)	0.41 (5.83)	+270 (595)	:2.9 m (9'7")
		800 (31.5")	63130 (9785)	0.37 (5.26)	+590 (1300)	:0.80 m ³ (1.05 cu.yd)
		900 (35.4")	71020 (11008)	0.33 (4.69)	+860 (1895)	
PC210NLC-8	Triple-grouser	500 (20")*	39490 (6121)	0.55 (7.82)	±0	:5.7 m (18'8")
		600 (24")	47390 (7345)	0.47 (6.68)	+360 (794)	:2.93 m (9'7")
		700 (28")	55290 (8570)	0.40 (5.69)	+630 (1389)	:0.84 m ³ (1.1 cu.yd)
PC210LC-8*4	Triple-grouser	600 (24")*	47350 (7339)	0.45 (6.40)	±0	:5.7 m (18'8")
		800 (31.5")	63130 (9785)	0.35 (4.98)	+690 (1521)	:2.925 m (9'7")
						:0.90 m ³ (1.18 cu.yd)
PC210LC-8*5	Triple-grouser	500 (20")	39460 (6116)	0.54 (7.68)	-270 (595)	:5.7 m (18'8")
		600 (24")*	47350 (7339)	0.48 (6.83)	±0	:2.4 m (7'10")
						:1.05 m ³ (1.37 cu.yd)
PC220-8 PC220-8*11 PC220-7	Triple-grouser	600 (24")*	44710 (6930)	0.51 (7.25)	±0	:5.85 m (19'2")
		700 (28")	52160 (8085)	0.45 (6.40)	+260 (573)	:3.045 m (10'0")
		800 (31.5")	59610 (8821)	0.39 (5.55)	+520 (1146)	:1.0 m ³ (1.31 cu.yd)

* Standard shoe
** USA source
*** UK source

*4 China source
*5 India source
*6 Thailand source
*7 Indonesia source

*8 Brazil source
*9 Italy source
*10 for USA
*11 for UK

*12 for Russia

NOTE: The shoe for the long-track excavator (L and LC), wide shoe (excluding the narrowest shoe for a model) and swamp shoe are provided with low ground pressure. These shoes should be used on soft and swampy terrain where the standard excavator with standard shoe is not usable due to sinkage of the tracks. If such shoes are used in swampy fields with stones, stumps and roots, bending of the shoe plates, cracks in the links, breakage of pins, loosening of shoe bolts and other damage may result. Therefore, the job site must be studied carefully, to provide the customer with correct instructions and advice.

	Shoe type	Shoe width mm (in)	Ground contact area cm ² (sq.in)	Ground pressure kg/cm ² (PSI)	Change in operating weight kg (lb)	Boom Arm Bucket
PC220-8M0	Triple-grouser	600 (24")*	44710 (6930)	0.51 (7.25)	±0	:5.85 m (19'2")
		700 (28")	52160 (8085)	0.45 (6.40)	+200 (440)	:3.05 m (10'0")
		800 (31.5")	59610 (8821)	0.40 (5.69)	+500 (1100)	:1.0 m ³ (1.31 cu.yd)
PC220-8*4	Triple-grouser	600 (24")*	44710 (6930)	0.52 (7.39)	±0	:5.85 m (19'2")
		800 (31.5")	59610 (5240)	0.40 (5.69)	+500 (1102)	:3.045 m (9'7")
						:1.0 m ³ (1.31 cu.yd)
PC220LC-8 PC220LC-8**11 PC220LC-7	Triple-grouser	600 (24")	49330 (7646)	0.49 (7.00)	-280 (617)	:5.85 m (19'2")
		700 (28")*	57550 (8920)	0.42 (5.97)	±0	:3.045 m (10'0")
		800 (31.5")	65770 (10194)	0.37 (5.26)	+280 (617)	:1.0 m ³ (1.31 cu.yd)
PC220LC-8M0	Triple-grouser	600 (24")	49330 (7646)	0.49 (6.97)	-300 (660)	:5.85 m (19'2")
		700 (28")*	57550 (8920)	0.43 (6.11)	±0	:3.05 m (10'0")
		800 (31.5")	65770 (10194)	0.38 (5.40)	+300 (660)	:1.0 m ³ (1.31 cu.yd)
PC228US-8	Triple-grouser	600 (24")*	42310 (6558)	0.51 (7.25)	±0	:5.7 m (18'8")
		700 (28")	49360 (7651)	0.45 (6.40)	+380 (840)	:2.9 m (9'7")
		800 (31.5")	56410 (8744)	0.40 (5.69)	+630 (1390)	:0.80 m ³ (1.05 cu.yd)
PC228USLC-8	Triple-grouser	600 (24")	47520 (7366)	0.48 (6.83)	-270 (595)	:5.7 m (18'8")
		700 (28")*	55440 (8593)	0.42 (5.97)	±0	:2.9 m (9'7")
		800 (31.5")	63360 (9821)	0.37 (5.26)	+280 (615)	:0.80 m ³ (1.05 cu.yd)
PC228USLC-8*10	Triple-grouser	600 (24")	47520 (7366)	0.51 (7.25)	-545 (1200)	:5.7 m (18'8")
		700 (28")	55440 (8593)	0.44 (6.26)	-280 (615)	:2.9 m (9'7")
		800 (31.5")*	63360 (9821)	0.39 (5.55)	±0	:0.80 m ³ (1.05 cu.yd)
PC228USLC-8*11	Triple-grouser	600 (24")*	47520 (7366)	0.48 (6.83)	±0	:5.7 m (18'8")
		700 (28")	55440 (8593)	0.41 (5.83)	+270 (595)	:2.9 m (9'7")
		800 (31.5")	63360 (9821)	0.37 (5.26)	+550 (1215)	:0.80 m ³ (1.05 cu.yd)
PC230NHD-8	Triple-grouser	550 (22")*	40984 (6353)	0.56 (7.96)	±0	:5.7 m (18'8")
						:2.9 m (9'6")
						:0.94 m ³ (1.23 cu.yd)
PC240LC-10**	Triple-grouser	700 (28")	57550 (8920)	0.43 (6.11)	-290 (640)	:5.85 m (19'2")
		800 (31.5")*	65770 (10194)	0.38 (5.40)	±0	:3.05 m (10'0")
						:1.2 m ³ (1.57 cu.yd)
PC240LC-10***	Triple-grouser	600 (24")	49330 (7646)	0.51 (7.25)	-300 (660)	:5.85 m (19'2")
		700 (28")*	57550 (8920)	0.44 (6.26)	±0	:3.0 m (9'10")
		800 (31.5")	65770 (10194)	0.39 (5.55)	+300 (660)	:1.0 m ³ (1.31 cu.yd)
		900 (35.4")	73990 (11468)	0.35 (4.98)	+600 (1325)	
PC240NLC-10***	Triple-grouser	600 (24")*	47050 (7293)	0.52 (7.39)	±0	:5.85 m (19'2")
		700 (28")	54890 (8508)	0.45 (6.40)	+300 (660)	:3.0 m (9'10")
		800 (31.5")	62730 (9723)	0.40 (5.69)	+600 (1325)	:1.73 m ³ (2.26 cu.yd)
PC240LC-8*4	Triple-grouser	600 (24")*	49330 (7646)	0.51 (7.25)	-300 (661)	:5.85 m (19'2")
		700 (28")	57550 (8920)	0.44 (6.26)	±0	:3.0 m (9'10")
		800 (31.5")	65770 (10194)	0.39 (5.55)	+300 (661)	:1.41 m ³ (1.84 cu.yd)
		900 (35.5")	73990 (11468)	0.35 (5.00)	+600 (1323)	
PC240LC-8*8	Triple-grouser	600 (24")*	49330 (7646)	0.50 (7.25)	±0	:5.85 m (19'2")
		700 (28")	57550 (8920)	0.44 (6.26)	+280 (615)	:2.5 m (8'2")
		800 (31.5")	65770 (10194)	0.39 (5.55)	+550 (1215)	:1.0 m ³ (1.31 cu.yd)
PC270-8	Triple-grouser	600 (24")*	48280 (7483)	0.56 (7.96)	±0	:5.85 m (19'2")
		700 (28")	56330 (8731)	0.49 (6.97)	+110 (243)	:3.05 m (10'0")
		800 (31.5")	64370 (9977)	0.43 (6.11)	+460 (1010)	:1.26 m ³ (1.65 cu.yd)
PC270-7*4	Triple-grouser	600 (24")*	48280 (7483)	0.56 (7.96)	±0	:5.85 m (19'2")
		700 (28")	56330 (8731)	0.49 (6.97)	+110 (243)	:3.05 m (10'0")
		800 (31.5")	64370 (9977)	0.43 (6.11)	+460 (1010)	:1.3 m ³ (1.70 cu.yd)
PC270LC-8	Triple-grouser	600 (24")	52450 (8130)	0.53 (7.54)	-600 (1323)	:5.85 m (19'2")
		700 (28")*	61190 (9484)	0.47 (6.68)	±0	:3.05 m (10'0")
		800 (31.5")	69930 (10839)	0.41 (5.83)	+380 (838)	:1.26 m ³ (1.65 cu.yd)

* Standard shoe *4 China source *8 Brazil source *12 for Russia
 ** USA source *5 India source *9 Italy source
 *** UK source *6 Thailand source *10 for USA
 *7 Indonesia source *11 for UK

NOTE: The shoe for the long-track excavator (L and LC), wide shoe (excluding the narrowest shoe for a model) and swamp shoe are provided with low ground pressure. These shoes should be used on soft and swampy terrain where the standard excavator with standard shoe is not usable due to sinkage of the tracks. If such shoes are used in swampy fields with stones, stumps and roots, bending of the shoe plates, cracks in the links, breakage of pins, loosening of shoe bolts and other damage may result. Therefore, the job site must be studied carefully, to provide the customer with correct instructions and advice.

	Shoe type	Shoe width mm (in)	Ground contact area cm ² (sq.in)	Ground pressure kg/cm ² (PSI)	Change in operating weight kg (lb)	Boom Arm Bucket
PC290LC-10**	Triple-grouser	700 (28")	61190 (9484)	0.50 (7.11)	-380 (838)	:6.15 m (20'2")
		800 (31.5")*	69930 (10839)	0.44 (6.26)	±0	:3.2 m (10'6")
		850 (33.5")	74300 (11517)	0.42 (5.97)	+191 (420)	:1.41 m ³ (1.85 cu.yd)
PC290LC-10***	Triple-grouser	600 (24")	52450 (8230)	0.57 (8.11)	-400 (880)	:6.15 m (20'2")
		700 (28")*	61190 (9484)	0.50 (7.11)	±0	:3.2 m (10'6")
		800 (31.5")	69930 (10839)	0.44 (6.40)	+400 (880)	:1.2 m ³ (1.57 cu.yd)
		850 (33.5")	74300 (11517)	0.42 (5.97)	+600 (1323)	
PC290NLC-10***	Triple-grouser	600 (24")*	52450 (8230)	0.57 (8.11)	±0	:6.15 m (20'2")
		700 (28")	61190 (9484)	0.50 (7.11)	+400 (880)	:3.2 m (10'6")
		800 (31.5")	69930 (10839)	0.44 (6.40)	+800 (1763)	:1.2 m ³ (1.57 cu.yd)
		850 (33.5")	74300 (11517)	0.42 (5.97)	+1000 (2205)	
PC300-8 PC300-8 ¹¹	Triple-grouser	600 (24")*	48280 (7483)	0.64 (9.10)	±0	:6.47 m (21'3")
		700 (28")	56330 (8731)	0.56 (7.96)	+560 (1234)	:3.185 m (10'5")
		800 (31.5")	64370 (9977)	0.49 (6.97)	+910 (2006)	:1.4 m ³ (1.83 cu.yd)
PC300-8 ⁶	Triple-grouser	600 (24")*	48280 (7483)	0.64 (9.12)	±0	:6.47 m (21'3")
		700 (28")	56330 (8731)	0.56 (7.96)	+360 (794)	:3.185 m (10'5")
		800 (31.5")	64370 (9977)	0.49 (6.97)	+710 (1565)	:1.4 m ³ (1.83 cu.yd)
PC300-8 ⁶ (SE spec)	Triple-grouser	600 (24")*	48280 (7483)	0.68 (9.70)	±0	:6.47 m (21'3")
		700 (28")	56330 (8731)	0.59 (8.45)	+360 (795)	:3.185 m (10'5")
		800 (31.5")	64370 (9977)	0.52 (7.47)	+710 (1565)	:1.4 m ³ (1.83 cu.yd)
PC300-8 ⁷	Triple-grouser	600 (24")	48280 (7483)	0.64 (9.12)	-710 (1565)	:6.47 m (21'3")
		700 (28")	56330 (8731)	0.56 (7.96)	-360 (795)	:3.185 m (10'5")
		800 (31.5")*	64370 (9977)	0.49 (6.97)	±0	:1.4 m ³ (1.83 cu.yd)
PC300-8 ⁷ (SE spec)	Triple-grouser	600 (24")	48280 (7483)	0.68 (9.70)	-710 (1565)	:6.47 m (21'3")
		700 (28")	56330 (8731)	0.59 (8.45)	-360 (795)	:3.185 m (10'5")
		800 (31.5")*	64370 (9977)	0.52 (7.47)	±0	:1.4 m ³ (1.83 cu.yd)
PC300-7	Triple-grouser	600 (24")*	48280 (7483)	0.64 (9.10)	±0	:6.47 m (21'3")
		700 (28")	56330 (8731)	0.55 (7.82)	+360 (794)	:3.185 m (10'5")
		800 (31.5")	64370 (9977)	0.47 (6.68)	+710 (1565)	:1.4 m ³ (1.83 cu.yd)
PC300-7 ⁴	Triple-grouser	600 (24")*	48280 (7483)	0.65 (9.24)	±0	:6.47 m (21'3")
		700 (28")	56330 (8731)	0.55 (7.82)	+360 (794)	:1.4 m ³ (1.83 cu.yd)
		800 (31.5")	64370 (9977)	0.47 (6.68)	+710 (1565)	:1.4 m ³ (1.83 cu.yd)
PC300LC-8 PC300LC-8 ¹¹	Triple-grouser	600 (24")	52230 (8096)	0.60 (8.53)	-600 (1323)	:6.47 m (21'3")
		700 (28")*	60940 (9446)	0.53 (7.54)	±0	:3.185 m (10'5")
		800 (31.5")	69650 (10796)	0.47 (6.68)	+380 (838)	:1.4 m ³ (1.83 cu.yd)
PC300LC-8 ⁶	Triple-grouser	600 (24")	52230 (8096)	0.61 (8.67)	-380 (838)	:6.47 m (21'3")
		700 (28")*	60940 (9446)	0.53 (7.48)	±0	:3.185 m (10'5")
		800 (31.5")	69650 (10796)	0.47 (6.63)	+380 (838)	:1.4 m ³ (1.83 cu.yd)
PC300LC-8 ⁶ (SE spec)	Triple-grouser	600 (24")	52230 (8096)	0.69 (9.86)	-380 (838)	:6.47 m (21'3")
		700 (28")*	60940 (9446)	0.56 (7.90)	±0	:3.185 m (10'5")
		800 (31.5")	69650 (10796)	0.50 (6.98)	+380 (838)	:1.4 m ³ (1.83 cu.yd)
PC300LC-8 ⁷	Triple-grouser	600 (24")	52230 (8096)	0.60 (8.56)	-760 (1675)	:6.47 m (21'3")
		700 (28")	60940 (9446)	0.53 (7.48)	-380 (838)	:3.185 m (10'5")
		800 (31.5")*	69650 (10796)	0.47 (6.63)	±0	:1.4 m ³ (1.83 cu.yd)
PC300LC-8 ⁷ (SE spec)	Triple-grouser	600 (24")	52230 (8096)	0.56 (7.90)	-760 (1675)	:6.47 m (21'3")
		700 (28")	60940 (9446)	0.50 (6.98)	-380 (838)	:3.185 m (10'5")
		800 (31.5")*	69650 (10796)	0.60 (8.56)	±0	:1.4 m ³ (1.83 cu.yd)
PC300LC-7 ⁵	Triple-grouser	600 (24")*	52230 (8096)	0.64 (9.10)	±0	:6.47 m (21'3")
						:3.185 m (10'5")
						:1.4 m ³ (1.83 cu.yd)
PC350-8 PC350-7	Triple-grouser	600 (24")*	48280 (7483)	0.67 (9.53)	±0	:6.47 m (21'3")
		700 (28")	56330 (8731)	0.58 (8.25)	+360 (794)	:3.185 m (10'5")
						:1.4 m ³ (1.83 cu.yd)
PC350LC-8 PC350LC-7	Triple-grouser	600 (24")*	52230 (8096)	0.64 (9.10)	±0	:6.47 m (21'3")
		700 (28")	60940 (9446)	0.56 (7.96)	+380 (838)	:3.185 m (10'5")
						:1.4 m ³ (1.83 cu.yd)

* Standard shoe *4 China source *8 Brazil source *12 for Russia
 ** USA source *5 India source *9 Italy source
 *** UK source *6 Thailand source *10 for USA
 *7 Indonesia source *11 for UK

NOTE: The shoe for the long-track excavator (L and LC), wide shoe (excluding the narrowest shoe for a model) and swamp shoe are provided with low ground pressure. These shoes should be used on soft and swampy terrain where the standard excavator with standard shoe is not usable due to sinkage of the tracks. If such shoes are used in swampy fields with stones, stumps and roots, bending of the shoe plates, cracks in the links, breakage of pins, loosening of shoe bolts and other damage may result. Therefore, the job site must be studied carefully, to provide the customer with correct instructions and advice.

Ground Pressure

EXCAVATORS
(BACKHOE)

	Shoe type	Shoe width mm (in)	Ground contact area cm ² (sq.in)	Ground pressure kg/cm ² (PSI)	Change in operating weight kg (lb)	Boom Arm Bucket
PC350LC-8* ⁸	Triple-grouser	600 (24")*	52230 (8096)	0.67 (9.53)	±0	:6.47 m (21'3")
		700 (28")	60940 (9446)	0.59 (8.39)	+500 (1102)	:3.185 m (10'5")
		800 (31.5")	69650 (10796)	0.52 (7.39)	+902 (1989)	:1.4 m ³ (1.83 cu.yd)
PC360LC-10**	Triple-grouser	700 (28")	60940 (9446)	0.58 (8.25)	-380 (838)	:6.47 m (21'3")
		800 (31.5")*	69950 (10796)	0.52 (7.39)	±0	:3.185 m (10'5")
		850 (33.5")	74300 (11517)	0.49 (6.97)	+380 (838)	:1.96 m ³ (2.56 cu.yd)
PC360LC-10***	Triple-grouser	700 (28")*	60940 (9446)	0.68 (9.67)	-380 (838)	:6.47 m (21'3")
		800 (31.5")	69950 (10796)	0.52 (7.39)	+380 (838)	:3.2 m (10'6")
		850 (33.5")	74300 (11517)	0.50 (7.11)	+570 (1257)	:2.66 m ³ (3.48 cu.yd)
PC360NLC-10***	Triple-grouser	600 (24")*	52230 (8096)	0.68 (9.67)	±0	:6.47 m (21'3")
		700 (28")	60940 (9446)	0.59 (8.39)	+380 (838)	:3.2 m (10'6")
		800 (31.5")	69650 (10796)	0.52 (7.39)	+760 (1675)	:2.66 m ³ (3.48 cu.yd)
PC360-7* ⁴	Triple-grouser	600 (24")*	48280 (7483)	0.67 (9.53)	±0	:6.47 m (21'3")
						:3.185 m (10'5")
						:1.4 m ³ (1.83 cu.yd)
PC390LC-10**	Triple-grouser	700 (28")	65390 (10135)	0.59 (8.39)	-504 (1111)	:6.5 m (21'3")
		800 (31.5")*	74730 (11583)	0.52 (7.39)	±0	:3.185 m (10'5")
		900 (33.5")	84070 (13030)	0.46 (6.54)	+437 (963)	:1.96 m ³ (2.56 cu.yd)
PC400-8 PC400-8R PC400-7 PC400-7* ¹¹	Triple-grouser	600 (24")*	52090 (8074)	0.79 (11.24)	±0	:7.06 m (23'2")
		700 (28")	60770 (9419)	0.69 (9.81)	+420 (926)	:3.38 m (11'1")
		800 (31.4")	69450 (10765)	0.61 (8.67)	+850 (1874)	:1.9 m ³ (2.49 cu.yd)
PC400-8* ⁴	Triple-grouser	600 (24")*	52090 (8074)	0.81 (11.5)	±0	:7.06 m (23'2")
		700 (28")	60770 (9419)	0.70 (9.95)	+500 (1102)	:3.38 m (11'1")
		800 (31.4")	69450 (10765)	0.62 (8.82)	+900 (1984)	:1.9 m ³ (2.49 cu.yd)
PC400-8R* ⁷ (SE spec)	Triple-grouser	600 (24")*	52090 (8074)	0.81 (11.5)	±0	:7.06 m (23'2")
		700 (28")	60770 (9419)	0.70 (9.95)	+500 (1102)	:3.38 m (11'1")
		800 (31.4")	69450 (10765)	0.62 (8.82)	+940 (2072)	:1.9 m ³ (2.49 cu.yd)
PC400LC-8 PC400LC-8R	Triple-grouser	600 (24")	56050 (8638)	0.75 (10.7)	-450 (992)	:7.06 m (23'2")
		700 (28")*	65390 (10135)	0.65 (9.24)	±0	:3.38 m (11'1")
		800 (31.4")	74730 (11583)	0.57 (8.11)	+460 (1014)	:1.9 m ³ (2.49 cu.yd)
PC400LC-7 PC400LC-7* ¹¹	Triple-grouser	600 (24")	56050 (8638)	0.76 (10.81)	-450 (992)	:7.06 m (23'2")
		700 (28")*	65390 (10135)	0.66 (9.39)	±0	:3.38 m (11'1")
		800 (31.4")	74730 (11583)	0.58 (8.25)	+450 (992)	:1.9 m ³ (2.49 cu.yd)
PC450-8 PC450-8R	Triple-grouser	600 (24")*	52090 (8074)	0.82 (11.7)	±0	:7.06 m (23'2")
		700 (28")	60770 (9419)	0.71 (10.1)	+420 (926)	:3.38 m (11'1")
						:1.9 m ³ (2.49 cu.yd)
PC450-8* ⁴	Triple-grouser	600 (24")*	52090 (8074)	0.87 (12.4)	±0	:7.06 m (23'2")
						:3.38 m (11'1")
						:2.1 m ³ (2.75 cu.yd)
PC450-7	Triple-grouser	600 (24")*	52090 (8074)	0.83 (11.8)	±0	:7.06 m (23'2")
		700 (28")	60770 (9419)	0.71 (10.1)	+420 (926)	:3.38 m (11'1")
						:1.9 m ³ (2.49 cu.yd)
PC450LC-8 PC450LC-8R	Triple-grouser	600 (24")*	56050 (8688)	0.78 (11.1)	±0	:7.06 m (23'2")
		700 (28")	65390 (10135)	0.68 (9.67)	+450 (992)	:3.38 m (11'1")
						:1.9 m ³ (2.49 cu.yd)
PC490-10***	Triple-grouser	600 (24")*	52090 (8074)	0.89 (12.7)	±0	:7.1 m (23'4")
		700 (28")	60770 (9419)	0.77 (10.9)	+470 (1036)	:3.4 m (11'2")
		800 (31.4")	69450 (10765)	0.68 (9.67)	+940 (2072)	:2.2 m ³ (2.88 cu.yd)
	Double-grouser	600 (24")	52090 (8074)	0.89 (12.7)	+120 (265)	

* Standard shoe *4 China source *8 Brazil source *12 for Russia
 ** USA source *5 India source *9 Italy source
 *** UK source *6 Thailand source *10 for USA
 *7 Indonesia source *11 for UK

NOTE: The shoe for the long-track excavator (L and LC), wide shoe (excluding the narrowest shoe for a model) and swamp shoe are provided with low ground pressure. These shoes should be used on soft and swampy terrain where the standard excavator with standard shoe is not usable due to sinkage of the tracks. If such shoes are used in swampy fields with stones, stumps and roots, bending of the shoe plates, cracks in the links, breakage of pins, loosening of shoe bolts and other damage may result. Therefore, the job site must be studied carefully, to provide the customer with correct instructions and advice.

	Shoe type	Shoe width mm (in)	Ground contact area cm ² (sq.in)	Ground pressure kg/cm ² (PSI)	Change in operating weight kg (lb)	Boom Arm Bucket
PC490LC-10***	Triple-grouser	600 (24")	56050 (8688)	0.84 (12.7)	-500 (1102)	:7.1 m (23'4")
		700 (28")*	65390 (10135)	0.72 (10.9)	±0	:3.4 m (11'2")
		800 (31.4")	74730 (11583)	0.64 (9.67)	+500 (1102)	:2.2 m ³ (2.88 cu.yd)
		900 (33.5")	84070 (13030)	0.57 (6.54)	+990 (2183)	
	Double-grouser	600 (24")	56050 (8688)	0.84 (12.7)	-380 (838)	
PC490LC-10***	Triple-grouser	700 (28")	65390 (10135)	0.72 (10.9)	-500 (1102)	:7.06 m (23'2")
		800 (31.4")*	74730 (11583)	0.64 (9.67)	±0	:3.38 m (11'1")
		900 (33.5")	84070 (13030)	0.57 (6.54)	+490 (1080)	:2.25 m ³ (2.94 cu.yd)
PC550LC-8	Triple-grouser	600 (24")*	55240 (8562)	0.93 (13.2)	±0	:6.67 m (21'11")
		750 (29.5")	69090 (10709)	0.75 (10.7)	+800 (1764)	:2.4 m (7'10")
						:3.0 m ³ (3.92 cu.yd)
PC600-8E0 PC600-8R1	Triple-grouser	600 (24")*	55240 (8562)	1.04 (14.8)	±0	:7.66 m (25'2")
		750 (29.5")	69090 (10709)	0.87 (12.4)	+800 (1764)	:3.5 m (11'6")
						:2.7 m ³ (3.53 cu.yd)
PC600-8***	Triple-grouser	600 (24")*	55240 (8562)	1.03 (14.5)	±0	:7.66 m (25'2")
		750 (29.5")	69090 (10709)	0.84 (11.94)	+800 (1764)	:2.9 m (9'6")
						:2.8 m ³ (3.66 cu.yd)
PC600-7*12	Triple-grouser	600 (24")*	55240 (8562)	1.04 (14.79)	±0	:7.66 m (25'2")
		750 (29.5")	69090 (10709)	0.84 (11.94)	+800 (1764)	:3.5 m (11'6")
						:2.7 m ³ (3.53 cu.yd)
PC600LC-8E0 PC600LC-8R1	Triple-grouser	600 (24")*	59440 (9213)	1.01 (14.4)	±0	:7.66 m (25'2")
		750 (29.5")	74300 (11517)	0.82 (11.7)	+800 (1764)	:3.5 m (11'6")
		900 (33.5")	89160 (13820)	0.69 (9.8)	+1700 (3748)	:2.7 m ³ (3.53 cu.yd)
PC600LC-8***	Triple-grouser	600 (24")*	59440 (9213)	0.98 (13.9)	±0	:7.66 m (25'2")
		750 (29.5")	74300 (11517)	0.79 (11.2)	+880 (1940)	:3.5 m (11'6")
		900 (35.4")	89160 (13820)	0.67 (9.5)	+1740 (3840)	:2.7 m ³ (3.53 cu.yd)
PC600LC-7*12	Triple-grouser	600 (24")*	59440 (9213)	0.97 (13.8)	±0	:7.66 m (25'2")
		750 (29.5")	74300 (11517)	0.79 (11.2)	+880 (1940)	:3.5 m (11'6")
		900 (35.4")	89160 (13820)	0.67 (9.5)	+1740 (3840)	:2.7 m ³ (3.53 cu.yd)
PC650LC-8E0*10	Double-grouser	750 (29.5")	74300 (11517)	0.86 (12.3)	-900 (1984)	:7.66 m (25'2")
		900 (33.5")*	89160 (13820)	0.73 (10.3)	±0	:3.5 m (11'6")
						:2.7 m ³ (3.53 cu.yd)
PC650LC-8R*4	Double-grouser	600 (24")*	59440 (9213)	0.99 (14.1)	±0	:7.3 m (23'11")
						:3.5 m (11'6")
						:3.1 m ³ (4.05 cu.yd)
PC700LC-8E0 PC700LC-8R1	Double-grouser	610 (24")*	60170 (9326)	1.09 (15.5)	±0	:7.3 m (23'11")
		710 (28")	70030 (10855)	0.95 (13.5)	+800 (1764)	:3.5 m (11'6")
						:2.8 m ³ (3.66 cu.yd)
PC700LC-8E0***	Double-grouser	610 (24")*	60170 (9326)	1.08 (15.4)	±0	:6.6 m (21'8")
		710 (28")	70030 (10855)	0.94 (13.4)	+690 (1521)	:2.9 m (9'6")
		810 (32")	79900 (12385)	0.83 (11.9)	+1375 (3031)	:4.0 m ³ (5.23 cu.yd)
		910 (36")	89760 (13913)	0.74 (10.5)	+1400 (3086)	
PC700LC-8E0*4	Double-grouser	610 (24")*	60170 (9326)	1.11 (15.8)	±0	:6.6 m (21'8")
		710 (28")	70030 (10855)	0.97 (13.8)	+800 (1764)	:2.9 m (9'6")
						:4.0 m ³ (5.23 cu.yd)
PC750-7*12	Double-grouser	610 (24")*	60170 (9326)	1.20 (17.1)	±0	
		710 (28")	70030 (10855)	1.04 (14.8)	+800 (1764)	:8.2 m (26'11")
		810 (32")	79900 (12385)	0.92 (13.1)	+1330 (2930)	:3.6 m (11'10")
		910 (36")	89760 (13913)	0.83 (11.8)	+1970 (4340)	:3.1 m ³ (4.05 cu.yd)
		1010 (40")	99630 (15443)	0.75 (10.7)	+2610 (5750)	

* Standard shoe *4 China source *8 Brazil source *12 for Russia
 ** USA source *5 India source *9 Italy source
 *** UK source *6 Thailand source *10 for USA
 *7 Indonesia source *11 for UK

NOTE: The shoe for the long-track excavator (L and LC), wide shoe (excluding the narrowest shoe for a model) and swamp shoe are provided with low ground pressure. These shoes should be used on soft and swampy terrain where the standard excavator with standard shoe is not usable due to sinkage of the tracks. If such shoes are used in swampy fields with stones, stumps and roots, bending of the shoe plates, cracks in the links, breakage of pins, loosening of shoe bolts and other damage may result. Therefore, the job site must be studied carefully, to provide the customer with correct instructions and advice.

Ground Pressure

EXCAVATORS (BACKHOE)

	Shoe type	Shoe width mm (in)	Ground contact area cm ² (sq.in)	Ground pressure kg/cm ² (PSI)	Change in operating weight kg (lb)	Boom Arm Bucket
PC800-8E0 PC800-8R1	Double-grouser	610 (24")*	60170 (9326)	1.24 (17.6)	±0	:8.2 m (26'11")
		710 (28")	70030 (10855)	1.08 (15.3)	+800 (1764)	:3.6 m (11'10")
		810 (32")	79900 (12385)	0.95 (13.5)	+1330 (2932)	:3.1 m ³ (4.05 cu.yd)
		910 (36")	89760 (13913)	0.85 (12.1)	+1970 (4343)	
PC800-8E0***	Double-grouser	1010 (40")	99630 (15443)	0.77 (10.9)	+2610 (5754)	
		610 (24")*	60170 (9326)	1.30 (18.5)	±0	:7.1 m (23'4")
		710 (28")	70030 (10855)	1.12 (15.9)	+700 (1543)	:2.9 m (9'6")
		810 (32")	79900 (12385)	0.99 (13.5)	+1400 (3086)	:4.0 m ³ (5.23 cu.yd)
PC800LC-8E0 PC800LC-8R1	Double-grouser	910 (36")	89760 (13913)	0.89 (12.1)	+2100 (4630)	
		810 (32")*	88320 (13690)	0.88 (12.5)	±0	:8.2 m (26'11")
		1010 (40")	110130 (17070)	0.72 (10.2)	+1400 (3086)	:3.6 m (11'10")
		1110 (44")	121030 (18760)	0.66 (9.38)	+2100 (4630)	:3.1 m ³ (4.05 cu.yd)
PC800LC-8E0***	Double-grouser	1110 (44")	121030 (18760)	0.66 (9.38)	+2100 (4630)	
		710 (28")	77420 (12000)	1.05 (14.9)	±0	:8.0 m (26'3")
		810 (32")	88320 (13690)	0.93 (13.2)	+700 (1543)	:3.6 m (11'10")
		910 (36")	99220 (15380)	0.84 (11.9)	+1400 (3086)	:3.4 m ³ (4.45 cu.yd)
PC800LC-8E0***	Double-grouser	1010 (40")	110130 (17070)	0.76 (10.8)	+2100 (4630)	
		1110 (44")	121030 (18760)	0.70 (9.95)	+2800 (6173)	
		610 (24")*	60170 (9326)	1.25 (17.8)	±0	:7.1 m (23'4")
		710 (28")	70030 (10855)	1.09 (15.5)	+800 (1764)	:2.9 m (9'6")
PC800-8E0 PC800-8R1 (SE spec)	Double-grouser	810 (32")	79900 (12385)	0.96 (13.7)	+1330 (2932)	:4.0 m ³ (5.23 cu.yd)
		910 (36")	89760 (13913)	0.86 (12.2)	+1970 (4343)	
		1010 (40")	99630 (15443)	0.78 (11.1)	+2610 (5754)	
		610 (24")*	60170 (9326)	1.22 (17.3)	±0	:7.1 m (23'4")
PC750-7* ¹² (SE spec)	Double-grouser	710 (28")	70030 (10855)	1.06 (15.1)	+800 (1764)	:2.945 m (9'8")
		810 (32")	79900 (12385)	0.93 (13.2)	+1330 (2932)	:4.0 m ³ (5.23 cu.yd)
		910 (36")	89760 (13913)	0.84 (11.9)	+1970 (4343)	
		1010 (40")	99630 (15443)	0.76 (10.8)	+2610 (5754)	
PC800LC-8E0 PC800LC-8R1 (SE spec)	Double-grouser	810 (32")*	88320 (13690)	0.89 (12.7)	±0	:8.04 m (26'5")
		1010 (40")	110130 (17070)	0.73 (10.4)	+1400 (3086)	:3.6 m (11'10")
		1110 (44")	121030 (18760)	0.67 (9.53)	+2100 (4630)	:3.4 m ³ (4.45 cu.yd)
PC850-8E0 PC850-8R1	Double-grouser	610 (24")*	60170 (9326)	1.31 (18.6)	±0	:8.04 m (26'5")
		710 (28")	70030 (10855)	1.14 (16.2)	+800 (1764)	:3.6 m (11'10")
PC800-7* ¹²	Double-grouser					:3.4 m ³ (4.45 cu.yd)
		610 (24")*	60170 (9326)	1.27 (18.1)	±0	:8.2 m (26'11")
PC850-8E0 PC850-8R1 (SE spec)	Double-grouser	710 (28")	70030 (10855)	1.10 (15.6)	+800 (1764)	:3.6 m (11'10")
						:3.4 m ³ (4.45 cu.yd)
PC800-7* ¹² (SE spec.)	Double-grouser	610 (24")*	60170 (9326)	1.31 (18.6)	±0	:7.1 m (23'4")
		710 (28")	70030 (10855)	1.13 (16.1)	+800 (1764)	:2.945 m (9'8")
PC1250-8 PC1250-8R	Double-grouser					:4.3 m ³ (5.62 cu.yd)
		610 (24")*	60170 (9326)	1.27 (18.1)	±0	:8.2 m (26'11")
PC1250-8 PC1250-8R	Double-grouser	710 (28")	70030 (10855)	1.10 (15.6)	+800 (1764)	:3.6 m (11'10")
						:3.4 m ³ (4.45 cu.yd)
PC1250-8 PC1250-8R	Double-grouser	700 (28")*	76450 (11850)	1.39 (19.8)	±0	:9.1 m (29'10")
		1000 (39.4")	109200 (16926)	0.99 (14.1)	+2310 (5090)	:3.4 m (11'2")
PC1250-8R* ⁷	Double-grouser					:5.0 m ³ (6.54 cu.yd)
		700 (28")*	76450 (11850)	1.39 (19.8)	±0	:7.8 m (25'7")
PC1250-7	Double-grouser					:3.4 m (11'2")
		700 (28")*	76450 (11850)	1.35 (19.2)	±0	:9.1 m (29'10")
PC1250-7	Double-grouser	1000 (39.4")	109200 (16926)	0.96 (13.7)	+2300 (5070)	:3.4 m (11'2")
						:5.0 m ³ (6.54 cu.yd)

* Standard shoe *4 China source *8 Brazil source *¹² for Russia
** USA source *5 India source *9 Italy source
*** UK source *6 Thailand source *¹⁰ for USA
 *7 Indonesia source *¹¹ for UK

NOTE: The shoe for the long-track excavator (L and LC), wide shoe (excluding the narrowest shoe for a model) and swamp shoe are provided with low ground pressure. These shoes should be used on soft and swampy terrain where the standard excavator with standard shoe is not usable due to sinkage of the tracks. If such shoes are used in swampy fields with stones, stumps and roots, bending of the shoe plates, cracks in the links, breakage of pins, loosening of shoe bolts and other damage may result. Therefore, the job site must be studied carefully, to provide the customer with correct instructions and advice.

	Shoe type	Shoe width mm (in)	Ground contact area cm ² (sq.in)	Ground pressure kg/cm ² (PSI)	Change in operating weight kg (lb)	Boom Arm Bucket
PC1250LC-8	Double-grouser	1000 (39.4")*	128700 (19949)	0.88 (12.5)	±0	:9.1 m (29'10")
		1200 (47.2")	154400 (23932)	0.75 (10.4)	+2000 (4410)	:3.4 m (11'2") :5.2 m ³ (6.80 cu.yd)
PC1250-8 PC1250-8R (SP spec.)	Double-grouser	700 (28")*	76450 (11850)	1.44 (20.4)	±0	:7.8 m (25'7")
						:3.4 m (11'2") :6.7 m ³ (8.8 cu.yd)
PC1250-7 (SP spec.)	Double-grouser	700 (28")*	76450 (11850)	1.36 (19.3)	±0	:7.8 m (25'7")
						:3.4 m (11'2") :6.5 m ³ (8.5 cu.yd)
PC2000-8*7 PC2000-8	Double-grouser	810 (32")*	103020 (15970)	1.94 (27.6)	±0	:8.7 m (28'7")
	Triple-grouser	1010 (40")	128460 (1990)	1.59 (22.6)	+4120 (9085)	:3.9 m (12'10") :12.0 m ³ (15.7 cu.yd)
PC3000-6 (Diesel Drive)	Double-grouser	800 (31.4")*	106696 (16538)	2.40 (34.1)	±0	:8.6 m (28'3")
		1000 (39.3")	133370 (20672)	1.99 (28.3)	+9000 (19840)	:4.0 m (13'1") :15 m ³ (19.6 cu.yd)
PC3000-6 (Electric Drive)	Double-grouser	800 (31.4")*	106696 (16538)	2.40 (34.0)	±0	:8.6 m (28'3")
		1000 (39.3")	133370 (20672)	1.99 (28.1)	+9000 (19840)	:4.0 m (13'1") :15 m ³ (19.6 cu.yd)
PC4000-6 (Diesel Drive)	Double-grouser	1200 (47.2")*	178793 (27741)	2.20 (31.3)	±0	:9.75 m (32'0")
		1500 (59")	223491 (34641)	1.79 (25.4)	+5000 (11020)	:4.5 m (14'9") :22 m ³ (28.8 cu.yd)
PC4000-6 (Electric Drive)	Double-grouser	1200 (47.2")*	178793 (27741)	2.18 (31.0)	±0	:9.75 m (32'0")
		1500 (59")	223491 (34641)	1.77 (25.1)	+5000 (11023)	:4.5 m (14'9") :22 m ³ (28.8 cu.yd)
PC5500-6 (Diesel Drive)	Double-grouser	1350 (53")*	222145 (34432)	2.41 (34.3)	±0	:11 m (36'1")
		1800 (71")	296194 (45910)	1.85 (26.3)	+14000 (30860)	:5.1 m (16'9") :29 m ³ (38 cu.yd)
PC5500-6 (Electric Drive)	Double-grouser	1350 (53")*	222145 (34432)	2.41 (34.3)	±0	:11 m (36'1")
		1800 (71")	296194 (45910)	1.85 (26.4)	+14000 (30860)	:5.1 m (16'9") :29 m ³ (38 cu.yd)
PC8000-6 (Diesel Drive)	Double-grouser	1500 (59")*	276668 (41954)	2.75 (39.1)	±0	:11.5 m (37'9")
		1900 (75")	342846 (53141)	2.27 (32.3)	+14000 (30860)	:5.5 m (18'1") :42 m ³ (55 cu.yd)
PC8000-6 (Electric Drive)	Double-grouser	1500 (59")*	276668 (41954)	2.70 (38.5)	±0	:11.5 m (37'10")
		1900 (75")	342846 (53141)	2.17 (30.9)	+12000 (26460)	:5.5 m (18'1") :38 m ³ (49.7 cu.yd)

* Standard shoe *4 China source *8 Brazil source *12 for Russia
 ** USA source *5 India source *9 Italy source
 *** UK source *6 Thailand source *10 for USA
 *7 Indonesia source *11 for UK

NOTE: The shoe for the long-track excavator (L and LC), wide shoe (excluding the narrowest shoe for a model) and swamp shoe are provided with low ground pressure. These shoes should be used on soft and swampy terrain where the standard excavator with standard shoe is not usable due to sinkage of the tracks. If such shoes are used in swampy fields with stones, stumps and roots, bending of the shoe plates, cracks in the links, breakage of pins, loosening of shoe bolts and other damage may result. Therefore, the job site must be studied carefully, to provide the customer with correct instructions and advice.

BUCKET CAPACITY RATING

Bucket capacity is measured in terms of either struck or heaped capacity. Generally, the heaped capacity description is more frequently used.

Komatsu Ltd. rates the excavator bucket capacity based on ISO and other standards such as JIS, PCSA and SAE (JIS and SAE are based on ISO.)

1) Struck Capacity

The struck capacity is the volume capacity of the bucket after it has been struck at the strike plane. The strike plane passes through the top back edge of the bucket and the cutting edge. (See top figure at right)

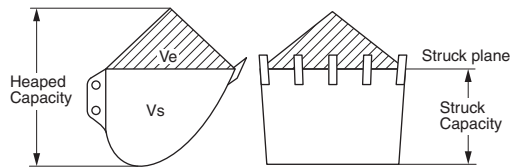

2) Heaped Capacity

The heaped capacity is the sum of the struck capacity plus the volume of material heaped on the bucket at a 1:2 angle of repose, as shown in the center figure at right. This in no way implies that the hoe must carry the bucket oriented in this attitude, or that all material will naturally have a 1:2 angle of repose.

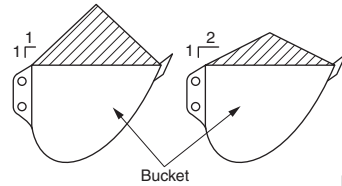

FVBH0256

$V_h = V_s + V_e$ Where:

- Vs: struck capacity
- Vh: heaped capacity
- Ve: excess material heaped at 1:2 or 1:1 angle of repose

There are various standards for designating the heaped capacity of the bucket.

The principal difference among these definitions is the "angle of repose", as listed in the table below.

The angle of repose

Standard Bucket type	ISO	JIS	PCSA	SAE	CECE
Hoe bucket	1:1	1:1	1:1	1:1	1:2
Loading shovel	1:2	1:2	1:2	1:2	1:2

Notes:

- ISOInternational Organization of Standard - ISO 7451 and ISO 7546
- JISJapanese Industrial Standard - JIS A8401 - 1976
- PCSAPower Crane and Shovel Association (USA) - PCSA No.37-26
- SAESociety of Automotive Engineers (USA) - SAE J296/J742b
- CECECommittee of European Construction Equipment - CECE SECTION VI

Bucket selection for excavator

Komatsu offers various kinds and sizes of buckets so that the users are able to select the optimum bucket for the type of soil and the work to be performed. This enables the work to be accomplished most efficiently. The following is a guide for selecting the optimum bucket.

1. Selection of type (shape)

Various types can be attached to excavators.

- General purpose bucket
- Light duty bucket
- Heavy duty bucket
- Narrow bucket (Ditch bucket)
- Rock bucket
- Ripper bucket
- Other special buckets

The appropriate type should be selected for each job application.

It is recommended to ask the Komatsu distributor about the availability of necessary buckets. When the necessary bucket is not currently available, the distributor can request Komatsu to develop it.

2. Selection of size

The following two points 1) and 2) should be considered altogether.

1) From the machine stability (For backhoe type)

If the bucket size (capacity) is too big, it will worsen the stability of the machine, resulting in danger of tipping over or rolling over.

The concept of the bucket selection from the point of machine stability is from the following.

Putting A as the maximum allowable load from over-side (sideways) machine stability and B as the bucket working load (bucket weight + carrying material weight), the size of the bucket should be selected so as to be;

$$B \leq A$$

From Figure 1,

$$A = W_1 + (L_0 / L) \quad W_2 = W_1 + W_2 \text{ Approximately}$$

where, W₁ : The weight of the empty bucket shown in the table of Lift Capacity. The value of the weight is shown in the tables of "Bucket and Arm Combination".

W₂ : The smallest lift capacity in the table of Lift Capacity at respective boom length and arm length (The lift capacity differs by the arm vertical position)

From Figure 2,

$$B = W_3 + W_4$$

where, W₃ : The bucket weight used for the job

W₄ : The weight of carried material
(= rated bucket capacity × specific gravity of carried material)

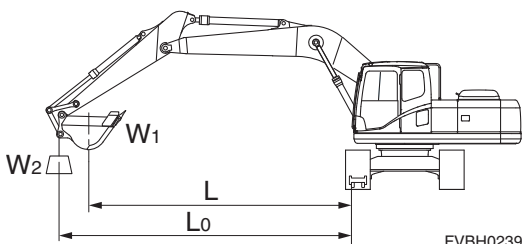

Figure 1

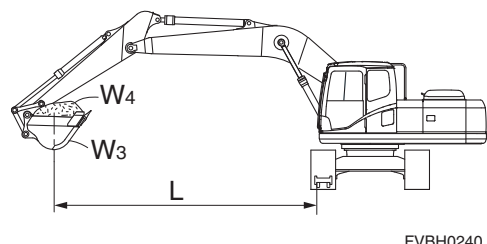

Figure 2

2) From the bucket penetration force

When selecting a bucket, check whether the penetration force of the bucket is sufficient for the soil at the job site. The bucket penetration force is the digging force per unit width of the bucket.

$$\text{Bucket penetration force} = \text{Digging force} / \text{Bucket width}$$

The larger the digging force per unit width of the bucket is, the larger the bucket penetration force (penetration performance) is.

The digging force is generated by the bucket hydraulic cylinder(s) and the boom hydraulic cylinder(s). In addition to the digging force, the width of the bucket and the tip radius (dimension from the bucket hinge center to the forefront of the bucket teeth) affects the bucket penetration force.

(1) Digging force

Rated digging force of the bucket is the force at the foremost digging point of the bucket. This digging force is generated by the bucket hydraulic cylinder and the arm hydraulic cylinder. The former is called the "Bucket digging force" and the latter is called the "Arm crowd force".

These digging forces are calculated by applying working relief hydraulic pressure to the cylinder(s). The weight of components and friction are to be excluded in the calculation. The definition of the digging forces are based on SAE J1179 and are as follows.

a. Bucket digging force

The rated bucket digging force (V, in the top figure) is the force generated by the bucket cylinder(s) and the tangent to the arc of radius C. The bucket should be positioned to obtain the maximum output moment from the bucket cylinder(s) and the connecting linkage.

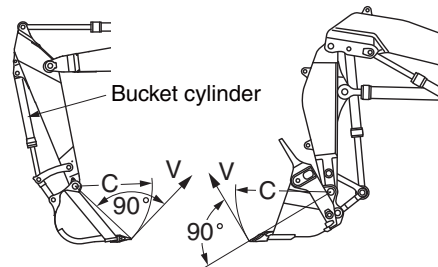

b. Arm crowd force

The rated arm crowd force (W, in the bottom figure) is the force generated by the arm cylinder(s) and the tangent to the arc of the radius B. The arm should be positioned to obtain the maximum output moment from the arm cylinder(s) and the bucket, positioned as mentioned above.

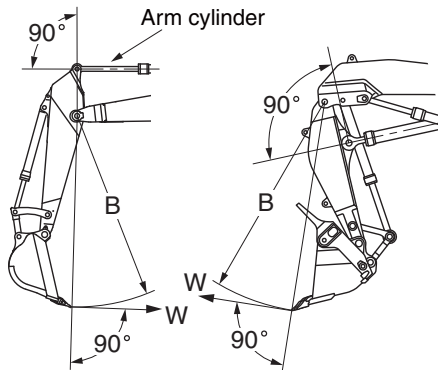

(2) Bucket width

The wider the bucket is, the worse the bucket penetration is. Generally speaking, a wide bucket is recommended for excavating soil that can be broken easily. A narrow bucket is better suited for work on hard soil.

The width of the bucket must be limited also from the point of durability of the bucket, arm, boom and their hinge pins and bushings,. If the width is too great, it will cause excessive twist on the relevant parts, resulting in premature breakage or wear.

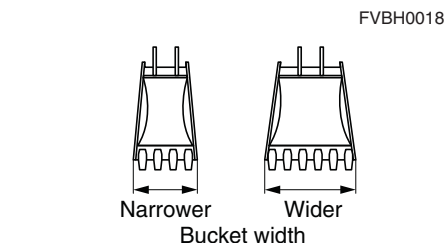

(3) Tip radius

The tip radius also affects the digging force of the bucket. If the bucket cylinder is provided with the same pushing force, the bucket with the shorter tip radius is better able to dig hard soil than the bucket with the longer tip radius.

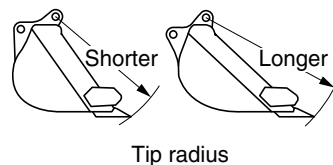

The bucket width and the tip radius should be selected with the combination of the digging forces mentioned above in order to have appropriate bucket penetration.

When you need the values for allowable bucket width and bucket penetration force for each model, you can request and get the figures from Komatsu through your distributor.

FVBH0045

Bucket and Arm Combinations

EXCAVATORS (BACKHOE)

This shows the bucket sizes currently available for respective models produced in various Komatsu plants, in relation with the arm length.

All allowable sizes from the concept of machine stability in "BUCKET SELECTION" are not shown, but it is possible for Komatsu plants to develop the various size buckets according to the theory of "BUCKET SELECTION", if it is requested through a distributor.

The theory of "BUCKET SELECTION" can be applied when a bucket is procured from a local attachment manufacturers. But the quality of the bucket from a local supplier can not be guaranteed by Komatsu.

These charts are based on over-side stability with fully loaded bucket at maximum reach.							
● : General purpose use, weight up to 2.1 t/m ³ (3500 lb/cu.yd) ○ : General purpose use, weight up to 1.8 t/m ³ (3000 lb/cu.yd) □ : General purpose use, weight up to 1.5 t/m ³ (2500 lb/cu.yd) ⊙ : Light duty work, weight up to 1.2 t/m ³ (2000 lb/cu.yd) ✕ : Not usable.							
Bucket capacity (heaped)		Width		Weight kg (lb) (With side cutters or side shrouds)	Arm length m (ft.in)		
SAE, PCSA m ³ (cu.yd)	CECE m ³ (cu.yd)	Without side cutters or side shrouds mm (in)	With side cutters or side shrouds mm (in)				
PC09-1					0.684 (2'3")	0.687(2'3")	0.884 (2'11")
0.017 (0.022)	—	225 (8.9")	250 (9.8")	11 (24)	○	○	○
0.022 (0.029)*	—	325 (12.8")	350 (13.8")	14 (31)	○	○	⊙
0.025 (0.033)	—	375 (14.8")	400 (15.7")	15 (33)	⊙	✕	✕
PC14R-3					0.88 (2'11")	1.13 (3'8")	
0.03 (0.04)	—	250 (9.8")	—	19 (42)	○	○	
0.035(0.046)	—	300 (11.8")	—	20 (44)	○	○	
0.04 (0.05)*	—	350 (13.8")	—	22 (48)	○	○	
0.05 (0.065)	—	400 (15.7")	—	23 (51)	○	✕	
0.06 (0.08)	—	450 (17.7")	—	25 (55)	○	✕	
PC16R-3					0.965 (2'2")	1.215 (4'0")	
0.03 (0.04)	—	250 (9.8")	—	19 (42)	○	○	
0.035(0.046)	—	300 (11.8")	—	20 (44)	○	○	
0.04 (0.05)*	—	350 (13.8")	—	22 (48)	○	○	
0.05 (0.065)	—	400 (15.7")	—	23 (51)	○	✕	
0.06 (0.08)	—	450 (17.7")	—	25 (55)	○	✕	
PC18MR-3					0.965 (3'2")	1.215 (4'0")	
0.022 (0.029)	0.02 (0.03)	250 (9.8")	300 (11.8")	—	○	○	
0.04 (0.05)	0.035 (0.05)	350 (13.8")	400 (15.7")	—	○	○	
0.044 (0.06)	0.04 (0.052)	400 (15.7")	450 (17.7")	—	○	✕	
PC18MR-3**					0.965 (3'2")	1.215 (4'0")	
0.03 (0.04)	—	250 (9.8")	—	19 (42)	○	○	
0.035(0.046)	—	300 (11.8")	—	20 (44)	○	○	
0.04 (0.05)	—	350 (13.8")	—	22 (48)	○	○	
0.05 (0.065)	—	400 (15.7")	—	23 (51)	○	✕	
0.06 (0.08)	—	450 (17.7")	—	25 (55)	⊙	✕	
PC20MR-3					0.97 (3'2")	1.32 (4'4")	
0.033 (0.043)	0.03 (0.04)	250 (9.8")	320 (12.6")	32 (70)	○	○	
0.044 (0.058)	0.04 (0.05)	350 (13.8")	420 (16.2")	37 (82)	○	○	
0.066 (0.086)	0.06 (0.08)	430 (16.9")	500 (19.7")	48 (106)	○	○	
0.08 (0.10)	0.07 (0.09)	530 (20.9")	600 (23.6")	52 (115)	⊙	✕	
PC22MR-3					0.97 (3'2")	1.32 (4'4")	
0.035 (0.046)	—	250 (9.8")	—	30 (66)	○	○	
0.055 (0.072)	—	350 (13.8")	—	40 (88)	○	○	
0.07 (0.09)	—	450 (17.7")	—	50 (110)	○	○	
0.085 (0.11)	—	550 (21.7")	—	60 (132)	⊙	✕	
PC27MR-3					1.1 (3'7")	1.37 (4'6")	
0.035 (0.046)	0.03 (0.04)	250 (10")	320 (12.6")	—	○	○	
0.044 (0.058)	0.04 (0.05)	280 (11")	350 (13.8")	—	○	○	
0.08 (0.10)	0.07 (0.09)	430 (17")	500 (19.7")	—	○	○	
0.09 (0.12)	—	430 (21")	500 (19.7")	—	○	✕	

- | | | | |
|--------------------------|----------------------|-------------------|----------------------|
| * Without side cutters | *6 Thailand source | *11 India source | *16 Bucket lip width |
| ** Heavy-duty bucket | *7 Brazil source | *12 for USA | *17 for Russia |
| *** Rock (Quarry) bucket | *8 UK source | *13 Russia source | |
| *4 Italy source | *9 USA source | *14 for UK | |
| *5 China source | *10 Indonesia source | | |

Bucket and Arm Combinations

EXCAVATORS (BACKHOE)

These charts are based on over-side stability with fully loaded bucket at maximum reach.

- : General purpose use, weight up to 2.1 t/m³ (3500 lb/cu.yd)
- : General purpose use, weight up to 1.8 t/m³ (3000 lb/cu.yd)
- : General purpose use, weight up to 1.5 t/m³ (2500 lb/cu.yd)
- ⊙ : Light duty work, weight up to 1.2 t/m³ (2000 lb/cu.yd)
- ✕ : Not usable.

Bucket capacity (heaped)		Width		Weight kg (lb) (With side cutters or side shrouds)	Arm length m (ft.in)	
SAE, PCSA m ³ (cu.yd)	CECE m ³ (cu.yd)	Without side cutters or side shrouds mm (in)	With side cutters or side shrouds mm (in)			
PC30MR-3					1.24 (4'1")	1.61 (5'3")
0.035 (0.046)	0.03 (0.04)	250 (9.8")	320 (12.6")	50 (110)	○	○
0.044 (0.058)	0.04 (0.05)	280 (11.0")	350 (13.8")	52 (115)	○	○
0.09 (0.12)	0.08 (0.10)	430 (16.9")	500 (19.7")	63 (139)	○	✕
0.11 (0.14)	0.10 (0.13)	530 (20.9")	600 (23.6")	81 (178)	⊙	✕
PC30MR-3**					1.24 (4'1")	1.61 (5'3")
0.035 (0.046)	—	300 (11.8")	—	55 (121)	○	○
0.07 (0.09)	—	400 (15.7")	—	65 (143)	○	○
0.095 (0.12)	—	500 (19.7")	—	80 (176)	○	✕
0.12 (0.16)	—	600 (23.6")	—	90 (198)	⊙	✕
0.13 (0.17)	—	650 (25.6")	—	95 (209)	⊙	✕
PC35MR-3					1.37 (4'6")	1.72 (5'8")
0.055 (0.072)	0.05 (0.065)	350 (13.8")	420 (16.5")	59 (130)	○	○
0.09 (0.12)	0.08 (0.10)	430 (16.9")	500 (19.7")	78 (172)	○	○
0.11 (0.143)	0.10 (0.13)	530 (20.9")	600 (23.6")	83 (183)	○	✕
0.13 (0.17)	0.12 (0.16)	630 (24.8")	700 (27.6")	98 (216)	⊙	✕
PC35MR-3**					1.37 (4'6")	1.72 (5'8")
0.035 (0.046)	—	300 (11.8")	—	55 (121)	○	○
0.07 (0.09)	—	400 (15.7")	—	65 (143)	○	○
0.095 (0.12)	—	500 (19.7")	—	80 (176)	○	○
0.12 (0.16)	—	600 (23.6")	—	90 (198)	○	✕
0.13 (0.17)	—	650 (25.6")	—	95 (209)	⊙	✕
PC45MR-3					1.375 (4'6")	1.77 (5'10")
0.055 (0.07)	0.05 (0.065)	300 (11.8")	370 (14.6")	89 (196)	○	○
0.11 (0.14)	0.10 (0.13)	430 (16.9")	500 (19.7")	94 (207)	○	○
0.14 (0.18)	0.13 (0.17)	530 (20.9")	600 (23.6")	105 (231)	○	✕
0.16 (0.21)	0.12 (0.18)	580 (22.8")	650 (25.6")	121 (267)	⊙	✕
PC45MR-3**					1.375 (4'6")	1.77 (5'10")
0.07 (0.09)	—	300 (11.8")	—	75 (165)	○	○
0.10 (0.13)	—	400 (15.7")	—	90 (198)	○	○
0.125 (0.16)	—	500 (19.7")	—	100 (202)	○	○
0.15 (0.20)	—	600 (23.6")	—	115 (253)	○	✕
0.175 (0.39)	—	700 (27.6")	—	125 (276)	⊙	✕
PC55MR-3					1.64 (5'5")	2.0 (6'7")
0.055 (0.07)	0.05 (0.065)	300 (11.8")	370 (14.6")	89 (196)	○	○
0.11 (0.14)	0.10 (0.13)	430 (16.9")	500 (19.7")	94 (207)	○	○
0.16 (0.21)	0.21 (0.18)	580 (22.8")	650 (25.6")	121 (267)	○	✕
PC55MR-3**					1.64 (5'5")	2.0 (6'7")
0.07 (0.09)	—	300 (11.8")	—	75 (165)	○	○
0.10 (0.13)	—	400 (15.7")	—	90 (198)	○	○
0.125 (0.16)	—	500 (19.7")	—	100 (202)	○	○
0.15 (0.20)	—	600 (23.6")	—	115 (253)	○	○
0.175 (0.39)	—	700 (27.6")	—	125 (276)	⊙	✕
PC56-7					1.64 (5'5")	
0.055 (0.07)	—	300 (11.8")	365 (14.4")	90 (198)	○	
0.11 (0.14)	—	430 (16.9")	500 (19.7")	110 (243)	○	
0.2 (0.26)	—	630 (24.8")	700 (27.6")	170 (375)	○	
0.22 (0.29)	—	655 (25.8")	725 (28.5")	180 (397)	○	

- | | | | |
|--------------------------|----------------------|-------------------|----------------------|
| * Without side cutters | *6 Thailand source | *11 India source | *16 Bucket lip width |
| ** Heavy-duty bucket | *7 Brazil source | *12 for USA | *17 for Russia |
| *** Rock (Quarry) bucket | *8 UK source | *13 Russia source | |
| *4 Italy source | *9 USA source | *14 for UK | |
| *5 China source | *10 Indonesia source | | |

Bucket and Arm Combinations

EXCAVATORS (BACKHOE)

These charts are based on over-side stability with fully loaded bucket at maximum reach.

- : General purpose use, weight up to 2.1 t/m³ (3500 lb/cu.yd)
- : General purpose use, weight up to 1.8 t/m³ (3000 lb/cu.yd)
- : General purpose use, weight up to 1.5 t/m³ (2500 lb/cu.yd)
- ⊙ : Light duty work, weight up to 1.2 t/m³ (2000 lb/cu.yd)
- ✕ : Not usable.

Bucket capacity (heaped)		Width		Weight kg (lb) (With side cutters or side shrouds)	Arm length m (ft.in)		
SAE, PCSA m ³ (cu.yd)	CECE m ³ (cu.yd)	Without side cutters or side shrouds mm (in)	With side cutters or side shrouds mm (in)				
PC60-8*5					1.55 (5'1")		
0.25 (0.33)	—	600 (23.6")	700 (27.6")	250 (551)	○		
0.30 (0.39)	—	655 (25.8")	750 (29.5")	280 (617)	○		
0.30W (0.39)	—	775 (30.5")	890 (35.0")	285 (628)	○		
PC70-8					1.65 (5'5")		
					1.65 (5'5") Strengthened Arm		
0.30 (0.39)	—	655 (25.8")	750 (29.5")	250 (551)	○		
0.37 (0.48)	—	815 (32.1")	925 (36.4")	280 (617)	○		
0.37 (0.48)**	—	680 (26.8")	775 (30.5")	285 (628)	✕		
PC70-8*5					1.65 (5'5")		
					1.65 (5'5") Strengthened Arm		
0.30 (0.39)	—	655 (25.8")	750 (29.5")	290 (639)	○		
0.37 (0.48)	—	815 (32.1")	925 (36.4")	300 (661)	○		
0.37 (0.48)**	—	680 (26.8")	775 (30.5")	310 (683)	✕		
PC71-7					1.65 (5'5")		
					2.25 (7'5")		
0.09 (0.12)	0.08 (0.10)	350 (13.8")	450 (17.7")	145 (320)	○		
0.30 (0.39)**	0.27 (0.35)	650 (25.6")	750 (29.5")	266 (586)	○		
0.30 (0.39)	0.27 (0.35)	790 (61.1")	890 (35.0")	236 (520)	○		
0.35 (0.46)	0.30 (0.39)	845 (33.3")	950 (37.4")	265 (584)	○		
PC78US-8					1.65 (5'5")		
					2.25 (7'5")		
0.09 (0.12)	0.08 (0.10)	350 (13.8")	450 (17.7")	145 (320)	○		
0.12 (0.16)	0.11 (0.14)	450 (17.7")	550 (21.7")	160 (355)	○		
0.20 (0.26)	0.18 (0.24)	550 (21.7")	650 (25.6")	185 (410)	○		
0.28 (0.37)	0.25 (0.33)	650 (25.6")	750 (29.5")	210 (465)	○		
0.34 (0.45)	0.30 (0.39)	755 (29.7")	—	210 (465)	⊙		
PC80MR-3					1.65 (5'5")		
					1.9 (6'3")		
					2.25 (7'5")		
0.086 (0.11)	—	300 (11.8")	—	120 (265)	○		
0.128 (0.17)	—	400 (15.7")	—	130 (287)	○		
0.171 (0.22)	—	500 (19.7")	—	142 (313)	○		
0.2 (0.26)	—	600 (23.6")	—	155 (342)	○		
0.232 (0.30)	—	700 (27.6")	—	168 (370)	○		
0.265 (0.35)	—	800 (31.5)	—	180 (397)	○		
PC88MR-8					1.65 (5'5")		
					2.25 (7'5")		
0.09 (0.12)	0.08 (0.10)	350 (13.8")	450 (17.7")	145 (320)	○		
0.12 (0.16)	0.11 (0.14)	450 (17.7")	550 (21.7")	160 (353)	○		
0.20 (0.26)	0.18 (0.24)	550 (21.7")	650 (25.6")	185 (408)	○		
0.28 (0.37)	0.25 (0.33)	650 (25.6")	750 (29.5")	210 (463)	○		
0.34 (0.45)	0.30 (0.39)	750 (29.7")	—	210 (463)	⊙		
PC88MR-8*4					1.65 (5'5")		
					2.1 (6'11")		
0.077 (1.0)	—	350 (13.8")	—	128 (282)	○		
0.109 (0.14)	—	450 (17.7")	—	144 (317)	○		
0.181 (0.24)	—	550 (21.7")	—	156 (344)	○		
0.235 (0.31)	—	650 (25.6")	—	175 (386)	○		
0.282 (0.37)	—	750 (29.7")	—	200 (441)	○		
PC110-7*5					2.26 (7'5")		
0.48 (0.63)	—	833 (32.8")	—	450 (992)	○		

- * Without side cutters
- ** Heavy-duty bucket
- *** Rock (Quarry) bucket
- *4 Italy source
- *5 China source
- *6 Thailand source
- *7 Brazil source
- *8 UK source
- *9 USA source
- *10 Indonesia source

- *11 India source
- *12 for USA
- *13 Russia source
- *14 for UK
- *16 Bucket lip width
- *17 for Russia

Bucket and Arm Combinations

EXCAVATORS (BACKHOE)

These charts are based on over-side stability with fully loaded bucket at maximum reach.

- : General purpose use, weight up to 2.1 t/m³ (3500 lb/cu.yd)
- : General purpose use, weight up to 1.8 t/m³ (3000 lb/cu.yd)
- : General purpose use, weight up to 1.5 t/m³ (2500 lb/cu.yd)
- ⊙ : Light duty work, weight up to 1.2 t/m³ (2000 lb/cu.yd)
- × : Not usable.

Bucket capacity (heaped)		Width		Weight kg (lb) (With side cutters or side shrouds)	Arm length m (ft.in)		
SAE, PCSA m ³ (cu.yd)	CECE m ³ (cu.yd)	Without side cutters or side shrouds mm (in)	With side cutters or side shrouds mm (in)				
PC118MR-8^{*4}					1.85 (6'1")	2.0 (6'7")	2.3 (7'7")
0.093 (0.12)	—	—	—	168 (370)	○	○	○
0.15 (0.20)	—	—	—	194 (428)	○	○	○
0.19 (0.25)	—	—	—	218 (481)	○	○	○
0.24 (0.31)	—	—	—	234 (516)	○	○	○
0.28 (0.37)	—	—	—	252 (555)	○	○	○
0.33 (0.43)	—	—	—	270 (595)	○	○	○
0.36 (0.47)	—	—	—	294 (648)	○	○	○
0.40 (0.52)	—	—	—	320 (705)	○	○	⊙
PC130-8					2.1 (6'11")	2.50 (8'2")	3.00 (9'10")
0.18 (0.24)	0.16 (0.21)	450 (17.7")	570 (22.4")	256 (565)	○	○	○
0.28 (0.37)	0.26 (0.34)	600 (23.6")	720 (28.3")	303 (668)	○	○	○
0.36 (0.47)	0.33 (0.43)	700 (27.6")	820 (32.3")	330 (728)	○	○	○
0.50 (0.65)	0.45 (0.59)	859 (33.8")	979 (38.5")	399 (880)	○	○	×
0.60 (0.78)	0.55 (0.72)	1000 (39.4")	—	436 (961)*	○	○	×
PC130-8^{*6}					2.5 (8'2")	3.00 (9'10")	
0.18 (0.24)	0.16 (0.21)	450 (17.7")	570 (22.4")	256 (565)	○	○	
0.28 (0.37)	0.26 (0.34)	600 (23.6")	720 (28.3")	303 (670)	○	○	
0.36 (0.47)	0.33 (0.43)	700 (27.6")	820 (32.3")	330 (730)	○	○	
0.50 (0.65)	0.45 (0.59)	859 (33.8")	979 (38.5")	399 (880)	○	○	
0.60 (0.78)	0.55 (0.72)	1000 (39.4")	—	436 (961)*	⊙	⊙	
PC130-8^{*7}					2.5 (8'2")		
0.50 (0.65)	0.45 (0.59)	859 (33.8")	979 (38.5")	399 (880)	○		
0.60 (0.78)	0.55 (0.72)	1000 (39.4")	—	436 (961)*	○		
PC130-7^{*11}					2.1 (6'11")	2.5 (8'2")	
0.53 (0.69)	—	859 (33.8")	984 (38.7")	433 (954)	○	○	
0.53 (0.69)**	—	—	908 (35.8")	470 (1036)	○	○	
0.64 (0.83)	—	1000 (39.4")	1125 (44.3")	485 (1069)	○	□	
0.70 (0.91)	—	1080 (42.5")	1210 (47.6")	575 (1267)	○	□	
PC130-7^{*6}					2.1 (6'11")	2.50 (8'2")	3.00 (9'10")
0.36 (0.47)	—	700 (27.6")	825 (32.5")	361 (796)	○	○	○
0.45 (0.59)	—	833 (32.8")	958 (37.7")	395 (871)	○	○	○
0.53 (0.69)	—	859 (33.8")	984 (38.7")	433 (955)	○	○	□
0.64 (0.84)	—	1000 (39.4")	1125 (44.3")	485 (1069)	○	□	□
PC138US-8					2.1 (6'11")	2.50 (8'2")	3.00 (9'10")
0.18 (0.24)	0.16 (0.21)	450 (17.7")	570 (22.4")	256 (565)	○	○	○
0.28 (0.37)	0.26 (0.34)	600 (23.6")	720 (28.3")	303 (670)	○	○	○
0.36 (0.50)	0.33 (0.43)	700 (27.6")	820 (32.3")	330 (730)	○	○	○
0.50 (0.65)	0.45 (0.59)	859 (33.8")	979 (38.5")	399 (880)	○	○	×
0.60 (0.78)	0.55 (0.72)	1000 (39.4")	—	436 (961)*	○	○	×
PC138US-8^{*8}					2.1 (6'11")	2.5 (8'2")	3.00 (9'10")
0.18 (0.24)	—	400 (15.7")	—	300 (661)*	○	○	○
0.25 (0.33)	—	500 (19.7")	—	325 (716)*	○	○	○
0.32 (0.42)	—	600 (23.6")	—	350 (772)*	○	○	○
0.40 (0.52)	—	700 (27.6")	—	390 (860)*	○	○	○
0.48 (0.63)	—	800 (31.5")	—	440 (970)*	○	○	○
0.56 (0.73)	—	900 (35.4")	—	475 (1047)*	○	○	○
0.64 (0.84)	—	1000 (39.4")	—	505 (1113)*	○	□	□
0.72 (0.94)	—	1100 (43.3")	—	560 (1235)*	□	□	⊙
0.80 (1.05)	—	1200 (47.2")	—	620 (1367)	⊙	⊙	×

- | | | | |
|--------------------------|----------------------|-------------------|----------------------|
| * Without side cutters | *6 Thailand source | *11 India source | *16 Bucket lip width |
| ** Heavy-duty bucket | *7 Brazil source | *12 for USA | *17 for Russia |
| *** Rock (Quarry) bucket | *8 UK source | *13 Russia source | |
| *4 Italy source | *9 USA source | *14 for UK | |
| *5 China source | *10 Indonesia source | | |

Bucket and Arm Combinations

EXCAVATORS (BACKHOE)

These charts are based on over-side stability with fully loaded bucket at maximum reach.

- : General purpose use, weight up to 2.1 t/m³ (3500 lb/cu.yd)
- : General purpose use, weight up to 1.8 t/m³ (3000 lb/cu.yd)
- : General purpose use, weight up to 1.5 t/m³ (2500 lb/cu.yd)
- ⊙ : Light duty work, weight up to 1.2 t/m³ (2000 lb/cu.yd)
- × : Not usable.

Bucket capacity (heaped)		Width		Weight kg (lb) (With side cutters or side shrouds)	Arm length m (ft.in)		
SAE, PCSA m ³ (cu.yd)	CECE m ³ (cu.yd)	Without side cutters or side shrouds mm (in)	With side cutters or side shrouds mm (in)				
PC138USLC-10^{*12}					2.50 (8'2")	3.00 (9'10")	
0.26 (0.34)	—	457 (18")	—	332 (732)	○	○	
0.38 (0.50)	—	610 (24")	—	387 (853)	○	○	
0.51 (0.67)	—	762 (30")	—	437 (963)	○	○	
0.63 (0.83)	—	914 (36")	—	499 (1099)	○	□	
0.76 (1.00)	—	1067 (42")	—	559 (1232)	□	⊙	
PC160LC-8					2.25 (7'5")	2.61 (8'7")	2.90 (9'6")
0.60 (0.78)	0.55 (0.72)	900 (35.4")	1000 (39.4")	474 (1040)	○	○	○
0.65 (0.85)	0.60 (0.78)	966 (38.0")	1066 (42.0)	499 (1100)	○	○	×
0.70 (0.92)	0.65 (0.85)	1100 (43.3")	—	504 (1100)*	○	○	×
PC160LC-8^{*8}					2.25 (7'5")	2.60 (8'7")	2.90 (9'6")
0.38 (0.50)	—	600 (23.6")	—	385 (849)*	○	○	○
0.47 (0.61)	—	700 (27.6")	—	435 (959)*	○	○	○
0.56 (0.73)	—	800 (31.5")	—	465 (1025)*	○	○	○
0.66 (0.86)	—	900 (35.4")	—	495 (1091)*	○	○	○
0.75 (0.98)	—	1000 (39.4")	—	530 (1168)*	□	□	□
0.94 (1.23)	—	1200 (47.2")	—	615 (1356)*	⊙	⊙	×
PC160LC-8^{*6}					2.25 (7'5")	2.61 (8'7")	2.90 (9'6")
0.60 (0.78)	0.55 (0.72)	900 (35.4")	1000 (39.4")	474 (1040)	○	○	○
0.65 (0.85)	0.60 (0.78)	966 (38.0")	1066 (42.0)	499 (1100)	○	○	○
0.74 (0.97)	0.65 (0.85)	1100 (43.3")	—	530 (1168)*	○	○	⊙
PC160LC-8^{*7}					2.25 (7'5")	2.90 (9'6")	
0.65 (0.85)	—	966 (38.0")	1066 (42.0)	499 (1100)	○	○	
0.80 (1.05)	—	1192 (47.0")	1292 (50.9")	740 (1631)	○	×	
1.05 (1.37)	—	1071 (42.2")	1117 (44.0")	913 (2078)	□	×	
1.20 (1.59)	—	1228 (48.3")	1274 (50.2")	942 (2013)	⊙	×	
PC160LC-7^{*6}					2.25 (7'5")	2.61 (8'7")	2.90 (9'6")
0.65 (0.85)	0.60 (0.78)	966 (38.0")	1088 (42.8)	—	○	○	×
0.75 (0.98)	0.70 (0.92)	1100 (43.3")	—	—	○	○	×
PC190LC-8^{*8}, PC190NLC-8^{*8}					2.25 (7'5")	2.60 (8'7")	2.90 (9'6")
0.38 (0.50)	—	600 (23.6")	—	385 (849)*	○	○	○
0.47 (0.61)	—	700 (27.6")	—	435 (959)*	○	○	○
0.56 (0.73)	—	800 (31.5")	—	465 (1025)*	○	○	○
0.66 (0.86)	—	900 (35.4")	—	495 (1091)*	○	○	○
0.75 (0.98)	—	1000 (39.4")	—	530 (1168)*	□	□	□
0.94 (1.23)	—	1200 (47.2")	—	615 (1356)*	□	□	⊙
1.14 (1.49)	—	1400 (55.1")	—	695 (1532)*	⊙	⊙	×
HB205-1, HB215LC-1					2.93 (9'7")		
0.80 (1.05)	0.70 (0.92)	1045 (41.1")	1170 (46.1")	635 (1400)	○		
0.93 (1.22)	0.80 (1.05)	1200 (47.2")	1325 (52.2")	696 (1530)	⊙		
1.05 (1.37)	0.90 (1.18)	1330 (52.4")	1455 (57.3")	757 (1670)	⊙		

- | | | | |
|--------------------------|----------------------|-------------------|----------------------|
| * Without side cutters | *6 Thailand source | *11 India source | *16 Bucket lip width |
| ** Heavy-duty bucket | *7 Brazil source | *12 for USA | *17 for Russia |
| *** Rock (Quarry) bucket | *8 UK source | *13 Russia source | |
| *4 Italy source | *9 USA source | *14 for UK | |
| *5 China source | *10 Indonesia source | | |

Bucket and Arm Combinations

EXCAVATORS (BACKHOE)

These charts are based on over-side stability with fully loaded bucket at maximum reach.							
<ul style="list-style-type: none"> ● : General purpose use, weight up to 2.1 t/m³ (3500 lb/cu.yd) ○ : General purpose use, weight up to 1.8 t/m³ (3000 lb/cu.yd) □ : General purpose use, weight up to 1.5 t/m³ (2500 lb/cu.yd) ⊙ : Light duty work, weight up to 1.2 t/m³ (2000 lb/cu.yd) ✕ : Not usable. 							
Bucket capacity (heaped)		Width		Weight kg (lb) (With side cutters or side shrouds)	Arm length m (ft.in)		
SAE, PCSA m ³ (cu.yd)	CECE m ³ (cu.yd)	Without side cutters or side shrouds mm (in)	With side cutters or side shrouds mm (in)				
HB215LC-1*⁸					2.93 (9'7")		
0.43 (0.56)	—	600 (23.6")	—	570 (1257)*	○		
0.52 (0.68)	—	700 (27.6")	—	610 (1345)*	○		
0.63 (0.82)	—	800 (31.5")	—	650 (1433)*	○		
0.73 (0.95)	—	900 (35.4")	—	690 (1521)*	○		
0.84 (1.10)	—	1000 (39.4")	—	740 (1631)*	○		
0.94 (1.23)	—	1100 (43.3")	—	820 (1808)*	○		
1.05 (1.37)	—	1200 (47.2")	—	850 (1874)*	□		
1.16 (1.52)	—	1300 (51.2")	—	880 (1940)*	□		
1.26 (1.65)	—	1400 (55.1")	—	950 (1433)*	⊙		
1.37 (1.79)	—	1500 (59.1")	—	1000 (2205)*	⊙		
PC200-8,PC200LC-8,PC200-8M0,PC200LC-8M0,PC200-8*¹³,PC200LC-8*¹³					1.84 (6'0")	2.41 (7'11")	2.93 (9'7")
0.50 (0.65)	0.45 (0.59)	750 (29.5")	875(34.4")	478 (1050)	○	○	○
0.80 (1.05)	0.70 (0.92)	1045 (41.1")	1170(46.1")	635(1400)	○	○	○
0.93 (1.22)	0.80 (1.05)	1200 (47.2")	1325(52.2")	696(1530)	□	□	⊙
1.05 (1.37)	0.90 (1.18)	1330 (52.4")	1455(57.3")	757 (1670)	□	□	✕
1.17 (1.53)	1.00 (1.31)	1450 (57.1")	—	*940 (2070)	⊙	⊙	✕
PC200-8*⁵, PC200LC-8*⁵					1.84 (6'0")	2.41 (7'11")	2.93 (9'7")
0.80 (1.05)	0.70 (0.92)	1045 (41.1")	—	—	○	○	○
0.80 (1.05)**	0.70 (0.92)	1050 (41.3")	—	—	○	○	○
0.90 (1.18)	0.80 (1.05)	1200 (47.2")	—	—	□	□	⊙
1.0 (1.31)**	0.90 (1.18)	1000 (39.4")	—	—	□	□	✕
PC200-8*⁷					1.84 (6'0")	2.41 (7'11")	2.93 (9'7")
0.80 (1.05)	—	913 (35.9")	958 (37.7")	842 (1856)	○	○	○
1.0 (1.31)	—	1071 (42.2")	1117 (44.0")	913 (2013)	○	○	□
1.2 (1.57)	—	1228 (48.3")	1274 (50.2")	942 (2077)	○	□	✕
1.5 (1.96)	—	1350 (53.1")	1900 (74.8")	1100 (2425)	✕	✕	✕
PC200LC-8*⁷					2.41 (7'11")		
0.80 (1.05)	—	913 (35.9")	958 (37.7")	842 (1856)	○		
1.0 (1.31)	—	1071 (42.2")	1117 (44.0")	913 (2013)	○		
1.2 (1.57)	—	1228 (48.3")	1274 (50.2")	942 (2077)	○		
1.5 (1.96)	—	1350 (53.1")	1900 (74.8")	1100 (2425)	○		
PC200-7					1.84 (6'0")	2.41 (7'11")	2.93 (9'7")
0.50 (0.65)	0.45 (0.59)	750 (29.5")	855 (33.7")	478 (1050)	○	○	○
0.80 (1.05)	0.70 (0.92)	1045 (41.1")	1150 (45.3")	645 (1420)	○	○	○
0.93 (1.22)	0.80 (1.05)	1200 (47.2")	1305 (51.4")	696 (1530)	□	□	⊙
1.05 (1.37)	0.90 (1.18)	1330 (52.4")	1435 (56.5")	757 (1670)	□	□	✕
1.17 (1.53)	1.00 (1.31)	1450 (57.1")	—	940 (2070)*	⊙	○	✕

- | | | | |
|--------------------------|----------------------|-------------------|----------------------|
| * Without side cutters | *6 Thailand source | *11 India source | *16 Bucket lip width |
| ** Heavy-duty bucket | *7 Brazil source | *12 for USA | *17 for Russia |
| *** Rock (Quarry) bucket | *8 UK source | *13 Russia source | |
| *4 Italy source | *9 USA source | *14 for UK | |
| *5 China source | *10 Indonesia source | | |

Bucket and Arm Combinations

EXCAVATORS (BACKHOE)

These charts are based on over-side stability with fully loaded bucket at maximum reach.

- : General purpose use, weight up to 2.1 t/m³ (3500 lb/cu.yd)
- : General purpose use, weight up to 1.8 t/m³ (3000 lb/cu.yd)
- : General purpose use, weight up to 1.5 t/m³ (2500 lb/cu.yd)
- ⊙ : Light duty work, weight up to 1.2 t/m³ (2000 lb/cu.yd)
- ✕ : Not usable.

Bucket capacity (heaped)		Width		Weight kg (lb) (With side cutters or side shrouds)	Arm length m (ft.in)		
SAE, PCSA m ³ (cu.yd)	CECE m ³ (cu.yd)	Without side cutters or side shrouds mm (in)	With side cutters or side shrouds mm (in)		2.4 (7'10")	2.9 (9'6")	
PC210-10^{*8}					2.4 (7'10")	2.9 (9'6")	
0.43 (0.56)	—	600 (23.6")	—	570 (1257)*	○	○	
0.52 (0.68)	—	700 (27.6")	—	610 (1345)*	○	○	
0.63 (0.82)	—	800 (31.5")	—	650 (1433)*	○	○	
0.73 (0.95)	—	900 (35.4")	—	690 (1521)*	○	○	
0.84 (1.10)	—	1000 (39.4")	—	740 (1631)*	○	○	
0.94 (1.23)	—	1100 (43.3")	—	820 (1808)*	○	○	
1.05 (1.37)	—	1200 (47.2")	—	850 (1874)*	○	○	
1.16 (1.52)	—	1300 (51.2")	—	880 (1940)*	□	□	
1.26 (1.65)	—	1400 (55.1")	—	950 (1433)*	□	⊙	
1.37 (1.79)	—	1500 (59.1")	—	1000 (2205)*	⊙	⊙	
1.49 (1.95)	—	1600 (63.0")	—	1100 (2425)*	⊙	✕	
1.58 (2.07)	—	1700 (66.9")	—	1150 (2535)*	✕	✕	
1.68 (2.20)	—	1800 (70.9")	—	1200 (2645)*	✕	✕	
PC210LC-10^{*8}					2.4 (7'10")	2.9 (9'6")	
0.43 (0.56)	—	600 (23.6")	—	570 (1257)*	○	○	
0.52 (0.68)	—	700 (27.6")	—	610 (1345)*	○	○	
0.63 (0.82)	—	800 (31.5")	—	650 (1433)*	○	○	
0.73 (0.95)	—	900 (35.4")	—	690 (1521)*	○	○	
0.84 (1.10)	—	1000 (39.4")	—	740 (1631)*	○	○	
0.94 (1.23)	—	1100 (43.3")	—	820 (1808)*	○	○	
1.05 (1.37)	—	1200 (47.2")	—	850 (1874)*	○	○	
1.16 (1.52)	—	1300 (51.2")	—	880 (1940)*	○	○	
1.26 (1.65)	—	1400 (55.1")	—	950 (1433)*	○	□	
1.37 (1.79)	—	1500 (59.1")	—	1000 (2205)*	□	□	
1.49 (1.95)	—	1600 (63.0")	—	1100 (2425)*	□	⊙	
1.58 (2.07)	—	1700 (66.9")	—	1150 (2535)*	⊙	⊙	
1.68 (2.20)	—	1800 (70.9")	—	1200 (2645)*	⊙	✕	
PC210NLC-8^{*8}					1.8 (5'11")	2.4 (7'10")	2.9 (9'6")
0.43 (0.56)	—	600 (23.6")	—	570 (1257)*	○	○	○
0.52 (0.68)	—	700 (27.6")	—	610 (1345)*	○	○	○
0.63 (0.82)	—	800 (31.5")	—	650 (1433)*	○	○	○
0.73 (0.95)	—	900 (35.4")	—	690 (1521)*	○	○	○
0.84 (1.10)	—	1000 (39.4")	—	740 (1631)*	○	○	○
0.94 (1.23)	—	1100 (43.3")	—	820 (1808)*	○	○	□
1.05 (1.37)	—	1200 (47.2")	—	850 (1874)*	○	□	□
1.16 (1.52)	—	1300 (51.2")	—	880 (1940)*	□	□	⊙
1.26 (1.65)	—	1400 (55.1")	—	950 (1433)*	□	⊙	✕
1.37 (1.79)	—	1500 (59.1")	—	1000 (2205)*	⊙	⊙	✕
1.49 (1.95)	—	1600 (63.0")	—	1100 (2425)*	⊙	✕	✕
1.58 (2.07)	—	1700 (66.9")	—	1150 (2535)*	✕	✕	✕
1.68 (2.20)	—	1800 (70.9")	—	1200 (2645)*	✕	✕	✕

- * Without side cutters
- ** Heavy-duty bucket
- *** Rock (Quarry) bucket
- *4 Italy source
- *5 China source

- *6 Thailand source
- *7 Brazil source
- *8 UK source
- *9 USA source
- *10 Indonesia source

- *11 India source
- *12 for USA
- *13 Russia source
- *14 for UK

- *16 Bucket lip width
- *17 for Russia

Bucket and Arm Combinations

EXCAVATORS (BACKHOE)

These charts are based on over-side stability with fully loaded bucket at maximum reach.

- : General purpose use, weight up to 2.1 t/m³ (3500 lb/cu.yd)
- : General purpose use, weight up to 1.8 t/m³ (3000 lb/cu.yd)
- : General purpose use, weight up to 1.5 t/m³ (2500 lb/cu.yd)
- ⊙ : Light duty work, weight up to 1.2 t/m³ (2000 lb/cu.yd)
- ✕ : Not usable.

Bucket capacity (heaped)		Width		Weight kg (lb) (With side cutters or side shrouds)	Arm length m (ft.in)		
SAE, PCSA m ³ (cu.yd)	CECE m ³ (cu.yd)	Without side cutters or side shrouds mm (in)	With side cutters or side shrouds mm (in)				
PC210-8*5, PC210LC-8*5					1.84 (6'0")	2.41 (7'11")	2.93 (9'7")
0.80 (1.05)*4	0.70 (0.92)	1050 (41.3")	—	—	○	○	○
0.90 (1.18)	0.80 (1.05)	1200 (47.2")	—	—	□	□	⊙
1.0 (1.31)*4	0.90 (1.18)	1004 (39.5")	—	—	□	□	✕
PC210LC-10*9					2.9 (9'7")		
0.50 (0.65)	—	610 (24")	—	605 (1334)	●		
0.67 (0.88)	—	762 (30")	—	689 (1518)	●		
0.85 (1.11)	—	914 (36")	—	780 (1719)	●		
1.02 (1.34)	—	1067 (42")	—	857 (1890)	○		
1.2 (1.57)	—	1219 (48")	—	949 (2092)	□		
PC210LC-8*11					2.4 (7'10")	2.9 (9'7")	
0.95 (1.24)	—	—	1350 (53.1")	865 (1907)	○		○
1.05 (1.37)	—	—	1330 (52.4")	855 (1885)	○		○
PC220-8, PC220-8M0, PC220-8*13 PC220LC-8, PC220LC-8M0, PC220LC-8*13					2.00 (6'7")	2.50 (8'2")	3.05 (10'0")
0.72 (0.94)	0.65 (0.85)	900 (35.4")	1005 (39.6")	658 (1450)	○	○	○
1.00 (1.31)	0.90 (1.18)	1155 (45.5")	1260 (49.6")	734 (1620)	○	○	○
1.14 (1.49)	1.00 (1.31)	1300 (51.2")	1405 (55.3")	793 (1750)	○	□	□
1.26 (1.65)	1.10 (1.44)	1400 (55.1")	1505 (59.3")	845 (1860)	○	□	⊙
PC220-7, PC220LC-7					2.00 (6'7")	2.50 (8'2")	3.05 (10'0")
0.72 (0.94)	0.65 (0.85)	900 (35.4")	1005 (39.6")	658 (1450)	○	○	○
1.00 (1.31)	0.90 (1.18)	1155 (45.5")	1260 (49.6")	734 (1620)	○	○	○
1.14 (1.49)	1.00 (1.31)	1300 (51.2")	1405 (55.3")	793 (1750)	○	□	□
1.26 (1.65)	1.10 (1.44)	1400 (55.1")	1505 (59.3")	845 (1860)	○	□	⊙
PC228US-8, PC228USLC-8					2.925 (9'7")		
0.50 (0.65)	0.45 (0.59)	750 (29.59")	875 (34.4")	478 (1050)		○	
0.80 (1.05)	0.70 (0.92)	1045 (41.1")	1170 (46.1")	635 (1400)		○	
0.93 (1.22)	0.80 (1.05)	1200 (47.2")	1325 (52.2")	696 (1530)		□	
1.00 (1.31)	0.90 (1.18)	1330 (52.4")	1455 (57.3")	730 (1610)		□	
PC228USLC-8*12					2.9 (9'7")		
0.50 (0.65)	—	610 (24")	—	605 (1334)		●	
0.67 (0.88)	—	762 (30")	—	689 (1518)		●	
0.85 (1.11)	—	914 (36")	—	780 (1719)		●	
1.02 (1.34)	—	1067 (42")	—	857 (1890)		○	
1.2 (1.57)	—	1219 (48")	—	949 (2092)		□	
PC228USLC-8*14					2.4 (7'10")	2.9 (9'7")	
0.48 (0.63)	—	600 (23.6")	—	480 (1058)	○		○
0.55 (0.72)	—	700 (27.6")	—	530 (1168)	○		○
0.63 (0.82)	—	800 (31.5")	—	580 (1279)	○		○
0.71 (0.93)	—	900 (35.4")	—	610 (1345)	○		○
0.78 (1.02)	—	1000 (39.4")	—	650 (1433)	○		○
0.86 (1.15)	—	1100 (43.3")	—	700 (1543)	○		○
0.96 (1.26)	—	1200 (47.2")	—	760 (1675)	○		○
1.03 (1.35)	—	1300 (51.2")	—	810 (1786)	○		○
1.11 (1.45)	—	1400 (55.1")	—	870 (1918)	○		□
1.19 (1.56)	—	1500 (59.1")	—	930 (2050)	□		□
1.49 (1.95)	—	1600 (63.0")	—	1100 (2425)	⊙		✕
1.58 (2.07)	—	1700 (66.9")	—	1150 (2535)	✕		✕
1.68 (2.20)	—	1800 (70.9")	—	1200 (2645)	✕		✕

- * Without side cutters
- ** Heavy-duty bucket
- *** Rock (Quarry) bucket
- *4 Italy source
- *5 China source

- *6 Thailand source
- *7 Brazil source
- *8 UK source
- *9 USA source
- *10 Indonesia source

- *11 India source
- *12 for USA
- *13 Russia source
- *14 for UK

- *16 Bucket lip width
- *17 for Russia

Bucket and Arm Combinations

EXCAVATORS (BACKHOE)

These charts are based on over-side stability with fully loaded bucket at maximum reach.

- : General purpose use, weight up to 2.1 t/m³ (3500 lb/cu.yd)
- : General purpose use, weight up to 1.8 t/m³ (3000 lb/cu.yd)
- : General purpose use, weight up to 1.5 t/m³ (2500 lb/cu.yd)
- ⊙ : Light duty work, weight up to 1.2 t/m³ (2000 lb/cu.yd)
- × : Not usable.

Bucket capacity (heaped)		Width		Weight kg (lb) (With side cutters or side shrouds)	Arm length m (ft.in)		
SAE, PCSA m ³ (cu.yd)	CECE m ³ (cu.yd)	Without side cutters or side shrouds mm (in)	With side cutters or side shrouds mm (in)				
PC230NHD-8					1.8 (5'11")	2.4 (7'10")	2.9 (9'6")
0.43 (0.56)	—	600 (23.6")	—	570 (1257)*	○	○	○
0.525 (0.69)	—	700 (27.6")	—	605 (1334)*	○	○	○
0.63 (0.82)	—	800 (31.5")	—	650 (1433)*	○	○	○
0.73 (0.95)	—	900 (35.4")	—	690 (1521)*	○	○	○
0.84 (1.10)	—	1000 (39.4")	—	740 (1631)*	○	○	○
0.94 (1.23)	—	1100 (43.3")	—	820 (1808)*	○	○	□
1.05 (1.37)	—	1200 (47.2")	—	850 (1874)*	○	□	□
1.16 (1.52)	—	1300 (51.2")	—	880 (1940)*	○	□	⊙
1.26 (1.65)	—	1400 (55.1")	—	950 (2094)*	□	⊙	⊙
1.37 (1.79)	—	1500 (59.1")	—	1000 (2205)*	⊙	⊙	×
1.49 (1.95)	—	1600 (63.0")	—	1100 (2425)*	⊙	×	×
1.58 (2.07)	—	1700 (66.9")	—	1150 (2535)*	⊙	×	×
PC240LC-10*9					3.05 (10')	3.5 (11'6")	
0.58 (0.76)	—	610 (24")	—	687 (1514)	●	●	
0.78 (1.02)	—	762 (30")	—	807 (1779)	●	●	
0.99 (1.29)	—	914 (36")	—	907 (2000)	●	●	
1.20 (1.57)	—	1067 (42")	—	949 (2178)	○	○	
1.41 (1.85)	—	1219 (48")	—	1045 (2399)	□	□	
PC240LC-10*8, PC240NLC-10*8					2.0 (6'7")	2.5 (8'2")	3.0 (9'10") 3.5 (11'6")
0.47 (0.61)	—	600 (23.6")	—	670 (1480)*	○	○	○ ○
0.70 (0.92)	—	800 (31.5")	—	750 (1650)*	○	○	○ ○
0.93 (1.22)	—	1000 (39.4")	—	840 (1850)*	○	○	○ ○
1.17 (1.53)	—	1200 (47.2")	—	960 (2120)*	○	○	○ ○ (NLC: □)
1.41 (1.53)	—	1400 (55.1")	—	1050 (2310)*	○	○ (NLC: □)	○ (NLC: ⊙)
1.53 (2.00)	—	1500 (59.1")	—	1120 (2470)*	○ (NLC: □)	○ (NLC: □)	□ (NLC: ⊙) (NLC: ⊙)
1.65 (2.17)	—	1600 (63.0")	—	1170 (2580)*	○ (NLC: □)	○ (NLC: ⊙)	⊙ (NLC: ⊙) (NLC: ×)
1.79 (2.34)	—	1800 (70.9")	—	1250 (2760)*	□ (NLC: ×)	□ (NLC: ⊙)	⊙ (NLC: ×) (NLC: ×)
1.89 (2.47)	—	2000 (78.7")	—	1300 (2870)*	□ (NLC: ⊙)	⊙	⊙ (NLC: ×) ×
PC240LC-8*5					3.05 (10')		
1.00 (1.31)	0.90 (1.18)	1150 (45.3")	—	—	○		
1.00 (1.31)*4	0.90 (1.18)	1155 (45.5")	—	—	○		
1.20 (1.57)*4	—	1140 (44.9")	—	—	□		
PC270-8, PC270LC-8					2.5 (8'2")	3.0 (10'0")	3.5 (11'6")
1.14 (1.49)	1.00 (1.31)	1300 (51.2")	1405 (55.3")	793 (1750)	○	○	○
1.26 (1.65)	1.10 (1.44)	1400 (55.1")	1505 (59.3")	845 (1860)	○	○	○
PC270-7*5					3.05 (10'0")		
1.3 (1.70)	—	1420 (55.9")	1540 (60.6")	1140 (2513)	○		
1.3 (1.70)*4	—	1435 (56.5")	1500 (59.0")	1375 (3031)	○		

- * Without side cutters
- *6 Thailand source
- *11 India source
- *16 Bucket lip width
- ** Heavy-duty bucket
- *7 Brazil source
- *12 for USA
- *17 for Russia
- *** Rock (Quarry) bucket
- *8 UK source
- *13 Russia source
- *4 Italy source
- *9 USA source
- *14 for UK
- *5 China source
- *10 Indonesia source

Bucket and Arm Combinations

EXCAVATORS (BACKHOE)

These charts are based on over-side stability with fully loaded bucket at maximum reach. ● : General purpose use, weight up to 2.1 t/m ³ (3500 lb/cu.yd) ○ : General purpose use, weight up to 1.8 t/m ³ (3000 lb/cu.yd) □ : General purpose use, weight up to 1.5 t/m ³ (2500 lb/cu.yd) ⊙ : Light duty work, weight up to 1.2 t/m ³ (2000 lb/cu.yd) ✕ : Not usable.								
Bucket capacity (heaped)		Width		Weight kg (lb) (With side cutters or side shrouds)	Arm length m (ft.in)			
SAE, PCSA m ³ (cu.yd)	CECE m ³ (cu.yd)	Without side cutters or side shrouds mm (in)	With side cutters or side shrouds mm (in)					
PC290LC-10^{*9}					3.2 (10'6")		3.5 (11'6")	
0.58 (0.76)	—	—	610 (24")	687 (1514)	●	●		
0.78 (1.02)	—	—	762 (30")	807 (1779)	●	●		
0.99 (1.29)	—	—	914 (36")	907 (2000)	●	●		
1.20 (1.57)	—	—	1067 (42")	949 (2178)	●	●		
1.41 (1.85)	—	—	1219 (48")	1045 (2399)	○	○		
1.63 (2.13)	—	—	1372 (54")	1168 (2576)	○	□		
PC290LC-10^{*8}, PC290NLC-10^{*8}					2.0 (6'7")	2.65 (8'8")	3.2 (10'6")	3.5 (11'6")
0.85 (1.11)	—	800 (31.5")	—	890 (1960)*	○	○	○	○
1.13 (1.48)	—	1000 (39.4")	—	1010 (2230)*	○	○	○	○
1.42 (1.86)	—	1200 (47.2")	—	1160 (2560)*	○	○	(NLC: □)	(NLC: □)
1.74 (2.28)	—	1400 (55.1")	—	1290 (2840)*	(NLC: □)	□	(NLC: ⊙)	⊙
1.87 (2.45)	—	1500 (59.1")	—	1350 (2980)*	(NLC: □)	(NLC: ⊙)	⊙	(NLC: ✕)
2.02 (2.64)	—	1600 (63.0")	—	1400 (3090)*	(NLC: ⊙)	⊙	(NLC: ✕)	(NLC: ✕)
PC300-8, PC300LC-8, PC300-8^{*13}, PC300LC-8^{*13}					2.2 (7'3")	2.55 (8'4")	3.185 (10'5")	4.02 (13'2")
0.52 (0.68)	0.48 (0.63)	610 (24")	740 (29.1")	664 (1460)	○	○	○	○
1.14 (1.49)	1.00 (1.31)	1145 (45.1")	1275 (50.2")	900 (1980)	○	○	○	○
1.40 (1.83)	1.20 (1.57)	1340 (52.8")	1445 (56.9")	1015 (2240)	○	○	○	⊙
1.40 (1.83)**	1.20 (1.57)	1458 (54.7")	—	1508 (3320)	○	○	○	✕
1.60 (2.09)	1.40 (1.83)	1515 (59.6")	1645 (64.8")	1102 (2430)	□	□	□	✕
1.80 (2.35)	1.60 (2.09)	1700 (66.9")	—	1115 (2460)	⊙	⊙	⊙	✕
PC300-7, PC300LC-7					2.2 (7'3")	2.55 (8'4")	3.185 (10'5")	4.02 (13'2")
0.52 (0.68)	0.48 (0.63)	610 (24")	740 (29.1")	664 (1460)	○	○	○	○
1.14 (1.49)	1.00 (1.31)	1145 (45.1")	1275 (50.2")	900 (1980)	○	○	○	○
1.40 (1.83)	1.20 (1.57)	1340 (52.8")	1445 (56.9")	1015 (2240)	○	○	○	⊙
1.40 (1.83)**	1.20 (1.57)	1458 (54.7")	—	1508 (3320)	○	○	○	✕
1.60 (2.09)	1.40 (1.83)	1515 (59.6")	1645 (64.8")	1102 (2430)	□	□	□	✕
1.80 (2.35)	1.60 (2.09)	1700 (66.9")	—	1115 (2460)	⊙	⊙	⊙	✕
PC300/PC300LC-8(SE spec)^{*6}, PC300/300LC-8(SE spec)^{*10}					2.22 (7'3")	2.55 (8'4")	3.185 (10'5")	
0.52 (0.68)	0.48 (0.63)	610 (24")	740 (29.1")	664 (1460)	○	○	○	
1.14 (1.49)	1.00 (1.31)	1145 (45.1")	1275 (50.2")	900 (1980)	○	○	○	
1.40 (1.83)	1.20 (1.57)	1340 (52.8")	1445 (56.9")	1015 (2240)	○	○	○	
1.60 (2.09)	1.40 (1.83)	1515 (59.6")	1645 (64.8")	1102 (2430)	□	□	□	
1.80 (2.35)	1.60 (2.09)	1700 (66.9")	—	1115 (2460)*	⊙	⊙	⊙	
1.40 (1.83)**	1.20 (1.57)	1458 (54.7")	—	1508 (3320)	○	○	○	
2.30 (3.01)	2.14 (2.80)	1615 (63.6)	—	1961 (3320)	○	⊙	✕	
PC300LC-7^{*11}					2.22 (7'3")		3.1 (10'5")	
1.40 (1.83)**	1.20 (1.57)	1458 (54.7")	—	1508 (3,320)	○	Granite		
1.60 (2.09)	1.38 (1.81)	1515 (59.6")	1640 (64.6")	1500 (3,000)	Iron Ore		○	
2.10 (2.74)	1.90 (2.48)	1565 (61.6")	1685 (66.3")	1725 (3,802)	□	✕		

- | | | | |
|--------------------------|----------------------|-------------------|----------------------|
| * Without side cutters | *6 Thailand source | *11 India source | *16 Bucket lip width |
| ** Heavy-duty bucket | *7 Brazil source | *12 for USA | *17 for Russia |
| *** Rock (Quarry) bucket | *8 UK source | *13 Russia source | |
| *4 Italy source | *9 USA source | *14 for UK | |
| *5 China source | *10 Indonesia source | | |

Bucket and Arm Combinations

EXCAVATORS (BACKHOE)

These charts are based on over-side stability with fully loaded bucket at maximum reach.									
<ul style="list-style-type: none"> ● : General purpose use, weight up to 2.1 t/m³ (3500 lb/cu.yd) ○ : General purpose use, weight up to 1.8 t/m³ (3000 lb/cu.yd) □ : General purpose use, weight up to 1.5 t/m³ (2500 lb/cu.yd) ⊙ : Light duty work, weight up to 1.2 t/m³ (2000 lb/cu.yd) × : Not usable. 									
Bucket capacity (heaped)		Width		Weight kg (lb) (With side cutters or side shrouds)	Arm length m (ft.in)				
SAE, PCSA m ³ (cu.yd)	CECE m ³ (cu.yd)	Without side cutters or side shrouds mm (in)	With side cutters or side shrouds mm (in)						
PC350-7, PC300LC-7, PC300-8, PC300LC-8					3.185 (10'5")		—		
1.40 (1.83)* ⁶	1.20 (1.57)	1458 (54.7")	—	1508 (3320)	○		—		
PC350LC-8*⁷					2.2 (7'3")	2.54 (8'4")	3.185 (10'5")	4.02 (13'2")	
0.93 (1.22)	—	—	762 (30")	1097 (2418)	○	○	○	○	
1.18 (1.54)	—	—	914 (36")	1198 (2641)	○	○	○	○	
1.44 (1.88)	—	—	1067 (42")	1325 (2921)	○	○	○	○	
1.70 (2.22)	—	—	1219 (48")	1426 (3144)	○	○	○	○	
1.96 (2.56)	—	—	1372 (54")	1554 (3426)	○	○	○	○	
PC360LC-10*⁹					2.6 (8'4")	3.2 (10'6")	4.0 (13'2")		
0.93 (1.22)	—	—	762 (30")	1097 (2418)	●	●	●		
1.18 (1.54)	—	—	914 (36")	1198 (2641)	●	●	●		
1.44 (1.88)	—	—	1067 (42")	1325 (2921)	●	●	●		
1.70 (2.22)	—	—	1219 (48")	1426 (3144)	●	●	○		
1.96 (2.56)	—	—	1372 (54")	1554 (3426)	○	○	○		
PC360LC-10*⁸, PC360NLC-10*⁸					2.2 (7'3")	2.6 (8'6")	3.2 (10'6")	4.0 (13'1")	
0.85 (1.11)	—	800 (31.5")	—	880 (1940)	○	○	○	○	
1.13 (1.48)	—	1000 (39.4")	—	1010 (2230)	○	○	○	□	
1.42 (1.86)	—	1200 (47.2")	—	1160 (2560)	○	○	○	□	
1.75 (2.29)	—	1400 (55.1")	—	1290 (2840)	○	○	○	□	
1.87 (2.45)	—	1500 (59.1")	—	1350 (2980)	○	○	○ (NLC: □)	□ (NLC: ○)	
2.02 (2.64)	—	1600 (63.0")	—	1400 (3090)	○	○ (NLC: □)	□	○	
2.32 (3.03)	—	1800 (70.9")	—	1520 (3350)	○ (NLC: □)	□	○	×	
PC360-7*⁸					2.2 (7'3")	2.55 (8'4")	3.185 (10'6")	4.02 (13'2")	
1.6 (2.09)	1.40 (1.83)	1515 (59.6")	1633 (64.3")	1615 (3560)	○	○	○	×	
PC390LC-10*⁹					2.6 (8'6")	3.2 (10'6")	4.0 (13'1")		
0.93 (1.22)	—	—	762 (30")	1097 (2418)	●	●	●		
1.18 (1.54)	—	—	914 (36")	1198 (2641)	●	●	●		
1.44 (1.88)	—	—	1067 (42")	1325 (2921)	●	●	●		
1.70 (2.22)	—	—	1219 (48")	1426 (3144)	●	●	○		
1.96 (2.56)	—	—	1372 (54")	1554 (3426)	○	○	□		
2.22 (2.91)	—	—	1524 (60")	1554 (3426)	□	□	○		
PC400-8, PC400-8R, PC400LC-8, PC400LC-8R PC400-7, PC400-7*¹³, PC400LC-7, PC400LC-7*¹³					2.4 (7'10")	2.9 (9'6")	3.38 (11'1")	4.0 (13'1")	
1.30 (1.70)	1.20 (1.57)	1120 (44.1")	1270 (50")	1115 (2458)	○	○	○	○	
1.60 (2.09)	1.40 (1.83)	1270 (50")	1420 (55.9")	1197 (2639)	○	○	○	○	
1.90 (2.49)	1.70 (2.22)	1475 (58.1")	1625 (64")	1358 (2873)	○	○	○	□	
1.90 (2.49)**	1.70 (2.22)	—	1625 (64")	1966 (3757)	○	○	○	×	
2.06 (2.69)	1.80 (2.35)	1565 (61.6")	1715 (67.5")	1391 (3067)	□	□	□	○	
2.10 (2.75)**	1.90 (2.49)	—	1745 (68.7")	2035 (4490)	○	○	○	×	
2.20 (2.88)	2.00 (2.62)	1715 (67.5")	—	1396 (3757)	○	○	○	×	
PC400-8*⁵					3.38 (11'1")		—		
1.90 (2.49)**	—	1630 (64.2")	—	—	○		—		
PC450-8*⁵					3.38 (11'1")		—		
2.1 (2.75)**	—	—	1752 (59")	—	○		—		
PC450-8, PC450-8R, PC450LC-8, PC450LC-8R, PC450-7					3.38 (11'1")		—		
1.90 (2.49)**	1.70 (2.22)	—	1625 (64.0")* ⁷	1966 (4330)	○		—		
2.10 (2.75)**	1.90 (2.49)	—	2035 (68.7")* ⁷	2035 (4490)	○		—		

* Without side cutters	* ⁶ Thailand source	* ¹¹ India source	* ¹⁶ Bucket lip width
** Heavy-duty bucket	* ⁷ Brazil source	* ¹² for USA	* ¹⁷ for Russia
*** Rock (Quarry) bucket	* ⁸ UK source	* ¹³ Russia source	
* ⁴ Italy source	* ⁹ USA source	* ¹⁴ for UK	
* ⁵ China source	* ¹⁰ Indonesia source		

Bucket and Arm Combinations

EXCAVATORS (BACKHOE)

These charts are based on over-side stability with fully loaded bucket at maximum reach.

- : General purpose use, weight up to 2.1 t/m³ (3500 lb/cu.yd)
- : General purpose use, weight up to 1.8 t/m³ (3000 lb/cu.yd)
- : General purpose use, weight up to 1.5 t/m³ (2500 lb/cu.yd)
- ⊙ : Light duty work, weight up to 1.2 t/m³ (2000 lb/cu.yd)
- × : Not usable.

Bucket capacity (heaped)		Width		Weight kg (lb) (With side cutters or side shrouds)	Arm length m (ft.in)				
SAE, PCSA m ³ (cu.yd)	CECE m ³ (cu.yd)	Without side cutters or side shrouds mm (in)	With side cutters or side shrouds mm (in)		2.4 (7'10")	2.9 (9'6")	3.4 (11'2")	4.0 (13'1")	4.8 (15'9")
PC490-10*8, PC490LC-10*8					2.4 (7'10")	2.9 (9'6")	3.4 (11'2")	4.0 (13'1")	4.8 (15'9")
1.34 (1.75)	—	1000 (39.4")	—	1450 (3197)*	○	○	○	○	○
1.69 (2.4)	—	1200 (47.2")	—	1650 (3638)*	○	○	○	○	○
2.20 (2.88)	—	1500 (59.0")	—	1940 (4277)*	○	○	○	○	○
2.40 (3.14)	—	1600 (63.0")	—	2040 (4497)*	○	○	○	○	□ (LC:○)
2.76 (3.61)	—	1800 (70.9")	—	2180 (4806)*	×	×	×	×	×
PC490LC-10*9					2.4 (7'10")	2.9 (9'6")	3.4 (11'2")	4.0 (13'1")	4.8 (15'9")
1.12 (1.47)	—	—	762 (30")	1287 (2838)	●	●	●	●	●
1.35 (1.76)	—	—	914 (36")	1441 (3176)	●	●	●	●	●
1.64 (2.15)	—	—	1067 (42")	1561 (3442)	●	●	●	●	●
1.94 (2.54)	—	—	1219 (48")	1714 (3779)	●	●	●	●	○
2.25 (2.94)	—	—	1372 (54")	1867 (4117)	●	●	●	○	□
2.55 (3.34)	—	—	1524 (60")	1988 (4382)	●	○	○	□	⊙
2.87 (3.75)	—	—	1676 (66")	2141 (4720)	○	□	□	⊙	×
3.17 (4.15)	—	—	1829 (72")	2261 (4985)	□	□	○	⊙	×
PC550LC-8					2.4 (7'10")		3.38 (11'1")		
3.05 (4.58)	2.6 (3.40)	—	1700 (66.9")	2035 (4486)	○		○		
PC600-8E0, PC600LC-8E0, PC600-8R1, PC600LC-8R1					6.6 (21'9")	7.3 (23'11")	7.66 (25'2")		
					2.9 (9'6")	3.5 (11'6")	3.5 (11'6")	4.3 (14'1")	5.2 (17'1")
2.0 (2.62)	1.8 (2.35)	1250 (49.2")	1430 (56.3")	2130 (4700)	—	—	○	○	○
2.3 (3.01)	2.1 (2.75)	1400 (55.1")	1580 (62.2")	2260 (4980)	—	—	○	□	×
2.7 (3.53)	2.4 (3.14)	1600 (63.0")	1780 (70.1")	2430 (5360)	—	—	○	×	×
2.8 (3.66)	2.5 (3.27)	1920 (75.6")	1920 (75.6")	3100 (6830)	—	—	—	—	—
3.1 (4.05)	2.8 (3.66)	2040 (80.3")	2000 (78.7")	3210 (7080)	×	○*9	×	×	×
3.5 (4.58)	3.1 (4.05)	2110 (83.1")	2110 (83.1")	3280 (7230)	○	—	—	—	—
PPC600-7*17, PC600LC-7*17					6.6 (21'9")	7.3 (23'11")	7.66 (25'2")		
					2.9 (9'6")	3.5 (11'6")	3.5 (11'6")	4.3 (14'1")	5.2 (17'1")
2.0 (2.62)	1.8 (2.35)	1250 (49.2")	1430 (56.3")	2200 (4850)	—	—	○	○	○
2.3 (3.01)	2.1 (2.75)	1400 (55.1")	1580 (62.2")	2382 (5250)	—	—	○	□	×
2.7 (3.53)	2.4 (3.14)	1600 (63.0")	1780 (70.1")	2505 (5520)	—	—	○	×	×
2.8 (3.66)	2.5 (3.27)	1870 (73.6")	1870 (73.6")	2981 (6570)	—	○	—	—	—
3.1 (4.05)	2.8 (3.66)	2000 (78.7")	2000 (78.7")	3100 (6830)	×	○*9	×	×	×
3.5 (4.58)	3.1 (4.05)	2120 (83.5")	2120 (83.5")	3406 (7510)	○	—	—	—	—
PC600-8*8					6.6 (21'9")		7.3 (23'11")		
					2.9 (9'6")		3.5 (11'6")		
2.4 (3.14)	2.1 (2.75)	1320 (52.0")	1400 (55.1")	2410 (5310)	○		○		
2.7 (3.53)	2.4 (3.14)	1600 (63.0")	1680 (66.1")	2795 (6160)	○		□		
2.8 (3.66)	2.5 (3.27)	1655 (65.2")	1705 (67.1")	2795 (6162)	○		□		
3.5 (4.58)	3.1 (4.05)	1850 (72.8")	1900 (74.8")	3325 (7330)	○		⊙		

- | | | | |
|--------------------------|----------------------|-------------------|----------------------|
| * Without side cutters | *6 Thailand source | *11 India source | *16 Bucket lip width |
| ** Heavy-duty bucket | *7 Brazil source | *12 for USA | *17 for Russia |
| *** Rock (Quarry) bucket | *8 UK source | *13 Russia source | |
| *4 Italy source | *9 USA source | *14 for UK | |
| *5 China source | *10 Indonesia source | | |

Bucket and Arm Combinations

EXCAVATORS (BACKHOE)

These charts are based on over-side stability with fully loaded bucket at maximum reach.

● : General purpose use, weight up to 2.1 t/m³ (3500 lb/cu.yd)
○ : General purpose use, weight up to 1.8 t/m³ (3000 lb/cu.yd)
□ : General purpose use, weight up to 1.5 t/m³ (2500 lb/cu.yd)
⊙ : Light duty work, weight up to 1.2 t/m³ (2000 lb/cu.yd)
× : Not usable.

Bucket capacity (heaped)		Width		Weight kg (lb) (With side cutters or side shrouds)	Arm length m (ft.in)				
SAE, PCSA m ³ (cu.yd)	CECE m ³ (cu.yd)	Without side cutters or side shrouds mm (in)	With side cutters or side shrouds mm (in)		6.6 (21'9")	7.3 (23'11")	7.6 (24'11")		
PC600LC-8*8					2.9 (9'6")	3.5 (11'6")	3.5 (11'6")		
2.4 (3.14)	2.1 (2.75)	1320 (52.0")	1400 (55.1")	2410 (5310)	○	○	○		
2.7 (3.53)	2.4 (3.14)	1600 (63.0")	1680 (66.1")	2795 (6160)	○	□	□		
2.8 (3.66)	2.5 (3.27)	1655 (65.2")	1705 (67.1")	2795 (6162)	○	□	□		
3.5 (4.58)	3.1 (4.05)	1850 (72.8")	1900 (74.8")	3325 (7330)	○	⊙	⊙		
PC650LC-8*12					3.5 (11'6")	4.3 (14'1")	5.2 (17'1")		
1.57 (2.05)	—	—	914 (36")	2230 (4916)	●	●	●		
1.93 (2.52)	—	—	1067 (42")	2395 (5280)	●	●	□		
2.29 (3.00)	—	—	1219 (48")	2631 (5800)	●	○	⊙		
2.67 (3.49)	—	—	1372 (54")	2797 (6167)	○	□	×		
3.04 (3.98)	—	—	1524 (60")	3034 (6688)	□	⊙	×		
3.42 (4.48)	—	—	1676 (66")	3197 (7048)	⊙	×	×		
3.81 (4.98)	—	—	1829 (72")	3433 (7568)	⊙	×	×		
PC650LC-8R*5					3.5 (11'6")				
3.1 (4.05)			2040 (80.3")		○				
					6.6 (21'8")	7.3 (23'11")	7.66 (25'2")		
					2.9 (9'6")	3.5 (11'6")	3.5 (11'6")	4.3 (14'1")	5.2 (17'1")
PC700LC-8E0, PC700LC-8R					—	—	○	○	○
2.0 (2.62)	1.8 (2.35)	1430 (56.3")	1250 (49.2")	2130 (4700)	—	—	○	○	○
2.3 (3.01)	2.1 (2.75)	1580 (62.2")	1400 (55.1")	2260 (4980)	—	—	○	□	×
2.7 (3.53)	2.4 (3.14)	1780 (70.1")	1600 (63.0")	2475 (5460)	—	—	○	×	×
2.8 (3.66)	2.5 (3.27)	1920 (75.6")*16	1920 (75.6")*16	2430 (5360)	—	○	—	—	—
3.1 (4.05)	2.8 (3.66)	2040 (80.3")*16	2040 (80.3")*16	3210 (7080)	—	○	×	×	×
3.5 (4.58)	3.1 (4.05)	2110 (83.1")*16	2110 (83.1")*16	3335 (7350)	○	—	—	—	—
4.0 (5.23)	3.5 (4.58)	2110 (83.1")*16	2110 (83.1")*16	3440 (7580)	○	—	—	—	—
PC700LC-8E0*8					2.9 (9'6")	3.5 (11'6")	3.5 (11'6")	4.3 (14'1")	5.2 (17'1")
2.4 (3.14)	2.1 (2.75)	1320 (52.0")	1400 (55.1")	2410 (5310)	○	○	○	○	○
2.7 (3.53)	2.4 (3.14)	1600 (63.0")	1680 (66.1")	2795 (6160)	○	○	○	⊙	⊙
2.8 (3.66)	2.5 (3.27)	1655 (65.2")	1705 (67.1")	2795 (6162)	○	○	○	⊙	⊙
3.5 (4.58)	3.1 (4.05)	1850 (72.8")	1900 (74.8")	3325 (7330)	○	□	□	×	×
PC700LC-8E0*5					2.9 (9'6")				
4.0 (5.23)	3.5 (4.58)	2110 (83.1")*16	2110 (83.1")*16	3440 (7580)	○				
PC750-7*17, PC800-8E0, PC800-8R1					3.6 (11'10")	4.6 (15'1")	5.6 (18'4")		
2.8 (3.66)	2.5 (3.27)	1550 (51.0")	1725 (67.9")	2740 (6040)	○	○	○	○	○
3.1 (4.05)	2.8 (3.66)	1700 (66.9")	1875 (73.8")	2940 (6480)	○	□	□	□	□
3.4 (4.45)	3.0 (3.92)	1820 (71.7")	1870 (73.6")	3500 (7720)	□	×	×	×	×
PC750-7*17, PC800-8E0, PC800-8R1 (SE spec)					2.9 (9'8")				
4.0 (5.23)	3.5 (4.58)	2000 (78.7")	2100 (82.8")	3440 (7580)	○				
4.3 (5.62)	3.8 (4.97)	2150 (84.6")	2250 (88.7")	3840 (8470)	□				
4.5 (5.89)	4.0 (5.23)	2230 (87.8")	2330 (91.7")	4050 (8930)	□				

- | | | | |
|--------------------------|----------------------|-------------------|----------------------|
| * Without side cutters | *6 Thailand source | *11 India source | *16 Bucket lip width |
| ** Heavy-duty bucket | *7 Brazil source | *12 for USA | *17 for Russia |
| *** Rock (Quarry) bucket | *8 UK source | *13 Russia source | |
| *4 Italy source | *9 USA source | *14 for UK | |
| *5 China source | *10 Indonesia source | | |

Bucket and Arm Combinations

EXCAVATORS (BACKHOE)

These charts are based on over-side stability with fully loaded bucket at maximum reach.								
<ul style="list-style-type: none"> ● : General purpose use, weight up to 2.1 t/m³ (3500 lb/cu.yd) ○ : General purpose use, weight up to 1.8 t/m³ (3000 lb/cu.yd) □ : General purpose use, weight up to 1.5 t/m³ (2500 lb/cu.yd) ⊙ : Light duty work, weight up to 1.2 t/m³ (2000 lb/cu.yd) × : Not usable. 								
Bucket capacity (heaped)		Width		Weight kg (lb) (With side cutters or side shrouds)	Arm length m (ft.in)			
SAE, PCSA m ³ (cu.yd)	CECE m ³ (cu.yd)	Without side cutters or side shrouds mm (in)	With side cutters or side shrouds mm (in)					
PC800-8E0*8, PC800LC-8*8					7.1 (23'4")		8.0 (26'3")	
					2.9 (9'8")		3.6 (11'10")	
3.6 (4.71)	—	—	1750 (68.9")	3575 (7880)	○	○		
4.0 (5.23)	—	—	1950 (76.8")	3700 (8160)	○	□		
4.4 (5.75)	—	—	2140 (84.3")	3800 (8380)	○	⊙ (LC: □)		
5.1 (6.67)	—	—	2480 (97.6")	3925 (8650)	□	⊙		
5.6 (7.32)	—	—	2730 (107.5")	4025 (8870)	⊙ (LC: □)	× (LC: ⊙)		
6.0 (7.85)	—	—	2920 (115.4")	4100 (9040)	⊙	×		
PC800LC-8E0, PC800LC-8R1					3.6 (11'10")	4.6 (15'1")	5.6 (18'4")	
2.9 (3.79)					○			
3.1 (4.05)	2.8 (3.66)	1700 (66.9")	1875 (73.8")	2940 (6480)	○			
3.7 (4.84)								
PC800LC-8*12					8.2 (26'11")		7.1 (23'4")	
					3.6 (11'10")	4.6 (15'1")	5.6 (18'4")	2.945 (9'8")
1.70 (2.23)	—	—	914 (36")	2544 (5609)	●	●	●	●
2.09 (2.73)	—	—	1067 (42")	2732 (6023)	●	●	○	●
2.48 (3.25)	—	—	1219 (48")	2998 (6610)	●	●	□	●
2.89 (3.78)	—	—	1372 (54")	3190 (7032)	●	●	⊙	●
3.29 (4.31)	—	—	1524 (60")	3456 (7619)	●	○	×	●
3.71 (4.85)	—	—	1676 (66")	3652 (8052)	○	□	×	●
4.12 (5.39)	—	—	1829 (72")	3919 (8639)	□	⊙	×	●
4.53 (5.93)	—	—	1981 (78")	4115 (9072)	⊙	×	×	○
PC800-7*17, PC850-8E0, PC850-8R1					3.6 (11'10")			
3.4 (4.45)	3.0 (3.92)	1820 (71.7")	1870 (73.6")	3500 (7720)	○			
PC800-7*17, PC850-8E0, PC850-8R1 (SE spec)					2.945 (9'8")	3.6 (11'10")		
4.0 (5.23)*9	3.5 (4.58)	2000 (78.7")	2105 (82.9")	4000 (8820)	○	○		
4.0 (5.23)	3.5 (4.58)	2000 (78.7")	2105 (82.9")	3435 (7570)	○	×		
4.3 (5.62)	3.8 (4.97)	2150 (84.6")	2255 (88.8")	3870 (8530)	○	×		
4.5 (5.89)	4.0 (5.23)	2230 (87.8")	2330 (91.9")	4050 (8930)	□	×		
PC1250-7, PC1250-8, PC1250-8R					3.4 (11'2")	4.5 (14'9")	5.7 (18'8")	
3.4 (4.4)	3.0 (3.9)	1500 (59.1")	1670 (65.7")	3600 (7940)	—	●	○	
4.0 (5.2)	3.5 (4.6)	1710 (67.3")	1880 (74")	3800 (8380)	●	○	□	
5.0 (6.5)	4.3 (5.6)	2050 (80.7")	2220 (87.4")	4400 (9700)	○	□	—	
5.2 (6.8)	4.5 (5.9)	2050 (80.7")	2110 (83.1")	5100 (11240)	○	—	—	
PC1250-7, PC1250-8, PC1250-8R (SP spec)					3.4 (11'2")			
6.7 (8.8)	5.9 (7.7)	2280 (89.8")	2340 (92.1")	6000 (13230)	○			
PC1250-8R*10					3.4 (11'2")			
6.7 (8.8)	5.9 (7.7)	2280 (89.8")	2340 (92.1")	6300 (13890)	○			
PC2000-8					8.7 + 3.9 (28'7" + 12'10")			
12.0 (15.7)*	11.0 (14.4)	2600 (102")	2670 (105")	12400 (27340)	○			
12.0 (15.7)	11.0 (14.4)	2600 (102")	2670 (105")	9700 (21380)	○			
13.7 (17.9)*	12.0 (15.7)	2720 (107")	2790 (110")	12500 (27560)	□			
13.7 (17.9)	12.0 (15.7)	2720 (107")	2790 (110")	10500 (23150)	□			

- | | | | |
|--------------------------|----------------------|-------------------|----------------------|
| * Without side cutters | *6 Thailand source | *11 India source | *16 Bucket lip width |
| ** Heavy-duty bucket | *7 Brazil source | *12 for USA | *17 for Russia |
| *** Rock (Quarry) bucket | *8 UK source | *13 Russia source | |
| *4 Italy source | *9 USA source | *14 for UK | |
| *5 China source | *10 Indonesia source | | |

Bucket and Arm Combinations

EXCAVATORS (BACKHOE)

These charts are based on over-side stability with fully loaded bucket at maximum reach.

- : General purpose use, weight up to 2.1 t/m³ (3500 lb/cu.yd)
- : General purpose use, weight up to 1.8 t/m³ (3000 lb/cu.yd)
- : General purpose use, weight up to 1.5 t/m³ (2500 lb/cu.yd)
- ⊙ : Light duty work, weight up to 1.2 t/m³ (2000 lb/cu.yd)
- ✕ : Not usable.

Bucket capacity (heaped)		Width		Weight kg (lb) (With side cutters or side shrouds)	Arm length m (ft.in)
SAE, PCSA m ³ (cu.yd)	CECE m ³ (cu.yd)	Without side cutters or side shrouds mm (in)	With side cutters or side shrouds mm (in)		
PC3000-6					8.6 + 4.0 (28'3" + 13'1")
15 (19.5)	13.2 (17.3)	3250 (128")	3320 (131")	15270 (33660)	○
PC4000-6					9.75 + 4.5 (32'0" + 14'9")
22 (28.8)	19 (24.9)	3790 (149")	3800 (150")	24700 (54450)	○
PC5500-6					11 + 5.1 (36'1" + 16'9")
29 (37.9)	24.3 (31.8)	4380 (172")	4390 (173")	32860 (72440)	○
PC8000-6					11.5 + 5.5 (37'9" + 18'1")
42 (55)	36.9 (48.3)	4555 (179")	4565 (180")	44050 (97110)	○



- | | | | |
|--------------------------|----------------------|-------------------|----------------------|
| * Without side cutters | *6 Thailand source | *11 India source | *16 Bucket lip width |
| ** Heavy-duty bucket | *7 Brazil source | *12 for USA | *17 for Russia |
| *** Rock (Quarry) bucket | *8 UK source | *13 Russia source | |
| *4 Italy source | *9 USA source | *14 for UK | |
| *5 China source | *10 Indonesia source | | |

Teeth Features and Teeth Selection

EXCAVATORS (BACKHOE)

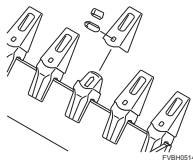
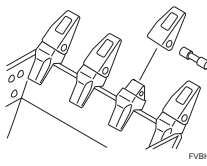
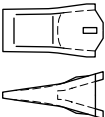
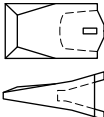
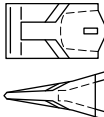
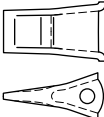
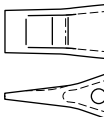
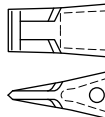
Teeth Selection for Excavators (Backhoe)

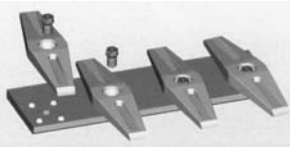
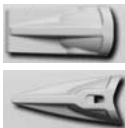
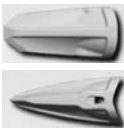
Type Current production Model	KOMATSU					
	Vertical pin type			Horizontal pin		
						
	Standard	Long Life	Self-sharpened	Standard	Long Life	Self-sharpened
						
PC130-8 PC138US PC160-8 PC200/210	○	○	○	○	○	○
PC220/230 PC270/290 PC300/350	○	○	○	○	○	○
PC400/450 PC550	○	○	○	○	○	○
PC600/650/700	—	—	—	—	—	—
PC800/850	—	—	—	—	—	—
PC1250	—	—	—	—	—	—
PC2000	—	—	—	—	—	—

Type Current production Model	Hensley KMAX series (XS series)				Komatsu KVX KVX
					
	SYL (Standard)	RC (Rock Chisel)	SC (Short)	Others	
					
PC130-8 PC138US PC160-8 PC200/210	△	△	△	△	△
PC220/230 PC270/290 PC300/350	△	△	△	△	△
PC400/450 PC550	△	△	△	△	△
PC600/650/700	◎*	◎**	○	○	△
PC800/850	◎*	◎**	○	○	△
PC1250	○	◎	○	○	△
PC2000	○	○	◎	○	△

- ◎ : Installed at Komatsu factory as a first fit optional equipment
- : Parts order needed separately and/or Hensley to Komatsu Parts Department.
- △ : Ask Hensley/KVX in detail
- : On current production models
- * : General purpose bucket
- ** : Quarry rock bucket

1. Komatsu vertical pin and horizontal pin type

- Long-life bucket tooth:
Fits the work site where wear resistance of the tooth is required because it must be used to collect sand and gravel.
- Self-sharpened bucket tooth:
Fits the work site where penetration ease of the tooth is required because it must be used to dig rock and clay after blasting.
- Standard bucket tooth:
Fits other general work sites.

2. Hensley teeth

1) Features

Tooth

- Penetrative ability can be maintained for long period of time by performing the rotation/ reverse.
- Wear resistance is reinforced with "Through-Hard" (hardened entirely).



Adapter

- Adapter nose is large and sturdy.
- Shape of the adapter is smoothly round which prevents concentration of stress.



Tooth lock pin

- It can be removed and installed easily by using socket wrench.
- It is able to use several times, and economical.



KMAX is easier

KMAX is locked with a latch. This ensures the easiest, safest and most secure locking method for a hammer-less system. No prying or special tools are needed. The teeth can be changed quickly and with minimal effort.



Locked and open position





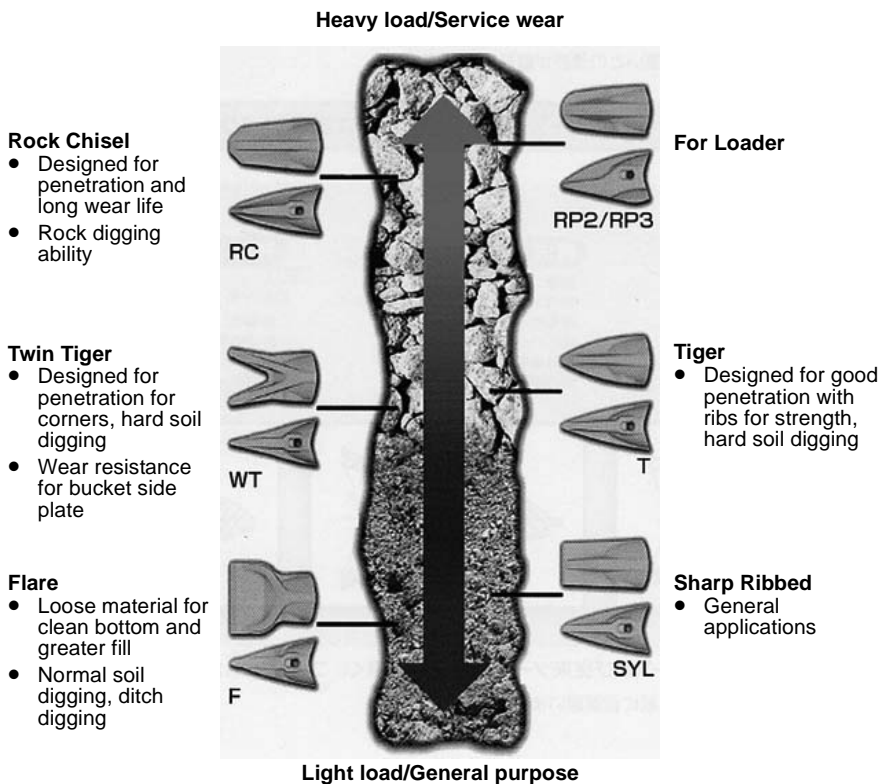



2) Teeth Selection



Application model

Series		Excavators
KMAX	XS	STANDARD/HEAVY DUTY
	XS04	PC20-PC45
	XS05	PC55-PC70
	XS10	PC78-PC88
K15	XS15	PC110-PC138
K20	XS20	PC160-PC200
K25	XS25	PC220-PC290
K30	XS30	PC300
K40	XS40	PC350-PC400
K50	XS50	PC450-PC600
K70	XS70	—
K85	XS85	PC800-PC1250
	XS115	PC1400-PC1600
	XS145	PC2000
	XS250 XS252	PC3000BH-PC3000FS
	XS340 XS342	PC4000BH
	XS390 TS922	PC4000FS
	XS640 TS1122	PC5500BH-PC5500FS
	XS800 TS1222	PC8000BH-PC8000FS

3) KMAX and XS teeth selection for excavators

Tooth style		Feature - Application	Benefit - Advantage
Sharp Ribbed (SYL)		<ul style="list-style-type: none"> • General purpose shape used on excavators • Ribbs for support • Centerline tooth 	Wears sharp for good penetration
Rock Chisel (RC)		<ul style="list-style-type: none"> • Heavy duty tooth shape • Used on excavators • Centerline tooth 	<ul style="list-style-type: none"> • Additional wear material for abrasive, tough digging conditions • Profile wears sharp for good penetration
Tiger (T)		<ul style="list-style-type: none"> • Ribs provide strength for tough digging conditions • Used on excavators • Centerline tooth 	Tooth shape provide maximum penetration
Twin Tiger (T)		<ul style="list-style-type: none"> • Used on corner adapters to cut bucket clearance • Used on excavators • Centerline tooth 	Tooth shape provide maximum penetration
U Twin Tiger (UT)		<ul style="list-style-type: none"> • Used on corner adapters to cut bucket clearance • Used on excavators • Centerline tooth 	<ul style="list-style-type: none"> • Better penetration • Parallel sides keep cut width constant during work
Flare (F)		<ul style="list-style-type: none"> • Wide profile for general purpose clean up and trench bottoms • Used on excavators • Centerline tooth 	Panels provide strength for excavating

3. K VX teeth system

1) Features

K VX GET is a "system", where the lip and other GET components work together to bring you unique benefits:

1. Recessed bolt heads mean:

- better penetration & productivity
- less hang-ups during dumping
- no exposed nuts inside the bucket

2. Threaded lip and/or GET components mean:

- positive retention throughout wear life
- more useable wear material (no mounts or plough bolt heads to wear off)
- elimination of troublesome nuts, washers, lock or retainers

3. K VX bolts mean:

- far superior GET retention than both plough bolt systems & pinned/locked systems
- high strength, enhancing impact resistance & allowing fitment of longer-life components which protrude further in front of the lip than conventional bolt or pin/lock systems can retain

4. Flat faced components mean up to 100% useable steel!

- after use as a GET components, competitive shrouds, adapters & teeth are discarded as scrap (often more than 50% "throw-away"). In contrast, K VX's "flat" GET components are re-used as wear & impact liners elsewhere in the mining operation, saving you money on alternative wear products

5. Adapterless & retainerless K VX design means:

- no adapters, retainers or profile bars to repair or replace
- no adapter, mount or profile bar welding
- almost zero risk of GET loss
- less risk of significant repair and downtime related to site costs due to lost GET parts damaging other plant
- excellent protection for underside of lip & bucket (minimal bucket underside wear)
- thinner frontal GET/lip profile for superior productivity and fuel efficiency plus less wheel spin

6. Sagitta steel means:

- longer GET life than typical castings (due to toughness, hardness and available steel)
- fewer change-outs and less bucket & GET Maintenance
- superior reliability

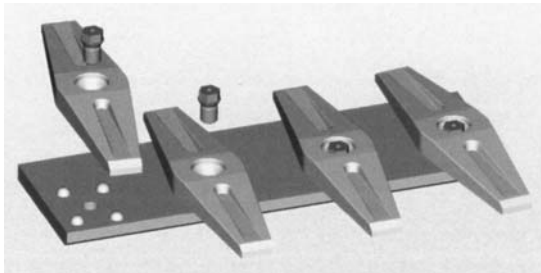

2) Teeth selection

How to select the right KVX system

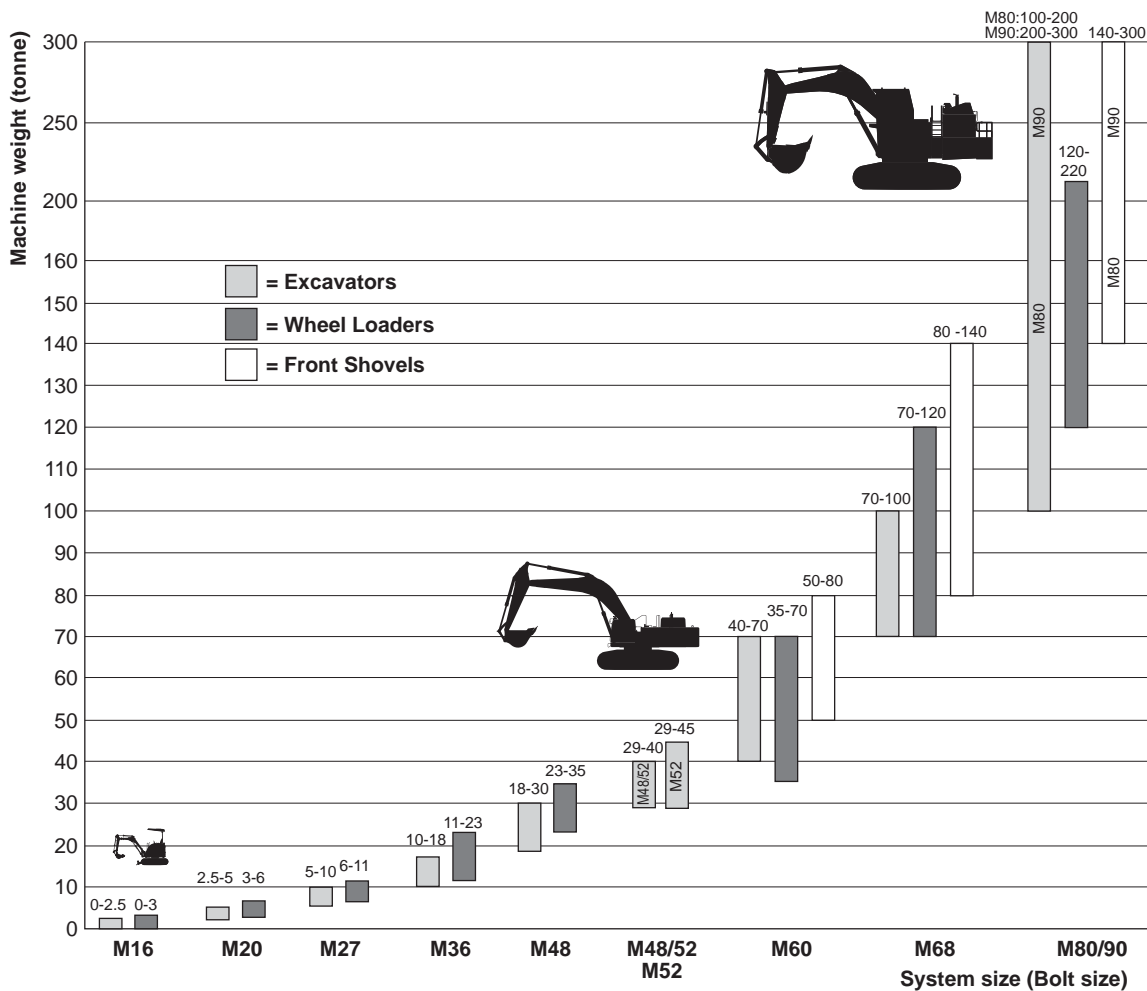

The graph indicates the recommended KVX system based on machine weight.
If in doubt, choose the larger system.

FVBH0494

A: STANDARD

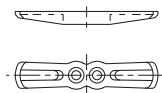

B: STONE

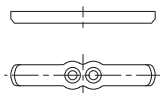

C: TORPEDO

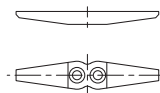

D: STORE TORPEDO

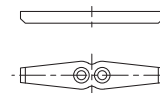

E: STONE HD

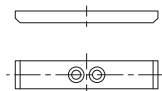

F: PENETRATION

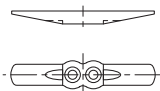

G: TIGER

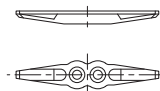

H: TWIN TIGER

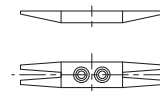

FVBH0189

**Teeth Features
and Teeth Selection**

**EXCAVATORS
(BACKHOE)**

KVX Tooth Table

Model	Bolt Size	TOOTH SHAPES							
		A	B	C	D	E	F	G	H
PC120, PC200	M36	○	○	—	—	—	○	○	○
PC200, PC300	M48	○	○	—	○	○	○	○	○
PC350, PC450	M48 / 52	○	—	○	—	○	—	○	○
PC450, PC600	M60	○	○	—	○	○	—	○	○
PC600, PC800	M68	—	—	—	○	○	—	○	○
PC1250	M80	—	—	—	○	○	—	○	○

○ : Available

1. Basic idea for excavator selection

The concept of the combination of bucket size, arm length, and boom length for hydraulic excavators to match the nature of the operation is as follows.

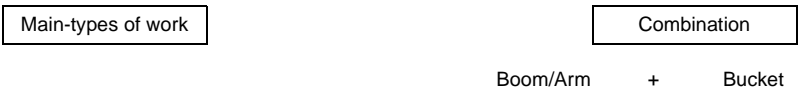

1) Wider working range

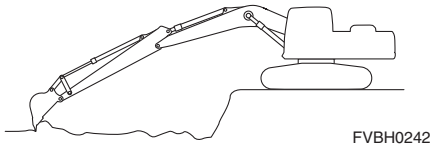

Long boom
Long arm + Small capacity bucket

2) Larger production

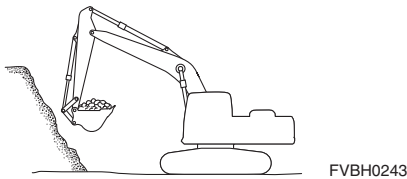

Short boom
Short arm + Large capacity bucket

3) Larger digging force, Larger lifting capacity

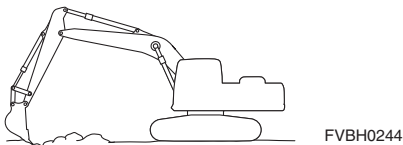

Short arm + Narrow bucket
+ Ripper bucket

4) Heavy-duty work

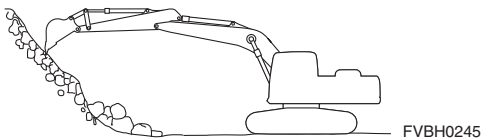

Strengthened boom
Strengthened arm + Heavy-duty bucket

2. Wrong combination

1) Long Arm with Large Capacity Bucket

If the machine is operated with a long arm and a large capacity bucket with a capacity larger than recommended, the machine will become unstable, and it will also lose digging power, so the operating efficiency will drop. In particular, if a strong shock load is applied to the bucket, there is danger that the arm may break.

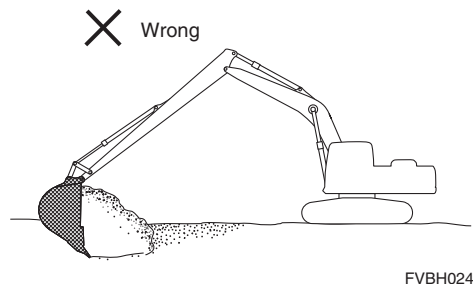

2) Additional Counterweight

If an excessive capacity bucket or heavy attachment is installed, the machine will become unstable, so it is common to see additional counterweights used. However, this means that an excessive load is applied not only to the work equipment and undercarriage, but also to the whole machine, so this will lead to a reduction in the service life of the machine.

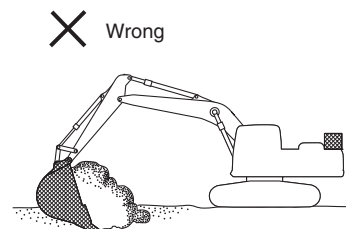

3. Concepts for selection of backhoe type and loading shovel for large hydraulic excavators

1) Bench height (ease of loading)

From the point of view of the ease of loading a dump truck, a guideline is to select a loading shovel if the height of the bench is more than 5 m (16'5"), and a backhoe type if the height of the bench is less than 5 m (16'5").

For the backhoe type to load a dump truck efficiently, the bench height should be less than the dump truck body height.

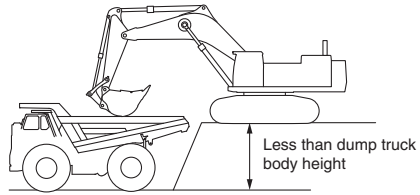

FVBH0248

2) Digging function

Loading shovel : This is better for loading blasted rocks where there are many large lumps and digging force is required. When digging flat surfaces, its horizontal pushing force is strong and it can show its power, but it is difficult for it to use its pushing force when digging above ground level.

Backhoe : This is an all-round attachment for digging and loading. When increasing the bucket size to ensure production volume, make the work equipment (arm, boom) shorter.

Large Size Hydraulic Excavator Work Equipment Selection Guide

Select the work equipment for large hydraulic excavators as follows.

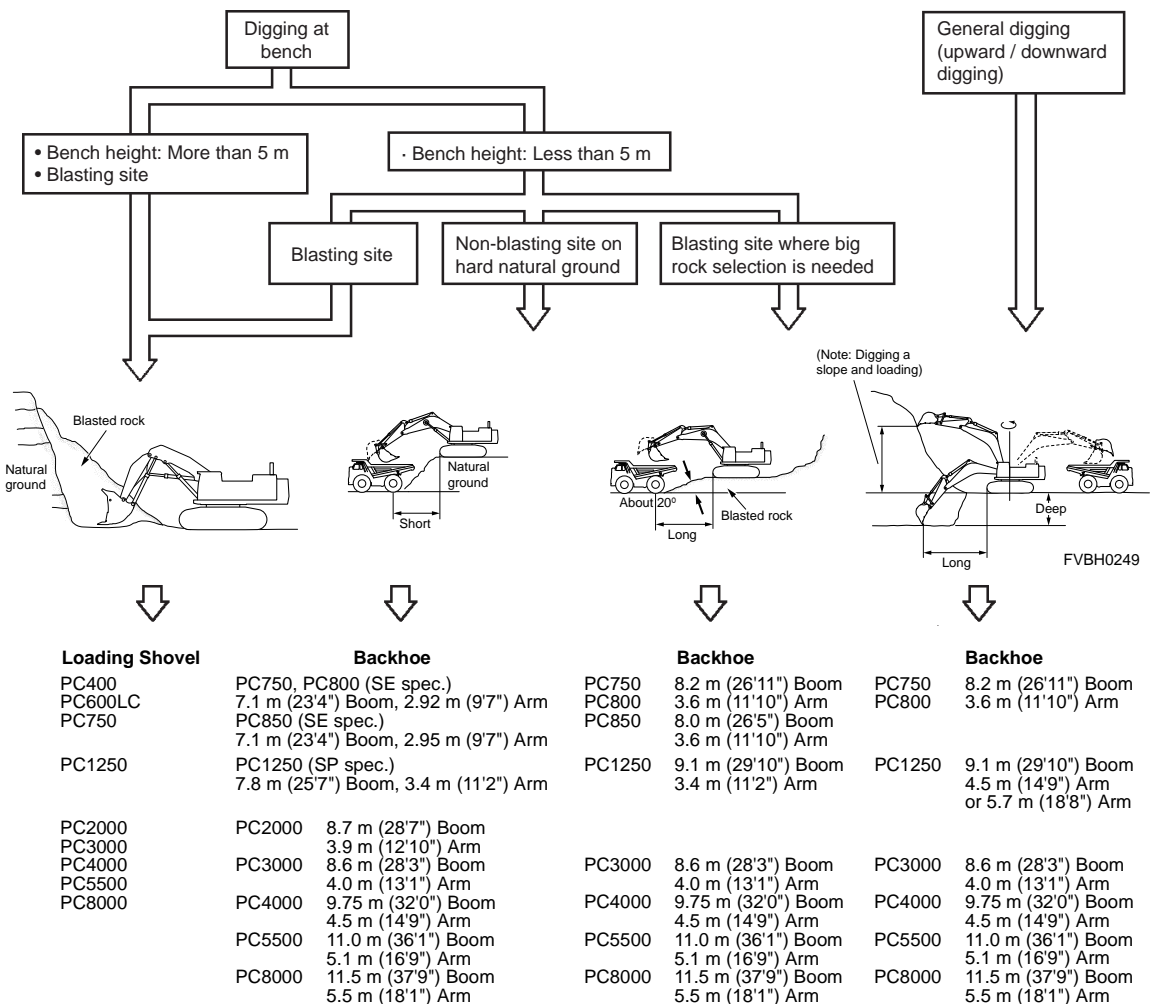

FVBH0249

NOTE: The bucket size depends on the specific gravity (loose) of the material loaded. For details, see Bucket and Arm Combination.

Hydraulic excavator and dump truck combination

HYDRAULIC EXCAVATOR			RIGID DUMP TRUCK						
MODEL (B/H)	BUCKET CAPACITY (HEAPED) m ³ (cu.yd)		HD255	HD325	HD405	HD465	HD605	HD785	HD1500
			Payload m. ton (U.S. ton)						
			25 (27.6)	36.5 (40)	41 (45)	55 (61)	63 (69)	91 (100)	144 (159)
			Body Capacity m ³ (cu. yd)						
(SAE)	(CECE)	17.7 (23.2)	24.0 (31.4)	27.3 (35.7)	34.2 (44.7)	40 (52.3)	60 (78.5)	78 (102)	
PC400	1.90 (2.49)	1.7 (2.22)	7	(11)					
PC450	2.10 (2.75)	1.9 (2.49)	7	(10)	(11)				
PC600 PC700	2.0 (2.62)	1.8 (2.35)	7	(10)	(11)				
	2.3 (3.01)	2.1 (2.75)	6	(9)	(10)				
	2.7 (3.53)	2.4 (3.14)	5	8	8	(11)			
	2.8 (3.66)	2.5 (3.27)	5	7	8	(11)			
	3.1 (4.05)	2.8 (3.66)	4	7	7	(10)	(11)		
	3.5 (4.58)	3.1 (4.05)	4	6	7	(9)	(10)		
PC800-8 PC750-7	2.8 (3.66)	2.5 (3.27)	5	7	8	(11)			
	3.1 (4.05)	2.8 (3.66)	4	7	7	(10)	(11)		
	3.4 (4.45)	3.0 (3.92)	4	6	7	(9)	(10)		
PC750-7 (SE spec.)	4.0 (5.2)	3.5 (4.6)	(3)	5	6	8	(9)		
PC800-8 (SE spec.)	4.3 (5.6)	3.8 (5.0)	(3)	5	5	7	8		
	4.5 (5.9)	4.0 (5.2)	(3)	5	5	7	8	(11)	
PC800-7 PC850-8	3.4 (4.45)	3.0 (3.92)	4	6	7	(9)	(10)		
PC1250	3.4 (4.4)	3.0 (3.9)	4	6	7	(9)	(10)		
	4.0 (5.2)	3.5 (4.6)	(3)	5	6	8	(9)		
	5.0 (6.5)	4.3 (5.6)	(3)	4	5	6	7	(10)	
	5.2 (6.8)	4.5 (5.9)	(3)	4	4	6	7	(10)	
PC1250 (SP spec.)	6.7 (8.8)	5.7 (7.5)		(3)	(3)	5	5	8	
PC2000	12.0 (15.7)	11.0 (14.4)				(3)	(3)	4	7
	13.7 (17.9)	12.0 (15.7)					(3)	4	6

Note: B/H: BACKHOE

Number of loads: 4 ~ 8 Suitable, (3)(9) ~ (11) Possible

Above combination is determined by following method;

(1) Suitable loading times (n):

$$n = \frac{\text{Max. payload of dump truck}}{\text{Bucket capacity} \times \text{Bucket fill factor} \times \text{Specific weight}} \quad \text{or} \quad n = \frac{\text{Heaped capacity of dump truck}}{\text{Bucket capacity} \times \text{Bucket fill factor}}$$

Number of loading times is calculated based on following condition.

1. Calculate number of loading times from maximum payload of dump truck.
Please see formula 1.
2. Calculate number of loading times from body capacity of dump truck.
Please see formula 2.
3. Adopt lower number between formula 1 and formula 2.

Formula 1

Number of loading = Payload of truck (metric tonnes) / (Bucket capacity of loader (m³) × loose density × bucket factor)

Formula 2

Number of loading = Body capacity (cubic meter) / (Bucket capacity of loader (m³) × bucket factor)

We adopt following condition.

Density = 1.8 metric tonnes per cubic meter

Bucket factor = 1.0

Calculated number of loading times are rounded off to the first decimal place.

Hydraulic excavator and dump truck combination

HYDRAULIC EXCAVATOR			RIGID DUMP TRUCK						
MODEL (B/H)	BUCKET CAPACITY (HEAPED) m ³ (cu.yd)		HD785	HD1500	730E	830E-AC	860E-1K	930E-4 930E-4SE	960E
			Payload m. ton (U.S. ton)						
			91 (100)	144 (159)	181 (200)	222 (244)	254 (280)	292 (320)	327 (360)
	Body Capacity m ³ (cu. yd)								
(SAE)	(CECE)	60 (78.5)	78 (102)	148 (193)	147 (193)	169 (221)	211 (276)	214 (280)	
PC3000	15.0 (19.6)	13.1 (17.1)	4	6	7				
PC4000	22.0 (28.8)	19 (25)	3	4	5	6	6		
PC5500	29.0 (37.9)	24.3 (31.8)		3	4	5	5	6	7
PC8000	42.0 (54.9)	36.9 (48.3)			3	3	4	4	5

Note: B/H: BACKHOE
Number of loads: 3 – 7 Suitable

Above combination is determined by following method;
(1) Suitable loading times (n):

$$n = \frac{\text{Max. payload of dump truck}}{\text{Bucket capacity} \times \text{Bucket fill factor} \times \text{Specific weight}} \quad \text{or} \quad n = \frac{\text{Heaped capacity of dump truck}}{\text{Bucket capacity} \times \text{Bucket fill factor}}$$

Number of loading times is calculated based on following condition.

1. Calculate number of loading times from maximum payload of dump truck.
Please see formula 1.
2. Calculate number of loading times from body capacity of dump truck.
Please see formula 2.
3. Adopt lower number between formula 1 and formula 2.

Formula 1

Number of loading = Payload of truck (metric tonnes) / (Bucket capacity of loader (m³) × loose density × bucket factor)

Formula 2

Number of loading = Body capacity (cubic meter) / (Bucket capacity of loader (m³) × bucket factor)

We adopt following condition.

Density = 1.8 metric tonnes per cubic meter

Bucket factor = 1.0

Working range and load height

Normal rock-loading operations:
Loading machine: PC350-7, PC350-8
Dump truck: 11-ton

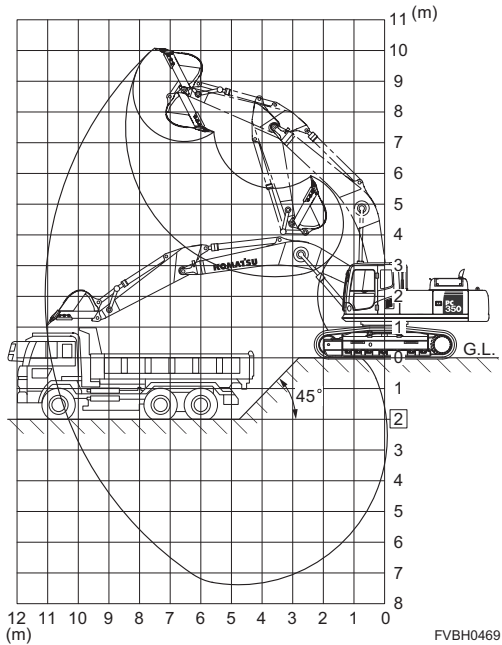

Normal rock-loading operations:
Loading machine: PC450-7, PC450-8(8R)
Dump truck: HD255-5

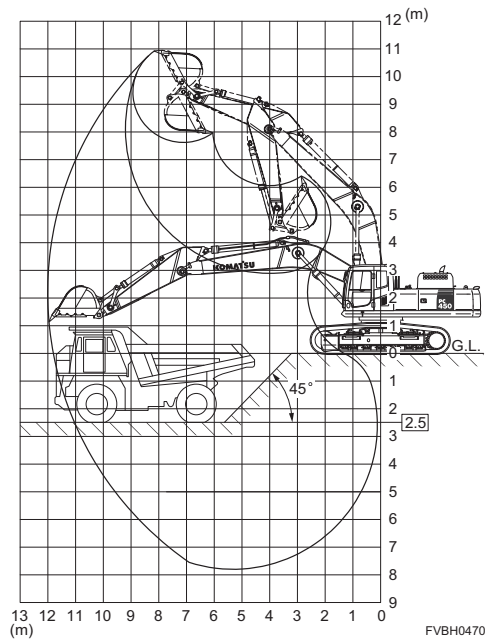

Normal rock-loading operations:
Loading machine: PC600-7, PC600-8E0(8R1)
Dump truck: HD255-5

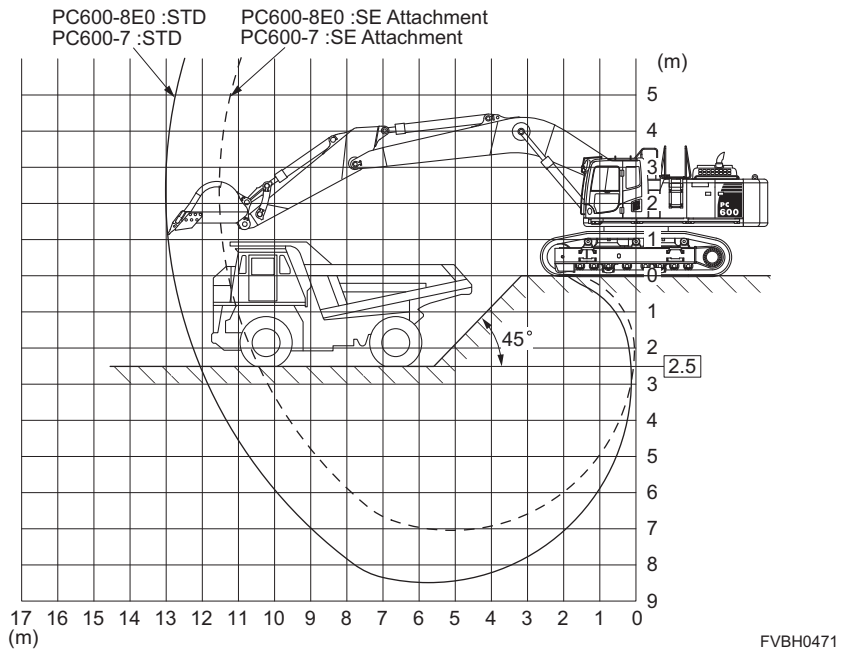

Working range and load height

Normal rock-loading operations:
 Loading machine: PC700LC-8E0 (8R)
 Dump truck: HD325-7

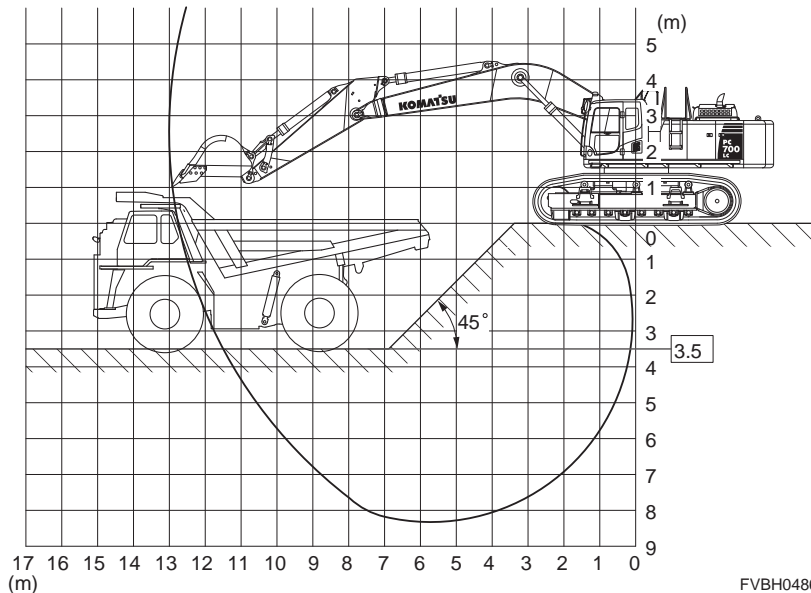

FVBH0486

Normal rock-loading operations:
 Loading machine: PC800-7, PC850-8E0(8R1)
 Dump truck: HD325-7(7R)

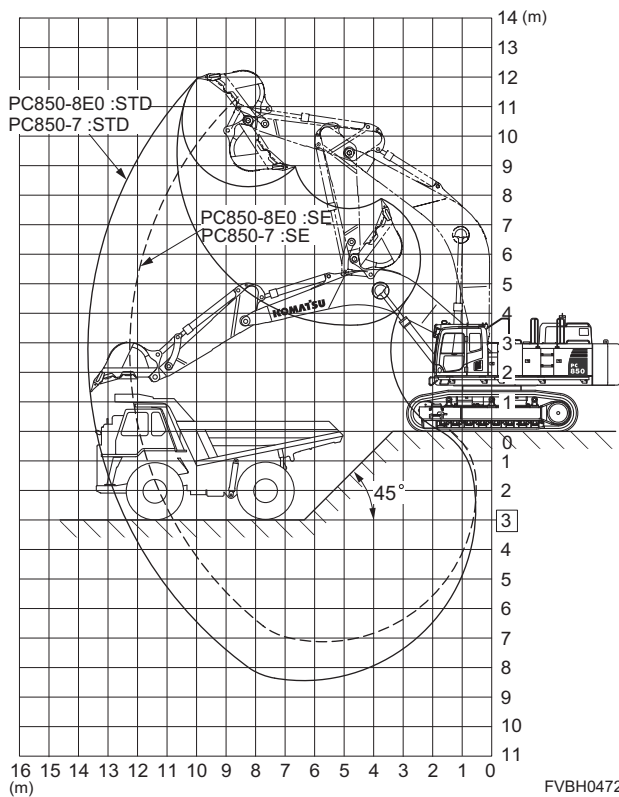

FVBH0472

Working range and load height

Normal rock-loading operations:

Loading machine: PC1250-7, PC1250-7(SP spec.), PC1250-8(8R), PC1250-8(8R)(SP spec.)

Dump truck: HD465-7E0(7R)

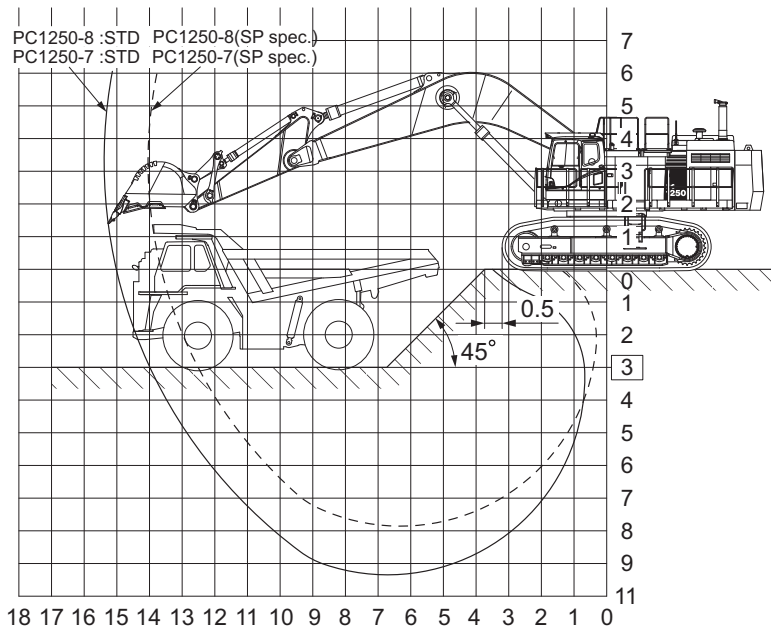

Normal rock-loading operations:

Loading machine: PC2000-8

Dump truck: HD785-7

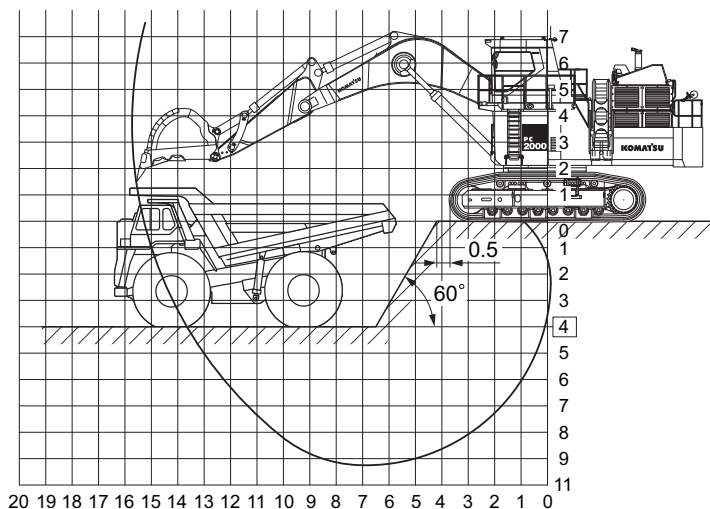

Working range and load height

Normal rock-loading operations:

Loading machine: PC3000-6

Dump truck: HD1500-7

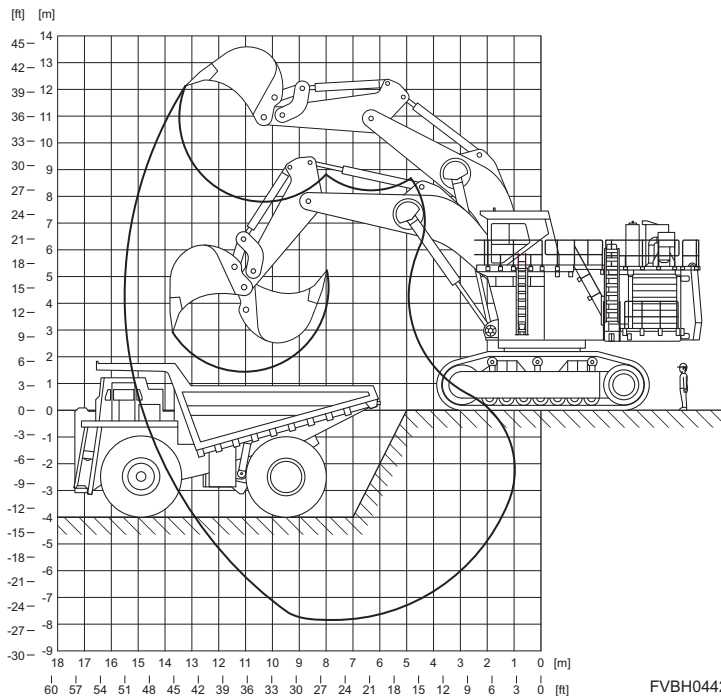

Normal rock-loading operations:

Loading machine: PC4000-6

Dump truck: 730E

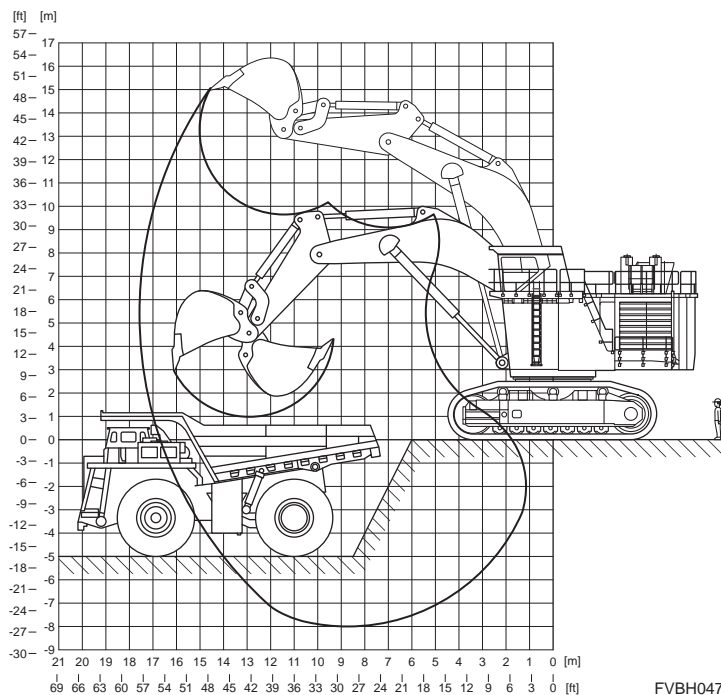

Working range and load height

Normal rock-loading operations:

Loading machine: PC5500-6

Dump truck: 830E

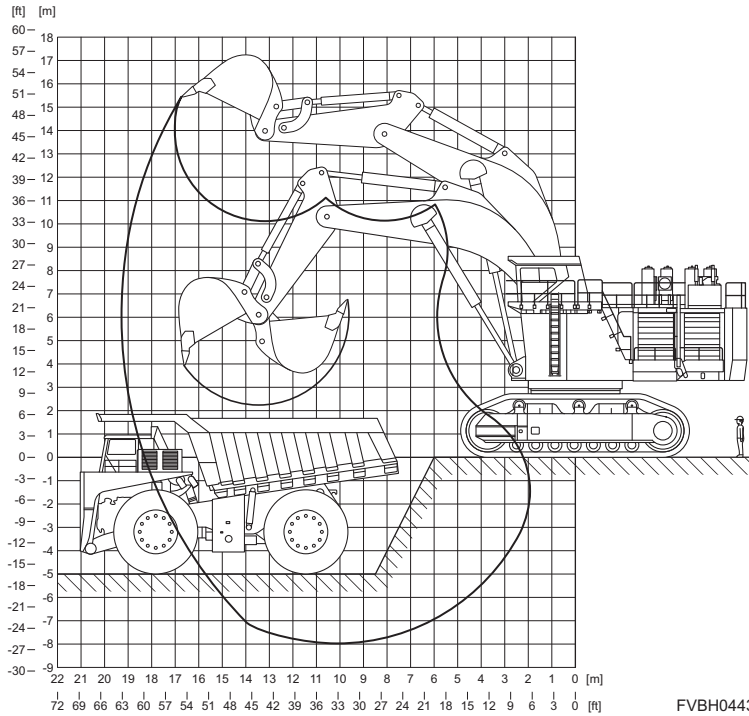

Normal rock-loading operations:

Loading machine: PC8000-6

Dump truck: 930E

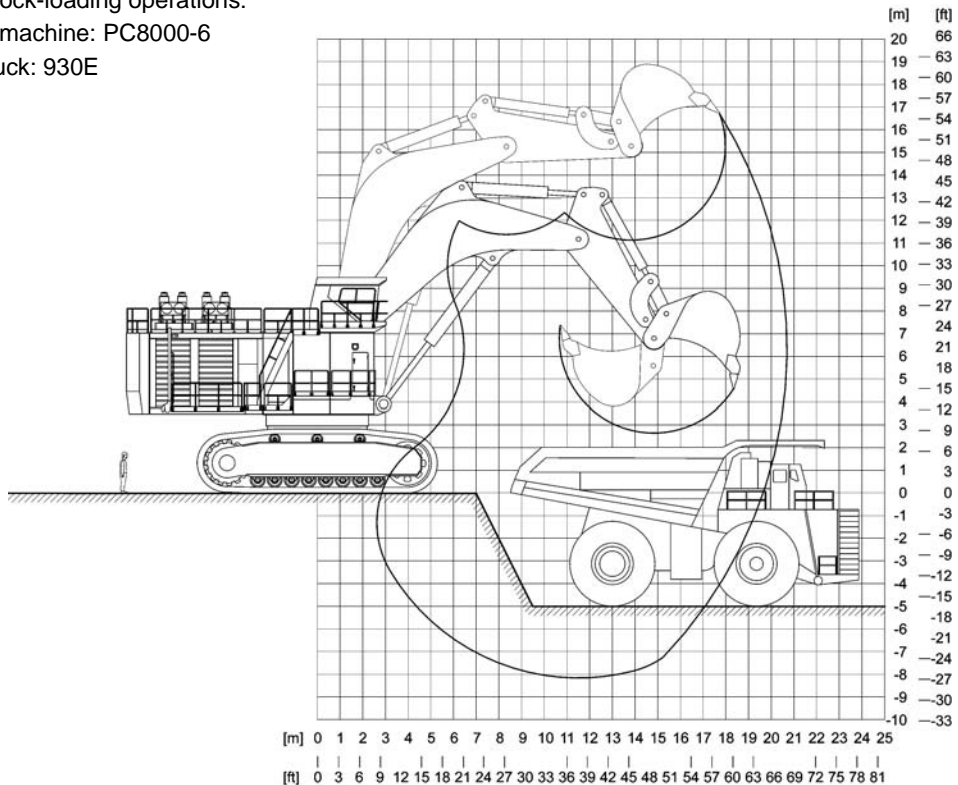

Estimated Hourly Production

ESTIMATED CYCLE TIME		BUCKET SIZE** (CU.M) OR (CU.YD)																								
SEC.	MIN.	0.2	0.3	0.5	0.7	0.9	1.1	1.3	1.5	1.7	1.9	2.1	2.3	2.5	2.7	2.9	3.1	3.3	3.5	3.7	3.9	4.1	4.3			
10.0	0.17	72	108	180	252	324																				
11.0	0.18	65	98	164	229	295	360	425	491																	
12.0	0.20	60	90	150	210	270	330	390	450	510	570	630	690	750												
13.0	0.22	55	83	138	194	249	305	360	415	471	526	582	637	692	748	803	858	914	969	1025	1080	1135				
15.0	0.25	48	72	120	168	216	264	312	360	408	456	504	552	600	648	696	744	792	840	888	936	984	1032			
17.0	0.28	42	64	106	148	191	233	275	318	360	402	445	487	529	572	614	656	699	741	784	826	868	911			
19.0	0.32	38	57	95	133	171	208	246	284	322	360	398	436	474	512	549	587	625	663	701	739	777	815			
21.0	0.35	34	51	86	120	154	189	223	257	291	326	360	394	429	463	497	531	566	600	634	669	703	737			
24.0	0.40	30	45	75	105	135	165	195	225	255	285	315	345	375	405	435	465	495	525	555	585	615	645			
27.0	0.45	27	40	67	93	120	147	173	200	227	253	280	307	333	360	387	413	440	467	493	520	547	573			
30.0	0.50	24	36	60	84	108	132	156	180	204	228	252	276	300	324	348	372	396	420	444	468	492	516			
35.0	0.58									175	195	216	237	257	278	298	319	339	360	381	401	422	442			
40.0	0.67																			279	297	315	333	351	369	387

ESTIMATED CYCLE TIME		BUCKET SIZE** (CU.M) OR (CU.YD)																					
SEC.	MIN.	4.5	4.7	4.9	5.1	5.3	5.5	5.7	6.0	6.5	7.0	7.5	8.0	8.5	9.0	9.5	10.0	10.5	11.0	11.5	12.0		
15.0	0.25	1080	1128	1176	1224	1272	1320	1368															
17.0	0.28	953	995	1038	1080	1122	1165	1207															
19.0	0.32	853	891	928	966	1004	1042	1080	1137	1231	1326	1421	1516	1611	1705	1800	1895	1989	2084	2179	2274		
21.0	0.35	771	806	840	874	909	943	977	1028	1114	1200	1286	1371	1457	1543	1629	1714	1800	1886	1971	2057		
24.0	0.40	675	705	735	765	795	825	855	900	975	1050	1125	1200	1275	1350	1425	1500	1575	1650	1725	1800		
27.0	0.45	600	627	653	680	707	733	760	800	867	933	1000	1067	1133	1200	1267	1333	1400	1467	1533	1600		
30.0	0.50	540	564	588	612	636	660	684	720	780	840	900	960	1020	1080	1140	1200	1260	1320	1380	1440		
35.0	0.58	463	483	504	525	545	566	586	617	668	720	771	823	874	926	977	1029	1080	1131	1183	1234		
40.0	0.67	405	423	441	459	477	495	513	540	585	630	675	720	765	810	855	900	945	990	1035	1080		
45.0	0.75								480	520	560	600	640	680	720	760	800	840	880	920	960		

ESTIMATED CYCLE TIME		BUCKET SIZE** (CU.M) OR (CU.YD)														
SEC.	MIN.	12.5	13.0	13.5	14.0	15.0	16.0	18	20	22	25	28	30	35	38	40
15.0	0.25															
17.0	0.28															
19.0	0.32	2368	2463													
21.0	0.35	2143	2229	2314	2400	2571	3031	3085								
24.0	0.40	1875	1950	2025	2100	2250	2400	2700	3000	3300	3750	4200	4500	5250	5700	6000
27.0	0.45	1667	1733	1800	1866	2000	2133	2400	2666	2933	3333	3733	4000	4666	5066	5333
30.0	0.50	1500	1560	1620	1680	1800	1920	2160	2400	2640	3000	3360	3600	4200	4560	4800
35.0	0.58	1286	1337	1388	1440	1543	1645	1851	2057	2263	2571	2880	3085	3600	3908	4114
40.0	0.67	1125	1170	1215	1260	1350	1440	1620	1800	1980	2250	2520	2700	3150	3420	3600
45.0	0.75	1000	1040	1080	1120	1200	1280	1440	1600	1760	2000	2240	2400	2800	3040	3200

** Bucket size : Heaped bucket capacity
 *** Cycle time : Refer to the section 16A "Productivity"

Actual production = Estimated Hourly Production × Bucket Fill Factor × Job Efficiency

Bucket fill factor (K) (PC78~PC2000)

Excavating conditions	K
Easy excavating	1.1 ~ 1.2
Average excavating	1.0 ~ 1.1
Rather difficult excavating	0.8 ~ 0.9
Difficult excavating	0.7 ~ 0.8

Job efficiency (E)

Excavating conditions	E
Good	0.83
Average	0.75
Rather poor	0.67
Poor	0.58

Bucket fill factor (K) (PC3000~PC8000) **4

Excavating conditions	K
Easy excavating	1.0
Average excavating	0.95
Severe	0.9

**4:KMG Mining Shovels (Backhoe)

SECTION **2B**

LIFTING CAPACITY

CONTENTS

PC14/16/18 2B-2
PC18/20/22 2B-3
PC27/30 2B-4
PC35/45 2B-5
PC45/55 2B-6
PC70 2B-8
PC78 2B-9
PC71/80 2B-10
PC88 2B-11
PC118 2B-14
PC130 2B-15
PC138 2B-18
PC160 2B-21
PC190 2B-24
HB205/215 2B-26
PC200 2B-27
PC210 2B-35
PC220 2B-40
PC228 2B-46
PC230 2B-49
PC240 2B-50
PC270 2B-54
PC290 2B-56
PC300 2B-60
PC350 2B-69
PC360 2B-72
PC390 2B-74
PC400 2B-76
PC450 2B-86
PC490 2B-88
PC550 2B-94
PC600 2B-95
PC650 2B-105
PC700 2B-107
PC750 2B-109
PC800 2B-112
PC850 2B-121
PC1250 2B-123
PC2000 2B-128

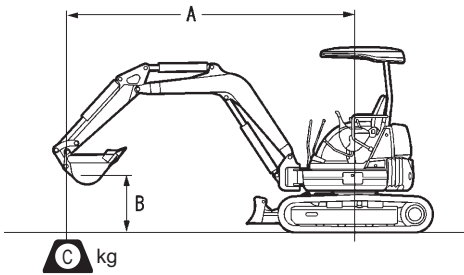

FVP02090

- A : Reach from swing center
- B : Bucket hook height
- C : Lifting capacity
- Cf : Rating over front
- Cs : Rating over side
- MAX: Rating at maximum reach

PC14R-3 (Italy source)

Conditions: Bucket (SAE): 0.04 m³, Shoes: 230 mm

unit: kg

B	A	MAX		3.0 m		2.5 m		2.0 m	
		Cf	Cs	Cf	Cs	Cf	Cs	Cf	Cs
Arm length 880 mm Blade on ground									
2.0 m		*220	179			218	200	*225	*225
1.0 m		*221	143			266	192	*353	267
0 m		*231	147			299	182	*424	249
-1.0 m		*227	215					*293	253
Arm length 1130 mm With blade on ground									
2.0 m		*184	151			*178	*178		
1.0 m		*189	123	*201	141	*235	190	*302	268
0 m		*200	125	*218	135	*290	177	*413	243
-1.0 m		*208	170			*226	177	*341	242

* Load is limited by hydraulic capacity rather than tipping.
Ratings are based on ISO Standard NO. 10567. Rated loads do not exceed 87% of hydraulic lift capacity or 75% of tipping load.

PC16R-3 (Italy source)

Conditions: Bucket (SAE): 0.04 m³, Shoes: 230 mm

unit: kg

B	A	MAX		3.0 m		2.5 m		2.0 m	
		Cf	Cs	Cf	Cs	Cf	Cs	Cf	Cs
Arm length 965 mm Blade on ground									
2.0 m		*279	172			*278	230	*286	*286
1.0 m		*284	142	*303	163	*364	217	*486	299
0 m		*296	146	*324	157	*426	204	*600	278
-1.0 m		*298	196			*331	206	*480	281
Arm length 1215 mm Blade on ground									
2.0 m		*242	145	*235	168	*229	*229		
1.0 m		*247	122	*276	161	*324	216	*417	302
0 m		*259	125	*317	152	*412	200	*584	273
-1.0 m		*266	159			*373	197	*525	271

* Load is limited by hydraulic capacity rather than tipping.
Ratings are based on ISO Standard NO. 10567. Rated loads do not exceed 87% of hydraulic lift capacity or 75% of tipping load.

PC18MR-3

Conditions: Boom: 1760 mm (5'7"), Bucket (SAE): 0.044 m³ (0.058 cu.yd), Shoes: 230 mm (9") unit: kg (lb)

B	A	MAX		3.0 m (10')		2.0 m (7')	
		Cf	Cs	Cf	Cs	Cf	Cs
Arm length 965 mm (3'2") Blade on ground with additional counterweight (X-weight)							
3.0 m (10')		*355 (780)	*355 (780)				
2.0 m (7')		*315 (700)	215 (470)	*310 (680)	235 (520)		
1.0 m (3')		*320 (710)	180 (400)	*365 (810)	230 (510)	*650 (1435)	420 (930)
0 m (0')		*335 (740)	185 (410)	*410 (900)	220 (480)	*805 (1780)	395 (870)
-1.0 m (-3')		*340 (750)	245 (540)			*635 (1400)	400 (880)

* Load is limited by hydraulic capacity rather than tipping.
Ratings are based on SAE Standard NO. J1097. Rated loads do not exceed 87% of hydraulic lift capacity or 75% of tipping load.

PC18MR-3 (Italy source)Conditions: Boom: 1760 mm, Bucket (SAE): 0.04 m³, Shoes: 230 mm

unit: kg

B	A	MAX		3.0 m		2.5 m		2.0 m	
		Cf	Cs	Cf	Cs	Cf	Cs	Cf	Cs
Arm length 965 mm Blade on ground									
	3.0 m	*318	188	*314	205	*318	282		
	1.0 m	*324	156	*367	199	*454	265	*653	370
	0 m	*338	160	*412	190	*551	249	*806	344
	-1.0 m	*342	213			*446	251	*635	350
Arm length 1215 mm Blade on ground									
	2.0 m	*280	162	*268	209	*257	*257		
	1.0 m	*287	138	*336	199	*404	267	*548	378
	0 m	*300	141	*404	*188	*535	248	*798	343
	-1.0 m	*310	177	*350	188	*493	245	*704	342

* Load is limited by hydraulic capacity rather than tipping.

Ratings are based on ISO standard 10567. Rated loads do not exceed 87% of hydraulic lift capacity or 75% of tipping load.

PC20MR-3Conditions: Boom: 1320 mm (6'11"), Bucket (SAE): 0.066 m³ (0.086 cu.yd), Shoes: 250 mm (10") unit: kg (lb)

B	A	MAX		3.0 m (10')		2.0 m (7')	
		Cf	Cs	Cf	Cs	Cf	Cs
Arm length 970 mm (3'2") Blade on ground with additional counterweight (X-weight)							
	3.0 m (10')	*515 (1135)	375 (825)				
	2.0 m (7')	*545 (1200)	250 (550)	*525 (1155)	310 (685)		
	1.0 m (3')	*595 (1310)	225 (495)	*685 (1510)	295 (650)	*1310 (2885)	550 (1215)
	0 m (0')	*655 (1445)	240 (530)	*790 (1745)	285 (630)	*1535 (3385)	530 (1170)
	-1.0 m (-3')	*740 (1630)	345 (760)			*1260 (2780)	545 (1200)

* Load is limited by hydraulic capacity rather than tipping.

Ratings are based on SAE Standard NO. J1097. Rated loads do not exceed 87% of hydraulic lift capacity or 75% of tipping load.

PC22MR-3 (Italy source)Conditions: Boom: 1320 mm, Bucket (SAE): 0.07 m³, Shoes: 250 mm

unit: kg

B	A	MAX		3.0 m		2.0 m	
		Cf	Cs	Cf	Cs	Cf	Cs
Arm length 970 mm Blade on ground							
	3.0 m	*475	360				
	2.0 m	*445	255	*490	340		
	1.0 m	*480	230	*655	320	*1195	590
	0 m	*605	245	*810	310	*1570	560
	-1.0 m	*755	330			*1395	570
Arm length 1320 mm Blade on ground							
	3.0 m	*350	285	*325	*325		
	2.0 m	*320	215	*365	*340		
	1.0 m	*340	195	*565	320	*885	*610
	0 m	*410	205	*765	305	*1495	*555
	-1.0 m	*625	260	*790	300	*1510	550

* Load is limited by hydraulic capacity rather than tipping.

Ratings are based on ISO standard 10567. Rated loads do not exceed 87% of hydraulic lift capacity or 75% of tipping load.

PC27MR-3Conditions: Boom: 2180 mm (7'2"), Bucket (SAE): 0.08 m³ (0.105 cu.yd), Shoes: 300 mm (12") unit: kg (lb)

B	A	MAX		4.0 m (13')		3.0 m (10')		2.0 m (7')	
		Cf	Cs	Cf	Cs	Cf	Cs	Cf	Cs
Arm length 1100 mm (37") Blade on ground with additional counterweight (X-weight)									
3.0 m (10')		*695 (1530)	325 (720)			*650 (1430)	425 (940)		
2.0 m (7')		*705 (1550)	250 (550)			*795 (1750)	410 (900)	*1215 (2680)	800 (1760)
1.0 m (3')		*735 (1620)	230 (510)	*755 (1660)	240 (530)	*1065 (2350)	385 (850)		
0 m (0')		*775 (1710)	245 (540)			*1185 (2610)	370 (820)	*2230 (4920)	680 (1500)
-1.0 m (-3')		*810 (1790)	315 (690)			*1020 (2250)	370 (820)	*1820 (4010)	695 (1530)

* Load is limited by hydraulic capacity rather than tipping.

Ratings are based on SAE Standard NO. J1097. Rated loads do not exceed 87% of hydraulic lift capacity or 75% of tipping load.

PC30MR-3Conditions: Boom: 2285 mm (7'6"), Bucket (SAE): 0.09 m³ (0.12 cu.yd), Shoes: 300 mm (12") unit: kg (lb)

B	A	MAX		4.0 m (13')		3.0 m (10')		2.0 m (7')	
		Cf	Cs	Cf	Cs	Cf	Cs	Cf	Cs
Arm length 1240 mm (41") Blade on ground with additional counterweight (X-weight)									
3.0 m (10')		*825 (1820)	290 (640)			*795 (1750)	435 (960)		
2.0 m (7')		*825 (1820)	225 (500)	*835 (1840)	250 (550)	*1000 (2200)	420 (930)		
1.0 m (3')		*845 (1860)	210 (460)	*915 (2020)	240 (530)	*1320 (2910)	385 (850)		
0 m (0')		*870 (1920)	220 (480)	*930 (2050)	230 (510)	*1440 (3170)	365 (800)	*2660 (5860)	680 (1500)
-1.0 m (-3')		*880 (1940)	275 (610)			*1250 (2760)	365 (800)	*2140 (4720)	695 (1530)

* Load is limited by hydraulic capacity rather than tipping.

Ratings are based on SAE Standard NO. J1097. Rated loads do not exceed 87% of hydraulic lift capacity or 75% of tipping load.

PC30MR-3 (Italy source)Conditions: Boom: 2285 mm, Bucket (SAE): 0.095 m³, Shoes: 300 mm

unit: kg

B	A	MAX		4.0 m		3.0 m		2.0 m	
		Cf	Cs	Cf	Cs	Cf	Cs	Cf	Cs
Arm length 1240 mm Blade on ground									
4.0 m		*920	580						
3.0 m		*825	320			*795	470		
2.0 m		*825	250	*835	275	*1005	455		
1.0 m		*845	230	*920	265	*1325	420		
0 m		*875	245	*930	260	*1445	400	*2670	745
-1.0 m		*885	305			*1255	405	*2155	760
-2.0 m		*760	610						

B	A	MAX		3.0 m		2.5 m		2.0 m	
		Cf	Cs	Cf	Cs	Cf	Cs	Cf	Cs
Arm length 1610 mm Blade on ground									
4.0 m		*740	425			*700	480		
3.0 m		*715	275	*710	285				
2.0 m		*730	225	*750	285	*845	470		
1.0 m		*760	210	*870	270	*1210	435		
0 m		*795	215	*945	260	*1435	405	*2850	745
-1.0 m		*835	260	*835	260	*1370	400	*2490	750
-2.0 m		*825	415					*1575	780

* Load is limited by hydraulic capacity rather than tipping.

Ratings are based on ISO standard 10567. Rated loads do not exceed 87% of hydraulic lift capacity or 75% of tipping load.

PC35MR-3Conditions: Boom: 2540 mm (8'4"), Bucket (SAE): 0.11 m³ (0.14 cu.yd), Shoes: 300 mm (12") unit: kg (lb)

B	A	MAX		4.0 m (13')		3.0 m (10')		2.0 m (7')	
		Cf	Cs	Cf	Cs	Cf	Cs	Cf	Cs
Arm length 1370 mm (4'6") Blade on ground with additional counterweight (X-weight)									
3.0 m (10')		*690 (1520)	385 (850)	*710 (1570)	405 (890)	*705 (1550)	*680 (1500)		
2.0 m (7')		*710 (1570)	315 (690)	*770 (1700)	400 (880)	*960 (2120)	655 (1440)		
1.0 m (3')		*845 (1860)	335 (740)	*880 (1940)	385 (850)	*1290 (2840)	610 (1350)		
0 m (0')		*885 (1950)	345 (760)	*935 (2060)	375 (830)	*1430 (3150)	580 (1280)	*2610 (5750)	1100 (2420)
-1.0 m (-3')		*920 (2030)	415 (910)			*1325 (2920)	580 (1280)	*2245 (4950)	1120 (2470)

* Load is limited by hydraulic capacity rather than tipping.

Ratings are based on SAE Standard NO. J1097. Rated loads do not exceed 87% of hydraulic lift capacity or 75% of tipping load.

PC35MR-3 (Italy source)Conditions: Boom: 2540 mm, Bucket (SAE): 0.12 m³, Shoes: 300 mm

unit: kg

B	A	MAX		4.0 m		3.0 m		2.0 m	
		Cf	Cs	Cf	Cs	Cf	Cs	Cf	Cs
Arm length 1370 mm Blade on ground									
4.0 m		*705	635			*715	*715		
3.0 m		*700	420	*720	440	*710	*710		
2.0 m		*720	350	*775	435	*965	700		
1.0 m		*855	370	*890	420	*1300	655		
0 m		*895	385	*945	410	*1445	630	*2630	1190
-1.0 m		*930	455			*1335	630	*2260	1205
-2.0 m		*900	710					*1455	1245

B	A	MAX		3.0 m		2.5 m		2.0 m	
		Cf	Cs	Cf	Cs	Cf	Cs	Cf	Cs
Arm length 1720 mm Blade on ground									
4.0 m		*630	535			*700	480		
3.0 m		*640	385	*625	455				
2.0 m		*665	325	*700	445	*820	720		
1.0 m		*700	305	*840	430	*1190	670		
0 m		*745	315	*935	415	*1420	635	*2780	1190
-1.0 m		*795	365	*910	410	*1400	630	*2515	1195
-2.0 m		*845	525			*1085	640	*1870	1225

* Load is limited by hydraulic capacity rather than tipping.

Ratings are based on ISO standard 10567. Rated loads do not exceed 87% of hydraulic lift capacity or 75% of tipping load.

PC45MR-3Conditions: Boom: 2630 mm (8'8"), Bucket (SAE): 0.14 m³ (0.18 cu.yd), Shoes: 400 mm (16") unit: kg (lb)

B	A	MAX		4.0 m (13')		3.0 m (10')		2.0 m (7')	
		Cf	Cs	Cf	Cs	Cf	Cs	Cf	Cs
Arm length 1375 mm (4'6") Blade on ground with additional counterweight (X-weight)									
3.0 m (10')		*1020 (2250)	585 (1290)	*990 (2180)	705 (1550)	*990 (2180)	*990 (2180)		
2.0 m (7')		*1060 (2340)	500 (1100)	*1155 (2550)	690 (1520)	*1530 (3370)	1100 (2430)		
1.0 m (3')		*1120 (2470)	480 (1060)	*1380 (3040)	660 (970)	*2125 (4690)	1025 (2260)		
0 m (0')		*1195 (2640)	505 (1110)	*1505 (3310)	640 (1410)	*2345 (5170)	995 (2190)		
-1.0 m (3')		*1280 (2820)	600 (1320)	*1400 (3090)	640 (1410)	*2195 (4840)	995 (2190)	*3010 (6640)	1965 (4330)

* Load is limited by hydraulic capacity rather than tipping.

Ratings are based on SAE Standard NO. J1097. Rated loads do not exceed 87% of hydraulic lift capacity or 75% of tipping load.

PC45MR-3 (Italy source)

Conditions:

Boom: 2630 mm, Bucket (SAE): 0.15 m³, Shoes: 400 mm

unit: kg

B	A	MAX		4.0 m		3.0 m		2.0 m	
		Cf	Cs	Cf	Cs	Cf	Cs	Cf	Cs
Arm length 1375 mm Blade on ground									
4.0 m		*1005	775						
3.0 m		*1020	555	*990	670	*990	*990		
2.0 m		*1060	475	*1165	655	*1530	1050		
1.0 m		*1120	450	*1380	625	*2125	975		
0 m		*1195	475	*1505	605	*2345	940		
-1.0 m		*1280	570	*1400	605	*2195	945	*3010	1875
-2.0 m		*1340	900			*1505	975	*2635	1935
Arm length 1770 mm Blade on ground									
4.0 m		*855	615	*805	675				
3.0 m		*880	465	*810	680				
2.0 m		*925	405	*1000	655	*1220	1070		
1.0 m		*980	385	*1260	625	*1895	985		
0 m		*1045	405	*1450	595	*2275	930	*1250	*1250
-1.0 m		*1125	470	*1465	585	*2275	920	*2410	*2410
-2.0 m		*1215	655			*1865	935	*3355	1870

* Load is limited by hydraulic capacity rather than tipping.

Ratings are based on ISO standard 10567. Rated loads do not exceed 87% of hydraulic lift capacity or 75% of tipping load.

PC55MR-3

Conditions:

Boom: 2900 mm (9'6"), Bucket (SAE): 0.16 m³ (0.21 cu.yd), Shoes: 400 mm (16")

unit: kg (lb)

B	A	MAX		4.0 m (13')		3.0 m (10')		2.0 m (7')	
		Cf	Cs	Cf	Cs	Cf	Cs	Cf	Cs
Arm length 1640 mm (5'5") Blade on ground with additional counterweight (X-weight)									
3.0 m (10')		*850 (1870)	500 (1100)	*845 (1860)	750 (1650)				
2.0 m (7')		*885 (1950)	440 (970)	*1050 (2320)	720 (1590)	*1435 (3160)	1140 (2510)		
1.0 m (3')		*930 (2050)	420 (930)	*1285 (2830)	680 (1500)	*2030 (4480)	1045 (2300)		
0 m (0')		*985 (2170)	435 (960)	*1435 (3160)	655 (1440)	*2260 (4980)	1005 (2220)		
-1.0 m (3')		*1050 (2320)	500 (1100)	*1415 (3120)	645 (1420)	*2170 (4780)	1000 (2200)	*2790 (6150)	1960 (4320)

* Load is limited by hydraulic capacity rather than tipping.

Ratings are based on SAE Standard NO. J1097. Rated loads do not exceed 87% of hydraulic lift capacity or 75% of tipping load.

PC55MR-3 (Italy source)

Conditions:

Boom: 2900 mm, Bucket (SAE): 0.15 m³, Shoes: 400 mm

unit: kg

B	A	MAX		4.0 m		3.0 m		2.0 m	
		Cf	Cs	Cf	Cs	Cf	Cs	Cf	Cs
Arm length 1640 mm Blade on ground									
4.0 m		*835	670	*790	780				
3.0 m		*850	520	*845	775				
2.0 m		*885	460	*1050	745	*1435	1180		
1.0 m		*930	440	*1285	705	*2030	1085		
0 m		*985	455	*1435	680	*2260	1040		
-1.0 m		*1050	520	*1415	670	*2170	1040	*2790	2025
-2.0 m									

B	A	MAX		4.0 m		3.0 m		2.0 m	
		Cf	Cs	Cf	Cs	Cf	Cs	Cf	Cs
Arm length 2000 mm Blade on ground									
4.0 m		*730	565	*625	625				
3.0 m		*750	450	*700	700				
2.0 m		*785	400	*915	750	*1160	1160		
1.0 m		*825	385	*1175	705	*1815	1095		
0 m		*875	395	*1375	670	*2180	1030	*1285	*1285
-1.0 m		*935	445	*1420	655	*2205	1015	*2365	1975
-2.0 m									

* Load is limited by hydraulic capacity rather than tipping.
 Ratings are based on ISO standard 10567. Rated loads do not exceed 87% of hydraulic lift capacity or 75% of tipping load.

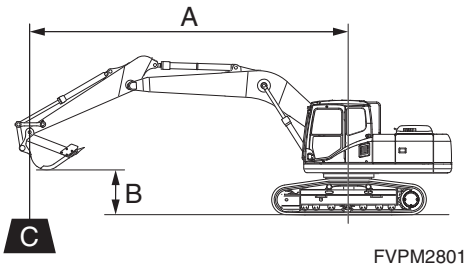

- A : Reach from swing center
 B : Bucket hook height
 C : Lifting capacity
 Cf : Rating over front
 Cs : Rating over side
 MAX: Rating at maximum reach

PC70-8

Conditions:

Boom: 3710 mm (12'2"), Bucket (SAE): 0.30 m³ (0.39 cu.yd), Shoes: 450 mm (18") unit: kg (lb)

B	A	MAX		5.0 m (16')		4.0 m (13')		3.0 m (10')		2.0 m (7')	
		Cf	Cs	Cf	Cs	Cf	Cs	Cf	Cs	Cf	Cs
Arm length 1650 mm (5'5") Without blade											
4.0 m (13')		1380 (3040)	1010 (2230)			*1400 (3090)	1320 (2910)	*1540 (3400)	*1540 (3400)		
3.0 m (10')		1140 (2510)	830 (1830)	1150 (2540)	830 (1830)	*1230 (2710)	*1230 (2710)	*1910 (4210)	*1910 (4210)	*2770 (6110)	*2770 (6110)
2.0 m (7')		1040 (2290)	750 (1650)	1140 (2510)	820 (1810)	1690 (3730)	1230 (2710)	*2390 (5270)	1980 (4370)		
1.0 m (3')		1010 (2230)	720 (1590)	1110 (2430)	800 (1760)	1620 (3570)	1170 (2580)	2600 (5732)	1850 (4080)		
0 m (0')		1050 (2320)	750 (1650)	1090 (2400)	780 (1720)	1580 (3480)	1130 (2490)	2520 (5560)	1780 (3920)		
-1.0 m (-3')		1190 (2620)	850 (1870)			1560 (3440)	1120 (2470)	2510 (5530)	1760 (3880)	*3740 (8250)	3540 (7800)
-2.0 m (-7')		1530 (3370)	1100 (2430)			*1510 (3330)	1130 (2490)	*2240 (4940)	1790 (3950)	*3110 (6860)	*3110 (6860)
Arm length 1650 mm (5'5") Blade on ground											
4.0 m (13')		*1390 (3060)	990 (2180)			*1400 (3090)	1300 (2870)	*1540 (3400)	*1540 (3400)		
3.0 m (10')		*1380 (3040)	810 (1790)	*1380 (3040)	820 (1810)	*1230 (2710)	*1230 (2710)	*1910 (4210)	*1910 (4210)	*2770 (6110)	*2770 (6110)
2.0 m (7')		*1390 (3060)	730 (1610)	*1440 (3180)	800 (1760)	*1760 (3880)	1210 (2670)	*2390 (5270)	1950 (4300)		
1.0 m (3')		*1410 (3110)	700 (1540)	*1510 (3330)	780 (1720)	*1940 (4280)	1150 (2540)	*2730 (6020)	1810 (3990)		
0 m (0')		*1440 (3180)	730 (1610)	*1500 (3310)	760 (1680)	*2010 (4430)	1110 (2450)	*2810 (6200)	1750 (3860)		
-1.0 m (-3')		*1460 (3220)	830 (1830)			*1910 (4210)	1090 (2400)	*2660 (5860)	1730 (3810)	*3740 (8250)	*3740 (8250)
-2.0 m (-7')		*1440 (3180)	1080 (2380)			*1510 (3330)	1110 (2450)	*2240 (4940)	1760 (3880)	*3110 (6860)	*3110 (6860)
Arm length 1650 mm (5'5") Blade above ground											
4.0 m (13')		*1390 (3060)	990 (2180)			*1400 (3090)	1300 (2870)	*1540 (3400)	*1540 (3400)		
3.0 m (10')		1150 (2530)	810 (1790)	1150 (2530)	820 (1810)	*1230 (2710)	*1230 (2710)	*1910 (4210)	*1910 (4210)	*2770 (6110)	*2770 (6110)
2.0 m (7')		1040 (2290)	730 (1610)	1140 (2510)	800 (1760)	1690 (3720)	1210 (2670)	*2390 (5270)	1950 (4300)		
1.0 m (3')		1010 (2220)	700 (1540)	1120 (2470)	780 (1720)	1630 (3590)	1150 (2540)	2610 (5750)	1810 (3990)		
0 m (0')		1050 (2310)	730 (1610)	1100 (2420)	760 (1680)	1580 (3480)	1110 (2450)	2540 (5600)	1750 (3860)		
-1.0 m (-3')		1200 (2640)	830 (1830)			1570 (3460)	1090 (2400)	2520 (5550)	1730 (3810)	*3740 (8250)	*3740 (8250)
-2.0 m (-7')		*1440 (3180)	1080 (2380)			*1510 (3330)	1110 (2450)	*2240 (4940)	1760 (3880)	*3110 (6860)	*3110 (6860)

* Load is limited by hydraulic capacity rather than tipping.

Ratings are based on ISO standard No. 10567. Rated loads do not exceed 87% of hydraulic lift capacity or 75% of tipping load.

PC78US-8

Conditions:

Boom: 3710 mm (12'2"), Bucket (SAE): Shoes: 450 mm (18")

unit: kg (lb)

B	A	MAX		4.5 m (14')		3.0 m (9')		1.5 m (4')	
		Cf	Cs	Cf	Cs	Cf	Cs	Cf	Cs
Arm length 1650 mm (5'5") Bucket (SAE): 0.28m ³ (0.37 cu.yd) Blade less									
5.0 m (16')		*1780 (3920)	1430 (3150)			*1790 (3960)	*1790 (3960)		
3.0 m (9')		1160 (2550)	860 (1910)	1500 (3320)	1130 (2500)	*2300 (5070)	2280 (5030)		
0.0 m (0')		1050 (2310)	760 (1690)	1370 (3020)	1000 (2220)	2650 (5850)	1900 (4200)		
-2.0 m (-6')		1440 (3170)	1050 (2330)	1360 (3010)	1000 (2210)	*2360 (5810)	1890 (4180)	*4060 (8960)	*4060 (8960)
Arm length 2250 mm (7'5") Bucket (SAE): 0.2m ³ (0.26 cu.yd) Blade less									
5.0 m (16')		*1420 (3140)	1090 (2420)	*1490 (3290)	1200 (2650)				
3.0 m (9')		980 (2160)	720 (1600)	1540 (3400)	1170 (2580)	*1870 (4130)	*1870 (4130)		
0.0 m (0')		880 (1950)	640 (1410)	1370 (3020)	1000 (2220)	2660 (5880)	1920 (4230)		
-2.0 m (-6')		1120 (2490)	820 (1810)	1330 (2930)	960 (2130)	2590 (5710)	1850 (4070)	*4230 (9330)	*4230 (9330)
Arm length 1650 mm (5'5") Bucket (SAE): 0.28m ³ (0.37 cu.yd) Blade on ground									
5.0 m (16')		*1780 (3920)	1500 (3310)			*1790 (3960)	*1790 (3960)		
3.0 m (9')		*1670 (3680)	910 (2020)	*1780 (3930)	1190 (2640)	*2300 (5070)	*2300 (5070)		
0.0 m (0')		*1710 (3770)	810 (1800)	*2120 (4680)	1060 (2350)	*3360 (7410)	2010 (4430)		
-2.0 m (-6')		*1650 (3650)	1120 (2460)	1510 (3330)	1060 (2340)	*2710 (5980)	2000 (4410)	*4060 (8960)	*4060 (8960)
Arm length 2250 mm (7'5") Bucket (SAE): 0.2m ³ (0.26 cu.yd) Blade on ground									
5.0 m (16')		*1420 (3140)	1150 (2540)	*1490 (3290)	1260 (2780)				
3.0 m (9')		*1350 (2990)	770 (1700)	*1570 (3470)	1230 (2710)	*1870 (4130)	*1870 (4130)		
0.0 m (0')		*1520 (3360)	680 (1510)	*2090 (4600)	1060 (2350)	*3320 (7330)	2020 (4460)		
-2.0 m (-6')		*1540 (3400)	870 (1920)	*1880 (4140)	1020 (2260)	*3010 (6640)	1950 (4300)	*4230 (9330)	*4230 (9330)

* Load is limited by hydraulic capacity rather than tipping.

Ratings are based on SAE Standard NO. J1097. Rated loads do not exceed 87% of hydraulic lift capacity or 75% of tipping load.

PC71-7 (India source)

Conditions:

Boom: 3710 mm, Bucket (SAE): 0.30 m³, Shoes: 450 mm

unit: kg

B	A	MAX		5.5 m		4.5 m		3.0 m		1.5 m	
		Cf	Cs	Cf	Cs	Cf	Cs	Cf	Cs	Cf	Cs
Arm length 1650 mm (5'5") Without blade											
6.0 m		*1550	*1550								
4.5 m		*1350	1300					*1300	*1300		
3.0 m		1050	900			1400	1200	*1800	*1800	*3150	*3150
1.5 m		950	800			1350	1150	*2500	2200		
0 m		950	800			1250	1050	2400	2000		
-1.5 m		1200	1000			1250	1050	2400	1950	*4500	*4500
-3.0 m		*1400	*1400					*1600	1600		

* Load is limited hydraulic capacity rather than tipping.

Ratings are based on SAE Standard No. J1097. Rated loads do not exceed 87% of hydraulic lift capacity or 75% of tipping load.

PC80MR-3

Conditions:

One piece boom: Bucket (SAE): 0.2 m³, Shoes: 450 mm

unit: kg

B	A	MAX		5.0 m		4.0 m		3.0 m	
		Cf	Cs	Cf	Cs	Cf	Cs	Cf	Cs
Arm length 1650 mm With blade on ground									
4.5 m		*1560	1090			*1470	*1460		
3.0 m		*1580	770	*1600	940	*1770	1390		
1.5 m		*1640	680	*1890	880	*2480	1260		
0.0 m		*1730	710	*2050	840	*2840	1180		
-1.5 m		*1830	910			*2510	1180		
Arm length 1650 mm With blade on ground Add. counterweight 230 kg									
4.5 m		*1560	1140			*1470	*1460	*1300	*1300
3.0 m		*1580	820	*1600	990	*1770	1460	*2180	*2180
1.5 m		*1640	720	*1890	940	*2480	1330	*3640	2040
0.0 m		*1730	750	*2050	890	*2840	1250	*4260	1930
-1.5 m		*1830	960			*2510	1250	*3700	1960
Arm length 2000 mm With blade on ground									
4.5 m		*1400	930	*1380	950	*1200	*1200	*900	*900
3.0 m		*1330	680	*1440	950	*1540	1410	*1690	*1690
1.5 m		*1410	610	*1770	890	*2290	1280	*3670	1990
0.0 m		*1580	630	*2020	830	*2790	1170	*4300	1820
-1.5 m		*1690	780	*1840	820	*2640	1150	*3960	1820
Arm length 2000 mm With blade on ground Add. counterweight 230 kg									
4.5 m		*1400	980	*1380	1010	*1200	1200	*900	*900
3.0 m		*1330	730	*1440	1000	*1540	1480	*1690	*1690
1.5 m		*1410	650	*1770	940	*2290	1350	*3670	2090
0.0 m		*1580	670	*2020	880	*2790	1240	*4300	1920
-1.5 m		*1690	830	*1840	870	*2640	1220	*3960	1920

* Load is limited by hydraulic capacity rather than tipping.

Ratings are based on ISO Standard NO. 10567. Rated loads do not exceed 87% of hydraulic lift capacity or 75% of tipping load.

PC88MR-8

Conditions:

Boom: 3405 mm (11'2"), Shoes: 450 mm (18")

unit: kg (lb)

B	A	MAX		4.5 m (14')		3.0 m (9')		1.5 m (4')	
		Cf	Cs	Cf	Cs	Cf	Cs	Cf	Cs
Arm length 1650 mm (5'5") Bucket (SAE): 0.28 m ³ (0.37 cu.yd) With blade on ground									
5.0 m (16')		*1520 (3360)	1250 (2750)						
3.0 m (9')		*1650 (3630)	790 (1760)	*1760 (3890)	1280 (2820)				
0 m (0')		*2210 (4890)	730 (1610)	*3060 (6740)	1100 (2440)	*3520 (7760)	2040 (4510)		
-2.0 m (6')		*2770 (6110)	1040 (2290)	*2960 (6530)	1100 (2420)	*5210 (11490)	2070 (4570)	*6110 (13480)	*4930 (10870)
Arm length 1650 mm (5'5") Bucket (SAE): 0.28 m ³ (0.37 cu.yd) With blade on ground and additional counterweight									
5.0 m (16')		*1520 (3360)	1340 (2970)						
3.0 m (9')		*1640 (3630)	870 (1920)	*1760 (3880)	1380 (3050)				
0 m (0')		*2210 (4880)	800 (1770)	*3060 (6740)	1210 (2670)	*3520 (7760)	2220 (4900)		
-2.0 m (6')		*2770 (6100)	1130 (2510)	*2960 (6530)	1200 (2650)	*5210 (11490)	2250 (4960)	*6110 (13480)	*4930 (10870)
Arm length 2100 mm (6'11") Bucket (SAE): 0.20 m ³ (0.26 cu.yd) With blade on ground									
5.0 m (16')		*1310 (2890)	1040 (2300)						
3.0 m (9')		*1430 (3170)	690 (1530)	*1430 (3160)	1290 (2850)				
0 m (0')		*1940 (4280)	620 (1380)	*2860 (6300)	1070 (2370)	*3980 (8770)	1990 (4400)		
-2.0 m (6')		*2460 (5430)	840 (1850)	*3060 (6750)	1040 (2290)	*5440 (12000)	1980 (4370)	*4870 (10730)	*3950 (8720)
Arm length 2100 mm (6'11") Bucket (SAE): 0.20 m ³ (0.26 cu.yd) With blade on ground and additional counterweight									
5.0 m (16')		*1310 (2890)	1130 (2490)						
3.0 m (9')		*1430 (3170)	760 (1680)	*1430 (3160)	1390 (3080)				
0 m (0')		*1940 (4280)	690 (1530)	*2860 (6300)	1180 (2600)	*3980 (8770)	2170 (4790)		
-2.0 m (6')		*2460 (5430)	920 (2040)	*3060 (6750)	1140 (2520)	*5440 (12000)	2160 (4760)	*4870 (10730)	*3950 (8720)

* Load is limited by hydraulic capacity rather than tipping.

Ratings are based on SAE Standard NO. J1097. Rated loads do not exceed 87% of hydraulic lift capacity or 75% of tipping load.

PC88MR-8 (Itary source)

Conditions:

One-piece boom: 3405 mm, Bucket (SAE): 0.28 m³, Shoes: 450 mm

unit: kg

B	A	MAX		4.5 m		3.0 m		1.5 m	
		Cf	Cs	Cf	Cs	Cf	Cs	Cf	Cs
Arm length 1650 mm With blade on ground									
	5.0 m	*1520	1250						
	3.0 m	*1650	790	*1760	1280				
	0.0 m	*2210	730	*3060	1100	*3520	2040		
	-2.0 m	*2770	1040	*2960	1100	*5210	2070	*6110	*4930
Arm length 1650 mm With blade on ground and additional counterweight									
	5.0 m	*1520	1340						
	3.0 m	*1640	870	*1760	1380				
	0.0 m	*2210	800	*3060	1100	*3520	2220		
	-2.0 m	*2770	1130	*2960	1100	*5210	2250	*6110	*4930
Arm length 2100 mm With blade on ground									
	5.0 m	*1310	1040						
	3.0 m	*1430	690	*1430	1290				
	0.0 m	*1940	620	*2860	1070	*3980	1990		
	-2.0 m	*2460	840	*3060	1040	*5440	1980	*4870	*3950
Arm length 2100 mm With blade on ground and additional counterweight									
	5.0 m	*1310	1130						
	3.0 m	*1430	760	*1430	1390				
	0.0 m	*1940	690	*2860	1180	*3980	2170		
	-2.0 m	*2460	920	*3060	1140	*5440	2160	*4870	*3950
Arm length 1650 mm With blade above ground									
	5.0 m	1520	1250						
	3.0 m	980	790	1560	1280				
	0.0 m	910	730	1380	1100	2630	2040		
	-2.0 m	1300	1040	1370	1100	*2660	2070	*4930	*4930
Arm length 1650 mm With blade on ground and additional counterweight									
	5.0 m	*1520	1340						
	3.0 m	1060	870	1680	1380				
	0.0 m	990	800	1500	1210	2850	2220		
	-2.0 m	1410	1130	1490	1200	2880	2250	*4930	*4930
Arm length 2100 mm With blade above ground									
	5.0 m	1270	1040						
	3.0 m	860	690	*1430	1290				
	0.0 m	790	620	1350	1070	2580	1990		
	-2.0 m	1060	840	1310	1040	2570	1980	*3950	*3950
Arm length 2100 mm With blade above ground and additional counterweight									
	5.0 m	*1310	1130						
	3.0 m	940	760	*1430	1390				
	0.0 m	870	690	1470	1180	2800	2170		
	-2.0 m	1160	930	1430	1140	2780	2160	*3950	*3950

* Load is limited hydraulic capacity rather than tipping.
Ratings are based on ISO Standard No.10567. Rated loads do not exceed 87% of hydraulic lift capacity or 75% of tipping load.

PC88MR-8 (Itary source)

Conditions:

Two-piece boom: 3405 mm, Bucket (SAE): 0.28 m³, Shoes: 450 mm

unit: kg

B	A	MAX		4.5 m		3.0 m		1.5 m	
		Cf	Cs	Cf	Cs	Cf	Cs	Cf	Cs
Arm length 1650 mm With blade on ground									
	5.0 m	*1840	760						
	3.0 m	*1650	520	*2170	1130				
	0.0 m	*1670	500	*2980	920				
	-2.0 m	*1500	700	*2510	950	*3890	1860		
Arm length 1650 mm With blade on ground and additional counterweight									
	5.0 m	*1840	840						
	3.0 m	*1650	590	*2170	1240				
	0.0 m	*1670	570	*2980	1030				
	-2.0 m	*1500	780	*2510	1050	*3890	2040		
Arm length 1900 mm With blade on ground									
	5.0 m	*1730	690						
	3.0 m	*1520	490	*2050	1150				
	0.0 m	*1610	460	*2960	920				
	-2.0 m	*1480	640	*2620	920	*4110	1810		
Arm length 1900 mm With blade on ground and additional counterweight									
	5.0 m	*1730	770						
	3.0 m	*1520	550	*2050	125				
	0.0 m	*1610	530	*2960	1020				
	-2.0 m	*1480	710	*2620	1030	*4110	1990		
Arm length 1650 mm With blade above ground									
	5.0 m	960	760						
	3.0 m	680	520	1430	1130				
	0.0 m	660	500	1200	920				
	-2.0 m	900	700	1230	950	2460	1860		
Arm length 1650 mm With blade on ground and additional counterweight									
	5.0 m	1050	840						
	3.0 m	750	590	1540	1240				
	0.0 m	730	570	1320	1030				
	-2.0 m	990	780	1350	1050	2670	2040		
Arm length 1900 mm With blade above ground									
	5.0 m	880	690						
	3.0 m	640	490	1440	1150				
	0.0 m	620	460	1200	920				
	-2.0 m	820	640	1200	920	2410	1810		
Arm length 1900 mm With blade above ground and additional counterweight									
	5.0 m	970	770						
	3.0 m	710	550	1560	1250				
	0.0 m	690	530	1310	1020				
	-2.0 m	910	710	1320	1030	2620	1990		

* Load is limited hydraulic capacity rather than tipping.
Ratings are based on ISO Standard No.10567. Rated loads do not exceed 87% of hydraulic lift capacity or 75% of tipping load.

PC118MR-8 (Itary source)

Conditions:

One-piece boom, Bucket (SAE): 0.38 m³, Shoes: 500 mm

unit: kg

B	A	MAX		6.0 m		4.5 m		3.0 m		1.5 m	
		Cf	Cs	Cf	Cs	Cf	Cs	Cf	Cs	Cf	Cs
Arm length 1850 mm											
4.5 m		*1730	1460								
3.0 m		1420	1190	1580	1320	*2060	*2060				
1.5 m		1330	1110	1520	1260	2430	1960				
0 m		1390	1160	1470	1220	2320	1860	*3300	3300		
-1.5 m		1700	1400			2300	1850	4540	3320	*6090	*6090
Arm length 1850 mm With additional counterweight: 388 kg											
4.5 m		*1730	1590								
3.0 m		1570	1310	1740	1440	*2060	*2060				
1.5 m		1470	1220	1680	1390	2660	2130				
0 m		1540	1270	1640	1350	2550	2030	*3300	3300		
-1.5 m		1880	1540			2530	2020	4970	3600	*6090	*6090
Arm length 2000 mm											
4.5 m		*1590	1380	*1560	1340						
3.0 m		1360	1140	1580	1320	*1910	*1910				
1.5 m		1270	1060	1510	1260	2430	1960				
0 m		1320	1100	1460	1210	2310	1850	*3380	3270		
-1.5 m		1600	1320			2280	1830	4500	3290	*5480	*5480
Arm length 2000 mm With additional counterweight: 388 kg											
4.5 m		*1590	1500	*1560	1460						
3.0 m		1500	1250	1740	1440	*1910	*1910				
1.5 m		1410	1170	1670	1380	2660	2130				
0 m		1470	1210	1620	1330	2540	2020	*3380	*3380		
-1.5 m		1780	1450			2510	2000	4930	3570	*5480	*5480
Arm length 2300 mm											
4.5 m		*1360	1260	*1390	1350					*1630	*1630
3.0 m		1250	1050	1580	1320	*1620	*1620				
1.5 m		1170	980	1510	1250	2440	1960				
0 m		1220	1010	1450	1200	2300	1840	*3560	3250		
-1.5 m		1440	1190	1440	1190	2250	1790	4440	3230	*3370	*3370
Arm length 2300 mm With additional counterweight: 388 kg											
4.5 m		*1360	*1360	*1390	*1390					*1630	*1630
3.0 m		*1370	1160	*1600	1440	*1620	*1620				
1.5 m		1310	1080	1670	1370	2650	2130				
0 m		1360	1120	1610	1320	2530	2010	*3560	3530		
-1.5 m		1600	1310	1600	1310	2480	1960	4880	3520	*3770	*3770

* Load is limited hydraulic capacity rather than tipping.

Ratings are based on ISO Standard No.10567. Rated loads do not exceed 87% of hydraulic lift capacity or 75% of tipping load.

PC130-8

Conditions:

Boom: 4600 mm (15'1"), Bucket (SAE): 0.50 m³ (0.65 cu.yd), Shoes: 500 mm (20")

unit: kg (lb)

B	A	MAX		6.1 m (20')		4.6 m (15')		3.0 m (10')		1.5 m (5')	
		Cf	Cs	Cf	Cs	Cf	Cs	Cf	Cs	Cf	Cs
Arm length 2500 mm (8'2")											
6.1 m (20')		*1950 (4300)	*1950 (4300)								
4.6 m (15')		*1800 (4000)	1650 (3600)	2850 (6200)	1950 (4300)	*3100 (6900)	*3100 (6900)				
3.0 m (10')		*1800 (4000)	1400 (3100)	2750 (6100)	1900 (4200)	*3900 (8600)	3100 (6900)	*5000 (11100)	*5000 (11100)		
1.5 m (5')		1950 (4300)	1300 (2800)	2700 (5900)	1800 (4000)	4300 (9500)	2900 (6400)	*7700 (17000)	5500 (12100)		
0 m (0')		1950 (4400)	1300 (2900)	2600 (5700)	1700 (3800)	4100 (9100)	2700 (6000)	8350 (18400)	5100 (11200)		
-1.5 m (-5')		2200 (4800)	1450 (3200)	2550 (5600)	1700 (3700)	3900 (8600)	2500 (5600)	8200 (18100)	5000 (11000)	*4750 (10400)	*4750 (10400)
-3.0 m (-10')		2800 (6200)	1850 (4100)			4050 (8900)	2650 (5800)	*7850 (17400)	5050 (11100)	*8000 (17700)	*8000 (17700)
Arm length 3000 mm (9'10")											
6.1 m (20')		*1500 (3400)	*1500 (3400)	*1850 (4100)	*1850 (4100)						
4.6 m (15')		*1400 (3100)	1400 (3100)	*2700 (6000)	1950 (4300)						
3.0 m (10')		*1400 (3100)	1200 (2600)	2750 (6100)	1900 (4200)	*3400 (7400)	3150 (6900)				
1.5 m (5')		*1500 (3300)	1100 (2400)	2650 (5900)	1800 (3900)	4350 (9600)	2900 (6400)	*6650 (14700)	5500 (12100)		
0 m (0')		1700 (3800)	1100 (2400)	2550 (5600)	1700 (3700)	4100 (9000)	2700 (5900)	8350 (18400)	5050 (11200)		
-1.5 m (-5')		1900 (4100)	1200 (2700)	2500 (5500)	1600 (3600)	3850 (8500)	2450 (5400)	8100 (17800)	4850 (10700)	*4150 (9100)	*4150 (9100)
-3.0 m (-10')		2300 (5100)	1500 (3300)	2500 (5500)	1600 (3600)	3900 (8600)	2550 (5600)	8100 (17900)	4850 (10700)	*6750 (14900)	*6750 (14900)

* Load is limited by hydraulic capacity rather than tipping.

Ratings are based on SAE Standard NO. J1097. Rated loads do not exceed 87% of hydraulic lift capacity or 75% of tipping load.

PC130-8 (UK source)

Conditions:

Mono boom: 4600 mm (15'1"), Bucket (SAE): 0.56 m³ (0.73 cu.yd), Shoes: 700 mm (27.6") unit: kg (lb)

B	A	MAX		6.0 m (20')		4.5 m (15')		3.0 m (10')		1.5 m (5')	
		Cf	Cs	Cf	Cs	Cf	Cs	Cf	Cs	Cf	Cs
Arm length 2100 mm (6'11")											
6.0 m (20')		*2400 (5300)	*2400 (5300)			*3400 (7500)	*3400 (7500)				
4.5 m (15')		*2250 (4950)	2000 (4400)	2950 (6500)	2200 (4850)	*3550 (7800)	*3550 (7800)				
3.0 m (10')		*2250 (4950)	1700 (3750)	2950 (6500)	2150 (4700)	*4350 (9550)	3450 (7600)	*6000 (13200)	*6000 (13200)		
1.5 m (5')		2200 (4850)	1550 (3400)	2850 (6250)	2050 (4500)	4550 (10000)	3250 (7150)	*8550 (18800)	6000 (13200)		
0 m (0')		2250 (4950)	1600 (3500)	2750 (6050)	2000 (4400)	4250 (9350)	3050 (6700)	*7400 (16300)	5650 (12450)		
-1.5 m (-5')		2550 (5600)	1800 (3950)	2750 (6050)	1950 (4300)	4150 (9100)	3000 (6600)	8750 (19250)	5600 (12300)	*4750 (10450)	*4750 (10450)
-3.0 m (-10')		3300 (7250)	2350 (5150)			4300 (9450)	3000 (6600)	*7550 (16600)	5750 (12650)	*8800 (19350)	*8800 (19350)
Arm length 2500 mm (8'2")											
6.0 m (20')		*1950 (4300)	*1950 (4300)								
4.5 m (15')		*1800 (3950)	1700 (3750)	3000 (6600)	2250 (4950)	*3150 (6900)	*3150 (6900)				
3.0 m (10')		*1850 (4050)	1550 (3400)	2950 (6500)	2200 (4850)	*3950 (8700)	3550 (7800)	*5200 (11450)	*5200 (11450)		
1.5 m (5')		*1950 (4300)	1450 (3200)	2850 (6250)	2100 (4600)	4550 (10000)	3300 (7250)	*7900 (17400)	6150 (13500)		
0 m (0')		2050 (4500)	1450 (3200)	2750 (6050)	2000 (4400)	4250 (9350)	3000 (6600)	*8050 (17700)	5700 (12550)		
-1.5 m (-5')		2250 (4950)	1600 (3500)	2700 (5950)	1950 (4300)	4250 (9350)	3000 (6600)	8700 (19150)	5600 (12300)	*4700 (10350)	*4700 (10350)
-3.0 m (-10')		2850 (6250)	2050 (4500)			4250 (9350)	2950 (6500)	*8050 (17700)	5700 (12550)	*7850 (17250)	*7850 (17250)
Arm length 3000 mm (9'10")											
6.0 m (20')		*1550 (3400)	*1550 (3400)	*2200 (4850)	2250 (4950)						
4.5 m (15')		*1450 (3200)	1450 (3200)	*2750 (6050)	2250 (4950)						
3.0 m (10')		*1450 (3200)	1350 (2950)	2950 (6500)	2200 (4850)	*3450 (7600)	*3450 (7600)				
1.5 m (5')		*1550 (3400)	1250 (2750)	2800 (6150)	2050 (4500)	*4550 (10000)	3300 (7250)	*6800 (14950)	6250 (13750)		
0 m (0')		*1750 (3850)	1250 (2750)	2700 (5950)	1950 (4300)	4300 (9450)	3050 (6700)	8800 (19350)	5650 (12400)		
-1.5 m (-5')		1950 (4300)	1350 (2950)	2650 (5800)	1850 (4050)	4050 (8900)	2900 (6400)	8550 (18800)	5450 (12000)	*4100 (9000)	*4100 (9000)
-3.0 m (-10')		2350 (5150)	1650 (3600)	2600 (5700)	1850 (4050)	4050 (8900)	2900 (6400)	*8450 (18600)	5500 (12100)	*6650 (14600)	*6650 (14600)

* Load is limited by hydraulic capacity rather than tipping.
 Ratings are based on SAE Standard NO. J1097. Rated loads do not exceed 87% of hydraulic lift capacity or 75% of tipping load.

PC130-8 (Brazil source)

Conditions:

Boom: 4600 mm, Bucket(SAE): 0.60 m³ Shoes: 700 mm

unit: kg

B	A	MAX		6.0 m		4.5 m		3.0 m		1.5 m	
		Cf	Cs	Cf	Cs	Cf	Cs	Cf	Cs	Cf	Cs
Arm length 2500 mm											
6.0 m		*1950	*1950								
4.5 m		*1800	1700	3000	2250	*3150	*3150				
3.0 m		*1850	1550	2950	2200	*3950	3550	*5200	*5200		
1.5 m		*1950	1450	2850	2100	4550	3300	*7900	6150		
0 m		2050	1450	2750	2000	4250	3000	*8050	5700		
-1.5 m		2250	1600	2700	1950	4250	3000	8700	5600	*4700	*4700
-3.0 m		2850	2050			4250	2950	*8050	5700	*7850	*7850

* Load is limited hydraulic capacity rather than tipping.
Ratings are based on SAE Standard No. J1097. Rated loads do not exceed 87% of hydraulic lift capacity or 75% of tipping load.

PC130-7 (India source)

Conditions:

Boom: 4600 mm, Bucket(SAE): 0.64 m³ Shoes: 500 mm

unit: kg

B	A	MAX		6.0 m		4.5 m		3.0 m		1.5 m	
		Cf	Cs	Cf	Cs	Cf	Cs	Cf	Cs	Cf	Cs
Arm length 2100 mm											
6.0 m		*2600	2350			*3150	3050				
4.5 m		*2400	1650	2600	1750	*3300	3000				
3.0 m		2050	1350	2600	1700	*4000	2850	*5600	*5600		
1.5 m		1900	1200	2500	1600	4000	2600	*6300	4850		
0 m		1950	1250	2400	1500	3800	2400	*5800	4500		
-1.5 m		2200	1400	2350	1500	3700	2350	*5850	4450	*5450	*5450
-3.0 m		2900	1850			3750	2350	*6400	4550	*5800	*5800

* Load is limited hydraulic capacity rather than tipping.
Ratings are based on SAE Standard No. J1097. Rated loads do not exceed 87% of hydraulic lift capacity or 75% of tipping load.

PC138US-8

Conditions:

Boom: 4600 mm (15'1"), Bucket (SAE) 0.50 m³ (0.65 cu.yd), Shoes: 500 mm (20")

unit: kg (lb)

B	A	MAX		6.1 m (20')		4.6 m (15')		3.0 m (10')	
		Cf	Cs	Cf	Cs	Cf	Cs	Cf	Cs
Arm length 2100 mm (6'11")									
6.1 m (20')		*2100 (4650)	*2100 (4650)			*3240 (7150)	3120 (6890)		
3.0 m (10')		*1950 (4310)	1510 (3340)	2850 (6290)	1810 (4000)	*4630 (10220)	2940 (6500)	*6480 (14300)	5720 (12620)
0.0 m (0')		2310 (5090)	1420 (3140)	2700 (5950)	1670 (3680)	4240 (9360)	2590 (5710)	*5570 (12280)	4800 (10590)
-3.0 m (-10')		3500 (7710)	2160 (4770)			4230 (9340)	2580 (5700)	*6270 (13830)	4880 (10770)
Arm length 2500 mm (8'2")									
6.1 m (20')		*1690 (3730)	*1690 (3730)			*3060 (6750)	*3060 (6750)		
3.0 m (10')		*1580 (3490)	1370 (3040)	2880 (6350)	1830 (4040)	*4320 (9530)	2990 (6600)	*5770 (12720)	*5770 (12720)
0.0 m (0')		*1940 (4280)	1290 (2850)	2690 (5950)	1660 (3680)	4260 (9390)	2600 (5730)	*5630 (12420)	4840 (10670)
-3.0 m (-10')		3000 (6630)	1850 (4090)			4180 (9230)	2540 (5600)	*6040 (13330)	4820 (10640)
Arm length 3000 mm (9'10")									
6.1 m (20')		*1380 (3050)	*1380 (3050)	*1580 (3480)	*1580 (3480)	*2690 (5940)	*2690 (5940)		
3.0 m (10')		*1280 (2830)	1200 (2660)	2900 (6390)	1850 (4080)	*3740 (8250)	3040 (6700)	*3690 (8150)	*3690 (8150)
0.0 m (0')		*1530 (3310)	1120 (2480)	2670 (5900)	1640 (3630)	4240 (9360)	2580 (5700)	*5990 (13200)	4830 (10660)
-3.0 m (-10')		2510 (5540)	1530 (3370)	2620 (5780)	1590 (3520)	4100 (9040)	2450 (5410)	*5990 (13210)	4680 (10330)

* Load is limited by hydraulic capacity rather than tipping.

Ratings are based on SAE Standard NO. J1097. Rated loads do not exceed 87% of hydraulic lift capacity or 75% of tipping load.

PC138US-8 (UK source)

Conditions: One-piece boom: 4600 mm, Bucket (SAE) : 0.50 m³, Shoes: 500 mm unit :kg

B	A	MAX		7.5 m		6.0 m		4.5 m		3.0 m		1.5 m	
		Cf	Cs	Cf	Cs	Cf	Cs	Cf	Cs	Cf	Cs	Cf	Cs
Arm length 3000 mm													
	6.0 m	*1620	*1620					*2810	*2810				
	4.5 m	*1510	1480			*2880	1930	*3040	*3040				
	3.0 m	*1530	1260	2240	1380	2960	1870	*3730	3090	*4970	*4970		
	1.5 m	*1630	1170	2190	1330	2850	1770	4600	2850	*7270	5430		
	0 m	*1860	1180	2130	1280	2750	1680	4380	2650	*7350	4990		
	-1.5 m	2740	1660			2690	1620	4270	2550	*8020	4870	*4070	*4070
	-3.0 m	*2500	*2500					4270	2550	*6770	4920	*6870	*6870
	-4.5 m	*4800	2950							*4180	*4180		
Arm length 2500 mm													
	6.0 m	*2060	*2060					*3270	3220				
	4.5 m	*1920	1730			*2890	1890	*3460	3200	*3960	*3960		
	3.0 m	*1950	1450			2940	1860	*4140	3050	*5870	*5870		
	1.5 m	*2120	1350			2850	1780	4590	2840	*7960	5330		
	0 m	2250	1370			2780	1710	4300	2580	*6750	5030		
	-1.5 m	2540	1550			2740	1680	4340	2620	*7740	4990	*4710	*4710
	-3.0 m	*3130	2060					*4160	2650	*6140	5090	*8310	*8310
	-4.5 m												
Arm length 2100 mm													
	6.0 m	*2620	*2620					*3530	3150	*3860	*3860		
	4.5 m	*2420	1950					*3780	3150	*4560	*4560		
	3.0 m	*2460	1610			2910	1830	*4420	3000	*6530	5820		
	1.5 m	2410	1490			2840	1770	4550	2810				
	0 m	2480	1520			2780	1710	4260	2560	*6240	5000		
	-1.5 m	2850	1750					4230	2530	*7300	5020	*5280	*5280
	-3.0 m	*3190	2430					*3660	2700	*5440	5150		
	-4.5 m												

Conditions: Two-piece boom: Bucket (SAE): 0.5 m³, Shoes: 500 mm unit :kg

B	A	MAX		7.5 m		6.0 m		4.5 m		3.0 m		1.5 m	
		Cf	Cs	Cf	Cs	Cf	Cs	Cf	Cs	Cf	Cs	Cf	Cs
Arm length 2500 mm													
	7.5 m	*2500	*2500										
	6.0 m	*2050	*2050					*3100	*3100				
	4.5 m	*1900	1550			2750	2050	*3350	*3350				
	3.0 m	1800	1300			2700	1950	*4100	3250	*5850	*5850		
	1.5 m	1700	1200	1700	1200	2550	1850	4200	3000				
	0 m	1700	1200	1700	1200	2450	1750	4000	2800				
	-1.5 m	1900	1350			2400	1700	3900	2700	*7500	4600		
	-3.0 m	2400	1700			2450	1700	3900	2700	*7450	5300		
Arm length 2100 mm													
	7.5 m	*3200	*3200										
	6.0 m	*2500	2350					*3500	*3500				
	4.5 m	*2350	1700			2700	2000	*3700	3450				
	3.0 m	2000	1450			2650	1950	4350	3200	*6550	6300		
	1.5 m	1850	1350			2550	1850	4150	2950				
	0 m	1900	1350			2450	1750	3950	2750				
	-1.5 m	2150	1500			2450	1750	3900	2700	*7750	4650		
	-3.0 m	2800	2000					3950	2750	*6850	5400		

Conditions: Offset boom: Bucket (SAE): 0.5 m³, Shoes: 500 mm unit :kg

B	A	MAX		7.5 m		6.0 m		4.5 m		3.0 m		1.5 m	
		Cf	Cs	Cf	Cs	Cf	Cs	Cf	Cs	Cf	Cs	Cf	Cs
Arm length 2100 mm													
	6.0 m	*2140	*2140							*3130	*3130		
	4.5 m	*2060	*2060			*2210	1810	*3210	*3210	*3160	*3160		
	3.0 m	*2190	1750			*2890	1790	*3780	3030	*5070	*5070		
	1.5 m	*2530	1540			2770	1670	4520	2740				
	0 m	2590	1530			2650	1570	4250	2500				
	-1.5 m	2990	1750					4130	2390	*7590	4600		
	-3.0 m	*4090	2560					*3780	2450	*6160	4740	*8020	*8020

* Load is limited hydraulic capacity rather than tipping.
Ratings are based on SAE Standard No. J1097. Rated loads do not exceed 87% of hydraulic lift capacity or 75% of tipping load.

PC138USLC-10 (for USA)

Conditions:

Boom: 4600 mm (15'1"), Bucket (SAE): 0.50 m³ (0.65 cu.yd), Shoes: 600 mm (24")

unit: kg (lb)

B	A	MAX		6.1 m (20')		4.6 m (15')		3.0 m (10')	
		Cf	Cs	Cf	Cs	Cf	Cs	Cf	Cs
Arm length 2500 mm (8'2")									
6.1 m (20')		*1690 (3730)	*1690 (3730)			*3060 (6750)	*3060 (6750)		
3.0 m (10')		*1580 (3480)	1580 (3480)	3550 (2830)	2120 (4670)	*4320 (9520)	3400 (7500)	*5770 (12720)	*5770 (12720)
0.0 m (0')		*1940 (4280)	1530 (3370)	3360 (7410)	1950 (4300)	5310 (11710)	3010 (6640)	*5630 (12420)	5570 (12280)
-3.0 m (-10')		3480 (7670)	2170 (4780)			4870 (10740)	2950 (6500)	*6040 (13320)	5550 (12240)
Arm length 3000 mm (9'10")									
6.1 m (20')		*1380 (3040)	*1380 (3040)	*1580 (3480)	*1580 (3480)	*2690 (5930)	*2690 (5930)		
3.0 m (10')		*1280 (2820)	1280 (2820)	3290 (7250)	2140 (4720)	*3740 (8250)	3450 (7610)	*3690 (8140)	*3690 (8140)
0.0 m (0')		*1530 (3370)	1340 (2950)	3350 (7390)	1930 (4260)	5300 (11680)	3000 (6610)	*5990 (13210)	5560 (12320)
-3.0 m (-10')		2550 (5620)	1810 (3990)	3290 (7250)	1880 (4150)	5150 (11350)	2870 (6330)	*5990 (13210)	5410 (11930)

* Load is limited hydraulic capacity rather than tipping.
 Ratings are based on SAE Standard No. J1097. Rated loads do not exceed 87% of hydraulic lift capacity or 75% of tipping load.

PC160LC-8

Conditions:

Boom: 5150 mm (16'11"), Bucket (SAE): 0.65 m³ (0.85 cu.yd), Shoes: 500 mm (20")

unit: kg (lb)

B	A	MAX		7.5 m (25')		6.0 m (20')		4.5 m (15')		3.0 m (10')		1.5 m (4')	
		Cf	Cs	Cf	Cs	Cf	Cs	Cf	Cs	Cf	Cs	Cf	Cs
Arm length 2250 mm (7'5")													
	7.5 m (24')	*2700 (6000)	*2700 (6000)										
	6.0 m (19')	*2400 (5300)	*2400 (5300)			*3250 (7200)	2850 (6300)						
	4.5 m (14')	*2350 (5200)	2050 (4600)			*4450 (9800)	2850 (6200)	*5000 (11000)	4650 (10200)				
	3.0 m (9')	*2450 (5400)	1800 (4000)			4450 (9800)	2700 (6000)	*6300 (13900)	4300 (9500)	*9700 (21400)	8150 (18000)		
	0 m (0')	2950 (6600)	1700 (3800)			4150 (9200)	2400 (5400)	6550 (14500)	3750 (8200)	*6750 (14900)	*6750 (14900)		
	-3.0 m (-9')	4200 (9300)	2450 (5400)					6550 (14500)	3700 (8200)	*10500 (23100)	7100 (15700)	*10250 (22700)	*10250 (22700)
	-4.5 m (-14')	*4850 (10700)	4200 (9200)							*7050 (15600)	*7050 (15600)		
Arm length 2610 mm (8'7")													
	7.5 m (24')	*2200 (4900)	*2200 (4900)										
	6.0 m (19')	*2000 (4400)	*2000 (4400)			*3350 (7400)	2900 (6400)						
	4.5 m (14')	*2000 (4400)	1900 (4200)			*4200 (9200)	2850 (6300)						
	3.0 m (9')	*2050 (4600)	1650 (3700)	3050 (6700)	1800 (4000)	4500 (9900)	2750 (6000)	*5900 (13000)	4400 (9700)	*8700 (19200)	8450 (18600)		
	0 m (0')	*2650 (5900)	1600 (3500)	2900 (6400)	1700 (3700)	4150 (9200)	2450 (5400)	6600 (14600)	3750 (8300)	*7350 (16200)	6950 (15400)		
	-3.0 m (-9')	3800 (8400)	2200 (4900)			4100 (9100)	2400 (5300)	6500 (14400)	3650 (8100)	*11150 (24500)	7050 (15600)	*9200 (20300)	*9200 (20300)
	-4.5 m (-14')	*4950 (11000)	3450 (7600)					*5550 (12200)	3850 (8500)	*8200 (18000)	7350 (16200)		
Arm length 2900 mm (9'6")													
	7.5 m (24')	*1900 (4200)	*1900 (4200)										
	6.0 m (19')	*1750 (3800)	*1750 (3800)			*3250 (7200)	2950 (6500)						
	4.5 m (14')	*1700 (3800)	*1700 (3800)	*2250 (4900)	1850 (4100)	*3900 (8600)	2850 (6300)						
	3.0 m (9')	*1800 (3900)	1550 (3400)	3050 (6700)	1800 (4000)	4500 (9900)	2700 (6000)	*5500 (12200)	4400 (9700)	*7850 (17300)	*7850 (17300)		
	0 m (0')	*2250 (5000)	1450 (3200)	2850 (6300)	1650 (3600)	4100 (9100)	2400 (5300)	6600 (14500)	3700 (8200)	*7650 (16900)	6950 (15300)		
	-3.0 m (-9')	3450 (7600)	1950 (4400)			4050 (8900)	2300 (5100)	6400 (14200)	3600 (7900)	*11500 (25300)	6900 (15300)	*8400 (18500)	*8400 (18500)
	-4.5 m (-14')	*4800 (10600)	2950 (6500)					*6050 (13300)	3700 (8200)	*8900 (19600)	7200 (15800)		

* Load is limited by hydraulic capacity rather than tipping.

Ratings are based on SAE Standard NO. J1097. Rated loads do not exceed 87% of hydraulic lift capacity or 75% of tipping load.

PC160LC-8 (UK source)

Conditions: One-piece boom: 5150 mm, Bucket (SAE) : 0.65m³, Shoes: 500 mm

unit: kg

B	A	MAX		7.5 m		6.0 m		4.5 m		3.0 m		1.5 m	
		Cf	Cs	Cf	Cs	Cf	Cs	Cf	Cs	Cf	Cs	Cf	Cs
Arm length 2250 mm													
	6.0 m	*2400	*2400			*3250	2850						
	4.5 m	*2350	2050			*4450	2850	*5000	4650				
	3.0 m	*2450	1800			4450	2700	*6300	4300	*9700	8150		
	1.5 m	*2700	1700	2950	1750	4300	2550	6700	3850				
	0 m	2950	1700			4150	2400	6550	3750	*6750	*6750		
	-1.5 m	3300	1950			4100	2400	6500	3650	*10600	6950	*6200	*6200
	-3.0 m	4200	2450					6550	3700	*10500	7100	*10250	*10250
	-4.5 m	*4850	4200							*7050	*7050		
Arm length 2600 mm													
	6.0 m	*2000	*2000			*3350	2900						
	4.5 m	*2000	1900			*4200	2850						
	3.0 m	*2050	1650	3050	1800	4500	2750	*5900	4400	*8700	8450		
	1.5 m	*2300	1600	3000	1750	4300	2550	6900	4000	*7850	7350		
	0 m	*2650	1600	2900	1700	4150	2450	6600	3750	*7350	6950		
	-1.5 m	3050	1750			4100	2350	6500	3650	*10150	6950	*5800	*5800
	-3.0 m	3800	2200			4100	2400	6500	3650	*11150	7050	*9200	*9200
	-4.5 m	*4950	3450					*5550	3850	*8200	7350		
Arm length 2900 mm													
	6.0 m	*1750	*1750			*3250	2950						
	4.5 m	*1700	*1700	*2250	1850	*3900	2850						
	3.0 m	*1800	1550	3050	1800	4500	2700	*5500	4400	*7850	*7850		
	1.5 m	*1950	1450	2950	1700	4300	2550	6900	4000	*10000	7450		
	0 m	*2250	1450	2850	1650	4100	2400	6600	3700	*7650	6950		
	-1.5 m	*2800	1600	2850	1600	4050	2300	6400	3600	*9750	6800	*5400	*5400
	-3.0 m	3450	1950			4050	2300	6400	3600	*11500	6900	*8400	*8400
	-4.5 m	*4800	2950					*6050	3700	*8900	7200		

Conditions: Two-piece boom: 5069 mm, Bucket (SAE): 0.65m³, Shoes: 500 mm

unit: kg

B	A	MAX		7.5 m		6.0 m		4.5 m		3.0 m		1.5 m	
		Cf	Cs	Cf	Cs	Cf	Cs	Cf	Cs	Cf	Cs	Cf	Cs
Arm length 2250 mm													
	7.5 m	*3050	*3050					*3350	*3350				
	6.0 m	*2650	*2650			*2900	2850	*5100	4900				
	4.5 m	*2550	2100			4650	2800	*6350	4650				
	3.0 m	*2650	1800			4450	2650	7250	4250	*14050	8000		
	1.5 m	*2850	1700			4250	2350	6750	3800				
	0 m	3050	1700			4100	2300	6450	3550	*7100	6550		
	-1.5 m	3400	1900			4050	2250	6350	3450	*11000	6600		
	-3.0 m							*5650	3550				
Arm length 2600 mm													
	7.5 m	*2500	*2500					*3550	*3550				
	6.0 m	*2200	*2200			*3300	2950						
	4.5 m	*2150	1950			*4600	2850	*5300	4750				
	3.0 m	*2200	1700	*2850	1750	4500	2650	7350	4300	*13200	8300		
	1.5 m	*2400	1550	2950	1600	4250	2350	6800	3850	*8300	7000		
	0 m	*2750	1600	2850	1600	4050	2300	6450	3550	*7800	6550		
	-1.5 m	3150	1750			4000	2250	6300	3450	*10900	6550		
	-3.0 m	3950	2200			4050	2300	6350	3500	*8250	6700		
Arm length 2900 mm													
	7.5 m	*2150	*2150										
	6.0 m	*1900	*1900			*3300	2950						
	4.5 m	*1850	1800	*1850	1800	*4250	2850	*4550	*4550				
	3.0 m	*1900	1550	3050	1750	4500	2650	7400	4350	*12450	8550		
	1.5 m	*2050	1450	2900	1600	4250	2350	6850	3850	*10500	7150		
	0 m	*2350	1450	2850	1550	4050	2250	6450	3500	*8050	6550		
	-1.5 m	2900	1600			3950	2200	6250	3350	*10400	6450		
	-3.0 m	3550	1950			3950	2200	6300	3400	*9200	6550		

* Load is limited hydraulic capacity rather than tipping.
 Ratings are based on SAE Standard No. J1097. Rated loads do not exceed 87% of hydraulic lift capacity or 75% of tipping load.

PC160LC-8 (Brazil source)

Conditions:

Boom: 5150 mm, Bucket (SAE): 0.80 m³, Shoes: 700 mm

unit: kg

B	A	MAX		7.5 m		6.0 m		4.5 m		3.0 m		1.5 m	
		Cf	Cs	Cf	Cs	Cf	Cs	Cf	Cs	Cf	Cs	Cf	Cs
Arm length 2900 mm													
7.5 m		*1900	*1900										
6.0 m		*1750	*1750			*3250	2950						
4.5 m		*1700	*1700	*2250	1850	*3900	2850						
3.0 m		*1800	1550	3050	1800	4500	2700	*5500	4400	*7850	*7850		
0 m		*2250	1450	2850	1650	4100	2400	6600	3700	*7650	6950		
-3.0 m		3450	1950			4050	2300	6400	3600	*11500	6900	*8400	*8400
-4.5 m		*4800	2950					*6050	3700	*8900	7200		
Arm length 2250 mm													
7.5 m		*2700	*2700										
6.0 m		*2400	*2400			*3250	2850						
4.5 m		*2350	2050			*4450	2850	*5000	4650				
3.0 m		*2450	1800			4450	2700	*6300	4300	*9700	8150		
0 m		2950	1700			4150	2400	6550	3750	*6750	*6750		
-3.0 m		4200	2450					6550	3700	*10500	7100	*10250	*10250
-4.5 m		*4850	4200							*7050	7050		

* Load is limited hydraulic capacity rather than tipping.
 Ratings are based on ISO Standard No.10567. Rated loads do not exceed 87% of hydraulic lift capacity or 75% of tipping load.

PC190LC-8 (UK source)Conditions: One-piece boom: 5330 mm, Bucket (SAE): 0.65 m³, Shoes: 600 mm

unit: kg

B	A	MAX		7.5 m		6.0 m		4.5 m		3.0 m		1.5 m	
		Cf	Cs	Cf	Cs	Cf	Cs	Cf	Cs	Cf	Cs	Cf	Cs
Arm length 2250 mm													
	6.0 m	*2500	*2500			*4200	3600						
	4.5 m	*2450	2400			5250	3500	*6200	5700				
	3.0 m	*2500	2100	3550	2300	5150	3350	*7650	5250				
	1.5 m	*2700	2000	3450	2200	4650	3150	7800	4850				
	0 m	*3050	2050	3400	2150	4800	3050	7400	4450	*4850	*4850		
	-1.5 m	3600	2300			4650	2950	6450	4500	*8750	8450	*5050	*5050
	-3.0 m	4400	2800			4750	3000	7500	4600	*12700	8900	*9150	*9150
	-4.5 m												
Arm length 2600 mm													
	6.0 m	*2100	*2100			*3900	3650						
	4.5 m	*2050	*2050			*4850	3550						
	3.0 m	*2100	2050	*2750	2400	5200	3400	*7300	5400	*11200	10400		
	1.5 m	*2300	1950	3600	2350	4700	3250	7950	4950				
	0 m	*2600	1950	3500	2250	4850	3100	7500	4550	*5700	*5700		
	-1.5 m	*3150	2150	3400	2200	4700	3000	6500	4550	*8600	*8350	*5000	*5000
	-3.0 m	*4050	2600	3400	2150	4750	3000	7550	4600	*13200	8950	*8350	*8350
	-4.5 m							7150	4750	*10300	9250		
Arm length 2900 mm													
	6.0 m	*1800	*1800			*3600	3600						
	4.5 m	*1800	*1800	*3050	2400	*4350	3600						
	3.0 m	*1850	*1850	3550	2300	5200	3400	*6850	5400	*10150	*10150		
	1.5 m	*2000	1800	3450	2250	4650	3200	7900	4950	*6600	*6600		
	0 m	*2250	1800	3400	2150	4800	3050	7450	4500	*6000	*6000		
	-1.5 m	*2700	1950	3350	2100	4630	2900	6450	4450	*8300	*8050	*4650	*4650
	-3.0 m	*3600	2350			4700	2950	7450	4500	*12200	8800	*7600	*7600
	-4.5 m												

Conditions: Two-piece boom: 5069 mm, Bucket (SAE): 0.65m³, Shoes: 600 mm

unit: kg

B	A	MAX		7.5 m		6.0 m		4.5 m		3.0 m		1.5 m	
		Cf	Cs	Cf	Cs	Cf	Cs	Cf	Cs	Cf	Cs	Cf	Cs
Arm length 2250 mm													
	7.5 m	*3050	*3050					*3550	*3350				
	6.0 m	*2650	*2650			*2900	*2900	*5100	*5100				
	4.5 m	*2550	*2550			5150	3550	*6350	5800				
	3.0 m	*2650	2400			5000	3400	8050	5350	*14050	10300		
	1.5 m	*2850	2250			4800	3100	7550	4900				
	0 m	*3300	2300			4650	3050	7250	4650	*7100	*7100		
	-1.5 m	3850	2550			4550	3000	7150	4600	*11000	8850		
	-3.0 m							*5650	4650				
Arm length 2600 mm													
	7.5 m	*2500	*2500					*3550	*3550				
	6.0 m	*2200	*2200			*3300	*3300						
	4.5 m	*2150	*2150			*4600	3600	*5300	*5300				
	3.0 m	*2200	*2200	*2850	2300	5050	3400	8150	5450	*13200	10250		
	1.5 m	*2400	2100	3350	2200	4800	3100	7650	5000	*8300	*8300		
	0 m	*2750	2150	3200	2150	4600	3050	7250	4650	*7800	*7800		
	-1.5 m	*3450	2350			4550	2950	7150	4550	*10900	8750		
	-3.0 m	*3950	2950			*4200	3050	*6450	4600	*8250	8250		
Arm length 2900 mm													
	7.5 m	*2150	*2150										
	6.0 m	*1900	*1900			*3300	*3300						
	4.5 m	*1850	*1850	*1850	*1850	*4250	3650	*4550	*4550				
	3.0 m	*1900	*1900	*3250	2300	5005	3450	*7650	5550	*12450	10500		
	1.5 m	*2050	1950	3350	2150	4800	3100	7650	5000	*10500	9400		
	0 m	*2350	2000	3250	2150	4600	3000	7250	4650	*8050	*8050		
	-1.5 m	*2900	2150			4500	2900	7100	4500	*10400	8650		
	-3.0 m	*3950	2650			4500	2950	6950	4500	*9200	8800		

* Load is limited hydraulic capacity rather than tipping.

Ratings are based on SAE Standard No. J1097. Rated loads do not exceed 87% of hydraulic lift capacity or 75% of tipping load.

PC190NLC-8 (UK source)

Conditions: One-piece boom: 5330 mm, Bucket (SAE): 0.65 m³, Shoes: 500 mm

unit: kg

B	A	MAX		7.5 m		6.0 m		4.5 m		3.0 m		1.5 m	
		Cf	Cs	Cf	Cs	Cf	Cs	Cf	Cs	Cf	Cs	Cf	Cs
Arm length 2250 mm													
	6.0 m	*2500	*2500			*4200	3250						
	4.5 m	*2450	2150			5150	3200	*6200	5150				
	3.0 m	*2500	1900	3450	2050	5050	3000	*7700	4750				
	1.5 m	*2700	1800	3400	2000	4550	2850	7650	4350				
	0 m	*3050	1850	3350	1950	4700	2700	7250	3940	*4850	*4850		
	-1.5 m	3500	2050			4580	2600	6350	4000	*8750	7400	*5050	*5050
	-3.0 m	4350	2500			4700	2700	7400	4100	*12750	7850	*9150	*9150
Arm length 2600 mm													
	6.0 m	*2100	*2100			*3900	3300						
	4.5 m	*2050	2050			*4850	3250						
	3.0 m	*2100	1800	*2750	2150	5100	3100	*7300	4850	*11200	9200		
	1.5 m	*2300	1700	3500	2100	4600	2900	7800	4450				
	0 m	*2600	1750	3400	2000	4750	2750	7300	4050	*5700	*5700		
	-1.5 m	*3150	1900	3350	1950	4600	2650	6350	4050	*8600	7450	*5000	*5000
	-3.0 m	3950	2300	3300	1900	4650	2700	7400	4100	*13200	7850	*8350	*8350
Arm length 2900 mm													
	6.0 m	*1800	*1800			*3600	3350						
	4.5 m	*1800	*1800	*3050	2150	*4350	3250						
	3.0 m	*1850	1650	3500	2050	5100	3050	*6850	4900	*10150	9400		
	1.5 m	*2000	1600	3400	2000	4550	2850	7700	4400	*6600	*6600		
	0 m	*2250	1600	3300	1900	4700	2700	7300	4000	*6000	*6000		
	-1.5 m	*2700	1750	3250	1850	4550	2600	6300	3950	*8300	7350	*4650	*4650
	-3.0 m	*3600	2100			4600	2600	7300	4000	*12200	7700	*7600	*7600

Conditions: Two-piece boom: 5069 mm, Bucket (SAE): 0.65m³, Shoes: 500 mm

unit: kg

B	A	MAX		7.5 m		6.0 m		4.5 m		3.0 m		1.5 m	
		Cf	Cs	Cf	Cs	Cf	Cs	Cf	Cs	Cf	Cs	Cf	Cs
Arm length 2250 mm													
	7.5 m	*3050	*3050					*3350	*3350				
	6.0 m	*2650	*2650			*2900	*2900	*5100	*5100				
	4.5 m	*2550	2350			5000	3050	*6350	5000				
	3.0 m	*2650	2000			4800	2900	7750	4600	*14050	8650		
	1.5 m	*2850	1900			4600	2600	7250	4150				
	0 m	*3300	1900			4400	2550	6950	3900	*7100	*7100		
	-1.5 m	3700	2150			4350	2500	6850	3800	*11000	7250		
	-3.0 m							*5650	3900				
Arm length 2600 mm													
	7.5 m	*2500	*2500					*3550	*3550				
	6.0 m	*2200	*2200			*3300	3250						
	4.5 m	*2150	*2150			*4600	3200	*5300	5250				
	3.0 m	*2200	1950	*2850	2000	4850	3000	7850	4800	*13200	9250		
	1.5 m	*2400	1800	3200	1900	4600	2700	7300	4350	*8300	7950		
	0 m	*2750	1850	3150	1850	4400	2650	6950	4050	*7800	7500		
	-1.5 m	3400	2050			4350	2550	6850	3900	*10900	7450		
	-3.0 m	*3950	2550			4200	2600	*6450	3950	*8250	7600		
Arm length 2900 mm													
	7.5 m	*2150	*2150										
	6.0 m	*1900	*1900			*3300	3300						
	4.5 m	*1850	*1850	*1850	*1850	*4250	3200	*4550	*4550				
	3.0 m	*1900	1800	*3250	2000	4850	3000	*7650	4850	*12450	9500		
	1.5 m	*2050	1700	3200	1850	4600	2700	7350	4350	*10500	8100		
	0 m	*2350	1700	3100	1800	4400	2600	6950	4000	*8050	7450		
	-1.5 m	*2900	1850			4300	2500	6800	3850	*10400	7350		
	-3.0 m	3850	2300			4300	2550	6800	3900	*9200	7500		

* Load is limited hydraulic capacity rather than tipping.
 Ratings are based on SAE Standard No. J1097. Rated loads do not exceed 87% of hydraulic lift capacity or 75% of tipping load.

HB205-1

Conditions:

Boom: 5700 mm (18'8"), Bucket (SAE): 0.80 m³ (0.15 cu.yd), Shoes: 600 mm (24")

unit: kg (lb)

B	A	MAX		7.6 m (25')		6.1 m (20')		4.6 m (15')		3.0 m (10')		1.5 m (5')	
		Cf	Cs	Cf	Cs	Cf	Cs	Cf	Cs	Cf	Cs	Cf	Cs
Arm length 2925 mm (9'7")													
7.6 m (25')		*2750 (6100)				*3800 (8300)	*3800 (8300)						
6.1 m (20')		*2600 (5800)	*2600 (5800)			*4300 (9500)	4050 (8900)						
4.6 m (15')		*2650 (5800)	2150 (4800)	3950 (8800)	2600 (5700)	*4900 (10800)	3900 (8600)						
3.0 m (10')		*2800 (6100)	1950 (4300)	3850 (8500)	2500 (5500)	5650 (12500)	3700 (8100)	*7350 (16200)	5850 (12900)	*11350 (25000)	*11350 (25000)		
1.5 m (5')		3000 (6600)	1850 (4100)	3750 (8300)	2350 (5200)	5400 (11900)	3450 (7600)	8600 (19000)	5350 (11800)	*7500 (16500)	*7500 (16500)		
0 m (0')		3050 (6700)	1900 (4200)	3650 (8000)	2300 (5000)	5200 (11500)	3250 (7200)	8250 (18200)	5050 (11100)	*8000 (17700)	*8000 (17700)		
-1.5 m (-5')		3350 (7400)	2050 (4600)	3600 (7900)	2250 (4900)	5100 (11200)	3150 (7000)	8100 (17900)	4900 (10800)	*11200 (24700)	9500 (20900)	*6800 (15000)	*6800 (15000)
-3.0 m (-10')		4000 (8800)	2500 (5500)			5100 (11200)	3150 (7000)	8100 (17900)	4950 (10900)	*15600 (34400)	9650 (21300)	*10500 (23200)	*10500 (23200)
-4.5 m (-15')		5650 (12500)	3550 (7900)					8300 (18300)	5100 (11200)	*13050 (28800)	10000 (22000)		

* Load is limited hydraulic capacity rather than tipping.
Ratings are based on SAE Standard No. J1097. Rated loads do not exceed 87% of hydraulic lift capacity or 75% of tipping load.

HB215LC-1, HB215LC-1 (UK source)

Conditions:

Boom: 5700 mm (18'8"), Bucket (SAE): 0.80 m³ (0.15 cu.yd), Shoes: 700 mm (28")

unit: kg (lb)

B	A	MAX		7.6 m (25')		6.1 m (20')		4.6 m (15')		3.0 m (10')		1.5 m (5')	
		Cf	Cs	Cf	Cs	Cf	Cs	Cf	Cs	Cf	Cs	Cf	Cs
Arm length 2925 mm (9'7")													
7.6 m (25')		*2750 (6100)	*2750 (6100)			*3800 (8300)	*3800 (8300)						
6.1 m (20')		*2600 (5800)	*2600 (5800)			*4300 (9500)	*4300 (9500)						
4.6 m (15')		*2650 (5800)	2550 (5600)	*4650 (10300)	2600 (5700)	*4900 (10800)	4500 (9900)						
3.0 m (10')		*2800 (6100)	2300 (5100)	4750 (10500)	2500 (5500)	*5850 (12900)	4250 (9400)	*7350 (16200)	6750 (14900)	*11350 (25000)	*11350 (25000)		
1.5 m (5')		*3050 (6700)	2200 (4900)	4650 (10200)	2350 (5200)	6700 (14700)	4000 (8900)	*9300 (20500)	6250 (13800)	*7500 (16500)	*7500 (16500)		
0 m (0')		*3500 (7800)	2250 (5000)	4550 (10000)	2300 (5000)	6450 (14300)	3850 (8400)	10450 (23000)	5900 (13000)	*8000 (17700)	*8000 (17700)		
-1.5 m (-5')		4150 (9200)	2450 (5400)	4500 (9900)	2250 (4900)	6350 (14000)	3750 (8200)	*10250 (22700)	5800 (12700)	*11200 (24700)	*11200 (24700)	*6800 (15000)	*6800 (15000)
-3.0 m (-10')		4950 (11000)	2950 (6500)			6350 (14000)	3750 (8200)	10300 (22700)	5800 (12800)	*15600 (34400)	11500 (25400)	*10500 (23200)	*10500 (23200)
-4.5 m (-15')		*6750 (14900)	4150 (9200)					*9050 (20000)	6000 (13200)	*13050 (28800)	11900 (26200)		

* Load is limited hydraulic capacity rather than tipping.
Ratings are based on SAE Standard No. J1097. Rated loads do not exceed 87% of hydraulic lift capacity or 75% of tipping load.

PC200-8

Conditions: Boom: 5700 mm (18'8"), Bucket (SAE): 0.80 m³ (1.05 cu.yd), Shoes: 600 mm (24") unit :kg (lb)

B	A	MAX		7.6 m (25')		6.1 m (20')		4.6 m (15')		3.0 m (10')		1.5 m (5')	
		Cf	Cs	Cf	Cs	Cf	Cs	Cf	Cs	Cf	Cs	Cf	Cs
Arm length 2925 mm (9'7")													
7.6 m (25')		*2750 (6100)	*2750 (6100)			*3800 (8300)	*3800 (8300)						
6.1 m (20')		*2600 (5800)	*2600 (5800)			*4300 (9500)	4050 (8900)						
4.6 m (15')		*2650 (5800)	2150 (4800)	3950 (8800)	2600 (5700)	*4900 (10800)	3900 (8600)						
3.0 m (10')		*2800 (6100)	1950 (4300)	3850 (8500)	2500 (5500)	5650 (12500)	3700 (8100)	*7350 (16200)	5850 (12900)	*11350 (25000)	*11350 (25000)		
1.5 m (5')		3000 (6600)	1850 (4100)	3750 (8300)	2350 (5200)	5400 (11900)	3450 (7600)	8600 (19000)	5350 (11800)	*7500 (16500)	*7500 (16500)		
0 m (0')		3050 (6700)	1900 (4200)	3650 (8000)	2300 (5000)	5200 (11500)	3250 (7200)	8250 (18200)	5050 (11100)	*8000 (17700)	*8000 (17700)		
-1.5 m (-5')		3350 (7400)	2050 (4600)	3600 (7900)	2250 (4900)	5100 (11200)	3150 (7000)	8100 (17900)	4900 (10800)	*11200 (24700)	9500 (20900)	*6800 (15000)	*6800 (15000)
-3.0 m (-10')		4000 (8800)	2500 (5500)			5100 (11200)	3150 (7000)	8100 (17900)	4950 (10900)	*15600 (34400)	9650 (21300)	*10550 (23200)	*10550 (23200)
-4.6 m (-15')		5650 (12500)	3550 (7900)					8300 (18300)	5100 (11200)	*13050 (28800)	10000 (22000)		
Arm length 1840 mm (6')													
7.6 m (25')		*4800 (10600)	*4800 (10600)					*5500 (12100)	*5500 (12100)				
6.1 m (20')		*4450 (9900)	3450 (7600)			*5450 (12100)	3800 (8300)	*5700 (12600)	*5700 (12600)				
4.6 m (15')		4200 (9300)	2700 (6000)			5650 (12500)	3700 (8100)	*7000 (15400)	6000 (13200)	*9850 (21800)	*9850 (21800)		
3.0 m (10')		3750 (8300)	2350 (5200)			5450 (12000)	3500 (7700)	8600 (19000)	5350 (11800)				
1.5 m (5')		3600 (8000)	2250 (5000)	3650 (8100)	2300 (5000)	5250 (11500)	3300 (7300)	8250 (18200)	5000 (11100)				
0 m (0')		3750 (8200)	2300 (5100)			5100 (11200)	3150 (7000)	8050 (17700)	4850 (10700)				
-1.5 m (-5')		4200 (9300)	2650 (5800)			5050 (11200)	3150 (6900)	8050 (17700)	4850 (10700)	*13350 (29400)	9500 (21000)		
-3.0 m (-10')		5500 (12100)	3450 (7600)					8200 (18100)	5000 (11000)	*13200 (29100)	9800 (21600)		
Arm length 2410 mm (7'11")													
7.6 m (25')		*4300 (9500)	4300 (9400)										
6.1 m (20')		*4100 (9000)	3000 (6600)			*4850 (10700)	3950 (8700)						
4.6 m (15')		3800 (8400)	2450 (5400)	3900 (8600)	2500 (5600)	*5400 (11900)	3800 (8400)	*6200 (13600)	*6200 (13600)				
3.0 m (10')		3400 (7500)	2150 (4800)	3800 (8400)	2450 (5400)	5600 (12300)	3600 (8000)	*8100 (17800)	5700 (12600)				
1.5 m (5')		3300 (7300)	2050 (4600)	3700 (8200)	2350 (5200)	5350 (11800)	3400 (7500)	8450 (18700)	5250 (11500)				
0 m (0')		3400 (7500)	2100 (4700)	3650 (8000)	2250 (5000)	5150 (11400)	3250 (7100)	8150 (18000)	4950 (11000)	*7350 (16200)	*7350 (16200)		
-1.5 m (-5')		3750 (8300)	2350 (5200)			5100 (11200)	3150 (7000)	8100 (17800)	4900 (10800)	*12250 (27000)	9500 (21000)	*7650 (16900)	*7650 (16900)
-3.0 m (-10')		4650 (10200)	2900 (6400)			5150 (11400)	3200 (7100)	8200 (18000)	4950 (11000)	*14700 (32400)	9750 (21500)	*12650 (27900)	*12650 (27900)
-4.6 m (-15')		*7200 (15900)	4550 (10000)					*8100 (17800)	5200 (11500)	*11600 (25500)	10150 (22400)		

* Load is limited by hydraulic capacity rather than tipping. Ratings are based on SAE Standard NO. J1097. Rated loads do not exceed 87% of hydraulic lift capacity or 75% of tipping load.

PC200LC-8

Conditions:

Boom: 5700 mm (18'8"), Bucket (SAE): 0.80 m³ (1.05 cu.yd), Shoes: 700 mm (28")

unit: kg (lb)

B	A	MAX		7.6 m (25')		6.1 m (20')		4.6 m (15')		3.0 m (10')		1.5 m (5')	
		Cf	Cs	Cf	Cs	Cf	Cs	Cf	Cs	Cf	Cs	Cf	Cs
Arm length 2925 mm (9'7")													
7.6 m (25')		*2750 (6100)	*2750 (6100)			*3800 (8300)	*3800 (8300)						
6.1 m (20')		*2600 (5800)	*2600 (5800)			*4300 (9500)	*4300 (9500)						
4.6 m (15')		*2650 (5800)	2550 (5600)	*4650 (10300)	3000 (6600)	*4900 (10800)	4500 (9900)						
3.0 m (10')		*2800 (6100)	2300 (5100)	*4750 (10500)	2900 (6400)	*5850 (12900)	4250 (9400)	*7350 (16200)	6750 (14900)	*11350 (25000)	*11350 (25000)		
1.5 m (5')		*3050 (6700)	2200 (4900)	4650 (10200)	2800 (6200)	6700 (14700)	4000 (8900)	*9300 (20500)	6250 (13800)	*7500 (16500)	*7500 (16500)		
0 m (0')		*3500 (7800)	2250 (5000)	4550 (10000)	2700 (5900)	6450 (14300)	3850 (8400)	10450 (23000)	5900 (13000)	*8000 (17700)	*8000 (17700)		
-1.5 m (-5')		*4150 (9200)	2450 (5400)	4500 (9900)	2650 (5800)	6350 (14000)	3750 (8200)	*10250 (22700)	5800 (12700)	*11200 (24700)	*11200 (24700)	*6800 (15000)	*6800 (15000)
-3.0 m (-10')		4950 (11000)	2950 (6500)			6350 (14000)	3750 (8200)	10300 (22700)	5800 (12800)	*15600 (34400)	11500 (25400)	*10550 (23200)	*10550 (23200)
-4.6 m (-15')		*6750 (14900)	4150 (9200)					*9050 (20000)	6000 (13200)	*13050 (28800)	11900 (26000)		
Arm length 2410 mm (7'11")													
7.6 m (25')		*4300 (9500)	*4300 (9500)										
6.1 m (20')		*4100 (9000)	3500 (7700)			*4850 (10700)	4500 (10000)						
4.6 m (15')		*4150 (9100)	2850 (6300)	*4700 (10400)	2950 (6500)	*5400 (11900)	4400 (9700)	*6200 (13600)	*6200 (13600)				
3.0 m (10')		*4250 (9300)	2550 (5600)	4700 (10400)	2850 (6300)	*6300 (13900)	4200 (9200)	*8100 (17800)	6600 (14600)				
1.5 m (5')		4100 (9000)	2450 (5400)	4600 (10200)	2750 (6100)	*6600 (14500)	3950 (8700)	*9850 (21800)	6100 (13500)				
0 m (0')		4200 (9300)	2500 (5500)	4550 (10000)	2700 (5900)	6450 (14200)	3800 (8400)	10350 (22800)	5850 (12900)	*7350 (16200)	*7350 (16200)		
-1.5 m (-5')		4650 (10300)	2750 (6100)			6350 (14000)	3750 (8300)	10250 (22600)	5800 (12700)	*12250 (27000)	11400 (25100)	*7650 (16900)	*7650 (16900)
-3.0 m (-10')		5750 (12700)	3450 (6100)			6400 (14200)	3800 (8400)	*10250 (22600)	5850 (12900)	*14700 (32400)	11600 (25600)	*12650 (27900)	*12650 (27900)
-4.6 m (-15')		*7200 (15900)	5300 (11700)					*8100 (17800)	6100 (13500)	*11600 (25500)	*11600 (25500)		
Arm length 1840 mm (6')													
6.1 m (20')		*4450 (9900)	3950 (8800)			*5450 (12100)	4350 (9600)	*5700 (12600)	*5700 (12600)				
7.6 m (25')		*4800 (10600)	*4800 (10600)					*5500 (12100)	*5500 (12100)				
4.6 m (15')		*4500 (9900)	3150 (7000)			*5900 (13000)	4250 (9400)	*7000 (15400)	*6900 (15200)	*9850 (21800)	*9850 (21800)		
3.0 m (10')		*4650 (10200)	2800 (6200)			*6700 (14800)	4050 (9000)	*8700 (19200)	6250 (13700)				
1.5 m (5')		4500 (9900)	2650 (5900)	4550 (10000)	2700 (6000)	6500 (14300)	3850 (8500)	*10350 (22800)	5900 (13000)				
0 m (0')		4650 (10300)	2750 (6100)			6350 (14000)	3750 (8200)	10200 (22500)	5700 (12600)				
-1.5 m (-5')		5250 (11600)	3100 (6900)			6350 (14000)	3700 (8200)	10200 (22500)	5700 (12600)	*13350 (29400)	11350 (25100)		
-3.0 m (-10')		6850 (15100)	4050 (8900)					*9550 (21100)	5900 (13000)	*13200 (29100)	11700 (25800)		

* Load is limited by hydraulic capacity rather than tipping. Ratings are based on SAE Standard NO. J1097. Rated loads do not exceed 87% of hydraulic lift capacity or 75% of tipping load.

PC200-8 (Thailand source)

Conditions: Boom: 5700 mm (18'8"), Bucket (SAE): 0.80 m³ (1.05 cu.yd), Shoes: 700 mm (28")

Lifting mode: ON

unit: kg (lb)

B	A	MAX		7.6 m (25')		6.1 m (20')		4.6 m (15')		3.0 m (10')		1.5 m (5')	
		Cf	Cs	Cf	Cs	Cf	Cs	Cf	Cs	Cf	Cs	Cf	Cs
Arm length 2410 mm (7'11")													
	7.6 m (25')	*4550 (10000)	4500 (10000)										
	6.1 m (20')	*4250 (9450)	3150 (7000)			5950 (13200)	4050 (8900)						
	4.6 m (15')	3850 (8550)	2550 (5650)	3900 (8650)	2600 (5700)	5800 (12850)	3900 (8600)	*7600 (16800)	6300 (13950)				
	3.0 m (10')	3500 (7700)	2250 (5000)	3850 (8450)	2500 (5550)	5550 (12300)	3650 (8100)	8950 (19800)	5750 (12750)				
	1.5 m (5')	3350 (7400)	2150 (4750)	3700 (8200)	2400 (5300)	5300 (11750)	3450 (7600)	8400 (18550)	5300 (11650)				
	0 m (0')	3450 (7600)	2200 (4850)	3650 (8050)	2300 (5150)	5150 (11350)	3300 (7250)	8100 (17900)	5000 (11100)	*7300 (16100)	*7300 (16100)		
	-1.5 m (-5')	3800 (8400)	2400 (5400)			5050 (11200)	3200 (7150)	8050 (17750)	4950 (10950)	*12450 (27500)	9600 (21250)	*7850 (17300)	*7850 (17300)
	-3.0 m (-10')	4700 (10450)	3000 (6700)			5150 (11350)	3300 (7250)	8150 (17950)	5050 (11150)	*17500 (38650)	9850 (21750)		
	-4.6 m (-15')	7500 (16600)	4800 (10550)					8450 (18650)	5300 (11700)	*13700 (30300)	10300 (22750)		

Conditions: Boom: 5700 mm (18'8"), Bucket (SAE): 0.80 m³ (1.05 cu.yd), Shoes:700 mm (28")

Lifting mode: ON

unit: kg (lb)

B	A	MAX		7.6 m (25')		6.1 m (20')		4.6 m (15')		3.0 m (10')		1.5 m (5')	
		Cf	Cs	Cf	Cs	Cf	Cs	Cf	Cs	Cf	Cs	Cf	Cs
Arm length 2925 mm (9'7")													
	7.6 m (25')	*2950 (6500)	*2950 (6500)			*3550 (7850)	*3550 (7850)						
	6.1 m (20')	*2800 (6150)	*2800 (6150)			*5350 (11800)	4100 (9100)						
	4.6 m (15')	*2800 (6200)	2300 (5150)	3950 (8800)	2650 (5850)	5900 (13050)	3950 (8800)	*6750 (14900)	6450 (14250)				
	3.0 m (10')	*2950 (6550)	2050 (4550)	3850 (8550)	2550 (5600)	5650 (12450)	3750 (8250)	*9050 (20000)	5900 (13100)	*14050 (31000)	11350 (25050)		
	1.5 m (5')	3050 (6800)	1950 (4350)	3750 (8250)	2400 (5350)	5350 (11850)	3500 (7700)	8550 (18850)	5400 (11900)	*7350 (16200)	*7350 (16200)		
	0 m (0')	3150 (6950)	2000 (4400)	3650 (8050)	5150 (2300)	5150 (11400)	3300 (7300)	8150 (18000)	5050 (11200)	*8250 (18250)	*8250 (18250)		
	-1.5 m (-5')	3400 (7600)	2150 (4800)	3600 (7950)	5050 (2250)	5050 (11150)	3200 (7100)	8000 (17700)	4950 (10900)	*11650 (25750)	9550 (21100)	*7250 (16000)	*7250 (16000)
	-3.0 m (-10')	4150 (9100)	2650 (5850)			5050 (11200)	3200 (7100)	8050 (17800)	4950 (11000)	*16750 (37000)	9750 (21450)	*11100 (24450)	*11100 (24450)
	-4.6 m (-15')	8450 (3800)	6000 (13200)					8150 (18050)	5050 (11200)	*15400 (34000)	22300 (10100)		

* Load is limited by hydraulic capacity rather than tipping. Ratings are based on ISO Standard NO. 10567. Rated loads do not exceed 87% of hydraulic lift capacity or 75% of tipping load.

PC200-8 (Brazil source)

Conditions:

Boom: 5700 mm, Bucket (SAE): 1.2 m³, Shoes: 700 mm

unit: kg

B	A	MAX		7.6 m		6.1 m		4.6 m		3.0 m		1.5 m	
		Cf	Cs	Cf	Cs	Cf	Cs	Cf	Cs	Cf	Cs	Cf	Cs
Arm length 2410 mm													
7.6m		*4250	4200										
6.1m		*3950	2850			5650	3750						
4.6m		3550	2250	3600	2300	5500	3600	*7300	6000				
3.0m		3200	1950	3350	2200	5250	3350	8650	5450				
1.5m		3050	1850	3400	2100	5000	3150	8100	5000				
0m		3150	1900	3350	2000	4850	3000	7800	4700	*7000	7000		
-1.5m		3500	2100			4750	2900	7750	4650	*12150	9300	*7550	*7550
-3.0m		4400	2700			4850	2900	7850	4750	*17200	9550		
-4.6m		7200	4500					8150	5000	*13400	10000		
Arm length 2925 mm													
7.6m		*2650	*2650			*3250	*3250						
6.1m		*2500	*2500			*5050	3800						
4.6m		*2500	2000	3650	2350	5600	3650	*6450	6150				
3.0m		*2650	1750	3550	2250	5350	3450	*8750	5600	*13750	11050		
1.5m		2750	1650	3450	2100	5050	3100	8250	5100	*7050	7050		
0m		2850	1700	3350	4850	4850	3000	7850	4750	*7950	7950		
-1.5m		3100	1750	3300	4750	4750	2900	7700	4650	*11350	9250	*6950	*6950
-3.0m		3850	2350			4750	2900	7750	4650	*16450	9350	*10800	*10800
-4.6m		5700	8150					7850	4750	*15100	22000		

* Load is limited hydraulic capacity rather than tipping.
Ratings are based on ISO Standard No.10567. Rated loads do not exceed 87% of hydraulic lift capacity or 75% of tipping load.

PC200LC-8 (Brazil source)

Conditions:

Boom: 5200 mm, Bucket (SAE): 1.50 m³, Shoes: 800 mm

unit: kg

B	A	MAX		7.6 m		6.1 m		4.6 m		3.0 m		1.5 m	
		Cf	Cs	Cf	Cs	Cf	Cs	Cf	Cs	Cf	Cs	Cf	Cs
Arm length 2410 mm													
7.6m		*4300	*4250										
6.1m		*3950	3300			*5750	4300						
4.6m		*4000	2650			*6350	4150	*7300	6900				
3.0m		4050	2300	5000	3020	6650	3900	*9600	6300				
1.5m		3900	2200	4840	2915	6350	3700	10450	5800				
0m		4000	2250	4790	2810	6200	3500	10100	5550	*7000	*7000		
-1.5m		4500	2550			6100	3450	10050	5550	*12150	11100	7550	7550
-3.0m		5650	3200					10150	5550	*17200	11350		
-4.6m		8500	5250					9350	5850	*13400	11800		

* Load is limited hydraulic capacity rather than tipping.
Ratings are based on SAE Standard No. J1097. Rated loads do not exceed 87% of hydraulic lift capacity or 75% of tipping load.

PC200-8M0

Conditions:

Boom: 5700 mm (18'8"), Bucket (SAE): 0.80 m³ (1.05cu.yd), Shoes: 600 mm (24")

unit: kg (lb)

B	A	MAX		7.5 m (25')		6.0 m (20')		4.5 m (15')		3.0 m (10')		1.5 m (5')	
		Cf	Cs	Cf	Cs	Cf	Cs	Cf	Cs	Cf	Cs	Cf	Cs
Arm length 1840 mm (6')													
7.5 m (25')		*5100 (11240)	*5100 (11240)					*5600 (12350)	*5600 (12350)				
6.0 m (20')		*4800 (10580)	3600 (7940)			*5550 (12240)	3950 (8710)	*5800 (12790)	*5800 (12790)				
4.5 m (15')		4400 (9700)	2850 (6280)			5850 (12900)	3800 (8380)	*7350 (16200)	6150 (13560)	*10350 (22820)	*10350 (22820)		
3.0 m (10')		3900 (8600)	2500 (5510)	3850 (8490)	2450 (5400)	5600 (12350)	3600 (7940)	9000 (19840)	5650 (12460)				
1.5 m (5')		3750 (8270)	2350 (5180)	3750 (8270)	2350 (5180)	5400 (11900)	3400 (7500)	8550 (18850)	5200 (11460)				
0 m (0')		3900 (8600)	2400 (5290)	3700 (8160)	2300 (5070)	5250 (11570)	3250 (7170)	8350 (18410)	5050 (11130)				
-1.5 m (-5')		4400 (9700)	2750 (6060)			5200 (11460)	3250 (7170)	8350 (18410)	5050 (11130)	*9500 (20940)	*9500 (20940)		
-3.0 m (-10')		5750 (12680)	3600 (7940)			5350 (11790)	3350 (7390)	8500 (18740)	5200 (11460)	*13000 (28660)	10300 (22710)		
Arm length 2410 mm (7'11")													
7.5 m (25')		*4500 (9920)	4250 (9370)										
6.0 m (20')		*4250 (9370)	3000 (6610)			*4850 (10690)	4050 (8930)						
4.5 m (15')		3800 (8380)	2450 (5400)	4000 (8820)	2600 (5730)	*5450 (12020)	3900 (8600)	*6400 (14110)	6300 (13890)				
3.0 m (10')		3450 (7610)	2150 (4740)	3900 (8600)	2500 (5510)	5650 (12460)	3650 (8050)	*8650 (19070)	5800 (12790)				
1.5 m (5')		3300 (7280)	2050 (4520)	3750 (8270)	2350 (5180)	5450 (12020)	3450 (7610)	8650 (19070)	5300 (11680)				
0 m (0')		3400 (7500)	2100 (4630)	3700 (8160)	2300 (5070)	5250 (11570)	3250 (7160)	8350 (18410)	5050 (11130)	*7000 (15430)	*7000 (15430)		
-1.5 m (-5')		3750 (8270)	2350 (5180)	3650 (8050)	2250 (4960)	5200 (11460)	3200 (7050)	8300 (18300)	5000 (11020)	*9300 (20500)	*9300 (20500)	*7700 (16980)	*7700 (16980)
-3.0 m (-10')		4650 (10250)	2900 (6390)			5250 (11570)	3250 (7160)	8400 (18520)	5100 (11240)	*14600 (32190)	10200 (22490)		
-4.5 m (-15')		*7150 (15760)	4500 (9920)					*8300 (18300)	5350 (11790)	*11650 (25680)	10400 (22930)		
Arm length 2925 mm (9'7")													
7.5 m (25')		*2900 (6390)	*2900 (6390)			*4050 (8930)	*4050 (8930)						
6.0 m (20')		*2750 (6060)	2600 (5730)	*3100 (6830)	2600 (5730)	*4250 (9370)	4100 (9040)						
4.5 m (15')		*2750 (6060)	2150 (4740)	4000 (8820)	2550 (5620)	*4850 (10690)	3900 (8600)	*5500 (12130)	*5500 (12130)				
3.0 m (10')		*2900 (6390)	1900 (4190)	3850 (8490)	2450 (5400)	5650 (12460)	3650 (8050)	*7700 (16980)	5850 (12900)	*11600 (25570)	*11600 (25570)		
1.5 m (5')		2950 (6500)	1800 (3970)	3700 (8160)	2300 (5070)	5400 (11900)	3400 (7500)	8700 (19180)	5300 (11680)	*6800 (14990)	*6800 (14990)		
0 m (0')		3000 (6610)	1800 (3970)	3600 (7940)	2200 (4850)	5150 (11350)	3200 (7050)	8300 (18300)	4950 (10910)	*5150 (11350)	*5150 (11350)		
-1.5 m (-5')		3300 (7280)	2000 (4410)	3550 (7830)	2150 (4740)	5050 (11130)	3050 (6720)	8100 (17860)	4850 (10690)	*9300 (20500)	*9300 (20500)	*5150 (11350)	*5150 (11350)
-3.0 m (-10')		3950 (8710)	2400 (5290)			5050 (11130)	3100 (6830)	8200 (18080)	4900 (10800)	*14800 (32630)	9850 (21720)	*9700 (21380)	*9700 (21380)
-4.5 m (-15')		5700 (12570)	3500 (7720)					8400 (18520)	5100 (11240)	*12950 (28550)	10200 (22490)		

* Load is limited hydraulic capacity rather than tipping.
 Ratings are based on SAE Standard No. J1097. Rated loads do not exceed 87% of hydraulic lift capacity or 75% of tipping load.

PC200LC-8M0

Conditions:

Boom: 5700 mm (18'8"), Bucket (SAE): 0.80 m³ (1.05cu.yd), Shoes: 700 mm (28")

unit: kg (lb)

B	A	MAX		7.5 m (25')		6.0 m (20')		4.5 m (15')		3.0 m (10')		1.5 m (5')	
		Cf	Cs	Cf	Cs	Cf	Cs	Cf	Cs	Cf	Cs	Cf	Cs
Arm length 1840 mm (6')													
7.5 m (25')		*5100 (11240)	*5100 (11240)					*5600 (12350)	*5600 (12350)				
6.0 m (20')		*4800 (10580)	4150 (9150)			*5550 (12240)	4550 (10030)	*5800 (12790)	*5800 (12790)				
4.5 m (15')		*4900 (10800)	3300 (7280)	4750 (10470)	2900 (6390)	*6000 (13230)	4400 (9700)	*7350 (16200)	7050 (15540)	*10350 (22820)	*10350 (22820)		
3.0 m (10')		4850 (10690)	2900 (6390)	4650 (10250)	2800 (6170)	6900 (15210)	4200 (9260)	*9700 (21380)	6550 (14440)				
1.5 m (5')		4650 (10250)	2800 (6170)	4600 (10140)	2750 (6060)	6700 (14770)	4000 (8820)	*10700 (23590)	6100 (13450)				
0 m (0')		4850 (10690)	2850 (6280)			6550 (14440)	3850 (8490)	10600 (23370)	5950 (13120)				
-1.5 m (-5')		5450 (12020)	3250 (7170)			6500 (14330)	3800 (8380)	10600 (23370)	5950 (13120)	*9500 (20940)	*9500 (20940)		
-3.0 m (-10')		7150 (15760)	4200 (9260)			6650 (14660)	3950 (8710)	*9750 (21490)	6100 (13450)	*13000 (28660)	12250 (27010)		
Arm length 2410 mm (7'11")													
7.5 m (25')		*4500 (9920)	*4500 (9920)										
6.0 m (20')		*4250 (9370)	3500 (7720)			*4850 (10690)	4650 (10250)						
4.5 m (15')		*4300 (9480)	2850 (6280)	4900 (10800)	3000 (6610)	*5450 (12020)	4500 (9920)	*6400 (14110)	*6400 (14110)				
3.0 m (10')		4250 (9370)	2550 (5620)	4800 (10580)	2900 (6390)	*6400 (14110)	4200 (9260)	*8650 (19070)	6750 (14880)				
1.5 m (5')		4100 (9040)	2450 (5400)	4700 (10360)	2800 (6170)	6750 (14880)	4000 (8820)	*10550 (23260)	6250 (13780)				
0 m (0')		4250 (9370)	2500 (5510)	4600 (10140)	2700 (5950)	6550 (14440)	3850 (8490)	10650 (23480)	5950 (13120)	*7000 (15430)	*7000 (15430)		
-1.5 m (-5')		4700 (10360)	2750 (6060)	4550 (10030)	2700 (5950)	6500 (14330)	3800 (8380)	10550 (23260)	5900 (13010)	*9300 (20500)	*9300 (20500)	*7700 (16980)	*7700 (16980)
-3.0 m (-10')		5800 (12790)	3400 (7500)			6550 (14440)	3850 (8490)	*10350 (22820)	6000 (13230)	*14600 (32190)	12200 (26900)		
-4.5 m (-15')		*7150 (15760)	5250 (11570)					*8300 (18300)	6250 (13780)	*11650 (25680)	*11650 (25680)		
Arm length 2925 mm (9'7")													
7.5 m (25')		*2900 (6390)	*2900 (6390)			*4050 (8930)	*4050 (8930)						
6.0 m (20')		*2750 (6060)	*2750 (6060)	*3100 (6830)	3050 (6720)	*4250 (9370)	*4250 (9370)						
4.5 m (15')		*2750 (6060)	2550 (5620)	*4600 (10140)	3000 (6610)	*4850 (10690)	4500 (9920)	*5500 (12130)	*5500 (12130)				
3.0 m (10')		*2900 (6390)	2250 (4960)	4800 (10580)	2850 (6280)	*5900 (13010)	4200 (9260)	*7700 (16980)	6800 (14990)	*11600 (25570)	*11450 (25240)		
1.5 m (5')		*3200 (7050)	2150 (4740)	4600 (10140)	2750 (6060)	6700 (14770)	3950 (8710)	*9800 (21610)	6250 (13780)	*6800 (14990)	*6800 (14990)		
0 m (0')		*3700 (8160)	2200 (4850)	4500 (9920)	2600 (5730)	6500 (14330)	3750 (8270)	10550 (23260)	5850 (12900)	*5150 (11350)	*5150 (11350)		
-1.5 m (-5')		4150 (9150)	2400 (5290)	4450 (9810)	2550 (5620)	6350 (14000)	3650 (8050)	10400 (22930)	5750 (12680)	*9300 (20500)	*9300 (20500)	*5150 (11350)	*5150 (11350)
-3.0 m (-10')		4950 (10910)	2900 (6390)			6350 (14000)	3650 (8050)	*10400 (22930)	5800 (12790)	*14800 (32630)	11800 (26010)	*9700 (21380)	*9700 (21380)
-4.5 m (-15')		*6700 (14770)	4100 (9040)					*9100 (20060)	6000 (13230)	*12950 (28550)	*12000 (26460)		

* Load is limited hydraulic capacity rather than tipping.
 Ratings are based on SAE Standard No. J1097. Rated loads do not exceed 87% of hydraulic lift capacity or 75% of tipping load.

PC200-7

Conditions:

Boom: 5700 mm (18'8"), Bucket (SAE): 0.80 m³ (1.05 cu.yd), Shoes: 600 mm (24")

unit :kg (lb)

B	A	MAX		7.6 m (25')		6.1 m (20')		4.6 m (15')		3.0 m (10')		1.5 m (5')	
		Cf	Cs	Cf	Cs	Cf	Cs	Cf	Cs	Cf	Cs	Cf	Cs
Arm length 2925 mm (9'7")													
7.6 m (25')		*2500 (5600)	*2500 (5600)			*3500 (7700)	*3500 (7700)						
6.1 m (20')		*2400 (5300)	*2400 (5300)			*3950 (8700)	*3950 (8700)						
4.6 m (15')		*2400 (5300)	2150 (4800)	3950 (8800)	2600 (5700)	*4500 (9900)	3900 (8600)						
3.0 m (10')		*2550 (5600)	1950 (4300)	3850 (8500)	2500 (5500)	*5350 (11800)	3700 (8100)	*6750 (14900)	5850 (12900)	*10450 (23000)	*10450 (23000)		
1.5 m (5')		*2800 (6200)	1850 (4100)	3750 (8300)	2350 (5200)	5400 (11900)	3450 (7600)	*8550 (18900)	5350 (11800)	*6950 (15300)	*6950 (15300)		
0 m (0')		3050 (6700)	1900 (4200)	3650 (8000)	2300 (5000)	5200 (11500)	3250 (7200)	8250 (18200)	5050 (11100)	*7400 (16400)	*7400 (16400)		
-1.5 m (-5')		3350 (7400)	2050 (4600)	3600 (7900)	2250 (4900)	5100 (11200)	3150 (7000)	8100 (17900)	4900 (10800)	*10400 (22900)	9500 (20900)	*6300 (13900)	*6300 (13900)
-3.0 m (-10')		4000 (8800)	2500 (5500)			5100 (11200)	3150 (7000)	8100 (17900)	4950 (10900)	*14350 (31600)	9650 (21300)	*9800 (21600)	*9800 (21600)
-4.6 m (-15')		5650 (12500)	3550 (7900)					*8300 (18300)	5100 (11200)	*12000 (26400)	10000 (22000)		
Arm length 2410 mm (7'11")													
7.6 m (25')		*4000 (8800)	*4000 (8800)										
6.1 m (20')		*3750 (8300)	3000 (6600)			*4450 (9800)	3950 (8700)						
4.6 m (15')		3800 (8400)	2450 (5400)	3900 (8600)	2500 (5600)	*4950 (10900)	3800 (8400)	*5650 (12500)	*5650 (12500)				
3.0 m (10')		3400 (7500)	2150 (4800)	3800 (8400)	2450 (5400)	5600 (12300)	3600 (8000)	*7450 (16400)	5700 (12600)				
1.5 m (5')		3300 (7300)	2050 (4600)	3700 (8200)	2350 (5200)	5350 (11800)	3400 (7500)	8450 (18700)	5250 (11500)				
0 m (0')		3400 (7500)	2100 (4700)	3650 (8000)	2250 (5000)	5150 (11400)	3250 (7100)	8150 (18000)	4950 (11000)	*6800 (15000)	*6800 (15000)		
-1.5 m (-5')		3750 (8300)	2350 (5200)			5100 (11200)	3150 (7000)	8100 (17800)	4900 (10800)	*11400 (25100)	9500 (21000)	*7100 (15700)	*7100 (15700)
-3.0 m (-10')		4650 (10200)	2900 (6400)			5150 (11400)	3200 (7100)	8200 (18000)	4950 (11000)	*13500 (29800)	9750 (21500)	*11750 (26000)	*11750 (26000)
-4.6 m (-15')		*6600 (14500)	4550 (10000)					*7400 (16300)	5200 (11500)	*10600 (23400)	10150 (22400)		
Arm length 1840 mm (6')													
7.6 m (25')		*4450 (9800)	*4450 (9800)					*5050 (11100)	*5050 (11100)				
6.1 m (20')		*4100 (9100)	3450 (7600)			*5000 (11100)	3800 (8300)	*5250 (11600)	*5250 (11600)				
4.6 m (15')		4150 (9200)	2700 (6000)			*5400 (11900)	3700 (8100)	*6400 (14100)	6000 (13200)	*9100 (20100)	*9100 (20100)		
3.0 m (10')		3750 (8300)	2350 (5200)			5450 (12000)	3500 (7700)	*8000 (17600)	5350 (11800)				
1.5 m (5')		3600 (8000)	2250 (5000)	3650 (8100)	2300 (5000)	5250 (11500)	3300 (7300)	8250 (18200)	5000 (11100)				
0 m (0')		3750 (8200)	2300 (5100)			5100 (11200)	3150 (7000)	8050 (17700)	4850 (10700)				
-1.5 m (-5')		4200 (9300)	2650 (5800)			5050 (11200)	3150 (6900)	8050 (17700)	4850 (10700)	*12400 (27400)	9500 (21000)		
-3.0 m (-10')		5500 (12100)	3450 (7600)					8200 (18100)	5000 (11000)	*12100 (26700)	9800 (21600)		

* Load is limited by hydraulic capacity rather than tipping. Ratings are based on SAE Standard NO. J1097. Rated loads do not exceed 87% of hydraulic lift capacity or 75% of tipping load.

PC200LC-7

Conditions:

Boom: 5700 mm (18'8"), Bucket (SAE): 0.80 m³ (1.05 cu.yd), Shoes: 700 mm (28")

unit: kg (lb)

B	A	MAX		7.6 m (25')		6.1 m (20')		4.6 m (15')		3.0 m (10')		1.5 m (5')	
		Cf	Cs	Cf	Cs	Cf	Cs	Cf	Cs	Cf	Cs	Cf	Cs
Arm length 2925 mm (9'7")													
7.6 m (25')		*2500 (5600)	*2500 (5600)			*3500 (7700)	*3500 (7700)						
6.1 m (20')		*2400 (5300)	*2400 (5300)			*3950 (8700)	*3950 (8700)						
4.6 m (15')		*2400 (5300)	*2400 (5300)	*4300 (9400)	3000 (6600)	*4500 (9900)	4500 (9900)						
3.0 m (10')		*2550 (5600)	2300 (5100)	*4700 (10300)	2900 (6400)	*5350 (11800)	4250 (9400)	*6750 (14900)	*6750 (14900)	*10450 (23000)	*10450 (23000)		
1.5 m (5')		*2800 (6200)	2200 (4900)	4650 (10200)	2800 (6200)	*6300 (13900)	4000 (8900)	*8550 (18900)	6250 (13800)	*6950 (15300)	*6950 (15300)		
0 m (0')		*3250 (7100)	2250 (5000)	4550 (10000)	2700 (5900)	6450 (14300)	3850 (8400)	*9750 (21500)	5900 (13000)	*7400 (16400)	*7400 (16400)		
-1.5 m (-5')		*4000 (8800)	2450 (5400)	4500 (9900)	2650 (5800)	6350 (14000)	3750 (8200)	*10100 (22300)	5800 (12700)	*10400 (22900)	*10400 (22900)	*6300 (13900)	*6300 (13900)
-3.0 m (-10')		4950 (11000)	2950 (6500)			6350 (14000)	3750 (8200)	*9750 (21500)	5800 (12800)	*14350 (31600)	11500 (25400)	*9800 (21600)	*9800 (21600)
-4.6 m (-15')		*6150 (13600)	4150 (9200)					*8300 (18300)	6000 (13200)	*12000 (26400)	11900 (26000)		
Arm length 2410 mm (7'11")													
7.6 m (25')		*4000 (8800)	*4000 (8800)										
6.1 m (20')		*3750 (8300)	3500 (7700)			*4450 (9800)	*4450 (9800)						
4.6 m (15')		*3800 (8000)	2850 (6300)	*4350 (9600)	2950 (6500)	*4950 (10900)	4400 (9700)	*5650 (12500)	*5650 (12500)				
3.0 m (10')		*4050 (8900)	2550 (5600)	4700 (10400)	2850 (6300)	*5750 (12700)	4200 (9200)	*7450 (16400)	6600 (14600)				
1.5 m (5')		4100 (9000)	2450 (5400)	4600 (10200)	2750 (6100)	*6600 (14500)	3950 (8700)	*9050 (20000)	6100 (13500)				
0 m (0')		4200 (9300)	2500 (5500)	4550 (10000)	2700 (5900)	6450 (14200)	3800 (8400)	*9950 (22000)	5850 (12900)	*6800 (15000)	*6800 (15000)		
-1.5 m (-5')		4650 (10300)	2750 (7600)			6350 (14000)	3750 (8300)	*10100 (22200)	5800 (12900)	*11400 (25100)	*11400 (25100)	*7100 (15700)	*7100 (15700)
-3.0 m (-10')		5750 (12100)	3450 (7600)			6400 (14200)	3800 (8400)	*9400 (20700)	5850 (12900)	*13500 (29800)	11600 (25600)	*11750 (26000)	*11750 (26000)
-4.6 m (-15')		*6600 (14500)	5300 (11700)					*7400 (16300)	6100 (13500)	*10600 (23400)	*10600 (23400)		
Arm length 1840 mm (6')													
7.6 m (25')		*4450 (9800)	*4450 (9800)					*5050 (11100)	*5050 (11100)				
6.1 m (20')		*4100 (9100)	3950 (8800)			*5000 (11100)	4350 (9600)	*5250 (11600)	*5250 (11600)				
4.6 m (15')		*4150 (9200)	3150 (7000)			*5400 (11900)	4250 (9400)	*6400 (14100)	*6400 (14100)	*9100 (20100)	*9100 (20100)		
3.0 m (10')		*4400 (9700)	2800 (6200)			*6150 (13500)	4050 (9000)	*8000 (17600)	6250 (13700)				
1.5 m (5')		4500 (9900)	2650 (5900)	4550 (10000)	2700 (6000)	6500 (14300)	3850 (8500)	*9500 (20900)	5900 (13000)				
0 m (0')		4650 (10300)	2750 (6100)			6350 (14000)	3750 (8200)	*10050 (22100)	5700 (12600)				
-1.5 m (-5')		5250 (11600)	3100 (6900)			6350 (14000)	3700 (8200)	*9800 (21600)	5700 (12600)	*12400 (27400)	11350 (25100)		
-3.0 m (-10')		*6500 (14400)	4050 (8900)					*8750 (19300)	5900 (13000)	*12100 (26700)	11700 (25800)		

* Load is limited by hydraulic capacity rather than tipping. Ratings are based on SAE Standard NO. J1097. Rated loads do not exceed 87% of hydraulic lift capacity or 75% of tipping load.

PC210-10 (UK source)

Conditions:

One-piece boom: 5700 mm, Bucketless, Shoes: 600 mm

unit: kg

B	A	MAX		7.5 m		6.0 m		4.5 m		3.0 m		1.5 m	
		Cf	Cs	Cf	Cs	Cf	Cs	Cf	Cs	Cf	Cs	Cf	Cs
Arm length 2400 mm													
	7.5 m	*6100	5900										
	6.0 m	*5700	4300			*6020	5150	*6240	*6240				
	4.5 m	5080	3620			*6520	5010	*7600	*7600	*10410	*10410		
	3.0 m	4640	3290	4930	3500	6850	4790	*9530	7100				
	1.5 m	4500	3180	4830	3400	6620	4580	10110	6670				
	0 m	4630	3250	4760	3340	6460	4440	9880	6480				
	-1.5 m	5090	3560			6420	4400	9850	6450	*12410	12060		
	-3.0 m	6240	4310			6510	4480	9960	6540	*14520	12270		
Arm length 2900 mm													
	7.5 m	*4060	*4060			*4660	*4660						
	6.0 m	*3820	*3820			*5430	5210						
	4.5 m	*3800	3290	5050	3600	*6010	5050	*6810	*6810				
	3.0 m	*3930	3010	4940	3500	6890	4810	*8760	7220				
	1.5 m	4130	3910	4810	3380	6620	4580	10180	6720				
	0 m	4220	2960	4720	3290	6430	4400	9860	6440	*7200	*7200		
	-1.5 m	4570	3190	4690	3270	6350	4330	9760	6360	*11680	*11680	*7480	*7480
	-3.0 m	5420	3750			6380	4360	9820	6410	*15550	12010	*12100	*12100
	-4.5 m	*7280	5230					*9020	6620	*12560	12380		

* Load is limited hydraulic capacity rather than tipping.

Ratings are based on SAE Standard No.10567. Rated loads do not exceed 87% of hydraulic lift capacity or 75% of tipping load.

PC210LC-10 (UK source)

Conditions:

One-piece boom: 5700 mm, Bucketless, Shoes: 600 mm

unit: kg

B	A	MAX		7.5 m		6.0 m		4.5 m		3.0 m		1.5 m	
		Cf	Cs	Cf	Cs	Cf	Cs	Cf	Cs	Cf	Cs	Cf	Cs
Arm length 2400 mm													
	7.5 m	*6100	*6100										
	6.0 m	*5700	4780			*6020	5710	*6240	*6240				
	4.5 m	*5660	4030			*6520	5570	*7600	*7600	*10410	*10410		
	3.0 m	5470	3670	5810	3900	*7370	5340	*9530	7980				
	1.5 m	5320	3560	5710	3810	7890	5130	*11140	7540				
	0 m	5470	3640	5640	3740	7730	4990	*11820	7340				
	-1.5 m	6040	3990			7690	4950	*11640	7310	*12410	*12410		
	-3.0 m	7450	4840			7780	5030	*10600	7410	*14520	14180		
Arm length 2900 mm													
	7.5 m	*4060	*4060			*4660	*4660						
	6.0 m	*3820	*3820			*5430	*5430						
	4.5 m	*3800	3660	*5680	4010	*6010	5620	*6810	*6810				
	3.0 m	*3930	3360	5830	3900	*6920	5370	*8760	8100				
	1.5 m	*4210	3260	5700	3790	*7850	5130	*10570	7590				
	0 m	*4720	3320	5600	3700	7710	4950	*11570	7300	*7200	*7200		
	-1.5 m	5420	3580	5570	3670	7620	4880	*11700	7220	*11680	*11680	*7480	*7480
	-3.0 m	6450	4220			7650	4910	*11010	7270	*15550	13920	*12100	*12100
	-4.5 m	*7280	5890					*9020	7490	*12560	*12560		

* Load is limited hydraulic capacity rather than tipping.

Ratings are based on SAE Standard No. J1097. Rated loads do not exceed 87% of hydraulic lift capacity or 75% of tipping load.

PC210LC-10 (USA source)

Conditions:

Boom: 5700 mm (18'8"), Bucketless, Counterweight: 4720 kg (10,406 lb)

unit :kg (lb)

B	A	MAX		7.6 m (25')		6.1 m (20')		4.6 m (15')		3.0 m (10')	
		Cf	Cs	Cf	Cs	Cf	Cs	Cf	Cs	Cf	Cs
Arm length 2900 mm (9'7"), Shoes: 700 mm (28")											
7.6 m (25')		*4100 (9050)	*4100 (9050)								
6.1 m (20')		*3850 (8500)	*3850 (8500)			*6500 (14400)	6000 (13300)				
4.6 m (15')		*3800 (8400)	*3800 (8400)	*5250 (11550)	4200 (9350)	*7150 (15850)	5900 (13000)	*8000 (17700)	*8000 (17700)		
3.0 m (10')		*3950 (8700)	3650 (8100)	6100 (13450)	4150 (9150)	*8250 (18250)	5650 (12550)	*10350 (22850)	8500 (18800)	*12800 (28300)	*12800 (28300)
1.5 m (5')		*4200 (9300)	3550 (7900)	5950 (13200)	4050 (8950)	8250 (18250)	5450 (12050)	*12550 (27750)	8050 (17800)		
0 m (0')		*4750 (10450)	3650 (8050)	5900 (13000)	3950 (8750)	8100 (17850)	5300 (11700)	12650 (27950)	7800 (17250)	*7450 (16500)	*7450 (16500)
-1.5 m (-5')		*5650 (12500)	3950 (8700)	*5850 (12900)	3950 (8750)	8000 (17700)	5250 (11550)	12550 (27750)	7750 (17100)	*12000 (26500)	*12000 (26500)
-3.0 m (-10')		7000 (15450)	4650 (10300)			8050 (17800)	5250 (11650)	12650 (27900)	7800 (17200)	*18500 (40850)	14800 (32650)
-4.6 m (-15')		*8950 (19750)	6600 (14550)					*10750 (23750)	8050 (17800)	*15000 (33100)	*15000 (33100)
Arm length 2900 mm (9'7"), Shoes: 800 mm (31.5")											
7.6 m (25')		*4100 (9050)	*4100 (9050)								
6.1 m (20')		*3850 (8500)	*3850 (8500)			*6500 (14400)	6100 (13400)				
4.6 m (15')		*3800 (8400)	*3800 (8400)	*5250 (11550)	4250 (9450)	*7150 (15850)	5950 (13100)	*8000 (17700)	*8000 (17700)		
3.0 m (10')		*3950 (8700)	3700 (8200)	6150 (13600)	4200 (9250)	*8250 (18250)	5700 (12650)	*10350 (22850)	8600 (19000)	*12800 (28300)	*12800 (28300)
1.5 m (5')		*4200 (9300)	3600 (7950)	6050 (13350)	4100 (9050)	8350 (18450)	5500 (12150)	*12550 (27750)	8150 (18000)		
0 m (0')		*4750 (10450)	3650 (8150)	5950 (13150)	4000 (8850)	8200 (18050)	5350 (11850)	12800 (28250)	7900 (17400)	*7450 (16500)	*7450 (16500)
-1.5 m (-5')		*5650 (12500)	4000 (8800)	*5850 (12900)	4000 (8800)	8100 (17900)	5300 (11700)	12700 (28050)	7800 (17250)	*12000 (26500)	*12000 (26500)
-3.0 m (-10')		7100 (15650)	4700 (10400)			8150 (18000)	5350 (11800)	12800 (28200)	7850 (17400)	*18500 (40850)	14950 (33000)
-4.6 m (-15')		*8950 (19750)	6650 (14700)					*10750 (23750)	8150 (18000)	*15000 (33100)	*15000 (33100)

* Load is limited hydraulic capacity rather than tipping.
 Ratings are based on ISO Standard No.10567. Rated loads do not exceed 87% of hydraulic lift capacity or 75% of tipping load.

PC210LC-10 (USA source)

Conditions:

Boom: 5700 mm (18'8"), Bucketless, Counterweight: 3600 kg (7,937 lb)

unit :kg (lb)

B	A	MAX		7.6 m (25')		6.1 m (20')		4.6 m (15')		3.0 m (10')	
		Cf	Cs	Cf	Cs	Cf	Cs	Cf	Cs	Cf	Cs
Arm length 2900 mm (9'7"), Shoes: 700 mm (28")											
7.6 m (25')		*4100 (9050)	*4100 (9050)								
6.1 m (20')		*3850 (8500)	*3850 (8500)			*6500 (14400)	5350 (11850)				
4.6 m (15')		*3800 (8400)	3500 (7750)	*5250 (11550)	3700 (8250)	*7150 (15850)	5200 (11550)	*8000 (17700)	*8000 (17700)		
3.0 m (10')		*3950 (8700)	3200 (7100)	5450 (12050)	3650 (8050)	7650 (16900)	5000 (11050)	*10350 (22850)	7550 (16700)	*12800 (28300)	*12800 (28300)
1.5 m (5')		*4200 (9300)	3100 (6900)	5350 (11800)	3550 (7800)	7400 (16350)	4800 (10600)	11650 (25650)	7100 (15650)		
0 m (0')		*4750 (10450)	3150 (7000)	5250 (11650)	3450 (7650)	7250 (16000)	4650 (10250)	11300 (25000)	6850 (15100)	*7450 (16500)	*7450 (16500)
-1.5 m (-5')		*5250 (11550)	3450 (7600)	5250 (11600)	3450 (7600)	7150 (15800)	4550 (10100)	11250 (24800)	6750 (14950)	*12000 (26500)	*12000 (26500)
-3.0 m (-10')		6250 (13850)	4050 (9000)			7200 (15900)	4600 (10200)	11300 (24950)	6800 (15100)	*18500 (40850)	13000 (28700)
-4.6 m (-15')		*8950 (19750)	5800 (12800)					*10750 (23750)	7100 (15700)	*15000 (33100)	*15000 (33100)
Arm length 2900 mm (9'7"), Shoes: 800 mm (31.5")											
7.6 m (25')		*4100 (9050)	*4100 (9050)								
6.1 m (20')		*3850 (8500)	*3850 (8500)			*6500 (14400)	5400 (11950)				
4.6 m (15')		*3800 (8400)	3550 (7850)	*5250 (11550)	3750 (8350)	*7150 (15850)	5300 (11650)	*8000 (17700)	*8000 (17700)		
3.0 m (10')		*3950 (8700)	3250 (7200)	5500 (12200)	3700 (8150)	7750 (17100)	5050 (11200)	*10350 (22850)	7650 (16850)	*12800 (28300)	*12800 (28300)
1.5 m (5')		*4200 (9300)	3150 (6950)	5400 (11950)	3600 (7900)	7500 (16550)	4850 (10700)	11750 (25950)	7200 (15850)		
0 m (0')		*4750 (10450)	3200 (7100)	5350 (11750)	3500 (7750)	7300 (16200)	4700 (10400)	11450 (25300)	6900 (15300)	*7450 (16500)	*7450 (16500)
-1.5 m (-5')		5300 (11700)	3500 (7700)	5300 (11750)	3500 (7700)	7250 (16000)	4650 (10250)	11350 (25100)	6850 (15100)	*12000 (26500)	*12000 (26500)
-3.0 m (-10')		6350 (14000)	4100 (9100)			7300 (16100)	4650 (10300)	11450 (25250)	6900 (15250)	*18500 (40850)	13150 (29050)
-4.6 m (-15')		*8950 (19750)	5850 (12950)					*10750 (23750)	7200 (15850)	*15000 (33100)	13550 (29850)

* Load is limited hydraulic capacity rather than tipping. Ratings are based on ISO Standard No.10567. Rated loads do not exceed 87% of hydraulic lift capacity or 75% of tipping load.

PC210LC-8 (India source)

Conditions:

Boom: 5700 mm, Bucket (SAE): 1.05 m³, Shoes: 600 mm

unit: kg

B	A	MAX		7.5 m		6.0 m		4.5 m		3.0 m		1.5 m	
		Cf	Cs	Cf	Cs	Cf	Cs	Cf	Cs	Cf	Cs	Cf	Cs
Arm length 2900 mm													
7.5 m		*2800	*2800			*4150	*4150						
6.0 m		*2650	*2650	*3450	3200	*4250	*4250						
4.5 m		*2650	2500	*4550	3150	*4850	4750	*5400	*5400				
3.0 m		*2750	2250	4900	3050	*5800	4450	*7350	7100	*11450	*11450		
1.5 m		*3000	2200	4750	2900	*6750	4150	*9250	6450	*6350	*6350		
0 m		*3400	2200	4600	2750	6600	3950	*10450	6050	*7200	*7200		
-1.5 m		4050	2400	4550	2700	6450	3800	10450	5900	*10450	*10450	*6300	*6300
-3.0 m		4800	2900			6450	3850	*10450	5950	*15250	11900	*10050	*10050
-4.5 m		*6300	4000					*9000		*12950	12350		
Arm length 2400 mm													
7.5 m		*4150	*4150										
6.0 m		*3950	*3450			*4750	*4750						
4.5 m		*3950	2850	4950	3100	*5350	4650	*6200	*6200				
3.0 m		4150	2550	4850	3000	*6200	4350	*8050	6900				
1.5 m		4050	2450	4700	2850	6750	4100	*9800	6350				
0 m		4150	2500	4600	2750	6550	3900	10550	6000	*6750	*6750		
-1.5 m		4600	2750	4600	2750	6450	3850	10550	5950	*11600	*11600	*7300	*7300
-3.0 m		5650	3400			6550	3900	*10550	6050	*14500	12100	*12150	*12150
-4.5 m		*6300	5150					*8100	6300	*11500	*11500		

* Load is limited hydraulic capacity rather than tipping.
 Ratings are based on SAE Standard No. J1097. Rated loads do not exceed 87% of hydraulic lift capacity or 75% of tipping load.

PC210NLC-8 (UK source)

Conditions: Boom: 5700 mm, Bucket (SAE): 0.84 m³, Shoes: 500 mm, Lifting capacities, including bucket (760 kg), bucket linkage (200 kg) and bucket cylinder (140 kg) unit: kg

B	A	MAX		7.5 m		6.0 m		4.5 m		3.0 m		1.5 m	
		Cf	Cs	Cf	Cs	Cf	Cs	Cf	Cs	Cf	Cs	Cf	Cs
Arm length 2900 mm													
7.5 m		*2800	*2800			*4150	*4150						
6.0 m		*2650	2550	*3450	2750	*4250	*4250						
4.5 m		*2650	2150	*4550	2700	*4850	4100	*5400	*5400				
3.0 m		*2750	1900	4950	2600	*5800	3800	*7350	6050	*11450	*11450		
1.5 m		*3000	1800	4800	2450	*6750	3550	*9250	5350	*6350	*6350		
0 m		*3400	1850	4650	2350	6650	3300	*10450	5100	*7200	*7200		
-1.5 m		4100	2000	4600	2300	6500	3150	10600	4800	*10450	8800	*6300	*6300
-3.0 m		4850	2400			6550	3200	*10450	4950	*15250	9600	*10050	*10050
-4.5 m		*6300	3400					*9000	5150	*12950	10000		
Arm length 2400 mm													
7.5 m		*4150	4150										
6.0 m		*3950	2950			*4750	4150						
4.5 m		*3950	2450	*4950	2650	*5350	4000	*6200	*6200				
3.0 m		*4200	2150	4900	2550	*6200	3750	*8050	5850				
1.5 m		4100	2050	4750	2400	6850	3500	*9800	5200				
0 m		4200	2100	4650	2350	6650	3300	10700	5050	*6750	*6750		
-1.5 m		4650	2300	4650	2300	6550	3200	10600	4800	*11600	8900	*7300	*7300
-3.0 m		5700	2850			6600	3300	*10150	5050	*14500	9750	*12150	*12150
-4.5 m		*6800	4350					*8100	5300	*11500	10250		
Arm length 1800 mm													
7.5 m		*4950	*4950										
6.0 m		*4550	3400			*5450	4050	*5750	*5750				
4.5 m		*4550	2750			*5900	3950	*7100	6300	*10050	*10050		
3.0 m		4650	2400	4850	2550	*6700	3700	*8900	5700				
1.5 m		4500	2300	4750	2450	6800	3450	*10400	5100				
0 m		4700	2350	4700	2400	6600	3300	10650	5000				
-1.5 m		5250	2650			6600	3250	10650	4850	*12100	9050		
-3.0 m		6750	3400			6800	3450	*9600	5200	*13150	10000		
-4.5 m													

* Load is limited by hydraulic capacity rather than tipping.
 Ratings are based on SAE Standard NO. J1097. Rated loads do not exceed 87% of hydraulic lift capacity or 75% of tipping load.

PC220-8

Conditions: Boom: 5850 mm (19'2"), Bucket (SAE): 1.0 m³ (1.31 cu.yd), Shoes: 600 mm (24") unit: kg (lb)

B	A	MAX		7.6 m (25')		6.1 m (20')		4.6 m (15')		3.0 m (10')		1.5 m (5')	
		Cf	Cs	Cf	Cs	Cf	Cs	Cf	Cs	Cf	Cs	Cf	Cs
Arm length 3045 mm (10'0")													
7.6 m (25')		*3150 (7000)	*3150 (7000)			*4300 (9500)	*4300 (9500)						
6.1 m (20')		*3050 (6700)	*3050 (6700)	*4050 (8900)	3500 (7800)	*4500 (9900)	*4500 (9900)						
4.6 m (15')		*3050 (6700)	2750 (6000)	5050 (11100)	3450 (7600)	*5250 (11600)	*5200 (11400)						
3.0 m (10')		*3250 (7100)	2450 (5500)	4900 (10800)	3350 (7400)	*6450 (14200)	4900 (10800)	*8150 (17900)	7800 (17200)	*12850 (28300)	*12850 (28300)		
1.5 m (5')		*3550 (7800)	2350 (5200)	4750 (10400)	3200 (7000)	6850 (15100)	4600 (10100)	*10550 (23300)	7150 (15700)	*7400 (16300)	*7400 (16300)		
0 m (0')		3650 (8100)	2400 (5300)	4600 (10100)	3050 (6700)	6550 (14500)	4350 (9600)	10500 (23200)	6700 (14800)	*8400 (18500)	*8400 (18500)		
-1.5 m (-5')		4000 (8800)	2600 (5800)	4550 (10000)	3000 (6600)	6450 (14200)	4200 (9300)	10300 (22700)	6550 (14400)	*12000 (26400)	*12000 (26400)	*7450 (16400)	*7450 (16400)
-3.0 m (-10')		4700 (10400)	3100 (6900)			6400 (14200)	4200 (9300)	10350 (22800)	6550 (14400)	*17300 (38100)	13100 (28900)	*11150 (25500)	*11150 (25500)
-4.6 m (-15')		6500 (14300)	4300 (9500)			6600 (14500)	4350 (9600)	*10550 (23300)	6750 (14900)	*16550 (36500)	13500 (29800)		
Arm length 2500 mm (8'2")													
7.6 m (25')		*5150 (11400)	*5150 (11400)										
6.1 m (20')		*4850 (10700)	4100 (9100)			*5700 (12500)	5100 (11300)						
4.6 m (15')		4900 (10800)	3300 (7300)			*6350 (14000)	4950 (10900)	*7450 (16500)	*7450 (16500)	*10600 (23400)	*10600 (23400)		
3.0 m (10')		4400 (9700)	2950 (6500)	4750 (10400)	3200 (7000)	6900 (15200)	4650 (10300)	*9650 (21300)	7100 (15700)				
1.5 m (5')		4250 (9400)	2800 (6200)	4600 (10200)	3050 (6800)	6600 (14600)	4400 (9700)	10500 (23100)	6700 (14800)				
0 m (0')		4400 (9700)	2900 (6400)	4550 (10000)	3000 (6600)	6400 (14200)	4200 (9300)	10200 (22500)	6450 (14200)				
-1.5 m (-5')		4900 (10800)	3250 (7100)			6350 (14100)	4150 (9200)	10200 (22500)	6450 (14200)	*13950 (30800)	12900 (28400)		
-3.0 m (-10')		6200 (13700)	4100 (9100)			6500 (14300)	4300 (9400)	10400 (22900)	6600 (14600)	*16750 (36900)	13250 (29200)		
-4.6 m (-15')		*8900 (19500)	6800 (15000)					*9100 (20100)	7000 (15500)				
Arm length 2000 mm (6'7")													
7.6 m (25')		*4950 (11000)	*4950 (11000)			*5000 (11100)	*5000 (11100)						
6.1 m (20')		*4750 (10500)	3750 (8300)			*5100 (11300)	*5100 (11300)						
4.6 m (15')		4550 (10000)	3100 (6800)	4950 (10900)	3350 (7400)	*5850 (12900)	5050 (11100)	*6650 (14700)	*6650 (14700)				
3.0 m (10')		4100 (9100)	2750 (6100)	4800 (10600)	3250 (7200)	*6950 (15300)	4750 (10500)	*9000 (19900)	7500 (16600)				
1.5 m (5')		3950 (8700)	2600 (5800)	4650 (10300)	3100 (6900)	6700 (14800)	4450 (9900)	10700 (23600)	6900 (15200)				
0 m (0')		4050 (9000)	2700 (5900)	4550 (10000)	3000 (6600)	6450 (14300)	4250 (9400)	10300 (22800)	6550 (14500)	*7850 (17300)	*7850 (17300)		
-1.5 m (-5')		4500 (9900)	2950 (6500)	4500 (10000)	3000 (6600)	6400 (14100)	4200 (9200)	10200 (22500)	6450 (14300)	*13400 (29500)	12850 (28300)	*8650 (19000)	*8650 (19000)
-3.0 m (-10')		5500 (12100)	3650 (8000)			6450 (14200)	4250 (9300)	10350 (22800)	6550 (14500)	*17900 (39500)	13100 (28900)	*14150 (31200)	*14150 (31200)
-4.6 m (-15')		*8350 (18400)	5500 (12100)					*10250 (22600)	6650 (14700)	*14950 (32900)	13650 (30100)		

* Load is limited by hydraulic capacity rather than tipping. Ratings are based on SAE Standard NO. J1097. Rated loads do not exceed 87% of hydraulic lift capacity or 75% of tipping load.

PC220LC-8

Conditions: Boom: 5850 mm (19'2"), Bucket (SAE): 1.0 m³ (1.31 cu.yd), Shoes: 700 mm (28") unit: kg (lb)

B	MAX		7.6 m (25')		6.1 m (20')		4.6 m (15')		3.0 m (10')		1.5 m (5')	
	Cf	Cs	Cf	Cs	Cf	Cs	Cf	Cs	Cf	Cs	Cf	Cs
Arm length 3045 mm (10'0")												
7.6 m (25')	*3150 (7000)	*3150 (7000)			*4300 (9500)	*4300 (9500)						
6.1 m (20')	*3050 (6700)	*3050 (6700)	*4050 (8900)	*4050 (8900)	*4500 (9900)	*4500 (9900)						
4.6 m (15')	*3050 (6700)	*3050 (6700)	*5050 (11100)	4000 (8800)	*5250 (11600)	*5250 (11600)						
3.0 m (10')	*3250 (7100)	2900 (6400)	*5650 (12500)	3850 (8500)	*6450 (14200)	5650 (12400)	*8150 (17900)	*8150 (17900)	*12850 (28300)	*12850 (28300)		
1.5 m (5')	*3550 (7800)	2800 (6200)	5800 (12800)	3700 (8200)	*7700 (17000)	5350 (11700)	*10550 (23300)	8300 (18300)	*7400 (16300)	*7400 (16300)		
0 m (0')	*4050 (9000)	2850 (6300)	5650 (12500)	3600 (7900)	8100 (17900)	5100 (11200)	*12200 (26900)	7900 (17400)	*8400 (18500)	*8400 (18500)		
-1.5 m (-5')	4900 (10800)	3100 (6800)	5600 (12300)	3500 (7800)	7950 (17500)	4950 (10900)	*12900 (28400)	7700 (17000)	*12000 (26400)	12000 (26400)	*7450 (16400)	*7450 (16400)
-3.0 m (-10')	5800 (12800)	3650 (8100)			7950 (17500)	4950 (10900)	*12700 (28000)	7750 (17000)	*17300 (38100)	15700 (34600)	*11500 (25500)	*11500 (25500)
-4.6 m (-15')	*7950 (17600)	5050 (11100)			*8100 (17800)	5100 (11300)	*11350 (25100)	7950 (17500)	*16550 (36500)	16150 (35600)		
Arm length 2500 mm (8'2")												
7.6 m (25')	*5150 (11400)	*5150 (11400)										
6.1 m (20')	*4850 (10700)	4750 (10500)			*5700 (12500)	*5700 (12500)						
4.6 m (15')	*4900 (10800)	3850 (8500)			*6350 (14000)	5700 (12500)	*7450 (16500)	*7450 (16500)	*10600 (23400)	*10600 (23400)		
3.0 m (10')	*5200 (11500)	3450 (7600)	*5800 (12800)	3700 (8200)	*7350 (16300)	5400 (11900)	*9650 (21300)	8300 (18300)				
1.5 m (5')	5200 (11500)	3300 (7300)	5650 (12500)	3600 (7900)	8150 (18000)	5100 (11300)	*11750 (25900)	7850 (17300)				
0 m (0')	5400 (11900)	3400 (7500)	5600 (12300)	3500 (7700)	7950 (17500)	4950 (10900)	*12700 (28000)	7600 (16800)				
-1.5 m (-5')	6050 (13300)	3800 (8400)			7900 (17400)	4900 (10800)	*12700 (28000)	7600 (16800)	*13950 (30800)	*13950 (30800)		
-3.0 m (-10')	*7650 (16600)	4800 (10600)			8050 (17700)	5000 (11100)	*11800 (26100)	7750 (17100)	*16750 (36900)	*15850 (34900)		
-4.6 m (-15')	*8900 (19600)	7950 (17500)					*9100 (20100)	8200 (18000)				
Arm length 2000 mm (6'7")												
7.6 m (25')	*4950 (11000)	*4950 (11000)			*5000 (11100)	*5000 (11100)						
6.1 m (20')	*4750 (10500)	4350 (9600)			*5100 (11300)	*5100 (11300)						
4.6 m (15')	*4850 (10700)	3600 (7900)	*5500 (12200)	3900 (8600)	*5850 (12900)	5800 (12800)	*6650 (14700)	*6650 (14700)				
3.0 m (10')	5050 (11100)	3250 (7100)	5900 (13000)	3800 (8400)	*6950 (15300)	5500 (12100)	*9000 (19900)	8700 (19200)				
1.5 m (5')	4850 (10800)	3100 (5800)	5700 (12600)	3650 (8000)	*8100 (17900)	5200 (11500)	*11200 (24800)	8050 (17800)				
0 m (0')	5000 (11100)	3150 (7000)	5600 (12400)	3550 (7800)	8000 (17600)	5000 (11000)	*12500 (27600)	7700 (17000)	*7850 (17300)	*7850 (17300)		
-1.5 m (-5')	5550 (12200)	3500 (7700)	5550 (12300)	3500 (7700)	7900 (17400)	4900 (10800)	*12850 (28300)	7650 (16800)	*13400 (29500)	*13400 (29500)	*8650 (19000)	*8650 (19000)
-3.0 m (-10')	6800 (14900)	4250 (9400)			7950 (17600)	4950 (10900)	*12300 (27100)	7700 (17000)	*17900 (39500)	15700 (34700)	*14150 (31200)	*14150 (31200)
-4.6 m (-15')	*8750 (19300)	6400 (14100)					*10250 (22600)	7800 (17200)	*14950 (32900)	*14950 (32900)		

* Load is limited by hydraulic capacity rather than tipping. Ratings are based on SAE Standard NO. J1097. Rated loads do not exceed 87% of hydraulic lift capacity or 75% of tipping load.

PC220-8M0

Conditions:

Boom: 5850 mm (19'2"), Bucket (SAE): 1.0 m³ (1.31 cu.yd), Shoes: 600 mm (24")

unit: kg (lb)

B	A	MAX		7.5 m (25')		6.0 m (20')		4.5 m (15')		3.0 m (10')		1.5 m (5')	
		Cf	Cs	Cf	Cs	Cf	Cs	Cf	Cs	Cf	Cs	Cf	Cs
Arm length 2000 mm (6'7")													
	7.5 m (25')	*5400 (11900)	*5400 (11900)										
	6.0 m (20')	*5150 (11400)	4200 (9300)			*5750 (12700)	5300 (11700)						
	4.5 m (15')	5000 (11000)	3400 (7500)	5000 (11000)	3400 (7500)	*6500 (14300)	5050 (11100)	*7950 (17500)	*7950 (17500)	*11200 (24700)	*11200 (24700)		
	3.0 m (10')	4500 (9900)	3050 (6700)	4900 (10800)	3300 (7300)	7100 (15650)	4800 (10600)	*10950 (24100)	7500 (16500)				
	1.5 m (5')	4350 (9600)	2900 (6400)	4750 (10500)	3150 (6900)	6800 (15000)	4500 (9900)	10850 (23900)	6950 (15300)				
	0 m (0')	4500 (9900)	2950 (6500)	4650 (10300)	3050 (6700)	6600 (14600)	4350 (9600)	10600 (23400)	6750 (14900)				
	-1.5 m (-5')	5000 (11000)	3300 (7300)			6550 (14400)	4300 (9500)	10650 (23500)	6750 (14900)	*8900 (19600)	*8900 (19600)		
	-3.0 m (-10')	6350 (14000)	4200 (9300)			6700 (14800)	4400 (9700)	10800 (23800)	6900 (15200)	*16650 (36700)	13950 (30800)		
	-4.5 m (-15')	*8950 (19700)	6850 (15100)					*9550 (21100)	7200 (15900)				
Arm length 2500 mm (8'2")													
	7.5 m (25')	*5300 (11700)	*5300 (11700)			*5250 (11600)	*5250 (11600)						
	6.0 m (20')	*5100 (11200)	3900 (8600)			*5200 (11500)	*5200 (11500)						
	4.5 m (15')	4700 (10400)	3200 (7100)	5150 (11400)	3500 (7700)	*6000 (13200)	5200 (11500)	*7100 (15700)	*7100 (15700)				
	3.0 m (10')	4250 (9400)	2850 (6300)	5000 (11000)	3350 (7400)	7200 (15900)	4900 (10800)	*9900 (21800)	7750 (17100)				
	1.5 m (5')	4100 (9000)	2750 (6050)	4800 (10600)	3200 (7100)	6900 (15200)	4600 (10100)	11050 (24400)	7100 (15700)				
	0 m (0')	4200 (9300)	2750 (6100)	4700 (10400)	3100 (6800)	6700 (14800)	4400 (9700)	10700 (23600)	6800 (15000)				
	-1.5 m (-5')	4600 (10100)	3050 (6700)	4650 (10300)	3050 (6700)	6600 (14600)	4300 (9500)	10600 (23400)	6700 (14800)	*10100 (22300)	*10100 (22300)	*8950 (19700)	*8950 (19700)
	-3.0 m (-10')	5650 (12500)	3700 (8200)			6650 (14700)	4350 (9600)	10750 (23700)	6850 (15100)	*17950 (39600)	13900 (30600)	*10050 (22200)	*10050 (22200)
	-4.5 m (-15')	8500 (18700)	5600 (12400)					*10700 (23600)	7100 (15700)	*15150 (33400)	14150 (31200)		
Arm length 3045 mm (9'12")													
	7.5 m (25')	*3350 (7400)	*3350 (7400)			*4350 (9600)	*4350 (9600)						
	6.0 m (20')	*3200 (7100)	*3200 (7100)	*4700 (10400)	3650 (8100)	*4450 (9800)	*4450 (9800)						
	4.5 m (15')	*3250 (7200)	2750 (6100)	*5050 (11100)	3550 (7800)	*5300 (11700)	5300 (11700)						
	3.0 m (10')	*3400 (7500)	2500 (5500)	5000 (11000)	3350 (7400)	*6600 (14600)	4950 (10900)	*8700 (19200)	7900 (17400)	*11950 (26350)	*11950 (26350)		
	1.5 m (5')	3600 (7900)	2350 (5200)	4800 (10600)	3200 (7100)	6950 (15300)	4600 (10100)	10950 (24100)	7200 (15800)	*6750 (14900)	*6750 (14900)		
	0 m (0')	3650 (8100)	2400 (5300)	4650 (10300)	3050 (6700)	6650 (14700)	4350 (9600)	10650 (23500)	6750 (14900)	*8250 (18190)	*8250 (18200)		
	-1.5 m (-5')	4000 (8800)	2600 (5700)	4550 (10000)	3000 (6600)	6500 (14300)	4200 (9300)	10500 (23200)	6600 (14600)	*9850 (21700)	*9850 (21700)	*7650 (16900)	*7650 (16900)
	-3.0 m (-10')	4700 (10400)	3100 (6800)	4600 (10100)	3000 (6600)	6500 (14300)	4200 (9300)	10550 (23300)	6650 (14700)	*17800 (39250)	13550 (29900)	*10600 (23400)	*10600 (23400)
	-4.5 m (-15')	6450 (14200)	4250 (9400)			6700 (14800)	4400 (9700)	10600 (23300)	6900 (15200)	*16550 (36490)	14000 (30900)		

* Load is limited hydraulic capacity rather than tipping.
 Ratings are based on SAE Standard No. J1097. Rated loads do not exceed 87% of hydraulic lift capacity or 75% of tipping load.

PC220LC-8M0

Conditions:

Boom: 5850 mm (19'2"), Bucket (SAE): 1.0 m³ (1.31 cu.yd), Shoes: 700 mm (27.5")

unit: kg (lb)

B	A	MAX		7.5 m (25')		6.0 m (20')		4.5 m (15')		3.0 m (10')		1.5 m (5')	
		Cf	Cs	Cf	Cs	Cf	Cs	Cf	Cs	Cf	Cs	Cf	Cs
Arm length 2000 mm (6'7")													
	7.5 m (25')	*5400 (11900)	*5400 (11900)										
	6.0 m (20')	*5150 (11400)	4850 (10700)			*5750 (12700)	*5750 (12700)						
	4.5 m (15')	*5200 (11500)	3950 (8700)	*6000 (13200)	3950 (8700)	*6500 (14300)	5850 (12900)	*7950 (17500)	*7950 (17500)	*11200 (24700)	*11200 (24700)		
	3.0 m (10')	*5500 (12100)	3550 (7800)	6000 (13200)	3850 (8500)	*7650 (16900)	5550 (12200)	*10950 (24100)	8700 (19200)				
	1.5 m (5')	5350 (11800)	3400 (7500)	5850 (12900)	3700 (8200)	8400 (18500)	5300 (11700)	*12200 (26900)	8150 (18000)				
	0 m (0')	5500 (12100)	3500 (7700)	5750 (12700)	3600 (7900)	8200 (18100)	5100 (11200)	*13050 (28800)	7900 (17400)				
	-1.5 m (-5')	6150 (13600)	3900 (8600)			8150 (18000)	5050 (11100)	*13000 (28700)	7950 (17500)	*8900 (19600)	*8900 (19600)		
	-3.0 m (-10')	7800 (17200)	4900 (10800)			8250 (18200)	5150 (11400)	*12100 (26700)	8100 (17900)	*16650 (36700)	*16650 (36700)		
	-4.5 m (-15')	*8950 (19700)	8000 (17600)					*9550 (21100)	8400 (18500)				
Arm length 2500 mm (8'2")													
	7.5 m (25')	*5300 (11700)	*5300 (11700)			*5250 (11600)	*5250 (11600)						
	6.0 m (20')	*5100 (11200)	4450 (9800)			*5200 (11500)	*5200 (11500)						
	4.5 m (15')	*5200 (11500)	3700 (8200)	*5600 (12400)	4100 (9000)	*6000 (13200)	*6000 (13200)	*7100 (15700)	*7100 (15700)				
	3.0 m (10')	5200 (11500)	3350 (7400)	6050 (12300)	3900 (8600)	*7250 (16000)	5650 (12500)	*9900 (21800)	8950 (19700)				
	1.5 m (5')	5000 (11000)	3200 (7100)	5900 (13000)	3750 (8300)	8450 (18600)	5350 (11800)	*12200 (26900)	8300 (18300)				
	0 m (0')	5150 (11400)	3250 (7200)	5800 (12800)	3650 (8100)	8250 (18200)	5150 (11400)	*13050 (28800)	7950 (17500)				
	-1.5 m (-5')	5700 (12600)	3600 (7900)	5750 (12700)	3600 (7900)	8150 (18000)	5050 (11100)	*13100 (28900)	7900 (17400)	*10100 (22300)	*10100 (22300)	*8950 (19700)	*8950 (19700)
	-3.0 m (-10')	6950 (15300)	4350 (9600)			8200 (18100)	5100 (11200)	*12550 (27000)	8000 (17600)	*17950 (39600)	*16450 (36300)	*10050 (22200)	*10050 (22200)
	-4.5 m (-15')	*8800 (19400)	6500 (14300)					*10700 (23600)	8300 (18300)	*15150 (33400)	*15150 (33400)		
Arm length 3045 mm (9'12")													
	7.5 m (25')	*3350 (7400)	*3350 (7400)			*4350 (9600)	*4350 (9600)						
	6.0 m (20')	*3200 (7100)	*3200 (7100)	*4700 (10400)	4200 (9300)	*4450 (9800)	*4450 (9800)						
	4.5 m (15')	*3250 (7200)	3250 (7200)	*5050 (11100)	4100 (9000)	*5300 (11700)	*5300 (11700)						
	3.0 m (10')	*3400 (7500)	2900 (6400)	*5650 (12500)	3900 (8600)	*6600 (14600)	5700 (12600)	*8700 (19200)	*8700 (19200)	*11950 (26400)	*11950 (26400)		
	1.5 m (5')	*3750 (8300)	2800 (6200)	5900 (13000)	3750 (8300)	*7900 (17400)	5350 (11800)	*11300 (24900)	8400 (18500)	*6750 (14900)	*6750 (14900)		
	0 m (0')	*4250 (9400)	2850 (6300)	5750 (12700)	3600 (7900)	8250 (18200)	5100 (11200)	*12650 (27900)	7950 (17500)	*8250 (18200)	*8250 (18200)		
	-1.5 m (-5')	4950 (10900)	3100 (6800)	5650 (12500)	3550 (7800)	8050 (17800)	4950 (10900)	*12950 (28600)	7800 (17200)	*9850 (21700)	*9850 (21700)	*7650 (16900)	*7650 (16900)
	-3.0 m (-10')	5800 (12800)	3650 (8100)	5700 (12600)	3550 (7800)	8050 (17800)	5000 (11000)	*12750 (28100)	7850 (17300)	*17800 (39200)	16250 (35800)	*10600 (23400)	*10600 (23400)
	-4.5 m (-15')	*7900 (17400)	5000 (11000)			*8200 (18100)	5150 (11400)	*11550 (25500)	8100 (17900)	*16550 (36500)	*16550 (36500)		

* Load is limited hydraulic capacity rather than tipping. Ratings are based on SAE Standard No.10567. Rated loads do not exceed 87% of hydraulic lift capacity or 75% of tipping load.

PC220-7

Conditions:

Conditions: Boom: 5850 mm (19'2"), Bucket (SAE): 1.0 m³ (1.31 cu.yd), Shoes: 600 mm (24") unit: kg (lb)

B	A	MAX		7.6 m (25')		6.1 m (20')		4.6 m (15')		3.0 m (10')		1.5 m (5')	
		Cf	Cs	Cf	Cs	Cf	Cs	Cf	Cs	Cf	Cs	Cf	Cs
Arm length 3045 mm (10'0")													
7.6 m (25')		*2900 (6400)	*2900 (6400)			*3900 (8700)	*3900 (8700)						
6.1 m (20')		*2750 (6100)	*2750 (6100)	*3700 (8200)	3500 (7800)	*4100 (9000)	*4100 (9000)						
4.6 m (15')		*2800 (6200)	2750 (6000)	*4600 (10100)	3450 (7600)	*4800 (10600)	*4800 (10600)						
3.0 m (10')		*2950 (6500)	2450 (5500)	4900 (10800)	3350 (7400)	*5900 (13000)	4900 (10800)	*7450 (17900)	*7450 (17900)	*11800 (26000)	*11800 (26000)		
1.5 m (5')		*3250 (7200)	2350 (5200)	4750 (10400)	3200 (7000)	6850 (15100)	4600 (10100)	*9700 (21400)	7150 (15700)	*6850 (15100)	*6850 (15100)		
0 m (0')		3650 (8100)	2400 (5300)	4600 (10100)	3050 (6700)	6550 (14500)	4350 (9600)	10500 (23200)	6700 (14800)	*7800 (17100)	*7800 (17100)		
-1.5 m (-5')		4000 (8800)	2600 (5800)	4550 (10000)	3000 (6600)	6450 (14200)	4200 (9300)	10300 (22700)	6550 (14400)	*11150 (24600)	*11150 (24600)	*6900 (15200)	*6900 (15200)
-3.0 m (-10')		4700 (10400)	3100 (6900)			6400 (14200)	4200 (9300)	10350 (22800)	6550 (14500)	*16050 (35400)	13100 (28900)	*10750 (23700)	*10750 (23700)
-4.6 m (-15')		6500 (14300)	4300 (9500)			6600 (14500)	4350 (9600)	*10400 (23000)	6750 (14900)	*15200 (33500)	13500 (29800)		
Arm length 2500 mm (8'2")													
7.6 m (25')		*4600 (10100)	*4600 (10100)			*4650 (10200)	*4650 (10200)						
6.1 m (20')		*4400 (9700)	3750 (8300)			*4650 (10300)	*4650 (10300)						
4.6 m (15')		*4450 (9800)	3100 (6800)	4950 (10900)	3350 (7400)	*5350 (11700)	5050 (11100)	*6100 (13500)	*6100 (13500)				
3.0 m (10')		4100 (9100)	2750 (6100)	4800 (10600)	3250 (7200)	*6350 (14000)	4750 (10500)	8250 (18200)	7500 (16600)				
1.5 m (5')		3950 (8700)	2600 (5800)	4650 (10300)	3100 (6900)	6700 (14800)	4450 (9900)	*10300 (22700)	6900 (15200)				
0 m (0')		4050 (9000)	2700 (5900)	4550 (10000)	3000 (6600)	6450 (14300)	4250 (9400)	10300 (22800)	6550 (14500)	*7250 (16000)	*7250 (16000)		
-1.5 m (-5')		4500 (9900)	2950 (6500)	4500 (10000)	3000 (6600)	6400 (14100)	4200 (9200)	10200 (22500)	6450 (14300)	*12450 (27400)	*12450 (27400)	*8000 (17700)	*8000 (17700)
-3.0 m (-10')		5500 (12100)	3650 (8000)			6450 (14200)	4250 (9300)	10350 (22800)	6550 (14500)	*16450 (36300)	13100 (28900)	*13150 (29000)	*13150 (29000)
-4.6 m (-15')		*8000 (17600)	5500 (12100)					*9350 (20600)	6650 (14700)	*13700 (30200)	13650 (30100)		
Arm length 2000 mm (6'7")													
7.6 m (25')		*4750 (10500)	*4750 (10500)										
6.1 m (20')		*4500 (9900)	4100 (9100)			*5200 (11400)	5100 (11300)						
4.6 m (15')		*4550 (10000)	3300 (7300)			*5800 (12800)	4950 (10900)	*6850 (15100)	*6850 (15100)	*9750 (21500)	*9750 (21500)		
3.0 m (10')		4400 (9700)	2950 (6500)	4750 (10400)	3200 (7000)	*6750 (14900)	4650 (10300)	*8850 (19500)	7100 (15700)				
1.5 m (5')		4250 (9400)	2800 (6200)	4600 (10200)	3050 (6800)	6600 (14600)	4400 (9700)	10500 (23100)	6700 (14800)				
0 m (0')		4400 (9700)	2900 (6400)	4550 (10000)	3000 (6600)	6400 (14200)	4200 (9300)	10200 (22500)	6450 (14200)				
-1.5 m (-5')		4900 (10800)	3250 (7100)			6350 (14100)	4150 (9200)	10200 (22500)	6450 (14200)	*13000 (28600)	12900 (28400)		
-3.0 m (-10')		6200 (13700)	4100 (9100)			6500 (14300)	4300 (9400)	10400 (22900)	6600 (14600)	*15350 (33900)	13250 (29200)		
-4.6 m (-15')		*8150 (17900)	6800 (15000)					*8350 (18400)	7700 (15500)				

* Load is limited by hydraulic capacity rather than tipping. Ratings are based on SAE Standard NO. J1097. Rated loads do not exceed 87% of hydraulic lift capacity or 75% of tipping load.

PC220LC-7

Conditions:

Boom: 5850 mm (19'2"), Bucket (SAE): 1.0 m³ (1.31 cu.yd), Shoes: 700 mm (28")

unit: kg (lb)

B	A	MAX		7.6 m (25')		6.1 m (20')		4.6 m (15')		3.0 m (10')		1.5 m (5')	
		Cf	Cs	Cf	Cs	Cf	Cs	Cf	Cs	Cf	Cs	Cf	Cs
Arm length 3045 mm (10'0")													
7.6 m (25')		*2900 (6400)	*2900 (6400)			*3900 (8700)	*3900 (8700)						
6.1 m (20')		*2750 (6100)	*2750 (6100)	*3700 (8200)	*3700 (8200)	*4100 (9000)	*4100 (9000)						
4.6 m (15')		*2800 (6200)	*2800 (6200)	*4600 (10100)	4000 (8800)	*4800 (10600)	*4800 (10600)						
3.0 m (10')		*2950 (6500)	2900 (6400)	*5150 (11400)	3850 (8500)	*5900 (13000)	5650 (12400)	*7450 (16500)	*7450 (16500)	*11800 (26000)	*11800 (26000)		
1.5 m (5')		*3250 (7200)	2800 (6200)	*5800 (12800)	3700 (8200)	*7050 (15500)	5350 (11700)	*9700 (21400)	8300 (18300)	*6850 (15100)	*6850 (15100)		
0 m (0')		*3750 (8300)	2850 (6300)	5650 (12500)	3600 (7900)	*8000 (17600)	5100 (11200)	*11200 (24700)	7900 (17400)	*7800 (17100)	*7800 (17100)		
-1.5 m (-5')		*4600 (10100)	3100 (6800)	5600 (12300)	3500 (7800)	7950 (17500)	4950 (10900)	*11800 (26100)	7700 (17000)	*11150 (24600)	11150 (24600)	*6900 (15200)	*6900 (15200)
-3.0 m (-10')		5800 (12800)	3650 (8100)			7950 (17500)	4950 (10900)	*11650 (25700)	7750 (17000)	*16050 (35400)	15700 (34600)	*10750 (23700)	*10750 (23700)
-4.6 m (-15')		*7250 (16000)	5050 (11100)			*7400 (16300)	5100 (1130)	*10400 (23000)	7950 (17500)	*15200 (33500)	*15200 (33500)		
Arm length 2500 mm (8'2")													
7.6 m (25')		*4600 (10100)	*4600 (10100)			*4650 (10200)	*4650 (10200)						
6.1 m (20')		*4400 (9700)	4350 (9600)			*4650 (10300)	*4650 (10300)						
4.6 m (15')		*4450 (9800)	3600 (7900)	*5000 (11100)	3900 (8600)	*5350 (11700)	*5350 (11700)	*6100 (13500)	*6100 (13500)				
3.0 m (10')		*4750 (10500)	3250 (7100)	*5500 (12100)	3800 (8400)	*6350 (14000)	5500 (12100)	*8250 (18200)	*8250 (18200)				
1.5 m (5')		4850 (10800)	3100 (5800)	5700 (12600)	3650 (8000)	*7400 (16300)	5200 (11500)	*10300 (22700)	8050 (17800)				
0 m (0')		5000 (11100)	3150 (7000)	5600 (12400)	3550 (7800)	8000 (17600)	5000 (11000)	*11450 (25300)	7700 (17000)	*7250 (16000)	*7250 (16000)		
-1.5 m (-5')		5550 (12200)	3500 (7700)	5550 (12300)	3500 (7700)	7900 (17400)	4900 (10800)	*11800 (26000)	7650 (16800)	*12450 (27400)	*12450 (27400)	*8000 (17700)	*8000 (17700)
-3.0 m (-10')		6800 (14900)	4250 (9400)			7950 (17600)	4950 (10900)	*11250 (24900)	7700 (17000)	*16450 (36300)	15700 (34700)	*13150 (29000)	*13150 (29000)
-4.6 m (-15')		*8000 (17600)	6400 (14100)					*9350 (20600)	7800 (17200)	*13700 (30200)	*13700 (30200)		
Arm length 2000 mm (6'7")													
7.6 m (25')		*4750 (10500)	*4750 (10500)										
6.1 m (20')		*4500 (9900)	*4500 (9900)			*5200 (11400)	*5200 (11400)						
4.6 m (15')		*4550 (10000)	3850 (8500)			*5800 (12800)	5700 (12500)	*6850 (15100)	*6850 (15100)	*9750 (21500)	*9750 (21500)		
3.0 m (10')		*4800 (10600)	3450 (7600)	*5800 (12800)	3700 (8200)	*6750 (14900)	5400 (11900)	*8850 (19500)	8300 (18300)				
1.5 m (5')		5200 (11500)	3300 (7300)	5650 (12500)	3600 (7900)	*7700 (17000)	5100 (11300)	*10800 (23800)	7850 (17300)				
0 m (0')		5400 (11900)	3400 (7500)	5600 (12300)	3500 (7700)	7950 (17500)	4950 (10900)	*11650 (25700)	7600 (16800)				
-1.5 m (-5')		6050 (13300)	3800 (8400)			7900 (17400)	4900 (10800)	*11650 (25700)	7600 (16800)	*13000 (28600)	*13000 (28600)		
-3.0 m (-10')		*7550 (16600)	4800 (10600)			7850 (17300)	5000 (11100)	*10850 (23900)	7750 (17100)	*15350 (33900)	*15350 (33900)		
-4.6 m (-15')		*8150 (17900)	7950 (17500)					*8350 (18400)	8200 (18000)				

* Load is limited by hydraulic capacity rather than tipping. Ratings are based on SAE Standard NO. J1097. Rated loads do not exceed 87% of hydraulic lift capacity or 75% of tipping load.

PC228US-8

Conditions:

Boom: 5700 mm (18'8"), Bucket (SAE): 0.80 m³ (1.05 cu.yd), Shoes: 600 mm (24")

unit :kg (lb)

B	A	MAX		7.5 m (24')		6.0 m (19')		4.5 m (14')		3.0 m (9')	
		Cf	Cs	Cf	Cs	Cf	Cs	Cf	Cs	Cf	Cs
Arm length 2925 mm (9'7")											
6.0 m (19')		*2820 (6200)	2670 (5900)	*3140 (6900)	2670 (5800)	*4290 (9400)	4090 (9000)				
4.5 m (14')		*2840 (6200)	2220 (4900)	4090 (9000)	2620 (5700)	*4950 (10900)	3920 (8600)	*5530 (12200)	*5530 (12200)		
3.0 m (9')		*3000 (6600)	1980 (4300)	3970 (8700)	2510 (5500)	5780 (12700)	3690 (8100)	*7820 (17200)	5900 (13000)	*11680 (25700)	11430 (25200)
1.5 m (4')		3080 (6800)	1880 (4100)	3830 (8400)	2380 (5200)	5530 (12100)	3460 (7600)	8860 (19500)	5400 (11900)	*6880 (15100)	*6880 (15100)
0 m (0')		3150 (6900)	1910 (4200)	3740 (8200)	2290 (5000)	5330 (11700)	3280 (7200)	8490 (18700)	5080 (11200)	*5230 (11500)	*5230 (11500)
-1.5 m (-4')		3430 (7500)	2080 (4600)	3690 (8100)	2240 (4900)	5220 (11500)	3190 (7000)	8340 (18400)	4960 (10900)	*9330 (20500)	*9330 (20500)
-3.0 m (-9')		4100 (9000)	2510 (5500)			5220 (11500)	3180 (7000)	8370 (18400)	4990 (11000)	*14890 (32800)	9950 (21900)
-4.5 m (-14')		5810 (12800)	3570 (7800)					8570 (18900)	5160 (11300)	*13590 (29900)	10260 (22600)

* Load is limited hydraulic capacity rather than tipping.

Ratings are based on ISO Standard No.10567. Rated loads do not exceed 87% of hydraulic lift capacity or 75% of tipping load.

PC228USLC-8

Conditions:

Boom: 5700 mm (18'8"), Bucket (SAE): 0.80 m³ (1.05 cu.yd), Shoes: 700 mm (27.5")

unit :kg (lb)

B	A	MAX		7.5 m (24')		6.0 m (19')		4.5 m (14')		3.0 m (9')	
		Cf	Cs	Cf	Cs	Cf	Cs	Cf	Cs	Cf	Cs
Arm length 2925 mm (9'7")											
6.0 m (19')		*2820 (6200)	*2820 (6200)	*3140 (6900)	3130 (6900)	*4290 (9400)	*4290 (9400)				
4.5 m (14')		*2840 (6200)	2630 (5800)	*4700 (10300)	3080 (6800)	*4950 (10900)	4560 (10000)	*5530 (12200)	*5530 (12200)		
3.0 m (9')		*3000 (6600)	2370 (5200)	5060 (11100)	2970 (6500)	*5990 (13200)	4320 (9500)	*7820 (17200)	6880 (15100)	*11680 (25700)	*11680 (25700)
1.5 m (4')		*3290 (7200)	2270 (5000)	4920 (10800)	2840 (6200)	7030 (15500)	4090 (9000)	*9990 (22000)	6370 (14000)	*6880 (15100)	*6880 (15100)
0 m (0')		*3800 (8300)	2310 (5000)	4820 (10600)	2750 (6000)	6870 (15100)	3900 (8600)	11020 (24200)	6040 (13300)	*5230 (11500)	*5230 (11500)
-1.5 m (-4')		4430 (9700)	2510 (5500)	4770 (10500)	2700 (5900)	6760 (14900)	3810 (8300)	10960 (24100)	5920 (13000)	*9330 (20500)	*9330 (20500)
-3.0 m (-9')		5290 (11600)	3000 (6600)			6750 (14800)	3800 (8300)	*10920 (24000)	5940 (13100)	*14890 (32800)	11990 (26400)
-4.5 m (-14')		*7030 (15500)	4240 (9300)					*9510 (20900)	6120 (13500)	*13590 (29900)	12180 (26800)

* Load is limited hydraulic capacity rather than tipping.

Ratings are based on ISO Standard No.10567. Rated loads do not exceed 87% of hydraulic lift capacity or 75% of tipping load.

PC228USLC-8 (for EU)

Conditions:

One-piece Boom: 5700 mm, Bucket (SAE): 0.80 m³, Shoes: 700 mm

unit :kg

B	A	MAX		7.5 m		6.0 m		4.5 m		3.0 m		1.5 m	
		Cf	Cs	Cf	Cs	Cf	Cs	Cf	Cs	Cf	Cs	Cf	Cs
Arm length 2400 mm													
6.0 m		*4250	3400			*4720	4530	*4750	*4750				
4.5 m		*4290	2780	*4980	2910	*5310	4350	*6210	*6210	*8000	*8000		
3.0 m		4340	2470	4890	2800	*6280	4080	*8480	6540				
1.5 m		4190	2350	4760	2680	6850	3870	*10380	6030				
0 m		4300	2400	4660	2600	6660	3710	10800	5760	*6970	*6970		
-1.5 m		4760	2650	4640	2580	6580	3640	10710	5690	*9250	*9250	*7680	*7680
-3.0 m		5870	3280			6640	3680	*10360	5790	*14680	11850	*10940	*10940
-4.5 m		*7210	5070					*8420	6050	*11870	*11870		
Arm length 2900 mm													
6.0 m		*2780	*2780	*3110	3040	*4200	*4200						
4.5 m		*2810	2530	*4580	2990	*4840	4470	*5430	*5430				
3.0 m		*2960	2270	4960	2860	*5860	4200	*7670	6750	*11480	*11480		
1.5 m		*3250	2160	4800	2720	6900	3950	*9790	6190	*6860	*6860		
0 m		*3760	2190	4690	2620	6720	3750	10790	5840	*5200	*5200		
-1.5 m		4310	2390	4640	2570	6600	3650	10730	5700	*9300	*9300	*5180	*5180
-3.0 m		5160	2870			6600	3650	*10710	5740	*14820	11680	*9740	*9740
-4.5 m		6870	4100					*9320	5940	*13300	*11920		

* Load is limited hydraulic capacity rather than tipping.
 Ratings are based on ISO Standard No.10567. Rated loads do not exceed 87% of hydraulic lift capacity or 75% of tipping load.

PC228USLC-8 (for USA)

Conditions:

Boom: Boom: 5700 mm (18'8"), Bucket (SAE): 0.70 m³ (0.92 cu.yd)

unit: kg (lb)

B	A	MAX		7.6 m (25')		6.1 m (20')		4.6 m (15')		3.0 m (10')		1.5 m (5')	
		Cf	Cs	Cf	Cs	Cf	Cs	Cf	Cs	Cf	Cs	Cf	Cs
Arm length 2925 mm (9'7") Shoes: 600 mm (24")													
6.1 m (20')	*2820 (6200)	*2820 (6200)			*5240 (11500)	5230 (11500)							
4.6 m (15')	*2840 (6200)	*2840 (6200)	*4880 (10700)	3470 (7600)	*5970 (13100)	5070 (11100)	*6570 (14400)	*6570 (14400)					
3.0 m (10')	*2990 (6500)	2790 (6100)	5550 (12200)	3360 (7400)	*7190 (15800)	4840 (10600)	*9240 (20300)	7640 (16800)	*13550 (29800)	*13550 (29800)			
1.5 m (5')	*3290 (7200)	2680 (5900)	5410 (11900)	3240 (7100)	7740 (17000)	4610 (10100)	*11820 (26000)	7130 (15700)	*7380 (16200)	*7380 (16200)			
0 m (0')	*3800 (8300)	2730 (6000)	5310 (11700)	3150 (6900)	7530 (16600)	4430 (9700)	12110 (26700)	6800 (15000)	*5540 (12200)	*5540 (12200)			
-1.5 m (-5')	*4720 (10400)	2970 (6500)	5260 (11600)	3100 (6800)	7420 (16300)	4330 (9500)	11950 (26300)	6670 (14700)	*9650 (21200)	*9650 (21200)	*5330 (11700)	*5330 (11700)	
-3.0 m (-10')	6020 (13200)	3550 (7800)			7420 (16300)	4330 (9500)	11980 (26400)	6700 (14700)	*16640 (36600)	13320 (29300)	*9970 (21900)	*9970 (21900)	
-4.6 m (-15')	8630 (19000)	5030 (11100)					*11250 (24800)	6880 (15100)	*16070 (35400)	13650 (30100)			
Arm length 2925 mm (9'7") Shoes: 700 mm (28")													
6.1 m (20')	*2820 (6200)	*2820 (6200)			*5240 (11500)	*5240 (11500)							
4.6 m (15')	*2840 (6200)	*2840 (6200)	*4880 (10700)	3500 (7700)	*5970 (13100)	5110 (11200)	*6570 (14400)	*6570 (14400)					
3.0 m (10')	*2990 (6500)	2820 (6200)	5600 (12300)	3390 (7400)	*7190 (15800)	4880 (10700)	*9240 (20300)	7700 (16900)	*13550 (29800)	*13550 (29800)			
1.5 m (5')	*3290 (7200)	2710 (5900)	5460 (12000)	3270 (7200)	7810 (17200)	4650 (10200)	*11820 (26000)	7200 (15800)	*7380 (16200)	*7380 (16200)			
0 m (0')	*3800 (8300)	2760 (6000)	5360 (11800)	3180 (7000)	7600 (16700)	4470 (9800)	12220 (26900)	6870 (15100)	*5540 (12200)	*5540 (12200)			
-1.5 m (-5')	*4720 (10400)	3000 (6600)	5320 (11700)	3140 (6900)	7490 (16500)	4370 (9600)	12060 (26500)	6740 (14800)	*9650 (21200)	*9650 (21200)	*5330 (11700)	*5330 (11700)	
-3.0 m (-10')	6070 (13400)	3580 (7900)			7490 (16500)	4370 (9600)	12090 (26600)	6760 (14900)	*16640 (36600)	13440 (29600)	*9970 (21900)	*9970 (21900)	
-4.6 m (-15')	*8640 (19000)	5080 (11200)					*11250 (24800)	6940 (15300)	*16070 (35400)	13700 (30300)			
Arm length 2925 mm (9'7") Shoes: 800 mm (31.5")													
6.1 m (20')	*2800 (6100)	*2800 (6100)			*5220 (11500)	*5220 (11500)							
4.6 m (15')	*2820 (6200)	*2820 (6200)	*4860 (10700)	3530 (7700)	*5950 (13100)	5150 (11300)	*6550 (14400)	*6550 (14400)					
3.0 m (10')	*2970 (6500)	2840 (6200)	5650 (12400)	3420 (7500)	*7170 (15800)	4920 (10800)	*9220 (20300)	7760 (17100)	*13530 (29800)	*13530 (29800)			
1.5 m (5')	*3270 (7200)	2730 (6000)	5510 (12100)	3300 (7200)	7880 (17300)	4690 (10300)	*11810 (26000)	7260 (16000)	*7360 (16200)	*7360 (16200)			
0 m (0')	*3780 (8300)	2780 (6100)	5410 (11900)	3210 (7000)	7680 (16900)	4510 (9900)	12340 (27200)	6930 (15200)	*5520 (12100)	*5520 (12200)			
-1.5 m (-5')	*4700 (10300)	3030 (6600)	5370 (11800)	3160 (6900)	7570 (16600)	4410 (9700)	12180 (26800)	6800 (15000)	*9640 (21200)	*9640 (21200)	*5310 (11700)	*5310 (11700)	
-3.0 m (-10')	6130 (13500)	3610 (7900)			7560 (16600)	4410 (9700)	12220 (26900)	6830 (15000)	*16640 (36600)	13580 (29900)	*9950 (21900)	*9950 (21900)	
-4.6 m (-15')	*8620 (19000)	5130 (11300)					*11230 (24700)	7010 (15400)	*16050 (35300)	13910 (30600)			

* Load is limited hydraulic capacity rather than tipping. Ratings are based on ISO Standard No.10567. Rated loads do not exceed 87% of hydraulic lift capacity or 75% of tipping load.

PC230NHD-8

Conditions: One piece boom: 5700 mm (18'8"), Bucket (SAE): 0.96 m³ (1.26 cu.yd), Shoes: 550 mm (22")
 Lifting capacities, including bucket (760 kg), bucket linkage (200 kg) and bucket cylinder (140 kg)
 unit: kg (lb)

B	A	MAX		7.5 m (25')		6.0 m (20')		4.5 m (15')		3.0 m (10')		1.5 m (5')	
		Cf	Cs	Cf	Cs	Cf	Cs	Cf	Cs	Cf	Cs	Cf	Cs
Arm length 2900 mm (9'6")													
6.0 m (20')		*2650 (5800)	*2650 (5800)	*3550 (7800)	2900 (6400)	*4300 (9400)	*4300 (9400)						
4.5 m (15')		*2650 (5800)	2250 (4900)	*4650 (10200)	2850 (6200)	*4900 (10800)	4250 (9300)	*5500 (12100)	*5500 (12100)				
3.0 m (10')		*2800 (6100)	2050 (4500)	4900 (10800)	2700 (5900)	*5850 (12800)	3950 (8700)	*7400 (16300)	6200 (13600)	*11550 (25400)	*11550 (25400)		
1.5 m (5')		*3050 (6700)	1950 (4300)	4750 (10400)	2600 (5700)	6800 (14900)	3700 (8100)	*9300 (20400)	5650 (12400)	*6400 (14100)	*6400 (14100)		
0 m (0')		*3450 (7600)	2000 (4400)	4650 (10200)	2450 (5400)	6550 (14400)	3450 (7600)	10450 (23000)	5250 (11500)	*7300 (16000)	*7300 (16000)		
-1.5 m (-5')		4100 (9000)	2150 (4700)	4600 (10100)	2400 (5300)	6450 (14200)	3350 (7300)	10250 (22500)	5150 (11300)	*10550 (23200)	9650 (21200)	*6400 (14100)	*6400 (14100)
-3.0 m (-10')		4850 (10600)	2550 (5600)			6450 (14200)	3400 (7500)	10300 (22600)	5150 (11300)	*15400 (33900)	9850 (21600)	*10150 (22300)	*10150 (22300)
-4.5 m (-15')		*6350 (13900)	3550 (7800)					9050 (19900)	5350 (11700)	*13000 (28600)	10250 (22500)		
Arm length 2400 mm (7'10")													
6.0 m (20')		*4150 (9100)	3100 (6800)			*4900 (10800)	4350 (9500)						
4.5 m (15')		*4150 (9100)	2550 (5600)	5000 (11000)	2800 (6100)	*5450 (12000)	4200 (9200)	*6300 (13800)	*6300 (13800)				
3.0 m (10')		4200 (9200)	2300 (5000)	4900 (10800)	2750 (6000)	*6350 (13900)	3950 (8700)	*8250 (18100)	6100 (13400)				
1.5 m (5')		4100 (9000)	2200 (4800)	4800 (10500)	2600 (5700)	6800 (14900)	3700 (8100)	*10000 (22000)	5600 (12300)				
0 m (0')		4200 (9200)	2250 (4900)	4700 (10300)	2550 (5600)	6600 (14500)	3550 (7800)	10500 (23100)	5300 (11600)				
-1.5 m (-5')		4600 (10100)	2500 (5500)	4650 (10200)	2500 (5500)	6550 (14500)	3450 (7600)	10400 (22900)	5250 (9300)	*11250 (24700)	9900 (21800)	*6900 (15200)	*6900 (15200)
-3.0 m (-10')		5600 (12300)	3050 (6700)			6600 (14500)	3500 (7700)	*10300 (22600)	5350 (11700)	*14700 (32300)	10150 (22300)	*12000 (26400)	*12000 (26400)
-4.5 m (-15')		*6750 (14800)	4500 (9900)					*8250 (18100)	5600 (12300)	*11700 (25700)	10600 (23300)		
Arm length 1800 mm (5'11")													
6.0 m (20')		*4600 (10100)	3550 (7800)			*5500 (12100)	4200 (9200)	*5850 (12800)	*5850 (12800)				
4.5 m (15')		*4600 (10100)	2850 (6200)			*6000 (13200)	4100 (9000)	*7150 (15700)	6450 (14200)	*10200 (22400)	*10200 (22400)		
3.0 m (10')		4650 (10200)	2550 (5600)	4850 (10600)	2650 (5800)	*6800 (14900)	3850 (8400)	*9000 (19800)	5850 (12800)				
1.5 m (5')		4500 (9900)	2450 (5400)	4750 (10400)	2600 (5700)	6700 (14700)	3650 (8000)	*10450 (23000)	5400 (11900)				
0 m (0')		4650 (10200)	2500 (5500)	4700 (10300)	2550 (5600)	6550 (14400)	3500 (7700)	10350 (22700)	5200 (11400)				
-1.5 m (-5')		5250 (11500)	2800 (6100)			6550 (14400)	3450 (7600)	10350 (22700)	5200 (11400)	*12250 (26900)	9950 (21900)		
-3.0 m (-10')		6650 (14600)	3600 (7900)			6700 (14700)	3600 (7900)	*9650 (21200)	5400 (11900)	*13200 (29000)	10250 (22500)		
-4.5 m (-15')													

* Load is limited by hydraulic capacity rather than tipping.
 Ratings are based on SAE Standard NO. J1097. Rated loads do not exceed 87% of hydraulic lift capacity or 75% of tipping load.

PC240LC-10 (USA source)

Conditions:

Boom: 5850 mm (19'2"), Bucketless, Shoes: 700 mm (28")

unit: kg (lb)

B	A	MAX		7.6 m (25')		6.1 m (20')		4.6 m (15')		3.0 m (10')		1.5 m (5')	
		Cf	Cs	Cf	Cs	Cf	Cs	Cf	Cs	Cf	Cs	Cf	Cs
Arm length 3045 mm (10'0")													
7.6 m (25')		*4700 (10400)	*4700 (10400)			*5950 (13200)	*5950 (13200)						
6.1 m (20')		*4450 (9800)	*4450 (9800)			*6400 (14100)	*6400 (14100)						
4.6 m (15')		*4450 (9800)	4300 (9500)	*6900 (15200)	4850 (10700)	*7200 (15900)	6750 (14900)	*8000 (17700)	*8000 (17700)				
3.0 m (10')		*4600 (10100)	3950 (8700)	6850 (15100)	4700 (10400)	*8450 (18700)	6500 (14300)	*10700 (23500)	9800 (21700)				
1.5 m (5')		*4900 (10800)	3850 (8500)	6700 (14800)	4600 (10100)	9300 (20500)	6200 (13700)	*13200 (29100)	9250 (20400)				
0 m (0')		*5450 (12100)	3900 (8600)	6600 (14500)	4450 (9900)	9100 (20000)	6000 (13300)	14350 (31700)	8900 (19700)	*7850 (17300)	*7850 (17300)		
-1.5 m (-5')		6200 (13700)	4200 (9300)	6550 (14400)	4450 (9800)	9000 (19800)	5900 (13100)	14250 (31400)	8800 (19400)	*12580 (28300)	*12850 (28300)	*8250 (18200)	*8250 (18200)
-3.0 m (-10')		7300 (16100)	4950 (10900)			9000 (19900)	5950 (13100)	14300 (31500)	8850 (19600)	*19750 (43600)	17300 (38200)	*13450 (29700)	*13450 (29700)
-4.6 m (-15')		*9800 (21600)	6750 (14900)					*12550 (27700)	9100 (20000)	*17750 (39100)	*17750 (39100)		
Arm length 3500 mm (11'6")													
7.6 m (25')		*4000 (8800)	*4000 (8800)			*5500 (12100)	*5500 (12100)						
6.1 m (20')		*3850 (8400)	*3850 (8400)	*5100 (11200)	4850 (10700)	*5650 (12500)	*5650 (12500)						
4.6 m (15')		*3800 (8400)	*3800 (8400)	*6300 (13900)	4800 (10500)	*6500 (14300)	*6500 (14300)						
3.0 m (10')		*3950 (8700)	3600 (8000)	6750 (14900)	4650 (10200)	*7750 (17100)	6400 (14200)	*9600 (21100)	*9600 (21100)	*14650 (32300)	*14650 (32300)		
1.5 m (5')		*4200 (9300)	3500 (7700)	6600 (14500)	4450 (9800)	*9150 (20200)	6100 (13400)	*12250 (27000)	9150 (20100)				
0 m (0')		*4650 (10300)	3550 (7800)	6450 (14200)	4300 (9500)	8900 (19700)	5850 (12900)	*14000 (30900)	8700 (19200)	*8750 (19300)	*8750 (19300)		
-1.5 m (-5')		*5450 (12000)	3800 (8400)	6350 (14000)	4250 (9400)	8750 (19300)	5700 (12600)	13900 (30700)	8500 (18800)	*12400 (27400)	*12400 (27400)	*7800 (17200)	*7800 (17200)
-3.0 m (-10')		6500 (14300)	4350 (9600)			8750 (19300)	5700 (12600)	13950 (30700)	8850 (18800)	*17850 (39400)	16700 (36900)	*12050 (26600)	*12050 (26600)
-4.6 m (-15')		8650 (19100)	5700 (12500)			8950 (19700)	5850 (12900)	*13100 (28900)	8750 (19300)	*18750 (41300)	17150 (37800)		

* Load is limited hydraulic capacity rather than tipping.

Ratings are based on ISO Standard No.10567. Rated loads do not exceed 87% of hydraulic lift capacity or 75% of tipping load.

PC240LC-10 (UK source)

Conditions:

One-piece boom: 5850 mm, Bucketless, Shoes: 600 mm

unit :kg

B	A	MAX		9.0 m		7.5 m		6.0 m		4.5 m		3.0 m	
		Cf	Cs	Cf	Cs	Cf	Cs	Cf	Cs	Cf	Cs	Cf	Cs
Arm length 2000 mm													
	7.5 m	*7530	*7350										
	6.0 m	*7000	6060					*7780	6930	*8150	*8150		
	4.5 m	*6950	5060					*8460	6750	*10120	*10120		
	3.0 m	6750	4610			6950	4740	*9590	6470	*12790	9630		
	1.5 m	6570	4470			6830	4630	9450	6230	*14710	9170		
	0 m	6800	4600					9300	6090	14720	9030		
	-1.5 m	7600	5090					9280	6080	14750	9060	*13790	*13790
	-3.0 m	9640	6340							*13580	9230	*18310	18210
	-4.5 m												
Arm length 2500 mm													
	7.5 m	*6950	*6950										
	6.0 m	*6590	5470					*7030	6990				
	4.5 m	*6590	4650			7060	4830	*7820	6780	*9120	*9120		
	3.0 m	6240	4250			6930	4710	*9020	6470	*11780	9740		
	1.5 m	6070	4120			6790	4580	9430	6190	*14000	9180		
	0 m	6240	4210			6690	4490	9220	6020	14620	8930		
	-1.5 m	6870	4600					9160	5960	14590	8900	*13530	*13530
	-3.0 m	8380	5540					9260	6040	*14080	9030	*19640	17830
	-4.5 m	*10260	8290							*11360	9360		
Arm length 3000 mm													
	7.5 m	*4640	*4640					*6160	*6160				
	6.0 m	*4420	*4420			*4950	*4950	*6290	*6290				
	4.5 m	*4400	4200			*6790	4890	*7150	6870	*8050	*8050		
	3.0 m	*4550	3880			6970	4740	*8420	6550	*10720	9950		
	1.5 m	*4870	3760			6800	4590	9480	6230	*13210	9300		
	0 m	*5430	3830			6660	4460	9220	6010	14650	8940	*7350	*7350
	-1.5 m	6130	4120			6610	4420	9110	5910	14520	8830	*12480	*12480
	-3.0 m	7210	4800					9140	5940	*14530	8900	*19150	17550
	-4.5 m	*9570	6510							*12640	9140	*17790	*17790
Arm length 3500 mm													
	7.5 m	*4010	*4010										
	6.0 m	*3850	*3850			*5500	5060	*5700	*5700				
	4.5 m	*3840	*3840			*6350	4960	*6600	*6600				
	3.0 m	*3970	3660			*7020	4800	*7910	6640	*9810	*9810	*15180	*15180
	1.5 m	*4230	3550	*4400	3560	6830	4620	*9300	6290	*12480	9420		
	0 m	*4690	3590			6670	4470	9250	6030	*14260	8970	*8490	*8490
	-1.5 m	*5470	3830			6590	4390	9090	5890	14480	8800	*12120	*12120
	-3.0 m	6540	4370			6610	4420	9080	5880	14490	8810	*17370	17320
	-4.5 m	8580	5640					9250	6020	*13390	9000	*19100	17730

* Load is limited hydraulic capacity rather than tipping.
 Ratings are based on SAE Standard No. J1097. Rated loads do not exceed 87% of hydraulic lift capacity or 75% of tipping load.

PC240NLC-10 (UK source)

Conditions:

One-piece boom: 5850 mm, Bucketless, Shoes: 600 mm

unit :kg

B	A	MAX		9.0 m		7.5 m		6.0 m		4.5 m		3.0 m	
		Cf	Cs	Cf	Cs	Cf	Cs	Cf	Cs	Cf	Cs	Cf	Cs
Arm length 2000 mm													
	7.5 m	*7530	*7530										
	6.0 m	*7000	5400					*7780	6180	*8150	*8150		
	4.5 m	6680	4500					*8460	6000	*10120	9120		
	3.0 m	6090	4090			6260	4200	8730	5730	*12790	8440		
	1.5 m	5920	3950			6150	4100	8460	5490	13150	8000		
	0 m	6120	4060					8310	5360	12990	7860		
	-1.5 m	6820	4490					8290	5340	13020	7890	*13790	*13790
	-3.0 m	8630	5590							13220	8050	*18310	15490
	-4.5 m	*7530	*7530										
Arm length 2500 mm													
	7.5 m	*6950	6520										
	6.0 m	*6590	4870					*7030	6240				
	4.5 m	6130	4130			6370	4300	*7820	6030	*9120	*9120		
	3.0 m	5620	3770			6240	4180	8740	5730	*11780	8550		
	1.5 m	5460	3640			6100	4050	8430	5460	13180	8000		
	0 m	5610	3710			6000	3960	8240	5280	12890	7770		
	-1.5 m	6160	4050					8170	5230	12860	7740	*13530	*13530
	-3.0 m	7510	4880					8270	5310	13000	7860	*19640	15130
	-4.5 m	*10260	7270							*11360	8180		
Arm length 3000 mm													
	7.5 m	*4640	*4640					*6160	*6160				
	6.0 m	*4420	4310			*4950	4420	*6290	*6290				
	4.5 m	*4400	3730			6440	4350	*7150	6120	*8050	*8050		
	3.0 m	*4550	3430			6280	4210	*8420	5800	*10720	8750		
	1.5 m	*4870	3320			6110	4050	8480	5490	*13210	8120		
	0 m	5080	3370			5980	3930	8240	5270	12910	7770	*7530	*7530
	-1.5 m	5500	3620			5930	3880	8120	5180	12790	7670	*12480	*12480
	-3.0 m	6460	4220					8160	5200	12860	7730	*19150	14860
	-4.5 m	8940	5730							*12640	7970	*17790	15300
Arm length 3500 mm													
	7.5 m	*4010	*4010										
	6.0 m	*3850	*3850			*5500	4520	*5700	*5700				
	4.5 m	*3840	3500			*6350	4420	*6600	6230				
	3.0 m	*3970	3240			6340	4260	*7910	5890	*9810	8950	*15180	*15180
	1.5 m	*4230	3130	*4400	3140	6150	4080	8550	5550	*12480	8240		
	0 m	*4690	3160			5990	3940	8260	5290	12960	7800	*8490	*8490
	-1.5 m	5100	3370			5900	3860	8110	5160	12750	7630	*12120	*12120
	-3.0 m	5870	3850			5930	3880	8090	5140	12760	7640	*17370	14650
	-4.5 m	7680	4960					8260	5290	12980	7830	*19100	15030

* Load is limited hydraulic capacity rather than tipping.
 Ratings are based on SAE Standard No. J1097. Rated loads do not exceed 87% of hydraulic lift capacity or 75% of tipping load.

PC240LC-8 (Brazil source)

Conditions: Boom: 5850 mm (19'2"), Bucket (SAE): 1.01 m³ (1.32 cu.yd), Shoes: 700 mm (28")
 Lifting capacities, including bucket (730 kg), bucket linkage (200 kg) and bucket cylinder (140 kg) unit: kg (lb)

B	A	MAX		7.5 m (25')		6.0 m (20')		4.5 m (15')		3.0 m (10')		1.5 m (5')	
		Cf	Cs	Cf	Cs	Cf	Cs	Cf	Cs	Cf	Cs	Cf	Cs
Arm length 3000 mm (9'10")													
6.0 m (20')		*3000 (6600)	*3000 (6600)	*4450 (9800)	4250 (9400)	*4900 (10800)	*4900 (10800)						
4.5 m (15')		*3050 (6700)	*3050 (6700)	*5550 (12200)	4200 (9200)	*5800 (12800)	*5800 (12800)						
3.0 m (10')		*3200 (7100)	2950 (6500)	*6250 (13700)	4050 (8900)	*7150 (15700)	5900 (13000)	*9050 (20000)	*9050 (20000)	*14450 (31800)	*14450 (31800)		
1.5 m (5')		*3550 (7800)	2850 (6200)	6050 (13300)	3850 (8500)	*8550 (18800)	5550 (12200)	*11700 (25800)	8650 (19000)	*6900 (15200)	*6900 (15200)		
0 m (0')		*4050 (8900)	2900 (6400)	5900 (13000)	3700 (8200)	8450 (18600)	5250 (11600)	*13500 (29700)	8150 (18000)	*8100 (17900)	*8100 (17900)		
-1.5 m (-5')		*4950 (10900)	3100 (6900)	5800 (12800)	3650 (8000)	8300 (18300)	5150 (11300)	13550 (29900)	8000 (17600)	*11650 (25700)	*11650 (25700)	*7350 (16200)	*7350 (16200)
-3.0 m (-10')		5850 (12900)	3700 (8100)			8250 (18200)	5100 (11300)	13600 (30000)	8000 (17700)	*16750 (37000)	16350 (36100)	*11350 (25100)	*11350 (25100)
-4.5 m (-15')		7950 (17600)	5000 (11000)			8450 (18600)	5300 (11500)	*12650 (27900)	8200 (18100)	*18350 (40500)	16850 (37100)		
Arm length 3500 mm (11'6")													
6.0 m (20')		*2350 (5200)	*2350 (5200)	*4050 (9000)	*4050 (9000)								
4.5 m (15')		*2400 (5300)	*2400 (5300)	*5050 (11200)	4200 (9300)	*5200 (11500)	*5200 (11500)						
3.0 m (10')		*2550 (5600)	*2550 (5600)	*5800 (12800)	4050 (8900)	*6550 (14400)	5950 (13100)	*8050 (17800)	*8050 (17800)	*11850 (26100)	*11850 (26100)		
1.5 m (5')		*2850 (6200)	2650 (5800)	6050 (13300)	3850 (8500)	*8000 (17600)	5550 (12200)	*10850 (24000)	8750 (19300)	*10850 (23900)	*10850 (23900)		
0 m (0')		*3300 (7300)	2650 (5900)	5850 (12900)	3700 (8100)	8400 (18600)	5250 (11600)	*12900 (28500)	8150 (18000)	*9500 (20900)	*9500 (20900)	*4300 (9400)	*4300 (9400)
-1.5 m (-5')		*4050 (8900)	2850 (6300)	5750 (12600)	3600 (7900)	8150 (18000)	5000 (11000)	13500 (29700)	7900 (17400)	*11850 (26100)	*11850 (26100)	*7350 (16200)	*7350 (16200)
-3.0 m (-10')		5350 (11800)	3350 (7400)	5700 (12600)	3550 (7900)	8150 (18000)	5000 (11100)	13450 (29700)	7850 (17400)	*15650 (34500)	*15650 (34500)	*10600 (23300)	*10600 (23300)
-4.5 m (-15')		7050 (15500)	4400 (9700)			8250 (18200)	5100 (11300)	*13100 (28900)	8000 (17700)	*19350 (42600)	16500 (36300)	*14400 (31800)	*14400 (31800)
Arm length 2500 mm (8'2")													
6.0 m (20')		*4750 (10500)	4400 (9700)			*5650 (12500)	*5650 (12500)						
4.5 m (15')		*4850 (10700)	3650 (8100)	*6100 (13500)	4150 (9100)	*6500 (14300)	6100 (13500)	*7500 (16500)	*7500 (16500)				
3.0 m (10')		5150 (11400)	3300 (7300)	6200 (13600)	4000 (8800)	*7750 (17100)	5800 (12800)	*10150 (22300)	9100 (20100)				
1.5 m (5')		5000 (11000)	3200 (7000)	6000 (13300)	3850 (8500)	8650 (19100)	5450 (12100)	*12550 (27700)	8450 (18600)				
0 m (0')		5150 (11300)	3250 (7200)	5900 (13000)	3750 (8200)	8400 (18500)	5250 (11600)	13700 (30200)	8100 (17800)				
-1.5 m (-5')		5650 (12500)	3550 (7900)	5850 (12900)	3700 (8100)	8300 (18300)	5150 (11400)	13600 (29900)	8000 (17600)	*13000 (28700)	*13000 (28700)	*8550 (18800)	*8550 (18800)
-3.0 m (-10')		6850 (15200)	4350 (9600)			8350 (18400)	5200 (11500)	*13700 (30200)	8100 (17900)	*19850 (43800)	16550 (36500)	*13900 (30700)	*13900 (30700)
-4.5 m (-15')		*9550 (21000)	6400 (14100)					*11700 (25800)	8400 (18500)	*16750 (36900)	*16750 (36900)		
Arm length 2000 mm (6'7")													
6.0 m (20')		*4850 (10700)	4800 (10600)			*6300 (13900)	6200 (13600)						
4.5 m (15')		*4950 (10900)	3950 (8700)	*5600 (12400)	4050 (8900)	*7100 (15600)	6000 (13200)	*8400 (18600)	*8400 (18600)	*12000 (26500)	*12000 (26500)		
3.0 m (10')		*5250 (11600)	3550 (7800)	6100 (13500)	3950 (8700)	*8250 (18200)	5700 (12500)	*11050 (24300)	8850 (19600)				
1.5 m (5')		5350 (11800)	3400 (7500)	5950 (13200)	3800 (8400)	8550 (18900)	5400 (11900)	*13200 (29100)	8250 (18200)				
0 m (0')		5550 (12200)	3500 (7700)	5900 (13000)	3700 (8200)	8350 (18400)	5200 (11500)	13600 (30000)	8000 (17700)				
-1.5 m (-5')		6200 (13600)	3900 (8600)			8300 (18300)	5150 (11400)	13600 (30000)	8000 (17700)	*13550 (29900)	*13550 (29900)		
-3.0 m (-10')		7800 (17200)	4900 (10800)			8450 (18600)	5250 (11600)	*13200 (29100)	8150 (18000)	*18650 (41100)	16750 (36900)		
-4.5 m (-15')		*9750 (21500)	7850 (17300)					*10450 (23100)	8550 (18900)				

* Load is limited by hydraulic capacity rather than tipping.
 Ratings are based on SAE Standard NO. J1097. Rated loads do not exceed 87% of hydraulic lift capacity or 75% of tipping load.

PC270-8

Conditions:

Boom: 5850 mm (19'2"), Bucket (SAE): 1.26 m³ (1.65 cu.yd), Shoes: 600 mm (24")

unit: kg (lb)

B	A	MAX		7.6 m (25')		6.1 m (20')		4.6 m (15')		3.0 m (10')		1.5 m (5')	
		Cf	Cs	Cf	Cs	Cf	Cs	Cf	Cs	Cf	Cs	Cf	Cs
Arm length 2500 mm (8'2")													
7.6 m (25')		*5550 (12200)	*5550 (12200)										
6.1 m (20')		*5350 (11800)	*4850 (10700)			*7150 (15700)	6500 (14400)						
4.6 m (15')		*5400 (12000)	4000 (8800)	6300 (13800)	4250 (9400)	*7900 (17400)	6300 (13900)	*9300 (20500)	*9300 (20500)				
3.0 m (10')		5350 (11800)	3550 (7900)	6150 (13500)	4100 (9100)	8850 (19500)	5950 (13100)	*11900 (26300)	9300 (20500)				
1.5 m (5')		5200 (11400)	3450 (7600)	5950 (13200)	3950 (8700)	8500 (18700)	5600 (12400)	13550 (29800)	8650 (19000)				
0 m (0')		5350 (11800)	3500 (7700)	5850 (12900)	3850 (8500)	8250 (18200)	5400 (11900)	13150 (28900)	8300 (18300)				
-1.5 m (-5')		5900 (13000)	3900 (8600)			8150 (18000)	5300 (11700)	13050 (28800)	8200 (18100)	*15700 (34600)	*15700 (34600)		
-3.0 m (-10')		7250 (16000)	4800 (10500)			8250 (18200)	5400 (11900)	13150 (29000)	8350 (18400)	*19100 (42200)	17800 (39300)		
-4.6 m (-15')		*9000 (19800)	7600 (16800)					*10000 (22000)	8650 (19100)				
Arm length 3045 mm (10'0")													
7.6 m (25')		*3450 (7600)	*3450 (7600)										
6.1 m (20')		*3300 (7300)	*3300 (7300)	*4200 (9200)	*4200 (9200)	*6350 (14000)	*6350 (14000)						
4.6 m (15')		*3350 (7300)	*3350 (7300)	*6250 (13800)	4300 (9500)	*7200 (15900)	6400 (14100)						
3.0 m (10')		*3550 (7800)	3150 (6900)	6150 (13600)	4150 (9100)	*8500 (18700)	6050 (13300)	*10900 (24000)	9550 (21100)	*17850 (39300)	*17850 (39300)		
1.5 m (5')		*3900 (8600)	3050 (6700)	6000 (13200)	3950 (8800)	8550 (18900)	5700 (12500)	*13250 (29300)	8850 (19500)	*7800 (17200)	*7800 (17200)		
0 m (0')		*4500 (9900)	3100 (6800)	5850 (12900)	3850 (8400)	8300 (18300)	5400 (12000)	13250 (29200)	8350 (18500)	*9600 (21200)	*9600 (21200)		
-1.5 m (-5')		5150 (11400)	3350 (7400)	5750 (12700)	3750 (8300)	8150 (17900)	5300 (11700)	13050 (28700)	8200 (18100)	*13950 (30700)	*13950 (30700)	*8850 (19500)	*8850 (19500)
-3.0 m (-10')		6100 (13500)	4000 (8800)			8150 (18000)	5300 (11700)	13100 (28800)	8250 (18200)	*20100 (44300)	17600 (38800)	*13650 (30100)	*13650 (30100)
-4.6 m (-15')		*8450 (18600)	5750 (12600)					*11600 (25600)	8500 (18700)	*16650 (36700)	*16650 (36700)		
Arm length 3500 mm (11'6")													
7.6 m (25')		*2900 (6400)	*2900 (6400)										
6.1 m (20')		*2800 (6100)	*2800 (6100)	*4450 (9800)	4450 (9800)								
4.6 m (15')		*2800 (6200)	*2800 (6200)	*5800 (12800)	4350 (9600)	*6600 (14500)	6450 (14300)						
3.0 m (10')		*3000 (6600)	2900 (6400)	6150 (13600)	4150 (9100)	*7950 (17500)	6050 (13400)	*9950 (22000)	9700 (21400)	*15500 (34200)	*15500 (34200)		
1.5 m (5')		*3300 (7200)	2750 (6100)	5950 (13100)	3950 (8700)	8550 (18900)	5700 (12500)	*12400 (27300)	8700 (19200)	*11050 (24300)	*11050 (24300)		
0 m (0')		*3750 (8300)	2800 (6200)	5800 (12700)	3750 (8300)	8250 (18200)	5350 (11800)	13200 (29100)	8350 (18400)	*10450 (23000)	*10450 (23000)		
-1.5 m (-5')		*4600 (10100)	3050 (6700)	5650 (12500)	3650 (8100)	8050 (17700)	5200 (11500)	12900 (28500)	8100 (17800)	*13600 (29900)	*13600 (29900)	*8300 (18300)	*8300 (18300)
-3.0 m (-10')		5500 (12100)	3550 (7900)	5700 (12500)	3700 (8100)	8000 (17700)	5150 (11400)	12900 (28400)	8050 (17800)	*18500 (40800)	17250 (38100)	*12400 (27300)	*12400 (27300)
-4.6 m (-15')		7450 (16500)	4850 (10800)			*8150 (18000)	5300 (11700)	*12350 (27300)	8250 (18200)	*18100 (39900)	17750 (39200)		

* Load is limited by hydraulic capacity rather than tipping.
 Ratings are based on SAE Standard NO. 1097. Rated loads do not exceed 87% of hydraulic lift capacity or 75% of tipping load.

PC270LC-8

Conditions:

Boom: 5850 mm (19'2"), Bucket (SAE): 1.26 m³ (1.65 cu.yd), Shoes: 700 mm (24")

Lifting mode: ON

unit: kg (lb)

B	A	MAX		7.6 m (25')		6.1 m (20')		4.6 m (15')		3.0 m (10')		1.5 m (5')	
		Cf	Cs	Cf	Cs	Cf	Cs	Cf	Cs	Cf	Cs	Cf	Cs
Arm length 3045 mm (10'0")													
7.6 m (25')		*3450 (7600)	*3450 (7600)										
6.1 m (20')		*3300 (7300)	*3300 (7300)	*4100 (9100)	*4100 (9100)	*6350 (14000)	*6350 (14000)						
4.6 m (15')		*3350 (7300)	*3350 (7300)	*6250 (13800)	4550 (10000)	*7200 (15900)	6750 (14900)						
3.0 m (10')		*3500 (7800)	3350 (7400)	*7250 (16000)	4400 (9700)	*8450 (18700)	6400 (14100)	*10850 (24000)	10200 (22500)	*13500 (29800)	*13500 (29800)		
1.5 m (5')		*3900 (8600)	3250 (7100)	7100 (15700)	4200 (9300)	*9750 (21500)	6050 (13300)	*13350 (29400)	9400 (20800)	*8350 (18400)	*8350 (18400)		
0 m (0')		*4500 (9900)	3300 (7300)	6950 (15300)	4050 (9000)	9950 (21900)	5750 (12700)	*12500 (27500)	8950 (19700)	*9950 (21900)	*9950 (21900)		
-1.5 m (-5')		*5550 (12200)	3600 (8000)	6900 (15200)	4000 (8800)	9800 (21600)	5600 (12400)	*12150 (26800)	8750 (19300)	*10600 (23400)	*10600 (23400)	*8950 (19700)	*8950 (19700)
-3.0 m (-10')		7400 (16300)	4300 (9500)			9800 (21600)	5650 (12400)	*12850 (28400)	8800 (19400)	*10700 (23600)	*10700 (23600)	*11050 (24400)	*11050 (24400)
-4.6 m (-15')		*8450 (18600)	6050 (13300)					*11750 (25900)	9050 (20000)	*11500 (25300)	*11500 (25300)		
Arm length 3500 mm (11'6")													
7.6 m (25')		*2900 (6400)	*2900 (6400)										
6.1 m (20')		*2800 (6100)	*2800 (6100)	*4400 (9700)	*4400 (9700)								
4.6 m (15')		*2800 (6200)	*2800 (6200)	*5800 (12800)	4550 (10100)	*6600 (14600)	*6600 (14600)						
3.0 m (10')		*2950 (6600)	*2950 (6600)	*6850 (15100)	4400 (9700)	*7900 (17400)	6400 (14200)	*9950 (21900)	*9950 (21900)	*13800 (30500)	*13800 (30500)		
1.5 m (5')		*3250 (7200)	2950 (6600)	7100 (15600)	4200 (9200)	*9250 (20400)	6000 (13300)	*12550 (27700)	9500 (20900)	*9700 (21400)	*9700 (21400)		
0 m (0')		*3750 (8300)	3000 (6700)	6900 (15200)	4000 (8800)	9900 (21900)	5700 (12600)	*11100 (24400)	8900 (19600)	*9550 (21100)	*9550 (21100)		
-1.5 m (-5')		*4600 (10200)	3250 (7200)	6800 (15000)	3900 (8600)	9700 (21400)	5550 (12200)	*10600 (23400)	8650 (19100)	*9550 (21100)	*9550 (21100)	*8400 (18600)	*8400 (18600)
-3.0 m (-10')		*6250 (13800)	3850 (8500)	6800 (15000)	3900 (8600)	9650 (21300)	5500 (12100)	*10850 (24000)	8650 (19000)	*9550 (21100)	*9550 (21100)	*10050 (22100)	*10050 (22100)
-4.6 m (-15')		*8150 (18000)	5150 (11300)			*9000 (19800)	5650 (12400)	*12000 (26500)	8850 (19500)	*9900 (21800)	*9900 (21800)		
Arm length 2500 mm (8'2")													
7.6 m (25')		*5550 (12300)	*5550 (12300)										
6.1 m (20')		*5350 (11800)	5100 (11300)			*7150 (15700)	6850 (15100)						
4.6 m (15')		*5450 (12000)	4250 (9300)	*6800 (14900)	4500 (9900)	*7900 (17400)	6650 (14600)	*9400 (20700)	*9400 (20700)				
3.0 m (10')		*5800 (12800)	3800 (8400)	7250 (16000)	4350 (9600)	*9050 (20000)	6300 (13900)	*11900 (26300)	9900 (21900)				
1.5 m (5')		6200 (13700)	3650 (8100)	7100 (15600)	4200 (9200)	10200 (22400)	5950 (13100)	*11750 (25900)	9200 (20300)				
0 m (0')		6400 (14100)	3750 (8300)	6950 (15400)	4100 (9000)	9900 (21900)	5750 (12600)	*10800 (23800)	8850 (19500)	*9300 (20500)	*9300 (20500)		
-1.5 m (-5')		7100 (15600)	4150 (9100)			9850 (21700)	5650 (12500)	*10850 (23900)	8800 (19400)	*10450 (23000)	*10450 (23000)		
-3.0 m (-10')		8800 (19400)	5100 (11300)			*9900 (21800)	5750 (12600)	*11750 (25900)	8900 (19600)	*10100 (22300)	*10100 (22300)		
-4.6 m (-15')		*9000 (19900)	7950 (17500)					*10200 (22500)	9250 (20400)				

* Load is limited by hydraulic capacity rather than tipping. Ratings are based on ISO Standard NO. 10567. Rated loads do not exceed 87% of hydraulic lift capacity or 75% of tipping load.

PC290LC-10 (USA source)

Conditions:

Boom: 6150 mm (20'2"), Bucketless, Shoes: 800 mm (31.5")

unit: kg (lb)

B	A	MAX		9.1 m (30')		7.6 m (25')		6.1 m (20')		4.6 m (15')		3.0 m (10')	
		Cf	Cs	Cf	Cs	Cf	Cs	Cf	Cs	Cf	Cs	Cf	Cs
Arm length 3200 mm (10'6")													
7.6 m (25')		*4700 (10400)	*4700 (10400)										
6.1 m (20')		*4500 (10000)	*4500 (10000)			*6350 (14000)	5900 (13000)	*7350 (16200)	*7350 (16200)				
4.6 m (15')		*4500 (10000)	*4500 (10000)			*7550 (16700)	5800 (12800)	*8300 (18300)	8100 (17900)	*9700 (21400)	*9700 (21400)		
3.0 m (10')		*4650 (10300)	4400 (9700)			*8200 (18100)	5650 (12400)	*9550 (21100)	7750 (17100)	*12400 (27300)	11700 (25800)		
1.5 m (5')		*5000 (11000)	4300 (9500)			8350 (18400)	5450 (12100)	*10800 (23800)	7400 (16300)	*14700 (32400)	11000 (24300)		
0 m (0')		*5500 (12200)	4350 (9600)			8200 (18100)	5350 (11800)	11350 (25000)	7150 (15800)	*15850 (34900)	10650 (23400)	*7350 (16200)	*7350 (16200)
-1.5 m (-5')		*6450 (14200)	4650 (10300)			8100 (17900)	5250 (11600)	11200 (24700)	7050 (15500)	*15850 (35000)	10500 (23200)	*12550 (27700)	*12550 (27700)
-3.0 m (-10')		*8200 (18100)	5350 (11800)					11250 (24800)	7050 (15600)	*14900 (32900)	10550 (23300)	*19300 (42500)	*19300 (42500)
-4.6 m (-15')		*8800 (19400)	6950 (15400)					*9250 (20400)	7250 (16000)	*12600 (27800)	10800 (23800)	*17100 (37700)	*17100 (37700)
Arm length 3500 mm (11'6")													
7.6 m (25')		*4300 (9500)	*4300 (9500)										
6.1 m (20')		*4150 (9200)	*4150 (9200)			*6350 (14000)	5950 (13100)						
4.6 m (15')		*4150 (9200)	*4150 (9200)			*7300 (16100)	5850 (12900)	*7900 (17400)	*7900 (17400)				
3.0 m (10')		*4300 (9500)	4250 (9300)	*5000 (11000)	4300 (9500)	*7950 (17500)	5650 (12500)	*9200 (20300)	7750 (17100)	*11750 (25900)	*11750 (25900)		
1.5 m (5')		*4600 (10100)	4100 (9100)	*5750 (12700)	4250 (9500)	8350 (18400)	5450 (12000)	*10500 (23100)	7400 (16300)	*14200 (31300)	11050 (24300)		
0 m (0')		*5050 (11100)	4200 (9200)			8150 (18000)	5300 (11700)	11300 (25000)	7100 (15700)	*15600 (34400)	10600 (23300)	*8200 (18100)	*8200 (18100)
-1.5 m (-5')		*5850 (12900)	4450 (9800)			8050 (17800)	5200 (11500)	11150 (24600)	7000 (15400)	*15850 (34900)	10400 (23000)	*12550 (27600)	*12550 (27600)
-3.0 m (-10')		*7400 (16300)	5050 (11100)			8100 (17900)	5250 (11500)	11150 (24600)	6950 (15400)	*15100 (33300)	10450 (23300)	*18300 (40300)	*18300 (40300)
-4.6 m (-15')		*8650 (19100)	6400 (14100)					*9800 (21600)	7100 (15700)	*13150 (29000)	10650 (23500)	*18050 (39900)	*18050 (39900)

* Load is limited hydraulic capacity rather than tipping.

Ratings are based on ISO Standard No.10567. Rated loads do not exceed 87% of hydraulic lift capacity or 75% of tipping load.

PC290LC-10 (USA source)

Conditions:

Boom: 6150 mm (20'2"), Bucketless, Shoes: 850 mm (33.5")

unit: kg (lb)

B	A	MAX		9.1 m (30')		7.6 m (25')		6.1 m (20')		4.6 m (15')		3.0 m (10')	
		Cf	Cs	Cf	Cs	Cf	Cs	Cf	Cs	Cf	Cs	Cf	Cs
Arm length 3200 mm (10'6")													
7.6 m (25')	*4700 (10400)	*4700 (10400)											
6.1 m (20')	*4500 (10000)	*4500 (10000)			*6350 (14000)	5950 (13100)	*7350 (16200)	*7350 (16200)					
4.6 m (15')	*4500 (10000)	*4500 (10000)			*7550 (16700)	5850 (12900)	*8300 (18300)	8150 (18000)	*9700 (21400)	*9700 (21400)			
3.0 m (10')	*4650 (10300)	4450 (9800)			*8200 (18100)	5700 (12500)	*9550 (21100)	7800 (17200)	*12400 (27300)	11750 (2600)			
1.5 m (5')	*5000 (11000)	4300 (9500)			8400 (18500)	5500 (12100)	*10800 (23800)	7450 (16400)	*14700 (32400)	11050 (24400)			
0 m (0')	*5500 (12200)	4400 (9700)			8250 (18200)	5350 (11800)	11400 (25200)	7200 (15900)	*15850 (34900)	10700 (23600)	*7350 (16200)	*7350 (16200)	
-1.5 m (-5')	*6450 (14200)	4700 (10400)			8150 (18000)	5300 (11700)	11300 (24900)	7100 (15600)	*15850 (35000)	10550 (23300)	*12550 (27700)	*12550 (27700)	
-3.0 m (-10')	*8200 (18100)	5400 (11900)					11300 (24900)	7100 (15700)	*14900 (32900)	10650 (23400)	*19300 (42500)	*19300 (42500)	
-4.6 m (-15')	*8800 (19400)	7000 (15500)					*9250 (20400)	7300 (16100)	*12600 (27800)	10850 (23900)	*17100 (37700)	*17100 (37700)	
Arm length 3500 mm (11'6")													
7.6 m (25')	*4300 (9500)	*4300 (9500)											
6.1 m (20')	*4150 (9200)	*4150 (9200)			*6350 (14000)	6000 (13200)							
4.6 m (15')	*4150 (9200)	*4150 (9200)			*7300 (16100)	5850 (12900)	*7900 (17400)	*7900 (17400)					
3.0 m (10')	*4300 (9500)	4250 (9400)	*5000 (11000)	4350 (9600)	*7950 (17500)	5700 (12500)	*9200 (20300)	7800 (17200)	*11750 (25900)	*11750 (25900)			
1.5 m (5')	*4600 (10100)	4150 (9100)	*5750 (12700)	4250 (9400)	8400 (18500)	5500 (12100)	*10500 (23100)	7450 (16400)	*14200 (31300)	11100 (24500)			
0 m (0')	*5050 (11100)	4200 (9300)			8200 (18100)	5350 (11800)	11400 (25100)	7150 (15800)	*15600 (34400)	10650 (23500)	*8200 (18100)	*8200 (18100)	
-1.5 m (-5')	*5850 (12900)	4450 (9900)			8100 (17900)	5250 (11600)	11200 (24800)	7000 (15500)	*15850 (34900)	10450 (23100)	*12550 (27600)	*12550 (27600)	
-3.0 m (-10')	*7400 (16300)	5050 (11200)			8150 (18000)	5250 (11600)	11200 (24700)	7000 (15500)	*15100 (33300)	10500 (23200)	*18300 (40300)	*18300 (40300)	
-4.6 m (-15')	*8650 (19100)	6450 (14200)					*9800 (21600)	7150 (15800)	*13150 (29000)	10700 (23600)	*18050 (39900)	*18050 (39900)	

* Load is limited hydraulic capacity rather than tipping.
 Ratings are based on ISO Standard No.10567. Rated loads do not exceed 87% of hydraulic lift capacity or 75% of tipping load.

PC290LC-10 (UK source)

Conditions:

One-piece boom: 6150 mm, Bucketless, Shoes: 700 mm

unit :kg

B	A	MAX		9.0 m		7.5 m		6.0 m		4.5 m		3.0 m	
		Cf	Cs	Cf	Cs	Cf	Cs	Cf	Cs	Cf	Cs	Cf	Cs
Arm length 2000 mm													
	7.5 m	*8010	*8010										
	6.0 m	*7540	6720					*8950	8320	*10040	*10040		
	4.5 m	*7520	5730			*8710	5830	9780	8080	*12260	*12260		
	3.0 m	*7800	5270			8600	5720	*10920	7750	*14940	11450		
	1.5 m	7720	5140			8460	5590	11700	7490				
	0 m	7990	5280			8380	5510	11530	7340	*16240	10910		
	-1.5 m	8850	5800					11510	7330	*15390	10950	*12450	*12450
	-3.0 m	*9620	7060					*10290	7460	*13560	11130	*16990	*16990
	-4.5 m												
Arm length 2650 mm													
	7.5 m	*6990	*6990					*7860	*7860				
	6.0 m	*6700	5940			*6730	5950	*8090	*8090				
	4.5 m	*6730	5170			*8110	5870	*9010	8140	*10940	*10940		
	3.0 m	*7000	4780			8600	5700	*10240	7780	*13640	11650		
	1.5 m	7000	4650			8420	5540	*11350	7460	*15610	11030		
	0 m	7190	4750			8290	5420	11450	7260	*16220	10780		
	-1.5 m	7820	5130			8250	5390	11370	7190	*15820	10750	*12950	*12950
	-3.0 m	*9180	6020					*11040	7250	*14470	10870	*19320	*19320
	-4.5 m	*9130	8300							*11580	11170		
Arm length 3200 mm													
	7.5 m	*4720	*4720										
	6.0 m	*4530	*4530			*6810	6050	*7380	*7380				
	4.5 m	*4530	*4530			*7600	5930	*8360	8260	*9860	*9860		
	3.0 m	*4670	4390	*4810	4400	*8250	5740	*9670	7880	*12600	11910		
	1.5 m	*4980	4270	*5580	4320	8440	5550	*10920	7520	*14920	11180		
	0 m	*5510	4340			8280	5410	11470	7260	*16030	10800		
	-1.5 m	*6410	4640			8200	5340	11330	7150	*16040	10680	*12240	*12240
	-3.0 m	8100	5300			8250	5380	11350	7160	*15100	10740	*18740	*18740
	-4.5 m	*8740	6810					*9570	7330	*12890	10970	*17440	*17440
Arm length 3500 mm													
	7.5 m	*4310	*4310										
	6.0 m	*4160	*4160			*6620	6110						
	4.5 m	*4170	*4170			*7340	5970	*8000	*8000				
	3.0 m	*4310	4230	*5760	4430	*8030	5780	*9340	7940	*12010	*12010		
	1.5 m	*4590	4120	6500	4330	8460	5570	*10660	7550	*14480	11260		
	0 m	*5060	4180	*6050	4250	8280	5410	11480	7270	*15840	10810	*7940	*7940
	-1.5 m	*5850	4440			8180	5320	11310	7130	*16080	10650	*12180	*12180
	-3.0 m	*7310	5010			8200	5330	11300	7110	*15350	10670	*17770	*17770
	-4.5 m	*8640	6290					*10100	7250	*13450	10870	*18480	*18480

* Load is limited hydraulic capacity rather than tipping.
 Ratings are based on SAE Standard No. J1097. Rated loads do not exceed 87% of hydraulic lift capacity or 75% of tipping load.

PC290NLC-10 (UK source)

Conditions:

One-piece boom: 6150 mm, Bucketless, Shoes: 600 mm

unit :kg

B	A	MAX		9.0 m		7.5 m		6.0 m		4.5 m		3.0 m	
		Cf	Cs	Cf	Cs	Cf	Cs	Cf	Cs	Cf	Cs	Cf	Cs
Arm length 2000 mm													
	7.5 m	*8010	*8010										
	6.0 m	*7540	6050					*8950	7500	*10040	*10040		
	4.5 m	*7520	5160			8480	5250	*9780	7250	*12260	10930		
	3.0 m	7680	4730			8350	5130	*10920	6940	*14940	10140		
	1.5 m	7500	4600			8210	5010	11360	6680				
	0 m	7750	4730			8130	4930	11200	6540	*16240	9610		
	-1.5 m	8590	5190					11180	6520	*15390	9660	*12450	*12450
	-3.0 m	*9620	6300					*10290	6650	*13560	9820	*16990	*16990
	-4.5 m												
Arm length 2650 mm													
	7.5 m	*6990	6810					*7860	7680				
	6.0 m	*6700	5350			*6730	5360	*8090	7590				
	4.5 m	*6730	4640			*8110	5280	*9010	7320	*10940	*10940		
	3.0 m	6950	4290			8350	5120	*10240	6960	*13640	10330		
	1.5 m	6790	4160			8170	4950	11350	6650	*15610	9730		
	0 m	6970	4250			8040	4840	11120	6450	*16220	9480		
	-1.5 m	7590	4580			8010	4810	11040	6380	*15820	9450	*12950	*12950
	-3.0 m	9000	5370					*11040	6440	*14470	9570	*19320	18490
	-4.5 m	*9130	7390							*11580	9860		
Arm length 3200 mm													
	7.5 m	*4720	*4720										
	6.0 m	*4530	*4530			*6810	5460	*7380	*7380				
	4.5 m	*4530	4230			*7600	5340	*8360	7430	*9860	*9860		
	3.0 m	*4670	3930	*4810	3940	*8250	5160	*9670	7060	*12600	10580		
	1.5 m	*4980	3820	*5580	3860	8190	4970	*10920	6700	*14920	9870		
	0 m	*5510	3880			8030	4830	11130	6460	*16030	9500		
	-1.5 m	*6410	4140			7960	4760	11000	6340	*16040	9390	*12240	*12240
	-3.0 m	7860	4720			8000	4800	11010	6350	*15100	9450	*18740	18210
	-4.5 m	*8740	6070					*9570	6520	*12890	9670	*17440	*17440
Arm length 3500 mm													
	7.5 m	*4310	*4310										
	6.0 m	*4160	*4160			*6620	5520						
	4.5 m	*4170	4070			*7340	5380	*8000	7500				
	3.0 m	*4310	3790	*5760	3970	*8030	5190	*9340	7120	*12010	10720		
	1.5 m	*4590	3690	6310	3870	8220	4990	*10660	6740	*14480	9950		
	0 m	*5060	3730	*6050	3800	8040	4830	11150	6460	*15480	9510	*7940	*7940
	-1.5 m	*5850	3690			7940	4740	10980	6320	*16080	9350	*12180	*12180
	-3.0 m	*7310	4470			7950	4750	10960	6310	*15350	9380	*17770	*17770
	-4.5 m	*8640	5610					*10100	6440	*13450	9570	*18480	18440

* Load is limited hydraulic capacity rather than tipping.
 Ratings are based on SAE Standard No. J1097. Rated loads do not exceed 87% of hydraulic lift capacity or 75% of tipping load.

PC300-8

Conditions:

Boom: 6470 mm (21'3"), Bucket (SAE): 1.40 m³ (1.83 cu.yd), Shoes: 600 mm (24")

Lifting mode: ON

unit: kg (lb)

B	A	MAX		9.0 m (29')		7.5 m (24')		6.0 m (19')		4.5 m (14')		3.0 m (9')	
		Cf	Cs	Cf	Cs	Cf	Cs	Cf	Cs	Cf	Cs	Cf	Cs
Arm length 3185 mm (10'5")													
7.5 m (24')	*5300 (11700)	4950 (10900)			*6850 (15200)	5400 (11900)							
6.0 m (19')	*5250 (11600)	3950 (8700)			*7250 (16000)	5350 (11800)							
4.5 m (14')	5050 (11200)	3350 (7400)	5350 (11800)	3600 (7900)	7500 (16500)	5150 (11300)	*9200 (20300)	7600 (16700)					
3.0 m (9')	4700 (10300)	3050 (6800)	5250 (11500)	3450 (7600)	7150 (15800)	4850 (10700)	10450 (23000)	7050 (15600)	*15000 (33100)	11200 (24700)			
1.5 m (4')	4550 (10000)	2950 (6500)	5050 (11200)	3300 (7300)	6900 (15200)	4550 (10100)	9900 (21800)	6550 (14500)	16000 (35300)	10200 (22500)			
0 m (0')	4600 (10200)	3000 (6600)	4950 (10900)	3200 (7100)	6650 (14700)	4350 (9600)	9500 (21000)	6200 (13700)	15400 (34000)	9700 (21400)			
-1.5 m (-4')	4950 (11000)	3200 (7100)	4900 (10800)	3150 (7000)	6550 (14400)	4250 (9400)	9350 (20600)	6050 (13300)	15250 (33700)	9550 (21100)	*9600 (21100)	*9600 (21100)	
-3.0 m (-9')	5750 (12700)	3750 (8200)			6550 (14400)	4250 (9400)	9350 (20600)	6050 (13300)	15300 (33800)	9700 (21400)	*18050 (39700)	*18050 (39700)	
-4.5 m (-14')	7450 (16400)	4900 (10800)					9450 (20900)	6200 (13700)	*12850 (28400)	9950 (22000)	*16600 (36600)	*16600 (36600)	
-6.0 m (-19')	*6300 (13900)	*6300 (13900)							*8150 (18000)	*8150 (18000)			
Arm length 4020 mm (13'2")													
7.5 m (24')	*4150 (9200)	4050 (8900)											
6.0 m (19')	*4050 (9000)	3300 (7300)	5700 (12500)	3900 (8600)									
4.5 m (14')	*4150 (9100)	2900 (6400)	5550 (12300)	3750 (8300)	*7100 (15700)	5350 (11800)							
3.0 m (9')	4100 (9000)	2650 (5800)	5350 (11800)	3600 (7900)	7350 (16300)	5000 (11100)	*9650 (21300)	7300 (16200)	*12950 (28600)	11800 (26000)			
1.5 m (4')	3950 (8700)	2550 (5600)	5150 (11400)	3400 (7500)	7000 (15400)	4650 (10300)	10100 (22300)	6750 (14800)	*15950 (35200)	10550 (23300)			
0 m (0')	4000 (8800)	2550 (5600)	5000 (11000)	3250 (7100)	6700 (14800)	4400 (9700)	9600 (21100)	6250 (13800)	15450 (34100)	9700 (21400)			
-1.5 m (-4')	4250 (9400)	2700 (5900)	4850 (10700)	3100 (6900)	6500 (14300)	4200 (9300)	9250 (20400)	5950 (13200)	15050 (33100)	9350 (20600)	*9750 (21500)	*9750 (21500)	
-3.0 m (-9')	4750 (10500)	3050 (6700)	4850 (10700)	3100 (6900)	6450 (14200)	4150 (9100)	9150 (20200)	5900 (13000)	15000 (33100)	9350 (20600)	*15450 (34100)	*15450 (34100)	
-4.5 m (-14')	5800 (12800)	3750 (8300)			6500 (14400)	4200 (9300)	9250 (20400)	6000 (13200)	*14500 (31900)	9550 (21100)	*20000 (44100)	19800 (43600)	
-6.0 m (-19')	*6550 (14400)	5400 (11900)					*8150 (18000)	6250 (13800)	*11050 (24400)	9850 (21700)	*14600 (32200)	*14600 (32200)	

* Load is limited by hydraulic capacity rather than tipping. Ratings are based on SAE Standard NO. J1097. Rated loads do not exceed 87% of hydraulic lift capacity or 75% of tipping load.

PC300-8

Conditions:

Boom: 6470 mm (21'3"), Bucket (SAE): 1.40 m³ (1.83 cu.yd), Shoes: 600 mm (24")

Lifting mode: ON

unit: kg (lb)

B	A	MAX		9.0 m (29')		7.5 m (24')		6.0 m (19')		4.5 m (14')		3.0 m (9')	
		Cf	Cs	Cf	Cs	Cf	Cs	Cf	Cs	Cf	Cs	Cf	Cs
Arm length 2200 mm (7'3")													
7.5 m (24')	*8650 (19100)	6750 (14900)											
6.0 m (19')	7350 (16200)	5000 (11100)			7450 (16400)	5100 (11200)	*9100 (20100)	7700 (17000)					
4.5 m (14')	6200 (13700)	4150 (9200)			7250 (16000)	4900 (10800)	*10250 (22600)	7200 (15900)	*13800 (30400)	11600 (25600)			
3.0 m (9')	5650 (12400)	3750 (8200)			6950 (15300)	4650 (10200)	10050 (22200)	6700 (14800)					
1.5 m (4')	5450 (12000)	3550 (7800)			6700 (14800)	4400 (9700)	9600 (21100)	6250 (13800)					
0 m (0')	5600 (12300)	3650 (8000)			6550 (14500)	4250 (9400)	9300 (20500)	6000 (13300)					
-1.5 m (-4')	6150 (13600)	4000 (8800)			6500 (14400)	4250 (9300)	9250 (20400)	5950 (13100)	15150 (33400)	9550 (21100)			
-3.0 m (-9')	7550 (16600)	4900 (10800)					9400 (20700)	6100 (13400)	*13400 (29600)	9750 (21500)	*14850 (32700)	*14850 (32700)	
-4.5 m (-14')	*7750 (17100)	7350 (16300)					*6550 (14400)	6450 (14200)	*9850 (21800)	9850 (21800)			
Arm length 2550 mm (8'4")													
7.5 m (24')	*7600 (16700)	5750 (12600)											
6.0 m (19')	6500 (14300)	4450 (9800)			7550 (16700)	5200 (11500)							
4.5 m (14')	5600 (12400)	3750 (8300)			7350 (16200)	5000 (11000)	*9900 (21900)	7350 (16200)	*13000 (28600)	11900 (26200)			
3.0 m (9')	5150 (11400)	3400 (7500)	5150 (11400)	3400 (7500)	7050 (15500)	4700 (10400)	10200 (22500)	6850 (15100)	*15500 (34100)	10650 (23500)			
1.5 m (4')	5000 (11000)	3250 (7200)	5000 (11100)	3250 (7200)	6750 (14900)	4450 (9900)	9700 (21400)	6350 (14100)					
0 m (0')	5100 (11300)	3300 (7300)	4950 (10900)	3200 (7000)	6600 (14500)	4300 (9500)	9400 (20700)	6100 (13400)	*14650 (32300)	9500 (20900)			
-1.5 m (-4')	5550 (12300)	3600 (8000)			6500 (14400)	4250 (9300)	9250 (20400)	6000 (13200)	*15200 (33600)	9550 (21100)			
-3.0 m (-9')	6600 (14600)	4300 (9500)			6600 (14500)	4300 (9500)	9350 (20600)	6050 (13400)	*14250 (31500)	9750 (21500)	*17150 (37800)	*17150 (37800)	
-4.5 m (-14')	*7400 (16400)	6000 (13200)					*8300 (18300)	6350 (14000)	*11050 (24300)	9950 (22000)	*13100 (28900)	*13100 (28900)	

* Load is limited by hydraulic capacity rather than tipping.
 Ratings are based on SAE Standard NO. J1097. Rated loads do not exceed 87% of hydraulic lift capacity or 75% of tipping load.

PC300-7

Conditions:

Boom: 6470 mm (21'3"), Bucket (SAE): 1.40 m³ (1.83 cu.yd), Shoes: 600 mm (24")

unit: kg (lb)

B	A	MAX		9.1 m (30')		7.6 m (25')		6.1 m (20')		4.6 m (15')		3.0 m (10')	
		Cf	Cs	Cf	Cs	Cf	Cs	Cf	Cs	Cf	Cs	Cf	Cs
Arm length 3185 mm (10'5")													
7.6 m (25')		*4600 (10100)	*4600 (10100)			*5950 (13200)	5200 (11500)						
6.1 m (20')		*4500 (9900)	3750 (8300)			*6550 (14400)	5200 (11400)						
4.6 m (15')		*4600 (10100)	3250 (7200)	5200 (11500)	3500 (7700)	*7050 (15500)	5000 (11000)	*8150 (18000)	7400 (16300)				
3.0 m (10')		4500 (9900)	2950 (6500)	5100 (11200)	3350 (7400)	*6950 (15300)	4700 (10400)	*9500 (20900)	6850 (15100)	10550 (23300)			
1.5 m (5')		4350 (9600)	2800 (6200)	4950 (10900)	3250 (7100)	6700 (14800)	4450 (9800)	9550 (21100)	6350 (14000)	*14800 (32600)	9750 (21500)		
0 m (0')		4450 (9800)	2850 (6300)	4800 (10500)	3100 (6900)	6450 (14200)	4250 (9400)	9150 (20200)	6000 (13200)	14600 (32200)	9200 (20300)	*7250 (16000)	*7250 (16000)
-1.5 m (-5')		4750 (10500)	3100 (6800)	4800 (10500)	3100 (6800)	6350 (14000)	4150 (9100)	9000 (19800)	5800 (12800)	14400 (31700)	9050 (19900)	*11750 (25900)	*11750 (25900)
-3.0 m (-10')		5500 (12100)	3550 (7900)			6350 (14000)	4150 (9100)	8950 (19700)	5800 (12800)	*13950 (30800)	9100 (20100)	*17200 (37900)	*17200 (37900)
-4.6 m (-15')		*6700 (14700)	4750 (10400)					*8500 (18700)	6000 (13200)	*11350 (25000)	9350 (20700)	*15250 (33600)	*15200 (33700)
-6.1 m (-20')		*5600 (12300)	*5600 (12300)							*6750 (14900)	*6750 (14900)		
Arm length 4020 mm (13'2")													
7.6 m (25')		*3550 (7900)	*3550 (7900)										
6.1 m (20')		*3500 (7700)	3200 (7000)	*5350 (11800)	3750 (8300)								
4.6 m (15')		*3550 (7800)	2800 (6200)	5400 (11900)	3650 (8100)	*6400 (14100)	5200 (11500)						
3.0 m (10')		*3700 (8200)	2550 (5600)	5200 (11500)	3500 (7700)	7150 (15800)	4900 (10800)	*8600 (19000)	7100 (15700)	*11200 (24700)	*11200 (24700)	18050 (39800)	18050 (39800)
1.5 m (5')		3800 (8400)	2450 (5400)	5000 (11000)	3300 (7300)	6800 (15000)	4550 (10000)	9750 (21500)	6500 (14400)	*13650 (30100)	10100 (22300)	*8050 (17800)	*8050 (17800)
0 m (0')		3850 (8500)	2450 (5400)	4850 (10700)	3150 (6900)	6500 (14300)	4300 (9400)	9250 (20400)	6050 (13300)	14700 (32400)	9300 (20500)	*8100 (17800)	*8100 (17800)
-1.5 m (-5')		4100 (9000)	2600 (5700)	4750 (10500)	3050 (6700)	6300 (13900)	4100 (9000)	8900 (19700)	5750 (12700)	14250 (31400)	8900 (19600)	*10800 (23800)	*10800 (23800)
-3.0 m (-10')		4550 (10000)	2950 (6500)	4750 (10400)	3050 (6700)	6250 (13700)	4000 (8900)	8800 (19400)	5650 (12500)	14150 (31200)	8800 (19400)	*14650 (32300)	*14650 (32300)
-4.6 m (-15')		5600 (12300)	3650 (8000)			6300 (13900)	4100 (9000)	8900 (19600)	5750 (12600)	*12800 (28200)	9000 (19800)	*18300 (40300)	*18300 (40300)
-6.1 m (-20')		*5800 (12800)	5250 (11600)					*6950 (15300)	6000 (13200)	*9550 (21100)	9350 (20700)	*13100 (28800)	*13100 (28800)

* Load is limited by hydraulic capacity rather than tipping. Ratings are based on SAE Standard NO. J1097. Rated loads do not exceed 87% of hydraulic lift capacity or 75% of tipping load.

PC300-7

Conditions:

Boom: 6470 mm (21'3"), Bucket (SAE): 1.40 m³ (1.83 cu.yd), Shoes: 600 mm (24")

unit: kg (lb)

B	A	MAX		9.1 m (30')		7.6 m (25')		6.1 m (20')		4.6 m (15')		3.0 m (10')	
		Cf	Cs	Cf	Cs	Cf	Cs	Cf	Cs	Cf	Cs	Cf	Cs
Arm length 2200 mm (7'3")													
7.6 m (25')	*7650 (16900)	6400 (14100)											
6.1 m (20')	7000 (15400)	4800 (10600)			7200 (15900)	4950 (10900)	*8200 (18100)	7450 (16400)					
4.6 m (15')	5950 (13100)	4000 (8800)			7050 (15500)	4800 (10600)	*9100 (20100)	7050 (15500)	*11750 (26000)	11200 (24700)			
3.0 m (10')	5350 (11800)	3550 (7800)			6750 (14900)	4550 (10000)	9700 (21400)	6500 (14300)	*14200 (31300)	9900 (21800)			
1.5 m (5')	5200 (11500)	3400 (7500)			6550 (14400)	4300 (9500)	9050 (20000)	5900 (13000)	14450 (31900)	9100 (20100)			
0 m (0')	5350 (11800)	3450 (7600)			6350 (14000)	4150 (9200)	8950 (19700)	5800 (12800)	14200 (31300)	8850 (19500)			
-1.5 m (-5')	5850 (12900)	3800 (8400)			6350 (14000)	4100 (9100)	8900 (19600)	5750 (12600)	*14100 (31100)	8900 (19600)	*14200 (31300)	*14200 (31300)	
-3.0 m (-10')	7100 (15700)	4650 (10300)					8850 (19500)	5700 (12600)	*12200 (26900)	9100 (20100)	*15100 (33300)	*15100 (33300)	
-4.6 m (-15')	*6900 (15200)	*6900 (15200)							*8550 (18800)	*8550 (18800)			
Arm length 2550 mm (8'4")													
7.6 m (25')	*6500 (14400)	5500 (12100)											
6.1 m (20')	6250 (13800)	4250 (9400)			*7100 (15700)	5050 (11100)							
4.6 m (15')	5400 (11900)	3600 (7900)			7150 (15700)	4850 (10700)	*8800 (19400)	7150 (15800)					
3.0 m (10')	4950 (10900)	3250 (7200)			6850 (15100)	4600 (10100)	9850 (21700)	6600 (14500)	*13750 (30300)	10200 (22500)			
1.5 m (5')	4800 (10600)	3100 (6800)			6600 (14500)	4350 (9600)	9350 (20600)	6150 (13600)	14750 (32500)	9350 (20600)			
0 m (0')	4900 (10800)	3200 (7000)			6400 (14100)	4200 (9200)	9050 (19900)	5850 (12900)	14350 (31600)	9000 (19800)			
-1.5 m (-5')	5350 (11800)	3450 (7600)			6350 (14000)	4100 (9100)	8900 (19700)	5750 (12700)	14300 (31600)	8950 (19700)	*12350 (27200)	*12350 (27200)	
-3.0 m (-10')	6300 (13900)	4100 (9100)			6400 (14100)	4200 (9200)	8800 (19400)	5650 (12400)	*12900 (28400)	9100 (20100)	*16850 (37200)	*16850 (37200)	
-4.6 m (-15')	*6600 (14600)	5800 (12800)					*7100 (15600)	6100 (13500)	*9650 (21300)	9500 (20900)	*12100 (26700)	*12100 (26700)	

* Load is limited by hydraulic capacity rather than tipping.
Ratings are based on SAE Standard NO. J1097. Rated loads do not exceed 87% of hydraulic lift capacity or 75% of tipping load.

PC300LC-8

Conditions:

Boom: 6470 mm (21'3"), Bucket (SAE): 1.40 m³ (1.83 cu.yd), Shoes: 700 mm (28")

Lifting mode: ON

unit: kg (lb)

B	A	MAX		9.0 m (29')		7.5 m (24')		6.0 m (19')		4.5 m (14')		3.0 m (9')	
		Cf	Cs	Cf	Cs	Cf	Cs	Cf	Cs	Cf	Cs	Cf	Cs
Arm length 3185 mm (10'5")													
7.5 m (24')	*5300 (11700)	5200 (11400)			*6850 (15200)	5650 (12500)							
6.0 m (19')	*5250 (11600)	4150 (9100)			*7250 (16000)	5600 (12400)							
4.5 m (14')	*5400 (11900)	3550 (7900)	6350 (14000)	3800 (8400)	*7800 (17300)	5400 (11900)	*9200 (20300)	7950 (17500)					
3.0 m (9')	5600 (12300)	3250 (7200)	6200 (13700)	3700 (8100)	8450 (18700)	5100 (11300)	*10650 (23500)	7400 (16300)	*15000 (33100)	11750 (25900)			
1.5 m (4')	5450 (12000)	3150 (6900)	6050 (13300)	3550 (7800)	8150 (18000)	4850 (10600)	11800 (26000)	6900 (15200)	*16700 (36900)	10700 (23600)			
0 m (0')	5550 (12200)	3200 (7000)	5900 (13100)	3400 (7500)	7950 (17500)	4600 (10200)	11400 (25100)	6550 (14500)	*17550 (38600)	10200 (22500)			
-1.5 m (-4')	5950 (13100)	3400 (7500)	5850 (12900)	3350 (7400)	7800 (17200)	4500 (9900)	11200 (24700)	6400 (14100)	*17000 (37500)	10100 (22200)	*9600 (21100)	*9600 (21100)	
-3.0 m (-9')	6850 (15100)	3950 (8700)			7800 (17200)	4500 (10000)	11200 (24700)	6400 (14100)	*15550 (34200)	10200 (22500)	*18050 (39700)	*18050 (39700)	
-4.5 m (-14')	*7550 (16600)	5150 (11400)					*9750 (21500)	6550 (14500)	*12850 (28400)	10500 (23100)	*16600 (36600)	*16600 (36600)	
-6.0 m (-19')	*6300 (13900)	*6300 (13900)							*8150 (18000)	*8150 (18000)			
Arm length 4020 mm (13'2")													
7.5 m (24')	*4150 (9200)	*4150 (9200)											
6.0 m (19')	*4050 (9000)	3500 (7800)	*6250 (13800)	4100 (9000)									
4.5 m (14')	*4150 (9100)	3100 (6800)	*6500 (14400)	4000 (8800)	*7100 (15700)	5600 (12400)							
3.0 m (9')	*4300 (9500)	2800 (6200)	6350 (14000)	3800 (8400)	*8000 (17700)	5300 (11600)	*9650 (21300)	7650 (16900)	*12950 (28600)	12300 (27200)			
1.5 m (4')	*4650 (10200)	2700 (6000)	6150 (13500)	3600 (7900)	8300 (18300)	4950 (10900)	*11200 (24700)	7100 (15600)	*15950 (35200)	11050 (24400)			
0 m (0')	4800 (10600)	2700 (6000)	5950 (13100)	3450 (7600)	8000 (17600)	4650 (10300)	11450 (25200)	6600 (14600)	*17250 (38000)	10250 (22600)			
-1.5 m (-4')	5100 (11200)	2900 (6400)	5850 (12900)	3350 (7300)	7750 (17100)	4450 (9900)	11100 (24500)	6300 (13900)	*17250 (38000)	9850 (21800)	*9750 (21500)	*9750 (21500)	
-3.0 m (-9')	5700 (12600)	3250 (7200)	5850 (12800)	3300 (7300)	7700 (17000)	4400 (9700)	11000 (24300)	6250 (13700)	*16400 (36200)	9850 (21700)	*15450 (34100)	*15450 (34100)	
-4.5 m (-14')	6950 (15300)	4000 (8800)			7800 (17200)	4500 (9900)	*10900 (*24000)	6350 (13900)	*14500 (31900)	10050 (22200)	*20000 (44100)	*20000 (44100)	
-6.0 m (-19')	*6550 (14400)	5700 (12600)					*8150 (18000)	6600 (14800)	*11050 (24400)	10300 (22700)	*14600 (32200)	*14600 (32200)	

* Load is limited by hydraulic capacity rather than tipping. Ratings are based on SAE Standard NO. J1097. Rated loads do not exceed 87% of hydraulic lift capacity or 75% of tipping load.

PC300LC-8

Conditions:

Boom: 6470 mm (21'3"), Bucket (SAE): 1.40 m³ (1.83 cu.yd), Shoes: 700 mm (28")

Lifting mode: ON

unit: kg (lb)

B	A	MAX		9.0 m (29')		7.5 m (24')		6.0 m (19')		4.5 m (14')		3.0 m (9')	
		Cf	Cs	Cf	Cs	Cf	Cs	Cf	Cs	Cf	Cs	Cf	Cs
Arm length 2200 mm (7'3")													
7.5 m (24')	*8650 (19100)	7050 (15600)											
6.0 m (19')	*8300 (18300)	5300 (11600)			*8200 (18100)	5350 (11800)	*9100 (20100)	8050 (17700)					
4.5 m (14')	7350 (16200)	4400 (9700)			8550 (18900)	5150 (11400)	*10250 (22600)	7550 (16700)	*13800 (30400)	12100 (26700)			
3.0 m (9')	6700 (14800)	3950 (8700)			8250 (18200)	4900 (10800)	*11550 (25500)	7050 (15500)					
1.5 m (4')	6500 (14300)	3800 (8300)			8000 (17600)	4700 (10300)	11450 (25200)	6600 (14600)					
0 m (0')	6700 (14700)	3850 (8500)			7850 (17300)	4500 (10000)	11150 (24600)	6350 (14000)					
-1.5 m (-4')	7350 (16200)	4250 (9400)			7800 (17200)	4500 (9900)	11100 (24400)	6300 (13900)	*15500 (34200)	10100 (22200)			
-3.0 m (-9')	*8600 (19000)	5200 (11500)					*10550 (23300)	6450 (14200)	*13400 (29600)	10300 (22700)	*14850 (32700)	*14850 (32700)	
-4.5 m (-14')	*7750 (17100)	*7750 (17100)					*6550 (14400)	*6550 (14400)	*9850 (21800)	*9850 (21800)			
Arm length 2550 mm (8'4")													
7.5 m (24')	*7600 (16700)	6000 (13200)											
6.0 m (19')	*7450 (16400)	4650 (10300)			*7850 (17400)	5450 (12000)							
4.5 m (14')	6650 (14600)	3950 (8700)			*8300 (18400)	5250 (11600)	*9900 (21900)	7700 (16900)	*13000 (28600)	12400 (27400)			
3.0 m (9')	6100 (13500)	3600 (7900)	6100 (13500)	3600 (7900)	8350 (18400)	5000 (11000)	*11300 (24900)	7150 (15800)	*15500 (34100)	11200 (24700)			
1.5 m (4')	5950 (13100)	3450 (7600)	6000 (13200)	3500 (7700)	8050 (17800)	4750 (10400)	11550 (25500)	6700 (14800)					
0 m (0')	6100 (13500)	3500 (7800)	5900 (13000)	3400 (7500)	7850 (17300)	4550 (10100)	11250 (24800)	6450 (14200)	*14650 (32300)	10000 (22100)			
-1.5 m (-4')	6650 (14700)	3850 (8500)			7800 (17200)	4500 (9900)	11100 (24500)	6350 (14000)	*16200 (35700)	10050 (22200)			
-3.0 m (-9')	7900 (17400)	4550 (10100)			7850 (17400)	4550 (10100)	*11050 (24300)	6400 (14100)	*14250 (31500)	10250 (22600)	*17150 (37800)	*17150 (37800)	
-4.5 m (-14')	*7400 (16400)	6300 (13900)					*8300 (18300)	6700 (14700)	*11050 (24300)	10450 (23100)	*13100 (28900)	*13100 (28900)	

* Load is limited by hydraulic capacity rather than tipping. Ratings are based on SAE Standard NO. J1097. Rated loads do not exceed 87% of hydraulic lift capacity or 75% of tipping load.

PC300LC-7

Conditions: Boom:

6470 mm (21'3"), Bucket (SAE): 1.40 m³ (1.83 cu.yd), Shoes: 700 mm (28")

unit: kg (lb)

B	A	MAX		9.1 m (30')		7.6 m (25')		6.1 m (20')		4.6 m (15')		3.0 m (10')	
		Cf	Cs	Cf	Cs	Cf	Cs	Cf	Cs	Cf	Cs	Cf	Cs
Arm length 3185 mm (10'5")													
7.6 m (25')	*4600 (10100)	*4600 (10100)			*5950 (13200)	5500 (12100)							
6.1 m (20')	*4500 (9900)	3950 (8800)			*6550 (14400)	5450 (12000)							
4.6 m (15')	*4600 (10200)	3450 (7600)	6150 (13600)	3700 (8200)	*7050 (15500)	5250 (11600)	*8150 (18000)	7750 (17100)					
3.0 m (10')	*4900 (10800)	3100 (6900)	6050 (13300)	3550 (7900)	*7750 (17100)	5000 (11000)	*9500 (20900)	7200 (15800)	*12650 (27900)	11050 (24400)			
1.5 m (5')	5200 (11500)	3000 (6600)	5900 (13000)	3450 (7600)	7950 (17500)	4700 (10400)	*10600 (23400)	6700 (14800)	*14800 (32700)	10250 (22600)			
0 m (0')	5300 (11700)	3050 (6700)	5750 (12700)	3350 (7400)	7700 (17000)	4500 (9900)	10950 (24200)	6350 (14000)	*15600 (34300)	9700 (21400)	*7250 (16000)	*7250 (16000)	
-1.5 m (-5')	5700 (12600)	3300 (7300)	5700 (12600)	3300 (7300)	7600 (16700)	4400 (9700)	10750 (23700)	6150 (13600)	*15250 (33600)	9550 (21000)	*11750 (25900)	*11750 (25900)	
-3.0 m (-10')	6550 (14500)	3800 (8400)			7600 (16700)	4400 (9700)	*10500 (23100)	6150 (13600)	*13950 (30800)	9600 (21200)	*17200 (37900)	*17200 (37900)	
-4.6 m (-15')	*6700 (14700)	5000 (11100)					*8500 (18800)	6300 (13900)	*11350 (25000)	9850 (21800)	*15250 (33700)	*15250 (33700)	
-6.1 m (-20')	*5600 (12300)	*5600 (12300)							*6750 (14900)	*6750 (14900)			
Arm length 4020 mm (13'2")													
7.6 m (25')	*3550 (7900)	*3550 (7900)											
6.1 m (20')	*3500 (7700)	3400 (7500)	*5350 (11800)	4000 (8800)									
4.6 m (15')	*3550 (7800)	2950 (6500)	*5850 (13000)	3850 (8500)	*6400 (14100)	5500 (12100)							
3.0 m (10')	*3700 (8200)	2700 (6000)	6150 (13600)	3700 (8200)	*7200 (15800)	5150 (11300)	*8600 (19000)	7450 (16400)	*11200 (24700)	*11200 (24700)	18050 (39800)	18050 (39800)	
1.5 m (5')	*4000 (8800)	2600 (5800)	5950 (13200)	3500 (7700)	*7900 (17400)	4800 (10500)	*9900 (21800)	6850 (15100)	*13650 (30100)	10600 (23400)	*8050 (17800)	*8050 (17800)	
0 m (0')	*4450 (9800)	2650 (5800)	5800 (12800)	3350 (7400)	7750 (17100)	4550 (10000)	*10800 (23800)	6400 (14100)	*15050 (32200)	9800 (21600)	*8100 (17800)	*8100 (17800)	
-1.5 m (-5')	4900 (10800)	2800 (6100)	5700 (12600)	3250 (7200)	7550 (16600)	4350 (9600)	10700 (23600)	6100 (13400)	*15350 (33800)	9400 (20700)	*10800 (23800)	*10800 (23800)	
-3.0 m (-10')	5500 (12100)	3150 (6900)	5650 (12500)	3250 (7100)	7450 (16500)	4300 (9400)	10600 (23300)	6000 (13200)	*14650 (32300)	9300 (20500)	*14650 (32300)	*14650 (32300)	
-4.6 m (-15')	*6200 (13600)	3900 (8600)			*7200 (15900)	4350 (9600)	*9600 (21200)	6050 (13400)	*12800 (28200)	9500 (20900)	*18300 (40300)	*18300 (40300)	
-6.1 m (-20')	*5800 (12800)	5550 (12200)					*6950 (15300)	6350 (14000)	*9550 (21100)	*9550 (21100)	*13100 (28800)	*13100 (28800)	

* Load is limited by hydraulic capacity rather than tipping. Ratings are based on SAE Standard NO. J1097. Rated loads do not exceed 87% of hydraulic lift capacity or 75% of tipping load.

PC300LC-7

Conditions:

Boom: 6470 mm (21'3"), Bucket (SAE): 1.40 m³ (1.83 cu.yd), Shoes: 700 mm (28")

unit: kg (lb)

B	A	MAX		9.1 m (30')		7.6 m (25')		6.1 m (20')		4.6 m (15')		3.0 m (10')	
		Cf	Cs	Cf	Cs	Cf	Cs	Cf	Cs	Cf	Cs	Cf	Cs
Arm length 2200 mm (7'3")													
7.6 m (25')	*7650 (16900)	6700 (14700)											
6.1 m (20')	*7350 (16200)	5050 (11100)			*7400 (16300)	5200 (11400)	*8200 (18100)	7800 (17200)					
4.6 m (15')	7000 (15500)	4200 (9300)			*7750 (17000)	5050 (11100)	*9100 (20100)	7400 (16300)	*11750 (26000)	11700 (25800)			
3.0 m (10')	6400 (14100)	3750 (8300)			8050 (17700)	4800 (10600)	*10250 (22600)	6850 (15100)	*14200 (31300)	10400 (22900)			
1.5 m (5')	6200 (13700)	3600 (8000)			7750 (17100)	4550 (10100)	10850 (24000)	6250 (13800)	*15350 (33900)	9600 (21200)			
0 m (0')	6400 (14100)	3700 (8100)			7600 (16800)	4400 (9700)	10750 (23700)	6150 (13500)	*15150 (33400)	9350 (20600)			
-1.5 m (-5')	7000 (15500)	4050 (9000)			7550 (16700)	4350 (9600)	10650 (23500)	6050 (13400)	*14100 (31100)	9400 (20700)	*14200 (31300)	*14200 (31300)	
-3.0 m (-10')	*7650 (16900)	4900 (10800)					*9300 (20500)	6050 (13400)	*12200 (26900)	9600 (21200)	*15100 (33300)	*15100 (33300)	
-4.6 m (-15')	*6900 (15200)	*6900 (15200)							*8550 (18800)	*8550 (18800)			
Arm length 2550 mm (8'4")													
7.6 m (25')	*6500 (14400)	5750 (12700)											
6.1 m (20')	*6400 (14100)	4500 (9900)			*7100 (15700)	5300 (11700)							
4.6 m (15')	6400 (11900)	3600 (7900)			*7500 (16600)	5100 (11300)	*8800 (19400)	7500 (16600)					
3.0 m (10')	5900 (13000)	3450 (7600)			8100 (17900)	4850 (10700)	*10000 (22100)	6950 (15300)	*13750 (30300)	10700 (23600)			
1.5 m (5')	5750 (12600)	3300 (7300)			7850 (17300)	4600 (10200)	*10900 (24100)	6500 (14300)	*15250 (33700)	9850 (21700)			
0 m (0')	5850 (12900)	3300 (7300)			7650 (16800)	4450 (9800)	10800 (23900)	6200 (13700)	*15450 (34000)	9500 (20900)			
-1.5 m (-5')	6400 (14100)	3700 (8100)			7550 (16700)	4350 (9600)	10700 (23600)	6100 (13500)	*14600 (32200)	9450 (20800)	*12350 (27200)	*12350 (27200)	
-3.0 m (-10')	*7150 (15800)	4350 (9600)			*7300 (16100)	4450 (9800)	*9700 (21400)	6000 (13200)	*12900 (28400)	9600 (21200)	*16850 (37200)	*16850 (37200)	
-4.6 m (-15')	*6600 (14600)	6100 (13500)					*7100 (15600)	6450 (14200)	*9650 (21300)	*9650 (21300)	*12100 (26700)	*12100 (26700)	

* Load is limited by hydraulic capacity rather than tipping.
Ratings are based on SAE Standard NO. J1097. Rated loads do not exceed 87% of hydraulic lift capacity or 75% of tipping load.

PC300LC-7 (India source)

Conditions:

Boom: 6470 mm (21'3"), Bucket: 1.40 m³ (1.83 cu.yd), Shoes: 600 mm (23.6")

unit: kg (lb)

B	A	MAX		9.1 m (30')		7.6 m (25')		6.1 m (20')		4.6 m (15')		3.0 m (10')	
		Cf	Cs	Cf	Cs	Cf	Cs	Cf	Cs	Cf	Cs	Cf	Cs
Arm length 3185 mm (10'5")													
7.6 m (25')	*4550 (10000)	*4550 (10000)			*6000 (13300)	5550 (12200)							
6.1 m (20')	*4450 (9800)	3900 (8700)			*6650 (14700)	5500 (12100)							
4.6 m (15')	*4600 (10100)	3350 (7400)	6200 (13700)	3650 (8000)	*7200 (15900)	5300 (11700)	*8400 (18500)	7950 (17500)					
3.0 m (10')	*4900 (10800)	3000 (6700)	6050 (13400)	3500 (7700)	*7950 (17500)	5000 (11100)	*9800 (21700)	7400 (16300)	*13150 (28900)	11450 (25200)			
1.5 m (5')	5200 (11500)	2900 (6400)	5900 (11500)	3350 (6400)	8100 (17800)	4750 (10400)	*11000 (24300)	6850 (15100)	*15550 (34200)	10650 (23500)			
0 m (0')	5300 (11700)	2950 (6500)	5800 (12700)	3250 (7200)	7850 (17300)	4500 (9900)	11300 (24900)	6500 (14300)	*16350 (36000)	10100 (22200)	*7450 (16400)	*7450 (16400)	
-1.5 m (-5')	5750 (12600)	3200 (7100)	5750 (12600)	3200 (7100)	7700 (17000)	4000 (9700)	11100 (24400)	6300 (13900)	*16000 (35200)	9900 (21800)	*12200 (26900)	*12200 (26900)	
-3.0 m (-10')	6650 (14600)	3750 (8300)			7700 (17000)	4000 (9700)	*10900 (24000)	6300 (13800)	*14600 (32200)	9950 (22000)	*18000 (39700)	*18000 (39700)	
-4.6 m (-15')	*6800 (15000)	5050 (11200)					*8800 (19400)	6450 (14300)	*11800 (26100)	10250 (22600)	*16050 (35400)	*16050 (35400)	
-6.1 m (-20')	*5650 (12500)	*5650 (12500)							*6950 (15300)	*6950 (15300)			

* Load is limited hydraulic capacity rather than tipping.
 Ratings are based on SAE Standard No. J1097. Rated loads do not exceed 87% of hydraulic lift capacity or 75% of tipping load.

PC350-8 (with lifting mode)

Conditions:

Boom: 6470 mm (21'3"), Bucket (SAE): 1.40 m³ (1.83 cu.yd), Shoes: 600 mm (24")

unit: kg (lb)

B	A	MAX		9.0 m (29')		7.5 m (24')		6.0 m (19')		4.5 m (14')		3.0 m (9')	
		Cf	Cs	Cf	Cs	Cf	Cs	Cf	Cs	Cf	Cs	Cf	Cs
Arm length 3185 mm (10'5")													
7.5 m (24')		*4900 (10800)	*4900 (10800)			*6400 (14200)	5550 (12300)						
6.0 m (19')		*4800 (10600)	3950 (8800)			*6750 (14800)	5500 (12100)						
4.5 m (14')		*4950 (10900)	3350 (7400)	5500 (12100)	3600 (8000)	*7300 (16100)	5250 (11600)	*8700 (19200)	7950 (17500)				
3.0 m (9')		4750 (10500)	3050 (6700)	5350 (11800)	3450 (7700)	7450 (16400)	4950 (11000)	*10100 (22300)	7400 (16300)	*14400 (31700)	11950 (26300)		
1.5 m (4')		4600 (12000)	2900 (6400)	5150 (11400)	3300 (7300)	7150 (15700)	4700 (10300)	10400 (23000)	6850 (15100)	*16100 (35500)	10850 (23900)		
0 m (0')		4700 (10400)	2950 (6500)	5050 (11100)	3200 (7000)	6900 (15200)	4450 (9900)	10000 (22100)	6500 (14300)	16400 (36100)	10300 (22700)		
-1.5 m (-4')		5100 (11200)	3200 (7100)	5000 (11000)	3150 (6900)	6750 (14900)	4350 (9600)	9800 (21600)	6300 (13900)	16200 (35700)	10150 (22400)	*9050 (19900)	*9050 (19900)
-3.0 m (-9')		5900 (13000)	3800 (8300)			6750 (14900)	4350 (9600)	9800 (21600)	6300 (13900)	*14900 (32800)	10250 (22600)	*17300 (38200)	*17300 (38200)
-4.5 m (-14')		*6950 (15300)	5050 (11100)					*9200 (20200)	6500 (14300)	*12250 (27000)	10550 (23300)	*15900 (35100)	*15900 (35100)
-6.0 m (-19')		*5700 (12600)	*5700 (12600)							*7550 (16600)	*7550 (16600)		

PC350LC-8 (with lifting mode)

Conditions: Boom:

6470 mm (21'3"), Bucket (SAE): 1.40 m³ (1.83 cu.yd), Shoes: 600 mm (24")

unit: kg (lb)

B	A	MAX		9.0 m (29')		7.5 m (24')		6.0 m (19')		4.5 m (14')		3.0 m (9')	
		Cf	Cs	Cf	Cs	Cf	Cs	Cf	Cs	Cf	Cs	Cf	Cs
Arm length 3185 mm (10'5")													
7.5 m (24')		*4900 (10800)	*4900 (10800)			*6400 (14200)	5750 (12600)						
6.0 m (19')		*4800 (10600)	4100 (9000)			*6750 (14800)	5650 (12500)						
4.5 m (14')		*4950 (10900)	3500 (7700)	6350 (14100)	3750 (8300)	*7300 (16100)	5450 (12000)	*8700 (19200)	8150 (18000)				
3.0 m (9')		*5300 (11700)	3150 (7000)	6200 (13700)	3600 (7900)	*8100 (17900)	5100 (11300)	*10100 (22300)	7600 (16800)	*14400 (31700)	12250 (27000)		
1.5 m (4')		5400 (11900)	3050 (6700)	6050 (13300)	3450 (7600)	8300 (18300)	4850 (10700)	*11400 (25100)	7100 (15600)	*16100 (35500)	11150 (24600)		
0 m (0')		5500 (12200)	3100 (6800)	5900 (13000)	3300 (7300)	8050 (17800)	4650 (10200)	11700 (25900)	6700 (14800)	*16900 (37200)	10600 (23400)		
-1.5 m (-4')		5950 (13200)	3350 (7400)	5850 (12900)	3250 (7200)	7950 (17500)	4500 (9900)	11500 (25400)	6500 (14400)	*16400 (36100)	10450 (23100)	*9050 (19900)	*9050 (19900)
-3.0 m (-9')		6950 (15300)	3900 (8600)			7950 (17500)	4500 (9900)	*11150 (24500)	6500 (14400)	*14900 (32800)	10600 (23300)	*17300 (38200)	*17300 (38200)
-4.6 m (-14')		*6950 (15300)	5200 (11500)					*9200 (20200)	6700 (14800)	*12250 (27000)	10850 (24000)	*15900 (35100)	*15900 (35100)
-6.0 m (-19')		*5700 (12600)	*5700 (12600)							*7550 (16600)	*7550 (16600)		

* Load is limited by hydraulic capacity rather than tipping. Ratings are based on SAE Standard NO. J1097. Rated loads do not exceed 87% of hydraulic lift capacity or 75% of tipping load.

PC350LC-8 (Brazil source)

Conditions:

Boom: 6500 mm, Bucket: 1.4m³ , Shoes: 700 mm

unit :kg

B	A	MAX		9.1 m		7.6 m		6.1 m		4.6 m		3.0 m	
		Cf	Cs	Cf	Cs	Cf	Cs	Cf	Cs	Cf	Cs	Cf	Cs
Arm length 2550 mm													
7.6 m		*7600	7600										
6.1 m		*7450	5950			*7850	6600						
4.6 m		*7650	5100			*8250	6450	*9750	9250	*12650	*12650		
3.0 m		7450	4700	7250	4550	*8900	6150	*11050	8750	*15100	13500		
1.5 m		7250	4550	7150	4450	*9400	5950	*12100	8300	*15100	12650		
0 m		7450	4600	7050	4350	9300	5750	*12400	8000	*16000	12300		
-1.5 m		*8100	5050			9250	5700	*12050	7900	*15950	12350		
-3.0 m		*8000	5950			*7800	5800	*10800	8000	*14050	12550	*17050	*17050
-4.6 m		*7350	*7350					*7900	*7900	*10750	*10750	*12800	*12800

Conditions:

Boom: 6500 mm, Bucket: 1.4m³ , Shoes: 800 mm

unit :kg

B	A	MAX		9.1 m		7.6 m		6.1 m		4.6 m		3.0 m	
		Cf	Cs	Cf	Cs	Cf	Cs	Cf	Cs	Cf	Cs	Cf	Cs
Arm length 2550 mm													
7.6 m		*7600	7600										
6.1 m		*7450	6000			*7850	6650						
4.6 m		*7650	5150			*8250	6450	*9750	9300	*12650	*12650		
3.0 m		7500	4700	7300	4600	*8900	6200	*11050	8800	*15100	13600		
1.5 m		7300	4550	7200	4450	*9400	5950	*12100	8350	*15100	12700		
0 m		7500	4650	7100	4400	9350	5800	*12400	8050	*16000	12400		
-1.5 m		*8100	5050			9250	5750	*12050	7950	*15950	12450		
-3.0 m		*8000	6000			*7800	5800	*10800	8050	*14050	12600	*17050	*17050
-4.6 m		*7350	*7350					*7900	*7900	*10750	*10750	*12800	*12800

* Load is limited hydraulic capacity rather than tipping.
Ratings are based on SAE Standard No. J1097. Rated loads do not exceed 87% of hydraulic lift capacity or 75% of tipping load.

PC350-7

Conditions:

Boom: 6470 mm (21'3"), Bucket (SAE): 1.40 m³ (1.83 cu.yd), Shoes: 600 mm (24")

unit: kg (lb)

B	A	MAX		9.1 m (30')		7.6 m (25')		6.1 m (20')		4.6 m (15')		3.0 m (10')	
		Cf	Cs	Cf	Cs	Cf	Cs	Cf	Cs	Cf	Cs	Cf	Cs
Arm length 3185 mm (10'5")													
	7.6 m (25')	*4550 (10000)	*4550 (10000)			*6000 (13300)	5400 (11900)						
	6.1 m (20')	*4450 (9800)	3800 (8400)			*6650 (14700)	5350 (11800)						
	4.6 m (15')	*4600 (10100)	3250 (7100)	5350 (11800)	3500 (7700)	*7200 (15900)	5150 (11400)	*8400 (18500)	7750 (17100)				
	3.0 m (10')	4550 (10000)	2900 (6400)	5200 (11500)	3400 (7500)	7250 (16000)	4850 (10700)	*9800 (21700)	7200 (15800)	*13150 (28900)	11150 (24600)		
	1.5 m (5')	4400 (9800)	2800 (6200)	5050 (11100)	3250 (7200)	6950 (15300)	4600 (10100)	10050 (22200)	5550 (12400)	*15550 (34200)	10350 (22900)		
	0 m (0')	4500 (10000)	2850 (6300)	4950 (10900)	3150 (6900)	6700 (14800)	4350 (9600)	9650 (21300)	6250 (13800)	15500 (34200)	9800 (21600)	*7450 (16400)	*7450 (16400)
	-1.5 m (-5')	4900 (10800)	3100 (6800)	4900 (10800)	3100 (6800)	6600 (14500)	4250 (9300)	9450 (20800)	6100 (13400)	15300 (33700)	9600 (21200)	*12200 (26900)	*12200 (26900)
	-3.0 m (-10')	5650 (12500)	3600 (8000)			6600 (14500)	4250 (9300)	9400 (20800)	6050 (13400)	*14600 (32200)	9650 (21300)	*18000 (39700)	*18000 (39700)
	-4.6 m (-15')	*6800 (15000)	4900 (10800)					*8800 (19400)	6250 (13800)	*11800 (26100)	9950 (22000)	*16050 (35400)	*16050 (35400)
	-6.1 m (-20')	*5650 (12500)	*5650 (12500)							*6950 (15300)	*6950 (15300)		

PC350LC-7

Conditions:

Boom: 6470 mm (21'3"), Bucket (SAE): 1.40 m³ (1.83 cu.yd), Shoes: 600 mm (24")

unit: kg (lb)

B	A	MAX		9.1 m (30')		7.6 m (25')		6.1 m (20')		4.6 m (15')		3.0 m (10')	
		Cf	Cs	Cf	Cs	Cf	Cs	Cf	Cs	Cf	Cs	Cf	Cs
Arm length 3185 mm (10'5")													
	7.6 m (25')	*4550 (10000)	*4550 (10000)			*6000 (13300)	5550 (12200)						
	6.1 m (20')	*4450 (9800)	3900 (8700)			*6650 (14700)	5500 (12100)						
	4.6 m (15')	*4600 (10100)	3350 (7400)	6200 (13700)	3650 (8000)	*7200 (15900)	5300 (11700)	*8400 (18500)	7950 (17500)				
	3.0 m (10')	*4900 (10800)	3000 (6700)	6050 (13400)	3500 (7700)	*7950 (17500)	5000 (11100)	*9800 (21700)	7400 (16300)	*13150 (28900)	11450 (25200)		
	1.5 m (5')	5200 (11500)	2900 (6400)	5900 (13000)	3350 (7400)	8100 (17800)	4750 (10400)	*11000 (24300)	6850 (15100)	*15550 (34200)	10650 (23500)		
	0 m (0')	5300 (11700)	2950 (6500)	5800 (12700)	3250 (7200)	7850 (17300)	4500 (9900)	11300 (24900)	6500 (14300)	*16350 (36000)	10100 (22200)	*7450 (16400)	*7450 (16400)
	-1.5 m (-5')	5750 (12600)	3200 (7100)	5750 (12600)	3200 (7100)	7700 (17000)	4400 (9700)	11100 (24400)	6300 (13900)	*16000 (35200)	9900 (21800)	*12200 (26900)	*12200 (26900)
	-3.0 m (-10')	6650 (14600)	3750 (8300)			7700 (17000)	4400 (9700)	*10900 (24000)	6300 (13800)	*14600 (32200)	9950 (22000)	*18000 (39700)	*18000 (39700)
	-4.6 m (-15')	*6800 (15000)	5050 (11200)					*8800 (19400)	6450 (14300)	*11800 (26100)	10250 (22600)	*16050 (35400)	*16050 (35400)
	-6.1 m (-20')	*5650 (12500)	*5650 (12500)							*6950 (15300)	*6950 (15300)		

* Load is limited by hydraulic capacity rather than tipping. Ratings are based on SAE Standard NO. J1097. Rated loads do not exceed 87% of hydraulic lift capacity or 75% of tipping load.

PC360LC-10 (UK source)

Conditions:

One-piece boom: 7060 mm, Bucketless, Shoes: 700 mm

unit :kg

B	A	MAX		9.0 m		7.5 m		6.0 m		4.5 m		3.0 m	
		Cf	Cs	Cf	Cs	Cf	Cs	Cf	Cs	Cf	Cs	Cf	Cs
Arm length 2200 mm													
	6.0 m	*9870	7590					*10830	10510				
	4.5 m	*9720	6590			*10110	7340	*11850	10090	*15470	15190		
	3.0 m	9160	6100			*10590	7120	*12990	9600				
	1.5 m	8970	5950			10560	6930	*13720	9230				
	0 m	9250	6100			10430	6810	*13710	9050	*17640	13470		
	-1.5 m	*9740	6640			*10070	6820	*12880	9040	*16140	13560		
	-3.0 m	*9380	7910					*10940	9190	*13650	*13650	*15120	*15120
	-4.5 m	*7880	*7880							*9210	*9210		
	-6.0 m												
Arm length 2600 mm													
	6.0 m	*9390	6960			*9500	7590	*10450	*10450				
	4.5 m	9140	6140			*9880	7420	*11530	10220	*14810	*14810		
	3.0 m	8560	5730			*10440	7190	*12760	9730	*17560	14340		
	1.5 m	8400	5600			10610	6980	*13640	9330				
	0 m	8630	5730			10460	6840	*13820	9110	*18210	13520		
	-1.5 m	*9240	6170			*10390	6810	*13200	9060	*16870	13570	*12670	*12670
	-3.0 m	*8940	7180					*11560	9160	*14570	13750	*17260	*17260
	-4.5 m	*7850	*7850							*10630	*10630		
	-6.0 m												
Arm length 3200 mm													
	6.0 m	*6960	6240			*8760	7640						
	4.5 m	*7030	5570	*7650	5640	*9270	7440	*10700	10320				
	3.0 m	*7310	5220	8280	5530	*9950	7180	*12060	9800	*16280	14670		
	1.5 m	7660	5090	8150	5410	*10530	6930	*13170	9330	*18170	13790		
	0 m	7830	5180	8050	5320	10370	6740	*13660	9040	*18460	13420		
	-1.5 m	8390	5520			10280	6660	*13400	8920	*17600	13360	*13300	*13300
	-3.0 m	*8630	6270			*9470	6710	*12240	8950	*15750	13480	*20330	*20330
	-4.5 m	*8140	7920					*9690	9160	*12560	*12560	*15600	*15600
	-6.0 m												
Arm length 4000 mm													
	6.0 m	*5470	5440	*7220	5870	*7960	7850						
	4.5 m	*5490	4930	*7870	5770	*8560	7610						
	3.0 m	*5660	4650	*8250	5610	*9340	7300	*11130	10030	*14560	*14560		
	1.5 m	*5970	4540	8200	5440	*10080	7000	*12480	9470	*17080	14080		
	0 m	*6490	4590	8040	5300	10390	6750	*13330	9060	*18230	13430	*8100	*8100
	-1.5 m	7320	4830	7960	5230	10220	6600	*13500	8830	*18100	13180	*12160	*12160
	-3.0 m	*7960	5330			*10130	6560	*15870	8780	*16900	13190	*17440	*17440
	-4.5 m	*7780	6350			*8470	6690	*11210	8900	*14530	13400	*19380	*19380
	-6.0 m	*6950	*6950					*7520	*7520	*10320	*10320	*13110	*13110

* Load is limited hydraulic capacity rather than tipping.

Ratings are based on SAE Standard No. J1097. Rated loads do not exceed 87% of hydraulic lift capacity or 75% of tipping load.

PC360NLC-10 (UK source)

Conditions:

One-piece boom: 7060 mm, Bucketless, Shoes: 700 mm

unit :kg

B	A	MAX		9.0 m		7.5 m		6.0 m		4.5 m		3.0 m	
		Cf	Cs	Cf	Cs	Cf	Cs	Cf	Cs	Cf	Cs	Cf	Cs
Arm length 2200 mm													
	6.0 m	*9870	6980					*10830	9650				
	4.5 m	*9720	6050			*10110	6740	*11850	9240	*15470	13790		
	3.0 m	9030	5600			*10590	6530	*12990	8770				
	1.5 m	8840	5450			10410	6340	*13720	8410				
	0 m	9120	5580			10280	6220	*13710	8230	*17640	12120		
	-1.5 m	*9740	6070			*10070	6230	*12880	8220	*16140	12210		
	-3.0 m	*9380	7220					*10940	8360	*13650	12430	*15120	*15120
	-4.5 m	*7880	*7880							*9210	*9210		
	-6.0 m												
Arm length 2600 mm													
	6.0 m	*9390	6410			*9500	6980	*10450	9780				
	4.5 m	9010	5640			*9880	6820	*11530	9370	*14810	14090		
	3.0 m	8440	5260			*10440	6600	*12760	8890	*17560	12960		
	1.5 m	8280	5130			10470	6390	*13640	8500				
	0 m	8510	5240			10310	6250	*13820	8290	*18210	12180		
	-1.5 m	9230	5650			10280	6220	*13200	8240	*16870	12220	*12670	*12670
	-3.0 m	*8940	6560					*11560	8330	*14570	12400	*17260	*17260
	-4.5 m	*7850	*7850							*10630	*10630		
	-6.0 m												
Arm length 3200 mm													
	6.0 m	*6960	5740			*8760	7030						
	4.5 m	*7030	5110	*7650	5180	*9270	6840	*10700	9470				
	3.0 m	*7310	4780	8170	5070	*9950	6580	*12060	8950	*16280	13280		
	1.5 m	7550	4660	8030	4950	10430	6330	*13170	8500	*18170	12430		
	0 m	7720	4740	7940	4860	10220	6150	*13660	8210	*18460	12070		
	-1.5 m	8270	5040			10130	6070	*13400	8090	*17600	12010	*13300	*13300
	-3.0 m	*8630	5720			*9470	6120	*12240	8130	*15750	12120	*20330	*20330
	-4.5 m	*8140	7230					*9690	8340	*12560	12420	*15600	*15600
	-6.0 m												
Arm length 4000 mm													
	6.0 m	*5470	5000	*7220	5400	*7960	7240						
	4.5 m	*5490	4530	*7870	5300	*8560	7010						
	3.0 m	*5660	4260	*8250	5150	*9340	6700	*11130	9180	*14560	13810		
	1.5 m	*5970	4160	8080	4980	*10080	6400	*12480	8630	*17080	12710		
	0 m	*6490	4200	7930	4840	10240	6160	*13330	8230	*18230	12080	*8100	*8100
	-1.5 m	7210	4410	7850	4770	10070	6010	*13500	8010	*18100	11830	*12160	*12160
	-3.0 m	*7960	4870			10040	5980	*12870	7960	*16900	11840	*17440	*17440
	-4.5 m	*7780	5800			*8470	6100	*11210	8070	*14530	12040	*19380	*19380
	-6.0 m	*6950	*6950					*7520	*7520	*10320	*10320	*13110	*13110

* Load is limited hydraulic capacity rather than tipping.
 Ratings are based on SAE Standard No. J1097. Rated loads do not exceed 87% of hydraulic lift capacity or 75% of tipping load.

PC390LC-10 (USA source)

Conditions:

Boom: 6500 mm (21'3"), Bucketless

unit: kg (lb)

B	A	MAX		9.1 m (30')		7.6 m (25')		6.1 m (20')		4.6 m (15')		3.0 m (10')	
		Cf	Cs	Cf	Cs	Cf	Cs	Cf	Cs	Cf	Cs	Cf	Cs
Arm length 3185 mm (10'5") Shoes: 800 mm (31.5")													
7.6 m (25')	*7200 (15900)	*7200 (15900)											
6.1 m (20')	*7000 (15500)	*7000 (15500)			*8900 (19650)	8800 (19450)							
4.6 m (15')	*7100 (15650)	6650 (14750)			*9400 (20750)	8650 (19050)	*10800 (23850)	*10800 (23850)					
3.0 m (10')	*7400 (16300)	6300 (13900)	*8800 (19450)	6500 (14400)	*10050 (22200)	8400 (18550)	*12150 (26850)	11400 (25200)	*16350 (36150)	*16350 (36150)			
1.5 m (5')	*7950 (17550)	6200 (13650)	*9000 (19850)	6400 (14150)	*10650 (23450)	8150 (18050)	*13250 (29250)	11000 (24300)	*18250 (40250)	16350 (36150)			
0 m (0')	*8850 (19550)	6300 (13950)	*8900 (19600)	6350 (14000)	*10900 (24000)	8000 (17700)	*13750 (30300)	10750 (23700)	*18500 (40800)	16050 (35350)			
-1.5 m (-5')	*8900 (19700)	6750 (14950)			*10550 (23350)	7950 (17550)	*13400 (29600)	10650 (23450)	*17600 (38850)	15950 (35250)	*14150 (31250)	*14150 (31250)	
-3.0 m (-10')	*8850 (19500)	7750 (17050)			*9250 (20500)	8000 (17650)	*12200 (26900)	10700 (23600)	*15650 (34550)	*15650 (34550)	*20250 (44700)	*20250 (44700)	
-4.6 m (-15')	*8250 (18250)	*8250 (18250)					*9300 (20500)	*9300 (20500)	*12250 (27000)	*12250 (27000)	*15250 (33600)	*15250 (33600)	
Arm length 3185 mm (10'5") Shoes: 900 mm (35.5")													
7.6 m (25')	*7200 (15900)	*7200 (15900)											
6.1 m (20')	*7000 (15500)	*7000 (15500)			*8900 (19650)	8900 (19600)							
4.6 m (15')	*7100 (15650)	6750 (14900)			*9400 (20750)	8700 (19250)	*10800 (23850)	*10800 (23850)					
3.0 m (10')	*7400 (16300)	6350 (14050)	*8800 (19450)	6600 (14550)	*10050 (22200)	8500 (18700)	*12150 (26850)	11550 (25450)	*16350 (36150)	*16350 (36150)			
1.5 m (5')	*7950 (17550)	6250 (13800)	*9000 (19850)	6450 (14300)	*10650 (23450)	8250 (18200)	*13250 (29250)	11100 (24550)	*18250 (40250)	16550 (36500)			
0 m (0')	*8850 (19550)	6400 (14100)	*8900 (19600)	6400 (14150)	*10900 (24000)	8100 (17850)	*13750 (30300)	10850 (23950)	*18500 (40800)	16200 (35750)			
-1.5 m (-5')	*8900 (19700)	6850 (15100)			*10550 (23350)	8000 (17700)	*13400 (29600)	10750 (23700)	*17600 (38850)	16150 (35600)	*14150 (31250)	*14150 (31250)	
-3.0 m (-10')	*8850 (19500)	7800 (17250)			*9250 (20500)	8100 (17850)	*12200 (26900)	10800 (23850)	*15650 (34550)	*15650 (34550)	*20250 (44700)	*20250 (44700)	
-4.6 m (-15')	*8250 (18250)	8250 (18250)					*9300 (20500)	*9300 (20500)	*12250 (27000)	*12250 (27000)	*15250 (33600)	*15250 (33600)	

* Load is limited hydraulic capacity rather than tipping.

Ratings are based on ISO Standard No.10567. Rated loads do not exceed 87% of hydraulic lift capacity or 75% of tipping load.

PC390LC-10 (USA source)

Conditions:

Boom: 6500 mm (21'3"), Bucketless

unit: kg (lb)

B	A	MAX		9.1 m (30')		7.6 m (25')		6.1 m (20')		4.6 m (15')		3.0 m (10')	
		Cf	Cs	Cf	Cs	Cf	Cs	Cf	Cs	Cf	Cs	Cf	Cs
Arm length 4020 mm (13'2") Shoes: 800 mm (31.5")													
7.6 m (25')	*5600 (12350)	*5600 (12350)											
6.1 m (20')	*5450 (12050)	*5450 (12050)	*6700 (14850)	6650 (14700)	*7900 (17500)	*7900 (17500)							
4.6 m (15')	*5500 (12100)	*5500 (12100)	*7800 (17300)	6600 (14550)	*8500 (18750)	*8500 (18750)							
3.0 m (10')	*5650 (12500)	*5500 (12100)	*8200 (18050)	6450 (14200)	*9250 (20450)	8350 (18400)	*11050 (24350)	*11050 (24350)	*14450 (31850)	*14450 (31850)			
1.5 m (5')	*6000 (13200)	5350 (11850)	*8500 (18800)	6250 (13850)	*10000 (22000)	8050 (17750)	*12350 (27250)	10900 (24050)	*16900 (37250)	16350 (36050)			
0 m (0')	*6550 (14400)	5450 (12050)	*8700 (19200)	6150 (13550)	*10450 (23050)	7800 (17250)	*13200 (29150)	10550 (23300)	*17950 (39650)	16350 (36050)	*8550 (18900)	*8550 (18900)	
-1.5 m (-5')	*7400 (16350)	5750 (12750)	*8500 (18700)	6100 (13450)	*10500 (23150)	7650 (16950)	*13300 (29350)	10300 (22800)	*17800 (39250)	15450 (34150)	*12750 (28150)	*12750 (28150)	
-3.0 m (-10')	*7950 (17600)	6400 (14150)			*9850 (21750)	7650 (16900)	*12600 (27800)	10300 (22750)	*16500 (36450)	15500 (34200)	*18300 (40350)	*18300 (40350)	
-4.6 m (-15')	*7750 (17100)	7750 (17100)			*7900 (17400)	7800 (17250)	*10750 (23750)	10400 (22950)	*14000 (30900)	*14000 (30900)	*18650 (41150)	*18650 (41150)	
Arm length 4020 mm (13'2") Shoes: 900 mm (35.5")													
7.6 m (25')	*5600 (12350)	*5600 (12350)											
6.1 m (20')	*5450 (12050)	*5450 (12050)	*6700 (14850)	6700 (14850)	*7900 (17500)	*7900 (17500)							
4.6 m (15')	*5500 (12100)	*5500 (12100)	*7800 (17300)	6650 (14700)	*8500 (18750)	*8500 (18750)							
3.0 m (10')	*5650 (12500)	5550 (12250)	*8200 (18050)	6500 (14350)	*9250 (20450)	8450 (18600)	*11050 (24350)	*11050 (24350)	*14450 (31850)	*14450 (31850)			
1.5 m (5')	*6000 (13200)	5450 (12000)	*8500 (18800)	6350 (14000)	*10000 (22000)	8150 (17950)	*12350 (27250)	11000 (24300)	*16900 (37250)	16500 (36400)			
0 m (0')	*6550 (14400)	5500 (12200)	*8700 (19200)	6200 (13700)	*10450 (23050)	7900 (17450)	*13200 (29150)	10650 (23550)	*17950 (39650)	15850 (35000)	*8550 (18900)	*8550 (18900)	
-1.5 m (-5')	*7400 (16350)	5850 (12900)	*8500 (18700)	6150 (13600)	*10500 (23150)	7750 (17150)	*13300 (29350)	10450 (23000)	*17800 (39250)	15650 (34500)	*12750 (28150)	*12750 (28150)	
-3.0 m (-10')	*7950 (17600)	6500 (14300)			*9850 (21750)	7750 (17100)	*12600 (27800)	10400 (22950)	*16500 (36450)	15650 (34550)	*18300 (40350)	*18300 (40350)	
-4.6 m (-15')	*7750 (17100)	*7750 (17100)			*7900 (17400)	*7900 (17400)	*10750 (23750)	10500 (23200)	*14000 (30900)	*14000 (30900)	*18650 (41150)	*18650 (41150)	

* Load is limited hydraulic capacity rather than tipping.
 Ratings are based on SAE Standard No.10567. Rated loads do not exceed 87% of hydraulic lift capacity or 75% of tipping load.

PC400-8/PC400-8R

Conditions:

Boom: 7060 mm (23'2"), Bucket (SAE): 1.90 m³ (2.49 cu.yd), Shoes: 600 mm (24")

Lifting mode: ON

unit: kg (lb)

B	A	MAX		9.0 m (29')		7.5 m (24')		6.0 m (19')		4.5 m (14')		3.0 m (9')	
		Cf	Cs	Cf	Cs	Cf	Cs	Cf	Cs	Cf	Cs	Cf	Cs
Arm length 3380 mm (11'1")													
7.5 m (24')	*6800 (15000)	6250 (13800)											
6.0 m (19')	*6800 (15000)	5250 (11600)	9050 (20000)	6100 (13400)	*10150 (22400)	8500 (18700)							
4.5 m (14')	*7000 (15400)	4700 (10300)	8850 (19500)	5900 (13000)	*11200 (24700)	8100 (17900)	*13450 (29700)	11750 (25900)					
3.0 m (9')	6750 (14900)	4350 (9600)	8600 (19000)	5650 (12500)	11650 (25600)	7700 (16900)	*15750 (34800)	11000 (24200)	*21600 (47700)	17150 (37800)			
1.5 m (4')	6600 (14600)	4250 (9400)	8350 (18400)	5450 (12000)	11200 (24700)	7300 (16100)	16100 (35500)	10300 (22700)	*16950 (37400)	15850 (34900)			
0.0 m (0')	6750 (14900)	4300 (9500)	8150 (18000)	5250 (11600)	10900 (24100)	7050 (15500)	15600 (34400)	9850 (21800)	*17000 (37500)	15350 (33900)			
-1.5 m (-4')	7200 (15900)	4600 (10200)	8050 (17800)	5150 (11400)	10750 (23700)	6850 (15200)	15350 (33900)	9650 (21300)	*22700 (50100)	15350 (33800)			
-3.0 m (-9')	8150 (18000)	5250 (11600)	8100 (17900)	5200 (11500)	10700 (23600)	6850 (15100)	15400 (33900)	9700 (21400)	*21800 (48000)	15500 (34200)	*18600 (41100)	*18600 (41100)	
-4.5 m (-14')	*9850 (21700)	6500 (14400)			10850 (23900)	7000 (15500)	*14500 (32000)	9900 (21800)	*18550 (40900)	15800 (34900)	*23300 (51300)	*23300 (51300)	
-6.0 m (-19')	*8800 (19500)	*8800 (19500)					*10150 (22400)	*10150 (22400)	*13350 (29400)	*13350 (29400)			
Arm length 4000 mm (13'1") Bucket: 1.6 m ³ (2.09 cu.yd)													
7.5 m (24')	*5850 (12900)	5600 (12400)			*8550 (18800)	6350 (14000)							
6.0 m (19')	*5800 (12800)	4800 (10600)			*8800 (19400)	6250 (13800)							
4.5 m (14')	*6000 (13200)	4300 (9500)	6800 (15000)	4450 (9800)	9000 (19800)	6000 (13300)	*10500 (23100)	8300 (18300)					
3.0 m (9')	6250 (13700)	4000 (8800)	6650 (14700)	4350 (9500)	8700 (19200)	5750 (12700)	*11800 (26000)	7850 (17300)	*14700 (32500)	11250 (24800)	*20750 (45800)	17700 (39100)	
1.5 m (4')	6100 (13500)	3900 (8600)	6500 (14400)	4200 (9200)	8400 (18500)	5500 (12100)	11300 (25000)	7400 (16300)	16250 (35900)	10450 (23100)	*23300 (51300)	16150 (35600)	
0.0 m (0')	6200 (13700)	3950 (8700)	6400 (14100)	4050 (9000)	8200 (18100)	5250 (11600)	10950 (24100)	7050 (15600)	15650 (34500)	9900 (21900)	*20450 (45150)	15350 (33800)	
-1.5 m (-4')	6550 (14500)	4150 (9200)	6300 (13900)	4000 (8800)	8050 (17700)	5150 (11300)	10700 (23600)	6850 (15100)	15300 (33700)	9600 (21200)	*23250 (51300)	15050 (33200)	
-3.0 m (-9')	7300 (16100)	4650 (10200)			8000 (17700)	5100 (11300)	10600 (23400)	6750 (14900)	15200 (33500)	9500 (21000)	*22850 (50400)	15150 (33400)	
-4.5 m (-14')	8750 (19300)	5600 (12300)					10700 (23600)	6850 (15100)	15300 (33700)	9650 (21300)	*20200 (44500)	15400 (34000)	
-6.0 m (-19')	*9150 (20100)	7650 (166900)					*8250 (18100)	7150 (15800)	*12250 (27000)	10000 (22000)	*15850 (35000)	15750 (34700)	

* Load is limited by hydraulic capacity rather than tipping.
 Ratings are based on SAE Standard NO. 10567. Rated loads do not exceed 87% of hydraulic lift capacity or 75% of tipping load.

PC400-8/PC400-8R

Conditions:

Boom: 7060 mm (23'2"), Bucket (SAE): 1.90 m³ (2.49 cu.yd), Shoes: 600 mm (24")

Lifting mode: ON

unit: kg (lb)

B	A	MAX		9.0 m (29')		7.5 m (24')		6.0 m (19')		4.5 m (14')		3.0 m (9')	
		Cf	Cs	Cf	Cs	Cf	Cs	Cf	Cs	Cf	Cs	Cf	Cs
Arm length 2400 mm (7'10")													
7.5 m (24')	*11050 (24400)	7950 (17600)			*11050 (24300)	8450 (18600)							
6.0 m (19')	9650 (21300)	6450 (14300)			*11400 (25100)	8250 (18200)	*13150 (28900)	12050 (26500)					
4.5 m (14')	8550 (18900)	5650 (12500)	8750 (19300)	5800 (12800)	11850 (26200)	7900 (17500)	*15150 (33400)	11350 (25100)					
3.0 m (9')	8000 (17600)	5250 (11600)	8550 (18800)	5600 (12400)	11450 (25300)	7550 (16700)	16450 (36300)	10650 (23500)					
1.5 m (4')	7850 (17300)	5100 (11300)	8350 (18400)	5450 (1200)	11150 (24600)	7250 (16000)	15850 (35000)	10150 (22300)					
0.0 m (0')	8100 (17800)	5250 (11500)	8250 (18100)	5300 (11700)	10900 (24100)	7050 (15600)	15550 (34300)	9850 (21700)					
-1.5 m (-4')	8800 (19400)	5700 (12500)	8250 (18100)	5300 (11700)	10850 (23900)	7000 (15400)	15500 (34200)	9800 (21600)	*18450 (40700)	15600 (34400)			
-3.0 m (-9')	10350 (22800)	6700 (14800)			10950 (24100)	7100 (15600)	*15600 (34300)	9950 (21900)	*19150 (42200)	16000 (35200)	*18450 (40700)	*18450 (40700)	
-4.5 m (-14')	*10500 (23100)	9000 (19900)					*12200 (26900)	10250 (22600)	*15150 (33400)	*15150 (33400)			
Arm length 2900 mm (9'6")													
7.5 m (24')	*10050 (22200)	7200 (15900)			*10100 (22300)	8500 (18700)							
6.0 m (19')	8900 (19600)	5900 (13000)	8850 (19500)	5900 (13000)	*10650 (23400)	8250 (18200)							
4.5 m (14')	7900 (17400)	5150 (11400)	8650 (19100)	5700 (12600)	*11600 (25600)	7900 (17400)	*14150 (31200)	11400 (25100)	*18550 (40900)	18200 (40200)			
3.0 m (9')	7400 (16300)	4750 (10500)	8450 (18600)	5500 (12100)	11400 (25100)	7450 (16500)	*16300 (35900)	10650 (23500)					
1.5 m (4')	7250 (15900)	4650 (10200)	8200 (18100)	5300 (11700)	11000 (24300)	7100 (15700)	15750 (34800)	10000 (22100)					
0.0 m (0')	7400 (16300)	4700 (10400)	8050 (17700)	5150 (11300)	10750 (23700)	6850 (15100)	15350 (33800)	9650 (21300)					
-1.5 m (-4')	8000 (17600)	5100 (11200)	8000 (17600)	5100 (11200)	10600 (23400)	6750 (14900)	15200 (33500)	9500 (21000)	*22650 (49900)	15250 (33600)			
-3.0 m (-9')	9250 (20400)	5900 (13000)			10650 (23500)	6800 (15000)	15300 (33800)	9600 (21200)	*20350 (44800)	15450 (34100)	*22050 (48600)	*22050 (48600)	
-4.5 m (-14')	*10550 (23200)	7700 (17000)			*9350 (20600)	7050 (15500)	*13300 (29300)	9900 (21800)	*16700 (36800)	15650 (34500)	*19650 (43400)	*19650 (43400)	

* Load is limited by hydraulic capacity rather than tipping. Ratings are based on SAE Standard NO. 10567. Rated loads do not exceed 87% of hydraulic lift capacity or 75% of tipping load.

PC400-7

Conditions:

Boom: 7060 mm (23'2"), Bucket (SAE): 1.90 m³ (2.49 cu.yd), Shoes: 600 mm (24")

unit: kg (lb)

B	A	MAX		9.0 m (29')		7.5 m (24')		6.0 m (19')		4.5 m (14')		3.0 m (9')	
		Cf	Cs	Cf	Cs	Cf	Cs	Cf	Cs	Cf	Cs	Cf	Cs
Arm length 3380 mm (11'1")													
7.5 m (24')	*5750 (12600)	*5750 (12600)	*6700 (14700)	6300 (13800)									
6.0 m (19')	*5750 (12600)	5150 (11300)	*8400 (18500)	6250 (13700)	*9150 (20100)	8700 (19100)							
4.5 m (14')	*5950 (13000)	4650 (10100)	*8850 (19500)	6050 (13300)	*10100 (22100)	8350 (18300)	*12050 (26500)	*12050 (26500)					
3.0 m (9')	*6250 (13700)	4350 (9500)	8850 (19400)	5850 (12800)	*11100 (24400)	7900 (17400)	*13900 (30600)	11250 (24700)	*19450 (42800)	17450 (38400)			
1.5 m (4')	6600 (14400)	4250 (9300)	8600 (18800)	5600 (12300)	11500 (25200)	7550 (16500)	*15400 (33900)	10550 (23200)	*20800 (45800)	16100 (35400)			
0.0 m (0')	6750 (14700)	4300 (9400)	8400 (18400)	5450 (11900)	11150 (24500)	7250 (15900)	15850 (34900)	10100 (22100)	*19800 (43600)	15550 (34200)			
-1.5 m (-4')	7150 (15700)	4600 (10100)	8300 (18200)	5350 (11700)	11000 (24100)	7050 (15500)	15650 (34400)	9850 (21700)	*21500 (47300)	15400 (33900)	*12950 (28500)	*12950 (28500)	
-3.0 m (-9')	8050 (17700)	5200 (11400)	8300 (18300)	5400 (11800)	10950 (24100)	7050 (15500)	*15050 (33100)	9850 (21700)	*19700 (43400)	15550 (34100)	*19000 (41800)	*19000 (41800)	
-4.5 m (-14')	*8550 (18700)	6400 (14000)			*9900 (21800)	7200 (15800)	*13000 (28600)	10050 (22100)	*16750 (36800)	15850 (34900)	*21750 (47900)	*21750 (47900)	
-6.0 m (-19')	*7700 (16900)	*7700 (16900)					*9050 (19800)	*9050 (19800)	*11950 (26200)	*11950 (26200)			
Arm length 4000 mm (13'1")													
7.5 m (24')	*4900 (10800)	*4900 (10800)	*7550 (16500)	6450 (14100)									
6.0 m (19')	*4900 (10700)	4650 (10200)	7800 (17100)	6350 (13900)									
4.5 m (14')	*5050 (11000)	4200 (9200)	*8350 (18300)	6150 (13400)	*9350 (20600)	8450 (18600)							
3.0 m (9')	*5300 (11600)	3950 (8600)	8850 (19500)	5900 (12900)	*10500 (23000)	8000 (17600)	*12950 (28500)	11450 (25100)	*17750 (39100)	*17750 (39100)			
1.5 m (4')	*5750 (12600)	3850 (8400)	8600 (18900)	5600 (12300)	*11500 (25300)	7550 (16600)	*14700 (32300)	10650 (23400)	*20800 (45800)	16400 (36100)			
0.0 m (0')	*6150 (13400)	3900 (8500)	8350 (18300)	5400 (11800)	11150 (24500)	7200 (15800)	*15750 (34700)	10050 (22100)	*21900 (48200)	15550 (34200)	*8550 (18800)	*8550 (18800)	
-1.5 m (-4')	6450 (14200)	4100 (9000)	8200 (18000)	5250 (11500)	10900 (23900)	6950 (15300)	*15500 (34100)	9750 (21400)	*21850 (48100)	15250 (33500)	*12500 (27500)	*12500 (27500)	
-3.0 m (-9')	7200 (15700)	4600 (10000)	8150 (17900)	5200 (11400)	10800 (23700)	6900 (15100)	*15400 (33900)	9650 (21200)	*20550 (45300)	15250 (33500)	*17350 (38100)	*17350 (38100)	
-4.5 m (-14')	*8200 (18000)	5500 (12000)			*10700 (23500)	6950 (15300)	*13850 (30400)	9750 (21500)	*18150 (39900)	15450 (34000)	*23400 (51500)	*23400 (51500)	
-6.0 m (-19')	*7850 (17200)	7350 (16100)					*10700 (23500)	9900 (21800)	*14150 (31100)	*14150 (31100)	*18550 (40800)	*18550 (40800)	

* Load is limited by hydraulic capacity rather than tipping. Ratings are based on SAE Standard NO. J1097. Rated loads do not exceed 87% of hydraulic lift capacity or 75% of tipping load.

PC400-7

Conditions:

Boom: 7060 mm (23'2"), Bucket (SAE): 1.90 m³ (2.49 cu.yd), Shoes: 600 mm (24")

unit: kg (lb)

B	A	MAX		9.0 m (29')		7.5 m (24')		6.0 m (19')		4.5 m (14')		3.0 m (9')	
		Cf	Cs	Cf	Cs	Cf	Cs	Cf	Cs	Cf	Cs	Cf	Cs
Arm length 2400 mm (7'10")													
7.5 m (24')	*9700 (21300)	7750 (17000)			*9850 (21600)	8600 (18900)							
6.0 m (19')	*9500 (20800)	6400 (14000)			*10300 (22600)	8450 (18600)							
4.5 m (14')	8500 (18600)	5650 (12300)	8950 (19600)	5950 (13000)	*11100 (24300)	8150 (17900)	*13500 (29700)	11650 (25600)	*18400 (40500)	18150 (40000)			
3.0 m (9')	7950 (17500)	5250 (11500)	8750 (19200)	5800 (12700)	11750 (25800)	7800 (17100)	*14900 (32800)	10650 (23400)					
1.5 m (4')	7850 (17200)	5100 (11200)	8600 (18800)	5600 (12300)	11400 (25100)	7450 (16400)	16150 (35500)	10350 (22700)					
0.0 m (0')	8050 (17700)	5250 (11500)	8450 (18600)	5500 (12100)	11150 (24600)	7250 (15900)	15800 (34800)	10050 (22000)	*15150 (33400)	*15150 (33400)			
-1.5 m (-4')	8750 (19200)	5700 (12500)			11100 (24400)	7200 (15800)	*15600 (34400)	9950 (21900)	*19950 (43900)	15600 (34300)			
-3.0 m (-9')	*9850 (21600)	6650 (14600)			*10850 (23900)	7250 (15900)	*14000 (30700)	10100 (22200)	*17550 (38600)	15900 (34900)	*20600 (45400)	*20600 (45400)	
-4.5 m (-14')	*9300 (20400)	8800 (19300)					*10700 (23500)	10150 (22300)	*13700 (30100)	*13700 (30100)			
Arm length 2900 mm (9'6")													
7.5 m (24')	*8800 (19400)	7000 (15300)			*9100 (19900)	8700 (19100)							
6.0 m (19')	8700 (19100)	5800 (12700)	*8800 (19300)	6050 (13300)	*9600 (21100)	8500 (18700)							
4.5 m (14')	7800 (17100)	5150 (11200)	*8900 (19600)	5900 (13000)	*10450 (23000)	8150 (17900)	*12650 (27800)	11750 (25800)	*16850 (37100)	*16850 (37100)			
3.0 m (9')	7350 (16100)	4800 (10500)	*8700 (19100)	5700 (12500)	*11400 (25100)	7750 (17000)	*14400 (31700)	10950 (24000)					
1.5 m (4')	7200 (15800)	4650 (10200)	*8500 (18600)	5500 (12100)	11300 (24900)	7350 (16200)	*15650 (34400)	10250 (22600)					
0.0 m (0')	7400 (16200)	4750 (10400)	*8300 (18300)	5350 (11700)	11050 (24200)	7100 (15600)	15650 (34400)	9900 (21700)	*20500 (45100)	15250 (33500)			
-1.5 m (-4')	7950 (17400)	5100 (11200)	*8250 (18100)	5300 (11600)	10900 (24000)	7000 (15300)	15500 (34100)	9750 (21400)	*20650 (45500)	15250 (33500)	*14800 (32600)	*14800 (32600)	
-3.0 m (-9')	9100 (20000)	5900 (12900)			10950 (24000)	7000 (15400)	*14400 (31700)	9800 (21500)	*18500 (40700)	15450 (34000)	*22800 (50200)	*22800 (50200)	
-4.5 m (-14')	*9200 (20200)	7500 (16500)					*11900 (26200)	10050 (22100)	*15150 (33000)	*15150 (33300)	*18700 (41100)	*18700 (41100)	
-6.0 m (-19')	*7850 (17200)	*7850 (17200)											

* Load is limited by hydraulic capacity rather than tipping.
 Ratings are based on SAE Standard NO. J1097. Rated loads do not exceed 87% of hydraulic lift capacity or 75% of tipping load.

PC400LC-8/PC400LC-8R

Conditions:

Boom: 7060 mm (23'2"), Bucket (SAE): 1.90 m³ (2.49 cu.yd), Shoes: 600 mm (24")

Lifting mode: ON

unit: kg (lb)

B	A	MAX		9.0 m (29')		7.5 m (24')		6.0 m (19')		4.5 m (14')		3.0 m (9')	
		Cf	Cs	Cf	Cs	Cf	Cs	Cf	Cs	Cf	Cs	Cf	Cs
Arm length 3380 mm (11'1")													
7.5 m (24')	*6800 (15000)	6450 (14200)											
6.0 m (19')	*6800 (15000)	5450 (12000)	*9400 (20700)	6300 (13900)	*10150 (22400)	8750 (19300)							
4.5 m (14')	*7000 (15400)	4850 (10700)	9900 (21800)	6100 (13500)	*11200 (24700)	8350 (18500)	*13450 (29700)	12050 (26600)					
3.0 m (9')	*7400 (16400)	4550 (10000)	9900 (21800)	5850 (12900)	*12400 (27400)	7950 (17500)	*15750 (34800)	11300 (25000)	*21600 (47700)	17650 (38900)			
1.5 m (4')	*7650 (16900)	4400 (9800)	9650 (21200)	5650 (12400)	12950 (28500)	7550 (16700)	*17450 (38500)	10650 (23500)	*16950 (37400)	16350 (36100)			
0.0 m (0')	7800 (17200)	4500 (9900)	9450 (20800)	5450 (12000)	12600 (27800)	7300 (16100)	*18050 (39800)	10200 (22500)	*17000 (37500)	15850 (35000)			
-1.5 m (-4')	8350 (18400)	4800 (10600)	9350 (20600)	5400 (11900)	12450 (27400)	7150 (15700)	*17900 (39400)	10000 (22100)	*22700 (50100)	15850 (34900)			
-3.0 m (-9')	9450 (20800)	5450 (12000)	9350 (20700)	5400 (11900)	12450 (27400)	7100 (15700)	*16800 (37000)	10050 (22100)	*21800 (48000)	16000 (35300)	*18600 (41100)	*18600 (41100)	
-4.5 m (-14')	*9850 (21700)	6750 (14900)			*11050 (24400)	7300 (16000)	*14500 (32000)	10250 (22600)	*18550 (40900)	16350 (36100)	*23300 (51300)	*23300 (51300)	
-6.0 m (-19')	*8800 (19500)	*8800 (19500)					*10150 (22400)	*10150 (22400)	*13350 (29400)	*13350 (29400)			
Arm length 4000 mm (13'1") Bucket: 1.6 m ³ (2.09 cu.yd)													
7.5 m (24')	*5850 (12900)	5800 (12800)			*8550 (18800)	6550 (14400)							
6.0 m (19')	*5800 (12800)	4950 (11000)			*8800 (19400)	6450 (14200)							
4.5 m (14')	*6000 (13200)	4450 (9800)	7800 (17300)	4650 (10200)	*9350 (20600)	6250 (13700)	*10500 (23100)	8550 (18900)					
3.0 m (9')	*6300 (13900)	4150 (9200)	7700 (16900)	4500 (9900)	10000 (22000)	5950 (13100)	*11800 (26000)	8100 (17800)	*14700 (32500)	11550 (25500)	*20750 (45800)	18200 (40200)	
1.5 m (4')	*6850 (15100)	4050 (8900)	7500 (16600)	4350 (9600)	9700 (21400)	5700 (12500)	*12950 (28600)	7650 (16900)	*16750 (36900)	10800 (23800)	*23300 (51300)	16650 (36800)	
0.0 m (0')	7200 (15800)	4100 (9000)	7400 (16300)	4250 (9300)	9450 (20900)	5500 (12100)	12650 (27900)	7300 (16100)	*17800 (39200)	10250 (22600)	*20450 (45150)	15850 (35000)	
-1.5 m (-4')	7600 (16800)	4350 (9600)	7350 (16200)	4200 (9200)	9300 (20500)	5350 (11800)	12400 (27400)	7100 (15600)	17850 (39400)	9950 (21900)	*23250 (51300)	15600 (34400)	
-3.0 m (-9')	8450 (18600)	4850 (10700)			9300 (20500)	5300 (11700)	12300 (27200)	7000 (15500)	*17250 (38100)	9850 (21700)	*22850 (50400)	15650 (34500)	
-4.5 m (-14')	*9550 (21100)	5800 (12800)					*12050 (26600)	7100 (15700)	*15550 (34300)	10000 (22000)	*20200 (44500)	15950 (35100)	
-6.0 m (-19')	*9150 (20100)	7950 (17500)					*8250 (18100)	7400 (16300)	*12250 (27000)	10350 (22800)	*15850 (35000)	*15850 (35000)	

* Load is limited by hydraulic capacity rather than tipping. Ratings are based on SAE Standard NO. J1097. Rated loads do not exceed 87% of hydraulic lift capacity or 75% of tipping load.

PC400LC-8/PC400LC-8R

Conditions:

Boom: 7060 mm (23'2"), Bucket (SAE): 1.90 m³ (2.49 cu.yd), Shoes: 600 mm (24")

Lifting mode: ON

unit: kg (lb)

B	A	MAX		9.0 m (29')		7.5 m (24')		6.0 m (19')		4.5 m (14')		3.0 m (9')	
		Cf	Cs	Cf	Cs	Cf	Cs	Cf	Cs	Cf	Cs	Cf	Cs
Arm length 2400 mm (7'10")													
7.5 m (24')	*11050 (24400)	8200 (18100)			*11050 (24300)	8700 (19200)							
6.0 m (19')	*10800 (23900)	6700 (14800)			*11400 (25100)	8550 (18800)	*13150 (28900)	12400 (27300)					
4.5 m (14')	9800 (21600)	5850 (12900)	10000 (22100)	6000 (13200)	*12300 (27100)	8200 (18000)	*15150 (33400)	11700 (25800)					
3.0 m (9')	9200 (20300)	5450 (12000)	9800 (21600)	5800 (12800)	13200 (29100)	7800 (17200)	*17200 (37900)	11000 (24300)					
1.5 m (4')	9050 (19900)	5300 (11700)	9600 (21200)	5650 (12400)	12850 (28300)	7500 (16600)	*18200 (40100)	10450 (23100)					
0.0 m (0')	9300 (20500)	5450 (12000)	9500 (20900)	5550 (12200)	12650 (27800)	7300 (16100)	18150 (40000)	10200 (22500)					
-1.5 m (-4')	10150 (22400)	5900 (13000)	9500 (20900)	5550 (12200)	12550 (27700)	7250 (16000)	*17400 (38300)	10150 (22400)	*18450 (40700)	16100 (35500)			
-3.0 m (-9')	*11200 (24700)	6950 (15300)			*12100 (26700)	7350 (16200)	*15600 (34300)	10300 (22700)	*19150 (42200)	16500 (36400)	*18450 (40700)	*18450 (40700)	
-4.5 m (-14')	*10500 (23100)	9300 (20600)					*12200 (26900)	10600 (23400)	*15150 (33400)	*15150 (33400)			
Arm length 2900 mm (9'6")													
7.5 m (24')	*10050 (22200)	7400 (16400)			*10100 (22300)	8750 (19300)							
6.0 m (19')	*9900 (21900)	6100 (13500)	*9800 (21600)	6100 (13400)	*10650 (23400)	8550 (18800)							
4.5 m (14')	9100 (20000)	5350 (11800)	9950 (22000)	5900 (13100)	*11600 (25600)	8150 (18000)	*14150 (31200)	11750 (25900)	*18550 (40900)	18550 (40900)			
3.0 m (9')	8500 (18800)	4950 (10900)	9700 (21400)	5700 (12600)	*12700 (28000)	7700 (17000)	*16300 (35900)	11000 (24200)					
1.5 m (4')	8350 (18400)	4800 (10600)	9500 (20900)	5500 (12100)	12750 (28100)	7350 (16300)	*17650 (38900)	10350 (22800)					
0.0 m (0')	8550 (18900)	4900 (10800)	9300 (20500)	5350 (11800)	12450 (27400)	7100 (15700)	*17900 (39500)	10000 (22000)					
-1.5 m (-4')	9250 (20400)	5300 (11700)	9250 (20400)	5300 (11700)	12300 (27100)	7000 (15400)	*17450 (38500)	9850 (21700)	*22650 (49900)	15750 (34700)			
-3.0 m (-9')	10700 (23600)	6150 (13500)			12350 (27200)	7050 (15500)	*16050 (35400)	9950 (22000)	*20350 (44800)	16000 (35200)	*22050 (48600)	*22050 (48600)	
-4.5 m (-14')	*10550 (23200)	7950 (17600)			*9350 (20600)	7300 (16100)	*13300 (29300)	10250 (22600)	*16700 (36800)	16150 (35600)	*19650 (43400)	*19650 (43400)	

* Load is limited by hydraulic capacity rather than tipping. Ratings are based on SAE Standard NO. J1097. Rated loads do not exceed 87% of hydraulic lift capacity or 75% of tipping load.

PC400-7

Conditions:

Boom: 7060 mm (23'2"), Bucket (SAE): 1.90 m³ (2.49 cu.yd), Shoes: 600 mm (24")

unit: kg (lb)

B	A	MAX		9.0 m (29')		7.5 m (24')		6.0 m (19')		4.5 m (14')		3.0 m (9')	
		Cf	Cs	Cf	Cs	Cf	Cs	Cf	Cs	Cf	Cs	Cf	Cs
Arm length 3380 mm (11'1")													
7.5 m (24')		*5750 (12600)	*5750 (12600)	*6700 (14700)	6300 (13800)								
6.0 m (19')		*5750 (12600)	5150 (11300)	*8400 (18500)	6250 (13700)	*9150 (20100)	8700 (19100)						
4.5 m (14')		*5950 (13000)	4650 (10100)	*8850 (19500)	6050 (13300)	*10100 (22100)	8350 (18300)	*12050 (26500)	*12050 (26500)				
3.0 m (9')		*6250 (13700)	4350 (9500)	8850 (19400)	5850 (12800)	*11100 (24400)	7900 (17400)	*13900 (30600)	11250 (24700)	*19450 (42800)	17450 (38400)		
1.5 m (4')		6600 (14400)	4250 (9300)	8600 (18800)	5600 (12300)	11500 (25200)	7550 (16500)	*15400 (33900)	10550 (23200)	*20800 (45800)	16100 (35400)		
0.0 m (0')		6750 (14700)	4300 (9400)	8400 (18400)	5450 (11900)	11150 (24500)	7250 (15900)	15850 (34900)	10100 (22100)	*19800 (43600)	15550 (34200)		
-1.5 m (-4')		7150 (15700)	4600 (10100)	8300 (18200)	5350 (11700)	11000 (24100)	7050 (15500)	15650 (34400)	9850 (21700)	*21500 (47300)	15400 (33900)	*12950 (28500)	*12950 (28500)
-3.0 m (-9')		8050 (17700)	5200 (11400)	8300 (18300)	5400 (11800)	10950 (24100)	7050 (15500)	*15050 (33100)	9850 (21700)	*19700 (43400)	15550 (34100)	*19000 (41800)	*19000 (41800)
-4.5 m (-14')		*8550 (18700)	6400 (14000)			*9900 (21800)	7200 (15800)	*13000 (28600)	10050 (22100)	*16750 (36800)	15850 (34900)	*21750 (47900)	*21750 (47900)
-6.0 m (-19')		*7700 (16900)	*7700 (16900)					*9050 (19800)	*9050 (19800)	*11950 (26200)	*11950 (26200)		
Arm length 4000 mm (13'1")													
7.5 m (24')		*4900 (10800)	*4900 (10800)	*7550 (16500)	6450 (14100)								
6.0 m (19')		*4900 (10700)	4650 (10200)	7800 (17100)	6350 (13900)								
4.5 m (14')		*5050 (11000)	4200 (9200)	*8350 (18300)	6150 (13400)	*9350 (20600)	8450 (18600)						
3.0 m (9')		*5300 (11600)	3950 (8600)	8850 (19500)	5900 (12900)	*10500 (23000)	8000 (17600)	*12950 (28500)	11450 (25100)	*17750 (39100)	*17750 (39100)		
1.5 m (4')		*5750 (12600)	3850 (8400)	8600 (18900)	5600 (12300)	*11500 (25300)	7550 (16600)	*14700 (32300)	10650 (23400)	*20800 (45800)	16400 (36100)		
0.0 m (0')		*6150 (13400)	3900 (8500)	8350 (18300)	5400 (11800)	11150 (24500)	7200 (15800)	*15750 (34700)	10050 (22100)	*21900 (48200)	15550 (34200)	*8550 (18800)	*8550 (18800)
-1.5 m (-4')		6450 (14200)	4100 (9000)	8200 (18000)	5250 (11500)	10900 (23900)	6950 (15300)	*15500 (34100)	9750 (21400)	*21850 (48100)	15250 (33500)	*12500 (27500)	*12500 (27500)
-3.0 m (-9')		7200 (15700)	4600 (10000)	8150 (17900)	5200 (11400)	10800 (23700)	6900 (15100)	*15400 (33900)	9650 (21200)	*20550 (45300)	15250 (33500)	*17350 (38100)	*17350 (38100)
-4.5 m (-14')		*8200 (18000)	5500 (12000)			*10700 (23500)	6950 (15300)	*13850 (30400)	9750 (21500)	*18150 (39900)	15450 (34000)	*23400 (51500)	*23400 (51500)
-6.0 m (-19')		*7850 (17200)	7350 (16100)					*10700 (23500)	9900 (21800)	*14150 (31100)	*14150 (31100)	*18550 (40800)	*18550 (40800)

* Load is limited by hydraulic capacity rather than tipping. Ratings are based on SAE Standard NO. J1097. Rated loads do not exceed 87% of hydraulic lift capacity or 75% of tipping load.

PC400-7

Conditions:

Boom: 7060 mm (23'2"), Bucket (SAE): 1.90 m³ (2.49 cu.yd), Shoes: 600 mm (24")

unit: kg (lb)

B	A	MAX		9.0 m (29')		7.5 m (24')		6.0 m (19')		4.5 m (14')		3.0 m (9')	
		Cf	Cs	Cf	Cs	Cf	Cs	Cf	Cs	Cf	Cs	Cf	Cs
Arm length 2400 mm (7'10")													
7.5 m (24')	*9700 (21300)	7750 (17000)			*9850 (21600)	8600 (18900)							
6.0 m (19')	*9500 (20800)	6400 (14000)			*10300 (22600)	8450 (18600)							
4.5 m (14')	8500 (18600)	5650 (12300)	8950 (19600)	5950 (13000)	*11100 (24300)	8150 (17900)	*13500 (29700)	11650 (25600)	*18400 (40500)	18150 (40000)			
3.0 m (9')	7950 (17500)	5250 (11500)	8750 (19200)	5800 (12700)	11750 (25800)	7800 (17100)	*14900 (32800)	10650 (23400)					
1.5 m (4')	7850 (17200)	5100 (11200)	8600 (18800)	5600 (12300)	11400 (25100)	7450 (16400)	16150 (35500)	10350 (22700)					
0.0 m (0')	8050 (17700)	5250 (11500)	8450 (18600)	5500 (12100)	11150 (24600)	7250 (15900)	15800 (34800)	10050 (22000)	*15150 (33400)	*15150 (33400)			
-1.5 m (-4')	8750 (19200)	5700 (12500)			11100 (24400)	7200 (15800)	*15600 (34400)	9950 (21900)	*19950 (43900)	15600 (34300)			
-3.0 m (-9')	*9850 (21600)	6650 (14600)			*10850 (23900)	7250 (15900)	*14000 (30700)	10100 (22200)	*17550 (38600)	15900 (34900)	*20600 (45400)	*20600 (45400)	
-4.5 m (-14')	*9300 (20400)	8800 (19300)					*10700 (23500)	10150 (22300)	*13700 (30100)	*13700 (30100)			
Arm length 2900 mm (9'6")													
7.5 m (24')	*8800 (19400)	7000 (15300)			*9100 (19900)	8700 (19100)							
6.0 m (19')	8700 (19100)	5800 (12700)	*8800 (19300)	6050 (13300)	*9600 (21100)	8500 (18700)							
4.5 m (14')	7800 (17100)	5150 (11200)	*8900 (19600)	5900 (13000)	*10450 (23000)	8150 (17900)	*12650 (27800)	11750 (25800)	*16850 (37100)	*16850 (37100)			
3.0 m (9')	7350 (16100)	4800 (10500)	*8700 (19100)	5700 (12500)	*11400 (25100)	7750 (17000)	*14400 (31700)	10950 (24000)					
1.5 m (4')	7200 (15800)	4650 (10200)	*8500 (18600)	5500 (12100)	11300 (24900)	7350 (16200)	*15650 (34400)	10250 (22600)					
0.0 m (0')	7400 (16200)	4750 (10400)	*8300 (18300)	5350 (11700)	11050 (24200)	7100 (15600)	15650 (34400)	9900 (21700)	*20500 (45100)	15250 (33500)			
-1.5 m (-4')	7950 (17400)	5100 (11200)	*8250 (18100)	5300 (11600)	10900 (24000)	7000 (15300)	15500 (34100)	9750 (21400)	*20650 (45500)	15250 (33500)	*14800 (32600)	*14800 (32600)	
-3.0 m (-9')	9100 (20000)	5900 (12900)			10950 (24000)	7000 (15400)	*14400 (31700)	9800 (21500)	*18500 (40700)	15450 (34000)	*22800 (50200)	*22800 (50200)	
-4.5 m (-14')	*9200 (20200)	7500 (16500)					*11900 (26200)	10050 (22100)	*15150 (33000)	*15150 (33300)	*18700 (41100)	*18700 (41100)	
-6.0 m (-19')	*7850 (17200)	*7850 (17200)											

* Load is limited by hydraulic capacity rather than tipping.

Ratings are based on SAE Standard NO. J1097. Rated loads do not exceed 87% of hydraulic lift capacity or 75% of tipping load.

PC400LC-7

Conditions:

Boom: 7060 mm (23'2"), Bucket (SAE): 1.90 m³ (2.49 cu.yd), Shoes: 700 mm (28")

unit: kg (lb)

B	A	MAX		9.0 m (29')		7.5 m (24')		6.0 m (19')		4.5 m (14')		3.0 m (9')	
		Cf	Cs	Cf	Cs	Cf	Cs	Cf	Cs	Cf	Cs	Cf	Cs
Arm length 3380 mm (11'1")													
7.5 m (24')		*5750 (12600)	*5750 (12600)	*6700 (14700)	6500 (14200)								
6.0 m (19')		*5750 (12600)	5350 (11700)	*8400 (18500)	6450 (14100)	*9150 (20100)	8950 (19700)						
4.5 m (14')		*5950 (13000)	4800 (10500)	*8850 (19500)	6250 (13700)	*10100 (22100)	8600 (18900)	*12050 (26500)	*12050 (26500)				
3.0 m (9')		*6250 (13700)	4500 (9900)	*9400 (20700)	6050 (13300)	*11100 (24400)	8200 (17900)	*13900 (30600)	11600 (25400)	*19450 (42800)	17950 (39500)		
1.5 m (4')		6800 (14900)	4400 (9600)	9850 (21700)	5850 (12800)	*12000 (26400)	7800 (17100)	*15400 (33900)	10900 (23900)	*20800 (45800)	16600 (36600)		
0.0 m (0')		7650 (16800)	4500 (9800)	9700 (21300)	5650 (12400)	*12500 (27500)	7500 (16400)	*16150 (35500)	10400 (22900)	*19800 (43600)	16050 (35300)		
-1.5 m (-4')		8300 (18200)	4800 (10500)	9600 (21000)	5550 (12200)	*12500 (27400)	7300 (16100)	*16050 (35300)	10200 (22400)	*21500 (47300)	15900 (35000)	*12950 (28500)	*12950 (28500)
-3.0 m (-9')		8700 (19100)	5400 (11900)	*9050 (19900)	5600 (12200)	*11750 (25800)	7300 (16000)	*15050 (33100)	10200 (22400)	*19700 (43400)	16050 (35300)	*19000 (41800)	*19000 (41800)
-4.5 m (-14')		*8550 (18700)	6650 (14500)			*9900 (21800)	7450 (16300)	*13000 (28600)	10400 (22800)	*16750 (36800)	16350 (36000)	*21750 (47900)	*21750 (47900)
-6.0 m (-19')		*7700 (16900)	*7700 (16900)					*9050 (19800)	*9050 (19800)	*11950 (26200)	*11950 (26200)		
Arm length 4000 mm (13'1")													
7.5 m (24')		*4900 (10800)	*4900 (10800)	*7550 (16500)	6650 (14600)								
6.0 m (19')		*4900 (10700)	4850 (10600)	*7800 (17100)	6550 (14400)								
4.5 m (14')		*5050 (11000)	4350 (9600)	*8350 (18300)	6350 (13900)	*9350 (20600)	8700 (19100)						
3.0 m (9')		*5300 (11600)	4100 (9000)	*8950 (19700)	6100 (13300)	*10500 (23000)	8250 (18100)	*12950 (28500)	11750 (25900)	*17750 (39100)	*17750 (39100)		
1.5 m (4')		*5750 (12600)	4000 (8700)	*9550 (2100)	5800 (12800)	*11500 (25300)	7800 (17100)	*14700 (32300)	11000 (24100)	*20800 (45800)	16900 (37200)		
0.0 m (0')		*6400 (14000)	4050 (8900)	9650 (21200)	5600 (12300)	*12200 (26800)	7450 (16300)	*15750 (34700)	10400 (22900)	*21900 (48200)	16050 (35300)	*8550 (18800)	*8550 (18800)
-1.5 m (-4')		*7400 (16300)	4300 (9400)	9500 (20800)	5450 (12000)	*12400 (27300)	7250 (15900)	*16000 (35200)	10100 (22200)	*21850 (48100)	15750 (34600)	*12500 (27500)	*12500 (27500)
-3.0 m (-9')		*8200 (18000)	4750 (10400)	9450 (20700)	5450 (11900)	*12000 (26400)	7150 (15700)	*15400 (33900)	10000 (22000)	*20550 (45300)	15750 (34600)	*17350 (38100)	*17350 (38100)
-4.5 m (-14')		*8200 (18000)	5700 (12500)			*10700 (23500)	7200 (15800)	*13850 (30400)	10100 (22200)	*18150 (39900)	15950 (35100)	*23400 (51500)	*23400 (51500)
-6.0 m (-19')		*7850 (17200)	7600 (16700)					*10700 (23500)	10250 (22500)	*14150 (31100)	*14150 (31100)	*18550 (40800)	*18550 (40800)

* Load is limited by hydraulic capacity rather than tipping. Ratings are based on SAE Standard NO. J1097. Rated loads do not exceed 87% of hydraulic lift capacity or 75% of tipping load.

PC400LC-7

Conditions:

Boom: 7060 mm (23'2"), Bucket (SAE): 1.90 m³ (2.49 cu.yd), Shoes: 700 mm (28")

unit: kg (lb)

B	A	MAX		9.0 m (29')		7.5 m (24')		6.0 m (19')		4.5 m (14')		3.0 m (9')	
		Cf	Cs	Cf	Cs	Cf	Cs	Cf	Cs	Cf	Cs	Cf	Cs
Arm length 2400 mm (9'6")													
7.5 m (24')		*9700 (21300)	8000 (17600)			*9850 (21600)	8900 (19500)						
6.0 m (19')		*9500 (20800)	6600 (14500)			*10300 (22600)	8750 (19200)						
4.5 m (14')		*9450 (20800)	5850 (12800)	*9650 (21200)	6150 (13500)	*11100 (24300)	8400 (18500)	*13500 (29700)	12000 (26300)	*18400 (40500)	*18400 (40500)		
3.0 m (9')		9150 (20100)	5450 (11900)	*10050 (22000)	6000 (13100)	*11950 (26200)	8050 (17600)	*14900 (32800)	10950 (24100)				
1.5 m (4')		9000 (19800)	5300 (11600)	9850 (21700)	5850 (12800)	*12550 (27600)	7700 (16900)	*16150 (35600)	10650 (23400)				
0.0 m (0')		9250 (20400)	5450 (11900)	9750 (21400)	5700 (12500)	*12750 (28000)	7500 (16500)	*16300 (35900)	10400 (22800)	*15150 (33400)	*15150 (33400)		
-1.5 m (-4')		*9900 (21800)	5900 (12900)			*12250 (27000)	7450 (16300)	*15600 (34400)	10300 (22700)	*19950 (43900)	16100 (35400)		
-3.0 m (-9')		*9850 (21600)	6900 (15100)			*10850 (23900)	7500 (16500)	*14000 (30700)	10450 (22900)	*17550 (38600)	16400 (36000)	*20600 (45400)	*20600 (45400)
-4.5 m (-14')		*9300 (20400)	9100 (19900)					*10700 (23500)	10500 (23100)	*13700 (30100)	*13700 (30100)		
Arm length 2900 mm (9'6")													
7.5 m (24')		*8800 (19400)	7200 (15800)			*9100 (19900)	8950 (19700)						
6.0 m (19')		*8700 (19100)	6000 (13100)	*8800 (19300)	6250 (13700)	*9600 (21100)	8750 (19200)						
4.5 m (14')		*8700 (19100)	5300 (11700)	*9150 (20100)	6150 (13400)	*10450 (23000)	8400 (18500)	*12650 (27800)	12100 (26600)	*16850 (37100)	*16850 (37100)		
3.0 m (9')		8450 (18500)	4950 (10900)	*9600 (21100)	5900 (13000)	*11400 (25100)	8000 (17600)	*14400 (31700)	11300 (24800)				
1.5 m (4')		8300 (18200)	4850 (10600)	9750 (21400)	5700 (12500)	*12150 (26700)	7600 (16700)	*15650 (34400)	10600 (23300)				
0.0 m (0')		8500 (18700)	4950 (10800)	9600 (21100)	5550 (12200)	*12500 (27500)	7350 (16100)	*16100 (35400)	10200 (22500)	*20500 (45100)	15750 (34600)		
-1.5 m (-4')		9200 (20100)	5300 (11600)	9550 (20900)	5500 (12100)	*12250 (27000)	7250 (15900)	*15700 (34600)	10100 (22100)	*20650 (45500)	15750 (34600)	*14800 (32600)	*14800 (32600)
-3.0 m (-9')		*9400 (20700)	6100 (13400)			*11250 (24700)	7300 (16000)	*14400 (31700)	10150 (22300)	*18500 (40700)	15950 (35100)	*22800 (50200)	*22800 (50200)
-4.5 m (-14')		*9200 (20200)	7800 (17100)					*11900 (26200)	10400 (22900)	*15150 (33300)	*15150 (33300)	*18700 (41100)	*18700 (41100)
-6.0 m (-19')		*7850 (17200)	*7850 (17200)										

* Load is limited by hydraulic capacity rather than tipping.

Ratings are based on SAE Standard NO. J1097. Rated loads do not exceed 87% of hydraulic lift capacity or 75% of tipping load.

PC450-8, PC450-8R

Conditions:

Boom: 7060 mm (23'2"), Bucket (SAE): 1.90 m³ (2.49 cu.yd), Shoes: 600 mm (24")

unit: kg (lb)

B	A	MAX		9.0 m (29')		7.5 m (24')		6.0 m (19')		4.5 m (14')		3.0 m (9')	
		Cf	Cs	Cf	Cs	Cf	Cs	Cf	Cs	Cf	Cs	Cf	Cs
Arm length 3380 mm (11'1")													
7.5 m (24')		*6000 (13200)	5850 (12900)										
6.0 m (19')		*6000 (13200)	4850 (10700)	8750 (19300)	5700 (12600)	*9600 (21200)	8200 (18100)						
4.5 m (14')		*6200 (13600)	4250 (9400)	8550 (18900)	5500 (12200)	*10600 (23300)	7800 (17200)	*12800 (28200)	11500 (25400)				
3.0 m (9')		6350 (14000)	3950 (8700)	8300 (18300)	5300 (11600)	11400 (25100)	7350 (16200)	*14950 (33000)	10650 (23500)	*20900 (46100)	16850 (37200)		
1.5 m (4')		6200 (13700)	3800 (8400)	8000 (17700)	5050 (11100)	10900 (24000)	6900 (15300)	15850 (34900)	9950 (21900)	*17650 (38900)	15450 (34100)		
0.0 m (0')		6350 (14000)	3850 (8500)	7800 (17200)	4850 (10700)	10550 (23300)	6600 (14600)	15300 (33700)	9450 (20800)	*17800 (39200)	14950 (32900)		
-1.5 m (-4')		6800 (15000)	4150 (9200)	7700 (17000)	4750 (10500)	10400 (22900)	6450 (14200)	15050 (33200)	9250 (20400)	*22950 (50600)	14950 (32900)		
-3.0 m (-9')		7750 (17100)	4800 (10600)	7750 (17100)	4750 (10500)	10400 (22900)	6450 (14200)	15100 (33300)	9300 (20500)	*20950 (46200)	15100 (33300)	*21700 (47800)	*21700 (47800)
-4.5 m (-14')		*9100 (20100)	6050 (13400)			*10350 (22800)	6600 (14600)	*13750 (30400)	9500 (20900)	*17700 (39100)	15450 (34100)	*22350 (49300)	*22350 (49300)
-6.0 m (-19')		*8050 (17700)	*8050 (17700)					*9450 (20800)	*9450 (20800)	*12600 (27700)	*12600 (27700)		

PC450LC-8, PC450LC-8R

Conditions:

Boom: 7060 mm (23'2"), Bucket (SAE): 1.90 m³ (2.49 cu.yd), Shoes: 600 mm (24")

unit: kg (lb)

B	A	MAX		9.0 m (29')		7.5 m (24')		6.0 m (19')		4.5 m (14')		3.0 m (9')	
		Cf	Cs	Cf	Cs	Cf	Cs	Cf	Cs	Cf	Cs	Cf	Cs
Arm length 3380 mm (11'1")													
7.5 m (24')		*6000 (13200)	5950 (13200)										
6.0 m (19')		*6000 (13200)	4950 (10900)	*8850 (19500)	5800 (12800)	*9600 (21200)	8350 (18400)						
4.5 m (14')		*6200 (13600)	4350 (9600)	*9250 (20400)	5650 (12400)	*10600 (23300)	7950 (17500)	*12800 (28200)	11700 (25800)				
3.0 m (9')		*6550 (14500)	4000 (8900)	9400 (20800)	5400 (11900)	*11750 (25900)	7500 (16500)	*14950 (33000)	10850 (23900)	*20900 (46100)	17150 (37800)		
1.5 m (4')		7150 (15700)	3900 (8600)	9150 (20200)	5150 (11300)	12450 (27400)	7050 (15500)	*16650 (36700)	10100 (22300)	*17650 (38900)	15750 (34700)		
0.0 m (0')		7300 (16100)	3950 (8700)	8950 (19700)	4950 (10900)	12100 (26700)	6750 (14900)	*17300 (38200)	9650 (21200)	*17800 (39200)	15200 (33500)		
-1.5 m (-4')		7800 (17200)	4250 (9400)	8850 (19500)	4850 (10700)	11900 (26300)	6600 (14500)	*17100 (37700)	9450 (20800)	*22950 (50600)	15200 (33500)		
-3.0 m (-9')		8900 (19600)	4900 (10800)	8850 (19600)	4900 (10800)	11900 (26300)	6550 (14500)	*16000 (35300)	9450 (20900)	*20950 (46200)	15400 (33900)	*21700 (47800)	*21700 (47800)
-4.5 m (-14')		*9100 (20100)	6200 (13600)			*10350 (22800)	6750 (14900)	*13750 (30400)	9650 (21300)	*17700 (39100)	15750 (34700)	*22350 (49300)	*22350 (49300)
-6.0 m (-19')		*8050 (17700)	*8050 (17700)					*9450 (20800)	*9450 (20800)	*12600 (27700)	*12600 (27700)		

* Load is limited by hydraulic capacity rather than tipping.

Ratings are based on SAE Standard NO. J1097. Rated loads do not exceed 87% of hydraulic lift capacity or 75% of tipping load.

PC450-7

Conditions:

Boom: 7060 mm (23'2"), Bucket (SAE): 1.90 m³ (2.49 cu.yd), Shoes: 600 mm (24")

unit: kg (lb)

B	A	MAX		9.0 m (29')		7.5 m (24')		6.0 m (19')		4.5 m (14')		3.0 m (9')	
		Cf	Cs	Cf	Cs	Cf	Cs	Cf	Cs	Cf	Cs	Cf	Cs
Arm length 3380 mm (11'1")													
7.5 m (24')	*5550 (12100)	*5550 (12100)	*6600 (14500)	5900 (12900)									
6.0 m (19')	*5550 (12100)	4750 (10400)	*8800 (19300)	5850 (12900)	*9600 (21100)	8400 (18500)							
4.5 m (14')	*5750 (12600)	4200 (9200)	8750 (19300)	5700 (12500)	*10650 (23400)	8050 (17600)	*12800 (28100)	11850 (26000)					
3.0 m (9')	*6100 (13400)	3900 (8500)	8500 (18700)	5450 (12000)	11700 (25700)	7600 (16600)	*14800 (32600)	10950 (24100)	*20800 (45800)	17200 (37800)			
1.5 m (4')	6200 (13600)	3800 (8300)	8250 (18100)	5250 (11400)	11200 (24600)	7150 (15700)	16150 (35500)	10200 (22400)	*23400 (51500)	15700 (34600)			
0.0 m (0')	6350 (13900)	3900 (8500)	8050 (17700)	5050 (11000)	10850 (23800)	6850 (15000)	15600 (34300)	9650 (21200)	*23050 (50700)	15050 (33100)			
-1.5 m (-4')	6800 (14900)	4200 (9100)	7950 (17400)	4950 (10800)	10650 (23400)	6650 (14600)	15300 (33700)	9450 (20700)	*23000 (50700)	14900 (32800)	*15050 (33100)	*15050 (33100)	
-3.0 m (-9')	7700 (16900)	4800 (10500)	7950 (17500)	4950 (10900)	10650 (23400)	6650 (14500)	15300 (33700)	9450 (20700)	*21050 (46400)	15050 (33100)	*22200 (48800)	*22200 (48800)	
-4.5 m (-14')	*8900 (19600)	6000 (13100)			*10450 (23000)	6800 (14900)	*13800 (30400)	9650 (21200)	*17850 (39300)	15450 (34000)	*23300 (51200)	*23300 (51200)	
-6.0 m (-19')	*8000 (17600)	*8000 (17600)					*9350 (20500)	*9350 (20500)	*12650 (27900)	*12650 (27900)			

* Load is limited by hydraulic capacity rather than tipping. Ratings are based on SAE Standard NO. J1097. Rated loads do not exceed 87% of hydraulic lift capacity or 75% of tipping load.

PC490-10 (UK source)

Conditions:

One-piece boom: 7100 mm, Bucket (SAE): 2.2 m³, Shoes: 700 mm

unit: kg

B	A	MAX		9.0 m		7.5 m		6.0 m		4.5 m		3.0 m	
		Cf	Cs	Cf	Cs	Cf	Cs	Cf	Cs	Cf	Cs	Cf	Cs
Arm length 2400 mm													
7.5 m		*13220	11430			*13240	11620						
6.0 m		12840	9640			*13540	11490	*15500	*15500				
4.5 m		11610	8710			*14340	11190	*17320	15260				
3.0 m		11020	8250	11370	8510	14710	10870	*19000	14610				
1.5 m		10910	8150	11230	8380	14420	10600	*19820	14180				
0 m		11260	8380			14260	10450	*19590	14000				
-1.5 m		12230	9060			14240	10430	*18410	14000	*22350	21400		
-3.0 m		*12360	10510			*12480	10580	*16080	14150	*19360	*19360	*20430	*20430
-4.5 m		*10960	*10960					*11520	*11520	*14410	*14410		
-6.0 m													
Arm length 2900 mm													
7.5 m		*12150	10480			*12310	11660						
6.0 m		11930	8950			*12790	11470	*14530	*14530				
4.5 m		10840	8120	11450	8570	*13680	11130	*16380	15280				
3.0 m		10310	7690	11260	8390	14610	10760	*18200	14550				
1.5 m		10190	7580	11080	8220	14270	10440	*19330	14020				
0 m		10470	7760	10960	8110	14050	10240	19390	13750				
-1.5 m		11270	8320			13980	10180	*18630	13690	*23440	20890		
-3.0 m		*12120	9500			*13280	10270	*16740	13800	*20660	*20660	*24100	*24100
-4.5 m		*11370	*11370					*13180	*13180	*16280	*16280		
-6.0 m													
Arm length 3400 mm													
7.5 m		*9160	*9160			*11710	*11710						
6.0 m		*9060	8180	*11420	8860	*12310	11650						
4.5 m		*9210	7510	11590	8700	*13280	11310	*15730	15560	*20530	*20530		
3.0 m		9560	7170	11370	8500	*14340	10920	*17720	14810	*24590	22190		
1.5 m		9460	7070	11170	8310	14410	10570	*19130	14220	*17760	*17760		
0 m		9690	7220	11020	8170	14150	10330	19530	13880	*20720	*20720		
-1.5 m		10310	7660	10970	8120	14030	10230	*19100	13750	*24620	20930	*15450	*15450
-3.0 m		*11410	8570			*14020	10260	*17580	13810	*22140	21100	*24050	*24050
-4.5 m		*10880	10410			*11020	10490	*14650	14040	*18250	*18250	*22170	*22170
-6.0 m													
Arm length 4000 mm													
7.5 m		*7890	*7890	*9970	9030								
6.0 m		*7830	7520	*10720	8940	*11480	*11480						
4.5 m		*7960	6950	*11240	8740	*12520	11400	*14620	*14620				
3.0 m		*8270	6640	11390	8500	*13690	10970	*16750	14970	*22810	22670		
1.5 m		8770	6540	11140	8270	14410	10570	*18460	14270	*23800	21380		
0 m		8930	6650	10950	8090	14090	10270	*19320	13820	*22690	20810		
-1.5 m		9430	7000	10840	7990	13910	10100	*19230	13600	*25360	20650	*15150	*15150
-3.0 m		10420	7700	10860	8010	13880	10070	*18170	13580	*23390	20750	*21760	*21760
-4.5 m		*10710	9070			*12490	10210	*15910	13740	*20120	*20120	*25940	*25940
-6.0 m		*9770	*9770					*11580	*11580	*14840	*14840		
Arm length 4800 mm													
7.5 m		*6380	*6380	*9480	9200								
6.0 m		*6310	*6310	*9820	9060								
4.5 m		*6380	6200	*10440	8830	*11480	*11480						
3.0 m		*6580	5950	*11170	8550	*12760	11090	*15370	15260	*20330	*20330		
1.5 m		*6930	5860	11150	8270	*13960	10620	*17410	14430	*23980	21790		
0 m		*7460	5930	10900	8030	14070	10240	*18740	13830	*24610	20850	*10120	*10120
-1.5 m		*8280	6180	10730	7880	13810	10000	19130	13490	*25780	20450	*13950	*13950
-3.0 m		9050	6690	10670	7820	13690	9890	*18660	13360	*24560	20390	*18840	*18840
-4.5 m		*9990	7630	*10610	7900	*13580	9930	*17100	13430	*22080	20570	*25120	*25120
-6.0 m		*9580	9480			*10700	10180	*14070	13690	*17970	*17970	*23550	*23550

* Load is limited hydraulic capacity rather than tipping.

Ratings are based on SAE Standard No. J1097. Rated loads do not exceed 87% of hydraulic lift capacity or 75% of tipping load.

PC490-10 (UK source)

Conditions:

Short boom: 6700 mm, Bucket (SAE): 2.2 m³, Shoes: 700 mm

unit :kg (lb)

B	A	MAX		7.0 m		6.0 m		4.5 m		3.0 m	
		Cf	Cs	Cf	Cs	Cf	Cs	Cf	Cs	Cf	Cs
Arm length 2400 mm											
6.0 m		*12850	10100	*13600	11700	*15200	*15200				
4.5 m		12050	9050	*14350	11450	*17000	15700	*22000	*22000		
3.0 m		11400	8600	14950	11100	*18900	15050				
1.5 m		11300	8450	14650	10800	*20000	14550				
0 m		11650	8700	14450	10650	*19950	14250				
-1.5 m		12700	9400	14400	10600	*19000	14200	*23650	21750		
-3.0 m		*12850	10950	*12650	10700	*16650	14350	*20400	*20400	*25850	*25850
-4.5 m		*11400	*11400			*11950	*11950	*15200	*15200	*19850	*19850
Arm length 2900 mm											
6.0 m		*12450	10000	*12850	11700						
4.5 m		11950	8950	*13650	11400	*16100	15750	*20300	*20300		
3.0 m		11250	8450	*14700	11050	*18050	15050				
1.5 m		11100	8250	14550	10700	*19500	14450				
0 m		11400	8450	14300	10450	19750	14050				
-1.5 m		12350	9100	14200	10350	*19150	13950	*24600	21250		
-3.0 m		*13600	10600	*13550	10400	*17300	14050	*21700	*21350	*25850	*25850
-4.5 m		*13100	*13100			*13700	*13700	*17150	*17150	*19850	*19850

* Load is limited hydraulic capacity rather than tipping.
 Ratings are based on SAE Standard No. J1097. Rated loads do not exceed 87% of hydraulic lift capacity or 75% of tipping load.

PC490LC-10 (USA source)

Conditions:

Boom: 7060 mm (23'2"), Bucketless, Shoes: 900 mm (35.5"), Lifting mode: ON

unit: kg (lb)

B	A	MAX		9.1 m (30')		7.6 m (25')		6.1 m (20')		4.6 m (15')		3.0 m (10')	
		Cf	Cs	Cf	Cs	Cf	Cs	Cf	Cs	Cf	Cs	Cf	Cs
Arm length 2900 mm (9'6")													
7.6 m (25')		*12260 (27000)	10420 (22900)			*12340 (27200)	11120 (24500)						
6.1 m (20')		*12030 (26500)	8850 (19500)			*12730 (28000)	10970 (24100)	*14370 (31600)	*14370 (31600)				
4.6 m (15')		*11980 (26400)	8000 (17600)	*12090 (26600)	8220 (18100)	*13570 (29900)	10670 (23500)	*16160 (35600)	14570 (32100)	*21420 (47200)	*21420 (47200)		
3.0 m (10')		11620 (25600)	7580 (16700)	12400 (27300)	8070 (17700)	*14490 (31900)	10320 (22700)	*17970 (39600)	13900 (30600)				
1.5 m (5')		11480 (25300)	7460 (16400)	12230 (26900)	7910 (17400)	*15170 (33400)	10030 (22100)	*19120 (42100)	13390 (29500)				
0 m (0')		11820 (26000)	7630 (16800)	12130 (26700)	7820 (17200)	*15340 (33800)	9840 (21600)	*19290 (42500)	13130 (28900)	*21910 (48300)	19630 (43200)		
-1.5 m (-5')		*12350 (27200)	8190 (18000)			*14770 (32500)	9780 (21500)	*18470 (40700)	13070 (28800)	*23340 (51400)	19710 (43400)		
-3.0 m (-10')		*12210 (26900)	9370 (20600)			*13040 (28700)	9870 (21700)	*16560 (36500)	13180 (29000)	*20520 (45200)	19940 (43900)	*24130 (53200)	*24130 (53200)
-4.6 m (-15')		*11420 (25100)	*11420 (25100)					*12850 (28300)	*12850 (28300)	*16040 (35300)	*16040 (35300)		
Arm length 3380 mm (11'1")													
7.6 m (25')		*9200 (20200)	*9200 (20200)			*11720 (25800)	11320 (24900)						
6.1 m (20')		*9070 (20000)	8090 (17800)	*11430 (25200)	8480 (18700)	*12230 (26900)	11140 (24500)						
4.6 m (15')		*9210 (20300)	7410 (16300)	*11770 (25900)	8350 (18400)	*13160 (29000)	10820 (23800)	*15510 (34200)	14820 (32600)	*20080 (44200)	*20080 (44200)		
3.0 m (10')		*9580 (21100)	7050 (15500)	*12260 (27000)	8160 (18000)	*14190 (31300)	10460 (23000)	*17470 (38500)	14130 (31100)	*24120 (53100)	20980 (46200)		
1.5 m (5')		*10240 (22500)	6950 (15300)	12310 (27100)	7990 (17600)	*15020 (33100)	10140 (22300)	*18900 (41600)	13570 (29900)	*19210 (42300)	*19210 (42300)		
0 m (0')		10910 (24000)	7100 (15600)	12170 (26800)	7860 (17300)	*15390 (33900)	9910 (21800)	*19390 (42700)	13240 (29100)	*21790 (48000)	19470 (43500)		
-1.5 m (-5')		*11600 (25500)	7540 (16600)	12130 (26700)	7820 (17200)	*15080 (33200)	9810 (21600)	*18910 (41700)	13120 (28900)	*24440 (53800)	19730 (43400)	*15850 (34900)	*15850 (34900)
-3.0 m (-10')		*11490 (25300)	8440 (18600)			*13810 (30400)	9850 (21700)	*17380 (38300)	13170 (29000)	*21950 (48300)	19890 (43800)	*24660 (54300)	*24660 (54300)
-4.6 m (-15')		*10930 (24100)	10320 (22700)					*14350 (31600)	13400 (29500)	*17970 (39600)	*17970 (39600)	*21900 (48200)	*21900 (48200)
Arm length 4000mm (13'1")													
7.6 m (25')		*7890 (17400)	*7890 (17400)	*8750 (19200)	8560 (18800)								
6.1 m (20')		*7810 (17200)	7380 (16200)	*10650 (23400)	8500 (18700)	*11350 (25000)	11200 (24700)						
4.6 m (15')		*7930 (17400)	6790 (14900)	*11120 (24500)	8330 (18300)	*12350 (27200)	10850 (23900)	*14350 (31600)	*14350 (31600)				
3.0 m (10')		*8230 (18100)	6480 (14200)	*11710 (25800)	8100 (17800)	*13480 (29700)	10440 (23000)	*16440 (36200)	14190 (31200)	*22280 (49100)	21310 (46900)		
1.5 m (5')		*8760 (19300)	6380 (14000)	12220 (26900)	7890 (17300)	*14470 (31900)	10050 (22100)	*18140 (39900)	13520 (29800)	*25090 (55300)	20070 (44200)		
0 m (0')		*9590 (21100)	6480 (14200)	12030 (26500)	7720 (17000)	*15050 (33100)	9770 (21500)	*19010 (41900)	13090 (28800)	*23770 (52400)	19500 (43000)		
-1.5 m (-5')		10590 (23300)	6830 (15000)	11940 (26300)	7630 (16800)	*15040 (33100)	9610 (21200)	*18940 (41700)	12880 (28400)	*25010 (55100)	19350 (42600)	*15460 (34100)	*15460 (34100)
-3.0 m (-10')		*10930 (24100)	7530 (16600)	*11220 (24700)	7660 (16800)	14220 (31300)	9590 (21100)	*17870 (39400)	12860 (28300)	*23050 (50800)	19400 (42800)	*22240 (49000)	*22240 (49000)
-4.6 m (-15')		*10700 (23600)	8920 (19600)			*12100 (26600)	9740 (21400)	*15550 (34200)	13030 (28700)	*19730 (43500)	*19730 (43500)	*25470 (56100)	*25470 (56100)

* Load is limited hydraulic capacity rather than tipping. Ratings are based on ISO Standard No.10567. Rated loads do not exceed 87% of hydraulic lift capacity or 75% of tipping load.

PC490LC-10 (USA source)

Conditions:

Boom: 7060 mm (23'2"), Bucketless, Shoes: 900 mm (35.5"), Lifting mode: ON

unit: kg (lb)

B	A	MAX		9.1 m (30')		7.6 m (25')		6.1 m (20')		4.6 m (15')		3.0 m (10')	
		Cf	Cs	Cf	Cs	Cf	Cs	Cf	Cs	Cf	Cs	Cf	Cs
Arm length 4800mm (15'9")													
7.6 m (25')		*6360 (14000)	*6360 (14000)	*9450 (20800)	8730 (19200)								
6.1 m (20')		*6290 (13800)	*6290 (13800)	*9740 (21400)	8610 (18900)								
4.6 m (15')		*6350 (14000)	6060 (13300)	*10320 (22700)	8400 (18500)	*11310 (24900)	10990 (24200)						
3.0 m (10')		*6550 (14400)	5800 (12700)	*11030 (24300)	8130 (17900)	*12560 (27700)	10540 (23200)	*15080 (33200)	14450 (31800)	*19860 (43700)	*19860 (43700)		
1.5 m (5')		*6890 (15200)	5710 (12500)	*11710 (25800)	7870 (17300)	*13740 (30300)	10090 (22200)	*17100 (37700)	13670 (30100)	*23510 (51800)	20450 (45000)		
0 m (0')		*7430 (16300)	5770 (12700)	11980 (26400)	7650 (16800)	*14590 (32100)	9730 (21400)	*18430 (40600)	13090 (28800)	*25290 (55700)	19540 (43000)	*10360 (22800)	*10360 (22800)
-1.5 m (-5')		*8260 (18200)	6020 (13200)	11810 (26000)	7500 (16500)	*14920 (32900)	9500 (20900)	*18860 (41500)	12760 (28100)	*25390 (55900)	19150 (42200)	*14230 (31300)	*14230 (31300)
-3.0 m (-10')		*9580 (21100)	6530 (14400)	11760 (25900)	7450 (16400)	*14570 (32100)	9400 (20700)	*18350 (40400)	12640 (27800)	*24180 (53300)	19100 (42100)	*19240 (42400)	*19240 (42400)
-4.6 m (-15')		*9990 (22000)	7480 (16400)	*10180 (22400)	7560 (16600)	*13260 (29200)	9450 (20800)	*16760 (36900)	12710 (28000)	*21670 (47700)	19280 (42500)	*25760 (56700)	*25760 (56700)

* Load is limited hydraulic capacity rather than tipping.

Ratings are based on ISO Standard No.10567. Rated loads do not exceed 87% of hydraulic lift capacity or 75% of tipping load.

PC490LC-10 (UK source)

Conditions: Boom: 7100 mm, Bucket (SAE): 2.2 m³, Shoes: 600 mm

unit: kg

B	A	MAX		9.0 m		7.5 m		6.0 m		4.5 m		3.0 m	
		Cf	Cs	Cf	Cs	Cf	Cs	Cf	Cs	Cf	Cs	Cf	Cs
Arm length 2400 mm													
	7.5 m	*13220	11610			*13240	11800						
	6.0 m	*12870	9800			*13540	11670	*15500	*15500				
	4.5 m	*12750	8860			*14340	11370	*17320	15500				
	3.0 m	12270	8390	12660	8650	*15190	11050	*19000	14850				
	1.5 m	12150	8290	12520	8520	*15720	10780	*19820	14430				
	0 m	12560	8530			*15670	10630	*19590	14240				
	-1.5 m	*12760	9220			*14800	10610	*18410	14240	*22350	21770		
	-3.0 m	*12360	10690			*12480	10760	*16080	14400	*19360	*19360	*20430	*20430
	-4.5 m	*10960	*10960					*11520	*11520	*14410	*14410		
	-6.0 m												
Arm length 2900 mm													
	7.5 m	*12150	10650			*12310	11840						
	6.0 m	*11930	9100			*12790	11650	*14530	*14530				
	4.5 m	*11890	8260	*12130	8710	*13680	11310	*16380	15520				
	3.0 m	11480	7830	*12530	8530	*14630	10940	*18200	14790				
	1.5 m	11360	7710	12370	8360	*15310	10620	*19330	14260				
	0 m	11690	7900	12250	8250	*15480	10420	*19460	13990				
	-1.5 m	*12250	8470			*14920	10360	*18630	13930	*23440	*21260		
	-3.0 m	*12120	9670			*13280	10450	*16740	14040	*20660	*20660	*24100	*24100
	-4.5 m	*11370	*11370					*13180	*13180	*16280	*16280		
	-6.0 m												
Arm length 3400 mm													
	7.5 m	*9160	*9160			*11710	*11710						
	6.0 m	*9060	8320	*11420	9000	*12310	11830						
	4.5 m	*9210	7640	*11820	8850	*13280	11490	*15730	*15730	*20530	*20530		
	3.0 m	*9590	7290	*12340	8640	*14340	11100	*17720	15060	*24590	22560		
	1.5 m	*10240	7200	12460	8450	*15180	10750	*19130	14470	*17760	*17760		
	0 m	10790	7350	12310	8310	*15540	10520	*19600	14120	*20720	*20720		
	-1.5 m	11510	7800	12250	8260	*15240	10410	*19100	14000	*24620	21290	*15450	*15450
	-3.0 m	*11410	8720			*14020	10440	*17580	14050	*22140	21470	*24050	*24050
	-4.5 m	*10880	10590			*11020	10670	*14650	14280	*18250	*18250	*22170	*22170
	-6.0 m												
Arm length 4000 mm													
	7.5 m	*7890	*7890	*9970	9170								
	6.0 m	*7830	7650	*10720	9080	*11480	*11480						
	4.5 m	*7960	7070	*11240	8890	*12520	11580	*14620	*14620				
	3.0 m	*8270	6760	*11860	8650	*13690	11150	*16750	15210	*22810	*22810		
	1.5 m	*8800	6660	*12410	8420	*14690	10750	*18460	14510	*23800	21750		
	0 m	*9620	6770	12240	8240	*15290	10450	*19320	14060	*22690	21170		
	-1.5 m	10520	7120	12130	8140	*15280	10280	*19230	13840	*25360	21020	*15150	*15150
	-3.0 m	*10930	7840	*11560	8160	*14500	10260	*18170	13830	*23390	21110	*21760	*21760
	-4.5 m	*10710	9230			*12490	10390	*15910	13980	*20120	*20120	*25940	*25940
	-6.0 m	*9770	*9770					*11580	*11580	*14840	*14840		
Arm length 4800 mm													
	7.5 m	*6380	*6380	*9480	9340								
	6.0 m	*6310	*6310	*9820	9200								
	4.5 m	*6380	6310	*10440	8970	*11480	*11480						
	3.0 m	*6580	6060	*11170	8690	*12760	11270	*15370	*15370	*20330	*20330		
	1.5 m	*6930	5970	*11870	8410	*13960	10800	*17410	14680	*23980	22160		
	0 m	*7460	6040	12190	8180	*14820	10420	*18740	14070	*24610	21220	*10120	*10120
	-1.5 m	*8280	6300	12020	8020	*15160	10180	*19160	13730	*25780	20820	*13950	*13950
	-3.0 m	*9570	6810	11960	7960	*14830	10070	*18660	13600	*24560	20760	*18840	*18840
	-4.5 m	*9990	7770	*10610	8050	*13580	10120	*17100	13670	*22080	20940	*25120	*25120
	-6.0 m	*9580	*9580			*10700	10360	*14070	13930	*17970	*17970	*23550	*23550

* Load is limited hydraulic capacity rather than tipping.
Ratings are based on SAE Standard No. J1097. Rated loads do not exceed 87% of hydraulic lift capacity or 75% of tipping load.

PC490LC-10 (UK source)

Conditions: Short boom: 6700 mm, Bucket (SAE): 2.2 m³, Shoes: 600 mm

unit :kg (lb)

B	A	MAX		7.0 m		6.0 m		4.5 m		3.0 m	
		Cf	Cs	Cf	Cs	Cf	Cs	Cf	Cs	Cf	Cs
Arm length 2400 mm											
6.0 m		*12850	10250	*13600	11850	*15200	*15200				
4.5 m		*13100	9200	*14350	11600	*17000	15900	*22000	*22000		
3.0 m		12700	8700	*15300	11300	*18900	15300				
1.5 m		12600	8600	*15850	11000	*20000	14800				
0 m		13000	8850	*15900	10800	*20000	14500				
-1.5 m		*13200	9600	*15100	10750	*19000	14450	*23650	*22100		
-3.0 m		*12850	11150	*12650	10900	*16650	14600	*20400	*20400	*21950	*21950
-4.5 m		*11400	*11400			*11950	*11950	*15200	*15200		
Arm length 2900 mm											
6.0 m		*12450	10150	*12850	11900						
4.5 m		*12450	9100	*13650	11600	*16100	16000	*20300	*20300		
3.0 m		12550	8550	*14700	11200	*18050	15250				
1.5 m		12350	8400	*15450	10900	*19500	14700				
0 m		12750	8600	*15700	10650	*19800	14300				
-1.5 m		*13450	9300	*15200	10550	*19150	14200	*24600	21650		
-3.0 m		*13600	10750	*13550	10600	*17300	14250	*21700	*21700	*25850	*25850
-4.5 m		*13100	*13100			*13700	*13700	*17150	*17150	*19850	*19850

* Load is limited hydraulic capacity rather than tipping.
 Ratings are based on SAE Standard No. J1097. Rated loads do not exceed 87% of hydraulic lift capacity or 75% of tipping load.

PC550LC-8

Conditions:

Boom: 6670 mm (21'11"), Bucket: 3.5 m³, Shoes: 750 mm (29.5")

unit: kg (lb)

B	A	MAX		9.0 m (29')		7.5 m (24')		6.0 m (19')		4.5 m (14')		3.0 m (9')	
		Cf	Cs	Cf	Cs	Cf	Cs	Cf	Cs	Cf	Cs	Cf	Cs
Arm length 2400 mm (7'10")													
7.5 m (24')	*6000 (13200)	5950 (13200)											
6.0 m (19')	*6000 (13200)	4950 (10900)	*8850 (19500)	5800 (12800)	*9600 (21200)	8350 (18400)							
4.5 m (14')	*6200 (13600)	4350 (9600)	*9250 (20400)	5650 (12400)	*10600 (23300)	7950 (17500)	*12800 (28200)	11700 (25800)					
3.0 m (9')	*6550 (14500)	4000 (8900)	9400 (20800)	5400 (11900)	*11750 (25900)	7500 (16500)	*14950 (33000)	13900 (23900)	*20900 (46100)	17150 (37800)			
1.5 m (4')	7150 (15700)	3900 (8600)	9150 (20200)	5150 (11300)	12450 (27400)	7050 (15500)	*16650 (36700)	10100 (22300)	*17650 (38900)	15750 (34700)			
0.0 m (0')	7300 (16100)	7630 (8700)	8950 (19700)	4950 (10900)	12100 (26700)	6750 (14900)	*17300 (38200)	9650 (21200)	*17800 (39200)	15200 (33500)			
-1.5 m (-4')	7800 (17200)	4250 (9400)	8850 (19500)	4850 (10700)	11900 (26300)	6600 (14500)	*17100 (37700)	9450 (20800)	*22950 (50600)	15200 (33500)			
-3.0 m (-9')	8900 (19600)	4900 (10800)	8850 (19600)	4900 (10800)	11900 (26300)	6550 (14500)	*16000 (35300)	9450 (20900)	*20950 (46200)	15400 (33900)	*21700 (47800)	*21700 (47800)	
-4.5 m (-14')	*9100 (20100)	*6200 (13600)			*10350 (22800)	6750 (14900)	*13750 (30400)	9650 (21300)	*17700 (39100)	15750 (34700)	*22350 (49300)	*22350 (49300)	
-6.0 m (-19')	*8050 (17700)	*8050 (17700)					*9450 (20800)	*9450 (20800)	*12600 (27700)	*12600 (27700)			

* Load is limited hydraulic capacity rather than tipping.

Ratings are based on SAE Standard No. J1097. Rated loads do not exceed 87% of hydraulic lift capacity or 75% of tipping load.

PC600-8E0, PC600-8R1

Conditions: Boom: 7660 mm (25'2"), Bucket (SAE): 2.70 m³ (3.53 cu.yd), Shoes: 600 mm (24")
 (Lifting mode: OFF) unit: kg (lb)

B	A	MAX		9.1 m (29')		7.6 m (24')		6.1 m (20')		4.6 m (15')		3.0 m (9')	
		Cf	Cs	Cf	Cs	Cf	Cs	Cf	Cs	Cf	Cs	Cf	Cs
Arm length 3500 mm (11'6")													
	9.1 m (29')	*6950 (15300)	*6950 (15300)										
	6.1 m (20')	*6850 (15100)	*6850 (15100)	*9700 (21400)	*9700 (21400)	*10800 (23800)	*10800 (23800)						
	3.0 m (9')	*7600 (16700)	6050 (13400)	*11250 (24800)	8950 (19800)	*13600 (30000)	12250 (27000)	*17850 (39300)	17400 (38400)				
	0 m (0')	8100 (17900)	6000 (13300)	11050 (24400)	8300 (18300)	14850 (32800)	11150 (24600)	*20200 (44500)	15850 (34900)	*16850 (37100)	*16850 (37100)		
	-3.0 m (-9')	9700 (21400)	7200 (15900)	10850 (24000)	8100 (17900)	14550 (32100)	10850 (23900)	*18950 (41700)	15600 (34400)	*24500 (54000)	*24500 (54000)	*14350 (31600)	*14350 (31600)
	-6.1 m (-20')	*9500 (21000)	*9500 (21000)			*8550 (18800)	*8550 (18800)	*12800 (28200)	*12800 (28200)	*16300 (35900)	*16300 (35900)		

(Lifting mode: ON) unit: kg (lb)

B	A	MAX		9.1 m (29')		7.6 m (24')		6.1 m (20')		4.6 m (15')		3.0 m (9')	
		Cf	Cs	Cf	Cs	Cf	Cs	Cf	Cs	Cf	Cs	Cf	Cs
Arm length 3500 mm (11'6")													
	9.1 m (29')	*8550 (18900)	*8550 (18900)										
	6.1 m (20')	*8450 (18600)	7200 (15900)	*12250 (27000)	9800 (21600)	*13500 (29700)	*13500 (29700)						
	3.0 m (9')	8100 (17900)	6050 (13400)	11750 (26000)	8950 (19800)	*16000 (35300)	12250 (27000)	*22100 (48700)	17550 (38700)				
	0 m (0')	8100 (17900)	6000 (13300)	11050 (24400)	8300 (18300)	14850 (32800)	11150 (24600)	21350 (47100)	15850 (34900)	*20150 (44400)	*20150 (44400)		
	-3.0 m (-9')	9700 (21400)	7200 (15900)	10850 (24000)	8100 (17900)	14550 (32100)	10850 (23900)	21150 (46600)	15600 (34400)	*30400 (67100)	25750 (56800)	*17400 (38300)	*17400 (38300)
	-6.1 m (-20')	*12350 (27300)	*12350 (27300)			*11150 (24600)	*11150 (24600)	*16350 (36000)	*16350 (36000)	*20650 (45600)	*20650 (45600)		

Conditions: Boom: 7300 mm (23'11"), Bucket (SAE): 2.80 m³ (3.66 cu.yd), Shoes: 600 mm (24")
 (Lifting mode: OFF) unit: kg (lb)

B	A	MAX		9.1 m (29')		7.6 m (24')		6.1 m (20')		4.6 m (15')		3.0 m (9')	
		Cf	Cs	Cf	Cs	Cf	Cs	Cf	Cs	Cf	Cs	Cf	Cs
Arm length 3500 mm (11'6")													
	9.1 m (29')	*6500 (14300)	*6500 (14300)										
	6.1 m (20')	*6350 (14000)	*6350 (14000)	*9550 (21000)	9400 (20800)	*10500 (23200)	*10500 (23200)						
	3.0 m (9')	*7200 (15800)	6150 (13600)	*11000 (24200)	8650 (19100)	*13300 (29300)	12050 (26500)	*17350 (38200)	*17350 (38200)	*24100 (53200)	*24100 (53200)		
	0 m (0')	8400 (18500)	6150 (13600)	10800 (23800)	8000 (17700)	14700 (32400)	11000 (24200)	*20000 (44100)	15850 (34900)	*14600 (32100)	*14600 (32100)		
	-3.0 m (-9')	10250 (22600)	7600 (16700)	10650 (23500)	7900 (17400)	*14400 (31700)	10700 (23500)	*18750 (41300)	15550 (34200)	*24750 (54500)	*24750 (54500)	*19650 (43300)	*19650 (43300)
	-6.1 m (-20')	*9500 (20900)	*9500 (20900)					*11450 (25200)	*11450 (25200)	*15250 (33700)	*15250 (33700)		

(Lifting mode: ON) unit: kg (lb)

B	A	MAX		9.1 m (29')		7.6 m (24')		6.1 m (20')		4.6 m (15')		3.0 m (9')	
		Cf	Cs	Cf	Cs	Cf	Cs	Cf	Cs	Cf	Cs	Cf	Cs
Arm length 3500 mm (11'6")													
	9.1 m (29')	*8150 (17900)	*8150 (17900)										
	6.1 m (20')	*7950 (17600)	*7450 (16500)	*12150 (26800)	9400 (20800)	*13200 (29100)	*13200 (29100)						
	3.0 m (9')	8350 (18400)	6150 (13600)	11450 (25300)	8650 (19100)	15850 (34900)	12050 (26500)	*21550 (47500)	*17600 (38800)	*26500 (58400)	*26500 (58400)		
	0 m (0')	8400 (18500)	6150 (13600)	10800 (23800)	8000 (17700)	14700 (32400)	11000 (24200)	*21400 (47200)	15850 (34900)	*17800 (39300)	*17800 (39300)		
	-3.0 m (-9')	10250 (22600)	7600 (16700)	10650 (23500)	7900 (17400)	14400 (31700)	10700 (23500)	21050 (46500)	15550 (34200)	*30700 (67700)	25800 (56900)	*23750 (52400)	*23750 (52400)
	-6.1 m (-20')	*12450 (27400)	*12450 (27400)					*14750 (32600)	*14750 (32600)	*19500 (43000)	*19500 (43000)		

* Load is limited hydraulic capacity rather than tipping.
 Ratings are based on SAE Standard No. J1097. Rated loads do not exceed 87% of hydraulic lift capacity or 75% of tipping load.

PC600-8E0, PC600-8R1

Conditions: Boom: 6600 mm (21'8"), Bucket (SAE): 3.50 m³ (4.58 cu.yd), Shoes: 600 mm (24")
 (Lifting mode: OFF)

unit: kg (lb)

B	A	MAX		9.1 m (29')		7.6 m (24')		6.1 m (20')		4.6 m (15')		3.0 m (9')	
		Cf	Cs	Cf	Cs	Cf	Cs	Cf	Cs	Cf	Cs	Cf	Cs
Arm length 2900 mm (9'6")													
9.1 m (29')		*9650 (21300)	*9650 (21300)										
6.1 m (20')		*8950 (19700)	*8950 (19700)			*11750 (25900)	*11750 (25900)						
3.0 m (9')		*9800 (21600)	7600 (16700)	11500 (25300)	8650 (19100)	*14000 (30900)	12100 (26600)	*17950 (39600)	17650 (38900)	*24650 (54300)	*24650 (54300)		
0 m (0')		10300 (22700)	7650 (16900)	10900 (24100)	8100 (17900)	14850 (32800)	11100 (24500)	*20250 (44600)	16100 (35500)	*26150 (57700)	25000 (55100)	*24700 (54500)	*24700 (54500)
-3.0 m (-9')		*11500 (25400)	9950 (22000)			*13250 (29200)	11000 (24300)	*17950 (39600)	15950 (35100)	*23750 (52400)	*23750 (52400)		

(Lifting mode: ON)

unit: kg (lb)

B	A	MAX		9.1 m (29')		7.6 m (24')		6.1 m (20')		4.6 m (15')		3.0 m (9')	
		Cf	Cs	Cf	Cs	Cf	Cs	Cf	Cs	Cf	Cs	Cf	Cs
Arm length 2900 mm (9'6")													
9.1 m (29')		*11800 (26000)	*11800 (26000)										
6.1 m (20')		*10950 (24200)	9400 (20700)			*14700 (32400)	13300 (29300)						
3.0 m (9')		10150 (22300)	7600 (16700)	11500 (25300)	8650 (19100)	15900 (35100)	12100 (26600)	*22250 (49000)	17750 (39200)	*30350 (66900)	28050 (61800)		
0 m (0')		10300 (22700)	7650 (16900)	10900 (24100)	8100 (17900)	14850 (32800)	11100 (24500)	21700 (47900)	16100 (35500)	*26150 (57700)	25000 (55100)		
-3.0 m (-9')		13350 (29400)	9950 (22000)			14750 (32500)	11000 (24300)	21550 (47500)	15950 (35100)	*29500 (65100)	26450 (58300)	*31000 (68400)	*31000 (68400)

* Load is limited hydraulic capacity rather than tipping.
 Ratings are based on SAE Standard No. J1097. Rated loads do not exceed 87% of hydraulic lift capacity or 75% of tipping load.

PC600-8 (UK source)

Conditions: Boom: 7300 mm, Bucket :3100 kg, Shoes: 600 mm

(Lifting mode: OFF)

unit: kg

B	A	MAX		9.1 m		7.6 m		6.1 m		4.6 m		3.0 m	
		Cf	Cs	Cf	Cs	Cf	Cs	Cf	Cs	Cf	Cs	Cf	Cs
Arm length 3500 mm													
9.1 m		*6500	*6500										
6.1 m		*6350	*6350	*9650	9300	*10700	*10700						
3.0 m		*7150	6200	*11000	8600	*13200	11950	*16900	*16900	*24200	*24200		
0 m		8400	6150	10700	7950	14500	10750	*19600	15400	*21300	*21300		
-3.0 m		10300	7600	10550	7850	*14100	10500	*18250	15150	*24150	*24150	*21900	*21900
-6.1 m		*9500	*9500					*10800	*10800	*14500	*14500		

(Lifting mode: ON)

unit: kg

9.1 m		*8150	*8150										
6.1 m		*7950	7450	12150	9300	*13450	13350						
3.0 m		8350	6200	11400	8600	15700	11950	*21000	17400	*29850	27900		
0 m		8400	6150	10700	7950	14500	10950	20950	15400	*25450	24800		
-3.0 m		10300	7600	10550	7850	14200	10500	20650	15150	*30200	24900	*26150	*26150
-6.1 m		*12450	*12450					*14050	*14050	*18650	*18650		

Conditions: Boom: 6600 mm, Bucket: 3200 kg, Shoes: 600 mm

(Lifting mode: OFF)

unit: kg

B	A	MAX		9.1 m		7.6 m		6.1 m		4.6 m		3.0 m	
		Cf	Cs	Cf	Cs	Cf	Cs	Cf	Cs	Cf	Cs	Cf	Cs
Arm length 2900 mm													
9.1 m		*9700	*9700										
6.1 m		*8950	*8950			*11950	*11950						
3.0 m		*9800	7600	11400	8600	*14000	12000	*17650	17600	*24700	*24700		
0 m		10300	7650	10850	8050	14700	10950	*19900	15700	*27600	25250		
-3.0 m		*11500	10050			*12850	10900	*16800	14950	*22950	*22950	*30500	*30500
-4.6 m		*10650	*10650					*12900	*12900	*17500	*17500	*22300	*22300

(Lifting mode: ON)

unit: kg

9.1 m		*11850	*11850										
6.1 m		*10950	9400			*14950	13200						
3.0 m		10150	7600	11400	8600	15800	12000	*21850	17600	*30400	28400		
0 m		10300	7650	10850	8050	14700	10950	21300	15700	*34200	25250		
-3.0 m		13450	10050			14650	10900	20450	14950	*28700	25500	*36700	*36700
-4.6 m		*13800	13750					*16550	16150	*22200	*22200	*28350	*28350

* Load is limited hydraulic capacity rather than tipping.

Ratings are based on ISO Standard No.10567. Rated loads do not exceed 87% of hydraulic lift capacity or 75% of tipping load.

PC600-7

Conditions: Boom: 7660 mm (25'2"), Bucket (SAE): 2.70 m³ (3.53 cu.yd), Shoes: 600 mm (24")

(Heavy-lifting: "OFF")

unit: kg (lb)

B	A	MAX		9.1 m (30')		7.6 m (25')		6.1 m (20')		4.6 m (15')		3.0 m (10')	
		Cf	Cs	Cf	Cs	Cf	Cs	Cf	Cs	Cf	Cs	Cf	Cs
Arm length 3500 mm (11'6")													
9.1 m (30')		*8000 (17600)	*8000 (17600)										
6.1 m (20')		*7900 (17400)	7250 (16000)	*10150 (22400)	8950 (19700)	*11450 (25300)	*11450 (25300)						
3.0 m (10')		8150 (18000)	6050 (13300)	11000 (24200)	8300 (18300)	*14000 (30800)	11400 (25100)	*18200 (40100)	16350 (86100)				
0 m (0')		8200 (18100)	6050 (13300)	10350 (22900)	7700 (17000)	13500 (29800)	9950 (21900)	*20100 (44300)	14800 (32700)	*14500 (32000)	*14500 (32000)		
-3.0 m (-10')		10150 (22400)	7550 (16600)	10350 (22800)	7650 (16900)	13500 (29800)	9950 (22000)	*18100 (39900)	14800 (32600)	*23150 (51000)	*23150 (51000)	*20950 (46200)	*20950 (46200)
-6.1 m (-20')		*9250 (20500)	*9250 (20500)					*10400 (22900)	*10400 (22900)	*13550 (29800)	*13550 (29800)		

(Heavy-lifting: "ON")

unit: kg (lb)

B	A	MAX		9.1 m (30')		7.6 m (25')		6.1 m (20')		4.6 m (15')		3.0 m (10')	
		Cf	Cs	Cf	Cs	Cf	Cs	Cf	Cs	Cf	Cs	Cf	Cs
Arm length 3500 mm (11'6")													
9.1 m (30')		*8850 (19500)	*8850 (19500)										
6.1 m (20')		*8750 (19300)	7250 (16000)	*11350 (25100)	8950 (19700)	*12750 (28100)	12700 (28000)						
3.0 m (10')		8150 (18000)	6050 (13300)	11000 (24200)	8300 (18300)	15050 (33200)	11400 (25100)	*20150 (44500)	16350 (86100)				
0 m (0')		8200 (18100)	6050 (13300)	10350 (22900)	7700 (17000)	13500 (29800)	9950 (21900)	20200 (44500)	14800 (32700)	*15900 (35000)	*15900 (35000)		
-3.0 m (-10')		10150 (22400)	7550 (16600)	10350 (22800)	7650 (16900)	13500 (29800)	9950 (22000)	20150 (44400)	14800 (32600)	*25750 (56800)	24400 (53800)	*22800 (50300)	*22800 (50300)
-6.1 m (-20')		*10550 (23300)	*10550 (23300)					*11800 (26000)	*11800 (26000)	*15300 (83700)	*15300 (33700)		

Conditions: Boom: 7300 mm (23'11"), Bucket (SAE): 2.80 m³ (3.66 cu.yd), Shoes: 600 mm (24")

(Heavy-lifting: "OFF")

unit: kg (lb)

B	A	MAX		9.1 m (30')		7.6 m (25')		6.1 m (20')		4.6 m (15')		3.0 m (10')	
		Cf	Cs	Cf	Cs	Cf	Cs	Cf	Cs	Cf	Cs	Cf	Cs
Arm length 3500 mm (11'6")													
9.1 m (30')		*7550 (16600)	*7550 (16600)			*8400 (18500)	*8400 (18500)						
6.1 m (20')		*7450 (16400)	*7450 (16400)	*10100 (22300)	8650 (19100)	*11300 (24900)	*11300 (24900)						
3.0 m (10')		*8550 (18800)	6300 (13900)	10850 (24000)	8150 (17900)	*13800 (30400)	11400 (25100)	*17200 (38000)	15900 (35100)	*23350 (51500)	*23350 (51500)		
0 m (0')		8700 (19200)	6350 (14000)	10300 (22700)	7600 (16800)	14100 (31000)	10450 (23000)	*20000 (44100)	15050 (33200)	*19500 (43000)	*19500 (43000)		
-3.0 m (-10')		*10900 (24000)	8150 (18000)			*13750 (30300)	10300 (22700)	*17900 (39500)	14950 (38000)	*23300 (51300)	*23300 (51800)	*23850 (52500)	*23850 (52500)

(Heavy-lifting: "ON")

unit: kg (lb)

B	A	MAX		9.1 m (30')		7.6 m (25')		6.1 m (20')		4.6 m (15')		3.0 m (10')	
		Cf	Cs	Cf	Cs	Cf	Cs	Cf	Cs	Cf	Cs	Cf	Cs
Arm length 3500 mm (11'6")													
9.1 m (30')		*8400 (18500)	*8400 (18500)			*9300 (20500)	*9300 (20500)						
6.1 m (20')		*8300 (18300)	7700 (17000)	*11350 (25000)	8650 (19100)	*12600 (27800)	12600 (27700)						
3.0 m (10')		8600 (18900)	6300 (13900)	10850 (24000)	8150 (17900)	15100 (83300)	11400 (25100)	*19150 (42300)	15900 (35100)	*25450 (56100)	*25450 (56100)		
0 m (0')		8700 (19200)	6350 (14000)	10300 (22700)	7600 (16800)	14100 (31000)	10450 (23000)	20500 (45200)	15050 (33200)	*21300 (46900)	*21300 (46900)		
-3.0 m (-10')		11050 (24400)	8150 (18000)			13950 (30700)	10300 (22700)	*19950 (44000)	14950 (33000)	*25900 (57100)	24800 (54600)	*25950 (57200)	*25950 (57200)

* Load is limited by hydraulic capacity rather than tipping.

Ratings are based on SAE Standard NO. J1097. Rated loads do not exceed 87% of hydraulic lift capacity or 75% of tipping load.

PC600-7

Conditions: Boom: 6600 mm (21'8"), Bucket (SAE): 3.5 m³ (4.58 cu.yd), Shoes: 600 mm (24")

(Heavy-lifting: "OFF")

unit: kg (lb)

B	A	MAX		9.1 m (30')		7.6 m (25')		6.1 m (20')		4.6 m (15')		3.0 m (10')	
		Cf	Cs	Cf	Cs	Cf	Cs	Cf	Cs	Cf	Cs	Cf	Cs
Arm length 2900 mm (9'6")													
9.1 m (30')		*8750 (19300)	*8750 (19300)										
6.1 m (20')		*8300 (18300)	*8300 (18300)			*11700 (25800)	*11700 (25800)						
3.0 m (10')		9300 (20500)	7050 (15600)	10850 (24000)	8150 (17900)	*13950 (30800)	11550 (25500)	*17650 (38900)	17100 (37700)	*24700 (54500)	*24700 (54500)		
0 m (0')		9650 (21300)	7100 (15700)	10350 (22800)	7650 (16800)	14150 (31200)	10550 (23200)	*19000 (41900)	13900 (30600)	*28100 (61900)	*24650 (54400)		
-3.0 m (-10')		11650 (25700)	9350 (20700)			*13200 (29200)	10400 (23000)	*16800 (37100)	13850 (30600)	*23750 (52300)	*23750 (52300)	*29900 (65900)	*29900 (65900)

(Heavy-lifting: "ON")

unit: kg (lb)

B	A	MAX		9.1 m (30')		7.6 m (25')		6.1 m (20')		4.6 m (15')		3.0 m (10')	
		Cf	Cs	Cf	Cs	Cf	Cs	Cf	Cs	Cf	Cs	Cf	Cs
Arm length 2900 mm (9'6")													
9.1 m (30')		*9700 (21400)	*9700 (21400)										
6.1 m (20')		*9200 (20200)	8750 (19300)			*13050 (28800)	12600 (27800)						
3.0 m (10')		9500 (21000)	7050 (15600)	10850 (24000)	8150 (17900)	15250 (33600)	11550 (25500)	*19550 (43100)	*17100 (37700)	27250 (60100)	*27250 (60100)		
0 m (0')		9650 (21300)	7100 (15700)	10350 (22800)	7650 (16800)	14150 (31200)	10550 (23200)	19200 (42400)	*13900 (30600)	31100 (68500)	24650 (54400)		
-3.0 m (-10')		12600 (27800)	9350 (20700)			14050 (31000)	10400 (23000)	*18850 (41600)	*13850 (30600)	26400 (58200)	24800 (54600)	*32450 (71600)	*32450 (71600)

* Load is limited by hydraulic capacity rather than tipping. Ratings are based on SAE Standard NO. J1097. Rated loads do not exceed 87% of hydraulic lift capacity or 75% of tipping load.

PC600LC-8E0, PC600LC-8R1

Conditions: Boom: 7660 mm (25'2"), Bucket (SAE): 2.70 m³ (3.53 cu.yd), Shoes: 600 mm (24")
(Lifting mode: OFF)

unit: kg (lb)

B	A	MAX		9.1 m (29')		7.6 m (24')		6.1 m (20')		4.6 m (15')		3.0 m (9')	
		Cf	Cs	Cf	Cs	Cf	Cs	Cf	Cs	Cf	Cs	Cf	Cs
Arm length 3500 mm (11'6")													
	9.1 m (29')	*6950 (15300)	*6950 (15300)										
	6.1 m (20')	*6850 (15100)	*6850 (15100)	*9700 (21400)	*9700 (21400)	*10800 (23800)	*10800 (23800)						
	3.0 m (9')	*7600 (16700)	6200 (13700)	*11250 (24800)	9150 (20200)	*13600 (30000)	12450 (27500)	*17850 (39300)	*17600 (38900)				
	0 m (0')	9350 (20600)	6150 (13600)	*12350 (27200)	8450 (18600)	*15400 (34000)	11350 (25100)	*20200 (44500)	16150 (35600)	*16850 (37100)	*16850 (37100)		
	-3.0 m (-9')	*10150 (22400)	7400 (16300)	*11600 (25500)	8300 (18300)	*14800 (32600)	11100 (24400)	*18950 (41700)	15900 (35100)	*24500 (54000)	*24500 (54000)	*14350 (31600)	*14350 (31600)
	-6.1 m (-20')	*9500 (21000)	*9500 (21000)			*8550 (18800)	*8550 (18800)	*12800 (28200)	*12800 (28200)	*16300 (35900)	*16300 (35900)		

(Lifting mode: ON)

unit: kg (lb)

B	A	MAX		9.1 m (29')		7.6 m (24')		6.1 m (20')		4.6 m (15')		3.0 m (9')	
		Cf	Cs	Cf	Cs	Cf	Cs	Cf	Cs	Cf	Cs	Cf	Cs
Arm length 3500 mm (11'6")													
	9.1 m (29')	*8550 (18900)	*8550 (18900)										
	6.1 m (20')	*8450 (18600)	7350 (16200)	*12250 (27000)	10000 (22000)	*13500 (29700)	*13500 (29700)						
	3.0 m (9')	9300 (20500)	6200 (13700)	13450 (29600)	9150 (20200)	*16000 (35300)	12450 (27500)	*22100 (48700)	17850 (39400)				
	0 m (0')	9350 (20600)	6150 (13600)	12700 (28000)	8450 (18600)	17100 (37700)	11350 (25100)	24800 (54600)	16150 (35600)	*20150 (44400)	*20150 (44400)		
	-3.0 m (-9')	11150 (24600)	7400 (16400)	12500 (27600)	8300 (18300)	16800 (37000)	11100 (24400)	*23650 (52100)	15900 (35100)	*30400 (67100)	26200 (57800)	*17400 (38300)	*17400 (38300)
	-6.1 m (-20')	*12350 (27300)	*12350 (27300)			*11150 (24600)	*11150 (24600)	*16350 (36000)	*16350 (36000)	*20650 (45600)	*20650 (45600)		

Conditions: Boom: 7300 mm (23'11"), Bucket (SAE): 2.80 m³ (3.66 cu.yd), Shoes: 600 mm (24")
(Lifting mode: OFF)

unit: kg (lb)

B	A	MAX		9.1 m (29')		7.6 m (24')		6.1 m (20')		4.6 m (15')		3.0 m (9')	
		Cf	Cs	Cf	Cs	Cf	Cs	Cf	Cs	Cf	Cs	Cf	Cs
Arm length 3500 mm (11'6")													
	9.1 m (29')	*6500 (14300)	*6500 (14300)										
	6.1 m (20')	*6350 (14000)	*6350 (14000)	*9550 (21000)	*9550 (21000)	*10500 (23200)	*10500 (23200)						
	3.0 m (9')	*7200 (15800)	6300 (13900)	*11000 (24200)	8850 (19500)	*13300 (29300)	12250 (27000)	*17350 (38200)	*17350 (38200)	*24100 (53200)	*24100 (53200)		
	0 m (0')	*9200 (20300)	6300 (13900)	*12050 (26600)	8200 (18100)	*15150 (33400)	11200 (24700)	*20000 (44100)	16150 (35600)	*14600 (32100)	*14600 (32100)		
	-3.0 m (-9')	*10350 (22900)	7750 (17100)	*10900 (24100)	8050 (17800)	*14400 (31700)	10900 (24000)	*18750 (41300)	15800 (34900)	*24750 (54500)	*24750 (54500)	*19650 (43300)	*19650 (43300)
	-6.1 m (-20')	*9500 (20900)	*9500 (20900)					*11450 (25200)	*11450 (25200)	*15250 (33700)	*15250 (33700)		

(Lifting mode: ON)

unit: kg (lb)

B	A	MAX		9.1 m (29')		7.6 m (24')		6.1 m (20')		4.6 m (15')		3.0 m (9')	
		Cf	Cs	Cf	Cs	Cf	Cs	Cf	Cs	Cf	Cs	Cf	Cs
Arm length 3500 mm (11'6")													
	9.1 m (29')	*8150 (17900)	*8150 (17900)										
	6.1 m (20')	*7950 (17600)	7650 (16800)	*12150 (26800)	9600 (21100)	*13200 (29100)	*13200 (29100)						
	3.0 m (9')	*8900 (19700)	6300 (13900)	13150 (29000)	8850 (19500)	*16700 (36800)	12250 (27000)	*21550 (47500)	17900 (39400)	*26500 (58400)	*26500 (58400)		
	0 m (0')	9700 (21400)	6300 (13900)	12450 (27400)	8200 (18100)	16950 (37400)	11200 (24700)	24750 (54600)	16150 (35600)	*17800 (39300)	*17800 (39300)		
	-3.0 m (-9')	11850 (26100)	7750 (17100)	12300 (27100)	8050 (17800)	16600 (36600)	10900 (24000)	*23450 (51700)	15850 (34900)	*30700 (67700)	26250 (57900)	*23750 (52400)	*23750 (52400)
	-6.1 m (-20')	*12450 (27400)	*12450 (27400)					*14750 (32600)	*14750 (32600)	*19500 (43000)	*19500 (43000)		

* Load is limited hydraulic capacity rather than tipping.
Ratings are based on SAE Standard No. J1097. Rated loads do not exceed 87% of hydraulic lift capacity or 75% of tipping load.

PC600LC-8E0, PC600LC-8R1

Conditions: Boom: 6600 mm (21'8"), Bucket (SAE): 3.50 m³ (4.58 cu.yd), Shoes: 600 mm (24")
 (Lifting mode: OFF) unit: kg (lb)

B	A	MAX		9.1 m (29')		7.6 m (24')		6.1 m (20')		4.6 m (15')		3.0 m (9')	
		Cf	Cs	Cf	Cs	Cf	Cs	Cf	Cs	Cf	Cs	Cf	Cs
Arm length 2900 mm (9'6")													
9.1 m (29')		*9650 (21300)	*9650 (21300)										
6.1 m (20')		*8950 (19700)	*8950 (19700)			*11750 (25900)	*11750 (25900)						
3.0 m (9')		*9800 (21600)	7750 (17100)	*11750 (25900)	8850 (19500)	*14000 (30900)	12300 (27100)	*17950 (39600)	17900 (39500)	*24650 (54300)	*24650 (54300)		
0 m (0')		*11500 (25400)	7800 (17200)	*12200 (26900)	8300 (18300)	*15500 (34000)	11350 (25000)	*20250 (44600)	16400 (36200)	*26150 (57700)	25000 (55100)	*24700 (54500)	*24700 (54500)
-3.0 m (-9')		*11500 (25400)	10150 (22400)			*13250 (29200)	11250 (24800)	*17950 (39600)	16250 (35800)	*23750 (52400)	*23750 (52400)		

(Lifting mode: ON) unit: kg (lb)

B	A	MAX		9.1 m (29')		7.6 m (24')		6.1 m (20')		4.6 m (15')		3.0 m (9')	
		Cf	Cs	Cf	Cs	Cf	Cs	Cf	Cs	Cf	Cs	Cf	Cs
Arm length 2900 mm (9'6")													
9.1 m (29')		*11800 (26000)	*11800 (26000)										
6.1 m (20')		*10950 (24200)	9600 (21100)			*14700 (32400)	13500 (29800)						
3.0 m (9')		11650 (25700)	7750 (17100)	13150 (29000)	8850 (19500)	*17500 (38600)	12300 (27100)	*22250 (49000)	18050 (39800)	*30350 (66900)	28500 (62800)		
0 m (0')		11850 (26100)	7800 (17200)	12550 (27700)	8300 (18300)	17150 (37800)	11350 (25000)	25100 (55300)	16400 (36200)	*26150 (57700)	25450 (56100)		
-3.0 m (-9')		*14750 (32500)	10150 (22400)			*16800 (37000)	11250 (24800)	*22450 (49500)	16250 (35800)	*29500 (65100)	26900 (59300)	*31000 (68400)	*31000 (68400)

* Load is limited hydraulic capacity rather than tipping.
 Ratings are based on SAE Standard No. J1097. Rated loads do not exceed 87% of hydraulic lift capacity or 75% of tipping load.

PC600LC-8 (UK source)

Conditions: Boom: 7660 mm, Bucket: 2750 kg, Shoes: 600 mm

(Lifting mode: OFF)

unit: kg

B	A	MAX		9.1 m		7.6 m		6.1 m		4.6 m		3.0 m	
		Cf	Cs	Cf	Cs	Cf	Cs	Cf	Cs	Cf	Cs	Cf	Cs
Arm length 3500 mm													
9.1 m		*6950	*6950										
6.1 m		*6850	*6850	*9800	*9800	*10950	*10950						
3.0 m		*7550	6200	*11200	9050	*13500	12350	*17100	*17100				
0 m		9350	6150	*12250	8350	*15100	11050	*19850	15750	*16550	*16550		
-3.0 m		*10150	7400	*11400	8200	*14350	10750	*18550	15550	*24150	*24150	*19450	*19450
-4.5 m		*9550	*9550					*11950	*11950	*15700	*15700		

(Lifting mode: ON)

unit: kg

9.1 m		*8450	7350	*2350	9850	*13650	*13650						
6.1 m		*9300	6200	13300	9050	*16850	12350	*21300	17350				
3.0 m		9350	6150	12550	8350	16700	11050	24350	15750	*19800	*19800		
0 m		*11200	7400	12400	8200	16400	10750	*23200	15550	*30150	25400	*23200	*23200
-3.0 m		*12400	*12400					*15400	*15400	*20100	*20100		
-4.5 m		*8450	7350	*2350	9850	*13650	*13650						

* Load is limited hydraulic capacity rather than tipping.

Ratings are based on ISO Standard No.10567. Rated loads do not exceed 87% of hydraulic lift capacity or 75% of tipping load.

PC600LC-7

Conditions: Boom: 7660 mm (25'2"), Bucket (SAE): 2.70 m³ (3.53 cu.yd), Shoes: 600 mm (24")

(Heavy-lifting: "OFF")

unit: kg (lb)

B	A	MAX		9.1 m (30')		7.6 m (25')		6.1 m (20')		4.6 m (15')		3.0 m (10')	
		Cf	Cs	Cf	Cs	Cf	Cs	Cf	Cs	Cf	Cs	Cf	Cs
Arm length 3500 mm (11'6")													
9.1 m (30')		*8000 (17600)	*8000 (17600)										
6.1 m (20')		*7900 (17400)	7400 (16400)	*10150 (22400)	9100 (20100)	*11450 (25300)	*11450 (25300)						
3.0 m (10')		*8900 (19700)	6200 (13600)	*11500 (25400)	8450 (18700)	*14000 (30800)	11650 (25600)	*18200 (40100)	16650 (36800)				
0 m (0')		9500 (21000)	6200 (13700)	12000 (26400)	7900 (17400)	*15000 (33100)	10200 (22400)	*20100 (44300)	15150 (33400)	*14500 (32000)	*14500 (32000)		
-3.0 m (-10')		*10600 (23300)	7700 (17000)	*10850 (23900)	7850 (17300)	*13850 (30600)	10200 (22500)	*18100 (39900)	15100 (33300)	*23150 (51000)	*23150 (51000)	*20950 (46200)	*20950 (46200)
-6.1 m (-20')		*9250 (20500)	*9250 (20500)					*10400 (22900)	*10400 (22900)	*13550 (29800)	*13550 (29800)		

(Heavy-lifting: "ON")

unit: kg (lb)

B	A	MAX		9.1 m (30')		7.6 m (25')		6.1 m (20')		4.6 m (15')		3.0 m (10')	
		Cf	Cs	Cf	Cs	Cf	Cs	Cf	Cs	Cf	Cs	Cf	Cs
Arm length 3500 mm (11'6")													
9.1 m (30')		*8850 (19500)	*8850 (19500)										
6.1 m (20')		*8750 (19300)	7400 (16400)	*11350 (25100)	9100 (20100)	*12750 (28100)	*12750 (28100)						
3.0 m (10')		9400 (20700)	6200 (18600)	12600 (27800)	8450 (18700)	*15550 (34800)	11650 (25600)	*20150 (44500)	16650 (36800)				
0 m (0')		9500 (21000)	6200 (13700)	12000 (26400)	7900 (17400)	15700 (34600)	10200 (22400)	*22300 (49200)	15150 (33400)	*15900 (35000)	*15900 (35000)		
-3.0 m (-10')		11750 (25900)	7700 (17000)	11950 (26400)	7850 (17300)	*15550 (34300)	10200 (22500)	*20200 (44500)	15100 (33300)	*25750 (56800)	24900 (54900)	*22800 (50300)	*22800 (50300)
-6.1 m (-20')		*10550 (23300)	*10550 (23300)					*11800 (26000)	*11800 (26000)	*15300 (33700)	*15300 (33700)		

Conditions: Boom: 7300 mm (23'11"), Bucket (SAE): 2.80 m³ (3.66 cu.yd), Shoes: 600 mm (24")

(Heavy-lifting: "OFF")

unit: kg (lb)

B	A	MAX		9.1 m (30')		7.6 m (25')		6.1 m (20')		4.6 m (15')		3.0 m (10')	
		Cf	Cs	Cf	Cs	Cf	Cs	Cf	Cs	Cf	Cs	Cf	Cs
Arm length 3500 mm (11'6")													
9.1 m (30')		*7550 (16600)	*7550 (16600)			*8400 (18500)	*8400 (18500)						
6.1 m (20')		*7450 (16400)	*7450 (16400)	*10100 (22300)	8850 (19500)	*11300 (24900)	*11300 (24900)						
3.0 m (10')		*8550 (18800)	6450 (14300)	*11350 (25100)	8300 (18300)	*13800 (30400)	11600 (25600)	*17200 (38000)	16200 (35700)	*23350 (51500)	*23350 (51500)		
0 m (0')		10100 (22200)	6500 (14400)	11900 (26800)	7800 (17200)	*15250 (33600)	10650 (23500)	*20000 (44100)	15350 (33800)	*19500 (48000)	*19500 (48000)		
-3.0 m (-10')		*10900 (24000)	8350 (18400)			*13750 (30300)	10550 (23200)	*17900 (39500)	15250 (33600)	*25300 (51300)	*23300 (51300)	*23850 (52500)	*23850 (52500)

(Heavy-lifting: "ON")

unit: kg (lb)

B	A	MAX		9.1 m (30')		7.6 m (25')		6.1 m (20')		4.6 m (15')		3.0 m (10')	
		Cf	Cs	Cf	Cs	Cf	Cs	Cf	Cs	Cf	Cs	Cf	Cs
Arm length 3500 mm (11'6")													
9.1 m (30')		*8400 (18500)	*8400 (18500)			*9300 (20500)	*9300 (20500)						
6.1 m (20')		*8300 (18300)	7850 (17300)	*11350 (25000)	8850 (19500)	*12600 (27800)	*12600 (27800)						
3.0 m (10')		*9450 (20800)	6450 (14300)	12500 (27500)	8300 (18300)	*15350 (33900)	11600 (25600)	*19150 (42300)	16200 (35700)	*25450 (56100)	*25450 (56100)		
0 m (0')		10100 (22200)	6500 (14400)	11900 (26300)	7800 (17200)	16250 (35900)	10650 (23500)	*22200 (49000)	15350 (33800)	*21300 (46900)	*21300 (46900)		
-3.0 m (-10')		*12300 (27100)	8350 (18400)			*15400 (33900)	10550 (23200)	*19950 (44000)	15250 (33600)	*25900 (57100)	25250 (55700)	*25950 (57200)	*25950 (57200)

* Load is limited by hydraulic capacity rather than tipping. Ratings are based on SAE Standard NO. J1097. Rated loads do not exceed 87% of hydraulic lift capacity or 75% of tipping load.

PC600LC-7

Conditions: Boom: 6600 mm (21'8"), Bucket (SAE): 3.5 m³ (4.58 cu.yd), Shoes: 600 mm (24")

(Heavy-lifting: "OFF")

unit: kg (lb)

B	A	MAX		9.1 m (30')		7.6 m (25')		6.1 m (20')		4.6 m (15')		3.0 m (10')	
		Cf	Cs	Cf	Cs	Cf	Cs	Cf	Cs	Cf	Cs	Cf	Cs
Arm length 2900 mm (9'6")													
9.1 m (30')		*8750 (19300)	*8750 (19300)										
6.1 m (20')		*8300 (18300)	*8300 (18300)			*11700 (25800)	*11700 (25800)						
3.0 m (10')		*9300 (20500)	7200 (15900)	*11700 (25800)	8350 (18400)	*13950 (30800)	11800 (26000)	*17650 (38900)	17400 (38400)	*24700 (54500)	*24700 (54500)		
0 m (0')		11200 (24600)	7300 (16100)	11950 (26400)	7800 (17300)	*15400 (33900)	10750 (23700)	*19000 (41900)	14200 (31300)	*28100 (61900)	25150 (55500)		
-3.0 m (-10')		*11650 (25700)	9350 (20700)			*13200 (29200)	10650 (23500)	*16800 (37100)	14200 (31300)	*23750 (52300)	*23750 (52300)	*29900 (65900)	*29900 (65900)

(Heavy-lifting: "ON")

unit: kg (lb)

B	A	MAX		9.1 m (30')		7.6 m (25')		6.1 m (20')		4.6 m (15')		3.0 m (10')	
		Cf	Cs	Cf	Cs	Cf	Cs	Cf	Cs	Cf	Cs	Cf	Cs
Arm length 2900 mm (9'6")													
9.1 m (30')		*9700 (21400)	*9700 (21400)										
6.1 m (20')		*9200 (20200)	8900 (19700)			*13050 (28800)	12850 (28300)						
3.0 m (10')		*10250 (22600)	7200 (15900)	12500 (27600)	8350 (18400)	*15550 (34200)	11800 (26000)	*19550 (43100)	17400 (38400)	*27250 (60100)	*27250 (60100)		
0 m (0')		11200 (24600)	7300 (16100)	11950 (26400)	7800 (17300)	16400 (36100)	10750 (23700)	*21200 (46800)	14200 (31300)	*31100 (68500)	25150 (55500)		
-3.0 m (-10')		*13150 (28900)	9600 (21100)			*14850 (32700)	10650 (23500)	*18850 (41600)	14200 (31300)	*26400 (58200)	25250 (55700)	*32450 (71600)	*32450 (71600)

* Load is limited by hydraulic capacity rather than tipping.
Ratings are based on SAE Standard NO. J1097. Rated loads do not exceed 87% of hydraulic lift capacity or 75% of tipping load.

PC650LC-8E0 (for USA)

Conditions:

Boom: 7660mm (25'2"), Bucket (SAE): 2.70 m³ (3.53 cu.yd), Shoes: 750 mm (29.5") unit: kg (lb)

B	A	MAX		9.1 m (29')		7.6 m (24')		6.1 m (20')		4.6 m (15')		3.0 m (9')	
		Cf	Cs	Cf	Cs	Cf	Cs	Cf	Cs	Cf	Cs	Cf	Cs
Arm length 3500 mm (11'6")													
	9.1 m (29')	*8600 (18900)	*8600 (18900)										
	6.1 m (20')	*8450 (18600)	*8450 (18600)	*12350 (27200)	11500 (25400)	*13650 (30100)	*13650 (30100)						
	3.0 m (9')	*9300 (20500)	7500 (16500)	*14150 (31200)	10700 (23600)	*16900 (37200)	14400 (31700)	*21300 (47000)	20150 (44400)				
	0 m (0')	10950 (24100)	7500 (16500)	14550 (32100)	10000 (22000)	*18950 (41800)	13100 (28900)	*24700 (54500)	18550 (40900)	*19800 (43700)	*19800 (43700)		
	-3.0 m (-9')	*13000 (28600)	8950 (19700)	14400 (31700)	9850 (21700)	*18150 (40000)	12800 (28200)	*23200 (51200)	18300 (40400)	*30100 (66400)	29700 (65500)	*23250 (51300)	*23250 (51300)
	-6.1 m (-20')	*12350 (27300)	*12350 (27300)					*15350 (33900)	*15350 (33900)	*20050 (44200)	*20050 (44200)		

Conditions:

Boom: 7660 mm (25'2"), Bucket (SAE): 2.30 m³ (3.00 cu.yd), Shoes: 750 mm (29.5") unit: kg (lb)

B	A	MAX		9.1 m (29')		7.6 m (24')		6.1 m (20')		4.6 m (15')		3.0 m (9')	
		Cf	Cs	Cf	Cs	Cf	Cs	Cf	Cs	Cf	Cs	Cf	Cs
Arm length 4300 mm (14'1")													
	9.1 m (29')	*6600 (14500)	*6600 (14500)	*9000 (19800)	*9000 (19800)								
	6.1 m (20')	*6450 (14200)	*6450 (14200)	*11200 (24700)	*11200 (24700)								
	3.0 m (9')	*7000 (15500)	6600 (14500)	*13250 (29200)	10750 (23700)	*15650 (34500)	14600 (32100)	*19750 (43500)	*19750 (43500)	*27750 (61200)	*27750 (61200)		
	0 m (0')	*8500 (18700)	6550 (14400)	14450 (31900)	9900 (21800)	*18400 (40600)	13150 (29000)	*23950 (52800)	18500 (40800)	*21700 (47800)	*21700 (47800)		
	-3.0 m (-9')	11200 (24700)	7600 (16800)	14100 (31100)	9550 (21000)	*18400 (40500)	12500 (27600)	*23700 (52300)	17900 (39500)	*31650 (69700)	29000 (64000)	*20200 (44500)	*20200 (44500)
	-6.1 m (-20')	*11900 (26200)	11500 (25400)			*13950 (30700)	*13150 (28900)	*18250 (40200)	*18250 (40200)	*23550 (52000)	*23550 (52000)	*31250 (69000)	*31250 (69000)

Conditions:

Boom: 7660 mm (25'2"), Bucket (SAE): 2.00 m³ (2.62 cu.yd), Shoes: 750 mm (29.5") unit: kg (lb)

B	A	MAX		9.1 m (29')		7.6 m (24')		6.1 m (20')		4.6 m (15')		3.0 m (9')	
		Cf	Cs	Cf	Cs	Cf	Cs	Cf	Cs	Cf	Cs	Cf	Cs
Arm length 5200 mm (17'1")													
	9.1 m (29')	*4900 (10800)	*4900 (10800)										
	6.1 m (20')	*4800 (10600)	*4800 (10600)										
	3.0 m (9')	*5150 (11400)	*5150 (11400)	*12200 (26900)	11000 (24300)	*14250 (31400)	*14250 (31400)	*17550 (38700)	*17550 (38700)	*23850 (52600)	*23850 (52600)		
	0 m (0')	*6150 (13600)	5700 (12500)	*14350 (31600)	9950 (22000)	*17600 (38800)	13350 (29400)	*22900 (50500)	18850 (41600)	*25000 (55100)	*25000 (55100)		
	-3.0 m (-9')	*8300 (18300)	6450 (14200)	13950 (30800)	9400 (20800)	*18550 (40900)	12450 (27400)	*24100 (53100)	17800 (39200)	*29300 (64700)	28750 (63400)	*17700 (39000)	*17700 (39000)
	-6.1 m (-20')	*11500 (24500)	9000 (19900)	*12200 (26900)	9600 (21200)	*15950 (35200)	12700 (28000)	*20550 (45300)	18050 (39800)	*27050 (59600)	*27050 (59600)	*31000 (68400)	*31000 (68400)

* Load is limited hydraulic capacity rather than tipping.
 Ratings are based on ISO Standard No.10567. Rated loads do not exceed 87% of hydraulic lift capacity or 75% of tipping load.

PC650LC-8E0 (for USA)

Conditions:

Boom: 7660 mm (25'2"), Bucket (SAE): 2.70 m³ (3.53 cu.yd), Shoes: 900 mm (35.5") unit: kg (lb)

B	A	MAX		9.1 m (29')		7.6 m (24')		6.1 m (20')		4.6 m (15')		3.0 m (9')	
		Cf	Cs	Cf	Cs	Cf	Cs	Cf	Cs	Cf	Cs	Cf	Cs
Arm length 3500 mm (11'6")													
	9.1 m (29')	*8600 (18900)	*8600 (18900)										
	6.1 m (20')	*8450 (18600)	*8450 (18600)	*12350 (27200)	11650 (25700)	*13650 (30100)	*13650 (30100)						
	3.0 m (9')	*9300 (20500)	7600 (16800)	*14150 (31200)	10850 (23900)	*16900 (37200)	14600 (32200)	*21300 (47000)	20400 (45000)				
	0 m (0')	11100 (24500)	7600 (16800)	14750 (32600)	10150 (22400)	*18950 (41800)	13300 (29300)	*24700 (54500)	18800 (41500)	*19800 (43700)	*19800 (43700)		
	-3.0 m (-9')	*13000 (28600)	9100 (20000)	*14450 (31900)	10000 (22000)	*18150 (40000)	13000 (28700)	*23200 (51200)	18600 (41000)	*30100 (66400)	*30100 (66400)	*23250 (51300)	*23250 (51300)
	-6.1 m (-20')	*12350 (27300)	*12350 (27300)					*15350 (33900)	*15350 (33900)	*20050 (44200)	*20050 (44200)		

Conditions:

Boom: 7660 mm (25'2"), Bucket (SAE): 2.30 m³ (3.00 cu.yd), Shoes: 900 mm (35.5") unit: kg (lb)

B	A	MAX		9.1 m (29')		7.6 m (24')		6.1 m (20')		4.6 m (15')		3.0 m (9')	
		Cf	Cs	Cf	Cs	Cf	Cs	Cf	Cs	Cf	Cs	Cf	Cs
Arm length 4300 mm (14'1")													
	9.1 m (29')	*6600 (14500)	*6600 (14500)	*9000 (19800)	*9000 (19800)								
	6.1 m (20')	*6450 (14200)	*6450 (14200)	*11200 (24700)	*11200 (24700)								
	3.0 m (9')	*7000 (15500)	6700 (14800)	*13250 (29200)	10900 (24100)	*15650 (34500)	14800 (32600)	*19750 (43500)	*19750 (43500)	*27750 (61200)	*27750 (61200)		
	0 m (0')	*8500 (18700)	6650 (14700)	14700 (32400)	10050 (22100)	*18400 (40600)	13350 (29400)	*23950 (52800)	18800 (41400)	*21700 (47800)	*21700 (47800)		
	-3.0 m (-9')	11400 (25200)	7750 (17100)	14300 (31600)	9700 (21400)	*18400 (40500)	12700 (28000)	*23700 (52300)	18200 (40100)	*31650 (69700)	29450 (64900)	*20200 (44500)	*20200 (44500)
	-6.1 m (-20')	*11900 (26200)	11700 (25800)			*13950 (30700)	13350 (29400)	*18250 (40200)	*18250 (40200)	*23550 (52000)	*23550 (52000)	*31250 (69000)	*31250 (69000)

Conditions:

Boom: Boom: 7660 mm (25'2"), Bucket (SAE): 2.00 m³ (3.00 cu.yd), Shoes: 900 mm (35.5") unit: kg (lb)

B	A	MAX		9.1 m (29')		7.6 m (24')		6.1 m (20')		4.6 m (15')		3.0 m (9')	
		Cf	Cs	Cf	Cs	Cf	Cs	Cf	Cs	Cf	Cs	Cf	Cs
Arm length 5200 mm (17'1")													
	9.1 m (29')	*4900 (10800)	*4900 (10800)										
	6.1 m (20')	*4800 (10600)	*4800 (10600)										
	3.0 m (9')	*5150 (11400)	*5150 (11400)	*12200 (26900)	11150 (24600)	*14250 (31400)	*14250 (31400)	*17550 (38700)	*17550 (38700)	*23850 (52600)	*23850 (52600)		
	0 m (0')	*6150 (13600)	5800 (12800)	*14350 (31600)	10150 (22300)	*17600 (38800)	13550 (29900)	*22900 (50500)	19150 (42200)	*25000 (55100)	*25000 (55100)		
	-3.0 m (-9')	*8300 (18300)	6550 (14500)	14200 (31300)	9600 (21100)	*18550 (40900)	12650 (27900)	*24100 (53100)	18050 (39800)	*29300 (64700)	29150 (64300)	*17700 (39000)	*17700 (39000)
	-6.1 m (-20')	*11500 (24500)	9150 (20200)	*12200 (26900)	9800 (21600)	*15950 (35200)	12900 (28400)	*20550 (45300)	18300 (40400)	*27050 (59600)	*27050 (59600)	*31000 (68400)	*31000 (68400)

* Load is limited hydraulic capacity rather than tipping.
Ratings are based on ISO Standard No.10567. Rated loads do not exceed 87% of hydraulic lift capacity or 75% of tipping load.

PC700LC-8E0, PC700LC-8R

Conditions:

Boom: 7660 mm (25'2"), Bucket (SAE): 2.70 m³ (3.53 cu.yd), Shoes: 610 mm (24")

(Lifting mode: ON)

unit: kg (lb)

B	A	MAX		9.1 m (29')		7.6 m (24')		6.1 m (20')		4.6 m (15')		3.0 m (9')	
		Cf	Cs	Cf	Cs	Cf	Cs	Cf	Cs	Cf	Cs	Cf	Cs
Arm length 3500 mm (11'6")													
9.1 m (29')		*8550 (18900)	*8550 (18900)										
6.1 m (20')		*8450 (18600)	*8450 (18600)	*12250 (27000)	11950 (22300)	*13500 (29700)	*13500 (29700)						
3.0 m (9')		9300 (20500)	7700 (17000)	*14150 (31200)	11100 (24500)	*17000 (37500)	14900 (32900)	*22100 (48700)	21250 (46800)				
0 m (0')		10550 (23300)	7700 (17000)	14200 (31300)	10400 (22900)	18950 (41800)	13850 (30500)	*25100 (55300)	19500 (43000)	*20150 (44400)	*20150 (44400)		
-3.0 m (-9')		12500 (27600)	9150 (20000)	14000 (30900)	10250 (22500)	*18600 (41000)	13550 (29900)	*23650 (52100)	19300 (42500)	*30400 (67100)	*30400 (67100)	*17400 (38300)	*17400 (38300)
-6.1 m (-20')		*12350 (27300)	*12350 (27300)			*11150 (24600)	*11150 (24600)	*16350 (36000)	*16350 (36000)	*20650 (45600)	*20650 (45600)		

Conditions:

Boom: 7300 mm (23'11"), Bucket (SAE): 2.80 m³ (3.66 cu.yd), Shoes: 610 mm (24")

(Lifting mode: ON)

unit: kg (lb)

B	A	MAX		9.1 m (29')		7.6 m (24')		6.1 m (20')		4.6 m (15')		3.0 m (9')	
		Cf	Cs	Cf	Cs	Cf	Cs	Cf	Cs	Cf	Cs	Cf	Cs
Arm length 3500 mm (11'6")													
9.1 m (29')		*8150 (17900)	*8150 (17900)										
6.1 m (20')		*7950 (17600)	*7950 (17600)	*12150 (26800)	11550 (25400)	*13200 (29100)	*13200 (29100)						
3.0 m (9')		*8900 (19700)	7900 (17400)	*13950 (30700)	10800 (23800)	*16700 (36800)	14750 (32500)	*21550 (47500)	*21050 (46400)	*26500 (58400)	*26500 (58400)		
0 m (0')		10950 (24100)	7900 (17500)	13950 (30700)	10150 (22300)	18800 (41500)	13650 (30100)	*24850 (54800)	19500 (43000)	*17800 (39300)	*17800 (39300)		
-3.0 m (-9')		13250 (29300)	9650 (21200)	13800 (30400)	10000 (22100)	*18150 (40100)	13350 (29500)	*23450 (51700)	19200 (42300)	*30700 (67700)	*30700 (67700)	*23750 (52400)	*23750 (52400)
-6.1 m (-20')		*12450 (27400)	*12450 (27400)					*14750 (32600)	*14750 (32600)	*19500 (43000)	*19500 (43000)		

Conditions:

Boom: 6600 mm (21'8"), Bucket (SAE): 3.50 m³ (4.58 cu.yd), Shoes: 610 mm (24")

(Lifting mode: ON)

unit: kg (lb)

B	A	MAX		9.1 m (29')		7.6 m (24')		6.1 m (20')		4.6 m (15')		3.0 m (9')	
		Cf	Cs	Cf	Cs	Cf	Cs	Cf	Cs	Cf	Cs	Cf	Cs
Arm length 2900 mm (9'6")													
9.1 m (29')		*11800 (26000)	*11800 (26000)										
6.1 m (20')		*10950 (24100)	*10950 (24100)	*10750 (23700)	*10750 (23700)	*14500 (32000)	*14500 (32000)						
3.0 m (9')		*11950 (26300)	9450 (20800)	14500 (31900)	10600 (23400)	*17450 (38400)	14600 (32100)	*22300 (49200)	21350 (47000)	*30100 (66300)	*30100 (66300)		
0 m (0')		13150 (29000)	9550 (21000)	13900 (30600)	10100 (22200)	18850 (41600)	13650 (30100)	*24900 (54900)	19650 (43300)	*26550 (58500)	*26550 (58500)		
-3.0 m (-9')		*14550 (32100)	12300 (27100)			*16600 (36600)	13550 (29900)	*22300 (49100)	19450 (42900)	*29300 (64600)	*29300 (64600)	*27200 (60000)	*27200 (60000)

* Load is limited hydraulic capacity rather than tipping.

Ratings are based on SAE Standard No. J1097. Rated loads do not exceed 87% of hydraulic lift capacity or 75% of tipping load.

PC700LC-8E0 (UK source)

Conditions: Boom: 6600 mm, Bucket (SAE): 3.5 m³, Shoes: 610 mm
(Lifting mode: OFF)

unit: kg

B	A	MAX		9.0 m		7.5 m		6.0 m		4.5 m		3.0 m	
		Cf	Cs	Cf	Cs	Cf	Cs	Cf	Cs	Cf	Cs	Cf	Cs
Arm length 2900 mm													
	9.1 m	*9700	*9700										
	6.1 m	*8960	*8960	*8780	*8780	*11590	*11590						
	3.0 m	*9810	9460	*11590	10640	*13930	*13930	*18000	*18000	*24410	*24410		
	0 m	*11370	9570	*11990	10100	*15250	13690	*20040	19650	*26580	*26580		
	-3.0 m	*11370	*11370			*13090	*13090	*17780	*17780	*23560	*23560	*22590	*22590
	-6.1 m												

(Lifting mode: ON)

unit: kg

	9.1 m	*11830	*11830										
	6.1 m	*10970	*10970	*10770	*10770	*14530	*14530						
	3.0 m	*11950	9460	14500	10640	*17460	14600	*22320	21350	*30100	*30100		
	0 m	13180	9570	13920	10100	18880	13690	*24920	19650	*26580	*26580		
	-3.0 m	*14580	12320			*16640	13580	*22300	19480	*29330	*29330	*27240	*27240
	-6.1 m												

Conditions: Boom: 7300 mm, Bucket (SAE): 2.7 m³, Shoes: 610 mm
(Lifting mode: OFF)

unit: kg

B	A	MAX		9.0 m		7.5 m		6.0 m		4.5 m		3.0 m	
		Cf	Cs	Cf	Cs	Cf	Cs	Cf	Cs	Cf	Cs	Cf	Cs
Arm length 3500 mm													
	9.1 m	*6500	*6500										
	6.1 m	*6350	*6350	*9550	*9550	*10500	*10500						
	3.0 m	*7200	*7200	*11000	10800	*13300	*13300	*17350	*17350	*24100	*24100		
	0 m	*9200	7900	*12050	10150	*15150	13650	*20000	19500	*14600	*14600		
	-3.0 m	*10350	9650	*10900	10000	*14400	13350	*18750	*18750	*24750	*24750	*19650	*19650
	-6.1 m	*9500	*9500					*11450	*11450	*15250	*15250		

(Lifting mode: ON)

unit: kg

	9.1 m	*8150	*8150										
	6.1 m	*7950	*7950	*12150	11550	*13200	*13200						
	3.0 m	*8900	7900	*13950	10800	*16700	14750	*21550	21050	*26500	*26500		
	0 m	10950	7900	13950	10150	18800	13650	*24850	19500	*17800	*17800		
	-3.0 m	13250	9650	13800	10000	*18150	13350	*23450	19200	*30700	*30700	*23750	*23750
	-6.1 m	*12450	*12450					*14750	*14750	*19500	*19500		*12450

Conditions: Boom: 7600 mm, Bucket (SAE): 2.4 m³, Shoes: 610 mm
(Lifting mode: OFF)

unit: kg

B	A	MAX		9.0 m		7.5 m		6.0 m		4.5 m		3.0 m	
		Cf	Cs	Cf	Cs	Cf	Cs	Cf	Cs	Cf	Cs	Cf	Cs
Arm length 3500 mm													
	9.1 m	*6950	*6950										
	6.1 m	*6850	*6850	*9700	*9700	*10800	*10800						
	3.0 m	*7600	*7600	*11250	11100	*13600	*13600	*17850	*17850				
	0 m	*9400	7700	*12350	10400	*15400	13850	*20200	19500	*16850	*16850		
	-3.0 m	*10150	9150	*11600	10250	*14800	13550	*18950	*18950	*24500	*24500	*14350	*14350
	-6.1 m	*9500	*9500			*8550	*8550	*12800	*12800	*16300	*16300		

(Lifting mode: ON)

unit: kg

	9.1 m	*8550	*8550										
	6.1 m	*8450	*8450	*12250	11950	*13500	*13500						
	3.0 m	*9300	7700	*14150	11100	*17000	14900	*22100	21250				
	0 m	10550	7700	14200	10400	18950	13850	*25100	19500	*20150	*20150		
	-3.0 m	12500	9150	14000	10250	*18600	13550	*23650	19300	*30400	*30400	*17400	*17400
	-6.1 m	*12350	*12350			*11150	*11150	*16350	*16350	*20650	*20650		

* Load is limited hydraulic capacity rather than tipping.

Ratings are based on SAE Standard No. J1097. Rated loads do not exceed 87% of hydraulic lift capacity or 75% of tipping load.

PC750-7

Conditions: Boom: 8200 mm (26'11"), Bucket (SAE): 3.1 m³ (4.05 cu.yd), Shoes: 610 mm (24")

(Heavy-lifting: "OFF")

unit: kg (lb)

B	A	MAX		9.0 m (29')		7.5 m (24')		6.0 m (19')		4.5 m (14')		3.0 m (9')	
		Cf	Cs	Cf	Cs	Cf	Cs	Cf	Cs	Cf	Cs	Cf	Cs
Arm length 3600 mm (11'10")													
6.0 m (19')		*9350 (20600)	*8650 (19100)	*12950 (28500)	12700 (28000)	*15150 (33400)	*15150 (33400)	*18900 (41700)	*18900 (41700)				
3.0 m (9')		9650 (21300)	7350 (16200)	14750 (32500)	11400 (25200)	*18450 (40700)	14850 (32800)	*25700 (56700)	21900 (48300)				
0 m (0')		9800 (21600)	7350 (16200)	13750 (30300)	10450 (23000)	18550 (40900)	14100 (31000)	26900 (59300)	20100 (44300)				
-3.0 m (-9')		12000 (26500)	9100 (20000)	13500 (29800)	10250 (22600)	18300 (40300)	13850 (30500)	*24850 (54800)	20150 (44500)	*29350 (64700)	*29350 (64700)	*21350 (47100)	*21350 (47100)
-6.0 m (-19')		*14350 (31600)	*14350 (31600)					*17000 (37500)	*17000 (37500)				

(Heavy-lifting: "ON")

unit: kg (lb)

B	A	MAX		9.0 m (29')		7.5 m (24')		6.0 m (19')		4.5 m (14')		3.0 m (9')	
		Cf	Cs	Cf	Cs	Cf	Cs	Cf	Cs	Cf	Cs	Cf	Cs
Arm length 3600 mm (11'10")													
6.0 m (19')		*10550 (23300)	8650 (19100)	*14800 (32700)	12700 (28000)	*17250 (38000)	*17250 (38000)	*21350 (47100)	*21350 (47100)				
3.0 m (9')		9650 (21300)	7350 (16200)	14750 (32500)	11400 (25200)	19400 (42800)	14850 (32800)	28850 (63700)	21900 (48300)				
0 m (0')		9800 (21600)	7350 (16200)	13750 (30300)	10450 (23000)	18550 (40900)	14100 (31000)	26900 (59300)	20100 (44300)				
-3.0 m (-9')		12000 (26500)	9100 (20000)	13500 (29800)	10250 (22600)	18300 (40300)	13850 (30500)	26950 (59500)	20150 (44500)	*32500 (71700)	*32500 (71700)	*23750 (52300)	*23750 (52300)
-6.0 m (-19')		*16650 (36800)	*16650 (36800)					*19700 (43400)	*19700 (43400)				

Conditions: Boom: 8200 mm (26'11"), Bucket (SAE): 2.8 m³ (3.66 cu.yd), Shoes: 610 mm (24")

(Heavy-lifting: "OFF")

unit: kg (lb)

B	A	MAX		12.0 m (39')		9.0 m (29')		7.5 m (24')		6.0 m (19')		4.5 m (14')		3.0 m (9')	
		Cf	Cs	Cf	Cs	Cf	Cs	Cf	Cs	Cf	Cs	Cf	Cs	Cf	Cs
Arm length 4600 mm (15'1")															
6.0 m (19')		*7500 (16600)	7500 (16500)			*11500 (25400)	*11500 (25400)								
3.0 m (9')		8450 (18700)	6350 (14000)	8650 (19000)	6500 (14300)	*14150 (31200)	11650 (25700)	*17500 (38600)	15950 (35200)	*23400 (51600)	22950 (50600)				
0 m (0')		8450 (18600)	6250 (13800)			13700 (30200)	10400 (23000)	18600 (41000)	14100 (31100)	*27000 (59500)	20200 (44500)	*13600 (30000)	*13600 (30000)		
-3.0 m (-9')		10000 (22000)	7450 (16400)			13200 (29100)	9900 (21900)	17950 (39600)	13500 (29800)	*25950 (57300)	19700 (43400)	*25600 (56400)	*25600 (56400)	*17800 (39300)	*17800 (39300)
-6.0 m (-19')		*13850 (30500)	12100 (26600)					*15800 (34800)	14000 (30900)	*20350 (44900)	*20350 (44900)	*26300 (58000)	*26300 (58000)		

(Heavy-lifting: "ON")

unit: kg (lb)

B	A	MAX		12.0 m (39')		9.0 m (29')		7.5 m (24')		6.0 m (19')		4.5 m (14')		3.0 m (9')	
		Cf	Cs	Cf	Cs	Cf	Cs	Cf	Cs	Cf	Cs	Cf	Cs	Cf	Cs
Arm length 3600 mm (11'10")															
6.0 m (19')		*8600 (19000)	7500 (16500)			*13250 (29200)	13100 (28900)								
3.0 m (9')		8450 (18700)	6350 (14000)	8650 (19000)	6500 (14300)	15000 (33100)	11650 (25700)	*20000 (44100)	15950 (35200)	*26550 (58600)	22950 (50600)				
0 m (0')		8450 (18600)	6250 (13800)			13700 (30200)	10400 (23000)	18600 (41000)	14100 (31100)	27050 (59600)	20200 (44500)	*15300 (33700)	*15300 (33700)		
-3.0 m (-9')		10000 (22000)	7450 (16400)			13200 (29100)	9900 (21900)	17950 (39600)	13500 (29800)	26450 (58400)	19700 (43400)	*28400 (62600)	*28400 (62600)	*19900 (43800)	*19900 (43800)
-6.0 m (-19')		15900 (35100)	12100 (26600)					*18300 (40300)	14000 (30900)	*23450 (51700)	20500 (45200)	*30200 (66600)	*30200 (66600)		

* Load is limited by hydraulic capacity rather than tipping.

Ratings are based on SAE Standard NO. J1097. Rated loads do not exceed 87% of hydraulic lift capacity or 75% of tipping load.

PC750-7

Conditions: Boom: 8200 mm (26'11"), Bucket (SAE): 2.8 m³ (3.66 cu.yd), Shoes: 610 mm (24")

(Heavy-lifting: "OFF")

unit: kg (lb)

B	A	MAX		12.0 m (39')		9.0 m (29')		7.5 m (24')		6.0 m (19')		4.5 m (14')		3.0 m (9')	
		Cf	Cs	Cf	Cs	Cf	Cs	Cf	Cs	Cf	Cs	Cf	Cs	Cf	Cs
Arm length 5600 mm (18'4")															
6.0 m (19')		*4550 (10000)	*4550 (10000)	*6850 (15100)	*6850 (15100)										
3.0 m (9')		*5300 (11700)	*5300 (11700)	*9500 (20900)	7400 (16300)	*12650 (27900)	*12650 (27900)	*15500 (34200)	*15500 (34200)	*20450 (45100)	*20450 (45100)				
0 m (0')		*6950 (15300)	5800 (12800)	9000 (19800)	6750 (14900)	*15000 (33100)	11600 (25600)	19050 (42000)	15750 (34700)	*25600 (56400)	22550 (49700)	*13650 (30100)	*13650 (30100)		
-3.0 m (-9')		8950 (19700)	6650 (14700)			14250 (31400)	10850 (23900)	19350 (42700)	14700 (32400)	-26100 (57600)	*21350 (47100)	*21100 (46500)	*21100 (46500)	*13900 (30600)	*13900 (30600)
-6.0 m (-19')		*11750 (25900)	9650 (21200)			*13450 (29600)	10950 (24100)	*16550 (36400)	13950 (30800)	*22400 (49400)	21700 (47900)	*29850 (65800)	*29850 (65800)	*25250 (55600)	*25250 (55600)

(Heavy-lifting: "ON")

unit: kg (lb)

B	A	MAX		12.0 m (39')		9.0 m (29')		7.5 m (24')		6.0 m (19')		4.5 m (14')		3.0 m (9')	
		Cf	Cs	Cf	Cs	Cf	Cs	Cf	Cs	Cf	Cs	Cf	Cs	Cf	Cs
Arm length 5600 mm (18'4")															
6.0 m (19')		*5350 (11800)	*5350 (11800)	*7900 (17400)	*7900 (17400)										
3.0 m (9')		*6200 (13700)	5900 (13000)	9650 (21300)	7400 (16300)	*14600 (32200)	13150 (28900)	*17800 (39200)	*17800 (39200)	*23300 (51300)	*23300 (51300)				
0 m (0')		7800 (17200)	5800 (12800)	9000 (19800)	6750 (14900)	15100 (33300)	11600 (25600)	20450 (45100)	15750 (34700)	*29200 (64300)	22550 (49700)	*15350 (33900)	*15350 (33900)		
-3.0 m (-9')		8950 (19700)	6650 (14700)			14250 (31400)	10850 (23900)	19350 (42700)	14700 (32400)	28450 (62800)	21350 (47100)	*23500 (51800)	*23500 (51800)	*15600 (34400)	*15600 (34400)
-6.0 m (-19')		12700 (28000)	9650 (21200)			14400 (31700)	10950 (24100)	18600 (41000)	13950 (30800)	*25750 (56800)	21700 (47900)	*34200 (75400)	*34200 (75400)	*28000 (61800)	*28000 (61800)

* Load is limited by hydraulic capacity rather than tipping.

Ratings are based on SAE Standard NO. J1097. Rated loads do not exceed 87% of hydraulic lift capacity or 75% of tipping load.

PC750-7 (SE spec.)

Conditions: Boom: 7100 mm (23'4"), Bucket (SAE): 4.0 m³ (5.23 cu.yd), Shoes: 610 mm (24")

(Heavy-lifting: "OFF")

unit: kg (lb)

B	A	MAX		9.0 m (29')		7.5 m (24')		6.0 m (19')		4.5 m (14')		3.0 m (9')	
		Cf	Cs	Cf	Cs	Cf	Cs	Cf	Cs	Cf	Cs	Cf	Cs
Arm length 2920 mm (9'7")													
6.0 m (19')		*13600 (30000)	10850 (23900)	*13800 (30400)	11600 (25600)	*15600 (34400)	*15600 (34400)	*18800 (41500)	*18800 (41500)				
3.0 m (9')		11800 (26000)	8900 (19600)	14100 (31100)	10750 (23700)	*19050 (42000)	15100 (33300)	*25300 (55800)	21950 (48400)				
0 m (0')		12250 (27000)	9200 (20300)	13350 (29400)	10050 (22100)	18350 (40400)	13850 (30500)	27000 (59600)	20150 (44400)	*27550 (60800)	*27550 (60800)		
-3.0 m (-9')		*16000 (35200)	12800 (28200)			*17500 (38600)	13950 (30800)	*23150 (51000)	20450 (45100)	*29900 (66000)	*29900 (66000)	*37500 (82700)	*37500 (82700)

(Heavy-lifting: "ON")

unit: kg (lb)

B	A	MAX		9.0 m (29')		7.5 m (24')		6.0 m (19')		4.5 m (14')		3.0 m (9')	
		Cf	Cs	Cf	Cs	Cf	Cs	Cf	Cs	Cf	Cs	Cf	Cs
Arm length 2920 mm (9'7")													
6.0 m (19')		14050 (31000)	10850 (23900)	15000 (33100)	11600 (25600)	*17800 (39300)	16950 (37400)	*21350 (47100)	*21350 (47100)				
3.0 m (9')		11800 (26000)	8900 (19600)	14100 (31100)	10750 (23700)	19650 (43300)	15100 (33300)	*28750 (63400)	21950 (48400)				
0 m (0')		12250 (27000)	9200 (20300)	13350 (29400)	10050 (22100)	18350 (40400)	13850 (30500)	27000 (59600)	20150 (44400)	*30600 (67400)	*30600 (67400)		
-3.0 m (-9')		16900 (37200)	12800 (28200)			18450 (40700)	13950 (30800)	*26500 (58400)	20450 (45100)	*34200 (75400)	*34200 (75400)	*42950 (94600)	*42950 (94600)

* Load is limited by hydraulic capacity rather than tipping. Ratings are based on SAE Standard NO. J1097. Rated loads do not exceed 87% of hydraulic lift capacity or 75% of tipping load.

PC800-8E0, PC800-8R1

Conditions: Boom: 8200 mm (26'11"), Bucket (SAE): 3.1 m³ (4.05cu.yd), Shoes: 610 mm (24")

(Heavy Lift mode: OFF)

unit: kg (lb)

B	A	MAX		9.0 m (29')		7.5 m (24')		6.0 m (19')		4.5 m (14')		3.0 m (9')	
		Cf	Cs	Cf	Cs	Cf	Cs	Cf	Cs	Cf	Cs	Cf	Cs
Arm length 3600 mm (11'10")													
6.0 m (19')		*7750 (17100)	*7750 (17100)	*12250 (27000)	*12250 (27000)	*14050 (31000)	*14050 (31000)						
3.0 m (9')		*9050 (20000)	7150 (15800)	*14600 (32200)	12100 (26700)	*17950 (39600)	16300 (35900)	*23900 (52700)	23000 (50700)				
0 m (0')		9350 (20600)	7050 (15550)	14200 (31300)	10850 (23900)	19000 (41900)	14450 (31900)	*21700 (47800)	20400 (45000)	*13550 (29900)	*13550 (29900)		
-3.0 m (-9')		11050 (24400)	8350 (18400)	13800 (30400)	10450 (23000)	18500 (40800)	13950 (30800)	*22450 (49500)	20100 (44300)	*20300 (44800)	*20300 (44800)	*19100 (42100)	*19100 (42100)
-6.0 m (-19')		*13800 (30400)	13600 (30000)			*14900 (32800)	14750 (32500)	*19100 (42100)	*19100 (42100)	*22500 (49600)	*22500 (49600)		

(Heavy Lift mode: ON)

unit: kg (lb)

B	A	MAX		9.0 m (29')		7.5 m (24')		6.0 m (19')		4.5 m (14')		3.0 m (9')	
		Cf	Cs	Cf	Cs	Cf	Cs	Cf	Cs	Cf	Cs	Cf	Cs
Arm length 3600 mm (11'10")													
6.0 m (19')		*8800 (19400)	8400 (18500)	*14000 (30900)	13700 (30200)	*16000 (35300)	*16000 (35300)						
3.0 m (9')		9350 (20700)	7150 (15700)	15550 (34300)	12100 (26700)	*20500 (45200)	16300 (36000)	*26900 (59300)	23000 (50800)				
0 m (0')		9350 (20600)	7050 (15550)	14200 (31400)	10850 (23900)	19000 (41900)	14450 (31900)	*21700 (47900)	20400 (45000)	*15100 (33300)	*15100 (33300)		
-3.0 m (-9')		11050 (24300)	8350 (18400)	13800 (30400)	10450 (23000)	18500 (40800)	13950 (30800)	*22450 (49500)	20100 (44400)	*20300 (44700)	*20300 (44700)	*21200 (46700)	*21200 (46700)
-6.0 m (-19')		*16050 (35400)	13600 (30000)			*17250 (38100)	14750 (32500)	*22050 (48600)	21250 (46800)	*22500 (49600)	*22500 (49600)		

Conditions: Boom: 8200 mm (26'11"), Bucket (SAE): 2.8 m³ (3.66cu.yd), Shoes: 610 mm (24")

(Heavy Lift mode: OFF)

unit: kg (lb)

B	A	MAX		12.0 m (39')		9.0 m (29')		7.5 m (24')		6.0 m (19')		4.5 m (14')		3.0 m (9')	
		Cf	Cs	Cf	Cs	Cf	Cs	Cf	Cs	Cf	Cs	Cf	Cs	Cf	Cs
Arm length 4600 mm (15'1")															
6.0 m (19')		*6400 (14100)	*6400 (14100)	*7900 (17400)	7800 (17200)	*10750 (23700)	*10750 (23700)								
3.0 m (9')		*7350 (16200)	6150 (13500)	9400 (20700)	7150 (15800)	*13400 (29500)	12450 (27500)	*16350 (36000)	*16350 (36000)	*21400 (47200)	*21400 (47200)				
0 m (0')		8050 (17800)	6000 (13200)	8750 (19300)	6550 (14400)	14350 (31600)	10950 (24100)	19300 (42500)	14700 (32400)	*25950 (57200)	20800 (45900)	*14600 (32200)	*14600 (32200)		
-3.0 m (-9')		9200 (20300)	6850 (15100)			13600 (30000)	10250 (22600)	18300 (40300)	13750 (30300)	*26050 (57400)	19800 (43700)	*23500 (51800)	*23500 (51800)	*15950 (35100)	*15950 (35100)
-6.0 m (-19')		*12650 (27900)	10050 (22200)			*13300 (29300)	10500 (23200)	*17100 (37700)	14050 (31000)	*21850 (48100)	20400 (45000)	*28600 (63100)	*28600 (63100)	*27150 (59900)	*27150 (59900)

(Heavy Lift mode: ON)

unit: kg (lb)

B	A	MAX		12.0 m (39')		9.0 m (29')		7.5 m (24')		6.0 m (19')		4.5 m (14')		3.0 m (9')	
		Cf	Cs	Cf	Cs	Cf	Cs	Cf	Cs	Cf	Cs	Cf	Cs	Cf	Cs
Arm length 4600 mm (15'1")															
6.0 m (19')		*7350 (16200)	7200 (15800)	*9000 (19800)	7800 (17200)	*12350 (27300)	*12350 (27300)								
3.0 m (9')		8150 (18000)	6150 (13500)	9400 (20700)	7150 (15800)	*15400 (34000)	12450 (27500)	*18700 (41200)	17000 (37500)	*24350 (53700)	*24350 (53700)				
0 m (0')		8050 (17800)	6000 (13200)	8750 (19300)	6550 (14400)	14350 (31600)	10950 (24100)	19300 (42500)	14700 (32400)	27800 (61300)	20800 (45900)	*16300 (36000)	*16300 (36000)		
-3.0 m (-9')		9200 (20300)	6850 (15100)			13600 (30000)	10250 (22600)	18300 (40300)	13750 (30300)	26750 (58900)	19800 (43700)	*26000 (57400)	*26000 (57400)	*17750 (39200)	*17750 (39200)
-6.0 m (-19')		13300 (29300)	10050 (22200)			13900 (30600)	10500 (23200)	18650 (41100)	14050 (31000)	*25150 (55400)	20400 (45000)	*30800 (67900)	*30800 (67900)	*27150 (59900)	*27150 (59900)

* Load is limited hydraulic capacity rather than tipping.

Ratings are based on ISO standard No.10567. Rated loads do not exceed 87% of hydraulic lift capacity or 75% of tipping load.

PC800-8E0, PC800-8R1

Conditions: Boom: 8200 mm (26'11"), Bucket (SAE): 2.8 m³ (3.66cu.yd), Shoes: 610 mm (24")

(Heavy Lift mode: OFF)

unit: kg (lb)

B	A	MAX		12.0 m (39')		9.0 m (29')		7.5 m (24')		6.0 m (19')		4.5 m (14')		3.0 m (9')	
		Cf	Cs	Cf	Cs	Cf	Cs	Cf	Cs	Cf	Cs	Cf	Cs	Cf	Cs
Arm length 5600 mm (18'4")															
6.0 m (19')		*4050 (8900)	*4050 (8900)	*7050 (15500)	*7050 (15500)										
3.0 m (9')		*4550 (10000)	*4550 (10000)	*9100 (20100)	7100 (15700)	*11800 (26100)	*11800 (26100)	*14250 (31500)	*14250 (31500)	*18400 (40600)	*18400 (40600)				
0 m (0')		*5650 (12500)	4750 (10500)	8500 (18800)	6300 (13900)	14250 (31400)	10850 (23900)	*18050 (39800)	14700 (32400)	*24200 (53300)	21000 (46300)	*15150 (33400)	*15150 (33400)		
-3.0 m (-9')		7400 (16300)	5350 (11800)	8050 (17800)	5850 (12900)	13150 (29000)	9800 (21600)	17850 (39300)	13300 (29300)	*25700 (56600)	19200 (42300)	*20100 (44300)	*20100 (44300)	*12850 (28400)	*12850 (28400)
-6.0 m (-19')		9950 (21900)	7350 (16200)			13100 (28900)	9750 (21500)	17750 (39100)	13200 (29100)	*23100 (51000)	19300 (42600)	*24300 (53600)	*24300 (53600)	*22250 (49000)	*22250 (49000)

(Heavy Lift mode: ON)

unit: kg (lb)

B	A	MAX		12.0 m (39')		9.0 m (29')		7.5 m (24')		6.0 m (19')		4.5 m (14')		3.0 m (9')	
		Cf	Cs	Cf	Cs	Cf	Cs	Cf	Cs	Cf	Cs	Cf	Cs	Cf	Cs
Arm length 5600 mm (18'4")															
6.0 m (19')		*4750 (10500)	*4750 (10500)	*8050 (17800)	7900 (17400)										
3.0 m (9')		*5350 (11800)	4950 (10900)	9350 (20600)	7100 (15700)	*13650 (30200)	12650 (27900)	*16400 (36100)	*16400 (36100)	*20950 (46200)	*20950 (46200)				
0 m (0')		*6550 (14500)	4750 (10500)	8500 (18800)	6300 (13900)	14250 (31400)	10850 (23900)	19350 (42600)	14700 (32400)	*27650 (61000)	21000 (46300)	*16900 (37300)	*16900 (37300)		
-3.0 m (-9')		7400 (16300)	5350 (11800)	8050 (17800)	5850 (12900)	13150 (29000)	9800 (21600)	17850 (39300)	13300 (29300)	26100 (57600)	19200 (42300)	*22300 (49200)	*22300 (49200)	*14400 (31800)	*14400 (31800)
-6.0 m (-19')		9950 (21900)	7350 (16200)			13100 (28900)	9750 (21500)	17750 (39100)	13200 (29100)	26200 (57800)	19300 (42600)	*24300 (53600)	*24300 (53600)	*22250 (49000)	*22250 (49000)

* Load is limited hydraulic capacity rather than tipping.

Ratings are based on ISO standard No.10567. Rated loads do not exceed 87% of hydraulic lift capacity or 75% of tipping load.

PC800-8E0 (SE spec.), PC800-8R1 (SE spec.)

Conditions: Boom: 7100 mm (23'4"), Bucket (SAE): 4.0 m³ (5.23 cu.yd), Shoes: 610 mm (24")

(Heavy Lift mode: OFF)

unit: kg (lb)

B	A	MAX		9.0 m (29')		7.5 m (24')		6.0 m (19')		4.5 m (14')		3.0 m (9')	
		Cf	Cs	Cf	Cs	Cf	Cs	Cf	Cs	Cf	Cs	Cf	Cs
Arm length 2900 mm (9'8")													
6.0 m (19')		*12300 (27100)	10100 (22300)	*12800 (28200)	12450 (27400)	*14400 (31700)	*14400 (31700)						
3.0 m (9')		11050 (24400)	8300 (18300)	14650 (32300)	11200 (24700)	*17850 (39400)	15600 (34400)	*23450 (51700)	22750 (50200)				
0 m (0')		11300 (24900)	8400 (18500)	13600 (30000)	10200 (22500)	18550 (40900)	13950 (30800)	*26250 (57900)	20150 (44400)	*28600 (63100)	*28600 (63100)		
-3.0 m (-9')		*14550 (32000)	11100 (24500)			*18000 (39700)	13800 (30400)	*23550 (51900)	20150 (44400)	*31050 (68500)	*31050 (68500)	*31800 (70100)	*31800 (70100)

(Heavy Lift mode: ON)

unit: kg (lb)

B	A	MAX		9.0 m (29')		7.5 m (24')		6.0 m (19')		4.5 m (14')		3.0 m (9')	
		Cf	Cs	Cf	Cs	Cf	Cs	Cf	Cs	Cf	Cs	Cf	Cs
Arm length 2900 mm (9'8")													
6.0 m (19')		13150 (28900)	10100 (22300)	*14800 (32600)	12450 (27400)	*16500 (36400)	*16500 (36400)						
3.0 m (9')		11050 (24400)	8300 (18400)	14650 (32300)	11200 (24700)	20350 (44900)	15600 (34400)	*26750 (58900)	22750 (50100)				
0 m (0')		11300 (24900)	8400 (18600)	13600 (30000)	10200 (22500)	18550 (40900)	13950 (30800)	27200 (59900)	20150 (44400)	*31350 (69100)	*31350 (69100)		
-3.0 m (-9')		14800 (32600)	11100 (24500)			18400 (40600)	13800 (30400)	*27050 (59600)	20150 (44400)	*32200 (71000)	*32200 (71000)	*31800 (70100)	*31800 (70100)

* Load is limited hydraulic capacity rather than tipping.
Ratings are based on ISO standard No.10567. Rated loads do not exceed 87% of hydraulic lift capacity or 75% of tipping load.

PC800-8E0 (UK source)

Conditions: Boom: 7100 mm, Bucket (SAE): 4.0 m³, Shoes: 610 mm
(Heavy Lift mode: OFF)

unit: kg

B	A	MAX		9.0 m		7.5 m		6.0 m		4.5 m		3.0 m	
		Cf	Cs	Cf	Cs	Cf	Cs	Cf	Cs	Cf	Cs	Cf	Cs
Arm length 2900 mm													
	9.0 m	*12620	*12620										
	6.0 m	*12310	11260	*12630	*12630	*14150	*14150						
	3.0 m	12260	9410	*14570	12400	*18010	17350	*23540	*23540				
	0 m	12560	9550	15060	11510	*20040	15770	*26730	22930	*28630	*28630		
	-3.0 m	*14560	12470			*18280	15540	*24040	*22790	*31560	*31560	*29820	*29820
	-6.0 m												

(Heavy Lift mode: ON)

unit: kg

B	A	MAX		9.0 m		7.5 m		6.0 m		4.5 m		3.0 m	
		Cf	Cs	Cf	Cs	Cf	Cs	Cf	Cs	Cf	Cs	Cf	Cs
Arm length 2900 mm													
	9.0 m	*14430	*14430										
	6.0 m	*14260	11260	*14590	13690	*16230	*16230						
	3.0 m	12260	9410	16000	12400	*20660	17350	*26800	25380				
	0 m	12560	9550	15060	11510	20610	15700	30360	22930	*31360	*31360		
	-3.0 m	16300	12470			20370	15540	*27560	22860	*36040	*36040	*33160	*33160
	-6.0 m												

Conditions: Boom: 8000 mm, Bucket (SAE): 3.1 m³, Shoes: 610 mm
(Heavy Lift mode: OFF)

unit: kg

B	A	MAX		9.0 m		7.5 m		6.0 m		4.5 m		3.0 m	
		Cf	Cs	Cf	Cs	Cf	Cs	Cf	Cs	Cf	Cs	Cf	Cs
Arm length 3600 mm													
	9.0 m	*7390	*7390										
	6.0 m	*7780	*7780	*12160	*12160	*14140	*14140						
	3.0 m	*9070	8060	*14790	13400	*18640	17990	*24140	*24140				
	0 m	10390	7990	15760	12230	*20740	16340	*25150	23180	*13570	*13570		
	-3.0 m	12230	9420	15330	11830	*20080	15880	*25650	23110	*21930	*21930	*14290	*14290
	-6.0 m	*13810	*13810			*15270	*15270	*19600	*19600	*24550	*24550		

(Heavy Lift mode: ON)

unit: kg

B	A	MAX		9.0 m		7.5 m		6.0 m		4.5 m		3.0 m	
		Cf	Cs	Cf	Cs	Cf	Cs	Cf	Cs	Cf	Cs	Cf	Cs
Arm length 3600 mm													
	9.0 m	*8380	*8380										
	6.0 m	*8800	*8800	*13940	*13940	*16100	*16100						
	3.0 m	*10220	8060	16870	13400	*21270	18130	*27400	25700				
	0 m	10390	7990	15760	12230	21140	16340	*27920	23180	*15140	*15140		
	-3.0 m	12230	9420	15330	11830	20650	15880	*29270	23110	*24400	*24400	*16040	*16040
	-6.0 m	*16050	15130			*17680	*16460	*22580	*22580	*28240	*28240		

* Load is limited hydraulic capacity rather than tipping.
Ratings are based on SAE Standard No. J1097. Rated loads do not exceed 87% of hydraulic lift capacity or 75% of tipping load.

PC800-7

Conditions: Boom: 8040 mm (26'11"), Bucket (SAE): 3.4 m³ (4.45 cu.yd), Shoes: 610 mm (24")
(Heavy-lifting: "OFF")

unit: kg (lb)

B	A	MAX		9.0 m (29')		7.5 m (24')		6.0 m (19')		4.5 m (14')		3.0 m (9')	
		Cf	Cs	Cf	Cs	Cf	Cs	Cf	Cs	Cf	Cs	Cf	Cs
Arm length 3600 mm (11'10")													
6.0 m (19')		*10550 (23200)	9050 (20000)	*11950 (26400)	*11950 (26400)	*14000 (30900)	*14000 (30900)	*17500 (38600)	*17500 (38600)				
3.0 m (9')		10100 (22300)	7650 (16800)	*14150 (31200)	12050 (26600)	*17700 (39100)	16500 (36300)	*24000 (52900)	23400 (51600)				
0 m (0')		10250 (22600)	7700 (16900)	14450 (31900)	11000 (24200)	19600 (43200)	14850 (32800)	*25900 (57100)	21300 (47000)				
-3.0 m (-9')		12700 (28000)	9600 (21100)	14250 (31500)	10800 (23800)	*18400 (40600)	14650 (32300)	*23550 (51900)	21400 (47200)	*30250 (66700)	*30250 (66700)	*28050 (61900)	*28050 (61900)
-6.0 m (-19')		*12850 (28400)	*12850 (28400)					*15550 (34300)	*15550 (34300)				

(Heavy-lifting: "ON")

unit: kg (lb)

B	A	MAX		9.0 m (29')		7.5 m (24')		6.0 m (19')		4.5 m (14')		3.0 m (9')	
		Cf	Cs	Cf	Cs	Cf	Cs	Cf	Cs	Cf	Cs	Cf	Cs
Arm length 3600 mm (11'10")													
6.0 m (19')		11750 (25900)	9050 (20000)	*13850 (30500)	13450 (29700)	*16100 (35500)	*16100 (35500)	*19900 (43900)	*19900 (43900)				
3.0 m (9')		10100 (22300)	7650 (16800)	15600 (34400)	12050 (26600)	*20350 (44900)	16500 (36300)	*27400 (60500)	23400 (51600)				
0 m (0')		10250 (22600)	7700 (16900)	14450 (31900)	11000 (24200)	19600 (43200)	14850 (32800)	28500 (62900)	21300 (47000)				
-3.0 m (-9')		12700 (28000)	9600 (21100)	14250 (31500)	10800 (23800)	19350 (42700)	14650 (32300)	*27050 (59700)	21400 (47200)	*34700 (76500)	*34700 (76500)	*31100 (68600)	*31100 (68600)
-6.0 m (-19')		*15150 (33400)	*15150 (33400)					*18250 (40200)	*18250 (40200)				

PC800-7 (SE spec.)

Conditions: Boom: 7100 mm (23'4"), Bucket (SAE): 4.3 m³ (5.62 cu.yd), Shoes: 610 mm (24")
(Heavy-lifting: "OFF")

unit: kg (lb)

B	A	MAX		9.0 m (29')		7.5 m (24')		6.0 m (19')		4.5 m (14')		3.0 m (9')	
		Cf	Cs	Cf	Cs	Cf	Cs	Cf	Cs	Cf	Cs	Cf	Cs
Arm length 2945 mm (9'8")													
6.0 m (19')		*13250 (29200)	11950 (26400)	*13450 (29600)	12800 (28200)	*15250 (33700)	*15250 (33700)	*18500 (40800)	*18500 (40800)				
3.0 m (9')		13000 (28600)	9950 (21900)	*15200 (33500)	11950 (26300)	*18750 (41300)	16700 (36800)	*25000 (55100)	24300 (53500)				
0 m (0')		13550 (29800)	10300 (22700)	14750 (32500)	11250 (24800)	20200 (44600)	15450 (34100)	*26850 (59200)	22450 (49500)	*27200 (59900)	*27200 (59900)		
-3.0 m (-9')		*15650 (34500)	14250 (31400)			*17200 (37900)	15550 (34300)	*22850 (50300)	22750 (50200)	*29600 (65300)	*29600 (65300)	*37150 (81900)	*37150 (81900)

(Heavy-lifting: "ON")

unit: kg (lb)

B	A	MAX		9.0 m (29')		7.5 m (24')		6.0 m (19')		4.5 m (14')		3.0 m (9')	
		Cf	Cs	Cf	Cs	Cf	Cs	Cf	Cs	Cf	Cs	Cf	Cs
Arm length 2945 mm (9'8")													
6.0 m (19')		*15300 (33800)	11950 (26400)	*15550 (34200)	12800 (28200)	*17500 (38600)	*17500 (38600)	*21050 (46400)	*21050 (46400)				
3.0 m (9')		13000 (28600)	9950 (21900)	15450 (34100)	11950 (26300)	*21450 (47300)	16700 (36800)	*28400 (62700)	24300 (53500)				
0 m (0')		13550 (29800)	10300 (22700)	14750 (32500)	11250 (24800)	20200 (44600)	15450 (34100)	29750 (65600)	22450 (49500)	*30200 (66600)	*30200 (66600)		
-3.0 m (-9')		*18150 (40000)	14250 (31400)			*19850 (43800)	15550 (34300)	*26200 (57800)	22750 (50200)	*33850 (74700)	*33850 (74700)	*42600 (93900)	*42600 (93900)

* Load is limited by hydraulic capacity rather than tipping.
Ratings are based on SAE Standard NO. J1097. Rated loads do not exceed 87% of hydraulic lift capacity or 75% of tipping load.

PC800LC-8E0, PC800LC-8R1

Conditions: Boom: 8200 mm (26'11"), Bucket (SAE): 3.1m³ (4.05 cu.yd), Shoes: 810 mm (32")

(Heavy Lift mode: ON)

unit: kg (lb)

B	A	MAX		9.0 m (29')		7.5 m (24')		6.0 m (19')		4.5 m (14')		3.0 m (9')	
		Cf	Cs	Cf	Cs	Cf	Cs	Cf	Cs	Cf	Cs	Cf	Cs
Arm length 3600 mm (11'10")													
9.0 m (29')		*8350 (18400)	*8350 (18400)										
6.0 m (19')		*8800 (19400)	*8800 (19400)	*14000 (30900)	*14000 (30900)	*16000 (35300)	*16000 (35300)						
3.0 m (9')		*10200 (22500)	7550 (16700)	*16750 (36900)	12700 (28000)	*20500 (45200)	17050 (37600)	*26900 (59300)	24050 (53000)				
0 m (0')		11850 (26100)	7450 (16500)	17900 (39500)	11450 (25200)	*23250 (51300)	15200 (33500)	*21700 (47900)	21400 (47200)	*15100 (33300)	*15100 (33300)		
-3.0 m (-9')		13950 (30800)	8850 (19500)	17450 (38500)	11050 (24300)	*22700 (50100)	14700 (32400)	*22450 (49500)	21150 (46600)	*20300 (44700)	*20300 (44700)	*21200 (46700)	*21200 (46700)
-6.0 m (-19')		*16050 (35400)	14300 (31500)			*17250 (38100)	15500 (34200)	*22050 (48600)	*22050 (48600)	*22500 (49600)	*22500 (49600)		

* Load is limited hydraulic capacity rather than tipping.
 Ratings are based on ISO Standard No.10567. Rated loads do not exceed 87% of hydraulic lift capacity or 75% of tipping load.

PC800LC-8 (for USA)

Conditions:

Boom: 8200 mm (26'11"), Bucket (SAE): 3.1 m³ (4.05 cu.yd), Bucket weight: 2950 kg (6,500 lb),
Shoes: 810 mm (32")

(Heavy Lift mode: ON)

unit: kg (lb)

B	A	MAX		9.1 m (30')		7.6 m (25')		6.1 m (20')		4.6 m (15')		3.0 m (10')	
		Cf	Cs	Cf	Cs	Cf	Cs	Cf	Cs	Cf	Cs	Cf	Cs
Arm length 3600 mm (11'10")													
	9.1 m (30')	*8350 (18400)	*8350 (18400)										
	6.1 m (20')	*8800 (19400)	*8800 (19400)	*13900 (30700)	*13900 (30700)	*16100 (35500)	*16100 (35500)						
	3.0 m (10')	*10200 (22500)	9200 (20200)	*16950 (37400)	15000 (33000)	*21250 (46800)	20150 (44400)	*27400 (60400)	*27400 (60400)				
	0.0 m (0')	*13250 (29200)	9150 (20200)	*18850 (41500)	13800 (30500)	*23700 (52200)	18350 (40500)	*27900 (61500)	25950 (57200)	*15100 (33300)	*15100 (33300)		
	-3.0 m (-10')	*15000 (33100)	10750 (23700)	*18400 (40600)	13400 (29600)	*23000 (50700)	17900 (39500)	*29250 (64500)	25850 (57000)	*24400 (53700)	*24400 (53700)	*16000 (35300)	*16000 (35300)
	-6.1 m (-20')	*16050 (35400)	*16050 (35400)			*17650 (38900)	*17650 (38900)	*22550 (49700)	*22550 (49700)	*28200 (62200)	*28200 (62200)		

Conditions:

Boom: 8200 mm (26'11"), Bucket (SAE): 2.8 m³ (3.66 cu.yd), Bucket weight: 2730 kg (6,017 lb),
Shoes: 810 mm (32")

(Heavy Lift mode: ON)

unit: kg (lb)

B	A	MAX		9.1 m (30')		7.6 m (25')		6.1 m (20')		4.6 m (15')		3.0 m (10')	
		Cf	Cs	Cf	Cs	Cf	Cs	Cf	Cs	Cf	Cs	Cf	Cs
Arm length 4600 mm (15'1")													
	9.1 m (30')	*7050 (15500)	*7050 (15500)										
	6.1 m (20')	*7350 (16200)	*7350 (16200)	*12350 (27200)	*12350 (27200)								
	3.0 m (10')	*8350 (18500)	7950 (17500)	*15650 (34500)	15100 (33300)	*19350 (42700)	*19350 (42700)	*24400 (53800)	*24400 (53800)				
	0 m (0')	*10500 (23200)	7850 (17300)	*18200 (40100)	13750 (30400)	*23000 (50700)	18350 (40500)	*30000 (66200)	27000 (57300)	*16300 (36000)	*16300 (36000)		
	-3.0 m (-10')	*13350 (29500)	8900 (19600)	*18550 (40900)	13050 (28800)	*23200 (51200)	17450 (38500)	*30100 (66300)	25150 (55400)	*25100 (55300)	*25100 (55300)	*14400 (31800)	*14400 (31800)
	-6.1 m (-20')	*14750 (32500)	12700 (28100)	*15550 (34300)	13400 (29600)	*19950 (44000)	17900 (39500)	*25400 (56100)	*25400 (56100)	*33000 (72700)	*33000 (72700)	*30450 (67100)	*30450 (67100)

Conditions:

Boom: 8200 mm (26'11"), Bucket (SAE): 2.8 m³ (3.66 cu.yd), Bucket weight: 2730 kg (6,017 lb),
Shoes: 810 mm (32")

(Heavy Lift mode: ON)

unit: kg (lb)

B	A	MAX		9.1 m (30')		7.6 m (25')		6.1 m (20')		4.6 m (15')		3.0 m (10')	
		Cf	Cs	Cf	Cs	Cf	Cs	Cf	Cs	Cf	Cs	Cf	Cs
Arm length 5600 mm (18'4")													
	9.1 m (30')	*4650 (10300)	*4650 (10300)										
	6.1 m (20')	*4750 (10500)	*4750 (10500)										
	3.0 m (10')	*5350 (11800)	*5350 (11800)	*13900 (30600)	*13900 (30600)	*17000 (37400)	*17000 (37400)	*22450 (49500)	*22450 (49500)				
	0 m (0')	*6550 (14500)	6450 (14200)	*17000 (37400)	13700 (30200)	*21550 (47500)	*29100 (64200)	*29100 (64200)	26200 (57800)	*16900 (37300)	*16900 (37300)		
	-3.0 m (-10')	*9050 (19900)	7150 (15800)	*18100 (39900)	12700 (28000)	*22750 (50100)	17050 (37600)	*29850 (65800)	24500 (54000)	*20050 (44200)	*20050 (44200)	*11400 (25200)	*11400 (25200)
	-6.1 m (-20')	*12550 (27700)	9600 (21100)	*16600 (36700)	12700 (28000)	*21000 (46300)	17100 (37700)	*27050 (59700)	24850 (54800)	*33300 (73400)	*33300 (73400)	*27550 (60700)	*27550 (60700)

* Load is limited hydraulic capacity rather than tipping.

Ratings are based on ISO Standard No.10567. Rated loads do not exceed 87% of hydraulic lift capacity or 75% of tipping load.

PC800LC-8 (for USA)

Conditions:

Boom: 8200 mm (26'11"), Bucket (SAE): 3.1 m³ (4.05 cu.yd), Bucket weight: 2950 kg (6,500 lb),
Shoes: 1010 mm (40")

(Heavy Lift mode: ON)

unit: kg (lb)

B	A	MAX		9.1 m (30')		7.6 m (25')		6.1 m (20')		4.6 m (15')		3.0 m (10')	
		Cf	Cs	Cf	Cs	Cf	Cs	Cf	Cs	Cf	Cs	Cf	Cs
Arm length 3600 mm (11'10")													
	9.1 m (30')	*8350 (18400)	*8350 (18400)										
	6.1 m (20')	*8800 (19400)	*8800 (19400)	*13900 (30700)	*13900 (30700)	*16100 (35500)	*16100 (35500)						
	3.0 m (10')	*10200 (22500)	9500 (21000)	*16950 (37400)	15450 (34100)	*21250 (46800)	20500 (45200)	*27400 (60400)	*27400 (60400)				
	0.0 m (0')	*13250 (29200)	9500 (20900)	*18850 (41500)	14300 (31500)	*23700 (52200)	18950 (41800)	*27900 (61500)	26750 (59000)	*15100 (33300)	*15100 (33300)		
	-3.0 m (-10')	*15000 (33100)	11150 (24600)	*18400 (40600)	13900 (30600)	*23000 (50700)	18500 (40800)	*29250 (64500)	26700 (58800)	*24400 (53700)	*24400 (53700)	*16000 (35300)	*16000 (35300)
	-6.1 m (-20')	*16050 (35400)	*16050 (35400)			*17650 (38900)	*17650 (38900)	*22550 (49700)	*22550 (49700)	*28200 (62200)	*28200 (62200)		

Conditions:

Boom: 8200 mm (26'11"), Bucket (SAE): 2.8 m³ (3.66 cu.yd), Bucket weight: 2730 kg (6,017 lb),
Shoes: 1010 mm (40")

(Heavy Lift mode: ON)

unit: kg (lb)

B	A	MAX		9.1 m (30')		7.6 m (25')		6.1 m (20')		4.6 m (15')		3.0 m (10')	
		Cf	Cs	Cf	Cs	Cf	Cs	Cf	Cs	Cf	Cs	Cf	Cs
Arm length 4600 mm (15'1")													
	9.1 m (30')	*7050 (15500)	*7050 (15500)										
	6.1 m (20')	*7350 (16200)	*7350 (16200)	*12350 (27200)	*12350 (27200)								
	3.0 m (10')	*8350 (18500)	8300 (18300)	*15650 (34500)	*15650 (34500)	*19350 (42700)	*19350 (42700)	*24400 (53800)	*24400 (53800)				
	0 m (0')	*10500 (23200)	8200 (18100)	*18200 (40100)	14350 (31600)	*23000 (50700)	19100 (42100)	*30000 (66200)	27000 (59500)	*16300 (36000)	*16300 (36000)		
	-3.0 m (-10')	*13350 (29500)	9350 (20600)	*18550 (40900)	13650 (30100)	*23200 (51200)	18200 (40100)	*30100 (66300)	26150 (57600)	*25100 (55300)	*25100 (55300)	*14400 (31800)	*14400 (31800)
	-6.1 m (-20')	*14750 (32500)	13300 (29300)	*15550 (34300)	14000 (30900)	*19950 (44000)	18650 (41100)	*25400 (56100)	*25400 (56100)	*33000 (72700)	*33000 (72700)	*30450 (67100)	*30450 (67100)

Conditions:

Boom: 8200 mm (26'11"), Bucket (SAE): 2.8 m³ (3.66 cu.yd), Bucket weight: 2730 kg (6,017 lb),
Shoes: 1010 mm (40")

(Heavy Lift mode: ON)

unit: kg (lb)

B	A	MAX		9.1 m (30')		7.6 m (25')		6.1 m (20')		4.6 m (15')		3.0 m (10')	
		Cf	Cs	Cf	Cs	Cf	Cs	Cf	Cs	Cf	Cs	Cf	Cs
Arm length 5600 mm (18'4")													
	9.1 m (30')	*4650 (10300)	*4650 (10300)										
	6.1 m (20')	*4750 (10500)	*4750 (10500)										
	3.0 m (10')	*5350 (11800)	*5350 (11800)	*13900 (30600)	*13900 (30600)	*17000 (37400)	*17000 (37400)	*22450 (49500)	*22450 (49500)				
	0 m (0')	*6550 (14500)	6550 (14500)	*17000 (37400)	14300 (31500)	*21550 (47500)	19150 (42200)	*29100 (64200)	27200 (60000)	*16900 (37300)	*16900 (37300)		
	-3.0 m (-10')	*9050 (19900)	7550 (16700)	*18100 (39900)	13250 (29300)	*22750 (50100)	17750 (39200)	*29850 (65800)	25500 (56200)	*20050 (44200)	*20050 (44200)	*11400 (25200)	*11400 (25200)
	-6.1 m (-20')	*12550 (27700)	10050 (22200)	*16600 (36700)	13300 (29300)	*21000 (46300)	17850 (39300)	*27050 (59700)	25500 (56300)	*33300 (73400)	*33300 (73400)	*27550 (60700)	*27550 (60700)

* Load is limited hydraulic capacity rather than tipping.

Ratings are based on ISO Standard No.10567. Rated loads do not exceed 87% of hydraulic lift capacity or 75% of tipping load.

PC800LC-8 (UK source)

Conditions: Boom: 7100 mm, Bucket (SAE): 4.0 m³, Shoes: 810 mm

(Heavy Lift mode: OFF)

unit: kg

B	A	MAX		9.0 m		7.5 m		6.0 m		4.5 m		3.0 m	
		Cf	Cs	Cf	Cs	Cf	Cs	Cf	Cs	Cf	Cs	Cf	Cs
Arm length 2900 mm													
9.0 m		*12620	*12620										
6.0 m		*12310	11780	*12630	*12630	*14150	*14150						
3.0 m		*12780	9900	*14570	12990	*18010	17860	*23540	*23540				
0 m		*13650	10070	*15810	12100	*20040	16510	*26730	23950	*28630	*28630		
-3.0 m		*14560	13090			*18280	16280	*24040	*23810	*31560	*31560	*29820	*29820
-6.0 m													

(Heavy Lift mode: ON)

unit: kg

B	A	MAX		9.0 m		7.5 m		6.0 m		4.5 m		3.0 m	
		Cf	Cs	Cf	Cs	Cf	Cs	Cf	Cs	Cf	Cs	Cf	Cs
Arm length 2900 mm													
9.0 m		*14430	*14430										
6.0 m		*14260	11780	*14590	14280	*16230	*16230						
3.0 m		*14840	9900	*16820	12990	*20660	18090	*26800	26400				
0 m		15770	10070	*18260	12100	*22990	16510	*30480	23950	*31360	*31360		
-3.0 m		*16920	13090			*21090	16280	*27560	23880	*36040	*36040	*33160	*33160
-6.0 m													

Conditions: Boom: 8000 mm, Bucket (SAE): 3.1 m³, Shoes: 810 mm

(Heavy Lift mode: OFF)

unit: kg

B	A	MAX		9.0 m		7.5 m		6.0 m		4.5 m		3.0 m	
		Cf	Cs	Cf	Cs	Cf	Cs	Cf	Cs	Cf	Cs	Cf	Cs
Arm length 3600 mm													
9.0 m		*7390	*7390										
6.0 m		*7780	*7780	*12160	*12160	*14140	*14140						
3.0 m		*9070	8480	*14790	13990	*18640	18460	*24140	*24140				
0 m		*11870	8420	*16420	12820	*20740	17090	*25150	24200	*13570	*13570		
-3.0 m		*12970	9910	*16000	12410	*20080	16630	*25650	*24130	*21930	*21930	*14290	*14290
-6.0 m		*13810	*13810			*15270	*15270	*19600	*19600	*24550	*24550		

(Heavy Lift mode: ON)

unit: kg

B	A	MAX		9.0 m		7.5 m		6.0 m		4.5 m		3.0 m	
		Cf	Cs	Cf	Cs	Cf	Cs	Cf	Cs	Cf	Cs	Cf	Cs
Arm length 3600 mm													
9.0 m		*8380	*8380										
6.0 m		*8800	*8800	*13940	*13940	*16100	*16100						
3.0 m		*10220	8480	*16960	13900	*21270	18870	*27400	26710				
0 m		12950	8420	*18850	12820	*23700	17090	*27920	24200	*15140	*15140		
-3.0 m		*15030	9910	*18420	12410	*23010	16630	*29270	24130	*24400	*24400	*16040	*16040
-6.0 m		*16050	15830			*17680	*17210	*22580	*22580	*28240	*28240		

* Load is limited hydraulic capacity rather than tipping.

Ratings are based on SAE Standard No. J1097. Rated loads do not exceed 87% of hydraulic lift capacity or 75% of tipping load.

PC850-8E0, PC850-8R1

Conditions: Boom: 8040 mm (26'5"), Bucket (SAE): 3.4 m³ (4.45 cu.yd), Shoes: 610 mm (24")

(Heavy Lift mode: OFF)

unit: kg (lb)

B	A	MAX		9.0 m (29')		7.5 m (24')		6.0 m (19')		4.5 m (14')		3.0 m (9')	
		Cf	Cs	Cf	Cs	Cf	Cs	Cf	Cs	Cf	Cs	Cf	Cs
Arm length 3600 mm (11'10")													
6.0 m (19')		*9300 (20500)	8650 (19000)	*11050 (24400)	*11050 (24400)	*12800 (28200)	*12800 (28200)						
3.0 m (9')		9850 (21700)	7250 (16000)	*13250 (29200)	12300 (27100)	*16450 (36300)	*16450 (36300)	*22050 (48600)	*22050 (48600)				
0 m (0')		9850 (21900)	7150 (15800)	*14800 (32600)	10950 (24100)	*18700 (41200)	14750 (32500)	*20950 (46200)	*20950 (46200)	*19850 (43800)	*19850 (43800)		
-3.0 m (-9')		*11800 (26100)	8600 (19000)	*14350 (31600)	10550 (23200)	*18150 (40000)	14250 (31400)	*21250 (46800)	*20750 (45700)	*21150 (46600)	*21150 (46600)	*24450 (53900)	*24450 (53900)
-6.0 m (-19')		*12550 (27700)	*12550 (27700)			*12900 (28400)	*12900 (28400)	*17050 (37600)	*17050 (37600)	*21300 (47000)	*21300 (47000)		

(Heavy Lift mode: ON)

unit: kg (lb)

B	A	MAX		9.0 m (29')		7.5 m (24')		6.0 m (19')		4.5 m (14')		3.0 m (9')	
		Cf	Cs	Cf	Cs	Cf	Cs	Cf	Cs	Cf	Cs	Cf	Cs
Arm length 3600 mm (11'10")													
6.0 m (19')		*10550 (23200)	8650 (19000)	*12850 (28300)	*12850 (28300)	*14750 (32500)	*14750 (32500)						
3.0 m (9')		9850 (21700)	7250 (16000)	*15400 (33900)	12300 (27100)	*18950 (41800)	*16800 (37000)	*23400 (51600)	*23400 (51600)				
0 m (0')		9850 (21700)	7150 (15750)	14800 (32600)	10950 (24100)	19950 (43900)	14750 (32500)	*20950 (46200)	*20950 (46200)	*22100 (48700)	*22100 (48700)		
-3.0 m (-9')		11800 (26000)	8600 (19000)	14350 (31700)	10550 (23200)	19400 (42800)	14250 (31400)	*21250 (46850)	20750 (45700)	*21150 (46700)	*21150 (46700)	*24450 (53900)	*24450 (53900)
-6.0 m (-19')		*14850 (32700)	*14850 (32700)			*15250 (33600)	*15250 (33600)	*20000 (44100)	*20000 (44100)	*21300 (46900)	*21300 (46900)		

* Load is limited hydraulic capacity rather than tipping.
Ratings are based on ISO Standard No.10567. Rated loads do not exceed 87% of hydraulic lift capacity or 75% of tipping load.

PC850-8E0 (SE spec.), PC850-8R1 (SE spec.)

Conditions: Boom: 7100 mm (23'4"), Bucket (SAE): 4.3 m³ (5.62 cu.yd), Shoes: 610 mm (24")

(Heavy Lift mode: OFF)

unit: kg (lb)

B	A	MAX		9.0 m (29')		7.5 m (24')		6.0 m (19')		4.5 m (14')		3.0 m (9')	
		Cf	Cs	Cf	Cs	Cf	Cs	Cf	Cs	Cf	Cs	Cf	Cs
Arm length 2900 mm (9'8")													
6.0 m (19')		*12150 (26800)	11100 (24500)	*12650 (27900)	*12650 (27900)	*14250 (31400)	*14250 (31400)						
3.0 m (9')		12400 (27300)	9250 (20400)	*14500 (32000)	12350 (27200)	*17700 (39000)	17100 (37700)	*23250 (51300)	*23250 (51300)				
0 m (0')		12700 (28000)	9400 (20700)	15250 (33600)	11350 (25000)	*19700 (43400)	15450 (34100)	*26050 (57400)	22250 (49100)	*28450 (62700)	*28450 (62700)		
-3.0 m (-9')		*14400 (31700)	12350 (27200)			*17850 (39400)	15300 (33700)	*23350 (51500)	22200 (48900)	*30850 (68000)	*30850 (68000)	*31850 (70200)	*31850 (70200)

(Heavy Lift mode: ON)

unit: kg (lb)

B	A	MAX		9.0 m (29')		7.5 m (24')		6.0 m (19')		4.5 m (14')		3.0 m (9')	
		Cf	Cs	Cf	Cs	Cf	Cs	Cf	Cs	Cf	Cs	Cf	Cs
Arm length 2900 mm (9'8")													
6.0 m (19')		*14100 (31100)	11100 (24500)	*14650 (32300)	13600 (30000)	*16350 (36000)	*16350 (36000)						
3.0 m (9')		12400 (27350)	9250 (20400)	16300 (35900)	12350 (27300)	*20350 (44800)	17100 (37800)	*26550 (58600)	24850 (54700)				
0 m (0')		12700 (28000)	9400 (20800)	15250 (33600)	11350 (25100)	20650 (45600)	15450 (34000)	*29800 (65700)	22250 (49000)	*31350 (69100)	*31350 (69100)		
-3.0 m (-9')		16500 (36400)	12350 (27200)			20550 (45300)	15300 (33700)	*26850 (59200)	22200 (49000)	*32100 (70800)	*32100 (70800)	*31850 (70200)	*31850 (70200)

* Load is limited hydraulic capacity rather than tipping.
Ratings are based on ISO standard No.10567. Rated loads do not exceed 87% of hydraulic lift capacity or 75% of tipping load.

PC1250-8, PC1250-8R

Conditions: Boom: 9100 mm (29'10"), Bucket (SAE): 5.0 m³ (6.54 cu.yd), Shoes: 700 mm (28")
(Heavy-lifting: "ON")

unit: kg (lb)

B	A	MAX		12.2 m (40')		10.7 m (35')		9.1 m (30')		7.6 m (25')		6.1 m (20')		4.6 m (15')	
		Cf	Cs	Cf	Cs	Cf	Cs	Cf	Cs	Cf	Cs	Cf	Cs	Cf	Cs
Arm length 3400 mm (11'2")															
9.1 m (30')		*15200 (33500)	*15200 (33500)			*18000 (39700)	*18000 (39700)								
6.1 m (20')		*15950 (35150)	13200 (29100)			*20050 (44200)	17400 (38400)	*22950 (50600)	*22950 (50600)	*27900 (61500)	*27900 (61500)				
3.0 m (10')		15650 (34500)	11850 (26200)	16400 (36100)	12500 (27500)	20850 (46000)	16100 (35500)	27000 (59500)	20850 (46000)	*34950 (77100)	27650 (60900)				
0.0 m (0')		16250 (35900)	12300 (27100)			19950 (44000)	15200 (33500)	24200 (53400)	18200 (40200)	34400 (75800)	26100 (57500)				
-3.0 m (-10')		19950 (44000)	15250 (33600)			20000 (44100)	15250 (33700)	25600 (56400)	19550 (43100)	34600 (76300)	26300 (57900)	*43850 (96700)	38400 (84700)	*39250 (86600)	*39250 (86600)
-6.1 m (-20')		*23500 (51800)	*23500 (51800)							*25400 (56100)	*25400 (56100)	*32550 (71800)	*32550 (71800)		

(Heavy-lifting: "OFF")

unit: kg (lb)

B	A	MAX		12.2 m (40')		10.7 m (35')		9.1 m (30')		7.6 m (25')		6.1 m (20')		4.6 m (15')	
		Cf	Cs	Cf	Cs	Cf	Cs	Cf	Cs	Cf	Cs	Cf	Cs	Cf	Cs
Arm length 3400 mm (11'2")															
9.1 m (30')		*15200 (33500)	*15200 (33500)			*15500 (34200)	*15500 (34200)								
6.1 m (20')		*15850 (34900)	13200 (29100)			*17300 (38100)	*17300 (38100)	*19950 (44000)	*19950 (44000)	*24400 (53800)	*24400 (53800)				
3.0 m (10')		15650 (34500)	11850 (26200)	16400 (36100)	12500 (27500)	*19800 (43700)	16100 (35500)	*23900 (52700)	20850 (46000)	*30550 (67400)	27650 (60900)				
0.0 m (0')		16250 (35900)	12300 (27100)			19950 (44000)	15200 (33500)	24200 (53400)	18200 (40200)	*32650 (72000)	26100 (57500)				
-3.0 m (-10')		*19600 (43200)	15250 (33600)			*19650 (43300)	15250 (33700)	*24750 (54600)	19550 (43100)	*30750 (67800)	26300 (57900)	*38350 (84500)	*38350 (84500)	*39250 (86600)	*39250 (86600)
-6.1 m (-20')		*20150 (44500)	*20150 (44500)							*21900 (48200)	*21900 (48200)	*28150 (62100)	*28150 (62100)		

Conditions: Boom: 9100 mm (29'10"), Bucket (SAE): 4.0 m³ (5.2 cu.yd), Shoes: 700 mm (28")
(Heavy-lifting: "ON")

unit: kg (lb)

B	A	MAX		12.2 m (40')		10.7 m (35')		9.1 m (30')		7.6 m (25')		6.1 m (20')		4.6 m (15')	
		Cf	Cs	Cf	Cs	Cf	Cs	Cf	Cs	Cf	Cs	Cf	Cs	Cf	Cs
Arm length 4500 mm (14'9")															
9.1 m (30')		*9300 (20500)	*9300 (20500)												
6.1 m (20')		*9650 (21300)	*9650 (21300)	*16650 (36700)	13700 (30200)	*18150 (40000)	18000 (39700)	*20550 (45400)	*20550 (45400)						
3.0 m (10')		*10950 (24200)	10200 (22500)	16650 (36700)	12750 (28100)	21200 (46700)	16400 (36100)	*25600 (56500)	21300 (47000)	*32350 (71400)	28500 (62800)				
0.0 m (0')		*13650 (30100)	10400 (23000)	15850 (34900)	11950 (26400)	19900 (43900)	15150 (33400)	24550 (54100)	18500 (40800)	34450 (75900)	26100 (57600)	*29300 (64600)	29300 (64600)		
-3.0 m (-10')		16400 (36200)	12400 (27300)			19550 (43100)	14800 (32600)	25100 (55400)	19050 (42000)	34000 (75000)	25700 (56600)	*46350 (102200)	37500 (82600)	*31900 (70300)	*31900 (70300)
-6.1 m (-20')		*21750 (48000)	18700 (41300)					*23650 (52100)	20000 (44100)	*28850 (63600)	25200 (55500)	*38200 (84300)	*38200 (84300)	*48900 (107800)	*48900 (107800)

(Heavy-lifting: "OFF")

unit: kg (lb)

B	A	MAX		12.2 m (40')		10.7 m (35')		9.1 m (30')		7.6 m (25')		6.1 m (20')		4.6 m (15')	
		Cf	Cs	Cf	Cs	Cf	Cs	Cf	Cs	Cf	Cs	Cf	Cs	Cf	Cs
Arm length 4500 mm (14'9")															
9.1 m (30')		*9300 (20500)	*9300 (20500)												
6.1 m (20')		*9650 (21300)	*9650 (21300)	*14250 (31400)	13700 (30200)	*15600 (34400)	*15600 (34400)	*17850 (39300)	*17850 (39300)						
3.0 m (10')		*10950 (24200)	10200 (22500)	*16050 (35400)	12750 (28100)	*18500 (40800)	16400 (36100)	*22250 (49000)	21300 (47000)	*28250 (62300)	*28250 (62300)				
0.0 m (0')		*13650 (30100)	10400 (23000)	15850 (34900)	11950 (26400)	19900 (43900)	15150 (33400)	*24200 (53300)	18500 (40800)	*31950 (70400)	26100 (57600)	*29300 (64600)	*29300 (64600)		
-3.0 m (-10')		16400 (36200)	12400 (27300)			19550 (43100)	14800 (32600)	25100 (55400)	19050 (42000)	*31650 (69800)	25700 (56600)	*40550 (89400)	37500 (82600)	*31900 (70300)	*31900 (70300)
-6.1 m (-20')		*18650 (41100)	18650 (41100)					*20300 (44800)	20000 (44100)	*24800 (54700)	24800 (54700)	*33200 (73200)	*33200 (73200)	*42600 (93900)	*42600 (93900)

* Load is limited by hydraulic capacity rather than tipping.
Ratings are based on SAE Standard NO. J1097. Rated loads do not exceed 87% of hydraulic lift capacity or 75% of tipping load.

PC1250-8, PC1250-8R

Conditions: Boom: 9100 mm (29'10"), Bucket (SAE): 3.4 m³ (4.4 cu.yd), Shoes: 700 mm (28")
 (Heavy-lifting: "ON")

unit: kg (lb)

B	A	MAX		13.7 m (45')		12.2 m (40')		10.7 m (35')		9.1 m (30')		7.6 m (25')		6.1 m (20')	
		Cf	Cs	Cf	Cs	Cf	Cs	Cf	Cs	Cf	Cs	Cf	Cs	Cf	Cs
Arm length 5700 mm (18'8")															
9.1 m (30')		*5900 (1300)	*5900 (13000)												
6.1 m (20')		*6050 (13400)	*6050 (13400)	*11050 (24300)	10950 (24100)	*14950 (32900)	14350 (31600)								
3.0 m (10')		*6800 (15000)	*6800 (15000)	13550 (29900)	10250 (22600)	17050 (37600)	13100 (28900)	*19800 (43700)	16900 (37200)	*23450 (51700)	22050 (48600)	*29300 (64600)	*29300 (64600)	*39750 (87600)	*39750 (87600)
0.0 m (0')		*8400 (18500)	*8400 (18500)	12850 (28400)	9600 (21100)	15950 (35200)	12050 (26600)	20100 (44300)	15300 (33800)	25900 (57100)	19800 (43600)	34800 (76700)	26450 (58300)	*31200 (68800)	*31200 (68800)
-3.0 m (-10')		*11500 (25400)	10150 (22400)			15500 (34100)	11600 (25600)	19300 (42600)	14600 (32100)	24850 (54800)	18800 (41500)	33600 (74100)	25300 (55800)	*47600 (105000)	36800 (81100)
-6.1 m (-20')		18600 (41000)	14100 (31100)					19750 (43500)	15000 (33000)	25200 (55600)	19150 (42200)	*33250 (73300)	25850 (56900)	*42350 (93300)	37850 (83400)

(Heavy-lifting: "OFF")

unit: kg (lb)

B	A	MAX		13.7 m (45')		12.2 m (40')		10.7 m (35')		9.1 m (30')		7.6 m (25')		6.1 m (20')	
		Cf	Cs	Cf	Cs	Cf	Cs	Cf	Cs	Cf	Cs	Cf	Cs	Cf	Cs
Arm length 5700 mm (18'8")															
9.1 m (30')		*5900 (1300)	*5900 (13000)												
6.1 m (20')		*6050 (13400)	*6050 (13400)	*11050 (24300)	10950 (24100)	*12700 (28000)	*12700 (28000)								
3.0 m (10')		*6800 (15000)	*6800 (15000)	*13350 (29500)	10250 (22600)	*14850 (32800)	13100 (28900)	*17050 (37600)	16900 (37200)	*20300 (44800)	*20300 (44800)	*25550 (56300)	*25550 (56300)	*34850 (76800)	*34850 (76800)
0.0 m (0')		*8400 (18500)	*8400 (18500)	12850 (28400)	9600 (21100)	15950 (35200)	12050 (26600)	*19700 (43400)	15300 (33800)	*24000 (53000)	19800 (43600)	*30600 (67500)	26450 (58300)	*31200 (68800)	*31200 (68800)
-3.0 m (-10')		*11500 (25400)	10150 (22400)			15500 (34100)	11600 (25600)	19300 (42600)	14600 (32100)	24850 (54800)	18800 (41500)	*31900 (70300)	25300 (55800)	*41650 (91800)	36600 (81100)
-6.1 m (-20')		*16550 (36500)	14100 (31100)					*18050 (39800)	15000 (33000)	*22950 (50600)	19150 (42200)	*28850 (63600)	25850 (56900)	*36900 (81300)	*36900 (81300)

* Load is limited by hydraulic capacity rather than tipping.

Ratings are based on SAE Standard NO. J1097. Rated loads do not exceed 87% of hydraulic lift capacity or 75% of tipping load.

PC1250-7

Conditions: Boom: 9100 mm (29'10"), Bucket (SAE): 5.0 m³ (6.54 cu.yd), Shoes: 700 mm (28")

(Heavy-lifting: "OFF")

unit: kg (lb)

B	A	MAX		12.2 m (40')		10.7 m (35')		9.1 m (30')		7.6 m (25')		6.1 m (20')		4.6 m (15')	
		Cf	Cs	Cf	Cs	Cf	Cs	Cf	Cs	Cf	Cs	Cf	Cs	Cf	Cs
Arm length 3400 mm (11'2")															
9.1 m (30')	*15200 (33500)	*15200 (33500)			*15500 (34200)	*15500 (34200)									
6.1 m (20')	*15850 (34900)	12900 (28500)			*17300 (38100)	17100 (37700)	*19950 (44000)	*19950 (44000)	*24400 (53800)	*24400 (53800)					
3.0 m (10')	15350 (33800)	11600 (25600)	16050 (35400)	12200 (26900)	*19800 (43700)	15750 (34800)	*23900 (52700)	20500 (45200)	*30550 (67400)	27150 (59800)					
0.0 m (0')	15950 (35200)	12050 (26500)			19600 (43200)	14900 (32800)	23750 (52400)	17850 (39300)	*32650 (72000)	25600 (56400)					
-3.0 m (-10')	*19600 (43200)	14900 (32900)			*19650 (43300)	14950 (33000)	*24750 (54600)	19150 (42200)	*30750 (67800)	25800 (56800)	*38350 (84500)	37750 (83200)	*39250 (86600)	*39250 (86600)	
-6.1 m (-20')	*20150 (44500)	*20150 (44500)							*21900 (48200)	*21900 (48200)	*28150 (62100)	*28150 (62100)			

(Heavy-lifting: "ON")

unit: kg (lb)

B	A	MAX		12.2 m (40')		10.7 m (35')		9.1 m (30')		7.6 m (25')		6.1 m (20')		4.6 m (15')	
		Cf	Cs	Cf	Cs	Cf	Cs	Cf	Cs	Cf	Cs	Cf	Cs	Cf	Cs
Arm length 3400 mm (11'2")															
9.1 m (30')	*15200 (33500)	*15200 (33500)			*18000 (39700)	17900 (39400)									
6.1 m (20')	*15950 (35100)	12900 (28500)			*20000 (44200)	17100 (37700)	*22950 (50600)	22750 (50200)	*27900 (61500)	*27900 (61500)					
3.0 m (10')	15350 (33800)	11600 (25600)	16050 (35400)	12200 (26900)	20500 (45200)	15750 (34800)	26550 (58600)	20500 (45200)	*34950 (77000)	27150 (59800)					
0.0 m (0')	15950 (35200)	12050 (26500)			19600 (43200)	14900 (32800)	23750 (52400)	17850 (39300)	33800 (74600)	25600 (56400)					
-3.0 m (-10')	19600 (43200)	14900 (32900)			19650 (43300)	14950 (33000)	25150 (55400)	19150 (42200)	34050 (75000)	25800 (56800)	*43850 (96700)	37750 (83200)	*39250 (86600)	*39250 (86600)	
-6.1 m (-20')	*23500 (51800)	*23500 (51800)							*25400 (56000)	*25400 (56000)	*32550 (71700)	*32550 (71700)			

* Load is limited by hydraulic capacity rather than tipping.

Ratings are based on SAE Standard NO. J1097. Rated loads do not exceed 87% of hydraulic lift capacity or 75% of tipping load.

PC1250LC-7

Conditions: Boom: 9100 mm (29'10"), Bucket (SAE): 5.2 m³ (6.80 cu.yd), Shoes: 1000 mm (39")

(Heavy-lifting: "OFF")

unit: kg (lb)

B	A	MAX		12.2 m (40')		10.7 m (35')		9.1 m (30')		7.6 m (25')		6.1 m (20')		4.6 m (15')	
		Cf	Cs	Cf	Cs	Cf	Cs	Cf	Cs	Cf	Cs	Cf	Cs	Cf	Cs
Arm length 3400 mm (11'2")															
9.1 m (30')		*15200 (33500)	*15200 (33500)			*15500 (34200)	*15500 (34200)								
6.1 m (20')		*15850 (34900)	13850 (30500)			*17300 (38100)	*17300 (38100)	*19950 (44000)	*19950 (44000)	*24400 (53800)	*24400 (53800)				
3.0 m (10')		*16750 (36900)	12500 (27600)	*17150 (37800)	13150 (29000)	*19800 (43700)	16850 (37200)	*23900 (52700)	21800 (48100)	*30550 (67400)	28850 (63600)				
0.0 m (0')		*18050 (39800)	12950 (28600)			*21250 (46900)	15950 (35200)	*24700 (54400)	19150 (42200)	*32650 (72000)	27300 (60100)				
-3.0 m (-10')		*19600 (43200)	16000 (35300)			*19650 (43300)	16050 (35400)	*24750 (54600)	20450 (45100)	*30750 (67800)	27450 (60600)	*38350 (84500)	*38350 (84500)	*39250 (86600)	*39250 (86600)
-6.1 m (-20')		*20150 (44500)	*20150 (44500)							*21900 (48200)	*21900 (48200)	*28150 (62100)	*28150 (62100)		

(Heavy-lifting: "ON")

unit: kg (lb)

B	A	MAX		12.2 m (40')		10.7 m (35')		9.1 m (30')		7.6 m (25')		6.1 m (20')		4.6 m (15')	
		Cf	Cs	Cf	Cs	Cf	Cs	Cf	Cs	Cf	Cs	Cf	Cs	Cf	Cs
Arm length 3400 mm (11'2")															
9.1 m (30')		*15200 (33500)	*15200 (33500)			*18000 (39700)	*18000 (39700)								
6.1 m (20')		*15950 (35100)	13850 (30500)			*20000 (44200)	18200 (40100)	*22950 (50600)	*22950 (50600)	*27900 (61500)	*27900 (61500)				
3.0 m (10')		*18300 (40300)	12500 (27600)	*19950 (43900)	13150 (29000)	*22900 (50500)	16850 (37200)	*27500 (60600)	21800 (48100)	*34950 (77000)	28850 (63600)				
0.0 m (0')		*21000 (46300)	12950 (28600)			*24600 (54200)	15950 (35200)	*28550 (63000)	19150 (42200)	*37400 (82400)	27300 (60100)				
-3.0 m (-10')		*22700 (50100)	16000 (35300)			*22800 (50200)	16050 (35400)	*28550 (62900)	20450 (45100)	*35300 (77800)	27450 (60600)	*43850 (96700)	40100 (88400)	*39250 (86600)	*39250 (86600)
-6.1 m (-20')		*23500 (51800)	*23500 (51800)							*25400 (56000)	*25400 (56000)	*32550 (71700)	*32550 (71700)		

* Load is limited by hydraulic capacity rather than tipping.

Ratings are based on SAE Standard NO. J1097. Rated loads do not exceed 87% of hydraulic lift capacity or 75% of tipping load.

PC1250-8 (SP spec.), PC1250-8R (SP spec.)

Conditions: Boom: 7800 mm (25'7"), Bucket (SAE): 6.7 m³ (8.8 cu.yd), Shoes: 700 mm (28")

(Heavy-lifting: "ON")

unit: kg (lb)

B	A	MAX		12.2 m (40')		10.7 m (35')		9.1 m (30')		7.6 m (25')		6.1 m (20')		4.6 m (15')	
		Cf	Cs	Cf	Cs	Cf	Cs	Cf	Cs	Cf	Cs	Cf	Cs	Cf	Cs
Arm length 3400 mm (11'2")															
9.1 m (30')	*11700 (25800)	*11700 (25800)					*17050 (37600)	*17050 (37600)							
6.1 m (20')	*12250 (27000)	*12250 (27000)			*16300 (35900)	16100 (35600)	*24350 (53700)	22600 (49800)	*28750 (63400)	*28750 (63400)	*36350 (80100)	*36350 (80100)			
3.0 m (10')	*14600 (32200)	13700 (30200)			20150 (44400)	15300 (33800)	26950 (59500)	20750 (45700)	*33850 (74700)	27000 (59600)	*47450 (104600)	41150 (90700)			
0.0 m (0')	19300 (42600)	14550 (32000)			19400 (42800)	14600 (32200)	25600 (56400)	19450 (42900)	31750 (70000)	23500 (51800)	*48750 (107500)	38650 (85200)			
-3.0 m (-10')	*23900 (52700)	19550 (43100)					*23950 (52900)	19550 (43100)	*30750 (67800)	24850 (54800)	*41450 (91300)	39250 (86500)	*52450 (115700)	*52450 (115700)	
-6.1 m (-20')															

(Heavy-lifting: "OFF")

unit: kg (lb)

B	A	MAX		12.2 m (40')		10.7 m (35')		9.1 m (30')		7.6 m (25')		6.1 m (20')		4.6 m (15')	
		Cf	Cs	Cf	Cs	Cf	Cs	Cf	Cs	Cf	Cs	Cf	Cs	Cf	Cs
Arm length 3400 mm (11'2")															
9.1 m (30')	*11700 (25800)	*11700 (25800)					*17050 (37600)	*17050 (37600)							
6.1 m (20')	*12250 (27000)	*12250 (27000)			*16300 (35900)	16100 (35600)	*21150 (46600)	*21150 (46600)	*25150 (55500)	*25150 (55500)	*32100 (70800)	*32100 (70800)			
3.0 m (10')	*14600 (32200)	13700 (30200)			20150 (44400)	15300 (33800)	*24450 (54000)	20750 (45700)	*29450 (65000)	27000 (59600)	*41750 (92000)	41150 (90700)			
0.0 m (0')	19300 (42600)	14550 (32000)			19400 (42800)	14600 (32200)	25600 (56400)	19450 (42900)	*29900 (65900)	23500 (51800)	*42750 (94300)	38650 (85200)			
-3.0 m (-10')	*20500 (45200)	19550 (43100)					*20550 (45300)	19550 (43100)	*26450 (58300)	24850 (54800)	*36100 (79600)	*36100 (79600)	*45800 (100800)	*45800 (100800)	
-6.1 m (-20')															

* Load is limited by hydraulic capacity rather than tipping.
 Ratings are based on SAE Standard NO. J1097. Rated loads do not exceed 87% of hydraulic lift capacity or 75% of tipping load.

PC2000-8

Conditions: Boom: 8700 mm (28'7"), Bucket (SAE): 12.0 m³ (15.7 cu.yd), Shoes: 810 mm (32")

(Heavy-lifting: "OFF")

unit: kg (lb)

B	A	MAX		10.7 m (35')		9.1 m (30')		7.6 m (25')		6.1 m (20')		4.6 m (15')		3.0 m (10')	
		Cf	Cs	Cf	Cs	Cf	Cs	Cf	Cs	Cf	Cs	Cf	Cs	Cf	Cs
Arm length 3900 mm (12'10")															
6.1 m (20')		*21950 (48400)	*21950 (48400)	*33350 (73500)	*33350 (73500)	*38650 (85200)	*38650 (85200)	*46700 (102900)	*46700 (102900)						
3.0 m (10')		*25500 (56100)	24100 (53100)	*37150 (81900)	36050 (79400)	*44850 (98800)	*44850 (98800)	*56550 (124700)	*56550 (124700)						
0.0 m (0')		*29800 (65700)	25050 (55200)	*38500 (84800)	33600 (74100)	*47150 (103900)	43450 (95800)	*59400 (130900)	58650 (129300)	*68850 (151800)	*68850 (151800)				
-3.0 m (-10')		*30350 (66900)	*30350 (66900)	*33700 (74300)	33200 (73200)	*42650 (94000)	*42650 (94000)	*53300 (117400)	*53300 (117400)	*67000 (147700)	*67000 (147700)	*68250 (150400)	*68250 (150400)	*50150 (110600)	*50150 (110600)
-6.1 m (-20')		*27000 (59500)	*27000 (59500)					*33150 (73100)	*33150 (73100)	*42200 (93000)	*42200 (93000)	*50800 (111900)	*50800 (111900)		

(Heavy-lifting: "ON")

unit: kg (lb)

B	A	MAX		10.7 m (35')		9.1 m (30')		7.6 m (25')		6.1 m (20')		4.6 m (15')		3.0 m (10')	
		Cf	Cs	Cf	Cs	Cf	Cs	Cf	Cs	Cf	Cs	Cf	Cs	Cf	Cs
Arm length 3900 mm (12'10")															
6.1 m (20')		*24850 (54800)	*24850 (54800)	*38350 (84500)	*38350 (84500)	*44150 (97300)	*44150 (97300)	*52950 (116700)	*52950 (116700)						
3.0 m (10')		*28700 (63200)	24100 (53100)	*42800 (94300)	36050 (79400)	*51300 (113100)	475050 (103700)	*64450 (142000)	63650 (140300)						
0.0 m (0')		*34100 (75200)	25050 (55200)	*44400 (97900)	33600 (74100)	*54150 (119400)	43450 (95800)	*67900 (149600)	58650 (129300)	*62450 (137600)	*62450 (137600)				
-3.0 m (-10')		*35550 (78300)	30600 (67400)	*39250 (86500)	33200 (73200)	*49300 (108600)	42700 (94100)	*61300 (135100)	57500 (127800)	*64650 (142500)	*64650 (142500)	*61500 (135600)	*61500 (135600)	*55650 (122700)	*55650 (122700)
-6.1 m (-20')		*32150 (70800)	*32150 (70800)					*39150 (86200)	*39150 (86200)	*49500 (109000)	*49500 (109000)	*59650 (131500)	*59650 (131500)		

* Load is limited by hydraulic capacity rather than tipping.

Ratings are based on SAE Standard NO. J/ISO10567. Rated loads do not exceed 87% of hydraulic lift capacity or 75% of tipping loa

SECTION **2C**

ATTACHMENTS

CONTENTS

Buckets & Rippers for Backhoe:

- Ripper Bucket 2C-2
- Trapezoidal Bucket 2C-2
- Slope Finishing Bucket 2C-2
- Ditch Cleaning Bucket 2C-2
- Single-shank Ripper 2C-2
- Clamshell Bucket 2C-2
- Coal Bucket and Chip Bucket 2C-3
- Chip Yard Bucket 2C-3

Attachments for General Construction:

- Telescopic Arm (Upper Arm Sliding Type) 2C-4
- Super Long Front 2C-5

Ripper Bucket

Suitable for digging rock bed or hard clayey soil when normal buckets cannot penetrate deep enough. Loading is also possible.

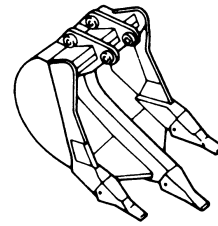

Trapezoidal Bucket

Performs digging and sloping simultaneously on a drainage or irrigation canal. Using this bucket will leave the digging profile shaped as a cross-section.

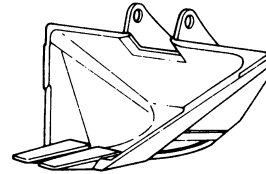

Slope Finishing Bucket

The wide bucket width and flat bottom make this bucket suitable for smoothing the slopes of irrigation canals, roads or river banks.

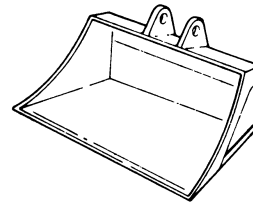

Ditch Cleaning Bucket

Most suitable for cleaning a river or dredging soft soil from the river bed. The bucket has small holes which allow the water to drain, retaining only solid objects of the ditch.

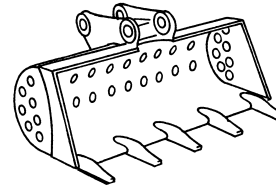

Single-shank Ripper

This ripper is used for site preparation prior to digging work, when it becomes necessary to remove rocks, pavement for other obstacles. Also effective for pulling out tree stumps.

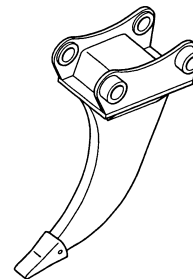

Clamshell Bucket

This type of bucket is used for digging, even below ground level.

It can also be used for placing objects up high and to move bulk materials from one point to another.

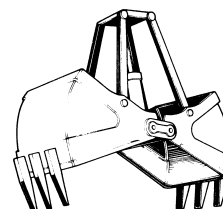

Coal Bucket and Chip Bucket

An excavator with INBOARD MATERIAL HANDLING SPECS greatly improves the working efficiency, safety and working environment when handling inboard materials like coal or chip and, in addition, its introduction leads to labor-savings.

Coal bucket

Bucket capacity : 1.3 m³ (PC130, PC138US)

Chip bucket

Bucket capacity : 1.9 m³ (PC130, PC138US)



PC130 (FOR COAL HANDLING SPECS)



FOR CHIP HANDLING SPECS

Chip Yard Bucket

An excavator with CHIP YARD SPECS provides a large capacity bucket which increases its loading efficiency higher and chip-proof structure to protect chip intrusion from the hood and exterior covers around the engine.

Bucket capacity

PC350LC 6.0 m³

PC400 7.0 m³ (Loading shovel)



PC400

Telescopic Arm (Upper Arm Sliding Type)

- With the arm extended, the machine can dig to the same depth as machines three classes higher. Useful attachment for restricted job sites where a wide working range is needed. Also slope-finishing work can be done with ease.
- Sliding mechanism using rollers on the slide surfaces makes adjustment easy and prevents vertical and horizontal vibrations of the arm, minimizing the wear which shortens arm life.
- Thanks to the hydraulic sliding system, the arm telescopes speedily, providing high working efficiency.

Unit : mm (ft in)

	Sliding amount
PC130	2100 (6'11")
PC200LC	2430 (8'0")
PC78US	1800 (5'11")
PC138US	2100 (6'11")
PC228USLC	2430 (8'0")

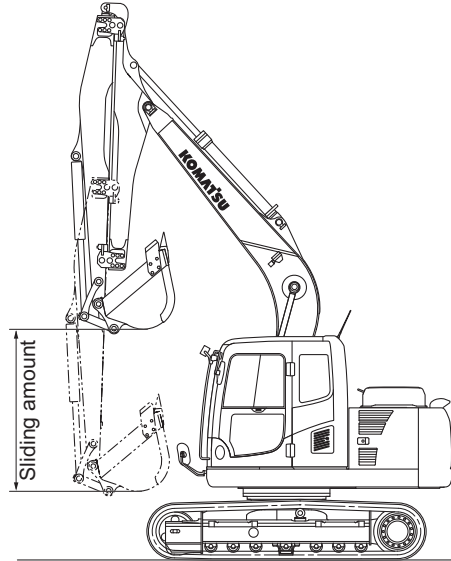

FVBH0484

Super Long Front

SUPER LONG FRONT attachment boasts a huge digging reach. An excavator with this attachment highly improves working efficiency in various works such as river conservation, lake dredging, slope-finishing and materials carrying where an extensively long reach is required.

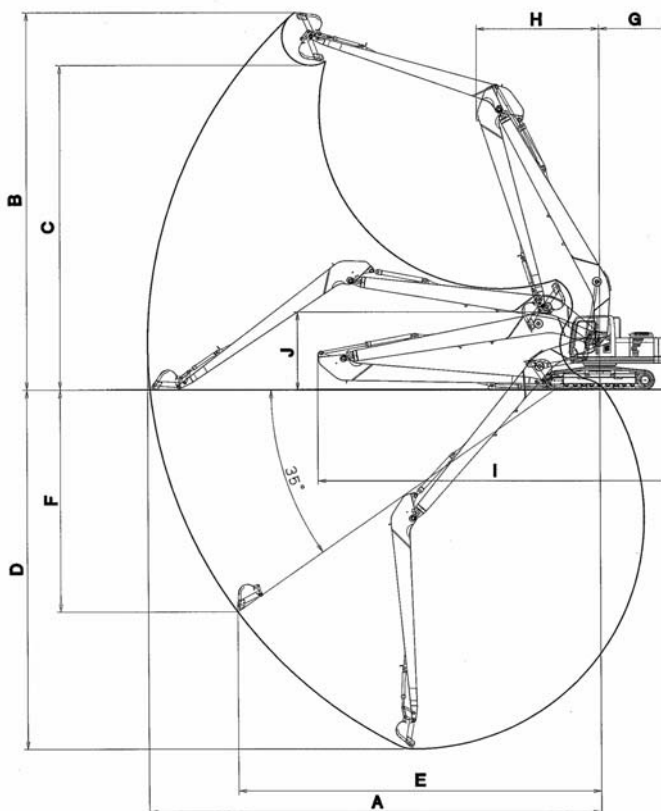

Model		PC130	PC200	PC200LC	PC200LC
Item		12.3m (40') reach	15m (49') reach	15m (49') reach	18m (59') reach
Operating weight	kg (lb)	12,600 (27,780)	21,700 (47,840)	23,100 (50,930)	26,400 (58,200)
Max. bucket capacity (SAE heaped)	m ³ (cu.yd)	0.28 (0.37)	0.37 (0.48)	0.45 (0.59)	0.29 (0.38)
Bucket width (with side cutters)	mm (ft.in)	750 (2'6")	860 (2'10")	955 (3'2")	720 (2'4")
Standard shoe width	mm (in)	500 (20")	600 (24")	700 (28")	700 (28")
Ground pressure	kg/cm ² (PSI)	0.41 (5.8)	0.50 (7.1)	0.41 (5.8)	0.47 (6.7)
I Overall length	mm (ft.in)	9,920 (32'7")	12,510 (41'1")	12,510 (41'1")	14,360 (47'1")
J Overall height	mm (ft.in)	2,835 (9'4")	3,080 (10'1")	3,080 (10'1")	3,190 (10'6")
Boom length	m (ft.in)	6.9 (22'8")	8.6 (28'3")	8.6 (28'3")	10.3 (33'10")
Arm length	m (ft.in)	4.9 (16'1")	6.4 (21'0")	6.4 (21'0")	8.2 (26'11")
A Working range : Max. digging reach	mm (ft.in)	12,330 (40'5")	15,250 (50'0")	15,250 (50'0")	18,340 (60'2")
B Max. digging height	mm (ft.in)	11,640 (38'2")	13,730 (45'1")	13,730 (45'1")	15,380 (50'6")
C Max. dumping height	mm (ft.in)	9,600 (31'6")	11,520 (37'10")	11,520 (37'10")	13,225 (43'5")
D Max. digging depth	mm (ft.in)	9,190 (30'2")	11,530 (37'10")	11,530 (37'10")	14,610 (47'11")
E Digging reach at 35° angle	mm (ft.in)	9,850 (32'4")	12,130 (39'10")	12,190 (40'0")	14,730 (48'4")
F Digging depth at 35° angle	mm (ft.in)	5,900 (19'4")	7,350 (24'1")	7,260 (23'10")	9,030 (29'8")
G Tail swing radius	mm (ft.in)	2,190 (7'2")	4,000 (13'1")	4,000 (13'1")	4,980 (16'4")
H Min. swing radius	mm (ft.in)	2,875 (9'5")	2,940 (9'8")	2,940 (9'8")	2,940 (9'8")

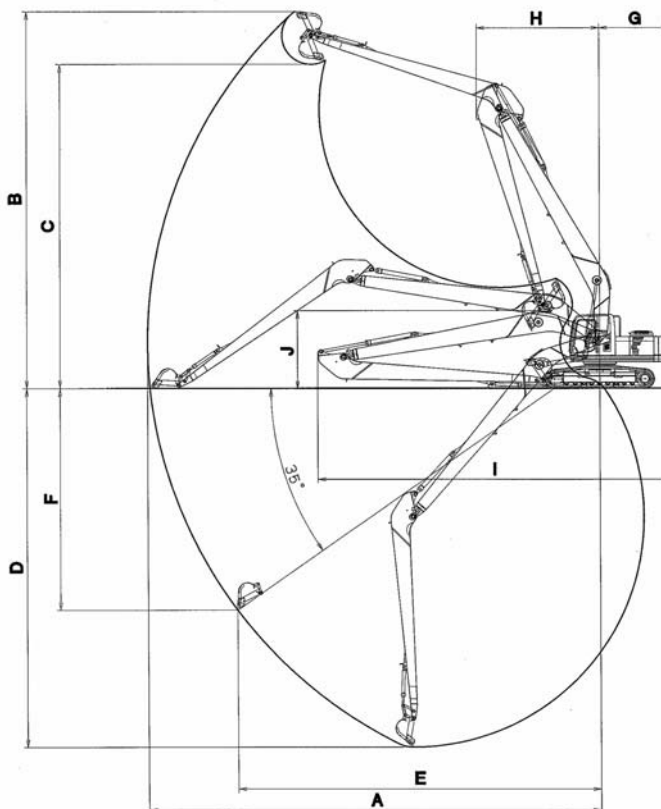

Item		Model	PC220LC	PC300LC	PC400LC
			18m (59') reach	16.5m (54') reach	20m (65') reach
Operating weight	kg (lb)	26,950 (59,410)	35,600 (78,480)	49,400 (108,900)	
Max. bucket capacity (SAE heaped)	m ³ (cu.yd)	0.45 (0.59)	0.69 (0.90)	0.8 (1.05)	
Bucket width (with side cutters)	mm (ft.in)	955 (3'2")	930 (3'1")	1030 (3'5")	
Standard shoe width	mm (in)	700 (28")	700 (28")	700 (28")	
Ground pressure	kg/cm ² (PSI)	0.47 (6.7)	0.58 (8.3)	0.75 (10.7)	
I Overall length	mm (ft.in)	14,430 (47'4")	13,930 (45'8")	16,150 (53'0")	
J Overall height	mm (ft.in)	3,190 (10'6")	3,490 (11'5")	3,660 (12'0")	
Boom length	m (ft.in)	10.3 (33'10")	9.2 (30'2")	11.1 (36'5")	
Arm length	m (ft.in)	8.2 (26'11")	6.4 (21'0")	8.3 (27'3")	
A Working range : Max. digging reach	mm (ft.in)	18,360 (60'3")	16,570 (54'4")	19,680 (64'7")	
B Max. digging height	mm (ft.in)	15,120 (49'7")	12,740 (41'10")	14,990 (49'2")	
C Max. dumping height	mm (ft.in)	12,980 (42'7")	9,930 (32'7")	12,200 (40'0")	
D Max. digging depth	mm (ft.in)	14,645 (48'1")	12,720 (41'9")	14,800 (48'7")	
E Digging reach at 35° angle	mm (ft.in)	14,895 (48'10")	13,250 (43'6")	15,770 (51'9")	
F Digging depth at 35° angle	mm (ft.in)	8,810 (28'11")	7,890 (25'11")	9,520 (31'3")	
G Tail swing radius	mm (ft.in)	4,980 (16'4")	3,600 (11'10")	3,795 (12'5")	
H Min. swing radius	mm (ft.in)	2,940 (9'8")	6,130 (20'1")	6,790 (22'3")	

SECTION **2D**

**HYDRAULIC
LOADING SHOVELS**

CONTENTS

Features 2D-2
Specifications 2D-4
Dimensions 2D-8
Working Ranges and Digging Force 2D-10
Component Dimensions and Weights 2D-11
Ground Pressure 2D-22
Loading Shovel Buckets 2D-24
Model Selection 2D-25
Production 2D-26

Komatsu Mining Shovel Front Shovel Features

High production with low running costs

High digging forces provide fast cycle times and low cost per tonnage

Environmental harmony

- Komatsu engines which meet EPA, EU and Japan emission regulations
- Extended oil change intervals and filter replacement intervals to reduce environmental impacts
- Long term experience in use of biological hydraulic oils and lubricants, as an option available

Large, comfortable and safe mining operator's cab

- Integrated FOPS structure according to ISO 3449
- Internal floor area about 4.2 m² (5.0 yd²)
- Large windows for good all around visibility
- Side sliding windows
- Pressurised to keep dust out
- Noise level in cab approx. 76 dB(A) according ISO 63096
- High intensive XENON working lights.
- Cab heating and air conditioner of 10 kW
- Comfortable multi-functional operator seat with internal heating
- Second swing out fold away seat for trainer
- Wash-hand basin
- Refrigerator

ECS or VHMS monitoring system for greater machine efficiency and low maintenance time

- Comprehensive overview of shovel functions with operator friendly display
- Optional data transfer possibility via Modular Mining System controller
- All important machine running data are monitored and electronically stored, with down load facility
- Acoustic and visually alarms warn of machine malfunctions

Komatsu engine

- Latest engine technology compliant with emission regulations
- Engine life time self cleaning stainless steel engine oil filter (ELIMINATOR) to avoid filter change; only filter cleaning at every 1000 hours is required
- Engine oil management system (Reserve and Centinel system) to extend oil change intervals up to 4000 hours
- Fuel tank capacity for continuous work up to 24 hours

Electric drive as option

- Electric motor 6600/7200 V and 50 or 60 Hz available
- Squirrel cage motor with soft start
- Optimized electrical design for all international standards
- Compact design with low vibration and noise
- Cable drum with automatic tensioning, as option

Komatsu hydraulic system HYDRO-PILOT

- Multi-circuit hydraulic system with electronic load governor, pump flow summation capability, and oil flow priority based on demand, for fast working cycles and high productivity
- All main hydraulic circuits are run at one pressure level only, simplifying pressure adjustment and service
- Each circuit with connection facility for pressure check gauges
- Changing from front shovel to backhoe is simple
- Un-pressurised hydraulic tank with large pump suction lines and low pump speed prevents risk of cavitation
- Each hydraulic circuit protected with high pressure filters
- Full flow 10 µm return line filters for system safety and for supplementary circuits 3 µm by-pass filter to improve oil quality for long component lifetime
- Swing out hydraulic cooler for simple cleaning to keep the cooling efficiency
- Float valves for improved hydraulic system

Heavy-duty shovel undercarriage design

- Komatsu Mining track system with oscillating shoes for optimum response to rugged mining ground conditions
- Lifetime lubricated rollers
- Automatic track tensioning system
- Track shoes in high quality casting steel and engineered by finite element method
- Precision hard facing of contact surfaces for long term performance
- Different width of shoes available for best performance in softer mining ground conditions

Attachments

- Front shovel attachment available for all mining applications
- Closed box design combining steel plates and castings, engineered by finite element method for full lifetime
- Wide selection of buckets and customised options
- Bucket wear package ranges to meet all mining conditions
- Attachment pin sealing arrangement for reduced bearing wear-parts costs

Service

- Hydraulically assisted ladder for ease and convenience access
- Upper structure walkway allows safe access to all service points
- Walk in machinery house provides all weather protection for service attention
- Automatic central lubrication system for attachment and main swing bearing
- Swing down service arm for fast, ground level refilling and evacuation and the minimizing of leakages during service
- Complete machine delivered in pre-tested modules for fast erection on job site

Specifications

HYDRAULIC LOADING SHOVELS

Item	Model	*PC400-8 PC400-8R	*PC400-8*** PC400-8R***	PC400-7	PC400-7***	
OPERATING WEIGHT*	kg (lb)	43440 (95,770)	44700 (98,550)	43100 (95,020)	44100 (97,200)	
HORSEPOWER	SAE J1995 Gross ISO9249 /SAE J1349 Net Hyd. fan at max. speed Net	kW (HP)/RPM kW (HP)/RPM kW (HP)/RPM	270 (362)/1900 257 (345)/1900	270 (362)/1900 257 (345)/1900	259 (347)/1850 246 (330)/1850	259 (347)/1850 246 (330)/1850
BUCKET CAPACITY RANGE	m ³ (cu.yd)	2.6 (3.4)	2.6 (3.4)	2.6 (3.4)	2.6 (3.4)	
PERFORMANCE:						
Swing speed	RPM	9.1	9.1	9.0	9.0	
Max.travel speed	Hi Mi Lo km/h (MPH)	5.5 (3.4) 4.0 (2.5) 3.0 (1.9)	5.5 (3.4) 4.0 (2.5) 3.0 (1.9)	5.5 (3.4) 4.4 (2.7) 3.0 (1.9)	5.5 (3.4) 4.4 (2.7) 3.0 (1.9)	
DIMENSIONS:	See the page of DIMENSIONS					
ENGINE:		KOMATSU	KOMATSU	KOMATSU	KOMATSU	
Model		SAA6D125E-5	SAA6D125E-5	SAA6D125E-3	SAA6D125E-3	
No. of cylinders- bore × stroke	mm (in)	6-125 × 150 (4.92 × 5.91)	6-125 × 150 (4.92 × 5.91)	6-125 × 150 (4.92 × 5.91)	6-125 × 150 (4.92 × 5.91)	
Piston displacement	ltr. (cu.in)	11.04 (673)	11.04 (673)	11.04 (673)	11.04 (673)	
HYDRAULIC SYSTEM:		2 × Variable Piston	2 × Variable Piston	2 × Variable Piston	2 × Variable Piston	
Hydraulic pump	ltr. (U.S. Gal)/min.	690 (182)	690 (182)	690 (182)	690 (182)	
Max. oil flow	kg/cm ² (PSI)	355 (5050)	355 (5050)	355 (5050)	355 (5050)	
Max. oil pressure (Implement)						
TRACK SHOES:						
Width/ground pressure	mm (in)/ kg/cm ² (PSI)	600 (24)/ 0.83 (11.8)	600 (24)/ 0.85 (12.1)	600 (24)/ 0.83 (11.8)	600 (24)/ 0.85 (12.1)	
CAPACITY (Refilled):						
Fuel tank	ltr. (U.S. Gal)	650 (1727)	650 (1727)	650 (172)	650 (172)	
Hydraulic oil tank		248 (65.5)	248 (65.5)	248 (65.5)	248 (65.5)	
MACHINE SPEC:						
Boom	mm (ft.in)	4000 (13'1")	4000 (13'1")	4000 (13'1")	4000 (13'1")	
Arm	mm (ft.in)	2900 (9'6")	2900 (9'6")	2900 (9'6")	2900 (9'6")	
Bucket	m ³ (cu.yd)	2.6 (3.4)	2.6 (3.4)	2.6 (3.4)	2.6 (3.4)	

Item	Model	*PC400LC-8 PC400LC-8R	*PC400LC-8*** PC400LC-8R***	PC400LC-7	PC400LC-7***	
OPERATING WEIGHT*	kg (lb)	44840 (98,850)	45900 (101,190)	44300 (97,660)	45200 (99,650)	
HORSEPOWER	SAE J1995 Gross ISO9249 /SAE J1349 Net Hyd. fan at max. speed Net	kW (HP)/RPM kW (HP)/RPM kW (HP)/RPM	270 (362)/1900 257 (345)/1900	270 (362)/1900 257 (345)/1900	259 (347)/1850 246 (330)/1850	259 (347)/1850 246 (330)/1850
BUCKET CAPACITY RANGE	m ³ (cu.yd)	2.6 (3.4)	2.6 (3.4)	2.6 (3.4)	2.6 (3.4)	
PERFORMANCE:						
Swing speed	RPM	9.1	9.1	9.0	9.0	
Max.travel speed	Hi Mi Lo km/h (MPH)	5.5 (3.4) 4.0 (2.5) 3.0 (1.9)	5.5 (3.4) 4.0 (2.5) 3.0 (1.9)	5.5 (3.4) 4.4 (2.7) 3.0 (1.9)	5.5 (3.4) 4.4 (2.7) 3.0 (1.9)	
DIMENSIONS:	See the page of DIMENSIONS					
ENGINE:		KOMATSU	KOMATSU	KOMATSU	KOMATSU	
Model		SAA6D125E-5	SAA6D125E-5	SAA6D125E-3	SAA6D125E-3	
No. of cylinders- bore × stroke	mm (in)	6-125 × 150 (4.92 × 5.91)	6-125 × 150 (4.92 × 5.91)	6-125 × 150 (4.92 × 5.91)	6-125 × 150 (4.92 × 5.91)	
Piston displacement	ltr. (cu.in)	11.04 (673)	11.04 (673)	11.04 (673)	11.04 (673)	
HYDRAULIC SYSTEM:		2 × Variable Piston	2 × Variable Piston	2 × Variable Piston	2 × Variable Piston	
Hydraulic pump	ltr. (U.S. Gal)/min.	690 (182)	690 (182)	690 (182)	690 (182)	
Max. oil flow	kg/cm ² (PSI)	355 (5050)	355 (5050)	355 (5050)	355 (5050)	
Max. oil pressure (Implement)						
TRACK SHOES:						
Width/ground pressure	mm (in)/ kg/cm ² (PSI)	700 (28)/ 0.68 (9.7)	700 (28)/ 0.70 (10.0)	700 (28)/ 0.68 (9.7)	600 (24)/ 0.69 (9.8)	
CAPACITY (Refilled):						
Fuel tank	ltr. (U.S. Gal)	650 (1727)	650 (1727)	650 (172)	650 (172)	
Hydraulic oil tank		248 (65.5)	248 (65.5)	248 (65.5)	248 (65.5)	
MACHINE SPEC:						
Boom	mm (ft.in)	4000 (13'1")	4000 (13'1")	4000 (13'1")	4000 (13'1")	
Arm	mm (ft.in)	2900 (9'6")	2900 (9'6")	2900 (9'6")	2900 (9'6")	
Bucket	m ³ (cu.yd)	2.6 (3.4)	2.6 (3.4)	2.6 (3.4)	2.6 (3.4)	

* Operating weight includes coolant, lubricants, full fuel tank, operator 80kg (180lb) and, indicated implement and shoes.

*** Variable gauge

- Tier 3 and Stage 3A model

Specifications

HYDRAULIC LOADING SHOVELS

Item	Model	•PC600-8E0 PC600-8R1	PC600-7	•PC600LC-8E0 PC600LC-8R1	PC600LC-7
OPERATING WEIGHT*	kg (lb)	63200 (139,330)	61100 (134,700)	64200 (141,540)	62200 (137,130)
HORSEPOWER	SAE J1995 Gross ISO9249 /SAE J1349 Net Hyd. fan at max. speed Net	kW (HP)/RPM 323 (433)/1800 kW (HP)/RPM 320 (429)/1800 kW (HP)/RPM 288 (368)/1800	287 (385)/1800	323 (433)/1800 320 (429)/1800 288 (368)/1800	287 (385)/1800
BUCKET CAPACITY RANGE	m ³ (cu.yd)	4.0 (5.2)	4.0 (5.2)	4.0 (5.2)	4.0 (5.2)
PERFORMANCE:					
Swing speed	RPM	8.3	8.3	8.3	8.3
Max.travel speed	Hi Mi Lo km/h (MPH)	4.9 (3.0)	4.9 (3.0)	4.9 (3.0)	4.9 (3.0)
		3.0 (1.9)	3.0 (1.9)	3.0 (1.9)	3.0 (1.9)
DIMENSIONS:	See the page of DIMENSIONS				
ENGINE:					
Model		KOMATSU SAA6D140E-5	KOMATSU SA6D140E-3	KOMATSU SAA6D140E-5	KOMATSU SA6D140E-3
No. of cylinders- bore × stroke	mm (in)	6-140 × 165 (5.51 × 6.50)	6-140 × 165 (5.51 × 6.50)	6-140 × 165 (5.51 × 6.50)	6-140 × 165 (5.51 × 6.50)
Piston displacement	ltr. (cu.in)	15.24 (930)	15.24 (930)	15.24 (930)	15.24 (930)
HYDRAULIC SYSTEM:					
Hydraulic pump		2 × Variable Piston	2 × Variable Piston	2 × Variable Piston	2 × Variable Piston
Max. oil flow	ltr. (U.S. Gal)/min.	820 (217)	820 (217)	820 (217)	820 (217)
Max. oil pressure (Implement)	kg/cm ² (PSI)	300 (4270)	300 (4290)	300 (4270)	300 (4270)
TRACK SHOES:					
Width/ground pressure	mm (in)/ kg/cm ² (PSI)	600 (24)/ 1.14 (16.2)	600 (24)/ 1.11 (15.8)	600 (24)/ 1.08 (15.4)	600 (24)/ 1.05 (14.9)
CAPACITY (Refilled):					
Fuel tank	ltr. (U.S. Gal)	880 (232.5)	880 (232)	880 (232.5)	880 (232)
Hydraulic oil tank		360 (95.0)	360 (95.0)	360 (95.0)	360 (95.0)
MACHINE SPEC:					
Boom	mm (ft.in)	4000 (13'1")	4000 (13'1")	4000 (13'1")	4000 (13'1")
Arm	mm (ft.in)	3000 (9'10")	3000 (9'10")	3000 (9'10")	3000 (9'10")
Bucket	m ³ (cu.yd)	4.0 (5.2)	4.0 (5.2)	4.0 (5.2)	4.0 (5.2)

Item	Model	PC750-7	•PC800-8E0 PC800-8R1	•PC1250-8 PC1250-8R	PC1250-7
OPERATING WEIGHT*	kg (lb)	76000 (167,550)	77300 (170,420)	110900 (244,490)	110000 (242,510)
HORSEPOWER	SAE J1995 Gross ISO9249 /SAE J1349 Net Hyd. fan at max. speed Net	kW (HP)/RPM 338 (454)/1800	370 (496)/1800 363 (487)/1800 338 (454)/1800	514 (688)/1800 502 (672)/1800 463 (620)/1800	485 (651)/1800
BUCKET CAPACITY RANGE	m ³ (cu.yd)	4.5, 5.1 (5.9) (6.7)	4.5, 5.1 (5.9) (6.7)	6.5 (8.5)	6.5 (8.5)
PERFORMANCE:					
Swing speed	RPM	6.8	6.8	6.8	5.5
Max.travel speed	Hi Mi Lo km/h (MPH)	4.2 (2.6)	4.2 (2.6)	4.2 (2.6)	3.2 (2.0)
		2.8 (1.7)	2.8 (1.7)	2.8 (1.7)	2.1 (1.3)
DIMENSIONS:	See the page of DIMENSIONS				
ENGINE:					
Model		KOMATSU SAA6D140E-3	KOMATSU SAA6D140E-5	KOMATSU SAA6D170E-5	KOMATSU SAA6D170E-3
No. of cylinders- bore × stroke	mm (in)	6-140 × 165 (5.51 × 6.50)	6-140 × 165 (5.51 × 6.50)	6-170 × 170 (6.69 × 6.69)	6-170 × 170 (6.69 × 6.69)
Piston displacement	ltr. (cu.in)	15.24 (930)	15.24 (930)	23.15 (1413)	23.15 (1413)
HYDRAULIC SYSTEM:					
Hydraulic pump		2 × Variable Piston	2 × Variable Piston	3 × Variable Piston	3 × Variable Piston
Max. oil flow	ltr. (U.S. Gal)/min.	988 (261)	988 (261)	1588 (420)	1588 (420)
Max. oil pressure (Implement)	kg/cm ² (PSI)	320 (4550)	320 (4550)	320 (4550)	320 (4550)
TRACK SHOES:					
Width/ground pressure	mm (in)/ kg/cm ² (PSI)	610 (24)/ 1.26 (17.9)	610 (24)/ 1.28 (18.2)	700 (28)/ 1.45 (20.6)	700 (28)/ 1.44 (20.1)
CAPACITY (Refilled):					
Fuel tank	ltr. (U.S. Gal)	880 (232)	980 (259)	1360 (359)	1360 (359)
Hydraulic oil tank		440 (116)	470 (124.2)	670 (177)	670 (177)
MACHINE SPEC:					
Boom	mm (ft.in)	4600 (15'1")	4600 (15'1")	5300 (17'5")	5300 (17'5")
Arm	mm (ft.in)	3400 (11'2")	3400 (11'2")	3800 (12'6")	3800 (12'6")
Bucket	m ³ (cu.yd)	4.5 (5.9)	4.5 (5.9)	6.5 (8.5)	6.5 (8.5)

- * Operating weight includes coolant, lubricants, full fuel tank, operator 80kg (180lb) and, indicated implement and shoes.
- Tier 3 and Stage 3A model

Specifications

HYDRAULIC LOADING SHOVELS

Item	Model	PC2000-8	PC3000-6 Diesel Tier 1	PC3000-6 Diesel Tier 2	PC3000E-6 Electric Drive
OPERATING WEIGHT*	kg (lb)	195000 (429,900)	249300 (549,600)	249300 (549,600)	251200 (553,200)
HORSEPOWER SAE J1995 Gross ISO9249 /SAE J1349 Net Hyd. fan at max. speed Net	kW (HP)/RPM kW (HP)/RPM kW (HP)/RPM	728 (976)/1800 713 (956)/1800 679 (910)/1800	940 (1260)/1800 895 (1200)/1800	940 (1260)/1800 895 (1200)/1800	900 (1206)
BUCKET CAPACITY RANGE	m ³ (cu.yd)	11 (14.4)	10 ~ 20 (13.1) (26.2)	10 ~ 20 (13.1) (26.2)	10 ~ 20 (13.1) (26.2)
PERFORMANCE: Swing speed Max.travel speed	RPM km/h (MPH) Hi Mi Lo	4.8 2.7 (1.7)	4.6 2.4 (1.5)	4.6 2.4 (1.5)	4.6 2.4 (1.5)
DIMENSIONS: See the page of DIMENSIONS					
ENGINE (Electric Motor): Model No. of cylinders- bore × stroke Piston displacement	mm (in) ltr. (cu.in)	KOMATSU SAA12V140E-3 12-140 × 165 (5.51 × 6.50) 30.48 (1860)	KOMATSU SSA12V159 12-159 × 159 (6.26 × 6.26) 37.5 (2288)	KOMATSU SSA12V159E-2 12-159 × 159 (6.26 × 6.26) 37.5 (2288)	Siemens (6.6 kV) 1LA452
HYDRAULIC SYSTEM: Hydraulic pump Max. oil flow Max. oil pressure (Implement)	ltr. (U.S. Gal)/min. kg/cm ² (PSI)	2 × Variable Piston 2317 (612) 300 (4270)	3 × Variable Piston 2730 (721) 310 (4410)	3 × Variable Piston 2730 (721) 310 (4410)	3 × Variable Piston 2730 (721) 316 (4495)
TRACK SHOES: Width/ground pressure	mm (in)/ kg/cm ² (PSI)	810 (32)/ 1.90 (27.0)	800 (31.5)/ 2.34 (33.3)	800 (31.5)/ 2.34 (33.3)	800 (31.5)/ 2.35 (33.4)
CAPACITY (Refilled): Fuel tank Hydraulic oil tank	ltr. (U.S. Gal)	3400 (898) 1300 (344)	4500 (1190) 2900 (765)	4500 (1190) 2900 (765)	2900 (765)
MACHINE SPEC: Boom Arm Bucket	mm (ft.in) mm (ft.in) m ³ (cu.yd)	5950 (19'6") 4450 (14'7") 11 (14.4)	6000 (19'8") 4300 (14'1") 15.0 (19.6)	6000 (19'8") 4300 (14'1") 15.0 (19.6)	6000 (19'8") 4300 (14'1") 15.0 (19.6)

Item	Model	PC4000-6 Diesel Tier 1	PC4000-6 Diesel Tier 2	PC4000E-6 Electric Drive	PC5500-6 Diesel Tier 1
OPERATING WEIGHT*	kg (lb)	387700 (854,700)	387700 (854,700)	379300 (836,200)	531200 (1,171,100)
HORSEPOWER SAE J1995 Gross ISO9249 /SAE J1349 Net Hyd. fan at max. speed Net	kW (HP)/RPM kW (HP)/RPM kW (HP)/RPM	1400 (1875)/1800 1324 (1775)/1800	1400 (1875)/1800 1324 (1775)/1800	1350 (1810)	1880 (2520)/1800 1825 (2446)/1800
BUCKET CAPACITY RANGE	m ³ (cu.yd)	16 ~ 28 (20.9) (36.6)	16 ~ 28 (20.9) (36.6)	16 ~ 28 (20.9) (36.6)	20 ~ 36 (26.2) (47.1)
PERFORMANCE: Swing speed Max.travel speed	RPM km/h (MPH) Hi Mi Lo	4.0 2.1 (1.3)	4.0 2.1 (1.3)	4.0 2.1 (1.3)	3.1 2.1 (1.3)
DIMENSIONS: See the page of DIMENSIONS					
ENGINE (Electric Motor): Model No. of cylinders- bore × stroke Piston displacement	mm (in) ltr. (cu.in)	KOMATSU SDA16V160 16-159 × 190 (6.26 × 7.48) 60.2 (3673)	KOMATSU SDA16V160E-2 16-159 × 190 (6.26 × 7.48) 60.2 (3673)	ABB (6.6 kV) AMA500L4A	KOMATSU 2 × SSA12V159 12-159 × 159 (6.26 × 6.26) 2 × 37.5 (2288)
HYDRAULIC SYSTEM: Hydraulic pump Max. oil flow Max. oil pressure (Implement)	ltr. (U.S. Gal)/min. kg/cm ² (PSI)	4 × Variable Piston 4140 (1094) 316 (4495)	4 × Variable Piston 4140 (1094) 316 (4495)	4 × Variable Piston 4140 (1094) 316 (4495)	6 × Variable Piston 4200 (1110) 316 (4495)
TRACK SHOES: Width/ground pressure	mm (in)/ kg/cm ² (PSI)	1200 (47)/ 2.17 (30.9)	1200 (47)/ 2.17 (30.9)	1200 (47)/ 2.12 (30.1)	1350 (53)/ 2.39 (34.0)
CAPACITY (Refilled): Fuel tank Hydraulic oil tank	ltr. (U.S. Gal)	6400 (1691) 3900 (1030)	6400 (1691) 3900 (1030)	— 3900 (1030)	10800 (2853) 3800 (1004)
MACHINE SPEC: Boom Arm Bucket	mm (ft.in) mm (ft.in) m ³ (cu.yd)	7150 (23'6") 4900 (16'1") 22.0 (28.8)	7150 (23'6") 4900 (16'1") 22.0 (28.8)	7150 (23'6") 4900 (16'1") 22.0 (28.8)	7600 (24'11") 5600 (18'4") 29.0 (37.9)

* Operating weight includes coolant, lubricants, full fuel tank, operator 80 kg (180 lb) and, indicated implement and shoes.

Specifications

HYDRAULIC LOADING SHOVELS

Item	Model	PC5500-6 Diesel Tier 2	PC5500E-6 Electric Drive	PC8000-6 Diesel Tier 2	PC8000E-6 Electric drive
OPERATING WEIGHT*	kg (lb)	532700 (1,174,400)	526400 (1,166,000)	743200 (1,638,500)	725550 (1,599,400)
HORSEPOWER SAE J1995 Gross ISO9249 /SAE J1349 Net Hyd. fan at max. speed Net	kW (HP)/RPM kW (HP)/RPM kW (HP)/RPM	1880 (2520)/1800 1825 (2446)/1800	1800 (2412)	3000 (4021)/1800 2882 (3863)/1800	2900 (3887)
BUCKET CAPACITY RANGE	m ³ (cu.yd)	20 ~ 36 (26.2) (47.1)	20 ~ 36 (26.2) (47.1)	28 ~ 50 (36.6) (65.4)	28 ~ 50 (36.6) (65.4)
PERFORMANCE: Swing speed Max.travel speed	RPM km/h (MPH) Hi Mi Lo	3.1 2.1 (1.3)	3.1 2.1 (1.3)	2.7 2.4 (1.5)	2.7 2.4 (1.5)
DIMENSIONS:	See the page of DIMENSIONS				
ENGINE (Electric Motor): Model No. of cylinders- bore × stroke Piston displacement	mm (in) ltr. (cu.in)	KOMATSU 2 × SDA12V159E-2 12-159 × 159 (6.26 × 6.26) 2 × 37.5 (2288)	2 × ABB (6.6 kV) AMA450L4A	KOMATSU 2 × SDA16V160E-2 16-159 × 190 (6.26 × 7.48) 2 × 60.2 (3673)	ABB (6.6 kV) 2 × AMA500L4A
HYDRAULIC SYSTEM: Hydraulic pump Max. oil flow Max. oil pressure (Implement)	ltr. (U.S. Gal)/min. kg/cm ² (PSI)	6 × Variable Piston 4200 (1110) 316 (4495)	6 × Variable Piston 4200 (1110) 316 (4495)	8 × Variable Piston 8280 (2188) 316 (4495)	8 × Variable Piston 8280 (2188) 316 (4495)
TRACK SHOES: Width/ground pressure	mm (in)/ kg/cm ² (PSI)	1350 (53)/ 2.40 (34.1)	1350 (53)/ 2.37 (33.7)	1500 (59)/ 2.75 (39.1)	1500 (59)/ 2.68 (38.1)
CAPACITY (Refilled): Fuel tank Hydraulic oil tank	ltr. (U.S. Gal)	10800 (2853) 3800 (1004)	— 3800 (1004)	13500 (3567) 8350 (2205)	— 8350 (2205)
MACHINE SPEC: Boom Arm Bucket	mm (ft.in) mm (ft.in) m ³ (cu.yd)	7600 (24'11") 5600 (18'4") 29.0 (37.9)	7600 (24'11") 5600 (18'4") 29.0 (37.9)	8150 (26'9") 5750 (18'10") 42.0 (55)	8150 (26'9") 5750 (18'10") 42.0 (55)

* Operating weight includes coolant, lubricants, full fuel tank, operator 80 kg (180 lb) and, indicated implement and shoes.

Dimensions

HYDRAULIC LOADING SHOVELS

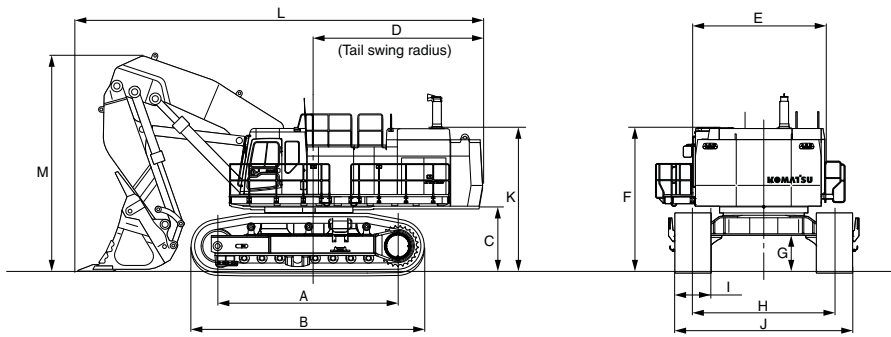

FVBH0104

	A mm (ft.in)	B mm (ft.in)	C mm (ft.in)	D mm (ft.in)	E mm (ft.in)	F mm (ft.in)	G mm (ft.in)	H mm (ft.in)	I mm (ft.in)	J mm (ft.in)	K mm (ft.in)	L mm (ft.in)	M mm (ft.in)
PC400-8	4020 (13'2")	5055 (16'7")	1320 (4'4")	3645 (12'0")	3090 (10'2")	3285 (10'9")	555 (1'10")	2740 (9')	600 (24")	3340 (11')	2920 (9'7")	8455 (27'9")	4400 (14'5")
PC400-8R							685 (2'3")	2890 (9'6")		3490 (11'5")			
PC400-8***										2990** (9'10")			
PC400-8R***										3440 (11'3")			
PC400LC-8	4350 (14'3")	5385 (17'8")	1320 (4'4")	3645 (12'0")	3090 (10'2")	3285 (10'9")	550 (1'10")	2740 (9')	700 (28")	3440 (11'3")	2920 (9'7")	8455 (27'9")	4400 (14'5")
PC400LC-8***							685 (2'3")	2890 (9'6")		3590 (11'9")			
										3090** (10'2")			
PC400-7	4020 (13'2")	5055 (16'7")	1320 (4'4")	3645 (12'0")	2995 (9'10")	3265 (10'9")	555 (1'10")	2740 (9')	600 (24")	3340 (11')	2715 (8'11")	8455 (27'9")	4400 (14'5")
PC400-7***							685 (2'3")	2890 (9'6")		3490 (11'5")			
										2990** (9'10")			
PC400LC-7	4350 (14'3")	5385 (17'8")	1320 (4'4")	3645 (12'0")	2995 (9'10")	3265 (10'9")	550 (1'10")	2740 (9')	700 (28")	3440 (11'3")	2715 (8'11")	8455 (27'9")	4400 (14'5")
PC400LC-7***							685 (2'3")	2890 (9'6")		3590 (11'9")			
										3090** (10'2")			
PC600-7	4250 (13'11")	5370 (17'7")	1370 (4'6")	3675 (12'1")	3170 (10'5")	3295 (10'10")	790 (2'7")	3300 (10'10")	600 (24")	3900 (12'10")	3075 (10'1")	8815 (28'11")	5540 (18'2")
PC600LC-7	4600 (15'1")	5690 (18'8")											
PC600-8E0 PC600-8R1	4250 (13'11")	5360 (17'7")								1365 (4'6")			
PC600LC-8E0 PC600LC-8R1	4600 (15'1")	5710 (18'9")	3190** (10'6")										
PC750-7	4500 (14'9")	5810 (19'1")	1560 (5'1")	4245 (13'11")	3195 (10'6")	3560 (11'8")	840 (2'9")	3500 (11'6")	610 (24")		4110 (13'6")	3445 (11'4")	9865 (32'4")
PC800-8E0 PC800-8R1	4500 (14'9")	5810 (19'1")	1560 (5'1")	4400 (14'5")	3195 (10'6")	3570 (11'9")	840 (2'9")	3500 (11'6")	610 (24")	4110 (13'6")	3670 (12')	10075 (33'1")	5790 (19'0")
PC1250-7	4995 (16'5")	6425 (21'1")	1790 (5'10")	4810 (15'9")	3470 (11'5")	4120 (13'6")	990 (3'3")	3900 (12'10")	700 (28")	4600 (15'1")	3925 (12'11")	10940 (35'11")	6200 (20'4")
PC1250-8 PC1250-8R	4995 (16'5")	6425 (21'1")	1790 (5'10")	4870 (16'0")	3470 (11'5")	4120 (13'6")	990 (3'3")	3900 (12'10")	700 (28")	4600 (15'1")	4075 (13'4")	10940 (35'11")	6200 (20'4")
PC2000-8	5780 (19')	7445 (24'5")	2095 (6'10")	5980 (19'7")	7490 (24'7")	7030 (23'1")	825 (2'8")	4600 (15'1")	810 (32")	5410 (17'9")	5970 (19'7")	13075 (42'11")	8180 (26'10")

** When retracted

*** Variable gauge

Dimensions

HYDRAULIC LOADING SHOVELS

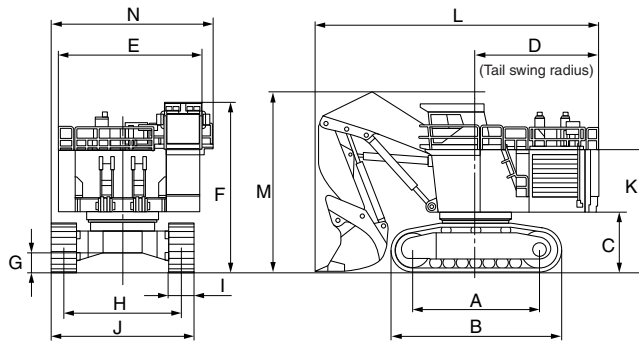

FVBH0108

	A mm (ft.in)	B mm (ft.in)	C mm (ft.in)	D mm (ft.in)	E mm (ft.in)	F mm (ft.in)	G mm (ft.in)	H mm (ft.in)	I mm (ft.in)	J mm (ft.in)	K mm (ft.in)	L mm (ft.in)	M mm (ft.in)	N mm (ft.in)
PC3000-6	6000 (19'8")	7930 (25'11")	2670 (8'9")	6410 (21'0")	6070 (19'11")	7455 (24'6")	935 (3'1")	4800 (15'9")	800 (31'5")	5600 (18'4")	5255 (17'3")	13700 (44'11")	8000 (26'3")	6800 (22'4")
PC3000E-6														
PC4000-6	6700 (22'0")	8842 (29'0")	3017 (9'11")	6500 (21'4")	7399 (24'3")	8300 (27'3")	930 (3'1")	5550 (18'3")	1200 (47")	6750 (22'2")	6102 (20'0")	14300 (46'11")	9000 (29'6")	8300 (27'3")
PC4000E-6														
PC5500-6	7424 (24'4")	9720 (31'11")	3310 (10'10")	7550 (24'9")	7270 (23'10")	8610 (28'3")	995 (3'3")	6190 (20'4")	1350 (53")	7540 (24'9")	6410 (21'0")	16800 (55'1")	10500 (34'5")	7900 (25'11")
PC5500E-6														
PC8000-6	8100 (26'7")	10735 (35'3")	3615 (11'10")	8710 (28'7")	8300 (27'3")	9655 (31'8")	1065 (3'6")	6830 (22'5")	1500 (59")	8330 (27'4")	7115 (23'4")	18650 (61'2")	11000 (36'1")	10010 (32'10")
PC8000E-6														

Working Ranges and Digging Force

HYDRAULIC LOADING SHOVELS

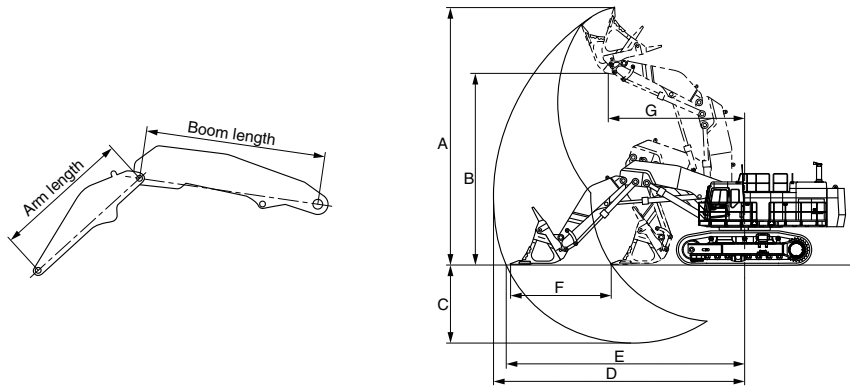

FVBH0105

	Boom length m (ft.in)	Arm length m (ft.in)	A mm (ft.in)	B mm (ft.in)	C mm (ft.in)	D mm (ft.in)	E mm (ft.in)	F mm (ft.in)	G mm (ft.in)	Breakout force kg (lb/kN)	Arm crowd force kg (lb/kN)
PC400-7 PC400-8 PC400-8R PC400LC-7 PC400LC-8 PC400LC-8R	4.0 (13'1")	2.9 (9'6")	10190 (33'5")	7190 (23'7")	3045 (10')	8660 (28'5")	8375 (27'6")	3430 (11'3")	3805 (12'6")	27500 (60,630/270)	29100 (64,150/285)
PC600-7 PC600LC-7 PC600-8E0 PC600-8R1 PC600LC-8E0 PC600LC-8R1	4.0 (13'1")	3.0 (9'10")	10090 (33'1")	6705 (22'0")	3495 (11'6")	9190 (30'2")	8850 (29'0")	3275 (10'9")	4460 (14'8")	39400 (86,860/386)	34500 (76,060/338)
PC750-7 PC800-8E0 PC800-8R1	4.60 (15'1")	3.40 (11'2")	10800 (35'5")	7260 (23'10")	3605 (11'10")	10370 (34'0")	9990 (32'9")	3865 (12'8")	5870 (19'3")	48600 (107,140/477)	41200 (90,830/404)
PC1250-7 PC1250-8 PC1250-8R	5.3 (17'5")	3.8 (12'6")	12330 (40'5")	8700 (28'7")	3650 (12'0")	11400 (37'5")	10900 (35'9")	4480 (14'8")	6760 (22'2")	59000 (130,070/579)	62000 (136,690/608)
PC2000-8	5.95 (19'6")	4.45 (14'7")	14450 (47'5")	9665 (31'9")	3190 (10'6")	13170 (43'3")	11940 (39'2")	4850 (15'11")	7500 (24'7")	73500 (162,070/721)	77000 (169,800/755)

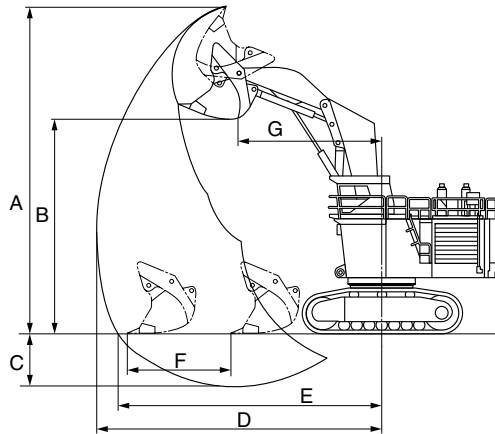

FVBH0109

	Boom length m (ft.in)	Arm length m (ft.in)	A mm (ft.in)	B mm (ft.in)	C mm (ft.in)	D mm (ft.in)	E mm (ft.in)	F mm (ft.in)	G mm (ft.in)	Breakout force* ton (US ton/kN)	Arm crowd force* ton (US ton/kN)
PC3000-6 PC3000E-6	6.0 (19'8")	4.3 (14'1")	15100 (49'7")	10900 (35'9")	3300 (10'10")	13300 (43'8")	12680 (41'7")	4700 (15'5")	7460 (24'6")	102 (112.4/1000)	112 (123.5/1100)
PC4000-6 PC4000E-6	7.15 (23'6")	4.9 (16'1")	17400 (57'1")	11500 (37'9")	2900 (9'6")	15100 (49'7")	13920 (45'8")	5700 (18'8")	9000 (29'6")	127.4 (140.4/1250)	135.6 (149.5/1330)
PC5500-6 PC5500E-6	7.6 (24'11")	5.6 (18'4")	19500 (64'0")	13000 (42'8")	2700 (8'10")	16500 (54'2")	15000 (49'3")	5600 (18'4")	9210 (30'3")	190.1 (209.5/1865)	190.6 (210/1870)
PC8000-6 PC8000E-6	8.15 (26'9")	5.75 (18'10")	29000 (95'2")	13600 (44'7")	3000 (9'10")	17800 (58'5")	16370 (53'9")	5900 (19'4")	9960 (32'8")	236.5 (260.7/2320)	236.5 (260.7/2320)

* DIN rating

PC600-8E0/PC600LC-8E0, PC600-8R1/PC600LC-8R1

Four-part structure

- (1) Work equipment ass'y (L/S) 16.5t (18.2 U.S. ton)
Width 2090 mm (6'10")

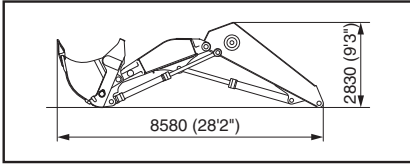

- (2) Upper structure 18.4t (20.3 U.S. ton)

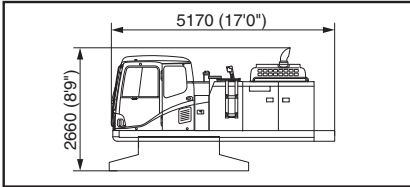

- (3) Undercarriage
PC600-8E0(R1) 16.0t (17.6 U.S. ton)
PC600LC-8E0(R1) 17.0t (18.7 U.S. ton)

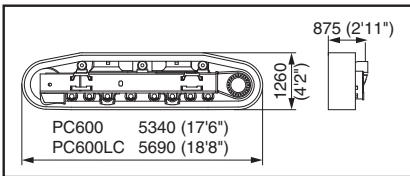

- (4) Other 12.3t (13.6 U.S. ton)

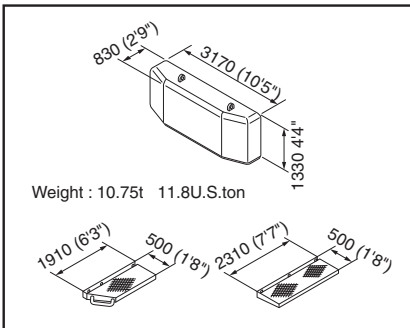

Three-part structure

- (1)

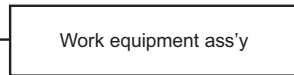

- (5) Base machine
PC600-8E0(R1) 34.4t (37.9 U.S. ton)
PC600LC-8E0(R1) 35.4t (39.0 U.S. ton)

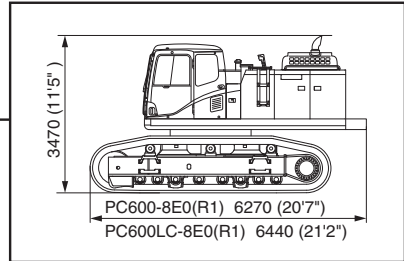

- (4)



PC600-7/PC600LC-7

Four-part structure

- (1) Work equipment ass'y (L/S) 16.2t (17.9 U.S. ton)
Width 2090 mm (6'10")

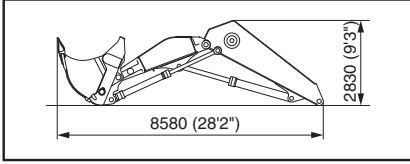

- (2) Upper structure 16.8t (18.5 U.S. ton)

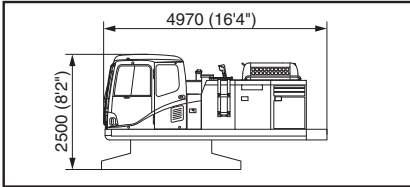

- (3) Undercarriage

- PC600-7 16.4t (18.1 U.S. ton)
PC600LC-7 17.4t (19.2 U.S. ton)

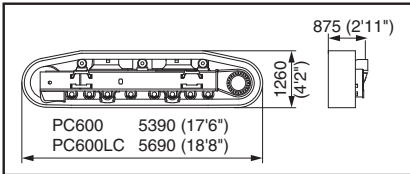

- (4) Other 11.0t (12.1 U.S. ton)

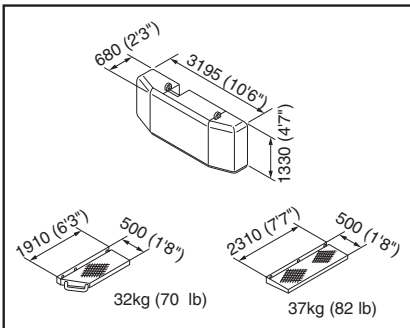

Three-part structure

- (1)

Work equipment ass'y

- (5) Base machine

- PC600-7 33.9t (37.4 U.S. ton)
PC600LC-7 35.0t (38.6 U.S. ton)

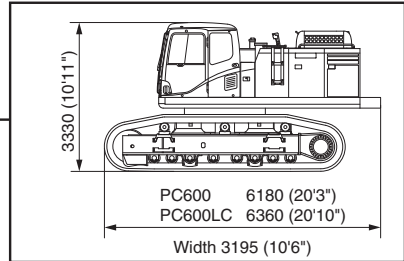

- (4)

Other

PC800-8E0, PC800-8R1

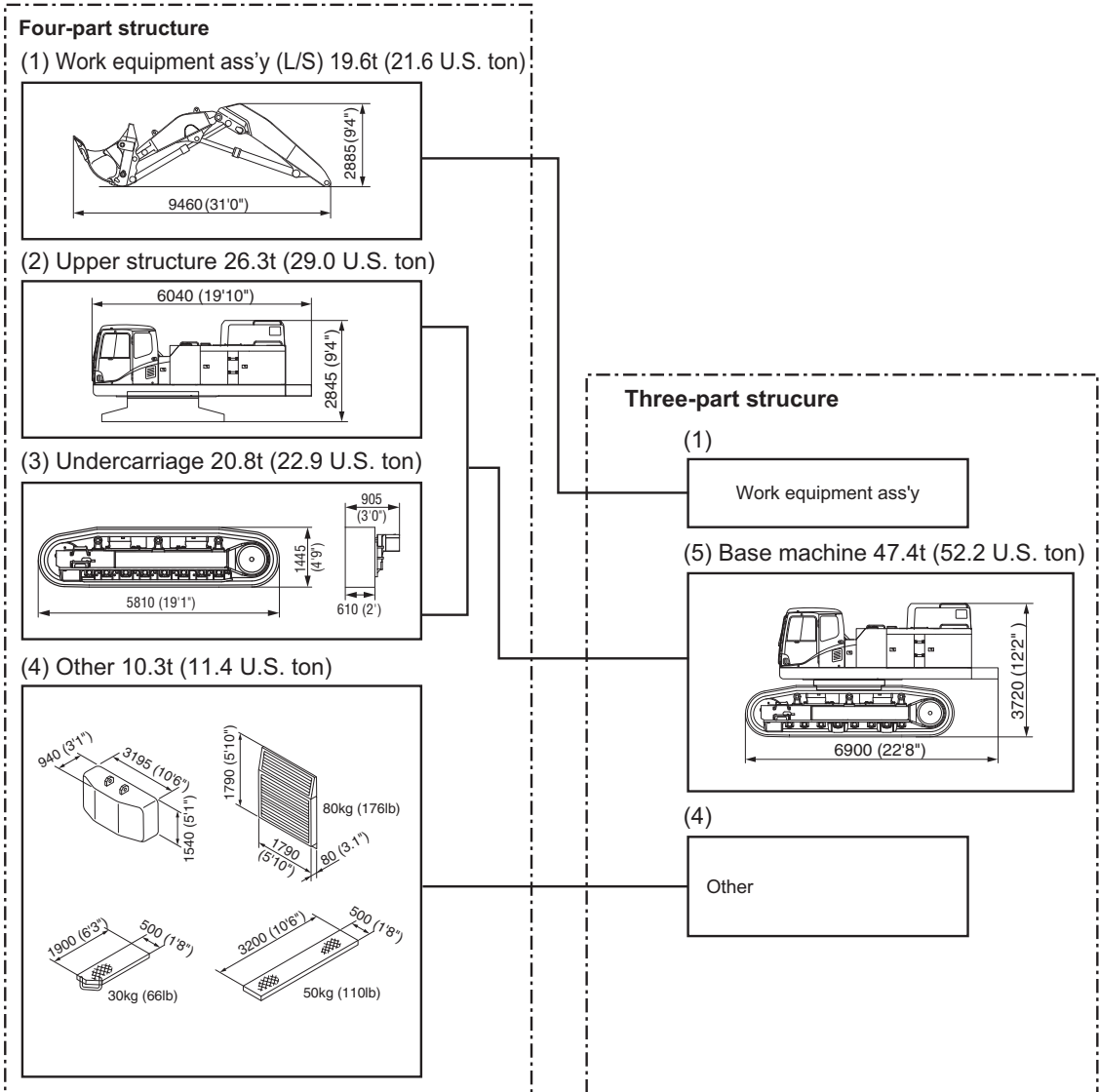

* KOMTRAX (optional) with an antenna when mounted.

PC750-7

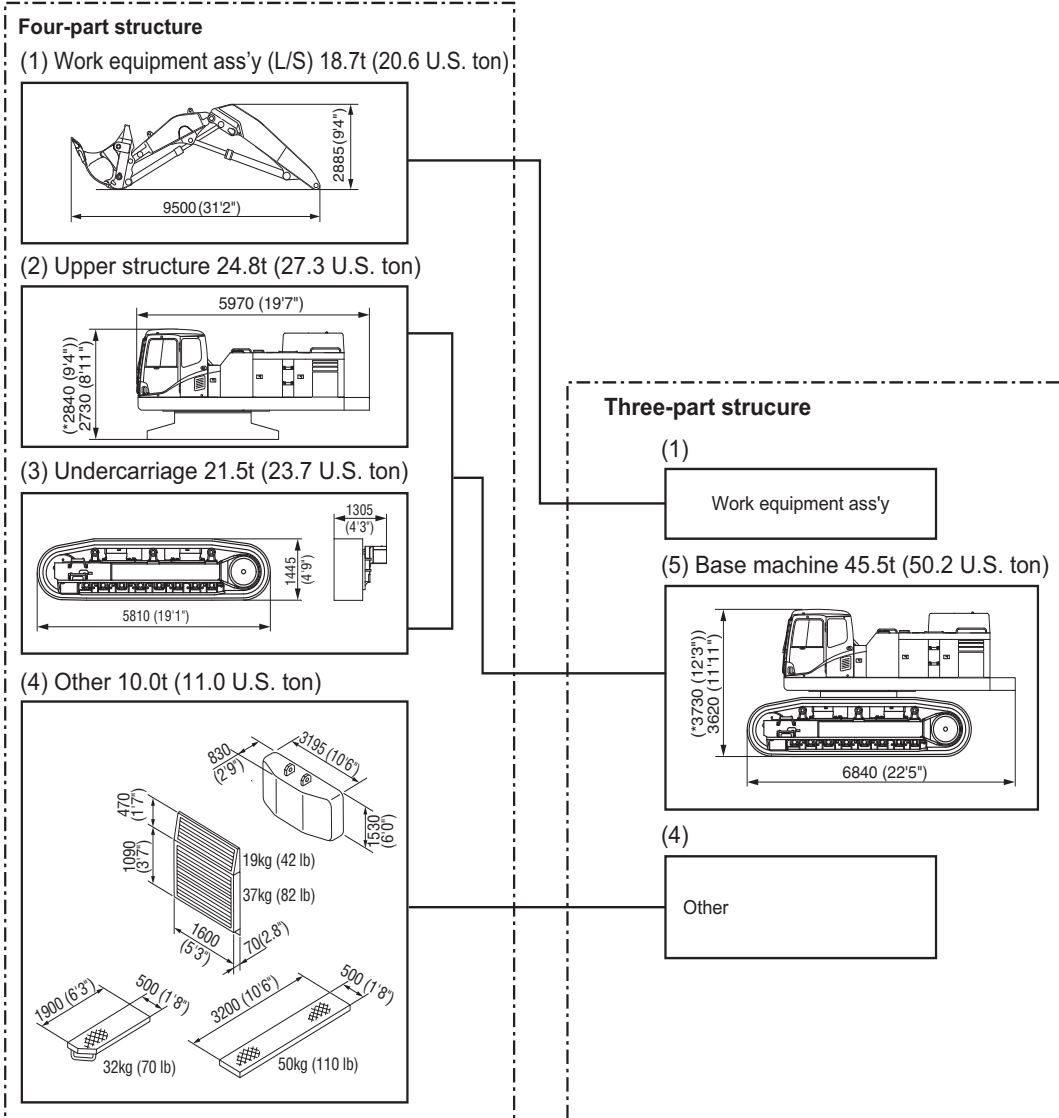

* KOMTRAX (optional) with an antenna when mounted.

PC1250-8, PC1250-8R

Posture for Transportation
(length X height X width) (1/2)

4 units for transportation (PC1250-8 STD spec.)

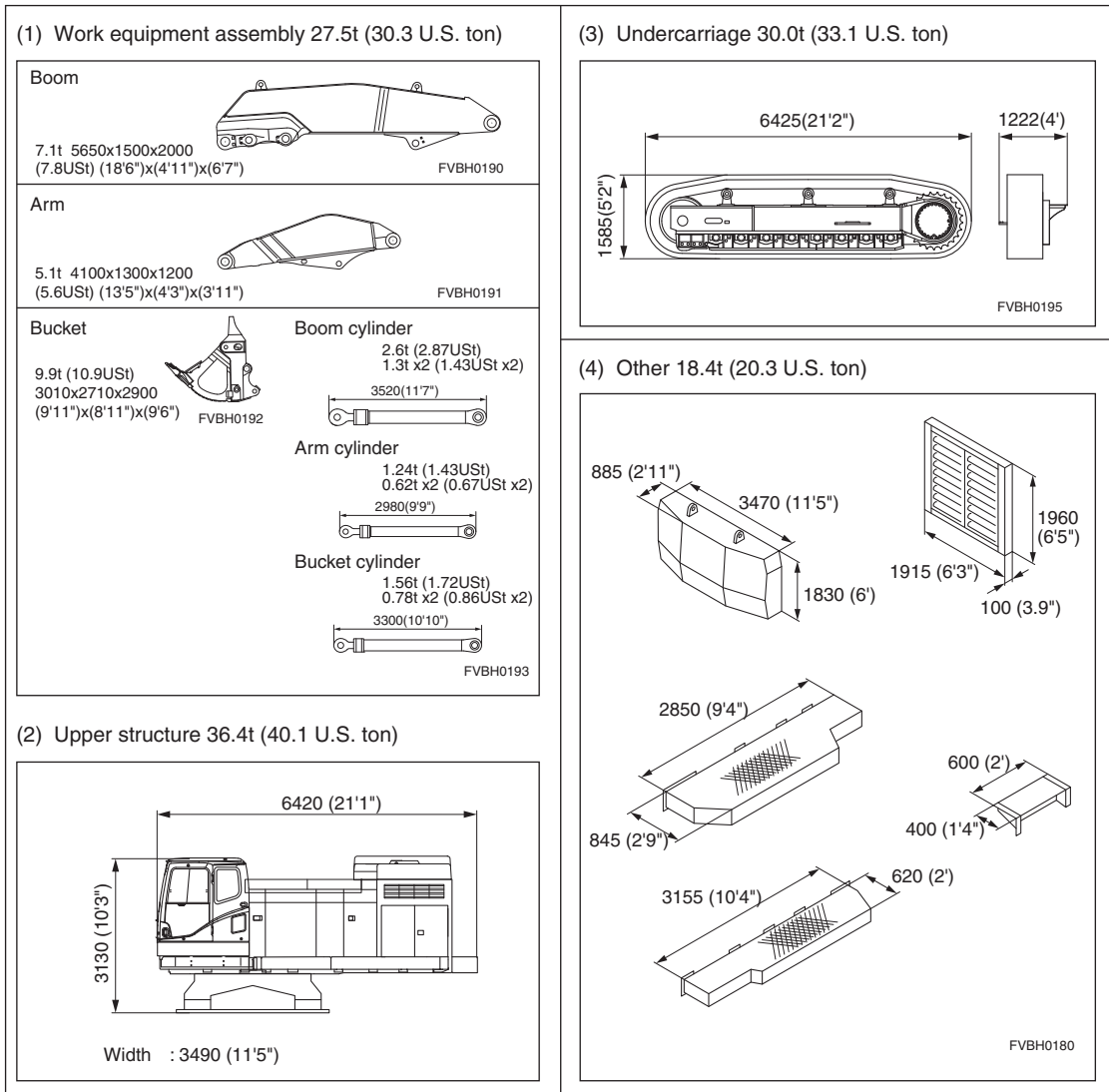

Component Dimensions and Weights

HYDRAULIC LOADING SHOVELS

PC1250-7

Posture for Transportation
(length X height X width) (1/2)



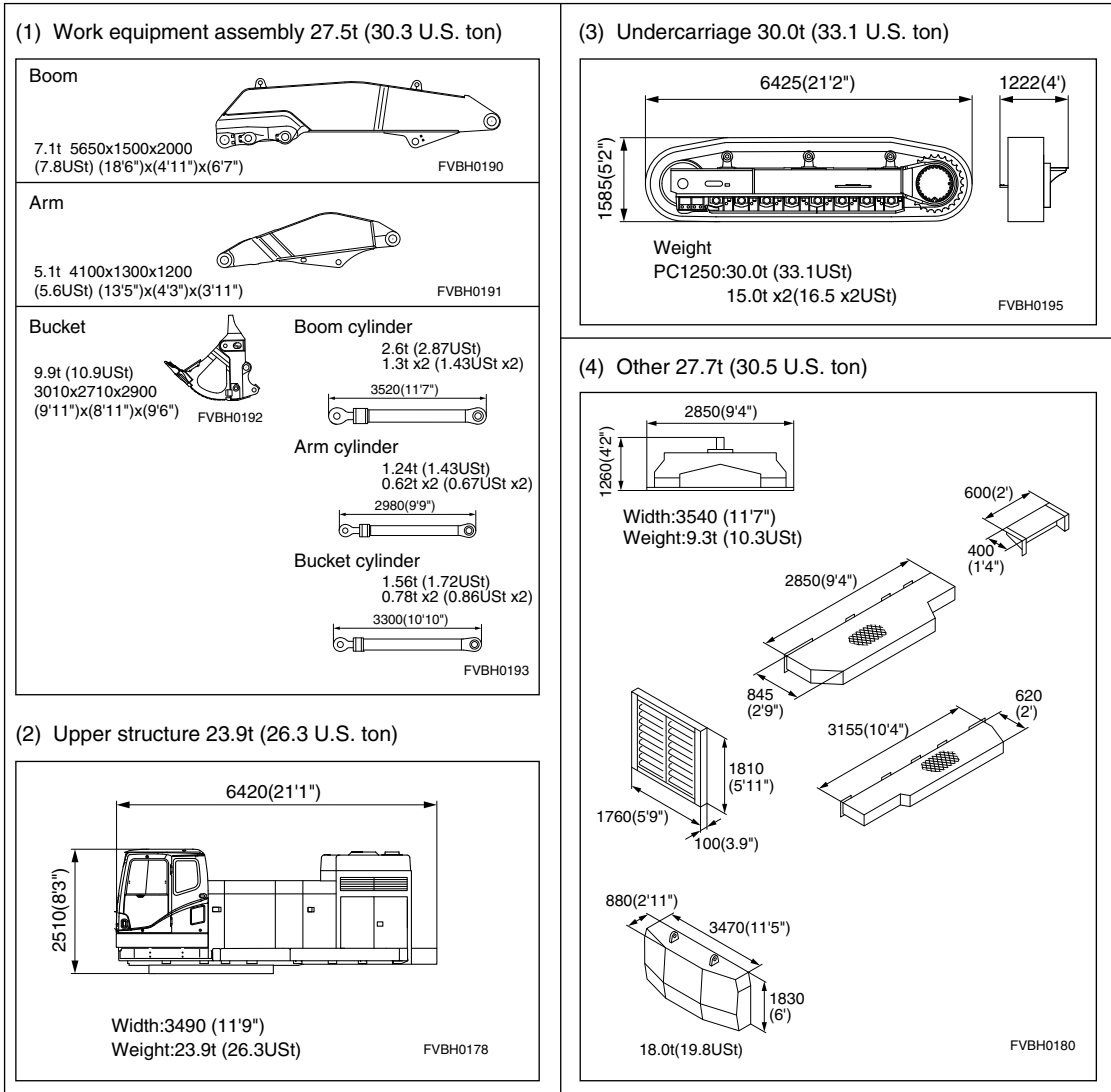



4 units for transportation (PC1250-7 STD spec.)

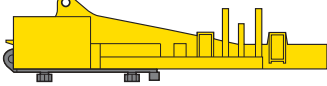
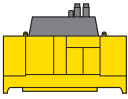
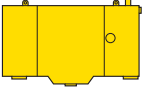
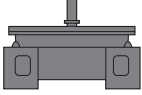
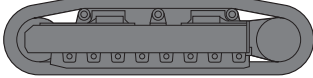

Component Dimensions and Weights

HYDRAULIC LOADING SHOVELS







PC2000-8

Unit name	Dimension	Length mm (ft.in.)	Width mm (ft.in.)	Height mm (ft.in.)	Weight ton (U.S. ton)
1. Boom	 FVBH0205	6400 (21'0")	1740 (5'9")	2000 (6'7")	11.8 (13.0)
2. Arm	 FVBH0206	4900 (16'1")	1450 (4'9")	1700 (5'7")	9.5 (10.5)
3. Bucket		3350 (11'0")	3190 (10'6")	2920 (9'7")	14.4 (15.9)
4. Revolving frame		7575 (24'10")	3180 (10'5")	2640 (8'8")	26.5 (29.2)
5. Power module		2515 (17'1")	2455 (8'1")	3195 (10'6")	16.1 (17.7)
6. Fuel tank		3100 (10'2")	875 (2'10")	2070 (6'10")	2.4 (2.65)
7. Center frame		3815 (12'6")	3190 (10'6")	2210 (7'3")	18.0 (19.8)
8. Undercarriage		7435 (24'5")	1720 (5'8")	1920 (6'4")	26.0 × 2 (28.1 × 2)
9. Cab base		3660 (12'0")	2505 (8'3")	2700 (8'10")	2.5 (2.8)
10. Operator cab		2885 (9'6")	1880 (6'2")	2520 (8'3")	1.8 (1.98)
11. Counterweight		6420 (21'1")	1115 (3'8")	1505 (4'11")	24.5 (27.0)
12. Hydraulic tank		1860 (6'1")	1115 (3'8")	2125 (7'0")	3.5 (3.86)
13. Cylinders and Others					12.5 (13.8)

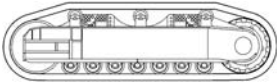
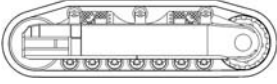
Component Dimensions and Weights

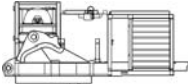
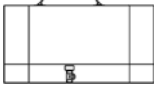
HYDRAULIC LOADING SHOVELS

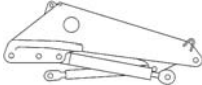
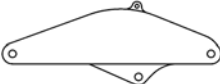
PC3000-6

Unit name	Dimension	Length mm (ft.in.)	Width mm (ft.in.)	Height mm (ft.in.)	Weight ton (U.S. ton)
Left Crawler Side Frame with 800 mm (31.5") Tracks		7930 (26'0")	1600 (5'3")	2210 (7'3")	31.9 (35.2)
Right Crawler Side Frame with 800 mm (31.5") Tracks		7930 (26'0")	1600 (5'3")	2210 (7'3")	31.9 (35.2)
Carbody with Rotary Joint		4020 (13'2")	3610 (11'10")	2180 (7'2")	19.5 (21.5)
Superstructure Platform with Machine House incl. 1 Diesel Engine, Hydraulic Tank and Hydraulic Cooler		7950* (26'1")	5250* (17'3")	3600* (11'10")	70* (77.2)
Counterweight		5060 (16'7")	1000 (3'3")	2850 (9'4")	30.5 (33.6)
Fuel Tank		2250 (7'5")	1650 (5'5")	2800 (9'2")	2.3 (2.5)
Cab Base		2520 (8'3")	2300 (7'7")	2800 (9'2")	3.25 (3.6)
Boom 6 m (19'8") with 4 cylinders		6450 (21'2")	2130 (7'0")	2800 (9'2")	26.3 (29.0)
Arm 4.3 m (14'1")		4740 (15'7")	1600 (5'3")	1800 (5'11")	9.25 (10.2)
Front Shovel Bucket 15 m ³ (19.0 cu.yd) incl. Standard Wear Package WP 3		4110** (13'6")	3790 (12'5")	3420** (11'3")	24.1** (26.6)
Front Shovel Backwall incl. Standard Wear Package WP 3			3610 (11'10")		10.2 (11.2)
Case with Accessories		3500 (11'6")	2400 (7'10")	3150 (10'4")	4 (4.4)
Case with Accessories		5800 (19'0")	2400 (7'10")	2100 (6'11")	5.7 (6.3)
Case with Accessories		4900 (16'1")	1300 (4'3")	1520 (5'0")	7 (7.7)









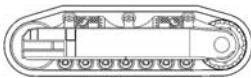

* including Superstructure, Hydraulic Tank and Hydraulic Cooler

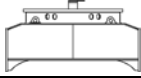
** for the complete bucket

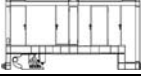
Component Dimensions and Weights

HYDRAULIC LOADING SHOVELS

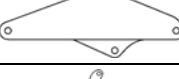
PC4000-6











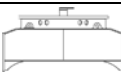
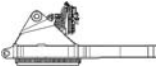

Unit name	Dimension	Length mm (ft.in.)	Width mm (ft.in.)	Height mm (ft.in.)	Weight ton (U.S. ton)
Left Crawler Side Frame with 1200 mm (47") Tracks		8850 (29'0")	1600 (5'3")	2500 (8'2")	58.0 (63.9)
Right Crawler Side Frame with 1200 mm (47") Tracks		8850 (29'0")	1600 (5'3")	2500 (8'2")	58.0 (63.9)
Carbody with Rotary Joint		4670 (15'4")	4070 (13'4")	2270 (7'5")	30.1 (33.2)
Superstructure Platform		8430 (27'8")	4435 (14'7")	3930 (12'11")	50.3 (55.4)
Counterweight		6100 (20'0")	950 (3'1")	3320 (10'11")	37 (40.8)
Main Machinery House incl. 1 Engine		6500 (21'4")	2750 (9'0")	3250 (10'8")	30.4 (33.5)
Fuel Tank		2390 (7'10")	2060 (6'9")	3280 (10'9")	3.5 (3.9)
Hydraulic Tank		2400 (7'10")	1370 (4'6")	3270 (10'9")	3.4 (3.7)
Cab Base		2400 (7'10")	2060 (6'9")	3020 (9'11")	3.8 (4.2)
Boom 7.15 m (23'6")		7700 (25'3")	2300 (7'7")	2800 (9'2")	23.6 (26.0)
Arm 4.9 m (16'1")		5400 (17'9")	2000 (6'7")	2100 (6'11")	14.9 (16.4)
Front Shovel Clam 22 m ³ (28.8 cu.yd) incl. Standard Wear Package WP 3		3700 (12'2")	4170 (13'8")	3600 (11'10")	19.4 (21.4)
Front Shovel Backwall 22 m ³ (28.8 cu.yd) incl. Standard Wear Package WP 3		4100** (13'5")	4000 (13'1")	1600 (5'3")	15.5 (17.1)
Case with Oil Cooler		5770 (18'11")	2490 (8'2")	1980 (6'6")	3.4 (3.7)
Case with Driver's Cab and with intermediate base		3890 (12'9")	3290 (10'10")	3280 (10'9")	5 (5.5)
Case with Boom Cylinders		5870 (19'3")	1290 (4'3")	1480 (4'10")	8.2 (9.0)
Case with Stick Cylinders		4870 (16'0")	1090 (3'7")	1280 (4'2")	6.1 (6.7)
Case with Accessories		5770 (18'11")	2490 (8'2")	1980 (6'6")	4 (4.4)
Case with Accessories		4870 (16'0")	1090 (3'7")	1280 (4'2")	6 (6.6)

** for the complete bucket

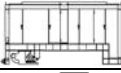
Component Dimensions and Weights

HYDRAULIC LOADING SHOVELS

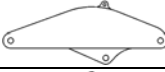







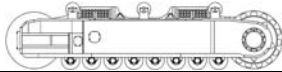
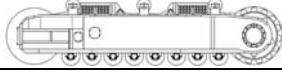

PC5500-6

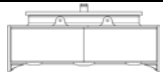
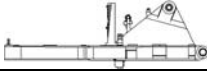
Unit name	Dimension	Length mm (ft.in.)	Width mm (ft.in.)	Height mm (ft.in.)	Weight ton (U.S. ton)
Left Crawler Side Frame without Tracks		9300 (30'6")	1500 (4'11")	2300 (7'7")	40 (44)
Right Crawler Side Frame without Tracks		9300 (30'6")	1500 (4'11")	2300 (7'7")	40 (44)
6 × 1 Chain with 12 Track Shoes 1350 mm (53") each 8.55 t (9.4 US ton)		6000 (198")	1350 (4'5")	400 (1'4")	51.3 (56.5)
2 × 1 Chain with 10 Track Shoes 1350 mm (53") each 7.1 t (7.3 US ton)		5050 (16'7")	1350 (4'5")	400 (1'4")	14.2 (15.7)
Carbody with Rotary Joint		5130 (16'10")	4690 (15'5")	2380 (7'10")	45 (49.6)
Superstructure Platform		9650 (31'7")	4510 (14'10")	4400 (14'5")	85 (93.6)
Counterweight		6600 (21'8")	1140 (3'9")	3320 (10'11")	42 (46.3)
Main Machinery House incl. 2 Diesel Engines		7100 (23'4")	4050 (13'3")	3300 (10'10")	40.5 (51.0)
Fuel Tank		2800 (9'2")	2250 (7'5")	3300 (10'10")	7.0 (7.7)
Hydraulic Tank		2390 (7'10")	1300 (4'3")	3300 (10'10")	3.4 (3.7)
Cab Base		2200 (7'3")	1950 (6'5")	3050 (10'0")	3.8 (4.2)
Boom 7.6 m (24'11")		8250 (27'1")	2530 (8'4")	3000 (9'10")	35.0 (38.6)
Arm 5.6 m (18'4")		6300 (20'8")	2340 (7'8")	2300 (7'7")	21.0 (23.0)
Front Shovel Clam 28 m ³ (36.6 cu.yd), incl. Standard Wear Package WP 3		4100 (13'5")	4900 (16'1")	3800 (12'6")	28.5 (31.0)
Front Shovel Backwall 28 m ³ (36.6 cu.yd) incl. Standard Wear Package WP 3		4250 (13'11")	4400 (14'5")	1950 (6'4")	23.0 (25.3)
Case with Oil Cooler		4000 (13'1")	2700 (8'10")	2300 (7'7")	5.4 (6.0)
Case with Driver's Cab and with Intermediate Base		4000 (13'1")	3300 (10'10")	3200 (10'6")	6.6 (7.3)
Case with 2 Gear Boxes		5600 (18'4")	2700 (8'10")	2250 (7'5")	16.6 (18.3)
Case with 2 Boom Cylinders		6500 (21'4")	1400 (4'7")	1500 (4'11")	12 (13.2)
Case with 2 Stick Cylinders		5670 (18'7")	1490 (4'11")	1680 (5'6")	9.2 (10.1)
Case with Accessories		3600 (11'10")	2500 (8'2")	2550 (8'4")	3.8 (4.2)
Case with Accessories		5770 (18'11")	2490 (8'2")	1880 (6'2")	4.6 (5.1)

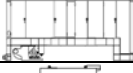
Component Dimensions and Weights

HYDRAULIC LOADING SHOVELS

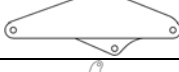
PC8000-6

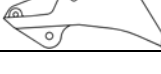
Unit name	Dimension	Length mm (ft.in.)	Width mm (ft.in.)	Height mm (ft.in.)	Weight ton (U.S. ton)
Left Crawler Side Frame without Tracks		10200 (33'6")	1600 (5'2")	2450 (8'0")	55 (60.6)
Right Crawler Side Frame without Tracks		10200 (33'6")	1600 (5'2")	2450 (8'0")	55 (60.6)
9 x 1 Chain with 10 Track Shoes 1500 mm (59")		5040 (16'6")	1500 (4'11")	400 (1'4")	91 (100.3)
1 Chain with 8 Track Shoes 1500 mm (59")		4070 (13'4")	1500 (4'11")	400 (1'4")	8.1 (8.9)
Carbody with Rotary Joint		5750 (18'10")	5060 (16'7")	2730 (8'11")	59 (65.0)
Superstructure Platform		11300 (37'1")	4750 (15'7")	4000 (13'1")	94 (103.6)
Counterweight		6800 (22'3")	1250 (4'1")	3900 (12'10")	52.3 (57.7)
Main Machinery House incl. 2 Diesel Engines		8000 (26'3")	5000 (16'5")	3900 (12'10")	62 (68.3)
Fuel Tank		3400 (11'1")	1800 (5'11")	3760 (12'4")	5.6 (6.2)
Hydraulic Tank		2710 (8'11")	1910 (6'3")	3730 (12'3")	7.3 (8.0)
Cab Base		2600 (8'6")	2000 (6'6")	3800 (12'5")	5.4 (6.0)
Boom 8.15 m (26'9")		8800 (28'10")	2900 (9'6")	3400 (11'2")	49.1 (54.1)
Arm 5.75 m (18'10")		6500 (21'3")	2700 (8'9")	2550 (8'4")	26.0 (28.5)
Front Shovel Clam 42 m ³ (55 cu.yd), incl. Standard Wear Package WP 3		4600 (15'1")	5670 (18'7")	4300 (14'1")	39.5 (43.5)
Front Shovel Backwall 42 m ³ (55 cu.yd), incl. Standard Wear Package WP 3		4800 (15'8")	5200 (17'8")	2350 (7'8")	31.0 (34.1)
Case with Oil Cooler		6500 (21'4")	2700 (8'10")	2500 (8'2")	11.5 (12.7)
Case with Slew Ring		4950 (16'3")	4910 (16'1")	1015 (3'4")	21 (23.1)
Case with Cab		4000 (13'1")	3030 (9'11")	3150 (10'4")	7 (7.7)
20' OT Container (belong to shipper) with Accessories					8.5 (9.4)
20' OT Container (belong to shipper) with Accessories					13.4 (14.8)
20' OT Container (belong to shipper) with Accessories					20.3 (22.4)
40' OT Container (belong to shipper) with Accessories					24.3 (26.8)

	Shoe type	Shoe width mm (in)	Ground contact area cm ² (sq.in)	Ground pressure kg/ cm ² (PSI)	Change in operating weight kg (lb)	Boom Arm Bucket
PC400-7 PC400-8 PC400-8R	Triple-grouser	600 (24")*	52090 (8074)	0.83 (11.8)	±0	: 4.0 m (13'1")
		700 (28")	60770 (9419)	0.72 (10.2)	+420 (926)	: 2.9 m (9'6")
		800 (31.5")	69450 (10765)	0.63 (8.95)	+850 (1874)	: 2.6 m ³ (3.4 cu.yd)
PC400LC-7 PC400LC-8 PC400LC-8R	Triple-grouser	600 (24")	56050 (8638)	0.78 (11.1)	-450 (992)	: 4.0 m (13'1")
		700 (28")*	65390 (10135)	0.68 (9.7)	±0	: 2.9 m (9'6")
		800 (31.5")	74730 (11583)	0.60 (8.53)	+450 (992)	: 2.6 m ³ (3.4 cu.yd)
PC600-7	Triple-grouser	600 (24")*	55240 (8562)	1.11 (15.8)	±0	: 4.0 m (13'1")
		750 (29.5")	69090 (10709)	0.90 (12.8)	+820 (1808)	: 3.0 m (9'10")
						: 4.0 m ³ (5.2 cu.yd)
PC600LC-7	Triple-grouser	600 (24")*	59440 (9213)	1.05 (14.9)	±0	: 4.0 m (13'1")
		750 (29.5")	74300 (11517)	0.85 (12.1)	+880 (1940)	: 3.0 m (9'10")
						: 4.0 m ³ (5.2 cu.yd)
PC600-8E0 PC600-8R1	Double-grouser	600 (24")*	55240 (8562)	1.14 (16.2)	±0	: 4.0 m (13'1")
						: 3.0 m (9'10")
						: 4.0 m ³ (5.2 cu.yd)
PC600LC-8E0 PC600LC-8R1	Double-grouser	600 (24")*	59440 (9213)	1.08 (15.4)	±0	: 4.0 m (13'1")
						: 3.0 m (9'10")
						: 4.0 m ³ (5.2 cu.yd)
PC750-7	Double-grouser	610 (24")*	60170 (9326)	1.26 (17.9)	±0	: 4.6 m (15'1")
		710 (28")	70030 (10855)	1.10 (15.6)	+800 (1764)	: 3.4 m (11'2")
						: 4.5 m ³ (5.9 cu.yd)
PC800-8E0 PC800-8R1	Double-grouser	610 (24")*	60170 (9326)	1.28 (18.2)	±0	: 4.6 m (15'1")
						: 3.4 m (11'2")
						: 4.5 m ³ (5.9 cu.yd)
PC1250-7	Double-grouser	700 (28")*	76450 (11850)	1.44 (20.5)	±0	: 5.3 m (17'5")
						: 3.8 m (12'6")
						: 6.5 m ³ (8.5 cu.yd)
PC1250-8 PC1250-8R	Double-grouser	700 (28")*	76450 (11850)	1.45 (20.6)	±0	: 5.3 m (17'5")
						: 3.8 m (12'6")
						: 6.5 m ³ (8.5 cu.yd)
PC2000-8	Double-grouser	810 (32")*	103020 (15970)	1.90 (27.0)	±0	: 5.95 m (19'6")
						: 4.45 m (14'7")
						: 11 m ³ (14.4 cu.yd)
PC3000-6 (Diesel Drive)	Double-grouser	800 (31.4")*	106696 (16538)	2.34 (33.3)	±0	: 6 m (19'8")
		1000 (39.3")	133370 (20672)	1.93 (27.4)	+8590 (18940)	: 4.3 m (14'1")
		1200 (47.2")	160044 (24807)	1.63 (23.2)	+11700 (25790)	: 15 m ³ (19.6 cu.yd)
PC4000-6 (Diesel Drive)	Double-grouser	1200 (47.2")*	178793 (27713)	2.17 (30.9)	±0	: 7.15 m (23'6")
		1500 (59")	223491 (34641)	1.76 (25.0)	+4870 (10740)	: 4.9 m (16'1")
						: 22 m ³ (28.8 cu.yd)
PC5500-6 (Diesel Drive)	Double-grouser	1350 (53")*	222145 (34432)	2.40 (34.1)	±0	: 7.6 m (24'11")
		1800 (71")	296194 (45910)	1.84 (26.2)	+13760 (30340)	: 5.6 m (18'4")
						: 29 m ³ (37.9 cu.yd)
PC8000-6 (Diesel Drive)	Double-grouser	1500 (59")*	270668 (41954)	2.75 (39.1)	±0	: 8.15 m (29'9")
		1900 (75")	342846 (53141)	2.21 (31.4)	+12870 (28370)	: 5.75 m (18'10")
						: 42 m ³ (55 cu.yd)

* Standard shoe

NOTE: The shoe for the long-track excavator (L and LC), wide shoe (excluding the narrowest shoe for a model) and swamp shoe are provided with low ground pressure. These shoes should be used on soft and swampy terrain where the standard excavator with standard shoe is not usable due to sinking of the tracks. If such shoes are used in swampy fields with stones, stumps and roots, bending of the shoe plates, cracks in the links, breakage of pins, loosening of shoe bolts and other damage may result. Therefore, the job site must be studied carefully, to provide the customer with correct instructions and advice.

	Shoe type	Shoe width mm (in)	Ground contact area cm ² (sq.in)	Ground pressure kg/ cm ² (PSI)	Change in operating weight kg (lb)	Boom Arm Bucket
PC3000E-6 (Electric Drive)	Double-grouser	800 (31.4")*	106696 (16538)	2.35 (33.5)	±0	: 6 m (19'8")
		1000 (39.3")	133370 (20672)	1.95 (27.7)	+8590 (18940)	: 4.3 m (14'1")
		1200 (47.2")	160044 (24807)	1.62 (23.1)	+8800 (19400)	: 15 m ³ (19.6 cu.yd)
PC4000E-6 (Electric Drive)	Double-grouser	1200 (47.2")*	178793 (27713)	2.12 (30.2)	±0	: 7.15 m (23'6")
		1500 (59")	223491 (34641)	1.72 (24.5)	+4910 (10820)	: 4.9 m (16'1")
						: 22 m ³ (28.8 cu.yd)
PC5500E-6 (Electric Drive)	Double-grouser	1350 (53")*	222145 (34432)	2.37 (33.7)	±0	: 7.6 m (24'11")
		1800 (71")	296194 (45910)	1.82 (25.9)	+13760 (30340)	: 5.6 m (18'4")
						: 29 m ³ (37.9 cu.yd)
PC8000E-6 (Electric Drive)	Double-grouser	1500 (59")*	270668 (41954)	2.71 (38.6)	±0	: 8.15 m (26'9")
		1900 (75")	342846 (53141)	2.12 (30.1)	+12870 (28370)	: 5.75 m (18'10")
						: 42 m ³ (55 cu.yd)

* Standard shoe

NOTE: The shoe for the long-track excavator (L and LC), wide shoe (excluding the narrowest shoe for a model) and swamp shoe are provided with low ground pressure. These shoes should be used on soft and swampy terrain where the standard excavator with standard shoe is not usable due to sinking of the tracks. If such shoes are used in swampy fields with stones, stumps and roots, bending of the shoe plates, cracks in the links, breakage of pins, loosening of shoe bolts and other damage may result. Therefore, the job site must be studied carefully, to provide the customer with correct instructions and advice.

Loading Shovel Buckets

HYDRAULIC LOADING SHOVELS

The bucket weight is heavier than the tilt-dump bucket. However, its characteristics of vertical dumping provide the following features

- Accurate loading is possible, because it is easy to position the bucket on the dumping point.
- Load spillage is less.
- Larger dumping clearance permits easier loading on the hauler.
- As it is possible to more closely position the bucket over the hauler's body, loading shock to the hauler can be minimized, extending the service life of the hauler.
- As a result of the above advantages, the cycle time is shortened.

Model	Bucket	Capacity m ³ (cu.yd)	Width mm (in)	Weight kg (lb)	Dump type	Recommen- dation
PC400-7 PC400LC-7 PC400-8 PC400-8R PC400LC-8 PC400LC-8R	Standard Bucket	2.6 (3.4)	1900 (74.8")	3270 (7,210)	Bottom	○
PC600-7 PC600LC-7 PC600-8E0 PC600-8R1 PC600LC-8E0 PC600LC-8R1	Standard Bucket	4.0 (5.2)	2090 (82.3")	5700 (12,570)	Bottom	○
PC750-7 PC800-8E0 PC800-8R1	Standard Bucket Light-material Bucket	4.5 (5.9) 5.1 (6.7)	2320 (91.3") 2670 (105.1")	5700 (12,570) 7360 (16,230)	Bottom Bottom	○ □
PC1250-7	Standard Bucket	6.5 (8.5)	2680 (105.5")	9700 (21,380)	Bottom	○
	Light material Bucket	7.2 (9.4)	2680 (105.5")	9800 (21,600)	Bottom	□
PC1250-8 PC1250-8R	Standard Bucket	6.5 (8.5)	2700 (106.3")	9730 (21,450)	Bottom	○
	Light material Bucket	7.2 (9.4)	2680 (105.5")	9800 (21,600)	Bottom	□
PC2000-8	Standard Bucket	11 (14.4)	3220 (126.8")	14400 (31,750)	Bottom	○

Applications

- : General digging and Loading
- △ : Light material work (Specific gravity, 1.2 and less)
- : Light material work (Specific gravity, 1.5 and less)
- : Heavy-duty work (Specific gravity, 1.5 ~ 2.0)

Model	Bucket Capacity	Width	Weight including Shrouds and WP-3*	Dump Type	Recommen- dation
	Heaped 2:1				
	m ³ (cu.yd)				
PC3000-6	15 (19.6)	3790 (149")	24270 (53,510)	bottom	○
PC4000-6	22 (28.8)	4020 (158")	34530 (76,120)	bottom	○
PC5500-6	29 (37.9)	4565 (180")	50880 (112,170)	bottom	○
PC8000-6	42 (55)	5375 (212")	69545 (153,320)	bottom	○

- * Wear package No.
- : General rock bucket for digging and loading
- △ : Light material work
- : Heavy-duty work

Hydraulic loading shovel and dump truck combination

HYDRAULIC EXCAVATOR		RIGID DUMP TRUCK					
MODEL (L/S)	BUCKET CAPACITY (HEAPED) m ³ (cu.yd)	HD255	HD325	HD405	HD465	HD605	HD785
		Payload m. ton (U.S. ton)					
		25 (27.6)	36.5 (40)	41 (45)	55 (61)	63 (69)	91 (100)
		Body Capacity m ³ (cu. yd)					
(SAE)	17.7 (23.2)	24.0 (31.4)	27.3 (35.7)	34.2 (44.7)	40 (52.3)	60 (78.5)	
PC400	2.6 (3.4)	5					
PC600LC	4.0 (5.2)	3	5	6			
PC750	4.5 (5.9)	3	5	5			
PC800	5.1 (6.7)	3	4	4			
PC1250	6.5 (8.5)	2	3	4	5	5	
PC2000	11.0 (14.4)				3	3	5

HYDRAULIC EXCAVATOR		RIGID DUMP TRUCK						
MODEL (L/S)	BUCKET CAPACITY (HEAPED) m ³ (cu.yd)	HD785	HD1500	730E	830E-AC	860E-1K	930E-4 930E-4SE	960E
		Payload m. ton (U.S. ton)						
		91 (100)	144 (159)	181 (200)	222 (244)	254 (280)	292 (320)	327 (360)
		Body Capacity m ³ (cu. yd)						
(SAE)	60 (78.5)	78 (102)	148 (193)	147 (193)	169 (221)	211 (276)	214 (280)	
PC3000	15.0 (19.6)	4	6	7				
PC4000	22.0 (28.8)	3	4	5	6	6		
PC5500	29.0 (37.9)		3	4	5	5	6	7
PC8000	42.0 (55)			3	3	4	4	5

Number of loads: 3–7 Suitable

Note: L/S: LOADING SHOVEL

Above combination is determined by following method;
(1) Suitable loading times (n): 4–6 times

$$n = \frac{\text{Max. payload of dump truck}}{\text{Bucket capacity} \times \text{Bucket fill factor} \times \text{Specific weight}} \quad \text{or} \quad n = \frac{\text{Heaped capacity of dump truck}}{\text{Bucket capacity} \times \text{Bucket fill factor}}$$

Number of loading times is calculated based on following condition.

1. Calculate number of loading times from maximum payload of dump truck.
Please see formula 1.
2. Calculate number of loading times from body capacity of dump truck.
Please see formula 2.
3. Adopt lower number between formula 1 and formula 2.

Formula 1

Number of loading = Payload of truck (metric tonnes) / (Bucket capacity of loader (m³) x loose density x bucket factor)

Formula 2

Number of loading = Body capacity (cubic meter) / (Bucket capacity of loader (m³) x bucket factor)

We adopt following condition.

Density = 1.8 metric tonnes per cubic meter

Bucket factor = 1.0

Calculated number of loading times are rounded off to the first decimal place.

Estimated Hourly Production

ESTIMATED CYCLE TIME		BUCKET SIZE** (m ³) OR (cu.yd)															
SEC.	MIN.	2.5	2.8	3.1	3.4	3.7	4.0	4.3	4.6	5.0	5.5	6.0	6.5	7.0	7.5	8.0	8.5
15.0	0.25	600	672	744	816	888	960	1032	1104	1200	1320	1440	1560	1680	1800	1920	2040
18.0	0.30	500	560	620	680	740	800	860	920	1000	1100	1200	1300	1400	1500	1600	1700
21.0	0.35	429	480	531	583	634	686	737	789	857	943	1029	1114	1200	1286	1371	1457
24.0	0.40	375	420	465	510	555	600	645	690	750	825	900	975	1050	1125	1200	1275
27.0	0.45	333	373	413	453	493	533	573	613	667	733	800	867	933	1000	1067	1133
30.0	0.50	300	336	372	408	444	480	516	552	600	660	720	780	840	900	960	1020
33.0	0.55	273	305	338	371	404	436	469	502	545	600	655	709	764	818	873	927
36.0	0.60	250	280	310	340	370	400	430	460	500	550	600	650	700	750	800	850

ESTIMATED CYCLE TIME		BUCKET SIZE** (m ³) OR (cu.yd)															
SEC.	MIN.	9.0	9.5	10.0	11.0	12.0	13.0	14.0	15.0	16.0	17.0	20	22	25	28	35	38
15.0	0.25	2160	2280	2400	2640	2880	3120	3360	3600	3840	4080						
18.0	0.30	1800	1900	2000	2200	2400	2600	2800	3000	3200	3400						
21.0	0.35	1543	1629	1714	1886	2057	2229	2400	2571	2743	2914	3428	3771	4285	4800	6000	6514
24.0	0.40	1350	1425	1500	1650	1800	1950	2100	2250	2400	2550	3000	3300	3750	4200	5250	5700
27.0	0.45	1200	1267	1333	1467	1600	1733	1867	2000	2133	2267	2666	2933	3333	3733	4666	5066
30.0	0.50	1080	1140	1200	1320	1440	1560	1680	1800	1920	2040	2400	2640	3000	3360	4200	4560
33.0	0.55	982	1036	1091	1200	1309	1418	1527	1636	1745	1855	2181	2400	2727	3054	3818	4145
36.0	0.60	900	950	1000	1100	1200	1300	1400	1500	1600	1700	2000	2200	2500	2800	3500	3800

** Bucket size: Heaped bucket capacity
 *** Cycle time: Refer to the section 16A "Productivity"

Actual production = (Estimated Hourly production) × (Bucket fill factor) × (Job efficiency)

Bucket Fill Factor (K) (PC400~PC2000)

Job Efficiency(E)

Loading conditions	K
Easy loading	1.0~1.1
Average loading	0.95~1.0
Rather difficult loading	0.90~0.95
Difficult loading	0.85~0.90

Operating conditions	E
Good	0.83
Average	0.75
Rather poor	0.67
Poor	0.58

Bucket Fill Factor (K) (PC3000~PC8000)*4

Loading conditions	K
Easy loading	1.0
Average loading	0.95
Severe loading	0.90

*4 : KMG Mining Shovels (Loading shovel)

SECTION **2E**

WHEEL-TYPE EXCAVATORS

CONTENTS

Features	2E-2
Specifications	2E-3
Dimensions	2E-5
Working Ranges and Digging Force	2E-7
Bucket and Arm Combinations	2E-9
Lifting Capacity	2E-11

High mobility

- A high-power KOMATSU engine gives it a higher travel speed for quick relocation.
- Four-wheel drive and double tires both front and rear make it easy to travel over rough or soft terrain.

High working performance

- Large working range and strong digging force.
- The PC system makes full use of engine power.
- A two-pump merge system increases work equipment speed and reduces cycle time.
- Smooth, responsive swing starts and stops.
- High lifting capacity and good stability.

High operating versatility

- Extra-small swing radius boosts operating versatility.
- Excellent stability due to oscillation lock cylinders and double tires.

Enhanced operator comfort

- Hydrostatic drive system assures smooth, easy travel speed changes.
- Newly designed cab offers greater comfort.

Excellent safety and easy maintenance

- Four wheel disc brake with positive braking
- One of the features now on the new wheeled excavator is a walkway across the excavator superstructure, giving easy access to the engine compartment.
(PW180-7, PW200-7, PW220-7)

In harmony with the environment

- Low emission engine
The powerful turbocharged and air-to-air aftercooled Komatsu SAA4D107E and SAA6D107E engine meets Tier 3 and Stage 3A emissions standards with increased power and machine productivity.
- Economy mode reduces fuel consumption
- Low operating noise
- Designed for easy end of life recycling
(PW140 and over)

Undercarriage

- Designed for high ground clearance
- High oscillation angle
- Virtually zero axle rocking with outboard wet disc system
- Powerful drawbar pull
- Automatic 3-speed travel
- Class leading 35 km/h maximum travel speed
(PW140-7 and over)

SpaceCab™

The new PW140/160/180/200/220-7's cab space have been increased by 14%, offering an exceptionally-roomy operating environment.

- High-pressurised cabin with optional air conditioner
- Low-noise design
- Low-vibration design with cabin damper mounting
- Cab moved forward for better visibility
- Ergonomic control levers
- Seat specially designed for wheeled machines, with exceptional extra comfort.
(PW140-7 and over)

Specifications

WHEEL-TYPE EXCAVATORS

Item		Model	PW98MR-8***	PW118MR-8***	PW148-8**
OPERATING WEIGHT*		kg (lb)	10300 (22,710)	12885 (28,410)	14895 (32,840)
HORSEPOWER: ISO 14396 ISO 9249 Net		kW (HP)/RPM	50.7 (68.0)/1950 49.0 (65.7)/1950	72.0 (96.6)/2200 68.4 (91.7)/2200	90.0 (121)/2200 86.0 (115)/2200
BUCKET CAPACITY RANGE (SAE)		m ³ (cu.yd)	0.077 ~ 0.282 (0.10) (0.37)	0.093 ~ 0.40 (0.12) (0.52)	0.20 ~ 0.97 (0.26) (1.27)
PERFORMANCE:					
Swing speed		RPM	10	8.5	11
Travel speeds		km/h (MPH)	6 (3.7)	4 (2.5)	2.5 (1.6)
1st or Creep			10 (6.2)	9 (5.6)	9 (5.6)
2nd or Lo			23 (14.3)	14 (8.7)	35 (21.7)
3rd or Hi			30 (18.6)	30 (18.6)	0 ~ 35 (21.7)
4th or Auto			5400 (11,900)	6600 (14,550)	8900 (19,620)
Maximum drawbar pull		kg (lb)			
DIMENSIONS:		See the page of DIMENSIONS			
ENGINE:			KOMATSU	KOMATSU	KOMATSU
Model			SAA4D95LE-5	SAA4D95LE-5	SAA4D107E-1
No. of cylinders- bore × stroke		mm (in)	4-95 × 115 (3.74 × 4.53)	4-95 × 115 (3.74 × 4.53)	4-107 × 124 (4.21 × 4.88)
Piston displacement		ltr. (cu.in)	3.26 (199)	3.26 (199)	4.5 (275)
HYDRAULIC SYSTEM:					
Hydraulic pump			1 × Variable Piston + 1 × Gear pump	1 × Variable Piston + 1 × Gear pump	1 × Variable Piston
Max. oil flow		ltr.(U.S. Gal)/min.	230 (60.8)	268 (70.8)	252 (66.6)
Max. oil pressure (Implement)		kg/cm ² (PSI)	270 (3840)	270 (3840)	280 (3980)
WHEELS: (front)			8.25-20 × 4	9.00-20 × 4	10.00-20-14PR × 4
(rear)			8.25-20 × 4	9.00-20 × 4	10.00-20-14PR × 4
CAPACITY (Refilled):					
Fuel tank		ltr. (U.S. Gal)	125 (33.0)	150 (39.6)	275 (72.7)
Hydraulic oil tank			100 (26.4)	80 (21.1)	123 (32.5)
MACHINE SPEC.:					
Boom (2 piece boom length)		mm (ft.in)	3855 (12'6")	3855 (12'6")	4600 (15'1")
Arm		mm (ft.in)	1650 (5'5")	1850 (6'1")	2500 (8'2")
Bucket (SAE)		m ³ (cu.yd)	0.28 (0.37)	0.33 (0.43)	0.48 (0.63)
Front and rear equipment		—	2 outriggers + blade	2 outriggers + blade	2 outriggers + blade

Item		Model	PW148-8***	PW160-8**	PW160-8***
OPERATING WEIGHT*		kg (lb)	15250 (33,620)	16670 (36,750)	16880 (37,210)
HORSEPOWER: ISO 14396 ISO 9249 Net		kW (HP)/RPM	90.0 (121)/2200 86.0 (115)/2200	97.0 (130)/2200 90.0 (121)/2200	97.0 (130)/2200 90.0 (121)/2200
BUCKET CAPACITY RANGE (SAE)		m ³ (cu.yd)	0.20 ~ 0.97 (0.26) (1.27)	0.20 ~ 0.97 (0.26) (1.27)	0.20 ~ 0.97 (0.26) (1.27)
PERFORMANCE:					
Swing speed		RPM	11	11	11
Travel speeds		km/h (MPH)	2.5 (1.6)	2.5 (1.6)	2.5 (1.6)
1st or Creep			9 (5.6)	10.5 (6.5)	10.5 (6.5)
2nd or Lo			35 (21.7)	35 (21.7)	35 (21.7)
3rd or Hi			0 ~ 35 (21.7)	0 ~ 35 (21.7)	0 ~ 35 (21.7)
4th or Auto			8900 (19,620)	9750 (21,490)	9750 (21,490)
Maximum drawbar pull		kg (lb)			
DIMENSIONS:		See the page of DIMENSIONS			
ENGINE:			KOMATSU	KOMATSU	KOMATSU
Model			SAA4D107E-1	SAA4D107E-1	SAA4D107E-1
No. of cylinders- bore × stroke		mm (in)	4-107 × 124 (4.21 × 4.88)	4-107 × 124 (4.21 × 4.88)	4-107 × 124 (4.21 × 4.88)
Piston displacement		ltr. (cu.in)	4.5 (275)	4.5 (275)	4.5 (275)
HYDRAULIC SYSTEM:					
Hydraulic pump			1 × Variable Piston	1 × Variable Piston	1 × Variable Piston
Max. oil flow		ltr.(U.S. Gal)/min.	252 (66.6)	308 (81.4)	308 (81.4)
Max. oil pressure (Implement)		kg/cm ² (PSI)	280 (3980)	380 (5400)	380 (5400)
WHEELS: (front)			10.00-20-14PR × 4	10.00-20-14PR × 4	10.00-20-14PR × 4
(rear)			10.00-20-14PR × 4	10.00-20-14PR × 4	10.00-20-14PR × 4
CAPACITY (Refilled):					
Fuel tank		ltr. (U.S. Gal)	275 (72.7)	300 (79.3)	300 (79.3)
Hydraulic oil tank			123 (32.5)	166 (43.9)	166 (43.9)
MACHINE SPEC.:					
Boom (2 piece boom length)		mm (ft.in)	4980 (16'1")	5300 (17'5")	5223 (17'2")
Arm		mm (ft.in)	2500 (8'2")	2500 (8'2")	2500 (8'2")
Bucket (SAE)		m ³ (cu.yd)	0.48 (0.63)	0.62 (0.81)	0.62 (0.81)
Front and rear equipment		—	2 outriggers + blade	2 outriggers + blade	2 outriggers + blade

* Operating weight includes coolant, lubricants, full fuel tank, operator 80kg (180lb) and, indicated implement, shoes and upper attachment.

** One piece boom

*** Two piece boom

Specifications

WHEEL-TYPE EXCAVATORS

Model		PW180-7**	PW180-7***	PW200-7**
OPERATING WEIGHT*	kg (lb)	17990 (39,660)	18220 (40,170)	20860 (45,990)
HORSEPOWER: ISO 14396 ISO 9249 Net	kW (HP)/RPM	116 (156)/2000 109 (146)/2000	116 (156)/2000 109 (146)/2000	134 (180)/2000 125 (168)/2000
BUCKET CAPACITY RANGE (SAE)	m ³ (cu.yd)	0.38 ~ 1.13 (0.50) (1.48)	0.38 ~ 1.13 (0.50) (1.48)	0.48 ~ 1.58 (0.63) (2.07)
PERFORMANCE: Swing speed Travel speeds 1st or Creep 2nd or Lo 3rd or Hi 4th or Auto Maximum drawbar pull	RPM km/h (MPH) kg (lb)	11.5 2.5 (1.6) 9.5 (5.9) 35 (21.7) 0 ~ 35 (21.7) 10500 (23,150)	11.5 2.5 (1.6) 9.5 (5.9) 35 (21.7) 0 ~ 35 (21.7) 10500 (23,150)	12.4 1.5 (0.9) 9 (5.6) 35 (21.7) 0 ~ 35 (21.7) 12600 (27,780)
DIMENSIONS: See the page of DIMENSIONS				
ENGINE: Model No. of cylinders- bore × stroke Piston displacement	mm (in) ltr. (cu.in)	KOMATSU SAA6D107E-1 6-107 × 124 (4.21 × 4.88) 6.69 (408)	KOMATSU SAA6D107E-1 6-107 × 124 (4.21 × 4.88) 6.69 (408)	KOMATSU SAA6D107E-1 6-107 × 124 (4.21 × 4.88) 6.69 (408)
HYDRAULIC SYSTEM: Hydraulic pump Max. oil flow Max. oil pressure (Implement)	ltr. (U.S. Gal)/min. kg/cm ² (PSI)	1 × Variable Piston 308 (81.4) 380 (5400)	1 × Variable Piston 308 (81.4) 380 (5400)	2 × Variable Piston 436.8 (115.4) 380 (5400)
WHEELS: (front) (rear)		10.00-20-14PR × 4 10.00-20-14PR × 4	10.00-20-14PR × 4 10.00-20-14PR × 4	10.00-20-16PR × 4 10.00-20-16PR × 4
CAPACITY (Refilled): Fuel tank Hydraulic oil tank	ltr. (U.S. Gal)	325 (85.9) 120 (31.7)	325 (85.9) 120 (31.7)	370 (97.8) 166 (43.9)
MACHINE SPEC.:* Boom (2 piece boom length) Arm Bucket (SAE)	mm (ft.in) mm (ft.in) m ³ (cu.yd)	5350 (17'7") 2600 (8'6") 0.75 (0.98)	5280 (17'4") 2600 (8'6") 0.75 (0.98)	5700 (18'8") 2400 (7'10") 0.80 (1.05)
Front and rear equipment	—	2 outriggers + blade	2 outriggers + blade	2 outriggers + blade

Model		PW200-7***	PW220-7**	PW220-7***
OPERATING WEIGHT*	kg (lb)	21540 (47,490)	22390 (49,360)	23050 (50,820)
HORSEPOWER: ISO 14396 ISO 9249 Net	kW (HP)/RPM	134 (180)/2000 125 (168)/2000	134 (180)/2000 125 (168)/2000	134 (180)/2000 125 (168)/2000
BUCKET CAPACITY RANGE (SAE)	m ³ (cu.yd)	0.48 ~ 1.58 (0.63) (2.07)	0.48 ~ 1.68 (0.63) (2.20)	0.48 ~ 1.68 (0.63) (2.20)
PERFORMANCE: Swing speed Travel speeds 1st or Creep 2nd or Lo 3rd or Hi 4th or Auto Maximum drawbar pull	RPM km/h (MPH) kg (lb)	12.4 1.5 (0.9) 9 (5.6) 35 (21.7) 0 ~ 35 (21.7) 12600 (27,780)	12.4 1.5 (0.9) 9 (5.6) 35 (21.7) 0 ~ 35 (21.7) 12600 (27,780)	12.4 1.5 (0.9) 9 (5.6) 35 (21.7) 0 ~ 35 (21.7) 12600 (27,780)
DIMENSIONS: See the page of DIMENSIONS				
ENGINE: Model No. of cylinders- bore × stroke Piston displacement	mm (in) ltr. (cu.in)	KOMATSU SAA6D107E-1 6-107 × 124 (4.21 × 4.88) 6.69 (408)	KOMATSU SAA6D107E-1 6-107 × 124 (4.21 × 4.88) 6.69 (408)	KOMATSU SAA6D107E-1 6-107 × 124 (4.21 × 4.88) 6.69 (408)
HYDRAULIC SYSTEM: Hydraulic pump Max. oil flow Max. oil pressure (Implement)	ltr. (U.S. Gal)/min. kg/cm ² (PSI)	2 × Variable Piston 436.8 (115.4) 380 (5400)	2 × Variable Piston 436.8 (115.4) 380 (5400)	2 × Variable Piston 436.8 (115.4) 380 (5400)
WHEELS: (front) (rear)		10.00-20-16PR × 4 10.00-20-16PR × 4	10.00-20-16PR × 4 10.00-20-16PR × 4	10.00-20-16PR × 4 10.00-20-16PR × 4
CAPACITY (Refilled): Fuel tank Hydraulic oil tank	ltr. (U.S. Gal)	370 (97.8) 166 (43.9)	370 (97.8) 166 (43.9)	370 (97.8) 166 (43.9)
MACHINE SPEC.:* Boom (2 piece boom length) Arm Bucket (SAE)	mm (ft.in) mm (ft.in) m ³ (cu.yd)	5410 (17'9") 2400 (7'10") 0.80 (1.05)	5700 (18'8") 2400 (7'10") 1.0 (1.31)	5410 (17'9") 2400 (7'10") 1.0 (1.31)
Front and rear equipment	—	2 outriggers + blade	2 outriggers + blade	2 outriggers + blade

* Operating weight includes coolant, lubricants, full fuel tank, operator 80kg (180lb) and, indicated implement, shoes and upper attachment.

** One piece boom

*** Two piece boom

Dimensions

WHEEL-TYPE EXCAVATORS

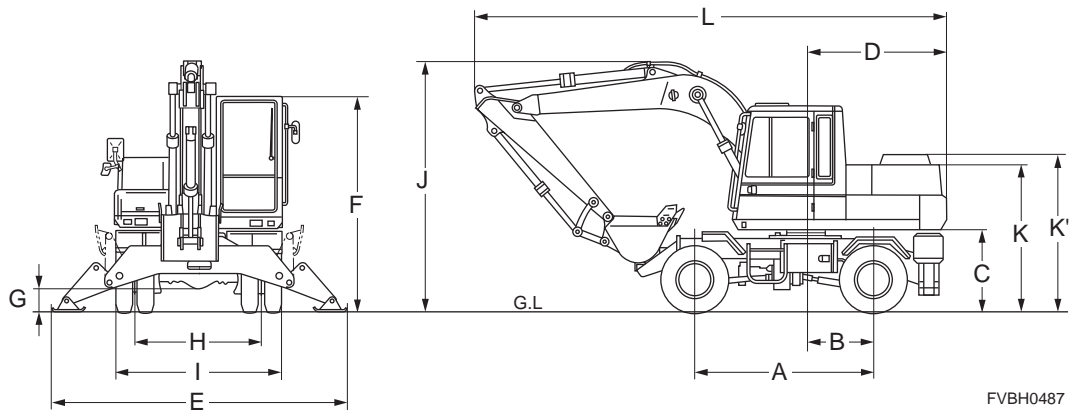

FVBH0487

	A mm (ft.in)	B mm (ft.in)	C mm (ft.in)	D mm (ft.in)	E mm (ft.in)	F mm (ft.in)	G mm (ft.in)	H mm (ft.in)	I mm (ft.in)	J mm (ft.in)	K, K' mm (ft.in)	L mm (ft.in)	Boom length m (ft.in)	Arm length m (ft.in)
PW98MR-8**	2200 (7'3")	1000 (3'3")	1120 (3'8")	1335 (4'5")	—	3100 (10'2")		1820 (6'0")	2350 (7'9")	3995 (13'1")	2200 (7'3")	5870 (19'3")	3.86 (12'8")	1.65 (5'5")
PW118MR-8**	2400 (7'10")	1100 (3'7")	1180 (3'10")	1440 (4'9")	—	3155 (10'4")		1935 (6'4")	2500 (8'2")	3995 (13'1")	2260 (7'5")	6071 (19'11")	3.86 (12'8")	1.85 (6'1")
												6051 (19'10")		2.0 (6'7")
PW148-8*	2500 (8'2")	1250 (4'3")	1240 (4'1")	1850 (6'1")	3660 (12'0")	3175 (10'5")	340 (1'1")	1915 (6'3")	2550 (8'4")	3680 (12'1")	2265 (7'5")	7120 (23'4")	4.6 (15'1")	2.1 (6'11")
												7120 (23'4")		2.5 (8'2")
												7160 (23'6")		3.0*** (9'10")
PW148-8**	2500 (8'2")	1250 (4'3")	1240 (4'1")	1850 (6'1")	3660 (12'0")	3175 (10'5")	340 (1'1")	1915 (6'3")	2550 (8'4")	3910 (12'1")	2265 (7'5")	5545 (18'2")	4.98 (16'1")	2.1 (6'11")
														2.5 (8'2")
														3.0*** (9'10")
PW160-8*	2600 (9'6")	1300 (4'3")	1265 (4'2")	2180 (7'2")	2490 (8'2")	3175 (10'5")	350 (1'2")	1915 (6'3")	2500 (8'2")	3500 (11'6")	2580 (8'6")	8290 (27'2")	5.3 (17'5")	2.1 (6'11")
										3500 (11'6")		8290 (27'2")		2.5 (8'2")
										3975 (13'0")		8045 (26'5")		3.0*** (9'10")
												5765 (18'11")		2.1 (6'11")
PW160-8**	2600 (9'6")	1300 (4'3")	1265 (4'2")	2180 (7'2")	2490 (8'2")	3175 (10'5")	350 (1'2")	1915 (6'3")	2500 (8'2")	3940 (12'11")	2580 (8'6")	5790 (19'0")	5.2 (17'1")	2.5 (8'2")
												5940 (19'6")		3.0*** (9'10")
PW180-7*	2600 (8'6")	1300 (4'3")	1303 (4'3")	2500 (8'2")	2490 (8'2")	3209 (10'6")	332 (1'1")	1914 (6'3")	2550 (8'4")	3720 (12'2")		8900 (29'2")	5.35 (17'7")	2.6 (8'6")
														2.9 (9'6")
PW180-7**	2600 (8'6")	1300 (4'3")	1303 (4'3")	2500 (8'2")	2490 (8'2")	3209 (10'6")	332 (1'1")	1914 (6'3")	2550 (8'4")	3972 (13')		6794 (22'3")	5.28 (17'4")	2.25 (7'5")
										3972 (13')		6717 (22'0")		2.6 (8'6")
										3960 (13')		6850 (22'76")		2.9 (9'6")

* One-piece boom

** Two-piece boom

*** Driving position without bucket

*4 2.55m (8'4") undercarriage spec.

*5 2.75m (9'0") undercarriage and 11.00-20 tyres spec.

Dimensions

WHEEL-TYPE EXCAVATORS

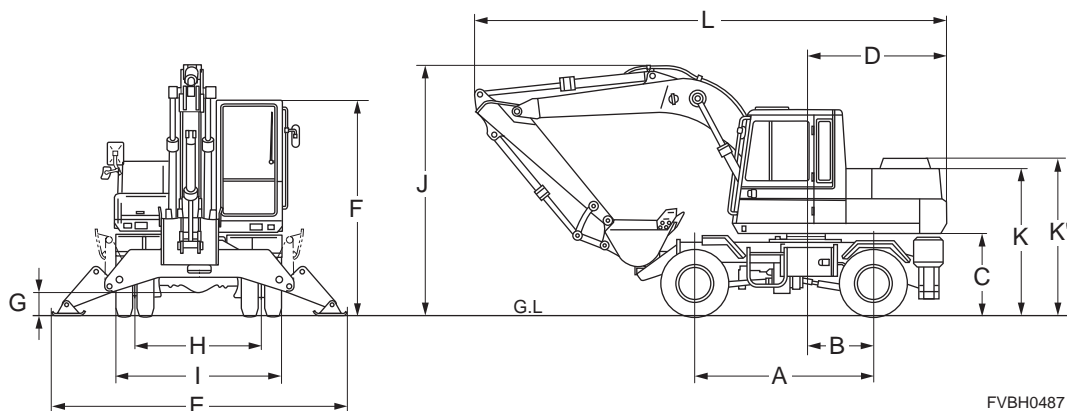

FVBH0487

	A mm (ft.in)	B mm (ft.in)	C mm (ft.in)	D mm (ft.in)	E mm (ft.in)	F mm (ft.in)	G mm (ft.in)	H mm (ft.in)	I mm (ft.in)	J mm (ft.in)	K, K' mm (ft.in)	L mm (ft.in)	Boom length m (ft.in)	Arm length m (ft.in)
PW200-7*	2750 (9'0")	1450 (4'9")	1327 (4'4") 1341 ^{*5} (4'5")	2700 (8'10")	2516 (8'3")	3234 (10'7") 3248 (10'8")	330 (1'1") 345 (1'2")	1914 (6'3") 2124 (7'0")	2550 ^{*4} (8'4") 2750 ^{*5} (9'0")	3906 (12'10")	2640 (8'8") 2655 ^{*5} (8'9")	9479 (31'1")	5.7 (18'8")	1.8 (5'11")
										3895 (12'9")		9435 (30'11")		2.4 (7'10")
										3912 (12'10")		9427 (30'11")		2.9 (9'6")
										3985 (13'1")		9467 (31'1")		3.5 (11'6")
										3980 (13'1")		7070 (23'2")		1.8 (5'11")
PW200-7**	2750 (9'0")	1450 (4'9")	1327 (4'4") 1341 ^{*5} (4'5")	2700 (8'10")	2516 (8'3")	3234 (10'7") 3248 (10'8")	330 (1'1") 345 (1'2")	1914 (6'3") 2124 (7'0")	2550 ^{*4} (8'4") 2750 ^{*5} (9'0")	3980 (13'1")	2640 (8'8") 2655 ^{*5} (8'9")	7070 (23'2")	5.4 (17'9")	1.8 (5'11")
										3980 (13'1")		7078 (23'3")		2.4 (7'10")
										3997 (13'1")		7000 (23'0")		2.9 (9'6")
										4505 (14'9")		7218 (23'8")		3.5 (11'6")
										3920 (12'10")		9479 (31'1")		1.8 (5'11")
PW220-7*	2750 (9'0")	1450 (4'9")	1341 (4'5")	2700 (8'10")	2516 (8'3")	3248 (10'8")	345 (1'2")	2124 (7'0")	2750 (9'0")	3920 (12'10")	2655 (8'9")	9479 (31'1")	5.7 (18'8")	1.8 (5'11")
										3909 (12'10")		9435 (30'11")		2.4 (7'10")
										3926 (12'11")		9427 (30'11")		2.9 (9'6")
										3999 (13'1")		9467 (31'1")		3.5 (11'6")
										3995 (13'1")		7070 (23'2")		1.8 (5'11")
PW220-7**	2750 (9'0")	1450 (4'9")	1341 (4'5")	2700 (8'10")	2516 (8'3")	3248 (10'8")	345 (1'2")	2124 (7'0")	2750 (9'0")	3995 (13'1")	2655 (8'9")	7070 (23'2")	5.4 (17'9")	1.8 (5'11")
										3995 (13'1")		7078 (23'3")		2.4 (7'10")
										4011 (13'2")		7000 (23'0")		2.9 (9'6")
										4519 (14'10")		7218 (23'8")		3.5 (11'6")
										3920 (12'10")		9479 (31'1")		1.8 (5'11")

* One-piece boom

** Two-piece boom

*** Driving position without bucket

^{*4} 2.55m (8'4") undercarriage spec.

^{*5} 2.75m (9'0") undercarriage and 11.00-20 tyres spec.

Working Ranges and Digging Force

WHEEL-TYPE EXCAVATORS

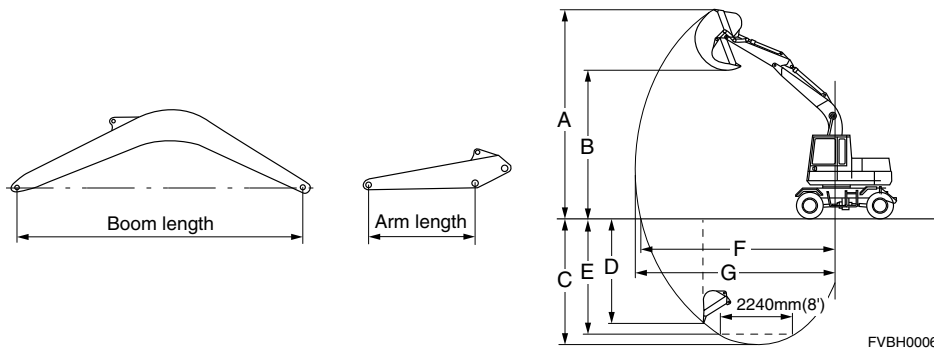

	Boom Length m (ft.in)	Arm length m (ft.in)	A mm (ft.in)	B mm (ft.in)	C mm (ft.in)	D mm (ft.in)	E mm (ft.in)	F mm (ft.in)	G mm (ft.in)	Bucket digging force*** kg (lb/kN)	Arm crowd force*** kg (lb/kN)
PW98MR-8**	3.86 (12'6")	1.65 (5'5")	8400 (27'7")	6330 (20'9")	4055 (13'4")	3415 (11'2")		7290 (23'11")	7585 (24'11")	6250 (13,780/61.3)	4230 (9,330/41.5)
		1.9 (6'3")	8630 (28'4")	6525 (21'5")	4305 (14'1")	3650 (12'0")		7560 (24'10")	7835 (25'8")		3800 (8380/37.2)
PW118MR-8**	3.86 (12'6")	1.85 (6'1")	8585 (28'2")	6515 (21'4")	4180 (13'9")	3355 (11'0")		7650 (21'1")	7950 (26'1")	7310 (16,120/71.7)	4600 (10,140/45.1)
		2.0 (6'7")	8725 (28'8")	6649 (21'10")	4330 (14'2")	3500 (11'6")		7800 (25'7")	8100 (26'7")		4600 (10,140/45.1)
PW148-8*	4.6 (15'1")	2.1 (6'1")	7980 (26'2")	5731 (18'10")	4462 (14'8")	3630 (11'11")	4025 (13'2")	7740 (25'5")	7928 (26'0")	9490 (20,910/93)	8160 (17,990/80)
		2.5 (6'7")	8270 (27'2")	6020 (19'9")	4860 (15'11")	4005 (13'2")	4570 (15'0")	8140 (26'8")	8290 (27'2")		6830 (15,070/67)
		3.0 (6'7")	8703 (28'7")	6449 (21'2")	5362 (17'7")	4470 (14'8")	4955 (16'3")	8640 (28'4")	8775 (28'9")		5710 (12,590/56)
PW148-8**	4.98 (16'1")	2.1 (6'1")	9228 (30'3")	6844 (22'5")	4845 (15'11")	3555 (11'8")	4515 (14'10")	7740 (25'5")	8268 (26'0")	9490 (20,910/93)	8160 (17,990/80)
		2.5 (6'7")	9518 (31'3")	7133 (23'5")	5245 (17'2")	4000 (13'1")	4935 (16'2")	8140 (26'8")	8681 (28'6")		6830 (15,070/67)
		3.0 (6'7")	9951 (32'8")	7562 (24'10")	5745 (18'10")	4495 (14'9")	5460 (17'11")	8640 (28'4")	9000 (29'6")		5710 (12,590/56)
PW160-8*	5.3 (17'5")	2.1 (6'1")	8730 (28'8")	6335 (20'9")	4925 (16'2")		4077 (13'5")	8620 (28'3")	8640 (28'4")	10400 (22,940/102)	7750 (17,090/76)
		2.5 (6'7")	8930 (29'4")	8555 (28'1")	5320 (17'5")		4477 (14'8")	8885 (29'2")	9070 (29'9")		6530 (14,390/64)
		3.0 (6'7")	9285 (30'6")	6911 (22'8")	5600 (18'4")		4977 (16'4")	9315 (30'7")	9485 (31'1")		5410 (11,920/53)
PW160-8**	5.22 (17'2")	2.1 (6'1")	9611 (31'6")	7135 (23'5")	4968 (16'4")		4660 (15'3")	8343 (27'4")	8533 (28'0")	10400 (22,940/102)	7750 (17,090/76)
		2.5 (6'7")	9910 (32'6")	7433 (24'5")	5365 (17'7")		5062 (16'7")	8715 (28'7")	8905 (29'3")		6530 (14,390/64)
		3.0 (6'7")	10337 (33'11")	7860 (25'9")	5861 (19'3")		5562 (18'3")	9224 (30'3")	9397 (30'10")		5410 (11,920/53)
PW180-7*	5.35 (17'7")	2.25 (7'5")	9458 (31'0")	6915 (22'8")	5321 (17'5")			8876 (29'1")	9061 (29'9")	12500 (27,560/123)	9700 (21,380/95.1)
		2.6 (8'6")	9562 (31'4")	7064 (23'2")	5676 (18'7")			9170 (30'1")	9345 (30'8")		9000 (19,840/88.3)
		2.9 (9'6")	9756 (32'0")	7236 (23'9")	5966 (19'7")			9759 (32'0")	9929 (32'7")		8100 (17,860/79.4)
PW180-7**	5.28 (17'4")	2.25 (7'5")	9942 (32'7")	7283 (23'10")	5400 (17'9")			8907 (29'3")	9080 (29'9")	12500 (27,560/123)	9700 (21,380/95.1)
		2.6 (8'6")	10129 (33'3")	7489 (24'7")	5742 (18'10")			9227 (30'3")	9401 (30'10")		9000 (19,840/88.3)
		2.9 (9'6")	10350 (33'11")	7709 (25'4")	6044 (19'10")			9509 (31'2")	9683 (31'9")		8100 (17,860/79.4)

* One piece boom

** Two piece boom

*** Using power max function, expect PW98MR and PW118MR, ISO rating

*4 With optional large bucket cylinder

Working Ranges and Digging Force

WHEEL-TYPE EXCAVATORS

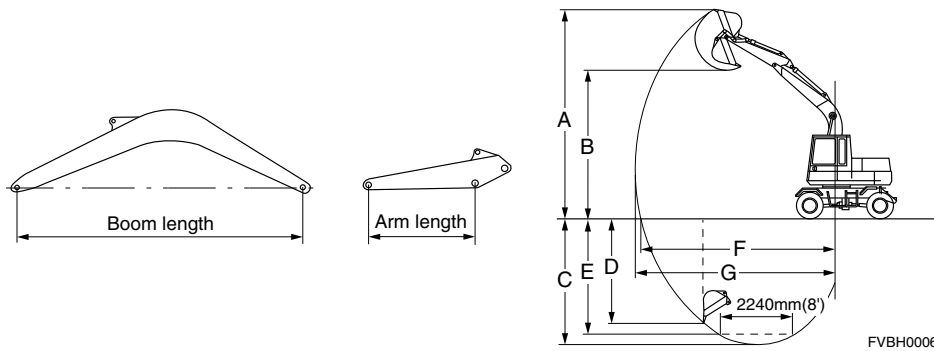

	Boom length m (ft.in)	Arm length m (ft.in)	A mm (ft.in)	B mm (ft.in)	C mm (ft.in)	D mm (ft.in)	E mm (ft.in)	F mm (ft.in)	G mm (ft.in)	Bucket digging force*** kg (lb/kN)	Arm crowd force*** kg (lb/kN)
PW200-7*	5.7 (18'8")	1.8 (5'11")	9467 (31'1")	6704 (22'0")	4791 (15'9")	4141 (13'7")	4575 (15'0")	8867 (29'1")	9061 (29'9")	17950* ⁴ (39,570/176)	14800 (32,630/145)
		2.4 (7'11")	9883 (32'5")	7057 (23'2")	5402 (17'9")	4745 (15'7")	5225 (17'2")	9438 (31'0")	9651 (31'8")		13000 (28,660/127)
		2.9 (9'6")	10003 (32'10")	7229 (23'9")	5917 (19'5")	5227 (17'2")	5763 (18'11")	9875 (32'5")	10060 (33'0")	15190 (33,490/149)	11000 (24,250/108)
		3.5 (11'6")	10438 (34'3")	7612 (25'0")	6500 (21'4")	5809 (19'1")	6366 (20'11")	10478 (34'5")	10642 (34'11")		9100 (20,060/89)
PW200-7**	5.4 (17'9")	1.8 (5'11")	9532 (31'3")	6670 (21'11")	5186 (17'0")	4104 (13'6")	5119 (16'10")	8599 (28'3")	8818 (28'11")	17950* ⁴ (39,570/176)	14800 (32,630/145)
		2.4 (7'11")	9842 (32'3")	6982 (22'11")	5785 (19'0")	4666 (15'4")	5713 (18'9")	9144 (30'0")	9348 (30'8")		13000 (28,660/127)
		2.9 (9'6")	10168 (33'4")	7298 (23'11")	6285 (20'7")	5208 (17'1")	6226 (20'5")	9634 (31'7")	9822 (32'3")	15190 (33,490/149)	11000 (24,250/108)
		3.5 (11'6")	10434 (34'3")	7574 (24'10")	6860 (22'6")	5768 (18'11")	6793 (22'3")	10156 (33'4")	10338 (33'11")		9100 (20,060/89)
PW220-7*	5.7 (18'8")	1.8 (5'11")	9467 (31'1")	6704 (22'0")	4791 (15'9")	4141 (13'7")	4575 (15'0")	8867 (29'1")	9061 (29'9")	17950* ⁴ (39,570/176)	14800 (32,630/145)
		2.4 (7'11")	9883 (32'5")	7057 (23'2")	5402 (17'9")	4745 (15'7")	5225 (17'2")	9438 (31'0")	9651 (31'8")		13000 (28,660/127.5)
		2.9 (9'6")	10003 (32'10")	7229 (23'9")	5917 (19'5")	5227 (17'2")	5763 (18'11")	9875 (32'5")	10060 (33'0")	15190 (33,490/149)	11000 (24,250/108)
		3.5 (11'6")	10438 (34'3")	7612 (25'0")	6500 (21'4")	5809 (19'1")	6366 (20'11")	10478 (34'5")	10642 (34'11")		9100 (20,060/89)
PW220-7**	5.4 (17'9")	1.8 (5'11")	9532 (31'3")	6670 (21'11")	5186 (17'0")	4104 (13'6")	5119 (16'10")	8599 (28'3")	8818 (28'11")	17950* ⁴ (39,570/176)	14800 (32,630/145)
		2.4 (7'11")	9842 (32'3")	6982 (22'11")	5785 (19'0")	4666 (15'4")	5713 (18'9")	9144 (30'0")	9348 (30'8")		13000 (28,660/127.5)
		2.9 (9'6")	10168 (33'4")	7298 (23'11")	6285 (20'7")	5208 (17'1")	6226 (20'5")	9634 (31'7")	9822 (32'3")	15190 (33,490/149)	11000 (24,250/108)
		3.5 (11'6")	10434 (34'3")	7574 (24'10")	6860 (22'6")	5768 (18'11")	6793 (22'3")	10156 (33'4")	10338 (33'11")		9100 (20,060/89)

* One piece boom

** Two piece boom

*** Using power max function, expect PW98MR and PW118MR, ISO rating

*⁴ With optional large bucket cylinder

Bucket and Arm Combinations

WHEEL-TYPE EXCAVATORS

These charts are based on over-side stability with fully loaded bucket at maximum reach. ○ General purpose use, weight up to 1.8 t/m ³ (3000 lb/cu.yd) □ General purpose use, weight up to 1.5 t/m ³ (2500 lb/cu.yd) △ Light duty work, weight up to 1.2 t/m ³ (2000 lb/cu.yd) ✕ Not usable.							
Bucket capacity (heaped)		Width		Weight kg (lb) (Without side cutters)	Arm length m (ft.in)		
SAE, PCSA m ³ (cu.yd)	CECE m ³ (cu.yd)	Without side cutters or side shrouds mm (in)	With side cutters or side shrouds mm (in)				
PW98MR-8					1.65 (5'5")	1.90 (6'3")	
0.077 (0.10)	—	350 (13.8")	450 (17.7")	○	○		
0.109 (0.14)	—	450 (17.7")	550 (21.7")	○	○		
0.181 (0.24)	—	550 (21.7")	650 (25.6")	○	○		
0.235 (0.31)	—	650 (25.6")	750 (29.5")	○	○		
0.282 (0.37)	—	750 (29.5")	825 (32.5")	○	○		
PW118MR-8					1.85 (6'1")	2.0 (6'7")	
0.093 (0.12)	—	300 (11.8")	—	168 (370)	○	○	
0.15 (0.20)	—	400 (15.7")	—	194 (428)	○	○	
0.19 (0.25)	—	500 (19.7")	—	218 (481)	○	○	
0.24 (0.31)	—	600 (23.6")	—	234 (516)	○	○	
0.28 (0.37)	—	700 (27.6")	—	252 (556)	○	○	
0.33 (0.43)	—	800 (31.5")	—	270 (595)	○	○	
0.36 (0.47)	—	900 (35.4")	—	294 (648)	○	△	
0.40 (0.52)	—	1000 (39.4")	—	320 (705)	○	△	
PW148-8					2.1 (6'11")	2.5 (8'2")	3.0 (9'10")
0.20 (0.26)	0.19 (0.25)	400 (15.7")	—	270 (595)	○	○	○
0.27 (0.35)	0.25 (0.33)	450 (17.7")	—	300 (661)	○	○	○
0.41 (0.54)	0.37 (0.48)	600 (23.6")	—	420 (926)	○	○	○
0.48 (0.63)	0.44 (0.58)	700 (27.6")	—	445 (981)	○	○	○
0.55 (0.72)	0.50 (0.65)	800 (31.5")	—	460 (1014)	○	○	○
0.62 (0.81)	0.57 (0.75)	900 (35.4")	—	495 (1091)	○	○	○
0.69 (0.90)	0.63 (0.82)	1000 (39.4")	—	530 (1168)	○	○	○
0.76 (0.99)	0.69 (0.90)	1100 (43.3")	—	550 (1213)	○	○	□
0.83 (1.09)	0.76 (0.99)	1200 (47.2")	—	575 (1268)	○	□	△
0.90 (1.18)	0.82 (1.07)	1300 (51.2")	—	605 (1334)	□	□	△
0.97 (1.27)	0.89 (1.16)	1400 (55.1")	—	630 (1389)	□	△	✕
PW160-8					2.1 (6'11")	2.5 (8'2")	3.0 (9'10")
0.20 (0.26)	0.19 (0.25)	400 (15.7")	—	270 (595)	○	○	○
0.27 (0.35)	0.25 (0.33)	450 (17.7")	—	300 (661)	○	○	○
0.41 (0.54)	0.37 (0.48)	600 (23.6")	—	420 (926)	○	○	○
0.48 (0.63)	0.44 (0.58)	700 (27.6")	—	445 (981)	○	○	○
0.55 (0.72)	0.50 (0.65)	800 (31.5")	—	460 (1014)	○	○	○
0.62 (0.81)	0.57 (0.75)	900 (35.4")	—	495 (1091)	○	○	○
0.69 (0.90)	0.63 (0.82)	1000 (39.4")	—	530 (1168)	○	○	○
0.76 (0.99)	0.69 (0.90)	1100 (43.3")	—	550 (1213)	○	□	□
0.83 (1.09)	0.76 (0.99)	1200 (47.2")	—	575 (1268)	□	□	□
0.90 (1.18)	0.82 (1.07)	1300 (51.2")	—	605 (1334)	□	△	△
0.97 (1.27)	0.89 (1.16)	1400 (55.1")	—	630 (1389)	△	△	△
PW180-7					2.25 (7'5")	2.6 (8'6")	2.9 (9'6")
0.38 (0.50)	—	600 (23.6")	—	385 (849)	○	○	○
0.56 (0.73)	—	700 (27.6")	—	435 (959)	○	○	○
0.57 (0.75)	—	800 (31.5")	—	465 (1025)	○	○	○
0.66 (0.86)	—	900 (35.4")	—	495 (1091)	○	○	○
0.75 (0.98)	—	1000 (39.4")	—	530 (1168)	○	○	○
0.94 (1.23)	—	1200 (47.2")	—	615 (1356)	□	□	△
1.13 (1.48)	—	1400 (55.1")	—	695 (1532)	△	△	✕

Bucket and Arm Combinations

WHEEL-TYPE EXCAVATORS

These charts are based on over-side stability with fully loaded bucket at maximum reach.								
○ General purpose use, weight up to 1.8 t/m ³ (3000 lb/cu.yd) □ General purpose use, weight up to 1.5 t/m ³ (2500 lb/cu.yd)								
△ Light duty work, weight up to 1.2 t/m ³ (2000 lb/cu.yd) × Not usable.								
Bucket capacity (heaped)		Width		Weight kg (lb) (Without side cutters)	Arm length m (ft.in)			
SAE,PCSA m ³ (cu.yd)	CECE m ³ (cu.yd)	Without side cutters or side shrouds mm (in)	With side cutters or side shrouds mm (in)					
PW200-7					1.8 (5'11")	2.4 (7'11")	2.9 (9'6")	3.5 (11'6")
0.48 (0.63)	—	600 (23.6")	—	480 (1058)	○	○	○	○
0.55 (0.72)	—	700 (27.6")	—	530 (1168)	○	○	○	○
0.63 (0.82)	—	800 (31.5")	—	580 (1279)	○	○	○	○
0.71 (0.93)	—	900 (35.4")	—	610 (1345)	○	○	○	○
0.78 (1.02)	—	1000 (39.4")	—	650 (1433)	○	○	○	□
0.86 (1.12)	—	1100 (43.3")	—	700 (1543)	○	○	□	△
0.96 (1.26)	—	1200 (47.2")	—	760 (1675)	○	○	□	△
1.03 (1.35)	—	1300 (51.2")	—	810 (1786)	○	□	△	×
1.11 (1.45)	—	1400 (55.1")	—	870 (1918)	□	△	△	×
1.19 (1.56)	—	1500 (59.1")	—	930 (2050)	△	△	×	×
1.49 (1.95)	—	1600 (63.0")	—	1100 (2425)	×	×	×	×
1.58 (2.07)	—	1700 (66.9")	—	1150 (2535)	×	×	×	×
PW220-7					1.8 (5'11")	2.4 (7'11")	2.9 (9'6")	3.5 (11'6")
0.48 (0.63)	—	600 (23.6")	—	480 (1058)	○	○	○	○
0.55 (0.72)	—	700 (27.6")	—	530 (1168)	○	○	○	○
0.63 (0.82)	—	800 (31.5")	—	580 (1279)	○	○	○	○
0.71 (0.93)	—	900 (35.4")	—	610 (1345)	○	○	○	○
0.78 (1.02)	—	1000 (39.4")	—	650 (1433)	○	○	○	○
0.86 (1.12)	—	1100 (43.3")	—	700 (1543)	○	○	○	○
0.96 (1.26)	—	1200 (47.2")	—	760 (1675)	○	○	○	□
1.03 (1.35)	—	1300 (51.2")	—	810 (1786)	○	○	□	△
1.11 (1.45)	—	1400 (55.1")	—	870 (1918)	○	□	□	△
1.19 (1.56)	—	1500 (59.1")	—	930 (2050)	○	□	△	×
1.49 (1.95)	—	1600 (63.0")	—	1100 (2425)	△	×	×	×
1.58 (2.07)	—	1700 (66.9")	—	1150 (2535)	△	×	×	×
1.68 (2.20)	—	1800 (70.9")	—	1200 (2646)	×	×	×	×

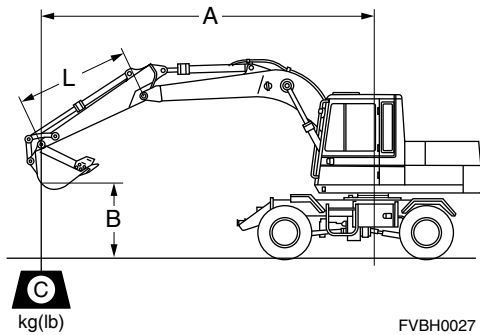

- A : Reach from swing center
- B : Bucket hook height
- C : Lifting capacity
- Cf : Rating over front
- Cs : Rating over side
- MAX : Rating at maximum reach
- L : Arm length

FVBH0027

PW98MR-8 (Two-piece boom)

Conditions:

Bucket (SAE): 0.282 m³, Tires: 8.25-20, additional counterweight 218 kg

unit: kg

	Max.		6.0 m		5.0 m		4.0 m	
	Cf	Cs	Cf	Cs	Cf	Cs	Cf	Cs
Arm length 1650 mm With front blade and rear outriggers above ground								
4.5 m			1005	756	*1479	1098	*1610	*1610
3.0 m	848	564	1005	713	1403	954	1988	1404
1.5 m	825	540	930	672	1305	840	1725	1176
0.0 m	867	570	987	683	1283	882	1722	1170
Arm length 1900 mm With front blade and rear outriggers above ground								
4.5 m			980	731	*1479	1073	*1610	*1610
3.0 m	798	514	980	688	1378	929	1963	1379
1.5 m	800	515	905	647	1280	815	1700	1151
0.0 m	817	520	962	658	1258	857	1697	1145
Arm length 1650 mm With rear blade on ground								
4.5 m			*1566	836	*1479	1159	*1610	*1610
3.0 m	*1566	559	*1653	776	*1940	1121	*2471	*1549
1.5 m	*1549	551	*1909	728	*2249	965	*2975	1253
0.0 m	*1626	557	*2004	728	*2204	984	*2975	1240
Arm length 1900 mm With rear blade on ground								
4.5 m			*1456	932	*1479	1175	*1610	*1610
3.0 m	*1442	525	*1618	789	*1918	1136	*2371	1616
1.5 m	*1470	529	*1792	686	*2232	917	*2971	1346
0.0 m	*1470	534	*1846	700	*2187	945	*2971	1333
Arm length 1650 mm With front blade and rear outriggers on ground								
4.5 m			*1566	1118	*1479	*1479	*1610	*1610
3.0 m	*1566	824	*1653	975	*1940	1342	*2471	2067
1.5 m	*1549	852	*1909	993	*2249	1264	*2975	1823
0.0 m	*1626	861	*2004	993	*2204	1289	*2975	1804
Arm length 1900 mm With front blade and rear outriggers on ground								
4.5 m			*1456	1050	*1479	*1479	*1610	*1610
3.0 m	*1442	746	*1618	1058	*1918	1422	*2371	*2371
1.5 m	*1470	795	*1792	990	*2232	1307	*2971	1935
0.0 m	*1470	803	*1846	1010	*2187	1346	*2971	1916

* Load is limited by hydraulic capacity rather than tipping.
Rating are based on ISO Standard NO. 10567. Rated loads do not exceed 87% of hydraulic lift capacity or 75% of tipping load.

PW118MR-8 (Two-piece boom)

Conditions:

Bucket (SAE): 0.33 m³, Tires: 9.00-20, additional counterweight 388 kg

unit: kg

	Max.		6.0 m		4.5 m		3.0 m	
	Cf	Cs	Cf	Cs	Cf	Cs	Cf	Cs
Arm length 1850 mm With front blade and rear outriggers above ground								
4.5 m	*1840	1170	*1910	1440	*2080	*2080		
3.0 m	*1740	1030	*2130	1380	*2790	2160		
1.5 m	*1780	1000	*2410	1310				
0.0 m	*1880	1080	*2460	1280	*3750	1930		
Arm length 2000 mm With front blade and rear outriggers above ground								
4.5 m	*1680	1110	*1830	1440	*1960	*1960		
3.0 m	*1590	980	*2070	370	*2680	2170		
1.5 m	*1620	960	*2370	1300				
0.0 m	*1790	1030	*2450	1270	*3740	1910		
Arm length 1850 mm With rear blade on ground								
4.5 m	*1840	1208	*1910	*1910	*2080	*2080		
3.0 m	*1740	1140	*2130	1538	*2790	2370		
1.5 m	*1780	1148	*2410	1508				
0.0 m	*1880	1182	*2460	1477	*3750	2190		
Arm length 2000 mm With rear blade on ground								
4.5 m	*1680	1148	*1830	*1830	*1960	*1960		
3.0 m	*1590	1013	*2070	1508	*2680	2340		
1.5 m	*1620	1005	*2370	1425				
0.0 m	*1790	1075	*2450	1397	*3740	2198		
Arm length 1850 mm With front blade and rear outriggers on ground								
4.5 m	*1840	1373	*1910	*1910	*2080	*2080		
3.0 m	*1740	1290	*2130	*2130	*2790	*2790		
1.5 m	*1780	1253	*2410	1703				
0.0 m	*1880	1290	*2460	1668	*3750	2562		
Arm length 2000 mm With front blade and rear outriggers on ground								
4.5 m	*1680	1313	*1830	*1830	*1960	*1960		
3.0 m	*1590	1170	*2070	*2070	*2680	*2680		
1.5 m	*1620	1125	*2370	1538				
0.0 m	*1790	1159	*2450	1507	*3740	2443		

* Load is limited by hydraulic capacity rather than tipping.

Rating are based on ISO Standard NO. 10567. Rated loads do not exceed 87% of hydraulic lift capacity or 75% of tipping load.

PW148-8 (One-piece boom)

Conditions:

Bucket (SAE): 0.48 m³, Tires: 10.00-20

unit: kg

	Max.		7.5 m		6.0 m		4.5 m		3.0 m	
	Cf	Cs	Cf	Cs	Cf	Cs	Cf	Cs	Cf	Cs
Arm length 2500 mm Without stabilizer										
6.0 m	*1900	1850								
4.5 m	*1800	1400			2400	1800				
3.0 m	1600	1150			2350	1750	3850	2850	*7250	5700
1.5 m	1550	1100			2200	1600	3550	2550	*8300	4400
0.0 m	1550	1100			2100	1500	3300	2200	*7250	4050
-1.5 m	1800	1250			2050	1450	3250	2300	*6200	3950
-3.0 m	2400	1700					3250	2350	6500	4500
Arm length 2500 mm With front or rear blade										
6.0 m	*1900	*1900								
4.5 m	*1800	1550			*3700	2050				
3.0 m	*1850	1350			*3950	1950	*4850	3200	*7250	6350
1.5 m	*2000	1250			*4350	1800	*5850	2900	*8300	5400
0.0 m	*2300	1300			*4450	1700	*6100	2700	*7250	5050
-1.5 m	*2950	1450			*4050	1700	*5850	2650	*6200	5000
-3.0 m	*3100	1950					*4500	2650	*6500	5150
Arm length 2500 mm With rear outrigger										
6.0 m	*1900	*1900								
4.5 m	*1800	*1800			*3700	2600				
3.0 m	*1850	1750			*3950	2500	*4850	4050	*7250	*7250
1.5 m	*2000	1650			*4350	2350	*5850	3750	*8300	*8300
0.0 m	*2300	1700			*4450	2250	*6100	3550	*7250	*7250
-1.5 m	*2950	1900			*4050	2200	*5850	3450	*6200	*6200
-3.0 m	*3100	2550					*4500	3500	*6500	*6500
Arm length 2500 mm With outrigger and blade										
6.0 m	*1900	*1900								
4.5 m	*1800	*1800			*3700	3100				
3.0 m	*1850	*1850			*3950	3000	*4850	4850	*7250	*7250
1.5 m	*2000	*2000			*4350	2850	*5850	4550	*8300	*8300
0.0 m	*2300	2100			*4450	2750	*6100	4300	*7250	*7250
-1.5 m	*2950	2350			*4050	2700	*5850	4250	*6200	*6200
-3.0 m	*3100	3100					*4500	4250	*6500	*6500
Arm length 2500 mm With outrigger front and rear										
6.0 m	*1900	*1900								
4.5 m	*1800	*1800			*3700	*3700				
3.0 m	*1850	*1850			*3950	3900	*4850	*4850	*7250	*7250
1.5 m	*2000	*2000			*4350	3750	*5850	*5850	*8300	*8300
0.0 m	*2300	*2300			*4450	3650	*6100	5850	*7250	*7250
-1.5 m	*2950	*2950			*4050	3600	*5850	5750	*6200	*6200
-3.0 m	*3100	3100					*4500	*4500	*6500	*6500

* Load is limited by hydraulic capacity rather than tipping.

Rating are based on SAE Standard NO. J1097. Rated loads do not exceed 87% of hydraulic lift capacity or 75% of tipping load.

PW148-8 (Two-piece boom)

Conditions:

Bucket (SAE): 0.48 m³, Tires: 10.00-20

unit: kg

	Max.		7.5 m		6.0 m		4.5 m		3.0 m	
	Cf	Cs	Cf	Cs	Cf	Cs	Cf	Cs	Cf	Cs
Arm length 2500 mm Without stabilizer										
7.5 m	*1750	*1750					*3350	*3350		
6.0 m	*1500	*1500			3050	2100	*3450	*3450		
4.5 m	*1400	1200	*1750	1250	3000	2050	*4000	3450	*3500	*3500
3.0 m	*1400	1050	1950	1250	2900	1950	4700	3150		
1.5 m	*1500	1000	1850	1200	2750	1800	4350	2850		
0.0 m	*1650	1050	1800	1150	2650	1700	4150	2650	*4050	4050
-1.5 m	1900	1200			2600	1650	4100	2600	*6900	4950
-3.0 m					2650	1700	4150	2650		
Arm length 2500 mm With front or rear blade										
7.5 m	*1750	*1750					*3350	*3350		
6.0 m	*1500	*1500			*3150	2300	*3450	*3450		
4.5 m	*1400	1400	*1750	1450	*3850	2250	*4000	3750	*3500	*3500
3.0 m	*1400	1200	*3150	1400	*5000	2150	*6450	3500		
1.5 m	*1500	1150	*3900	1350	*5500	2000	*7550	3200		
0.0 m	*1650	1200	*3850	1300	*5700	1900	*8000	3000	*4050	*4050
-1.5 m	*2000	1350			*5400	1850	*7550	2900	*6900	5500
-3.0 m					*4150	1900	*6150	2950		
Arm length 2500 mm With rear outrigger										
7.5 m	*1750	*1750					*3350	*3350		
6.0 m	*1500	*1500			*3150	2650	*3450	*3450		
4.5 m	*1400	*1400	*1750	1700	*3850	2600	*4000	*4000	*3500	*3500
3.0 m	*1400	*1400	*3150	1650	*5000	2500	*6450	4000		
1.5 m	*1500	1400	*3900	1600	*5500	2350	*7550	3700		
0.0 m	*1650	1450	*3850	1550	*5700	2250	*8000	3500	*4050	*4050
-1.5 m	*2000	1600			*5400	2200	*7550	3450	*6900	6650
-3.0 m					*4150	2250	*6150	3500		
Arm length 2500 mm With outrigger and blade										
7.5 m	*1750	*1750					*3350	*3350		
6.0 m	*1500	*1500			*3150	*3150	*3450	*3450		
4.5 m	*1400	*1400	*1750	*1750	*3850	3750	*4000	*4000	*3500	*3500
3.0 m	*1400	*1400	*3150	2450	*5000	3600	*6450	5850		
1.5 m	*1500	*1500	*3900	2400	*5500	3450	*7550	5500		
0.0 m	*1650	*1650	*3850	2350	*5700	3350	*8000	5250	*4050	*4050
-1.5 m	*2000	*2000			*5400	3300	*7550	5200	*6900	*6900
-3.0 m					*4150	3350	*6150	5250		
Arm length 2500 mm With outrigger front and rear										
7.5 m	*1750	*1750					*3350	*3350		
6.0 m	*1500	*1500			*3150	*3150	*3450	*3450		
4.5 m	*1400	*1400	*1750	*1750	*3850	*3850	*4000	*4000	*3500	*3500
3.0 m	*1400	*1400	*3150	2950	*5000	4350	*6450	*6450		
1.5 m	*1500	*1500	*3900	2900	*5500	4200	*7550	6700		
0.0 m	*1650	*1650	*3850	2850	*5700	4050	*8000	6500	*4050	*4050
-1.5 m	*2000	*2000			*5400	4000	*7550	6400	*6900	*6900
-3.0 m					*4150	4050	*6150	*6150		

* Load is limited by hydraulic capacity rather than tipping.
Rating are based on SAE Standard NO. J1097. Rated loads do not exceed 87% of hydraulic lift capacity or 75% of tipping load.

PW160-8 (One-piece boom)

Conditions:

Bucketless, Tires: 10.00-20

unit: kg

	Max.		7.5 m		6.0 m		4.5 m		3.0 m	
	Cf	Cs	Cf	Cs	Cf	Cs	Cf	Cs	Cf	Cs
Arm length 2100 mm Without stabilizer										
7.5 m	*2945	*2945								
6.0 m	*2595	*2595			3645	2695				
4.5 m	*2445	1945			3595	2645	5545	3995		
3.0 m	2395	1745	2545	1845	3445	2545	5195	3695		
1.5 m	2345	1695	2495	1795	3345	2395	4845	3395		
0.0 m	2395	1745	2445	1745	3245	2295	4695	3245		
-1.5 m	2595	1895			3245	2345	4695	3195	*7395	5495
-3.0 m	3195	2295			3245	2345	4695	3245	*7045	5645
Arm length 2100 mm With front or rear blade										
7.5 m	*2945	*2945								
6.0 m	*2595	*2595			*4245	3095				
4.5 m	*2445	2245			*5195	3045	*5745	4645		
3.0 m	*2445	2045	*3845	2145	*5595	2945	*7195	4295		
1.5 m	*2545	1995	4495	2095	*5895	2795	*7995	3995		
0.0 m	*2795	1995	*3945	2045	*5895	2695	*7945	3845		
-1.5 m	*3245	2195			*5345	2695	*7145	3795	*7395	6745
-3.0 m	*3395	2695			*3695	2745	*5545	3845	*7045	6895
Arm length 2100 mm With rear outrigger										
7.5 m	*2945	*2945								
6.0 m	*2595	*2595			*4245	3445				
4.5 m	*2445	*2445			*5195	3395	*5745	5195		
3.0 m	*2445	2295	*3845	2395	*5595	3295	*7195	4845		
1.5 m	*2545	2195	*4645	2345	*5895	3145	*7995	4545		
0.0 m	*2795	2295	*3945	2345	*5895	3045	*7945	4395		
-1.5 m	*3245	2495			*5345	2995	*7145	4345	*7395	*7395
-3.0 m	*3395	2995			*3695	3095	*5545	4395	*7045	*7045
Arm length 2100 mm With outrigger and blade										
7.5 m	*2945	*2945								
6.0 m	*2595	*2595			*4245	*4245				
4.5 m	*2445	*2445			*5195	4295	*5745	*5745		
3.0 m	*2445	*2445	*3845	3045	*5595	4195	*7195	6295		
1.5 m	*2545	*2545	*4645	2995	*5895	4045	*7995	5995		
0.0 m	*2795	*2795	*3945	2945	*5895	3945	*7945	5795		
-1.5 m	*3245	3195			*5345	3895	*7145	5745	*7395	*7395
-3.0 m	*3395	*3395			*3695	*3695	*5545	*5545	*7045	*7045
Arm length 2100 mm With outrigger front and rear										
7.5 m	*2945	*2945								
6.0 m	*2595	*2595			*4245	*4245				
4.5 m	*2445	*2445			*5195	5045	*5745	*5745		
3.0 m	*2445	*2445	*3845	3545	*5595	4895	*7195	*7195		
1.5 m	*2545	*2545	*4645	3495	*5895	4745	*7995	7195		
0.0 m	*2795	*2795	*3945	3445	*5895	4645	*7945	6995		
-1.5 m	*3245	*3245			*5345	4595	*7145	6945	*7395	*7395
-3.0 m	*3395	*3395			*3695	*3695	*5545	*5545	*7045	*7045

* Load is limited by hydraulic capacity rather than tipping. Rating are based on SAE Standard NO. J1097. Rated loads do not exceed 87% of hydraulic lift capacity or 75% of tipping load.

PW160-8 (One-piece boom)

Conditions:

Bucketless, Tires: 10.00-20

unit: kg

	Max.		7.5 m		6.0 m		4.5 m		3.0 m	
	Cf	Cs	Cf	Cs	Cf	Cs	Cf	Cs	Cf	Cs
Arm length 2500 mm Without stabilizer										
7.5 m	*2295	*2295								
6.0 m	*2095	*2095			3645	2695				
4.5 m	*2045	1845	*2495	1895	3595	2645				
3.0 m	*2095	1645	2545	1845	3495	2545	5245	3745	9995	6545
1.5 m	*2195	1595	2445	1795	3345	2395	4945	3445		
0.0 m	2245	1645	2395	1745	3245	2295	4745	3245	*4895	*4895
-1.5 m	2445	1745			3195	2245	4645	3195	*7595	5545
-3.0 m	2895	2095			3195	2295	4695	3245	*8045	5645
Arm length 2500 mm With front or rear blade										
7.5 m	*2295	*2295								
6.0 m	*2095	*2095			*3695	3095				
4.5 m	*2045	*2045	*2495	2195	*4595	3045				
3.0 m	*2095	1945	*3795	2145	*5395	2945	*6895	4395	*10545	7845
1.5 m	*2195	1895	4495	2095	*5795	2795	*7845	4095		
0.0 m	*2445	1895	4445	2045	*5895	2695	*8045	3895	*4895	*4895
-1.5 m	*2895	2095			*5545	2645	*7445	3795	*7595	6745
-3.0 m	*3645	2445			*4345	2695	*6045	3845	*8045	6895
Arm length 2500 mm With rear outrigger										
7.5 m	*2295	*2295								
6.0 m	*2095	*2095			*3695	3445				
4.5 m	*2045	*2045	*2495	2445	*4595	3395				
3.0 m	*2095	*2095	*3795	2395	*5395	3295	*6895	4945	*10545	*9045
1.5 m	*2195	2095	*4645	2345	*5795	3145	*7845	4595		
0.0 m	*2445	2145	*4545	2295	*5895	3045	*7845	4395	*4895	*4895
-1.5 m	*2895	2345			*5545	2995	*7445	4345	*7595	*7595
-3.0 m	*3645	2745			*4345	3045	*6045	4395	*8045	7995
Arm length 2500 mm With outrigger and blade										
7.5 m	*2295	*2295								
6.0 m	*2095	*2095			*3695	*3695				
4.5 m	*2045	*2045	*2495	*2495	*4595	4345				
3.0 m	*2095	*2095	*3795	3045	*5395	4195	*6895	6395	*10545	*10545
1.5 m	*2195	*2195	*4645	2995	*5795	4045	*7845	6045		
0.0 m	*2445	*2445	*4545	2945	*5895	3945	*8045	5845	*4895	*4895
-1.5 m	*2895	*2895			*5545	3845	*7445	5745	*7595	*7595
-3.0 m	*3645	3545			*4345	3895	*6045	5795	*8045	*8045
Arm length 2500 mm With outrigger front and rear										
7.5 m	*2295	*2295								
6.0 m	*2095	*2095			*3695	*3695				
4.5 m	*2045	*2045	*2495	*2495	*4595	*4595				
3.0 m	*2095	*2095	*3795	3545	*5395	4895	*6895	*6895	*10545	*10545
1.5 m	*2195	*2195	*4645	3495	*5795	4745	*7845	7245		
0.0 m	*2445	*2445	*4545	3445	*5895	4645	*8045	7045	*4895	*4895
-1.5 m	*2895	*2895			*5545	4595	*7445	6945	*7595	*7595
-3.0 m	*3645	*3645			*4345	*4345	*6045	*6045	*8045	*8045

* Load is limited by hydraulic capacity rather than tipping.
Rating are based on SAE Standard NO. J1097. Rated loads do not exceed 87% of hydraulic lift capacity or 75% of tipping load.

PW160-8 (One-piece boom)

Conditions:

Bucketless, Tires: 10.00-20

unit: kg

	Max.		7.5 m		6.0 m		4.5 m		3.0 m	
	Cf	Cs	Cf	Cs	Cf	Cs	Cf	Cs	Cf	Cs
Arm length 3000 mm Without stabilizer										
7.5 m	*1945	*1945			*2845	2645				
6.0 m	*1795	*1795	*1945	1845	*3395	2695				
4.5 m	*1695	1595	2545	1845	3595	2645				
3.0 m	*1695	1445	2495	1795	3445	2495	5295	3795		
1.5 m	*1795	1395	2395	1745	3295	3345	4895	3395		
0.0 m	*1945	1395	2345	1695	3145	2245	4645	3195	*4545	*4545
-1.5 m	2145	1495	2295	1645	3095	2145	4545	3095	*6445	5295
-3.0 m	2445	1745			3095	2145	4545	3095	8595	5395
Arm length 3000 mm With front or rear blade										
7.5 m	*1945	*1945			*2845	*2845				
6.0 m	*1795	*1795	*1945	*1945	*3395	3145				
4.5 m	*1695	*1695	*3195	2145	*3745	3045				
3.0 m	*1695	*1695	*3845	2095	*4845	2945	*5945	4395		
1.5 m	*1795	1645	4445	2045	*5545	2745	*7395	3995		
0.0 m	*1945	1695	4345	1995	*5795	2645	*7895	3795	*4545	*4545
-1.5 m	*2195	1795	*4195	1945	*5595	2545	*7595	3695	*6445	*6445
-3.0 m	*2695	2095			*4745	2545	*6495	3695	*9045	6645
Arm length 3000 mm With rear outrigger										
7.5 m	*1945	*1945			*2845	*2845				
6.0 m	*1795	*1795	*1945	*1945	*3395	3295				
4.5 m	*1695	*1695	*3195	2295	*3745	3245				
3.0 m	*1695	*1695	*3845	2245	*4845	3095	*5945	4695		
1.5 m	*1795	1745	4545	2145	*5545	2945	*7395	4295		
0.0 m	*1945	1745	4445	2095	*5795	2795	*7895	4045	*4545	*4545
-1.5 m	*2195	1895	*4195	2045	*5595	2695	*7595	3945	*6445	*6445
-3.0 m	*2695	2195			*4745	2695	*6495	3945	*9045	7295
Arm length 3000 mm With outrigger and blade										
7.5 m	*1945	*1945			*2845	*2845				
6.0 m	*1795	*1795	*1945	*1945	*3395	*3395				
4.5 m	*1695	*1695	*3195	3095	*3745	*3745				
3.0 m	*1695	*1695	*3845	2995	*4845	4195	*5945	*5945		
1.5 m	*1795	*1795	*4545	2945	*5545	3995	*7395	5995		
0.0 m	*1945	*1945	*4545	2845	*5795	3845	*7895	5745	*4545	*4545
-1.5 m	*2195	*2195	*4195	2845	*5595	3795	*7595	5645	*6445	*6445
-3.0 m	*2695	*2695			*4745	3795	*6495	5645	*9045	7295
Arm length 3000 mm With outrigger front and rear										
7.5 m	*1945	*1945			*2845	*2845				
6.0 m	*1795	*1795	*1945	*1945	*3395	*3395				
4.5 m	*1695	*1695	*3195	*3195	*3745	*3745				
3.0 m	*1695	*1695	*3845	3545	*4845	*4845	*5945	*5945		
1.5 m	*1795	*1795	*4545	3445	*5545	4745	*7395	7195		
0.0 m	*1945	*1945	*4545	3345	*5795	4595	*7895	6945	*4545	*4545
-1.5 m	*2195	*2195	*4195	3345	*5595	4495	*7595	6845	*6445	*6445
-3.0 m	*2695	*2695			*4745	4495	*6495	*6495	*9045	*9045

* Load is limited by hydraulic capacity rather than tipping.
Rating are based on SAE Standard NO. J1097. Rated loads do not exceed 87% of hydraulic lift capacity or 75% of tipping load.

PW160-8 (Two-piece boom)

Conditions:
Bucketless, Tires: 10.00-20

unit: kg

	Max.		7.5 m		6.0 m		4.5 m		3.0 m	
	Cf	Cs	Cf	Cs	Cf	Cs	Cf	Cs	Cf	Cs
Arm length 2100 mm Without stabilizer										
7.5 m	*4195	*4195								
6.0 m	*3565	3005								
4.5 m	*3385	2485			4065	2905	6065	4225	*8575	*7415
3.0 m	3145	2255			3965	2815	5785	3965		
1.5 m	3045	2175			3845	2705	5525	3735		
0.0 m	3125	2225			3775	2635	5395	9615		
-1.5 m	3455	2435			3765	2625	5375	3605	*9155	6105
-3.0 m	*4195	*4195								
Arm length 2100 mm With front or rear blade										
7.5 m	*4195	*4195								
6.0 m	*3565	3435					*5955	5015		
4.5 m	*3385	2835			*5955	3325	*6835	4865	*8575	*7415
3.0 m	*3385	2575			*6375	3225	*8065	4605		
1.5 m	*3545	2495			*6795	3115	*9065	4365		
0.0 m	*3905	2555			*6865	3045	*9215	4235		
-1.5 m	*4635	2805			*6285	3035	*8485	4225	*9155	7345
-3.0 m	*4195	*4195								
Arm length 2100 mm With rear outrigger										
7.5 m	*4195	*4195								
6.0 m	*3565	*3565					*5955	*5955		
4.5 m	*3385	*3385			*5955	4735	*6835	*6835	*8575	*8575
3.0 m	*3385	*3385			*6375	4605	*8065	6715		
1.5 m	*3545	3515			*6795	4455	*9065	6375		
0.0 m	*3905	3605			*6865	4365	*9215	6205		
-1.5 m	*4635	3995			*6285	4345	*8485	6185	*9155	*9155
-3.0 m	*4195	*4195								
Arm length 2100 mm With outrigger and blade										
7.5 m	*4195	*4195								
6.0 m	*3565	*3565					*5955	*5955		
4.5 m	*3385	*3385			*5955	4595	*6835	*6835	*8575	*8575
3.0 m	*3385	*3385			*6375	4495	*8065	6635		
1.5 m	*3545	3435			*6795	4375	*9065	6365		
0.0 m	*3905	3905			*6865	4295	*9215	6225		
-1.5 m	*4635	3925			*6285	4285	*8485	6215	*9155	*9155
-3.0 m	*4195	*4195								
Arm length 2100 mm With outrigger front and rear										
7.5 m	*4195	*4195								
6.0 m	*3565	*3565					*5955	*5955		
4.5 m	*3385	*3385			*5955	*5955	*6835	*6835	*8575	*8575
3.0 m	*3385	*3385			*6375	*6375	*8065	6635		
1.5 m	*3545	*3545			*6795	6385	*9065	6365		
0.0 m	*3905	*3905			*6865	6305	*9215	6225		
-1.5 m	*4635	*4635			*6285	*6285	*8485	*8485	*9155	*9155
-3.0 m	*4195	*4195								

* Load is limited by hydraulic capacity rather than tipping.
Rating are based on SAE Standard NO. J1097. Rated loads do not exceed 87% of hydraulic lift capacity or 75% of tipping load.

PW160-8 (Two-piece boom)

Conditions:

Bucketless, Tires: 10.00-20

unit: kg

	Max.		7.5 m		6.0 m		4.5 m		3.0 m	
	Cf	Cs	Cf	Cs	Cf	Cs	Cf	Cs	Cf	Cs
Arm length 2500 mm Without stabilizer										
7.5 m	*3365	*3365					*4435	4335		
6.0 m	*2945	2665			*4065	2895	*4975	4375		
4.5 m	*2815	2235			4025	2855	*5845	4205	*5675	*5675
3.0 m	*2825	2035	2905	2065	3895	2745	5745	3925		
1.5 m	2775	1965	2855	2015	3765	2615	5435	3645		
0.0 m	2845	2005			3665	2525	5255	3485	*4715	*4715
-1.5 m	3105	2165			3635	2495	5215	3445	*8485	5805
-3.0 m							5285	3505		
Arm length 2500 mm With front or rear blade										
7.5 m	*3365	*3365					*4435	*4435		
6.0 m	*2945	*2945			*4065	3315	*4975	*4975		
4.5 m	*2815	2565			*5305	3275	*5845	4855	*5675	*5675
3.0 m	*2825	2345	*3235	2375	*6055	3155	*7565	4565		
1.5 m	*2945	2265	*4035	2325	*6545	3025	*8695	4265		
0.0 m	*3215	2315			*6755	2935	*9085	4105	*4715	*4715
-1.5 m	*3755	2515			*6395	2905	*8605	4065	*8485	7085
-3.0 m							*7115	4125		
Arm length 2500 mm With rear outrigger										
7.5 m	*3365	*3365					*4435	*4435		
6.0 m	*2945	*2945			*4065	*4065	*4975	*4975		
4.5 m	*2815	*2815			*5305	4675	*5845	*5845	*5675	*5675
3.0 m	*2825	*2825	*3235	*3235	*6055	4515	*7565	6655		
1.5 m	*2945	*2945	*4035	3275	*6545	4335	*8695	6255		
0.0 m	*3215	*3215			*6755	4215	*9085	6025	*4715	*4715
-1.5 m	*3755	3565			*6395	4175	*8605	5975	*8485	*8485
-3.0 m							*7115	6055		
Arm length 2500 mm With outrigger and blade										
7.5 m	*3365	*3365					*4435	*4435		
6.0 m	*2945	*2945			*4065	*4065	*4975	*4975		
4.5 m	*2815	*2815			*5305	4555	*5845	*5845	*5675	*5675
3.0 m	*2825	*2825	*3235	*3235	*6055	4425	*7565	6595		
1.5 m	*2945	*2945	*4035	3235	*6545	4285	*8695	6275		
0.0 m	*3215	*3215			*6755	4185	*9085	6095	*4715	*4715
-1.5 m	*3755	*3535			*6395	4155	*8605	6045	*8485	*8485
-3.0 m							*7115	6115		
Arm length 2500 mm With outrigger front and rear										
7.5 m	*3365	*3365					*4435	*4435		
6.0 m	*2945	*2945			*4065	*4065	*4975	*4975		
4.5 m	*2815	*2815			*5305	*5305	*5845	*5845	*5675	*5675
3.0 m	*2825	*2825	*3235	*3235	*6055	*6055	*7565	*7565		
1.5 m	*2945	*2945	*4035	*4035	*6545	6305	*8695	*8695		
0.0 m	*3215	*3215			*6755	6195	*9085	*9085	*4715	*4715
-1.5 m	*3755	*3755			*6395	6155	*8605	*8605	*8485	*8485
-3.0 m							*7115	*7115		

* Load is limited by hydraulic capacity rather than tipping.
Rating are based on SAE Standard NO. J1097. Rated loads do not exceed 87% of hydraulic lift capacity or 75% of tipping load.

PW160-8 (Two-piece boom)

Conditions:

Bucketless, Tires: 10.00-20

unit: kg

	Max.		7.5 m		6.0 m		4.5 m		3.0 m	
	Cf	Cs	Cf	Cs	Cf	Cs	Cf	Cs	Cf	Cs
Arm length 3000 mm Without stabilizer										
7.5 m	*2805	*2805					*4175	*4175		
6.0 m	*2525	2405			*3995	2985	*4105	*4105		
4.5 m	*2415	2075	2985	2145	4095	2925	*4535	*4315		
3.0 m	*2425	1915	2945	2105	3955	2795	5865	4035	*10295	6945
1.5 m	*2505	1845	2885	2045	3805	2655	5525	3725		
0.0 m	2645	1875	2825	1995	3685	2545	5305	3525	*5055	*5055
-1.5 m	2845	2005			3635	2495	5215	3445	*7695	5815
-3.0 m	3325	2315			3655	2515	5245	3475	9745	5905
Arm length 3000 mm With front or rear blade										
7.5 m	*2855	*2855					*4235	*4235		
6.0 m	*2575	*2575			*4055	3485	*4165	*4165		
4.5 m	*2475	2465	*3115	2545	*4605	3435	*4595	*4595		
3.0 m	*2475	2285	*4165	2515	*5815	3315	*7195	4785	*10455	8395
1.5 m	*2565	2225	*4875	2455	*6515	3185	*8545	4495		
0.0 m	*2755	2255	*5025	2405	*6875	3085	*9225	4305	*5105	*5105
-1.5 m	*3125	2415			*6745	3035	*9055	4225	*7745	7295
-3.0 m	*3885	2795			*6775	3045	*7945	4245	*11065	7375
Arm length 3000 mm With rear outrigger										
7.5 m	*2855	*2855					*4235	*4235		
6.0 m	*2575	*2575			*4055	*4055	*4165	*4165		
4.5 m	*2475	*2475	*3115	*3115	*4605	*4605	*4595	*4595		
3.0 m	*2475	*2475	*4165	*3525	*5815	4725	*7195	6955	*10455	*10455
1.5 m	*2565	*2565	*4875	3445	*6515	4555	*8545	6565		
0.0 m	*2755	*2755	*4845	3385	*6875	4405	*9225	6295	*5105	*5105
-1.5 m	*3125	*3125			*6745	4335	*9055	6195	*7745	*7745
-3.0 m	*3885	*3885			*6775	4360	*7945	6215	*11065	*11065
Arm length 3000 mm With outrigger and blade										
7.5 m	*2805	*2805					*4175	*4175		
6.0 m	*2525	*2525			*3995	*3995	*4105	*4105		
4.5 m	*2415	*2415	*3055	*3055	*4545	*4545	*4535	*4535		
3.0 m	*2425	*2425	*4105	3335	*5755	4485	*7065	6725	*10295	*10295
1.5 m	*2505	*2505	*4815	3265	*6375	4335	*8385	6375		
0.0 m	*2695	*2695	*4965	3205	*6725	4215	*9045	6145	*5055	*5055
-1.5 m	*3065	*3065			*6605	4155	*8875	6055	*7695	*7695
-3.0 m	*3825	3785			*5635	4185	*7775	6085	*10845	*10845
Arm length 3000 mm With outrigger front and rear										
7.5 m	*2805	*2805					*4175	*4175		
6.0 m	*2525	*2525			*3995	*3995	*4105	*4105		
4.5 m	*2415	*2415	*3055	*3055	*4545	*4545	*4535	*4535		
3.0 m	*2425	*2425	*4105	*4105	*4645	*4645	*7065	*7065	*10295	*10295
1.5 m	*2505	*2505	*4815	4645	*6375	6355	*8385	*8385		
0.0 m	*2695	*2695	*4965	4585	*6725	6225	*9045	*9045	*5055	*5055
-1.5 m	*3065	*3065			*6605	6155	*8875	*8875	*7695	*7695
-3.0 m	*3825	*3825			*5635	*5635	*7775	*7775	*10845	*10845

* Load is limited by hydraulic capacity rather than tipping.
Rating are based on SAE Standard NO. J1097. Rated loads do not exceed 87% of hydraulic lift capacity or 75% of tipping load.

PW180-7 (One-piece boom)

Conditions:

Bucketless, Undercarriage width: 2.55 m

unit: kg

	Max.		7.5 m		6.0 m		4.5 m		3.0 m	
	Cf	Cs	Cf	Cs	Cf	Cs	Cf	Cs	Cf	Cs
Arm length 2250 mm Without stabilizer										
7.5 m	*3250	*3250								
6.0 m	*3000	2450			4050	3050				
4.5 m	2750	2000	2750	2050	3950	2950	6200	4500		
3.0 m	2500	1800	2700	2000	3750	2750	5700	4100		
1.5 m	2400	1750	2650	1900	3550	2550	5250	3650		
0.0 m	2450	1750	2550	1850	3400	2450	5000	3450	*5150	*5150
-1.5 m	2650	1900			3350	2400	4950	3400	*9150	5900
-3.0 m	3200	2300			3450	2450	5000	3450	*8250	6100
Arm length 2250 mm With front or rear blade										
7.5 m	*3250	*3250								
6.0 m	*3000	2800			*4950	3450				
4.5 m	*2950	2300	*3150	2350	*6000	3350	*7200	5150		
3.0 m	*3000	2100	4800	2300	*6500	3150	*8400	4600		
1.5 m	*3250	2000	4700	2200	6650	3000	*9150	4200		
0.0 m	*3600	2050	4650	2150	6450	2850	*9200	3850	*5150	*5150
-1.5 m	*4350	2200			*6300	2800	*8250	3800	*9150	7100
-3.0 m	*4150	2650			*4750	2850	*6550	4050	*8250	7300
Arm length 2250 mm With rear outrigger										
7.5 m	*3250	*3250								
6.0 m	*3000	*3000			*4950	3950				
4.5 m	*2950	2650	*3150	2700	*6000	3850	*7250	5950		
3.0 m	*3000	2400	4950	2650	*6500	3650	*8400	5450		
1.5 m	*3250	2300	4850	2550	6900	3450	*9250	4900		
0.0 m	*3600	2350	4800	2500	6700	3300	*9150	4650	*5150	*5150
-1.5 m	*4350	2550			*6300	3250	*8250	4500	*9150	8700
-3.0 m	*4150	3100			*4750	3300	*6550	4600	*8250	*8250
Arm length 2250 mm With outrigger and blade										
7.5 m	*3250	*3250								
6.0 m	*3000	*3000			*4950	4950				
4.5 m	*2950	*2950	*3150	*3150	*6000	4850	*7250	*7250		
3.0 m	*3000	*3000	*5050	3350	*6450	4650	*8400	7050		
1.5 m	*3250	2950	5300	3250	*6900	4400	*9350	6600		
0.0 m	*3600	3050	5250	3200	*6850	4050	*9150	5900	*5150	*5150
-1.5 m	*4350	3300			*6300	4150	*8350	5900	*9150	*9150
-3.0 m	*4150	4000			*4750	4300	*6550	6350	*8250	*8250
Arm length 2250 mm With outrigger front and rear										
7.5 m	*3250	*3250								
6.0 m	*3000	*3000			*4950	*4950				
4.5 m	*2950	*2950	*3150	*3150	*6000	5800	*7250	*7250		
3.0 m	*3000	*3000	*5050	4000	*6450	5600	*8400	*8500		
1.5 m	*3250	*3250	*5500	3950	*6900	5400	*9350	8250		
0.0 m	*3600	*3600	*5250	3850	*6850	5000	*9150	7450	*5150	*5150
-1.5 m	*4350	4000			*6300	5100	*8350	7450	*9150	*9150
-3.0 m	*4150	*4150			*4750	*4750	*6550	*6550	*8250	*8250

* Load is limited by hydraulic capacity rather than tipping.
Rating are based on SAE Standard NO. J1097. Rated loads do not exceed 87% of hydraulic lift capacity or 75% of tipping load.

PW180-7 (One-piece boom)

Conditions:

Bucketless, Undercarriage width: 2.55 m

unit: kg

	Max.		7.5 m		6.0 m		4.5 m		3.0 m		1.5 m	
	Cf	Cs	Cf	Cs	Cf	Cs	Cf	Cs	Cf	Cs	Cf	Cs
Arm length 2600 mm Without stabilizer												
7.5 m	*2750	*2750										
6.0 m	*2550	2300			4100	3100						
4.5 m	*2550	1900	2800	2100	4000	3000	*6050	4600				
3.0 m	2350	1750	2750	2000	3800	2800	5800	4150	11000	7250		
1.5 m	2500	1800	2550	1800	3350	2350	4900	3350	*8900	5850		
0.0 m	2300	1650	2550	1850	3450	2450	5000	3450	*5850	5850		
-1.5 m	2500	1800	2550	1800	3350	2350	4900	3350	*8900	5850	*5700	*5700
-3.0 m	2950	2100			3400	2400	4950	3400	*9300	6050		
-4.5 m	*3250	3000					*4150	3550				
Arm length 2600 mm With front or rear blade												
7.5 m	*2750	*2750										
6.0 m	*2550	*2550			*4500	3500						
4.5 m	*2550	2200	*3700	2400	*5550	3400	*6000	5250				
3.0 m	*2600	2000	4850	2300	*6350	3200	*8050	4700	*12650	8550		
1.5 m	*2800	1900	4750	2200	6700	3000	*9050	4250				
0.0 m	*3150	1950	4650	2150	6500	2850	*9250	3850	*5850	*5850		
-1.5 m	*3750	2100	4600	2100	6400	2750	*8550	3850	*8900	7050	*5700	*5700
-3.0 m	*4250	2850			*5250	3250	*7100	4750	*9300	7250		
-4.5 m	*3250	*3250					*4150	*4150				
Arm length 2600 mm With rear outrigger												
7.5 m	*2750	*2750										
6.0 m	*2550	*2550			*4500	4000						
4.5 m	*2550	2550	*3700	2750	*5550	3900	*6000	6050				
3.0 m	*2600	2300	*5000	2650	*6350	3700	*8050	5450	*12650	10250		
1.5 m	*2800	2200	4850	2550	*6800	3500	*9050	5000				
0.0 m	*3150	2250	4800	2500	6700	3300	*9250	4600	*5850	*5850		
-1.5 m	*3750	2400	*4600	2450	*6450	3250	*8550	4500	*8900	8650	*5700	*5700
-3.0 m	*4250	2850			*5250	3250	*7100	4750	*9300	8850		
-4.5 m	*3250	*3250					*4150	*4150				
Arm length 2600 mm With outrigger and blade												
7.5 m	*2750	*2750										
6.0 m	*2550	*2550			*4500	*4500						
4.5 m	*2550	*2550	*3700	3450	*5550	4900	*6050	*6050				
3.0 m	*2600	*2600	*5000	3350	*6300	4700	*8050	7200	*12650	*12650		
1.5 m	*2800	*2800	5350	3250	*6800	4450	*9200	6650				
0.0 m	*3150	2850	5250	3200	*6900	4200	*9150	5950	*5850	*5850		
-1.5 m	*3750	3100	*4600	3150	*6450	4150	*8550	5900	*8900	*8900	*5700	*5700
-3.0 m	*4250	3650			*5250	4250	*7100	6300	*9300	*9300		
-4.5 m	*3250	*3250					*4150	*4150				
Arm length 2600 mm With outrigger front and rear												
7.5 m	*2750	*2750										
6.0 m	*2550	*2550			*4500	*4500						
4.5 m	*2550	*2550	*3700	*3700	*5550	*5550	*6050	*6050				
3.0 m	*2600	*2600	*5000	4050	*6300	5650	*8050	*8050	*12650	*12650		
1.5 m	*2800	*2800	*5450	3950	*6800	5400	*9200	8300				
0.0 m	*3150	*3150	*5350	3850	*6900	5000	*9150	7450	*5850	*5850		
-1.5 m	*3750	3750	*4600	3850	*6450	5100	*8550	7400	*8900	*8900	*5700	*5700
-3.0 m	*4250	*4250			*5250	5200	*7100	*7100	*9300	*9300		
-4.5 m	*3250	*3250					*4150	*4150				

* Load is limited by hydraulic capacity rather than tipping.
Rating are based on SAE Standard NO. J1097. Rated loads do not exceed 87% of hydraulic lift capacity or 75% of tipping load.

PW180-7 (One-piece boom)

Conditions:

Bucketless, Undercarriage width: 2.55 m

unit: kg

	Max.		7.5 m		6.0 m		4.5 m		3.0 m		1.5 m	
	Cf	Cs	Cf	Cs	Cf	Cs	Cf	Cs	Cf	Cs	Cf	Cs
Arm length 2900 mm Without stabilizer												
7.5 m	*2450	*2450			*3100	3050						
6.0 m	*2300	2100			4150	3100						
4.5 m	*2250	1800	2800	2050	4000	3000						
3.0 m	2200	1600	2700	2000	3800	2800	5850	4200	11250	7500		
1.5 m	2150	1550	2600	1900	3550	2550	5350	3750				
0.0 m	2150	1550	2500	1800	3400	2400	5000	3400	*6050	5800		
-1.5 m	2300	1650	2450	1750	3300	2300	4850	3300	*8550	5750	*5350	*5350
-3.0 m	2700	1900			3300	2300	4850	3300	9350	5900	*8200	*8200
-4.5 m	*3400	2600					*4850	3500	*6200	6200		
Arm length 2900 mm With front or rear blade												
7.5 m	*2450	*2450			*3100	*3100						
6.0 m	*2300	*2300			*4200	3500						
4.5 m	*2250	2050	*3800	2400	*5000	3400						
3.0 m	*2350	1850	4850	2300	*6100	3200	*7700	4750	*11800	8800		
1.5 m	*2500	1800	4700	2200	*6650	3000	*8750	4250				
0.0 m	*2750	1800	4600	2100	6450	2800	*9200	3850	*6100	*6100		
-1.5 m	*3250	1950	4550	2050	6350	2700	*8700	3750	*8550	6950	*5350	*5350
-3.0 m	*4150	2250			*5500	2700	*7400	3950	*10000	7100	*8200	*8200
-4.5 m	*3400	3050					*4850	4100	*6250	*6250		
Arm length 2900 mm With rear outrigger												
7.5 m	*2450	*2450			*3100	*3100						
6.0 m	*2300	*2300			*4200	4000						
4.5 m	*2250	*2250	*3800	2750	*5000	3900						
3.0 m	*2350	2150	*4850	2650	*6050	3700	*7750	5500	*11800	10500		
1.5 m	*2500	2100	4850	2550	*6650	3450	*8800	5000				
0.0 m	*2750	2100	4750	2450	6700	3250	*9200	4550	*6100	*6100		
-1.5 m	*3250	2250	4700	2400	*6550	3200	*8700	4450	*8550	8500	*5350	*5350
-3.0 m	*4150	2600			*5500	3200	*7400	4650	*10000	8650	*8200	*8200
-4.5 m	*3400	*3400					*4850	*4850	*6250	*6250		
Arm length 2900 mm With outrigger and blade												
7.5 m	*2450	*2450			*3100	*3100						
6.0 m	*2300	*2300			*4200	*4200						
4.5 m	*2250	*2250	*3800	3450	*5000	4900						
3.0 m	*2350	*2350	4850	3350	*6050	4700	*7750	7250	*11800	*11800		
1.5 m	*2500	*2500	5300	3250	*6650	4450	*8950	6700				
0.0 m	*2750	2700	5200	3150	*6850	4050	*9100	5900	*6100	*6100		
-1.5 m	*3250	2900	*4900	3100	*6550	4100	*8800	5850	*8550	*8550	*5350	*5350
-3.0 m	*4150	3400			*5500	4150	*7400	6200	*10000	*10000	*8200	*8200
-4.5 m	*3400	*3400					*4850	*4850	*6250	*6250		
Arm length 2900 mm With outrigger front and rear												
7.5 m	*2450	*2450			*3100	*3100						
6.0 m	*2300	*2300			*4200	*4200						
4.5 m	*2250	*2250	*3800	*3800	*5000	*5000						
3.0 m	*2350	*2350	4850	4050	*6050	5650	*7750	*7800	*11800	*11800		
1.5 m	*2500	*2500	*5350	3900	*6650	5400	*8950	8350				
0.0 m	*2750	*2750	*5350	3800	*6850	4950	*9150	7450	*6100	*6100		
-1.5 m	*3250	*3250	*4900	3750	*6550	5050	*8800	7350	*8550	*8550	*5350	*5350
-3.0 m	*4150	4100			*5500	5100	*7400	*7400	*10000	*10000	*8200	*8200
-4.5 m	*3400	*3400					*4850	*4850	*6250	*6250		

* Load is limited by hydraulic capacity rather than tipping.
Rating are based on SAE Standard NO. J1097. Rated loads do not exceed 87% of hydraulic lift capacity or 75% of tipping load.

PW180-7 (Two-piece boom)

Conditions:

Bucketless, Undercarriage width: 2.75 m

unit: kg

	Max.		7.5 m		6.0 m		4.5 m		3.0 m	
	Cf	Cs	Cf	Cs	Cf	Cs	Cf	Cs	Cf	Cs
Arm length 2250 mm Without stabilizer										
7.5 m	*3500	*3500					*5350	5300		
6.0 m	*3100	2650			4050	3350	*5350	5300		
4.5 m	2700	2200	2750	2300	3950	3250	6200	5050		
3.0 m	2450	2000	2750	2250	3800	3100	5750	4600		
1.5 m	2400	1950	2650	2150	3600	2900	5300	4200		
0.0 m	2450	2000	2600	2100	3450	2800	5050	3950		
-1.5 m	2700	2200			3400	2750	5000	3950	*8250	7050
-3.0 m										
Arm length 2250 mm With front or rear blade										
7.5 m	*3500	*3500					*5350	*5350		
6.0 m	*3100	3000			*5200	3800	*5350	*5350		
4.5 m	*3000	2550	*3650	2600	*5900	3700	*6450	5700		
3.0 m	*3000	2300	4900	2550	*6250	3550	*8050	5250		
1.5 m	*3150	2250	4800	2500	6700	3350	*9050	4850		
0.0 m	*3400	2300	4200	2450	6600	3200	9100	4600		
-1.5 m	*3950	2500			*6400	3150	*8550	4600	*8250	*8250
-3.0 m										
Arm length 2250 mm With rear outrigger										
7.5 m	*3500	*3500					*5350	*5350		
6.0 m	*3100	*3100			*5200	4300	*5350	*5350		
4.5 m	*3000	2900	*3650	2950	*5900	4250	*6450	*6450		
3.0 m	*3000	2650	*5350	2950	*6250	4050	*8050	6100		
1.5 m	*3150	2550	5300	2850	*6750	3850	*9050	5650		
0.0 m	*3400	2650	4600	2800	*6900	3700	*9050	5450		
-1.5 m	*3950	2900			*6400	3700	*8550	5400	*8250	*8250
-3.0 m										
Arm length 2250 mm With outrigger and blade										
7.5 m	*3500	*3500					*5350	*5350		
6.0 m	*3100	*3100			*5200	*5200	*5350	*5350		
4.5 m	*3000	*3000	*3650	*3650	*5900	5250	*6450	*6450		
3.0 m	*3000	*3000	5200	3650	*6350	5050	*8200	6100		
1.5 m	*3150	2550	5300	2850	*6750	3850	*9050	5650		
0.0 m	*3400	2650	4600	2800	*6900	3700	*9050	5450		
-1.5 m	*3950	2900			*6400	3700	*8550	5400	*8250	*8250
-3.0 m	*4150	4000			*4750	4300	*6550	6350	*8250	*8250
Arm length 2250 mm With outrigger front and rear										
7.5 m	*3250	*3250								
6.0 m	*3000	*3000			*4950	*4950				
4.5 m	*2950	*2950	*3150	*3150	*6000	5800	*7250	*7250		
3.0 m	*3000	*3000	*5050	4000	*6450	5600	*8400	*8500		
1.5 m	*3250	*3250	*5500	3950	*6900	5400	*9350	8250		
0.0 m	*3600	*3600	*5250	3850	*6850	5000	*9150	7450	*5150	*5150
-1.5 m	*4350	4000			*6300	5100	*8350	7450	*9150	*9150
-3.0 m	*4150	*4150			*4750	*4750	*6550	*6550	*8250	*8250

* Load is limited by hydraulic capacity rather than tipping.
Rating are based on SAE Standard NO. J1097. Rated loads do not exceed 87% of hydraulic lift capacity or 75% of tipping load.

PW180-7 (Two-piece boom)

Conditions:

Bucketless, Undercarriage width: 2.75 m

unit: kg

	Max.		7.5 m		6.0 m		4.5 m		3.0 m	
	Cf	Cs	Cf	Cs	Cf	Cs	Cf	Cs	Cf	Cs
Arm length 2600 mm Without stabilizer										
7.5 m	*2950	*2950			*3100	*3100				
6.0 m	*2650	2450			4100	3400				
4.5 m	2550	2100	2800	2300	4000	3300	*5450	5150		
3.0 m	2350	1900	2750	2250	3850	3150	5850	4700		
1.5 m	2250	1850	2650	2150	3600	2950	5350	4250		
0.0 m	2300	1900	2600	2100	3450	2800	5100	4000		
-1.5 m	2500	2050	2600	2100	3400	3750	5000	3900	*8100	7000
-3.0 m					3450	2750	5050	4000		
Arm length 2600 mm With front or rear blade										
7.5 m	*2950	*2950			*3100	*3100				
6.0 m	*2650	*2650			*4650	3850				
4.5 m	*2600	2400	*4050	2650	*5350	3750	*5450	*5450		
3.0 m	*2600	2200	4900	2550	*6100	3550	*7700	5350		
1.5 m	*2750	2100	4800	2500	*6650	3350	*8900	4900		
0.0 m	*3000	2150	4150	2400	6600	3200	*9150	3650		
-1.5 m	*3450	2350	4700	2400	6500	3150	*8800	4550	*8100	*8100
-3.0 m					*5350	3200	*7300	4650		
Arm length 2600 mm With rear outrigger										
7.5 m	*2950	*2950			*3100	*3100				
6.0 m	*2650	*2650			*4650	4350				
4.5 m	*2600	*2600	*4050	3000	*5350	4250	*5450	*5450		
3.0 m	*2600	2500	*5150	2950	*6100	4100	*7700	6200		
1.5 m	*2750	2450	5300	2850	*6650	3900	*8900	5750		
0.0 m	*3000	2500	4600	2800	*6900	3700	*9150	5450		
-1.5 m	*3450	2700	*4800	2750	*6350	3650	*8800	5350	*8100	*8100
-3.0 m					*5350	3700	*7300	5450		
Arm length 2600 mm With outrigger and blade										
7.5 m	*2950	*2950			*3100	*3100				
6.0 m	*2650	*2650			*4650	*4650				
4.5 m	*2600	*2600	*4050	3700	*5350	5300	*5450	*5450		
3.0 m	*2600	*2600	*5150	3650	*6150	5100	*7900	7850		
1.5 m	*2750	*2750	5150	3550	*6700	4850	*9050	7350		
0.0 m	*3000	*3000	5050	3450	*6900	4500	*9200	6550		
-1.5 m	*3450	3350	*4800	3500	*6550	4650	*8800	6500	*8100	*8100
-3.0 m					*5350	4700	*7300	7050		
Arm length 2600 mm With outrigger front and rear										
7.5 m	*2950	*2950			*3100	*3100				
6.0 m	*2650	*2650			*4650	*4650				
4.5 m	*2600	*2600	*4050	*4050	*5350	*5350	*5450	*5450		
3.0 m	*2600	*2600	*5150	4350	*6150	6100	*7900	*7950		
1.5 m	*2750	*2750	*5400	4250	*6700	5900	*9050	*9050		
0.0 m	*3000	*3000	*5350	4100	*6900	5450	*9200	9150		
-1.5 m	*3450	*3450	*4800	4200	*6550	5650	*8800	9130	*8100	*8100
-3.0 m					*5350	*5350	*7300	*7300		

* Load is limited by hydraulic capacity rather than tipping.
Rating are based on SAE Standard NO. J1097. Rated loads do not exceed 87% of hydraulic lift capacity or 75% of tipping load.

PW180-7 (Two-piece boom)

Conditions:

Bucketless, Undercarriage width: 2.75 m

unit: kg

	Max.		7.5 m		6.0 m		4.5 m		3.0 m	
	Cf	Cs	Cf	Cs	Cf	Cs	Cf	Cs	Cf	Cs
Arm length 2900 mm Without stabilizer										
7.5 m	*2600	*2600			*3600	3350				
6.0 m	*2650	2300	*2550	2300	4150	3400				
4.5 m	*2300	1950	2800	2300	4050	3300	*4650	*4650		
3.0 m	2200	1800	2750	2250	3850	3150	5900	4750		
1.5 m	2100	1700	2650	2150	3600	2900	5400	4250		
0.0 m	2150	1750	2550	2050	3450	2750	5050	3950	*5150	*5150
-1.5 m	2350	1900	2500	2000	3350	2650	4950	3850	*7750	6850
-3.0 m					3350	2700	4950	3900		
Arm length 2900 mm With front or rear blade										
7.5 m	*2600	*2600			*3600	*3600				
6.0 m	*2350	*2350	*2550	*2550	*4250	3850				
4.5 m	*2300	2250	*4050	2650	*4800	3750	*4650	*4650		
3.0 m	*2300	2050	4900	2550	*5900	3550	*7400	5400		
1.5 m	*2400	2000	4750	2450	*6500	3350	*8650	5750		
0.0 m	*2650	2350	4550	2750	*6800	3700	*9050	5400	*5150	*5150
-1.5 m	*3000	2500	*4950	2700	*6600	3600	*8900	5300	*7750	*7750
-3.0 m					*5600	3600	*7600	4550		
Arm length 2900 mm With rear outrigger										
7.5 m	*2600	*2600			*3600	*3600				
6.0 m	*2350	*2350	*2550	*2550	*4250	*4250				
4.5 m	*2300	*2300	*4050	3000	*4800	4300	*4650	*4650		
3.0 m	*2300	*2300	*4900	2950	*5900	4100	*7400	6250		
1.5 m	*2400	2300	5250	2800	*6550	3850	*8650	4950		
0.0 m	*2650	2000	4150	2350	6550	3150	*9000	4600	*5150	*5150
-1.5 m	*3000	2150	4650	2350	6450	3100	*8900	4500	*7750	*7750
-3.0 m					*5600	3100	*7600	5350		
Arm length 2900 mm With outrigger and blade										
7.5 m	*2600	*2600			*3600	*3600				
6.0 m	*2350	*2350	*2550	*2550	*4250	*4250				
4.5 m	*2300	*2300	*4050	3700	*4800	*4800	*4650	*4650		
3.0 m	*2300	*2300	*4900	3650	*6000	5100	*7550	7600		
1.5 m	*2400	*2400	5100	3550	*6550	4850	*8800	7350		
0.0 m	*2650	*2650	5000	3400	*6800	4450	*9100	6450	*5150	*5150
-1.5 m	*3000	*3000	*4950	3400	*6600	4600	*8900	6450	*7750	*7750
-3.0 m					*5600	4600	*7600	6950		
Arm length 2900 mm With outrigger front and rear										
7.5 m	*2600	*2600			*3600	*3600				
6.0 m	*2350	*2350	*2550	*2550	*4250	*4250				
4.5 m	*2300	*2300	*4050	*4050	*4800	*4800	*4650	*4650		
3.0 m	*2300	*2300	*4900	4350	*6000	*6000	*7550	*7600		
1.5 m	*2400	*2400	*5300	4250	*6550	5850	*8800	*8800		
0.0 m	*2650	*2650	*5350	4100	*6800	5450	*9100	8100	*5150	*5150
-1.5 m	*3000	*3000	*4950	4100	*6600	5600	*8900	8100	*7750	*7750
-3.0 m					*5600	*5600	*7600	*7600		

* Load is limited by hydraulic capacity rather than tipping.
Rating are based on SAE Standard NO. J1097. Rated loads do not exceed 87% of hydraulic lift capacity or 75% of tipping load.

PW200-7 (One-piece boom)

Conditions:

Bucketless, Undercarriage width: 2.75 m

unit: kg

	Max.		7.5 m		6.0 m		4.5 m		3.0 m	
	Cf	Cs	Cf	Cs	Cf	Cs	Cf	Cs	Cf	Cs
Arm length 2400 mm Without stabilizer										
7.5 m	*5160	4260								
6.0 m	4260	3150			5710	4210				
4.5 m	3610	2660	3910	2860	5560	4110	*7610	6310		
3.0 m	3310	2410	3810	2760	5260	3860	8110	5710		
1.5 m	3210	2310	3660	2660	5010	3560	7460	5110		
0.0 m	3260	2310	3560	2560	4760	3360	7060	4760		
-1.5 m	3510	2510	3510	2510	4660	3260	6960	4660	*11710	8210
-3.0 m	4160	2960			4710	3310	7010	4710	*13910	8460
Arm length 2400 mm With rear blade										
7.5 m	*5160	4760								
6.0 m	*4860	5560			*6110	4760				
4.5 m	*4810	3010	*6110	3210	*6610	4610	*7610	7110		
3.0 m	*4960	2710	6110	3160	*7460	4360	*9510	6510		
1.5 m	5110	2610	5960	3010	*8310	4060	*11260	5910		
0.0 m	5260	2660	5810	2910	8110	3860	*12060	5510		
-1.5 m	5710	2860	5760	2910	8010	3760	*11860	5410	*11710	9810
-3.0 m	*6760	3410			*7860	3810	*10660	5510	*14810	10060
Arm length 2400 mm With rear outrigger										
7.5 m	*5160	*5160								
6.0 m	*4860	3960			*6110	5260				
4.5 m	*4810	3360	*6110	3610	*6610	5110	*7610	*7610		
3.0 m	*4960	3060	*6460	3510	*7460	4860	*9510	7310		
1.5 m	*5310	2910	6560	3360	*8310	4560	*11260	6660		
0.0 m	5760	2960	6460	3260	*8810	4360	*12060	6310		
-1.5 m	6360	3210	6410	3210	*8760	4210	*11860	6160	*11710	*11510
-3.0 m	*6760	3810			*7860	4310	*10660	6260	*14810	11810
Arm length 2400 mm With outrigger and blade										
7.5 m	*5260	*5260								
6.0 m	*4910	4910			*6210	*6210				
4.5 m	*4860	4160	*6210	4460	*6710	6360	*7660	*7660		
3.0 m	*5010	3810	*6560	4360	*7610	6110	*9660	9410		
1.5 m	*5360	3710	6510	4260	*8460	5810	*11410	8710		
0.0 m	5710	3760	6360	4160	8910	5560	*12210	8310		
-1.5 m	6260	4060	6310	4110	8760	5410	*12010	8160	*11910	*11910
-3.0 m	*6860	4860			*8010	5510	*10810	8260	*15010	*15010
Arm length 2400 mm With outrigger front and rear										
7.5 m	*5260	*5260								
6.0 m	*4910	*4910			*6210	*6210				
4.5 m	*4860	4860	*6210	5210	*6710	*6710	*7660	*7660		
3.0 m	*5010	4460	*6560	5110	*7610	7160	*9660	*9660		
1.5 m	*5360	4310	6660	4960	*8460	6860	*11410	10560		
0.0 m	5910	4410	6560	4860	*8960	6610	*12210	10160		
-1.5 m	6460	4810	6510	4810	*8910	6460	*12010	10010	*11910	*11910
-3.0 m	*6860	5710			*8010	6560	*10810	*10060	*15010	*15010

* Load is limited by hydraulic capacity rather than tipping.
Rating are based on SAE Standard NO. J1097. Rated loads do not exceed 87% of hydraulic lift capacity or 75% of tipping load.

PW200-7 (Two-piece boom)

Conditions:

Bucketless, Undercarriage width: 2.55 m

unit: kg

	Max.		7.5 m		6.0 m		4.5 m		3.0 m	
	Cf	Cs	Cf	Cs	Cf	Cs	Cf	Cs	Cf	Cs
Arm length 2400 mm Without stabilizer										
7.5 m	*5160	3810								
6.0 m	4210	2810			5610	3810				
4.5 m	3560	2360	3810	2560	5460	3660	*7810	5660		
3.0 m	3210	2160	3710	2460	5160	3410	7960	5060		
1.5 m	3110	2060	3560	2360	4860	3160	7260	4510		
0.0 m	3160	2060	3460	2260	4660	2960	6860	4160		
-1.5 m	3410	2210	3460	2210	4510	2860	6760	4060	*11710	6960
-3.0 m	4060	2610			4610	2910	6810	4110	13560	7210
Arm length 2400 mm With rear blade										
7.5 m	*5160	4260								
6.0 m	*4860	3210			*6110	4260				
4.5 m	*4810	2710	6060	2910	*6610	4110	*7610	6360		
3.0 m	*4960	2410	5960	2810	*7460	3860	*9510	5760		
1.5 m	5010	2310	5810	2710	8210	3610	*11260	5100		
0.0 m	5110	2360	5680	2610	7910	3410	*12060	4810		
-1.5 m	5610	2560	5660	2560	7760	3310	*11860	4710	*11710	8310
-3.0 m	*6760	3010			*7860	3360	*10660	4760	*14810	8560
Arm length 2400 mm With rear outrigger										
7.5 m	*5160	4810								
6.0 m	*4860	3610			*6110	4810				
4.5 m	*4810	3060	*6110	3260	*6610	4660	*7610	7210		
3.0 m	*4960	2760	*6460	3210	*7460	4410	*9510	6610		
1.5 m	*5310	2660	6410	3060	*8310	4110	*11260	6010		
0.0 m	*5660	2710	6310	2960	*8810	3910	*12060	5610		
-1.5 m	6210	2910	6260	2910	8760	3810	*11860	5510	*11710	10060
-3.0 m	*6760	3460			*7860	3860	*10660	5610	*14810	10310
Arm length 2400 mm With outrigger and blade										
7.5 m	*5260	*5260								
6.0 m	*4910	4560			*6210	6060				
4.5 m	*4860	3860	*6210	4160	*6710	5910	*7760	*7760		
3.0 m	*5010	3560	6510	4060	*7610	5660	*9660	8660		
1.5 m	*5360	3410	6360	3910	*8460	5360	*11410	7960		
0.0 m	5610	3460	6260	3810	8760	5110	*12210	7610		
-1.5 m	6160	3760	6210	3810	8610	5010	*12010	7460	*11910	*11910
-3.0 m	*6860	4460			*8010	5060	*10810	7560	*15010	*15010
Arm length 2400 mm With outrigger front and rear										
7.5 m	*5260	*5260								
6.0 m	*4910	*4910			*6210	*6210				
4.5 m	*4860	4610	*6210	4960	*6710	*6710	*7760	*7760		
3.0 m	*5010	4210	*6560	4860	*7610	6760	*9660	*9660		
1.5 m	*5360	4060	6510	4710	*8460	6460	*11410	9910		
0.0 m	5760	4160	6410	4610	*8960	6210	*12210	9510		
-1.5 m	6310	4510	6360	4560	8810	6110	*12010	9360	*11910	*11910
-3.0 m	*6860	5410			*8010	6160	*10810	9460	*15010	*15010

* Load is limited by hydraulic capacity rather than tipping.
Rating are based on SAE Standard NO. J1097. Rated loads do not exceed 87% of hydraulic lift capacity or 75% of tipping load.

PW200-7 (One-piece boom)

Conditions:

Bucketless, Undercarriage width: 2.75 m

unit: kg

	Max.		7.5 m		6.0 m		4.5 m		3.0 m	
	Cf	Cs	Cf	Cs	Cf	Cs	Cf	Cs	Cf	Cs
Arm length 2900 mm Without stabilizer										
7.5 m	*3560	*3560			*4910	4260				
6.0 m	*3360	2810	*3960	2910	*5560	4310				
4.5 m	3310	2410	3960	2910	5660	4160	*6810	6460		
3.0 m	3010	2210	3810	2810	5360	3910	8310	5910	*13160	10610
1.5 m	2910	2110	3660	2660	5060	3610	7610	5260	*7110	*7110
0.0 m	2960	2110	3560	2510	4810	3360	7110	4810	*7710	*7710
-1.5 m	3160	2260	3460	2460	4610	3210	6910	4610	*10960	8110
-3.0 m	3660	2610			4610	3210	6910	4610	13710	8310
Arm length 2900 mm With rear blade										
7.5 m	*3560	*3560			*4910	4810				
6.0 m	*3360	3160	*3960	3310	*5560	4810				
4.5 m	*3310	2710	*5710	3260	*6110	4660	*6810	*6810		
3.0 m	*3410	2510	*6110	3160	*7010	4410	*8710	6710	*13160	12360
1.5 m	*3660	2410	5960	3010	*7960	4110	*10660	6010	*7110	*7110
0.0 m	*4010	2410	5810	2910	*8160	3860	*11810	5560	*7710	*7710
-1.5 m	*4710	2560	5710	2810	*7960	3710	*11960	5360	*10960	9710
-3.0 m	*6010	2960			*7960	3710	*11160	5410	*16010	9910
Arm length 2900 mm With rear outrigger										
7.5 m	*3560	*3560			*4910	*4910				
6.0 m	*3360	*3360	*3960	3660	*5560	5310				
4.5 m	*3310	3060	*5710	3660	*6110	5160	*6810	*6810		
3.0 m	*3410	2810	*6110	3510	*7010	4910	*8710	7510	*13160	*13160
1.5 m	*3660	2710	*6610	3360	*7960	4610	*10660	6810	*7110	*7110
0.0 m	*4010	2710	6410	3260	*8660	4360	*11810	6360	*7710	*7710
-1.5 m	*4710	2910	6360	3160	*8760	4160	*11960	6160	*10960	*10960
-3.0 m	*6010	3360			*8260	4210	*11160	6160	*16010	11610
Arm length 2900 mm With outrigger and blade										
7.5 m	*3610	*3610			*5010	*5010				
6.0 m	*3410	*3410	*4010	*4010	*5610	*5610				
4.5 m	*3360	*3360	*5760	4510	*6210	*6210	*6910	*6910		
3.0 m	*3460	*3460	*6210	4410	*7110	6160	*8860	8860	*13310	*13310
1.5 m	*3710	3410	6510	4260	*8060	5860	*10810	8860	*7210	*7210
0.0 m	*4110	3410	6360	4110	*8760	5560	*12010	8360	*7810	*7810
-1.5 m	*4760	3660	6260	4060	8710	5410	*12160	8160	*11110	*11110
-3.0 m	*6110	4260			*8410	5410	*11310	8160	*16210	*16210
Arm length 2900 mm With outrigger front and rear										
7.5 m	*3610	*3610			*5010	*5010				
6.0 m	*3410	*3410	*4010	*4010	*5610	*5610				
4.5 m	*3360	*3360	*5760	5260	*6210	*6210	*6910	*6910		
3.0 m	*3460	*3460	*6210	5160	*7110	*7110	*8860	*8860	*13310	*13310
1.5 m	*3710	*3710	6660	5010	*8060	6910	*10810	10760	*7210	*7210
0.0 m	*4110	4010	6510	4860	*8760	6610	*12010	10210	*7810	*7810
-1.5 m	*4760	4310	6460	4760	*8910	6460	*12160	9960	*11110	*11110
-3.0 m	*6110	5010			*8410	6460	*11310	9310	*16210	*16210

* Load is limited by hydraulic capacity rather than tipping. Rating are based on SAE Standard NO. J1097. Rated loads do not exceed 87% of hydraulic lift capacity or 75% of tipping load.

PW200-7 (Two-piece boom)

Conditions:

Bucketless, Undercarriage width: 2.55 m

unit: kg

	Max.		7.5 m		6.0 m		4.5 m		3.0 m	
	Cf	Cs	Cf	Cs	Cf	Cs	Cf	Cs	Cf	Cs
Arm length 2900 mm Without stabilizer										
7.5 m	*3560	*3560			*4910	3860				
6.0 m	*3360	2510	3860	2610	*5560	3860				
4.5 m	3210	2160	3860	2610	5510	3760	*6810	5810		
3.0 m	2960	1960	3760	2510	5260	3510	8160	5210	*13160	9260
1.5 m	2860	1860	3610	2360	4910	3210	7410	4610	*7110	*7110
0.0 m	2860	1860	3460	2210	4660	2960	6910	4160	*7710	6960
-1.5 m	3060	1960	3360	2160	4510	2810	2710	4010	*10960	6960
-3.0 m	3560	2260			4510	2810	6710	4010	13310	7010
Arm length 2900 mm With rear blade										
7.5 m	*3560	*3560			*4910	4310				
6.0 m	*3360	2860	*3960	2960	*5560	4360				
4.5 m	*3310	2460	*5710	2960	*6110	4210	*6810	6510		
3.0 m	*3410	2210	6010	2810	*7010	3960	*8710	5960	*13160	10710
1.5 m	*3660	2110	5810	2710	*7960	3660	*10660	5310	*7110	*7110
0.0 m	*4010	2160	5660	2560	7960	3410	*11810	4860	*7710	*7710
-1.5 m	*4710	2260	5560	2510	7760	3260	*11960	4660	*10960	8210
-3.0 m	5910	2610			7760	3260	*11160	4710	*16010	8410
Arm length 2900 mm With rear outrigger										
7.5 m	*3560	*3560			*4910	4860				
6.0 m	*3360	3210	*3960	3360	*5560	4910				
4.5 m	*3310	2760	*5710	3310	*6110	4760	*6810	*6810		
3.0 m	*3410	2510	*6110	3210	*7010	4460	*8710	6810	*13160	12660
1.5 m	*3660	2460	6410	3060	*7960	4160	*10660	6110	*7110	*7110
0.0 m	*4010	2460	6260	2960	*8660	3910	*11810	5660	*7710	*7710
-1.5 m	*4710	2610	6210	2860	*8710	3760	*11960	5460	*10960	9960
-3.0 m	*6010	3010			*8260	3760	*11160	5510	*16010	10110
Arm length 2900 mm With outrigger and blade										
7.5 m	*3610	*3610			*5010	*5010				
6.0 m	*3410	*3410	*4010	*4010	*5610	*5610				
4.5 m	*3360	*3360	*5760	4210	*6210	6010	*6910	*6910		
3.0 m	*3460	3260	*6210	4410	*7110	5710	*8860	8860	*13310	*13310
1.5 m	*3710	3160	6410	3960	*8060	5410	*10810	8110	*7210	*7210
0.0 m	*4110	3160	6260	3810	*8760	5160	*12010	7660	*7810	*7810
-1.5 m	*4760	3410	6160	3760	8560	4960	*12160	7460	*11110	*11110
-3.0 m	*6110	3910			*8410	4960	*11310	7460	*16210	*14810
Arm length 2900 mm With outrigger front and rear										
7.5 m	*3610	*3610			*5010	*5010				
6.0 m	*3410	*3410	*4010	*4010	*5610	*5610				
4.5 m	*3360	*3360	*5760	5010	*6210	*6210	*6910	*6910		
3.0 m	*3460	*3460	*6210	4860	*7110	6860	*8860	*8860	*13310	*13310
1.5 m	*3710	*3710	6560	4710	*8060	6510	*10810	10060	*7210	*7210
0.0 m	*4110	3810	6410	4560	*8760	6260	*12010	9560	*7810	*7810
-1.5 m	*4760	4110	6310	4510	8760	6060	*12160	9310	*11110	*11110
-3.0 m	*6110	4760			*8410	6060	*11310	9310	*16210	*16210

* Load is limited by hydraulic capacity rather than tipping.
Rating are based on SAE Standard NO. J1097. Rated loads do not exceed 87% of hydraulic lift capacity or 75% of tipping load.

PW220-7 (One-piece boom)

Conditions:

Bucketless, Undercarriage width: 2.75 m, HD counterweight

unit: kg

	Max.		7.5 m		6.0 m		4.5 m		3.0 m	
	Cf	Cs	Cf	Cs	Cf	Cs	Cf	Cs	Cf	Cs
Arm length 2400 mm Without stabilizer										
7.5 m	*5010	4260			*5810	4510				
6.0 m	4360	3260			6060	4560				
4.5 m	3760	2810	4210	3160	5910	4410	9210	6660		
3.0 m	3460	2560	4110	3060	5660	4160	8460	6010		
1.5 m	3360	2510	4010	2960	5410	3910	7960	5560		
0.0 m	3410	2510	3910	2860	5110	3660	7660	5310		
-1.5 m	3710	2710	3860	2860	5010	3560	7610	5260	*10510	9310
-3.0 m	4310	3160			5160	3710	7710	5360	*9860	9560
Arm length 2400 mm With rear blade										
7.5 m	*5010	4810			*5810	5110				
6.0 m	*4760	3710			*7560	5160				
4.5 m	*4810	3210	6660	3610	*8960	5010	*10710	7560		
3.0 m	*4960	2960	6560	3510	9310	4760	*12710	6960		
1.5 m	5360	2910	6410	3410	9010	4560	*13610	6510		
0.0 m	5460	2960	6310	3360	8710	4310	*13060	6260		
-1.5 m	5960	3160	6310	3310	8610	4210	*11360	6210	*10510	*10510
-3.0 m	*5210	3660			*6760	4360	*8760	6310	*10110	*10110
Arm length 2400 mm With rear outrigger										
7.5 m	*5010	*5010			*5810	5560				
6.0 m	*4760	4010			*7560	5610				
4.5 m	*4810	3460	*7060	3910	*8860	5460	*10710	8310		
3.0 m	*4960	3210	7110	3810	*9560	5210	*12560	7610		
1.5 m	*5360	3110	6960	3660	9910	4910	*13460	7160		
0.0 m	5910	3160	6860	3610	9560	3660	*12860	6860		
-1.5 m	*5910	3410	*6460	3560	*8560	4560	*11210	6910	*10510	*10510
-3.0 m	*5110	3960			*6660	4710	*8560	6910	*9860	*9860
Arm length 2400 mm With outrigger and blade										
7.5 m	*5110	*5110			*5860	*5860				
6.0 m	*4860	*4860			*7660	6810				
4.5 m	*4860	4260	6510	4660	*9010	6660	*10860	10410		
3.0 m	*5060	3910	6510	4660	9210	6410	*12760	9660		
1.5 m	5360	3810	6410	4510	8910	6110	*13660	9160		
0.0 m	5460	3910	6310	4460	8560	5860	*13060	8810		
-1.5 m	5960	4210	6260	4410	8460	5760	*11360	8760	*10660	*10660
-3.0 m	*5210	4910			*6760	5910	*8710	*8710	*10060	*10060
Arm length 2400 mm With outrigger front and rear										
7.5 m	*5110	*5110			*5860	*5860				
6.0 m	*4860	*4860			*7660	*7660				
4.5 m	*4860	*4860	*7110	5560	*9010	7860	*10860	*10860		
3.0 m	*5060	4610	7160	5460	*9660	7560	*12760	11710		
1.5 m	*5460	4460	7060	5310	9910	7260	*13660	11160		
0.0 m	6010	4560	6910	5210	9560	6960	*13060	10810		
-1.5 m	*6010	4960	*6560	5210	*8660	6860	*11360	10760	*10660	*10660
-3.0 m	*5210	*5210			*6760	*6760	*8710	*8710	*10060	*10060

* Load is limited by hydraulic capacity rather than tipping. Rating are based on SAE Standard NO. J1097. Rated loads do not exceed 87% of hydraulic lift capacity or 75% of tipping load.

PW220-7 (One-piece boom)

Conditions:

Bucketless, Undercarriage width: 2.75 m, HD counterweight

unit: kg

	Max.		7.5 m		6.0 m		4.5 m		3.0 m	
	Cf	Cs	Cf	Cs	Cf	Cs	Cf	Cs	Cf	Cs
Arm length 2900 mm Without stabilizer										
7.5 m	*3410	*3410			*5210	4610				
6.0 m	*3310	2960	4310	3210	*6060	4610				
4.5 m	*3310	2560	4260	3210	5960	4460				
3.0 m	3210	3260	4110	3060	5710	4210	8760	6260	17160	11060
1.5 m	3110	2310	4010	2960	5410	3960	8110	5560		
0.0 m	3160	2310	3860	2860	5160	3710	7710	5310	*6710	*6710
-1.5 m	3360	2460	3810	2760	4960	3510	7560	5210	*9960	9210
-3.0 m	3810	2810	3860	2810	5010	2560	7610	5210	*12010	9410
Arm length 2900 mm With rear blade										
7.5 m	*3410	*3410			*5210	5160				
6.0 m	*3310	3310	*4610	3610	*6060	5160				
4.5 m	*3310	2860	*6060	3560	*7360	5010				
3.0 m	*3410	2660	6460	3460	*9210	4710	*12060	7060	*18910	12810
1.5 m	*3660	2560	6310	3310	8910	4460	*13260	6460		
0.0 m	*4060	2610	6210	3210	8610	4210	*13160	6110	*6710	*6710
-1.5 m	*4760	2760	6110	3160	8360	4010	*11910	5960	*9960	*9960
-3.0 m	*5110	3160	*5160	3160	*7360	4060	*9610	6010	*12010	11060
Arm length 2900 mm With rear outrigger										
7.5 m	*3410	*3410			*5210	*5210				
6.0 m	*3310	*3310	*4610	3960	*6060	5660				
4.5 m	*3310	3160	*6060	3910	*7360	5510				
3.0 m	*3410	2960	7110	3810	*9210	5260	*12060	7910	*18910	14710
1.5 m	*3660	2860	6960	3660	9760	4960	*13260	7260		
0.0 m	*4060	2910	6810	3560	9610	4710	*13160	6910	*6710	*6710
-1.5 m	*4760	3110	6760	3510	8910	4510	*11910	6760	*9960	*9960
-3.0 m	*5110	3510	*5160	3560	*7360	4560	*9610	6810	*12010	*12010
Arm length 2900 mm With outrigger and blade										
7.5 m	*3460	*3460			*5260	*5260				
6.0 m	*3360	*3360	*4660	*4660	*6160	*6160				
4.5 m	*3360	*3360	*6160	4810	*7460	6710				
3.0 m	*3460	*3460	6560	4660	9260	6460	*12210	9910	*19160	*19160
1.5 m	*3710	3510	6410	4510	8960	6160	*13460	9260		
0.0 m	*4110	3560	6260	4410	8610	5860	*13360	8860	*6810	*6810
-1.5 m	*4810	3810	6210	4360	8410	5710	*12060	8710	*10060	*10060
-3.0 m	*5210	4360	*5260	4360	*7460	5760	*9760	8760	*12210	*12210
Arm length 2900 mm With outrigger front and rear										
7.5 m	*3460	*3460			*5260	*5260				
6.0 m	*3360	*3360	*4660	*4660	*6160	*6160				
4.5 m	*3360	*3360	*6160	5160	*7460	7360				
3.0 m	*3460	*3460	6710	5060	*9260	7060	*12060	11160	*18910	*19160
1.5 m	*3710	*3710	6560	4910	9260	6760	*13410	10460		
0.0 m	*4110	3860	6410	4810	8910	5860	*13360	8860	*6810	*6810
-1.5 m	*4810	4110	6360	4710	8710	6260	*12260	9860	*10060	*10060
-3.0 m	*5360	4760	*5410	4760	*7660	6310	*10060	9910	*12210	*12210

* Load is limited by hydraulic capacity rather than tipping.
Rating are based on SAE Standard NO. J1097. Rated loads do not exceed 87% of hydraulic lift capacity or 75% of tipping load.

PW220-7 (Two-piece boom)

Conditions:

Bucketless, Undercarriage width: 2.75 m, HD counterweight

unit: kg

	Max.		7.5 m		6.0 m		4.5 m		3.0 m	
	Cf	Cs	Cf	Cs	Cf	Cs	Cf	Cs	Cf	Cs
Arm length 2400 mm Without stabilizer										
7.5 m	*5160	4660								
6.0 m	4660	3460			6210	4610				
4.5 m	3960	2960	4260	3160	6060	4510	*8260	6860		
3.0 m	3610	2660	4160	3060	5760	4260	8860	6260		
1.5 m	3510	2560	4060	2960	5510	3960	8160	5710		
0.0 m	3560	2610	3910	2860	5260	3760	7760	5360		
-1.5 m	3760	2710	3910	2810	5160	3660	7660	5260	*9910	9210
-3.0 m	4610	3310			5210	3710	7710	5310	15310	9460
Arm length 2400 mm With rear blade										
7.5 m	*5160	*5160								
6.0 m	*4860	3910			*6610	5160				
4.5 m	*4810	3310	*6310	3560	*7210	5010	*8260	7710		
3.0 m	*4960	3010	6560	3460	*8110	4760	*10310	7110		
1.5 m	*5310	2910	6410	3360	*9060	4510	*12210	6510		
0.0 m	5660	2960	6310	3260	8810	4260	*13110	6160		
-1.5 m	6210	3160	6260	3210	8660	4160	*12910	6010	*11710	10910
-3.0 m	*7360	3760			*8560	4210	*11610	6110	*16160	11160
Arm length 2400 mm With rear outrigger										
7.5 m	*5160	*5160								
6.0 m	*4860	4310			*6610	5660				
4.5 m	*4810	3660	*6310	3910	*7210	5560	*8260	*8260		
3.0 m	*4960	3360	*7010	3810	*8110	5310	*10310	7960		
1.5 m	*5310	3210	7060	3710	*9060	5010	*12210	7310		
0.0 m	*5960	3260	6960	3610	*9610	4760	*13110	6960		
-1.5 m	6860	3560	6910	3560	*9560	4660	*12910	6810	*11710	*11710
-3.0 m	*7360	4210			*8560	4710	*11610	6910	*16160	13010
Arm length 2400 mm With outrigger and blade										
7.5 m	*5260	*5260								
6.0 m	*4910	*4910			*6710	*6710				
4.5 m	*4860	4510	*6360	4860	*7310	6860	*8360	*8360		
3.0 m	*5010	4160	7110	4760	*8260	6610	*10510	10160		
1.5 m	*5360	4010	6960	4610	*9160	6310	*12410	9460		
0.0 m	*6010	4110	6860	4510	9610	6060	*13310	9060		
-1.5 m	6760	4460	6810	4460	9460	5910	*13110	8910	*11910	*11910
-3.0 m	*7460	5260			*8710	6010	*11810	9010	*16410	*16410
Arm length 2400 mm With outrigger front and rear										
7.5 m	*5260	*5260								
6.0 m	*4910	*4910			*6710	*6710				
4.5 m	*4860	*4860	*6360	5610	*7310	*7310	*8360	*8360		
3.0 m	*5010	4810	*7110	5510	*8260	7710	*10510	*10510		
1.5 m	*5360	4660	7160	5410	*9160	7410	*12410	11410		
0.0 m	*6010	4760	7010	5260	*9760	7160	*13310	11010		
-1.5 m	6910	5210	7010	5260	9710	7060	*13110	10860	*11910	*11910
-3.0 m	*7460	6210			*8710	7110	*11760	10960	*16410	*16410

* Load is limited by hydraulic capacity rather than tipping.
Rating are based on SAE Standard NO. J1097. Rated loads do not exceed 87% of hydraulic lift capacity or 75% of tipping load.

PW220-7 (Two-piece boom)

Conditions:

Bucketless, Undercarriage width: 2.75 m, HD counterweight

unit: kg

	Max.		7.5 m		6.0 m		4.5 m		3.0 m	
	Cf	Cs	Cf	Cs	Cf	Cs	Cf	Cs	Cf	Cs
Arm length 2900 mm Without stabilizer										
7.5 m	*3560	*3560			*4910	4660				
6.0 m	*3360	3110	*3960	3260	*5910	4710				
4.5 m	*3310	2660	4310	3210	6160	4560	*7060	7060		
3.0 m	3310	2460	4210	3110	5860	4310	9060	6460	*14210	11660
1.5 m	3210	2360	4060	2960	5510	4010	8310	5810	*7110	*7110
0.0 m	3260	2360	3910	2860	5260	3760	7810	5360	*7710	*7710
-1.5 m	3510	2510	3860	2760	5110	3610	7610	5210	*10960	9160
-3.0 m	4010	2910			5110	3610	7610	6210	15110	9310
Arm length 2900 mm With rear blade										
7.5 m	*3560	*3560			*4910	*4910				
6.0 m	*3360	*3360	*3960	3610	*5910	5260				
4.5 m	*3310	3010	*5710	3610	*6610	5110	*7060	*7060		
3.0 m	*3410	2760	6610	3510	*7610	4810	*9460	7310	*14210	13460
1.5 m	*3660	2660	6460	3360	*8660	4510	*11610	6610	*7110	*7110
0.0 m	*4010	2710	6310	3210	8860	4310	*12860	6160	*7710	*7710
-1.5 m	*4710	2860	6210	3160	8610	4110	*13010	6010	*10960	10810
-3.0 m	*6010	3310			8660	4160	*12160	6010	*16010	11010
Arm length 2900 mm With rear outrigger										
7.5 m	*3560	*3560			*4910	*4910				
6.0 m	*3360	*3360	*3960	*3960	*5910	5760				
4.5 m	*3310	*3310	*5710	3960	*6610	5610	*7060	*7060		
3.0 m	*3410	3060	*6660	3860	*7610	5360	*9460	8160	*14210	*14210
1.5 m	*3660	2960	7110	3710	*8660	5060	*11610	7460	*7110	*7110
0.0 m	*4010	3010	6960	3560	*9410	4810	*12860	7010	*7710	*7710
-1.5 m	*4710	3210	6860	3510	*9560	4610	*13010	6810	*10960	*10960
-3.0 m	*6010	3710			*9010	4660	*12160	6810	*16010	12860
Arm length 2900 mm With outrigger and blade										
7.5 m	*3610	*3610			*5010	*5010				
6.0 m	*3410	*3410	*4010	*4010	*6010	*6010				
4.5 m	*3360	*3360	*5760	4910	*6710	*6710	*7160	*7160		
3.0 m	*3460	*3460	*6760	4760	*7710	*6660	*9610	*9610	*14460	*14460
1.5 m	*3710	*3710	7010	4610	*8810	6360	*11760	9610	*7210	*7210
0.0 m	*4110	3760	6860	4510	*9560	6060	*13060	9110	*7810	*7810
-1.5 m	*4760	4010	6760	4410	9410	5910	*13210	8910	*11110	*11110
-3.0 m	*6110	3910			*9160	5910	*12360	8910	*16210	*16210
Arm length 2900 mm With outrigger front and rear										
7.5 m	*3610	*3610			*5010	*5010				
6.0 m	*3410	*3410	*4010	*4010	*6010	*6010				
4.5 m	*3360	*3360	*5760	5260	*6710	*6710	*7160	*7160		
3.0 m	*3460	*3460	*6760	5160	*7710	7260	*9610	*9610	*14460	*14460
1.5 m	*3710	*3710	6660	5010	*8810	6910	*11760	10760	*7210	*7210
0.0 m	*4110	4010	6510	4860	9160	6610	*13060	10210	*7810	*7810
-1.5 m	*4760	4310	6460	4760	8960	6460	*13210	9960	*11110	*11110
-3.0 m	*6110	5010			9010	6460	*12360	9960	*16210	*16210

* Load is limited by hydraulic capacity rather than tipping.
Rating are based on SAE Standard NO. J1097. Rated loads do not exceed 87% of hydraulic lift capacity or 75% of tipping load.

SECTION **2F**

DEMOLITION

CONTENTS

Machine Selection (Guide Line)2F-2
Specifications:
 Demolition Specification2F-3
 Demolition High Reach2F-4
Attachment Features and Specifications:
 Demolition Two Piece Boom2F-10
 Underground Demolition Specifications2F-11

1. When carrying out demolition of concrete building from the ground

- 1) For demolition of 4~10 storied buildings use a hydraulic excavator with a super long boom and arm as base machine.
- 2) For demolition of 2~4 storied buildings use a hydraulic excavator with a normal boom and arm as the base machine.
- 3) For demolition of the foundations or areas below ground level, use a hydraulic excavator with the normal boom and arm as the base machine and operate from the ground level. If necessary, lower the machine below the ground to carry out the work.

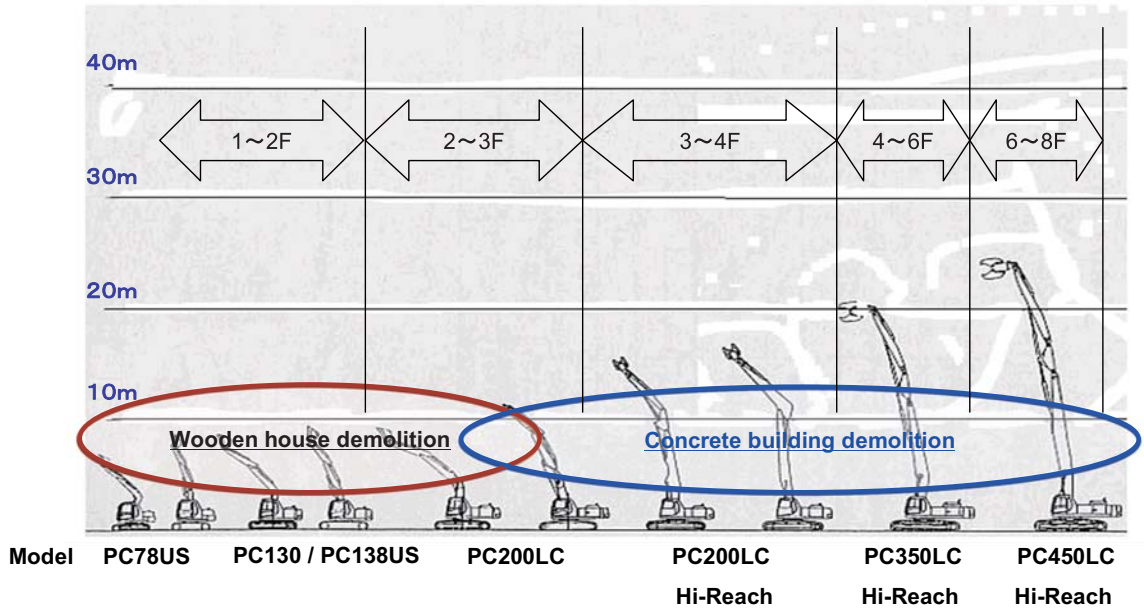

2. When carrying out demolition from inside the building being demolished

There is no space to carry out demolition work with machine from the ground level, or the building is too high (higher than 6 stories) to demolished, and the demolition attachment does not reach, place the demolition machine on the top floor of the building to be demolished. Start the demolition operation from the top, and work down.

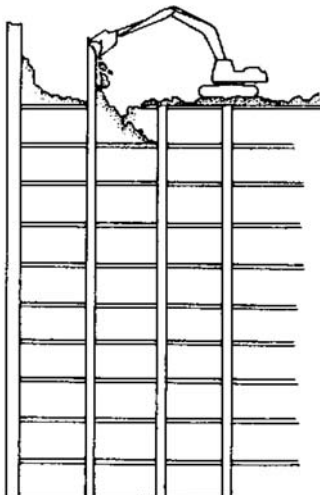

Specifications Demolition Specification

DEMOLITION

- Demolition work means hard work for hydraulic excavators. Operator safety, machine flexibility, reliability and performance are essential for this application.
- Demolition specification features additional machine guarding, reinforced structure and better visibility that enables safer and more efficient operation.

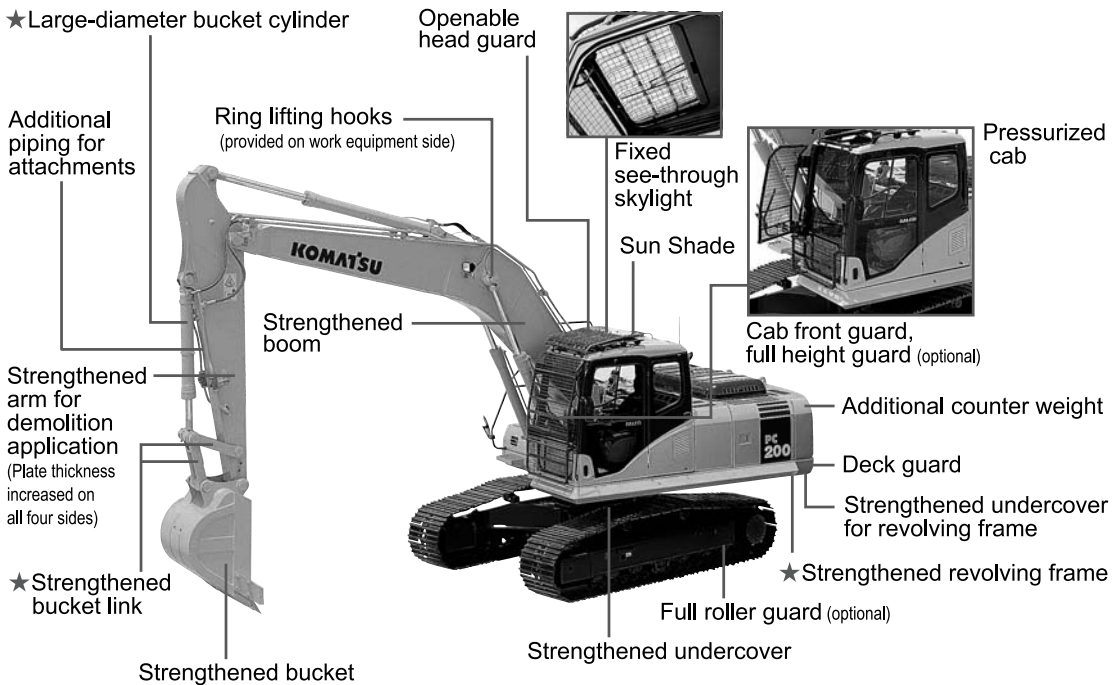

★ Parts normally used for one-class higher model (PC220)

Specifications Demolition High Reach

DEMOLITION

- Demolition high reach enables high efficient operation and safety for 3-4 stories building demolition.
- Two-stage front type provides easy demolition operation thanks to the same lever motion as standard machine.



Working Range

PC200LC

(2-stage type for demolition work only)

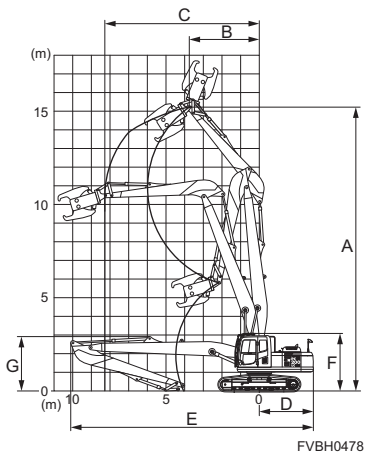

PC200LC

(2-stage type for demolition and digging work)

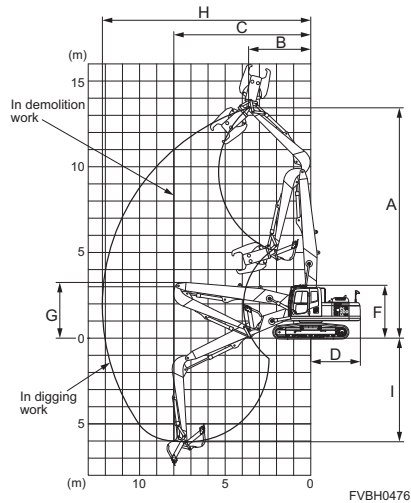

Specifications

Model		PC200LC	
Structure	High reach type	2-stage	
	Boom type	1-piece	
	Application	For Demolition work	For Demolition & Digging work
Operating Weight *1	kg(lb)	28,200(62,170)	27,200(59,970)
Max. Allowable Crusher Weight	kg(lb)	2,300(5,070)	2,300(5,070)
Max. Working Height *2	A mm(ft.in)	15,215(49'11")	13,460(44'2")
Arm Top Pin Radius at Max. Working Height	B mm(ft.in)	3,810(12'6")	3,600(11'10")
Max. Allowable Working Radius	C mm(ft.in)	8,300(27'3")	8,000(26'3")
Tail Swing Radius	D mm(ft.in)	2,940(9'8")	2,940(9'8")
Overall Length *3	E mm(ft.in)	13,260(43'6")	11,090(36'5")
Overall Height *3	F mm(ft.in)	3,160(10'4")	3,160(10'4")
Height of Folded Work Equipment	G mm(ft.in)	2,850(9'4")	3,000(9'10")
Arm Top Pin at Max. Working Radius	H mm(ft.in)	—	12,210(40'1")
Arm Top Pin at Max. Working Depth	I mm(ft.in)	—	6,165(20'3")

* The photos may slightly differ from the standard specifications of demolition high reach.

* For precautions when operating the machine, refer to the operation and maintenance manual.

*1 Excluding allowable crusher weight

*2 Arm top pin

*3 When work equipment is folded and lowered to the ground

Specifications Demolition High Reach

DEMOLITION

- Demolition high reach enables high efficient operation and safety for 3-4 stories building demolition.
- Three-stage front type suits for delicate demolition work thanks to the intermediate arm that ensures the wider working range than 2-stage type.

Working Range

PC200LC

(3-stage type for demolition work only)

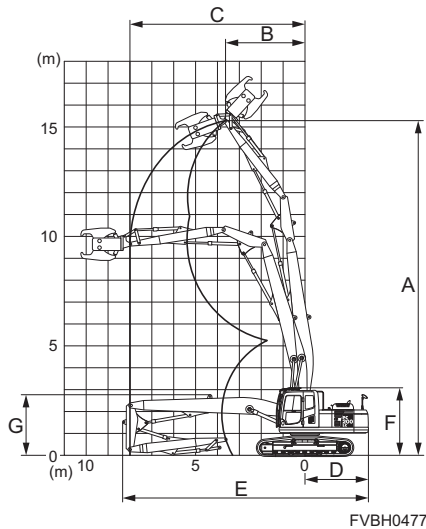

Specifications

Model			PC200LC
Structure	High reach type	3-stage	
	Boom type	1-piece	
Operating Weight *1	kg(lb)	27,700(61,070)	
Max. Allowable Crusher Weight	kg(lb)	2,100(4,630)	
Max. Working Height *2	A	mm(ft.in)	15,225(49'11")
Arm Top Pin Radius at Max. Working Height	B	mm(ft.in)	3,600(11'10")
Max. Allowable Working Radius	C	mm(ft.in)	8,000(26'3")
Tail Swing Radius	D	mm(ft.in)	2,940(9'8")
Overall Length *3	E	mm(ft.in)	11,280(37'0")
Overall Height *3	F	mm(ft.in)	3,160(10'4")
Height of Folded Work Equipment	G	mm(ft.in)	2,750(9')

* The photos may slightly differ from the standard specifications of demolition high reach.

* For precautions when operating the machine, refer to the operation and maintenance manual.

*1 Excluding allowable crusher weight

*2 Arm top pin

*3 When work equipment is folded and lowered to the ground

Specifications Demolition High Reach

DEMOLITION

- There are several stages at the demolition works such as demolishing structures, taking out debris, leveling ground etc. which are required several machines at each process.
- The exchangeable fronts system can reduce the cost and time for demolition works. Three types of equipments are available by exchanging front equipment at one machine.
- Safety devices are equipped such as working range monitor, wide view front glass etc.

Demolition spec. outline

There are three kind of work equipment configuration.

- (1) Hi-reach demolition spec.
- (2) Demolition excavation boom spec.
- (3) Demolition two-piece long front spec.

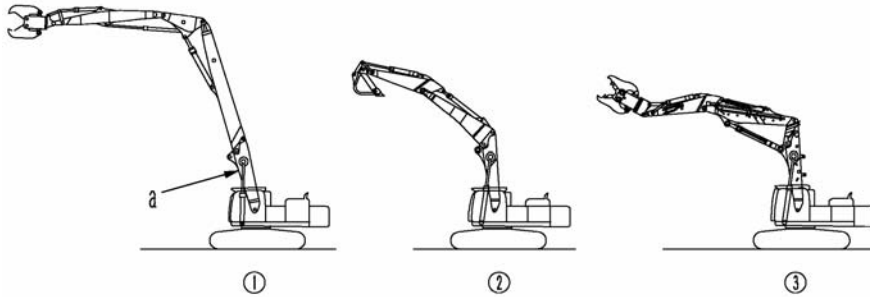

(a)'s first boom is a common for the above three configuration spec.

PC350LC Demolition spec.

		Hi-reach demolition spec.	Demolition excavation boom spec.	Demolition two-piece long front spec.	
Operating weight	kg (lb)	41,300 (91,050)	35,700 (78,700)	41,700 (91,930)	
Max. attachment weight	kg (lb)	2,300 (5,070)	—	3,600 (7,940)	
Bucket capacity	m ³ (cu.yd)	—	1.4 (1.83)	1.4 (1.83)	
A	Overall length	mm (ft.in)	14,980 (49'2")	12,120 (39'9")	14,350 (47'1")
B	Overall height	mm (ft.in)	3,340 (10'11")	3,565 (11'8")	3,565 (11'8")
C	Cab height	mm (ft.in)	3,140 (10'4")		
D	Track length	mm (ft.in)	4,960 (16'3")		
E	Tumbler distance	mm (ft.in)	4,030 (13'3")		
Overall width		mm (ft.in)	3,200 (10'6")		
Shoe width		mm (in)	600 (24")		
Ground clearance		mm (ft.in)	500 (1'8")		

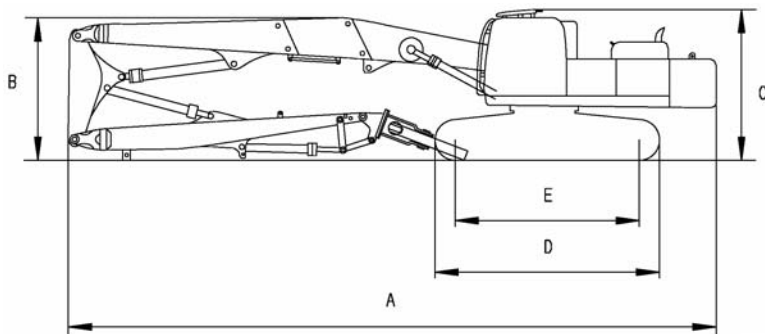

Specifications Demolition High Reach

DEMOLITION

PC350LC Demolition spec.

Hi-reach demolition spec.

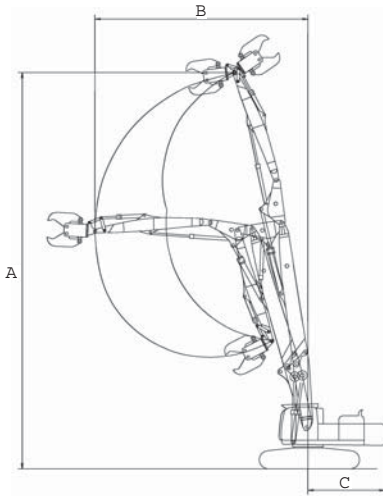

A	Max. working height	mm (ft.in)	20,510 (67'3")
B	Max. forward reach	mm (ft.in)	11,000 (36'1")
C	Turning radius at rear portion	mm (ft.in)	3,800 (12'6")
D	Max. digging depth	mm (ft.in)	—

Demolition excavation boom spec.

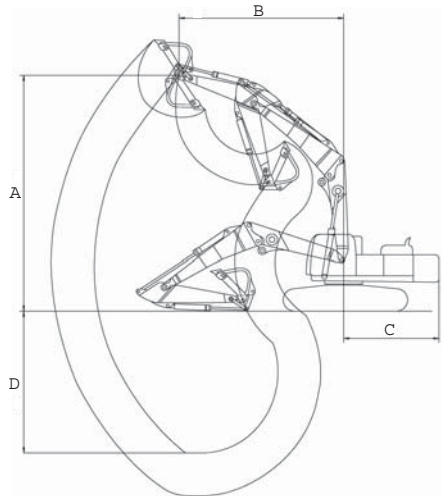

A	Max. working height	mm (ft.in)	10,540 (34'7")
B	Max. forward reach	mm (ft.in)	6,710 (22'0")
C	Turning radius at rear portion	mm (ft.in)	4,435 (14'7")
D	Max. digging depth	mm (ft.in)	7,410 (24'4")

Demolition two-piece long front spec.

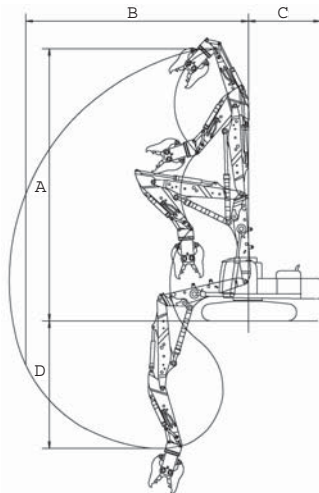

A	Max. working height	mm (ft.in)	14,380 (47'2")
B	Max. forward reach	mm (ft.in)	9,000 (29'6")
C	Turning radius at rear portion	mm (ft.in)	3,230 (10'7")
D	Max. digging depth	mm (ft.in)	6,750 (22'2")

Specifications Demolition High Reach

DEMOLITION

PC450LC Demolition spec.

		Hi-reach demolition spec.	Demolition excavation boom spec.	Demolition two-piece long front spec.
Operating weight	kg (lb)	57,220 (126,150)	54,300 (119,710)	60,520 (133,420)
Max. attachment weight	kg (lb)	2,300 (5,070)	—	5,700 (12,570) or 4,200 (9,260)
Bucket capacity	m ³ (cu.yd)	—	1.9 (2.49)	1.9 (2.49)
A	Overall length	mm (ft.in)	16,450 (54'0")	12,700 (41'8")
B	Overall height	mm (ft.in)	3,450 (11'4")	3,755 (12'4")
C	Cab height	mm (ft.in)	3,450 (11'4")	3,450 (11'4")
D	Track length	mm (ft.in)	5,385 (17'8")	5,385 (17'8")
E	Tumbler distance	mm (ft.in)	4,350 (14'3")	4,350 (14'3")
Overall width		mm (ft.in)	3,490 (11'5")	3,490 (11'5")
Shoe width		mm (in)	600 (24")	600 (24")
Ground clearance		mm (ft.in)	685 (2'3")	685 (2'3")

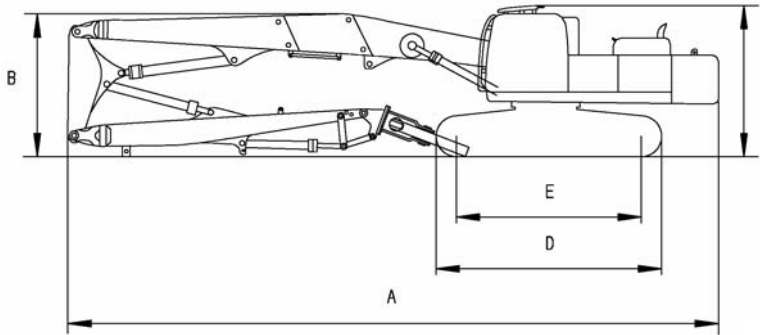

Hi-reach demolition spec.

Demolition excavation boom spec.

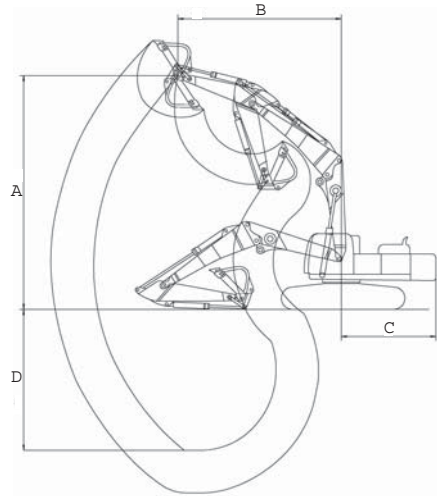
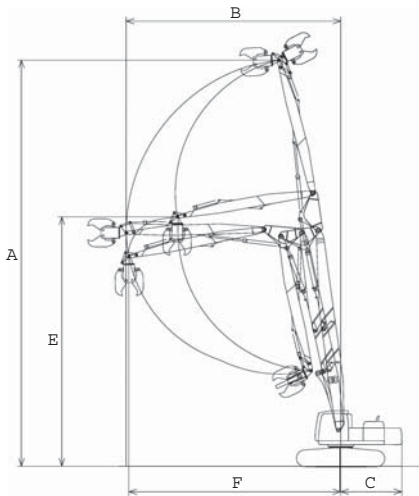

		Hi-reach demolition spec.	Demolition excavation boom spec.
A	Max. working height	mm (ft.in)	24,660 (80'11")
B	Max. forward reach	mm (ft.in)	13,000 (42'8")
C	Turning radius at rear portion	mm (ft.in)	3,710 (12'2")
D	Max. digging depth	mm (ft.in)	—
E	Max. working height at possible horizontal crashing	mm (ft.in)	15,128 (49'8")
F	Max. forward reach at possible horizontal crashing	mm (ft.in)	12,838 (42'1")

Specifications Demolition High Reach

DEMOLITION

PC450LC Demolition spec.

Demolition two-piece long front spec.

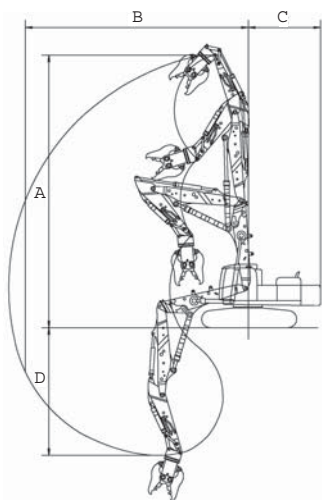

A	Max. working height	mm (ft.in)	15,150 (49'8")
B	Max. forward reach	mm (ft.in)	9,000 (29'6")
C	Turning radius at rear portion	mm (ft.in)	3,710 (12'2")
D	Max. digging depth	mm (ft.in)	6,910 (22'8")
E	Max. working height at possible horizontal crashing	mm (ft.in)	15,145 (49'8")
F	Max. forward reach at possible horizontal crashing	mm (ft.in)	9,000 (29'6")

- The demolition two piece boom now realizes a higher, wider and longer working range.
- It has also made possible demolition work comparable to a one-class larger machine in a tight quarter.
- It demonstrates power when demolishing low-rise to mid-rise building now that it can access closer to a building to be demolished.
- The base machine is designed for demolition work. Various critical parts and work equipment have been strengthened to ensure higher durability. Thus it demonstrates excellent performance in the hard working conditions.

The two piece boom enables an operator to reach a higher work point.

- PC200LC demolition specifications
- PC200LC demolition specifications with 2 piece boom

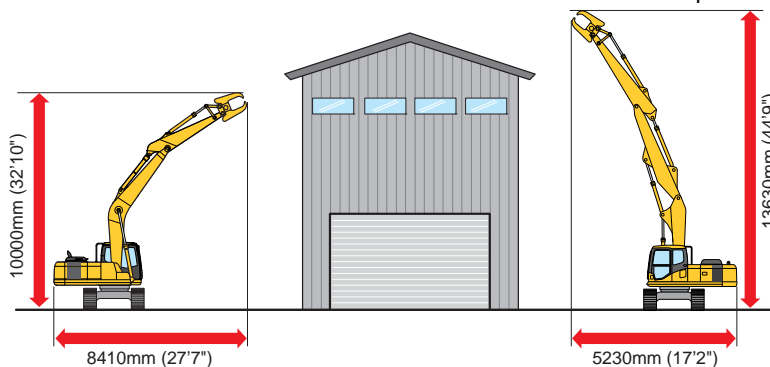

Tow piece boom spec.

		PC78US	PC138US	PC200LC	PC228USLC
Operating weight	kg (lb)	8,390 (18,500)	15,675 (34,560)	27,900 (61,510)	29,400 (64,820)
Max. attachment weight	kg (lb)	560 (1,230)	1,000 (2,200)	2,300 (5,070)	2,500 (5,510)
Bucket capacity	m ³ (cu.yd)	0.28 (0.37)	0.5 (0.65)	0.8 (1.05)	0.8 (1.05)
Max. working height	mm (ft.in)	8675 (28'6")	10500 (34'5")	12140 (39'10")	12100 (39'8")

Attachment Features and Specifications Underground Demolition Specifications

DEMOLITION

- A breaker and crusher for a one-class larger machine (PC200 class) can be installed.
- A regenerative circuit assures a hydraulic oil amount equal to that for one-class larger machine (PC200 class) in the crushing work.
- A two piece boom is adopted.
- A low height cab is installed, allowing the machine to pass under 2,530 m (8'4") high beam.
- Ring hooks for lifting the machine are installed as a standard equipment.

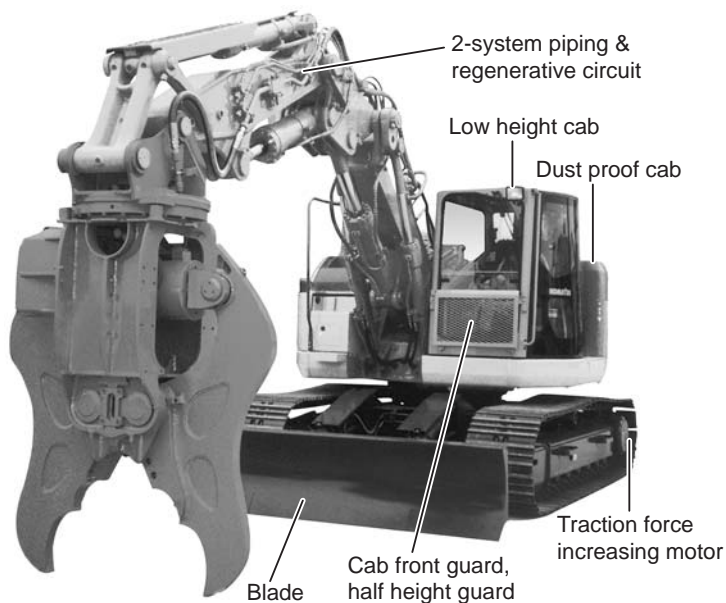

Model		PC138US
Machine weight	kg (lb)	15000 (33,070)
Max. crusher weight	kg (lb)	2300 (5,070)

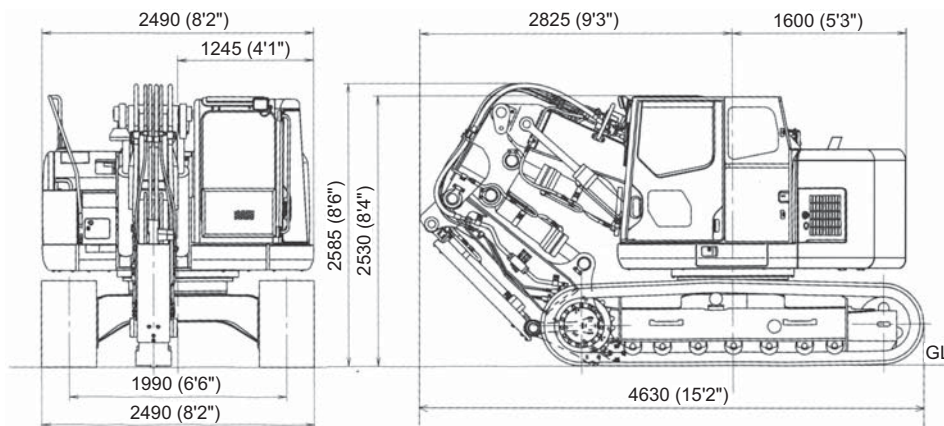
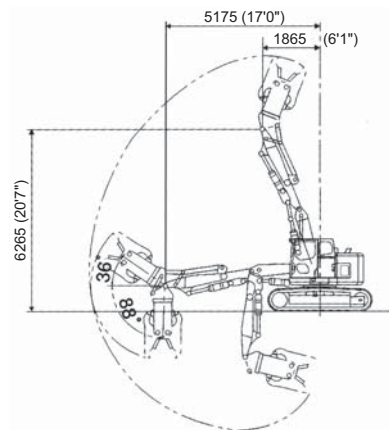

MEMO

A series of horizontal dashed lines for writing.

SECTION **2G**

SCRAP & MATERIAL HANDLING

CONTENTS

Attachments for Industry:

Scrap Handling Machine	2G-2
High-mount Cab	2G-5
Lifting Magnet	2G-6
Car Scrap Handler	2G-6
Scrap Grapple	2G-6
Orange Grapple	2G-6
Magnet Fork	2G-6

Scrap Handling Machine

Long Boom and Long Arm

- Mounted on the machine body these give you increased working reach-and safe, easy loading and unloading at those heights. The extended working range pays off in greater scrap-handling efficiency.

The Komatsu Scrap Handling Machine consists of:

- Basic Machine (See catalog for standard machines.)
- Scrap-handling long boom and gooseneck arm
- Attachment hydraulics
- Boom cylinder hydraulic line and drift-prevention valve
- Heavy counterweight
- High-mount cabs (hydraulic elevator; PC300 parallel link type, PC450 Z-link type)
- Optional widened track gauge for enhanced lateral stability. (PC300)



Dimensions & Working range

PC300 14 m (46') reach with hydraulic lift cab

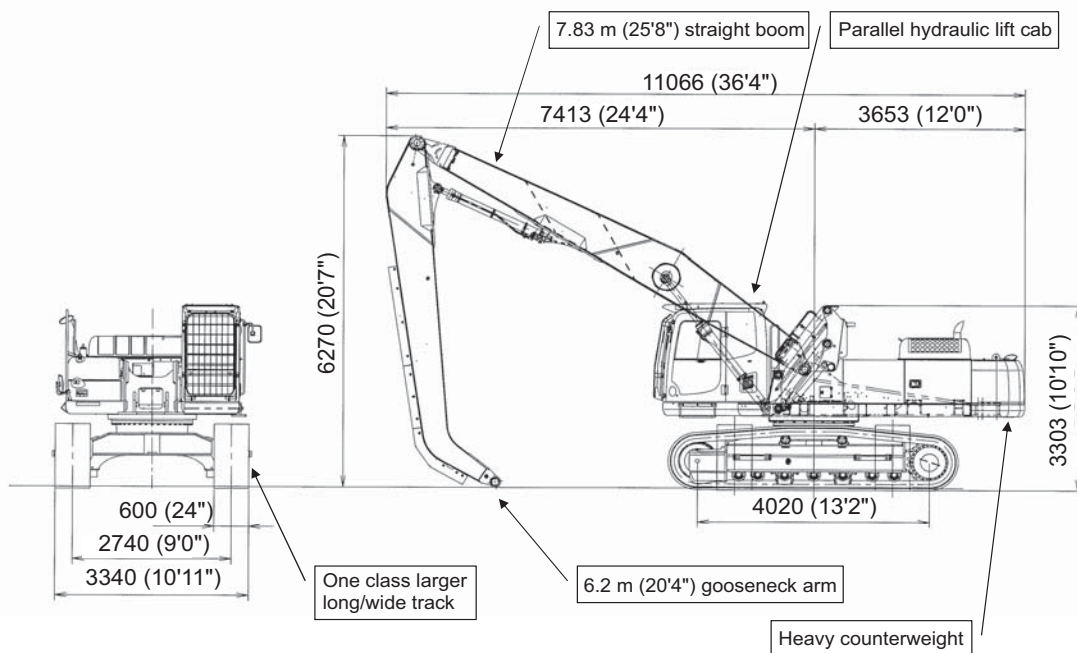

Scrap Handling Machine

PC300 14m (46') reach spec with hydraulic lift cab

Working range

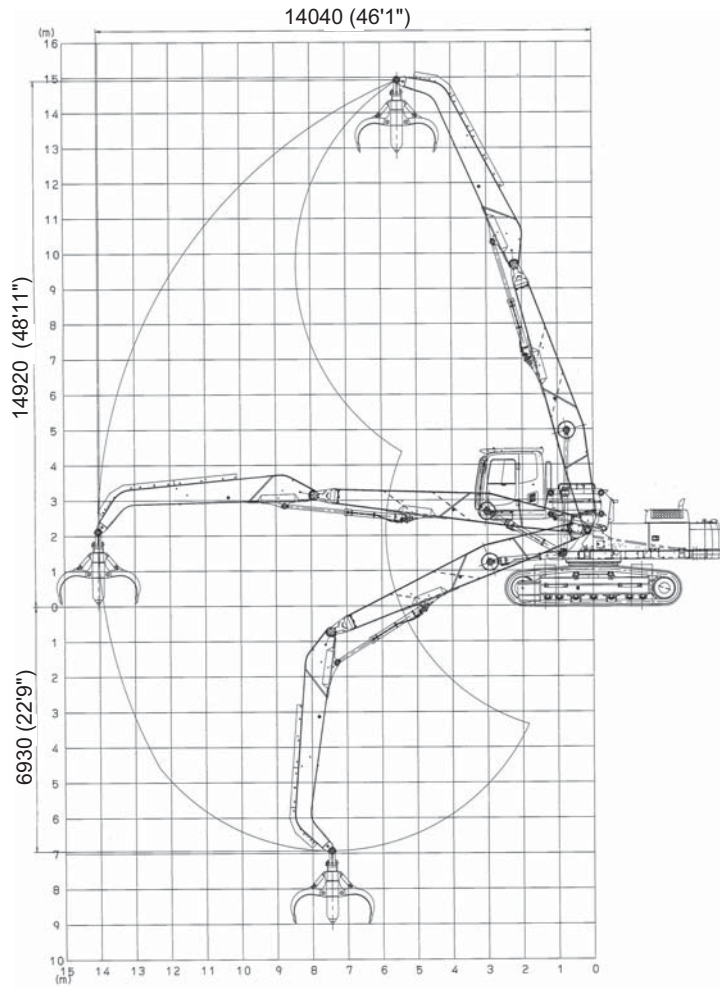

Model		PC300
Boom length	m (ft.in)	7.83 (25'8")
Arm length	m (ft.in)	6.2 (20'8")
Max. reach, at arm end pin	m (ft.in)	14.04 (46'1")
Max. height, at arm end pin	m (ft.in)	14.92 (48'11")
Max. digging depth, at arm end pin	m (ft.in)	6.93 (22'9")

Scrap Handling Machine

PC450LC 15.5 m (51'2") reach spec with hydraulic lift cab

Working range

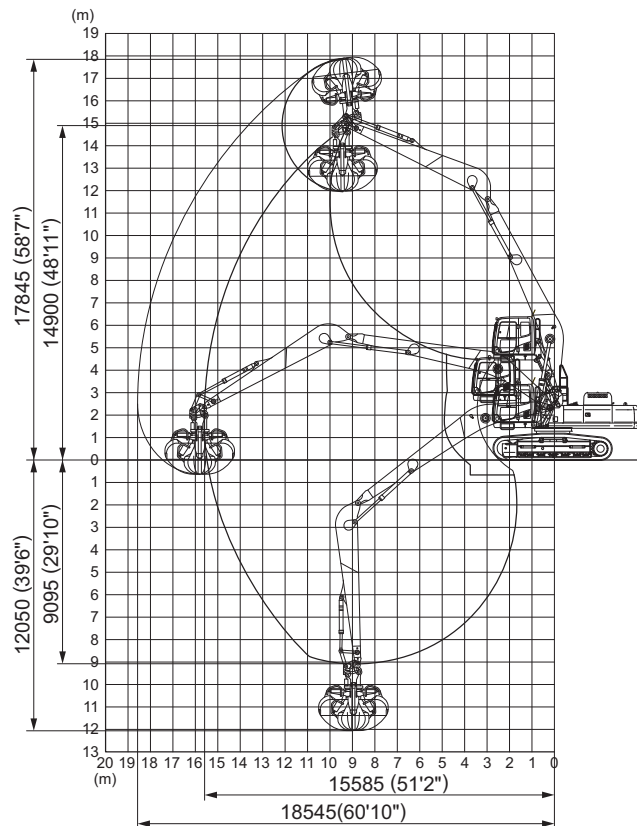

Model		PC450LC
Boom length	m (ft.in)	9.6 (31'6")
Arm length	m (ft.in)	7.0 (23')
Max. reach, at arm end pin	m (ft.in)	15.58 (51'2")
Max. height, at arm end pin	m (ft.in)	14.90 (48'10")
Max. digging depth, at arm end pin	m (ft.in)	9.09 (29'10")

FVBH0488

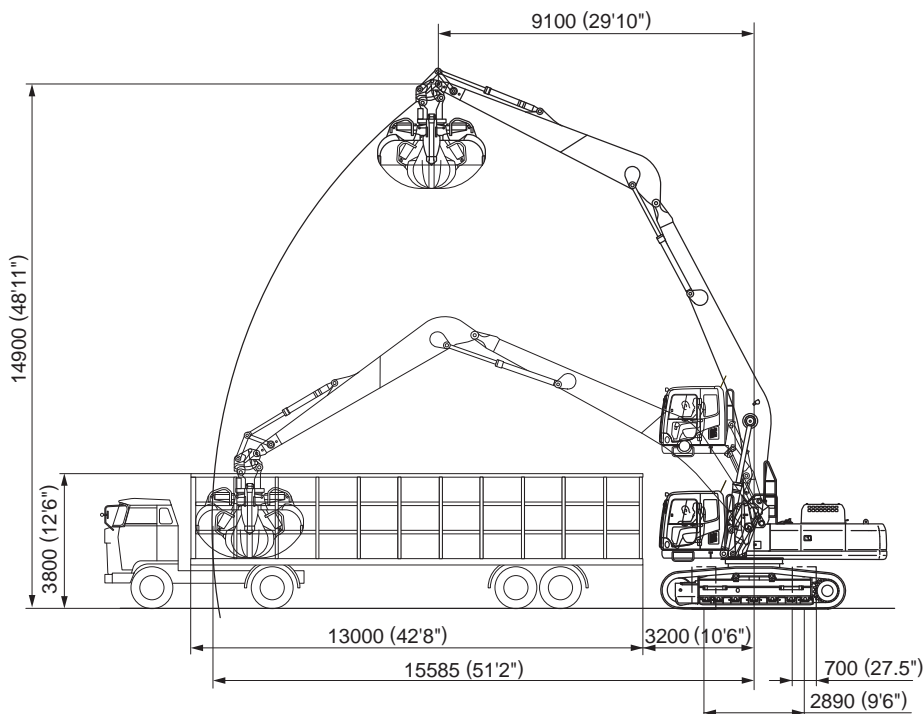

FVBH0489

High-mount Cab

A high-mount cab provides the operator with wider and clearer field view, thus facilitating loading or unloading of scrap on or off a truck and charging or discharging into or out of scrap processing machines. The hydraulic elevating cab lowered ensures better transportability.

Parallel link cab

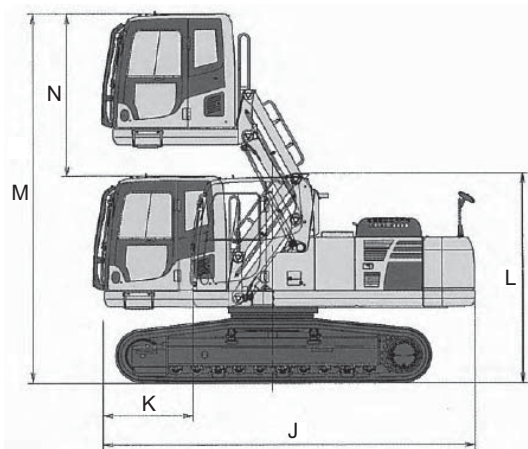

Dimension

	Model	PC200	PC220	PC300	
J	Overall length	mm (ft.in)	5,485 (18'0")	5,485 (18'0")	6,310 (20'8")
K	Cab protruding amount [compared with std cab]	mm (ft.in)	1,310 (4'4")	1,310 (4'4")	1,310 (4'4")
L	Height at cab lowest position	mm (ft.in)	3,075 (10'1")	3,085 (10'1")	3,195 (10'6")
M	Height at cab fully raised	mm (ft.in)	5,430 (17'10")	5,440 (17'10")	5,540 (18'2")
N	Lift height	mm (ft.in)	2,400 (7'10")	2,400 (7'10")	2,400 (7'10")

Z-link cab (3 m (9'10") lift height) for PC450LC

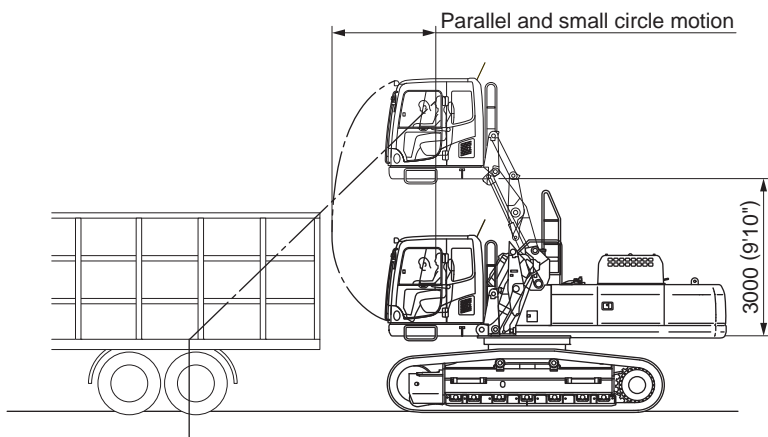

FVBH0490

Lifting Magnet (PC200-PC450)

- Lifting magnet with strong attraction force by over-excitation and swift release by reverse excitation.
- Engine-driven brushless alternator, realizing a maintenance free operation.



PC200LC

Car Scrap Handler (PC200)

- With one car scrap handler, preparation, dismantling, and sorting work can be carried out speedily. The combination play between a state-of-the-art machine and a clamp arm makes delicate removal operations possible.
- Powerful clamp arm
The clamp arm installed to the track frame can hold the scrapped car securely, so picking-up work can be carried out efficiently and smoothly.



PC200

Scrap Grapple

To assure safe handling of massive or irregularly shaped scrap, each of the 4 claws opens and closes by independent hydraulic cylinders. The grapple rotates freely to make grappling readjustments safe and easy.

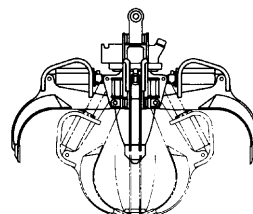

Orange Grapple

The claws are 4 vane-shaped blades operated independently by hydraulic cylinders. The freely turn-able grapple surrounds the scrap material; grasps accurately, and keeps small-item spillage to a minimum.

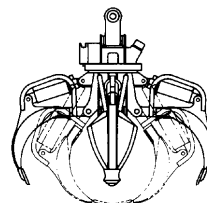

Magnet Fork (PC200-PC220)

An excavator-based machine with a lifting magnet and fork device exhibits the best operating performance in scrap handlings by itself through the combination of both the MAGNET absorbing and FORK grapple forces, thus enabling great improvement of working efficiency, because materials to be handled can be freely selected.



SECTION **2H**

**SPECIAL APPLICATION
MACHINES**

CONTENTS

Inboard Work Specifications	2H-2
Barge-ship Work Specifications	
Backhoe Dredger	2H-4
Heat Resistance Specifications	2H-5

Inboard Work Specifications

PC138US inboard work spec.

- (1) Wide working range can speedy inboard work at vessel corner and high position work.
- (2) Short tail swing type can meet with tight working conditions.



20% large fuel tank capacity for long refill interval

Head guard



Engine room cover for preventive chip and dust intake



Four additional working light



Strengthened arm and link

Holed shoe for preventive chip stack



Spiked carrier roller for chip removal from track link



Hook for machine lifting



Large capacity chip bucket



Sling hook



Photo shown PC138US-2 former model

Inboard Work Specifications

PC130 inboard work spec.

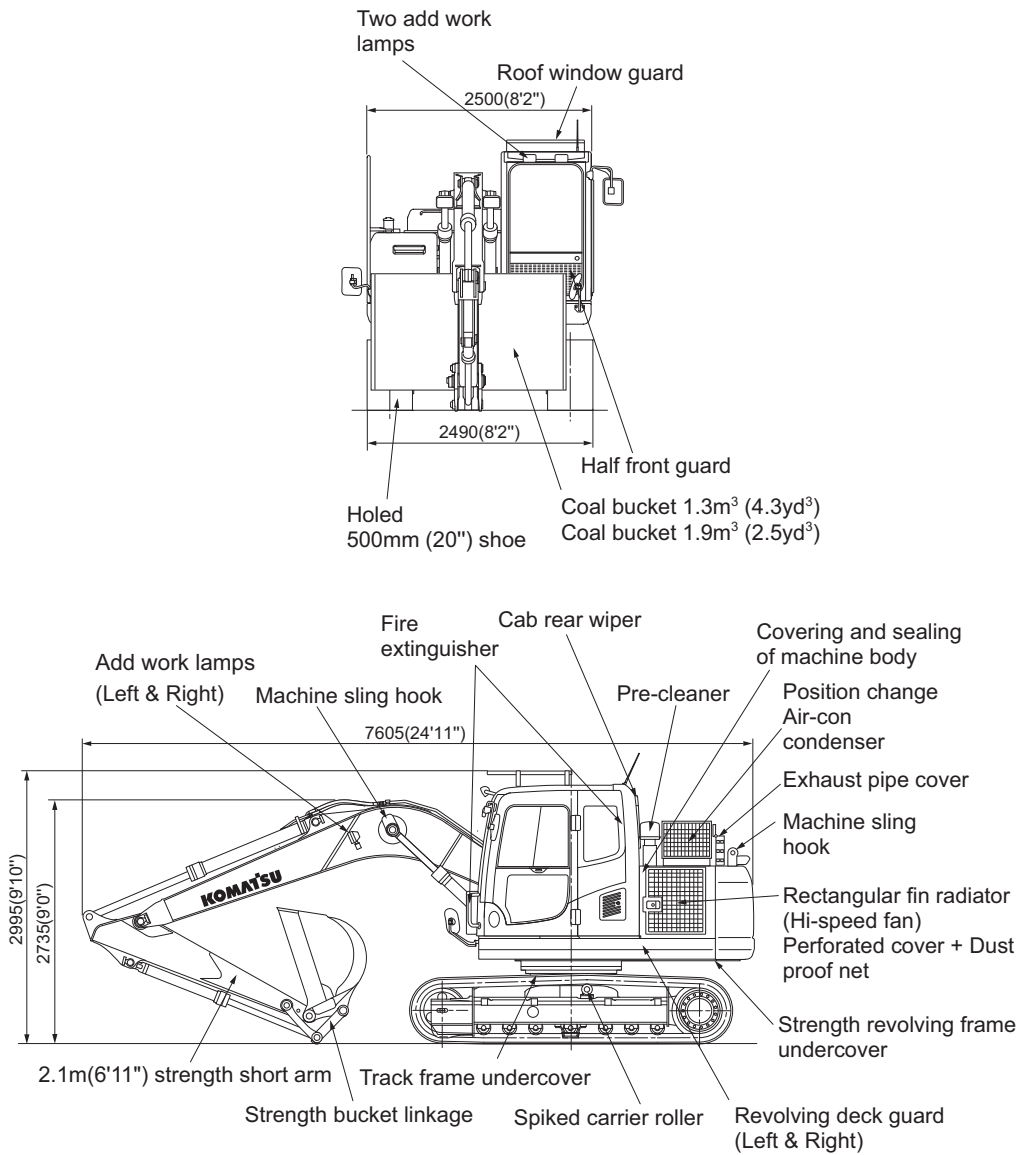

FVBH0485



For coal



For salt

Backhoe Dredger

An excavator based machine with BACK-HOE TYPE SPECS mounted on a vessel exhibits its best operating performance in large-scaled ocean works such as filling-up reclamation to build a land, adjustment or enlargement of harbors and demolition or rehabilitation of breakwaters. As for mounting method, besides an excavator type with undercarriages, two methods (gantry- and fixed-type) are provided.

The work in a salty environment is necessary to prevent corrosion of parts.

Antit-corrosion arrangement is also available.



Specifications

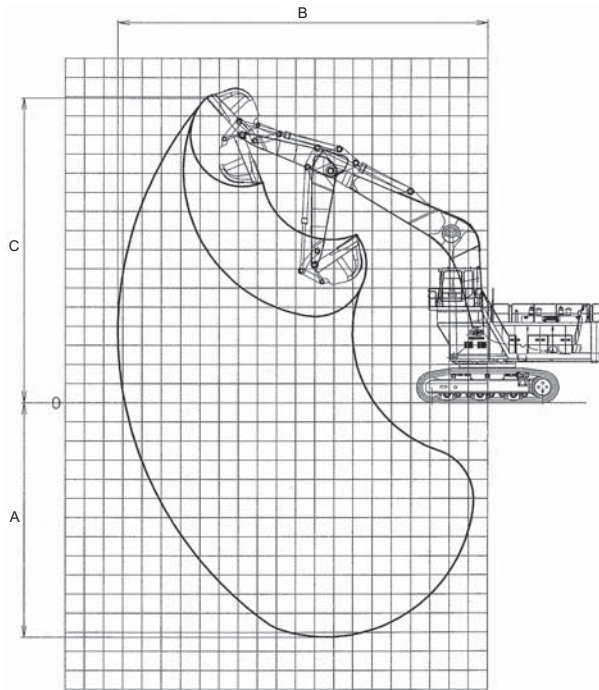

Working Range

		PC600	PC800LC		PC1250		
Boom length	m (ft.in)	7.66 (25'2")	8.2 (26'11")	10 (32'10")	9.1 (29'10")	11 (36'1")	
Arm length	m (ft.in)	5.2 (17'1")	5.6 (18'4")	5.6 (18'4")	5.7 (18'8")	5.7 (18'8")	
Bucket capacity (SAE) *Rock bucket, Heaped	m ³ (cu.yd)	2.0 (2.6)	2.8 (3.7)	2.0 (2.6)	3.4 (4.4)	2.8 (3.7)	
A	Max. digging depth	mm (ft.in)	10,225 (33'7")	10,595 (34'9")	12,170 (39'11")	11,590 (38'0")	12,380 (40'7")
B	Max. digging reach	mm (ft.in)	14,630 (48'0")	15,635 (51'4")	17,505 (57'5")	17,450 (57'3")	18,930 (62'1")
C	Max. digging height	mm (ft.in)	12,560 (41'2")	12,690 (41'8")	13,970 (45'10")	13,910 (45'8")	15,810 (51'10")
	Min. work equipment swing radius	mm (ft.in)	5,510 (18'1")	6,145 (20'2")	7,575 (24'10")	8,150 (26'9")	9,000 (29'6")

* : Material weight up to 1.8t/m³ (3,000 lb/cu.yd)

Sand & Gravel bucket and Soft clay bucket etc. is fitted depend on job conditions.

Heat Resistance Specifications

The works at a steel mill in a high temperature work place, typically a slag yard, is always fraught with various problems and danger like early deterioration and corrosion of parts and ignition

Heat resistance specification are developed to protect machine from those tough working condisions.

PC350 / PC450 Heat resistance specification

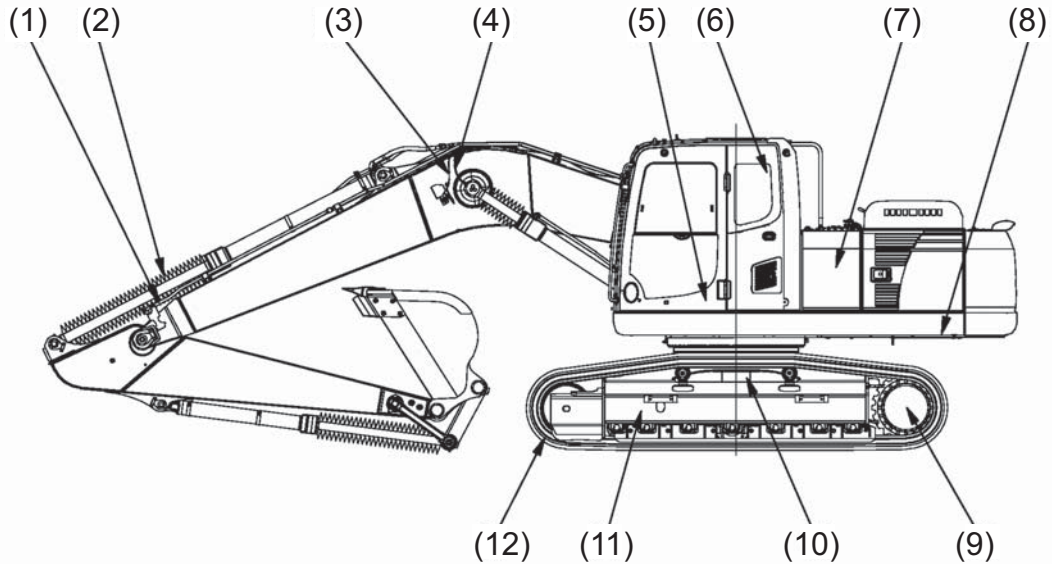

(1) Heat resistance type hydraulic hoses	(7) Heat resistance type fuel hoses
(2) Hydraulic cylinder rod protective cover (boom, arm and bucket)	(8) Revolving frame under guard
(3) Work lamp wiring harness protect by cover wound	(9) Travel motor hydraulic hoses (Heat resistance type)
(4) Heat resistance type greasing hose	(10) Track frame under guard
(5) Heat resistance hoses between boom and machine	(11) Heat resistance type roller's seal (idler, carrier, track rollers and final drive)
(6) Fire extinguisher (equipped inside and outside cab)	(12) Metal type shoe link seal

MEMO

A series of horizontal dashed lines for writing.

CONTENTS

INDEX

SECTION **3**

WHEEL LOADERS Sec 3A

WHEEL DOZERS Sec 3B

SECTION **3A**

WHEEL LOADERS

CONTENTS

Features 3A-2
Specifications 3A-16
Performance Data, Dimensions 3A-27
Performance Curves, Travel Time Charts 3A-134
Definitions 3A-141
Attachment Availability 3A-144
Bucket Features 3A-151
Teeth Features 3A-152
Teeth Features and Teeth Selection 3A-153
Bucket Selection 3A-156
Fork Equipment Features 3A-172
Log-loader Operations 3A-174
Lumber Grapple Specifications 3A-175
Dumping Fork Specifications 3A-176
Lumber Fork Specifications 3A-177
Log Grapple Specifications 3A-178
Logger Performance 3A-179
High Lift Boom Specifications 3A-186
Tire Availability 3A-187
Wheel Loader and Dump Truck Combination ... 3A-190
Production, Loading 3A-195

■ **Excellent productivity**

- Dual hydraulic speed system to reduce cycle time (WA320-WA900, except WA320-3 CUSTOM, WA800-3)
- VOHS (Variable Output Hydraulic System) to reduce cycle time (WA1200)
- High capacity engine with power to spare
The powerful Komatsu engine provides fuel-efficient operation.

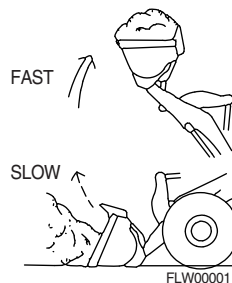

- High breakout force
Z-bar loader linkages are made of high-tensile-strength steel for maximum rigidity and powerful excavation.

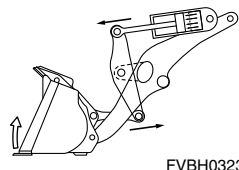

- Modulated clutch allows for selection of drive force and travel speed according to type of work. (WA1200)

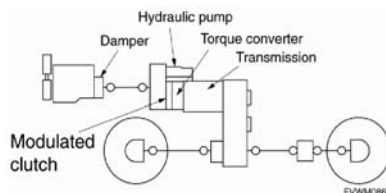

■ **Easy & comfortable operation**

- Light-touch operations
Electrically controlled transmission enables light fingertip control of all direction/gear shifting.
- Use of PPC work equipment control valve

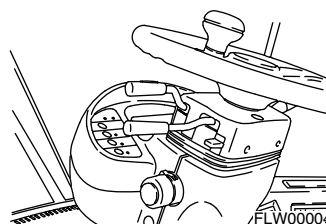

- Faster pile-penetration & scooping
Kick-down switch on the boom control lever facilitates material scooping operation.
- Tiltable steering column & one-glance monitor
Tiltable steering wheel and adjustable seat provide operator comfort and efficiency.

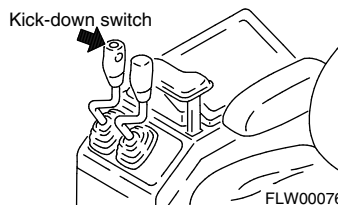

- Low vibration & noise
Komatsu viscous damping mounts reduce unpleasant vibration and noise.

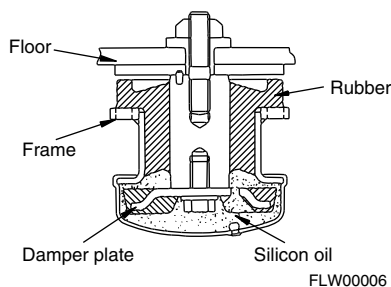

- Easy-to-use with organ-type brake pedal
- Switches centralized in front of operator
- Quick glow automatic preheating system employed



- AJSS (Advanced Joystick Steering System) with light, short strokes for perfect steering accuracy. (WA1200)

■ Easy maintenance and safety

- Gull-wing type side cover
Gull-wing engine side covers facilitate engine access for easy check/replacement of engine oil or filters. (WA320-WA470)

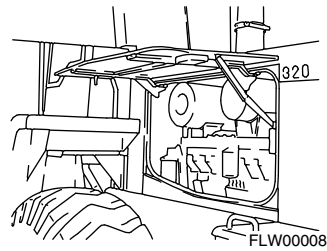

- Fully-sealed wet disc brake
Adjustment-free wet disc brakes ensure braking even on muddy terrain. They are sealed to stay free of dirt and other abrasive contaminants.

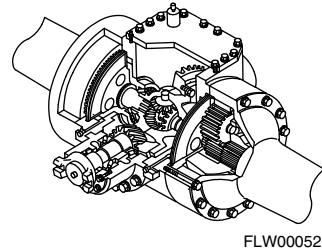

- Wet disc type parking brake
The parking brake prevents the entry of dirt or dust and reduced wear to make the parking brake maintenance free.

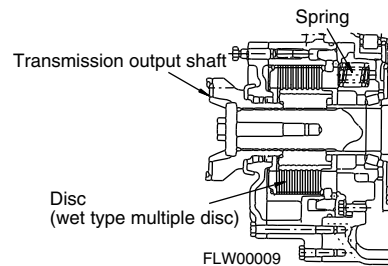

- Electric display panel one unit with steering column
The main monitor and the maintenance monitor (EDIMOS II) are neatly arranged on the instrument panel for a quick, clear reading of machine functions at all times.

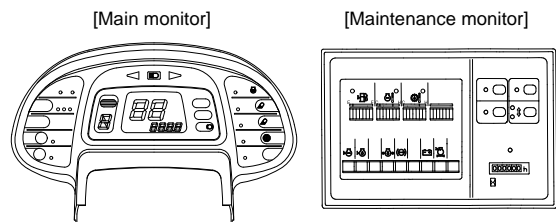

- TMS (Total Management System) & CGC (Color Graphic Console)
TMS connects each controller and sensor to the VHMS (Vehicle Health Monitoring System) controller and displays the condition and management information of the vehicle on the CGC. (WA1200)

- Spin-on type full-flow engine oil filters and fuel filters for easy element replacement.



- Dry type air cleaner with automatic dust evacuator for longer element service.

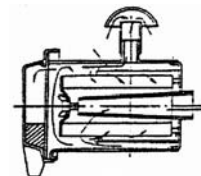

- Sealed loader linkage pins with dust seals and cord rings extend greasing intervals.

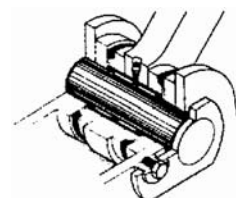

■ Dependable and high-performance components

- High-rigidity frames
Front and rear frames are made as one larger loader class to provide high rigidity for the power train and loader equipment.
The high-rigidity frames, together with the reinforced loader linkage for resist loading stress and shock.
- Torque proportioning differential installed
Torque proportioning differentials minimize slippage, improve traction and increase the service life of tires. (WA320-WA470)
- Dependable braking system
Two independent fully hydraulic brake lines are used for the brake control system.
- High-quality paint
Most exterior plates are treated with a cation electro-deposition undercoat and melamine baked final paint for rust resistance and longer service life.
In addition, some exterior components employ resin.
- Proportional pressure control (PPC): Little effort is required to operate the bucket and boom control levers, assuring smooth, responsive bucket/boom action.
[WA320 and over except WA320-3 CUSTOM]
- Tiltable steering wheel and fully adjustable suspension seat provide maximum operator comfort.
[WA320 and over]
- Hydraulic power steering system guarantees light-touch steering at all times.
- High machine stability is assured by a center-pin-supported rear axle and large oscillation angle that keep the machine level even on the roughest surfaces.
- Automatic bucket positioner assures accurate bucket positioning.
- Boom kick out device facilitates repeated dig-load operations.
[WA320 and over]
- Tire saver controls tire slip and lengthens tire life.
[WA1200]

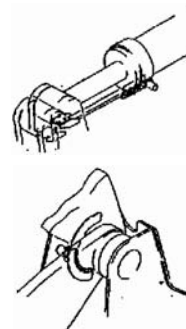
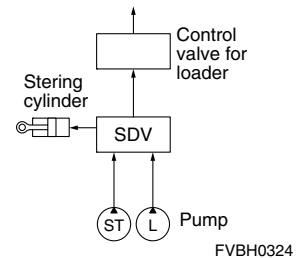
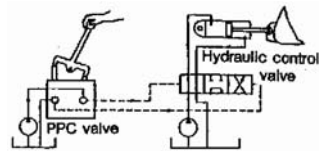
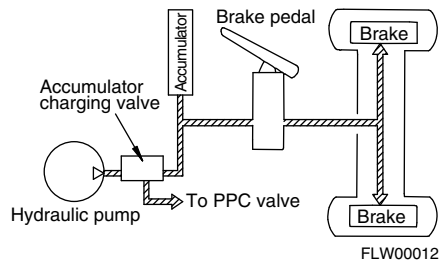
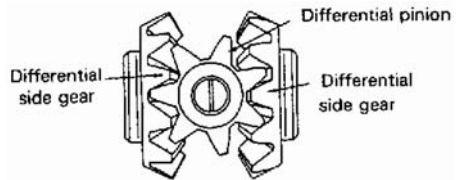
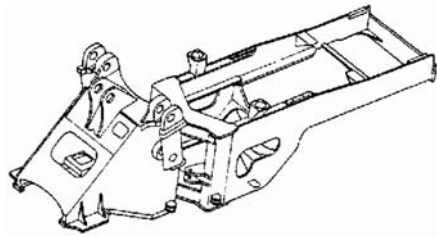

■ **High productivity and low fuel consumption**

● **Dual-mode engine power select system**

- This wheel loader offers two selectable operating modes-Normal and Power.
 - **E mode:** This mode provides maximum fuel efficiency for most of general loading.
 - **P mode:** This mode provides maximum power output for hard digging operation or hill climb.

(WA380-6, WA430-5(-6), WA470-5(-6), WA500-6 and WA600-6)

● **Automatic transmission mode select system**

This operator controlled system allows the operator to select manual shifting or three levels of automatic shifting (low, medium, and high).

(WA380-6, WA430-5(-6), WA470-5(-6), WA500-6 and WA600-6)

● **New dual-speed hydraulic system**

Komatsu's dual-speed hydraulic system increases operational efficiency by matching the hydraulic demands to work conditions.

(Except WA150 – WA320, WA380-6, WA500-6 and WA600-6)

● **Maximum dumping clearance and reach**

The long lift arms provide high dumping clearances and maximum dumping reach. The operator can even level loads on the body of a dump truck easily and efficiently.

● **Long wheelbase/articulation angle of 40°**

The widest tread in class and the long wheelbase provide improved machine stability in both longitudinal and lateral directions. Since the articulation angle is 40°, the operator can work efficiently even in the tightest job sites.

● **Low fuel consumption**

The fuel consumption is reduced greatly because of the low-noise, high-torque engine and the large-capacity torque converter with maximum efficiency in the low-speed range.

■ **Increased reliability**

- **Wet multi-disc brakes and fully hydraulic braking system** mean lower maintenance costs and higher reliability. Wet disc brakes are fully sealed. Contaminants are kept out, reducing wear and resulting maintenance.

Brakes require no adjustments for wear, meaning even lower maintenance. The new parking brake is also an adjustment-free, wet multi-disc for high reliability and long life.

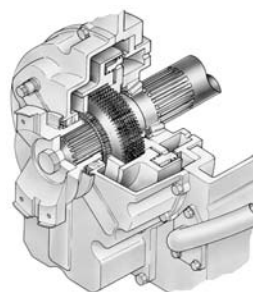
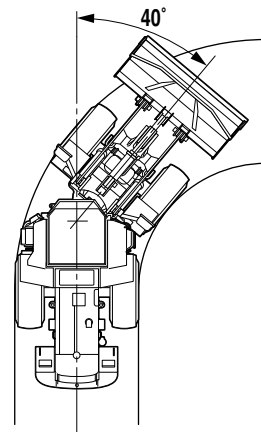
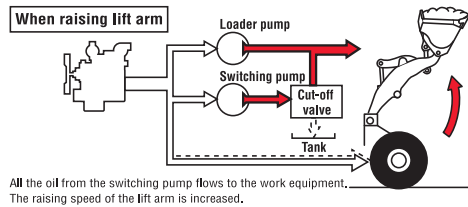
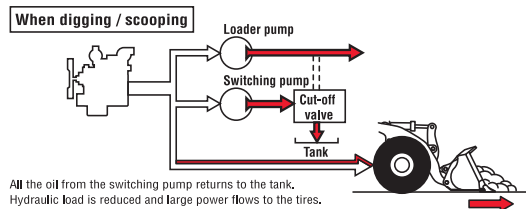

Wet multi-disc brake

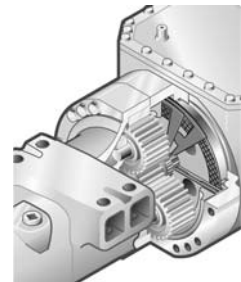

Wet type disc parking brake

- **Hi-rigidity frames**

The front and rear frames have high rigidity to bear twisting and bending loads applied repeatedly to the loader body.

- **Flat face-to-face O-ring seals**

Flat face-to-face O-ring seals are used to securely seal all hydraulic hose connections and to prevent oil leakage. In addition, buffer rings are installed to the head side of the all-hydraulic cylinders to lower the load on the rod seals and maximize the reliability.

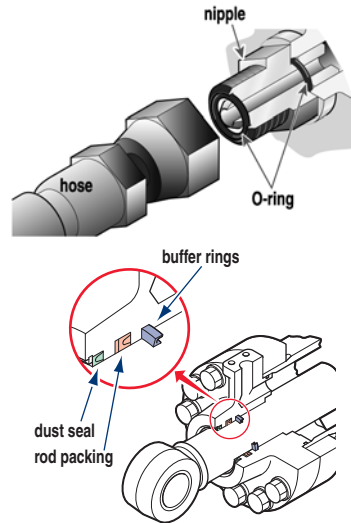

- **Komatsu components**

Komatsu manufactures the engine, torque converter, transmission, hydraulic units, electric parts, and even each bolt on this wheel loader.

- **Cathion Electrodeposition primer paint/ powder coating final paint**

Cathion electrodeposition paint is applied as a primer paint and powder coating is applied as topcoat to the exterior metal sheet parts.

- **Sealed DT connectors**

Main harnesses and controller connectors are equipped with sealed DT connectors providing high reliability, water resistance and dust resistance.

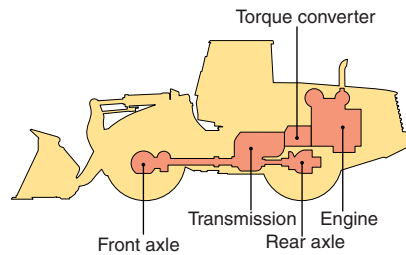

- **Easy maintenance**

- **EMMS (Equipment Management Monitoring System)**

Monitor is mounted in front of the operator for easy view, allowing the operator to easily check gauges and warning lights.

- **Reversible cooling fan and swing-out cooler elements**

If the machine is operating in adverse conditions, the operator can reserve the hydraulic cooling fan from inside the cab by turning on a switch on the control panel.

- **Gull-wing type engine side doors open wide**

The operator can open and close each gull-wing type engine side door easily with the assistance of a gas spring to perform daily service checks from the ground.

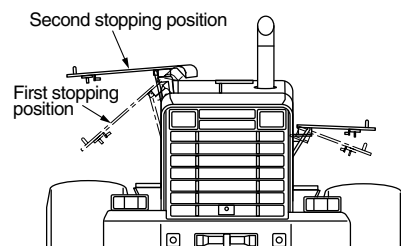
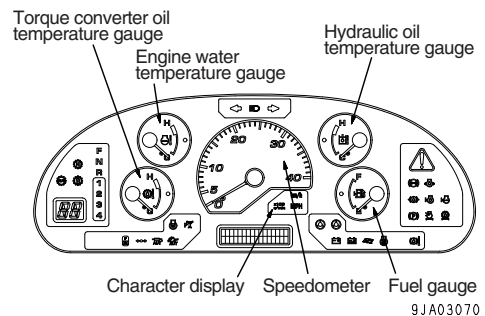

FVW00925

■ Easy & comfortable operation

• **Automatic transmission with ECMV**

Automatic transmission with ECMV automatically selects the proper gear speed based on travel speed, engine speed, and other travel conditions. The ECMV (Electronically Controlled Modulation Valve) system engages the clutch smoothly to prevent lags and shocks when shifting. This system provides efficient machine operation and a comfortable ride.

• **Kick-down switch**

With the touch of a finger, the kick-down switch automatically down shifts from second to first when beginning the digging cycle.

• **Electronically controlled transmission lever**

Easy shifting and directional changes with Komatsu two-lever electronic shifting. Change direction or shift gears with a touch of the fingers without removing the shifting hand from the steering wheel.

• **Variable transmission cut-off**

The operator can adjust the transmission cut-off connected to the left brake pedal with the switch near the operator's seat to set the brake/cut-off point for easier operation and higher operating performance in variable operating conditions.

- High cut-off pressure for digging operations.
- Low cut-off pressure for truck-loading operations.

• **Fingertip work equipment control lever**

New PPC control levers are used for the work equipment. The operator can easily operate the work equipment with fingertip control, reducing operator fatigue and increasing controllability.

• **Low-noise design**

The large cab is mounted with Komatsu's unique ROPS/FOPS viscous mounts. The low-noise engine, hydraulically driven fan, and hydraulic pumps are mounted with rubber cushions, and the cab sealing is improved to provide a quiet, low-vibration, dustproof with pressurizing, and comfortable operating environment.

• **Rear-hinged full open cab door**

The cab door hinges are installed to the rear side of the cab providing a large opening angle for the operator to enter and exit.

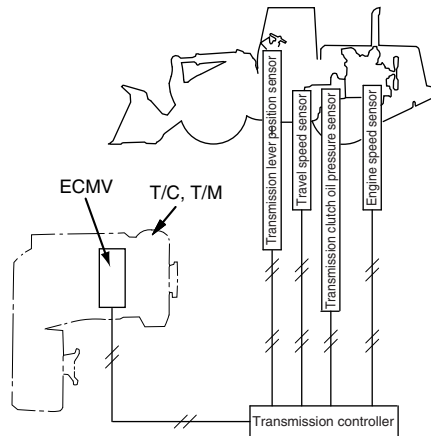

FZW00949

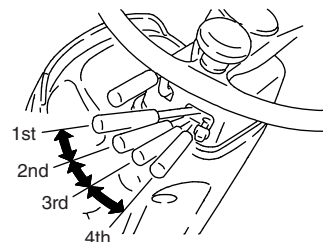

9JM00799

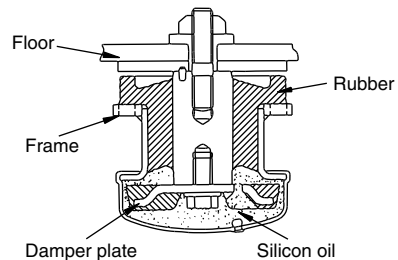

FLW00006

■ **Electronically-controlled HST using a 1-pump, 2-motor system**

- The 1-pump, 2-motor system allows for high-efficiency and high tractive effort. Engine power is transmitted hydraulically to transfer case, then manually out to the differentials and out to the four driving wheels.
- HST provides quick travel response and aggressive drive into the pile. The variable displacement system automatically adjusts to the tractive effort demand to provide maximum power and efficiency.
- Full auto-shifting eliminates any gear shifting and kick-down operation to allow the operator to concentrate on digging and loading.
- When high drive torque is needed for digging, climbing or initiating movement, the pump feeds both motors. This combination makes the loader very aggressive and quick.
- Under deceleration, the HST system acts as a dynamic brake on the mechanical drive system. The dynamic brake can hold the loader in position on most workable slopes. This can be an advantage in stockpiling and ramp loading.
(WA150, WA200/PT, WA250/PT, WA320)

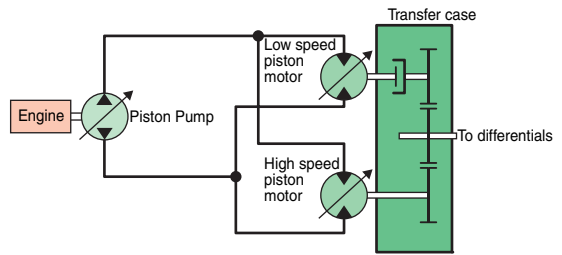

- As the machine moves and gains ground speed, the torque demand decreases and the low speed motor is effectively removed from the drive system by a clutch. At this point, the flow is going to the high-speed motor and the low-speed motor is not causing a drag on the system.
- An inching pedal gives the operator excellent simultaneous control of his travel and equipment hydraulic speeds. By depressing the inching pedal, drive pump flow to the motors will decrease, reducing ground speed and allowing the operator to use his accelerator to increase flow to his equipment hydraulics. Depressing the inching pedal further will activate the service brakes.

■ **Electronically-controlled HST with variable shift control system**

The operator can choose between first, second, third or fourth maximum speeds by dialing the speed range selector switch.

The variable shift switch allows the operator to adjust his machine speed in confined v-loading applications.



(WA150, WA200/PT, WA250/PT, WA320)

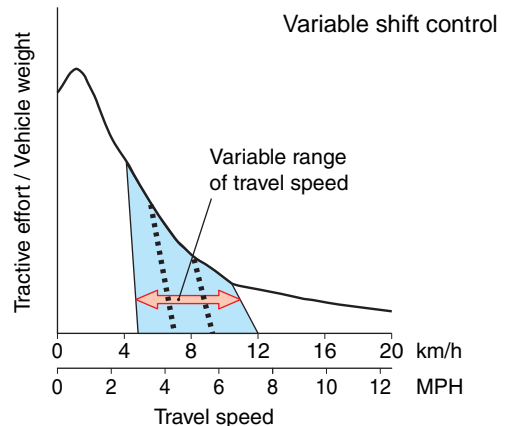

■ Traction control system

In limited traction situations where the operator would like to avoid tire slippage (such as sandy or wet surface operations), he can automatically reduce slippage by activating the traction control feature. Putting the traction control switch in the "ON" position limits the maximum amount of tractive effort.



(WA150, WA200/PT, WA250/PT, WA320-5(-6))

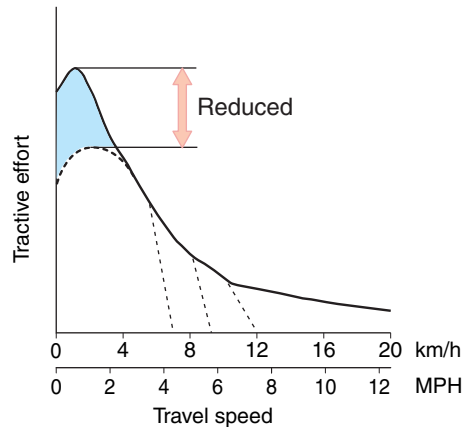

■ Overrun prevention system

When the machine descends a slope of six degrees or less, maximum travel speed is automatically restricted to specified speed, for safety protection against damage of power train components and brakes by sensing the travel speed and controlling the discharge amount of the HST pump and motor. When the machine descends a steep slope and the travel speed reaches specified speed, the caution lamp lights up to inform the operator to reduce the travel speed.

(WA150, WA200/PT, WA250/PT, WA320-5(-6))

■ Automatic transmission with ECMV

Automatic transmission with ECMV automatically selects the proper gear speed based on travel speed, engine speed, and other travel conditions. The ECMV (Electronically Controlled Modulation Valve) system engages the clutch smoothly to prevent lags and shocks when shifting. This system provides efficient machine operation and a comfortable ride.

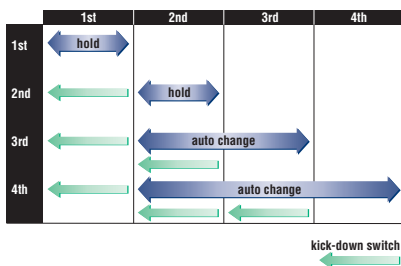

- Kick-down switch: Consider this valuable feature for added productivity. With the touch of a finger, the kick-down switch automatically downshifts from second to first when beginning the digging cycle. It automatically up shifts from first to second when the direction control lever is placed in reverse. This results in increased rim pull for better bucket penetration and reduced cycle times for higher productivity.
- Hold switch: Auto shift is selected and if the operator turns on this switch when the lever is at the 3rd or 4th gear speed position, the transmission is fixed to that gear speed.

(WA380-6, WA430-5(-6), WA470-5(-6), WA480-5(-6), WA500-6, WA600-6)

■ Variable displacement piston pump & CLSS

New design variable displacement piston pump combined with the Closed-center Load Sensing System delivers hydraulic flow just as the job requires preventing wasted hydraulic pressure. Minimized waste loss contributes to better fuel economy.

- **New Variable Displacement Piston Pump:** The pump delivers only necessary amounts minimizing waste loss.

- **Fixed Displacement Piston Pump:** The pump delivers the maximum amount at any time and the unused flow is disposed.

(WA380-6 through WA600-6)

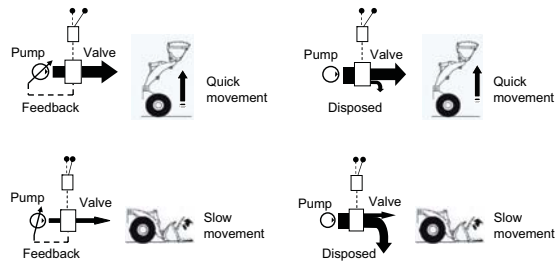

■ Modulated clutch system

The Modulated Clutch System controls the tractive effort with left brake pedal from 100% to 20% of the converter output torque.

(WA600-6)

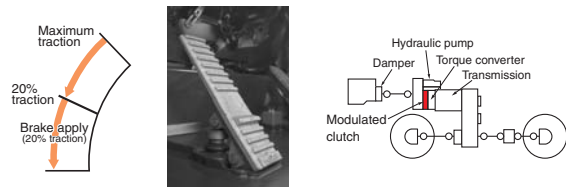

■ Lock-up torque converter

The Komatsu designed lock-up torque converter provides increased production efficiency, reduced cycle times and optimum fuel savings in load & carry or hill-climb operations.

(WA600-6, option for WA500-6)

■ Ecology features

ecot 3 (EPA Tier 3, EU Stage 3A certified engine)

Komatsu develops and produces all major components, such as engines, electronics and hydraulic components in house.

With this "Komatsu Technology", and adding customer feedback, Komatsu is achieving great advancements in technology.

To achieve high levels of productivity and ecology, Komatsu developed the main components with an advanced control system.

The result is a new generation of high performance and environment friendly machines.

(WA200-6 through WA600-6)

■ Variable transmission cut-off

The operator can adjust the transmission cut-off connected to the left brake pedal with the switch near the operator's seat to set the brake/cut-off point for easier operation and higher operating performance in variable operating conditions.

- High cut-off pressure for digging operations.
 - Low cut-off pressure for truck-loading operations.
- (WA380-6, WA430-5, WA470-5, WA480-5, A500-6)

■ Fuel efficient electronic controlled engine

The engine is EPA Tier 3 and EU Stage 3A emission regulation certified. The engine is turbocharged and features Common Rail Injection system and air-to-air aftercooling to maximize power, fuel efficiency and emission compliance. To minimize noise and vibration, the engine is mounted to the main frame with rubber cushions.

VHMS (Vehicle Health Monitoring System) (Option for WA600-6)

VHMS controller monitors the health conditions of major components, enables remote analysis of the machine and its operation. This process is supported by the Komatsu distributors, factory and design team. This contributes to reduced repair costs and to maintaining maximum availability.

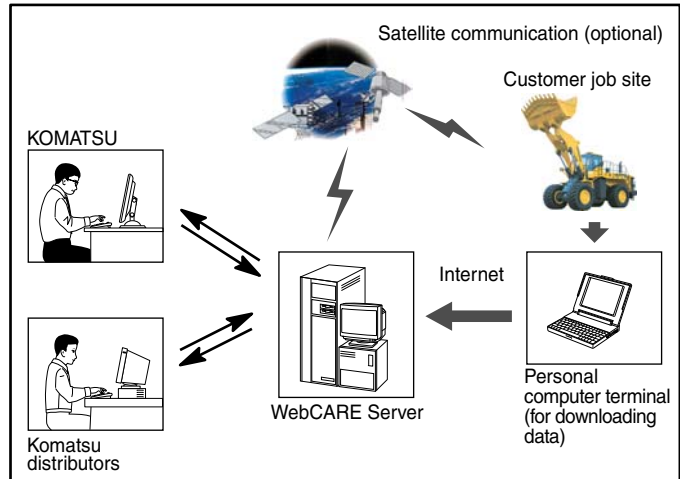

■ Merits of using VHMS

Diagnosis

- Machine health information that used to take approximately 1 hour to be measured can now be downloaded by personal computer in approximately 10 minutes, shortening the vehicle's down time.
- Furthermore, if the satellite communications function is equipped, the machine information can be gathered without stopping the vehicle at all. (Not available in some regions.)

Recommendation

- An appropriate recommendation can be made by viewing these data over the Internet.
 - Proper driving methods
 - Formulation of maintenance plans in advance that suit the customer's production schedule.

Customer's Benefit

- Sudden break down can be prevented through utilization of data trend (change over time).
- Ascertaining the facts and searching for the cause of the breakdown are simplified, thus enabling problems to be resolved quickly.
- Down time can be shortened by the systematic use of Reman components.
- Machine life can be extended significantly by proper operation and proper maintenance.

■ Ecology features

- EPA Tier4 Interim and EU Stage 3B emissions certified engine

Note: For details, see the page of engine features (Section 11)

■ High productivity and low fuel consumption

- Komatsu SmartLoader logic

Komatsu new wheel loaders provide Komatsu SmartLoader Logic, a new engine control system. This technology acquires data from various sensors in the vehicle and controls the engine to yield enough torque for each work phase. Engine torque requirement for a wheel loader varies depending on working conditions. For example, it requires higher torque for digging in V-shape loading, but less torque in driving with an empty bucket. This technology limits the engine torque during less demanding work, therefore saving fuel. Komatsu SmartLoader Logic functions automatically and doesn't interfere with operation, saving fuel without decreasing production.

(WA380-7, WA470-7, WA500-7)

- Large-capacity torque converter

The newly designed power train has a large capacity torque converter for optimum efficiency. Komatsu new wheel loaders have greater productivity in V-shape loading applications because of the increased tractive effort without requiring full throttle. The improved hill climbing ability allows the Komatsu new wheel loaders to up-shift gears faster because of improved acceleration. Komatsu new wheel loaders can achieve higher gear ranges and maintain higher travel speed when working in load-and-carry applications. In most applications, production is increased and fuel consumption reduced, resulting in improved fuel efficiency.

(WA380-7, WA470-7, WA500-7)

- Dual-mode engine power select system

This wheel loader offers two selectable operating modes E and P.

- **E Mode:** This mode provides maximum fuel efficiency for general loading.
- **P Mode:** This mode provides maximum power output for hard digging operation or hill climb.

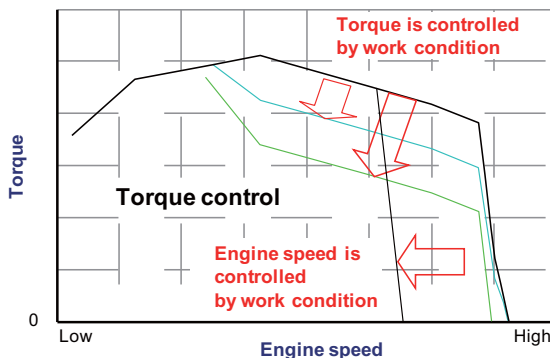

Dual mode engine power selection switch

- Enhanced lock-up

The newly designed large-capacity torque converter with lock-up is standard on Komatsu new wheel loaders, and the lock-up function activates in 2nd, 3rd and 4th gears to give the loader a maximum travel speed of 40 km/h. The large capacity torque converter with the enhanced lock-up is effective for both load and carry application, and V-shape loading which uses lower gears. The enhanced lock-up reduces the clutch engagement shock by controlling engine torque with Komatsu SmartLoader Logic. Lower fuel consumption in load-and-carry applications, and V-shape loading results from the enhanced lock-up + Komatsu SmartLoader Logic.

- ECO guidance

The ECO Guidance provides information on a monitor to help save fuel. The monitor displays messages in real-time during operation and on the exit screen when turning of the key. This function can be controlled through on the monitor. The operator can view fuel consumption through the monitor as well as through KOMTRAX.



User menu for ON/OFF setting



Key OFF



■ **Excellent operator environment**

● **Ergonomic comfort**

Ergonomically designed round dashboard is incorporated. Switches are arranged for easy access.



● **Operator seat with EPC (Electronic Pilot Control) levers**

The EPC lever console is integrated in the seat and moves with it. The angle of the armrest is fully adjustable for optimum operator comfort.



● **Low noise design**

The large cab is mounted with Komatsu's unique ROPS/FOPS viscous mounts. The low-noise engine, hydraulically driven fan, and hydraulic pumps are mounted with rubber cushions, and the cab sealing is improved to provide a quiet, low-vibration, dustproof, and comfortable operating environment.



● **Rear view monitoring system**

The operator can view the rear of the machine with a color monitor screen.



● **Automatic kick-down**

Komatsu new wheel loaders have the function to shift down to F1 automatically. It can be controlled ON/OFF through the monitor.

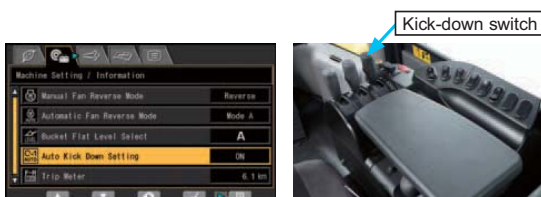

Information & communication technology

Machine monitor

The machine monitor display various machine information and allows for various settings of the machine. The LCD unit is a 7-inch color TFT-LCD and displays maintenance information, operation record, ECO Guidance record, etc. The switch panel is used to select various LCD unit screens and the air conditioner control screen. By using the switch panel, you can display various user menus on the LCD unit screen and perform the settings of the machine.

Machine monitor

- | | |
|---------------------------|---|
| 1 LCD unit | 8 Engine coolant temperature gauge |
| 2 LED unit | 9 Hydraulic oil temperature gauge |
| 3 Engine tachometer | 10 Torque converter oil temperature gauge |
| 4 Speedometer | 11 Fuel gauge |
| 5 ECO gauge | 12 Message pilot lamp |
| 6 Air conditioner display | 13 Pilot lamps |
| 7 Shift indicator | |



Switch panel

- | | |
|--|---------------------|
| 1 Air conditioner switches / Numeral key pad | 2 Function switches |
|--|---------------------|

KOMTRAX

Ecological operation report for assistance

KOMTRAX is Komatsu's remote equipment and fleet monitoring system. Wireless technology and a secure Webbased application gives you the information you need to make the best possible operation and management decisions, from location, actual hour worked, and fuel consumption to maintenance monitoring, abnormality codes, and load frequency, in simple to read and understand reports.

- Guidance to improve fuel consumption
- Ecological operation report.
- Report operation hours by operation mode(E or P mode)
- Service information for Tier 4 Interim (Regeneration, diagnostics information)

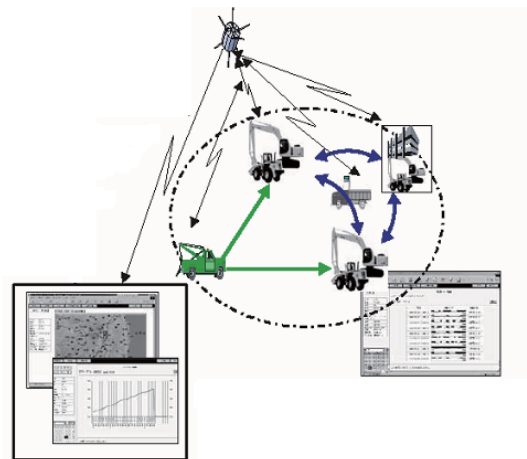

Fuel management by KOMTRAX

In addition to existing items, information to assist fuel saving is provided.

- Average fuel consumption logs
- KDPF infor
- Odometer

Energy-saving operation support report

KOMTRAX provides various useful information which includes the energy-saving operation support report based on the operating information of your machine such as fuel consumption and idle time.

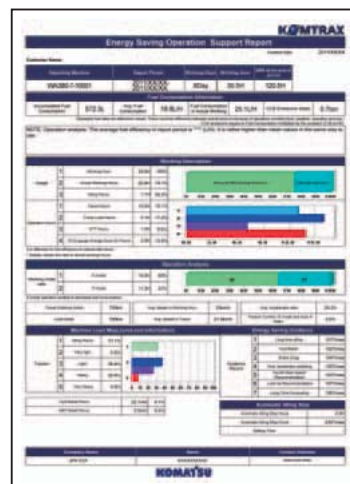

■ Easy maintenance

● Full side-opening gull-wing engine doors

The large gull-wing type engine doors are operated with less power assisted by gas springs. The doors open in two steps. The first position is for daily maintenance and the second position is for periodic maintenance. Large steps are provided on each side of the engine to help access.



● Swing-out type cooling fan for wider core radiator

The fan drive unit swings open for cleaning. It features wider spacing of cooling fins to prevent clogging. Wide core radiator can reduce core clogging.

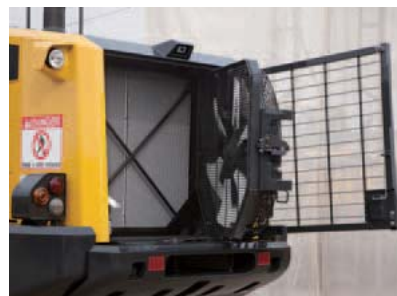

● Auto reversing fan

The engine cooling fan is driven hydraulically. It can be set to operate in reverse automatically. Fan reverse mode can be controlled through the monitor.



● KDPF regeneration

Soot trapped by and accumulated in the KDPF is removed by burning it periodically and automatically.



KDPF regeneration monitor

● Maintenance function

The monitor informs when the replacement interval for oil and filters is reached.



1. Japan sourced models

Item		Model	•WA50-6	WA120-3	•WA150-6	WA150-5
OPERATING WEIGHT*		kg (lb)				
HORSEPOWER	SAE J1995 Gross ISO9249 /SAE J1349 Net Hyd. fan at max. speed Net	kW (HP)/RPM	29.7 (39.8)/2400		74 (99)/2200	
		kW (HP)/RPM kW (HP)/RPM	28.7 (38.6)/2400	63 (85)/2400	73 (98)/2200 71 (95)/2200	71 (96)/2000
BUCKET CAPACITY*		m ³ (cu.yd)				
PERFORMANCE:						
Travel speeds:		km/h (MPH)				
Forward	1st		0-15.0 (9.3)	7.2 (4.5)	5.3-13.0 (3.3-8.1)**	4.6-13.0 (2.9-8.1)**
	2nd			13.6 (8.5)	13.0 (8.1)	13.0 (8.1)
	3rd			34.5 (21.4)	22.4 (13.9)	20.0 (12.4)
	4th				36.2 (22.5)	38.0 (23.6)
Reverse	1st		0-15.0 (9.3)	7.5 (4.7)	5.3-13.0 (3.3-8.1)**	4.6-13.0 (2.9-8.1)**
	2nd			14.0 (8.7)	13.0 (8.1)	13.0 (8.1)
	3rd			35.0 (21.7)	22.4 (13.9)	20.0 (12.4)
	4th				36.2 (22.5)	38.0 (23.6)
Turning radius* (Outside corner of bucket)		mm (ft.in)				
Articulation angle: each dire./end stop		degree	42.5	40	38/40	40
DIMENSIONS*:		mm (ft.in)				
ENGINE:						
Model			KOMATSU 4D88E-6B	KOMATSU S4D102E	KOMATSU SAA4D95LE-5	KOMATSU SAA4D102E-2
No. of cylinders- bore × stroke		mm (in)	4-88 × 90 (3.46 × 3.54)	4-102 × 120 (4.0 × 4.7)	4-95 × 115 (3.74 × 4.53)	4-102 × 120 (4.02 × 4.72)
Piston displacement		ltr. (cu.in)	2.189 (135)	3.92 (239)	3.26 (199)	3.92 (239)
CAPACITY:						
Fuel tank		ltr. (U.S. Gal)	50 (13.2)	133 (35.1)	133 (35.1)	133 (35.1)

Item		Model	WA180-3	•WA200-6	WA200-5	•WA200PZ-6
OPERATING WEIGHT*		kg (lb)				
HORSEPOWER	SAE J1995 Gross ISO9249 /SAE J1349 Net Hyd. fan at max. speed Net	kW (HP)/RPM	82 (110)/2400	95.2 (128)/2000	92 (123)/2000	95.2 (128)/2000
		kW (HP)/RPM kW (HP)/RPM		94 (126)/2000 91 (122)/2000		94 (126)/2000
BUCKET CAPACITY*		m ³ (cu.yd)				
PERFORMANCE:						
Travel speeds:		km/h (MPH)				
Forward	1st		7.2 (4.5)	4.0-13.0 (2.5-8.1)**	4.0-13.0 (2.5-8.1)**	4.4-14.3 (2.7-8.9)**
	2nd		12.0 (7.5)	13.0 (8.1)	13.0 (8.1)	14.3 (8.9)
	3rd		22.0 (13.7)	20.0 (12.4)	20.0 (12.4)	22.0 (13.7)
	4th		34.5 (21.4)	34.5 (21.4)	34.5 (21.4)	38.0 (23.6)
Reverse	1st		7.7 (4.8)	4.4-14.3 (2.7-8.9)**	4.0-13.0 (2.5-8.1)**	4.4-14.3 (2.7-8.9)**
	2nd		12.6 (7.8)	14.3 (8.9)	13.0 (8.1)	14.3 (8.9)
	3rd		22.9 (14.2)	22.0 (13.7)	20.0 (12.4)	22.0 (13.7)
	4th		35.0 (21.7)	38.0 (23.6)	34.5 (21.4)	38.0 (23.6)
Turning radius* (Outside corner of bucket)		mm (ft.in)				
Articulation angle: each dire./end stop		degree	40	38/40	40	38/40
DIMENSIONS*:		mm (ft.in)				
ENGINE:						
Model			KOMATSU S6D102E	KOMATSU SAA4D107E-1	KOMATSU SAA6D102E-2	KOMATSU SAA4D107E-1
No. of cylinders- bore × stroke		mm (in)	6-102 × 120 (4.0 × 4.7)	4-107 × 124 (4.21 × 4.88)	6-102 × 120 (4.02 × 4.72)	4-107 × 124 (4.21 × 4.88)
Piston displacement		ltr. (cu.in)	5.88 (359)	4.46 (272)	5.88 (359)	4.46 (272)
CAPACITY:						
Fuel tank		ltr. (U.S. Gal)	170 (44.9)	177 (46.8)	175 (46.2)	177 (46.8)

* See PERFORMANCE DATA

** 1st speed can be set variably

- EPA Tier 3 and EU Stage 3A model

Item	Model	•WA250-6	WA250-5	•WA250PZ-6	•WA320-6
OPERATING WEIGHT*	kg (lb)				
HORSEPOWER SAE J1995 Gross ISO9249 /SAE J1349 Net Hyd. fan at max. speed Net	kW (HP)/RPM kW (HP)/RPM kW (HP)/RPM	104 (140)/2000 103 (138)/2000 100 (134)/2000	101 (135)/2000	104 (140)/2000 103 (138)/2000	127.3 (171)/2000 125 (167)/2000 117 (156)/2000
BUCKET CAPACITY*	m ³ (cu.yd)				
PERFORMANCE:	km/h (MPH)				
Travel speeds:					
Forward		3.6-11.7 (2.2-7.3)**	3.6-11.7 (2.2-7.3)**	4.0-13.0 (2.5-8.1)**	4.0-13.0 (2.5-8.1)
1st		11.7 (7.3)	11.7 (7.3)	13.0 (8.1)	13.0 (8.1)
2nd		16.2 (10.1)	16.2 (10.1)	18.0 (11.2)	18.7 (11.6)
3rd		34.2 (21.2)	34.2 (21.2)	38.0 (23.6)	38.0 (23.6)
4th					
Reverse		4.0-13.0 (2.5-8.1)**	3.6-11.7 (2.2-7.3)**	4.0-13.0 (2.5-8.1)**	4.0-13.0 (2.5-8.1)
1st		13.0 (8.1)	11.7 (7.3)	13.0 (8.1)	13.0 (8.1)
2nd		18.0 (11.2)	16.2 (10.1)	18.0 (11.2)	18.7 (11.6)
3rd		38.0 (23.6)	34.2 (21.2)	38.0 (23.6)	38.0 (23.6)
4th					
Turning radius* (Outside corner of bucket)	mm (ft.in)				
Articulation angle: each dire./end stop	degree	38/40	40	38/40	38.5/40
DIMENSIONS*:	mm (ft.in)				
ENGINE:					
Model		KOMATSU SAA6D107E-1	KOMATSU SAA6D102E-2	KOMATSU SAA6D107E-1	KOMATSU SAA6D107E-1
No. of cylinders- bore × stroke	mm (in)	6-107 × 124 (4.21 × 4.88)	6-102 × 120 (4.02 × 4.72)	6-107 × 124 (4.21 × 4.88)	6-107 × 124 (4.21 × 4.88)
Piston displacement	ltr. (cu.in)	6.69 (408)	5.88 (359)	6.69 (408)	6.69 (408)
CAPACITY:					
Fuel tank	ltr. (U.S. Gal)	186 (49.1)	184 (48.6)	186 (49.1)	245 (64.7)

Item	Model	WA320-5	WA320-3 CUSTOM	•WA320PZ-6	•WA380-6
OPERATING WEIGHT*	kg (lb)				
HORSEPOWER SAE J1995 Gross ISO9249 /SAE J1349 Net Hyd. fan at max. speed Net	kW (HP)/RPM kW (HP)/RPM kW (HP)/RPM	124 (166)/2000	114 (153)/2350	127.3 (171)/2000 125 (167)/2000 117 (156)/2000	143 (192)/2100 142 (191)/2100 133 (179)/2100
BUCKET CAPACITY*	m ³ (cu.yd)				
PERFORMANCE:	km/h (MPH)				
Travel speeds:					
Forward		4.0-13.0 (2.5-8.1)**	7.5 (4.7)	4.0-13.0 (2.5-8.1)	6.0 (3.7)
1st		13.0 (8.1)	12.0 (7.5)	13.0 (8.1)	10.6 (6.7)
2nd		18.0 (11.2)	21.0 (13.0)	18.7 (11.6)	18.6 (11.6)
3rd		38.0 (23.6)	34.0 (21.1)	38.0 (23.6)	31.1 (19.3)
4th					
Reverse		4.0-13.0 (2.5-8.1)**	7.8 (4.8)	4.0-13.0 (2.5-8.1)	6.5 (4.0)
1st		13.0 (8.1)	12.5 (7.8)	13.0 (8.1)	11.3 (7.0)
2nd		18.0 (11.2)	22.0 (13.7)	18.7 (11.6)	20.2 (12.6)
3rd		38.0 (23.6)	35.0 (21.7)	38.0 (23.6)	34.0 (21.1)
4th					
Turning radius* (Outside corner of bucket)	mm (ft.in)				
Articulation angle: each dire./end stop	degree	40	40	38.5/40	35/40
DIMENSIONS*:	mm (ft.in)				
ENGINE:					
Model		KOMATSU SAA6D102E-2	KOMATSU SA6D102E-2	KOMATSU SAA6D107E-1	KOMATSU SAA6D107E-1
No. of cylinders- bore × stroke	mm (in)	6-102 × 120 (4.02 × 4.72)	6-102 × 120 (4.02 × 4.72)	6-107 × 124 (4.21 × 4.88)	6-107 × 124 (4.21 × 4.88)
Piston displacement	ltr. (cu.in)	5.88 (359)	5.88 (359)	6.69 (408)	6.69 (408)
CAPACITY:					
Fuel tank	ltr. (U.S. Gal)	228 (60.2)	200 (52.8)	245 (64.7)	300 (79.3)

* See PERFORMANCE DATA

** 1st speed can be set variably

• EPA Tier 3 and EU Stage 3A model

Specifications

WHEEL LOADERS

Item		Model	WA380Z-6	WA380-5	WA380-3	•WA430-6	
OPERATING WEIGHT*		kg (lb)					
HORSEPOWER		SAE J1995 Gross ISO9249 /SAE J1349 Net Hyd. fan at max. speed Net	kW (HP)/RPM kW (HP)/RPM kW (HP)/RPM	143 (192)/2100 141 (189)/2100 130 (175)/2100	140 (187)/2000	140 (187)/2200	173 (232)/2100 172 (231)/2100 163 (218)/2100
BUCKET CAPACITY*		m ³ (cu.yd)					
PERFORMANCE:							
Travel speeds:		km/h (MPH)					
Forward		1st	6.6 (4.1)	6.3 (3.9)	7.1 (4.4)	7.0 (4.4)	
		2nd	11.5 (7.1)	11.4 (7.1)	11.4 (7.1)	12.3 (7.6)	
		3rd	20.2 (12.6)	20.2 (12.6)	20.2 (12.6)	21.6 (13.4)	
		4th	34.0 (21.1)	31.5 (19.6)	31.5 (19.6)	37.2 (23.1)	
Reverse		1st	7.1 (4.4)	6.7 (4.2)	7.4 (4.6)	7.6 (4.7)	
		2nd	12.3 (7.6)	11.8 (7.3)	11.8 (7.3)	12.9 (8.0)	
		3rd	21.5 (13.4)	21.0 (13.0)	21.0 (13.0)	23.0 (14.3)	
		4th	35.5 (22.1)	32.5 (20.2)	32.5 (20.2)	37.2 (23.1)	
Turning radius* (Outside corner of bucket)		mm (ft.in)					
Articulation angle: each dire./end stop		degree	35/40	40	40	35/40	
DIMENSIONS*:		mm (ft.in)					
ENGINE:							
Model			KOMATSU SAA6D107E-1	KOMATSU SAA6D114E-2	KOMATSU S6D108-1	KOMATSU SAA6D114E-3	
No. of cylinders- bore × stroke		mm (in)	6-107 × 124 (4.21 × 4.88)	6-114 × 135 (4.49 × 5.31)	6-108 × 130 (4.25 × 5.12)	6-114 × 135 (4.49 × 5.32)	
Piston displacement		ltr. (cu.in)	6.69 (408)	8.27 (505)	7.15 (436)	8.27 (505)	
CAPACITY:							
Fuel tank		ltr. (U.S. Gal)	300 (79.3)	300 (79.3)	287 (75.8)	325 (85.9)	

Item		Model	WA430-5	•WA470-6	WA470-5	WA470-3	
OPERATING WEIGHT*		kg (lb)					
HORSEPOWER		SAE J1995 Gross ISO9249 /SAE J1349 Net Hyd. fan at max. speed Net	kW (HP)/RPM kW (HP)/RPM kW (HP)/RPM	204 (273)/2000 203 (272)/2000 191 (256)/2000	204 (273)/2000 203 (272)/2000 191 (256)/2000	195 (261)/2000	194 (260)/2200
BUCKET CAPACITY*		m ³ (cu.yd)					
PERFORMANCE:							
Travel speeds:		km/h (MPH)					
Forward		1st	6.6 (4.1)	7.6 (4.7)	6.3 (3.9)	6.2 (3.9)	
		2nd	11.5 (7.1)	13.1 (8.1)	12.1 (7.5)	11.2 (7.0)	
		3rd	20.4 (12.7)	22.9 (14.2)	21.7 (13.5)	19.8 (12.3)	
		4th	33.2 (20.6)	36.2 (37.2)	34.9 (21.7)	31.5 (19.6)	
Reverse		1st	7.1 (4.4)	7.9 (4.9)	6.7 (4.2)	6.4 (4.0)	
		2nd	12.3 (7.6)	13.5 (8.4)	12.8 (8.0)	11.7 (7.3)	
		3rd	21.6 (13.4)	23.6 (14.7)	23.0 (14.3)	20.7 (12.9)	
		4th	34.9 (21.7)	37.3 (23.2)	36.0 (22.4)	32.7 (20.3)	
Turning radius* (Outside corner of bucket)		mm (ft.in)					
Articulation angle: each dire./end stop		degree	40	35/40	40	40	
DIMENSIONS*:		mm (ft.in)					
ENGINE:							
Model			KOMATSU SAA6D125E-3	KOMATSU SAA6D125E-5	KOMATSU SAA6D125E-3	KOMATSU S6D125-1	
No. of cylinders- bore × stroke		mm (in)	6-125 × 150 (4.92 × 5.91)	6-125 × 150 (4.92 × 5.91)	6-125 × 150 (4.92 × 5.91)	6-125 × 150 (4.92 × 5.91)	
Piston displacement		ltr. (cu.in)	11.04 (674)	11.04 (674)	11.04 (674)	11.04 (674)	
CAPACITY:							
Fuel tank		ltr. (U.S. Gal)	343 (90.6)	413 (109.1)	390 (103.0)	400 (105.7)	

- * See PERFORMANCE DATA
- EPA Tier 3 and EU Stage 3A model

Item	Model	*WA480-6	*WA500-6	WA500-6R	WA500-3
OPERATING WEIGHT*	kg (lb)				
HORSEPOWER SAE J1995 Gross ISO9249 /SAE J1349 Net Hyd. fan at max. speed Net	kW (HP)/RPM kW (HP)/RPM kW (HP)/RPM	224 (300)/2000 223 (299)/2000 211 (283)/2000	266 (357)/1900 263 (353)/1900 248 (332)/1900	266 (357)/1900 263 (353)/1900 248 (332)/1900	235 (315)/2100
BUCKET CAPACITY*	m ³ (cu.yd)				
PERFORMANCE:	km/h (MPH)				
Travel speeds:					
Forward					
1st		7.7 (4.8)	7.7 (4.8)	7.7 (4.8)	6.7 (4.2)
2nd		13.1 (8.1)	12.5 (7.8)	12.5 (7.8)	12.0 (7.5)
3rd		22.9 (14.2)	22.3 (13.9)	22.3 (13.9)	20.2 (12.6)
4th		36.3 (22.6)	34.9 (21.7)	34.9 (21.7)	33.0 (20.5)
Reverse					
1st		7.9 (4.9)	8.6 (5.3)	8.6 (5.3)	7.5 (4.7)
2nd		13.5 (8.4)	13.0 (8.1)	13.0 (8.1)	13.4 (8.3)
3rd		23.6 (14.7)	24.8 (15.4)	24.8 (15.4)	22.5 (14.0)
4th		37.4 (23.2)	37.5 (23.3)	36.5 (22.7)	36.1 (22.4)
Turning radius* (Outside corner of bucket)	mm (ft.in)				
Articulation angle: each dire./end stop	degree	35/40	40	40	40
DIMENSIONS*:	mm (ft.in)				
ENGINE:					
Model		KOMATSU SAA6D125E-5	KOMATSU SAA6D140E-5	KOMATSU SAA6D140E-5	KOMATSU SA6D140E-3
No. of cylinders- bore × stroke	mm (in)	6-125 × 150 (4.92 × 5.91)	6-140 × 165 (5.51 × 6.50)	6-140 × 165 (5.51 × 6.50)	6-140 × 165 (5.51 × 6.50)
Piston displacement	ltr. (cu.in)	11.04 (674)	15.24 (930)	15.24 (930)	15.24 (930)
CAPACITY:					
Fuel tank	ltr. (U.S. Gal)	413 (109.1)	473 (124.9)	473 (124.9)	450 (118.9)

Item	Model	*WA600-6	WA600-6R	WA600-3	WA700-3
OPERATING WEIGHT*	kg (lb)				
HORSEPOWER SAE J1995 Gross ISO9249 /SAE J1349 Net Hyd. fan at max. speed Net	kW (HP)/RPM kW (HP)/RPM kW (HP)/RPM	396 (530)/1800 393 (527)/1800 374 (502)/1900	396 (530)/1800 393 (527)/1800 374 (502)/1800	357 (478)/2000	502 (672)/2000
BUCKET CAPACITY*	m ³ (cu.yd)				
PERFORMANCE:	km/h (MPH)				
Travel speeds:					
Forward					
1st		6.7 (4.2)	6.7 (4.2)	6.4 (4.0)	6.4 (4.0)
2nd		11.7 (7.3)	11.7 (7.3)	11.1 (6.9)	11.1 (6.9)
3rd		20.3 (12.6)	20.3 (12.6)	18.8 (11.7)	18.7 (11.6)
4th		33.8 (21.0)	33.8 (21.0)	30.3 (18.8)	30.0 (18.6)
Reverse					
1st		7.3 (4.5)	7.3 (4.5)	7.1 (4.4)	7.1 (4.4)
2nd		12.8 (8.0)	12.8 (8.0)	12.2 (7.6)	12.3 (7.6)
3rd		22.0 (13.7)	22.0 (13.7)	20.5 (12.7)	20.5 (12.7)
4th		37.0 (23.0)	37.0 (23.0)	32.7 (20.3)	32.3 (20.1)
Turning radius* (Outside corner of bucket)	mm (ft.in)				
Articulation angle: each dire./end stop	degree	43	43	43	40
DIMENSIONS*:	mm (ft.in)				
ENGINE:					
Model		KOMATSU SAA6D170E-5	KOMATSU SAA6D170E-5	KOMATSU SAA6D170E-3	KOMATSU SAA6D170E-3
No. of cylinders- bore × stroke	mm (in)	6-170 × 170 (6.69 × 6.69)	6-170 × 170 (6.69 × 6.69)	6-170 × 170 (6.69 × 6.69)	6-170 × 170 (6.69 × 6.69)
Piston displacement	ltr. (cu.in)	23.15 (1413)	23.15 (1413)	23.15 (1413)	23.15 (1413)
CAPACITY:					
Fuel tank	ltr. (U.S. Gal)	718 (189.7)	718 (189.7)	670 (177)	1100 (290.6)

* See PERFORMANCE DATA
 • EPA Tier 3 and EU Stage 3A model

Item	Model	WA800-3E0	WA800-3	WA900-3E0	WA900-3
OPERATING WEIGHT*	kg (lb)				
HORSEPOWER SAE J1995 Gross ISO9249 /SAE J1349 Net Hyd. fan at max. speed Net	kW (HP)/RPM kW (HP)/RPM kW (HP)/RPM	636 (853)/2000 603 (808)/2000	603 (808)/2000	672 (900)/2050 638 (856)/2000	637 (853)/2000
BUCKET CAPACITY*	m ³ (cu.yd)				
PERFORMANCE:					
Travel speeds:	km/h (MPH)				
Forward 1st		7.0 (4.3)	7.0 (4.3)	7.0 (4.3)	7.0 (4.3)
2nd		12.3 (7.6)	12.3 (7.6)	12.3 (7.6)	12.3 (7.6)
3rd		28.0 (17.4)	28.0 (17.4)	28.0 (17.4)	28.0 (17.4)
4th					
Reverse 1st		7.1 (4.4)	7.1 (4.4)	7.1 (4.4)	7.1 (4.4)
2nd		12.4 (7.7)	12.4 (7.7)	12.4 (7.7)	12.4 (7.7)
3rd		28.3 (17.6)	28.3 (17.6)	28.3 (17.6)	28.3 (17.6)
4th					
Turning radius* (Outside corner of bucket)	mm (ft.in)				
Articulation angle: each dire./end stop	degree	40	40	40	40
DIMENSIONS*:	mm (ft.in)				
ENGINE:					
Model		KOMATSU SAA12V140E-3	KOMATSU SA12V140-1	KOMATSU SAA12V140E-3	KOMATSU SA12V140-1
No. of cylinders- bore × stroke	mm (in)	12-140 × 165 (5.51 × 6.50)	12-140 × 165 (5.51 × 6.50)	12-140 × 165 (5.51 × 6.50)	12-140 × 165 (5.51 × 6.50)
Piston displacement	ltr. (cu.in)	30.5 (1,861)	30.5 (1,861)	30.5 (1,861)	30.5 (1,861)
CAPACITY:					
Fuel tank	ltr. (U.S. Gal)	1555 (410.8)	1425 (376.5)	1555 (410.8)	1430 (377.8)

Item	Model	WA1200-6			
OPERATING WEIGHT*	kg (lb)				
HORSEPOWER SAE J1995 Gross ISO9249 /SAE J1349 Net Hyd. fan at max. speed Net	kW (HP)/RPM kW (HP)/RPM kW (HP)/RPM	1411 (1892)/1800 1316 (1765)/1800			
BUCKET CAPACITY*	m ³ (cu.yd)				
PERFORMANCE:					
Travel speeds:	km/h (MPH)				
Forward 1st		6.1 (3.8)			
2nd		11.1 (6.9)			
3rd		18.7 (11.6)			
4th					
Reverse 1st		6.3 (3.9)			
2nd		11.4 (7.1)			
3rd		19.3 (12.0)			
4th					
Turning radius* (Outside corner of bucket)	mm (ft.in)				
Articulation angle: each dire./end stop	degree	40			
DIMENSIONS*:	mm (ft.in)				
ENGINE:					
Model		KOMATSU SSDA16V160E-2			
No. of cylinders- bore × stroke	mm (in)	16-159 × 190 (6.26 × 7.48)			
Piston displacement	ltr. (cu.in)	60.0 (3661)			
CAPACITY:					
Fuel tank	ltr. (U.S. Gal)	5100 (1347)			

* See PERFORMANCE DATA

2. USA sourced models

Item	Model	•WA150-6***	•WA200-6***	WA200PZ-6***	•WA250-6***
OPERATING WEIGHT*	kg (lb)				
HORSEPOWER SAE J1995 Gross ISO9249 /SAE J1349 Net Hyd. fan at max. speed Net	kW (HP)/RPM	74 (99)/2200	95.2 (128)/2000	95.2 (128)/2000	104 (140)/2000
	kW (HP)/RPM	73 (98)/2200	94 (126)/2000	94 (126)/2000	103 (138)/2000
	kW (HP)/RPM	71 (95)/2200	91 (122)/2000		100 (134)/2000
BUCKET CAPACITY*	m ³ (cu.yd)				
PERFORMANCE:					
Travel speeds:	km/h (MPH)				
Forward 1st		5.5-13.6 (3.4-8.5)**	4.4-14.3 (2.7-8.9)**	4.4-14.3 (2.7-8.9)**	4.0-13.0 (2.5-8.1)**
2nd		13.6 (8.5)	14.3 (8.9)	14.3 (8.9)	13.0 (8.1)
3rd		23.5 (14.6)	22.0 (13.9)	22.0 (13.9)	18.0 (11.2)
4th		38.0 (23.6)	38.0 (23.6)	38.0 (23.6)	38.0 (23.6)
Reverse 1st		5.5-13.6 (3.4-8.5)**	4.4-14.3 (2.7-8.9)**	4.4-14.3 (2.7-8.9)**	4.0-13.0 (2.5-8.1)**
2nd		13.6 (8.5)	14.3 (8.9)	14.3 (8.9)	13.0 (8.1)
3rd		23.5 (14.6)	22.0 (13.7)	22.0 (13.7)	18.0 (11.2)
4th		38.0 (23.6)	38.0 (23.6)	38.0 (23.6)	38.0 (23.6)
Turning radius* (Outside corner of bucket)	mm (ft.in)				
Articulation angle: each dire./end stop	degree	38/40	38/40	38/40	38/40
DIMENSIONS*:	mm (ft.in)				
ENGINE:					
Model		KOMATSU SAA4D95LE-5	KOMATSU SAA4D107E-1	KOMATSU SAA4D107E-1	KOMATSU SAA6D107E-1
No. of cylinders- bore × stroke	mm (in)	4-95 × 115 (3.74 × 4.53)	4-107 × 124 (4.21 × 4.88)	4-107 × 124 (4.21 × 4.88)	6-107 × 124 (4.21 × 4.88)
Piston displacement	ltr. (cu.in)	3.26 (199)	4.46 (272)	4.46 (272)	6.69 (408)
CAPACITY:					
Fuel tank	ltr. (U.S. Gal)	133 (35.1)	177 (46.8)	177 (46.8)	186 (49.1)

Item	Model	•WA250PZ-6***	•WA320-6*4	•WA320PZ-6***	○WA380-7*4
OPERATING WEIGHT*	kg (lb)				
HORSEPOWER SAE J1995 Gross ISO9249 /SAE J1349 Net Hyd. fan at max. speed Net	kW (HP)/RPM	104 (140)/2000	127.3 (171)/2000	127.3 (171)/2000	143 (192)/2100
	kW (HP)/RPM	103 (138)/2000	125 (167)/2000	125 (167)/2000	142 (191)/2100
	kW (HP)/RPM	100 (134)/2000	117 (156)/2000	117 (156)/2000	
BUCKET CAPACITY*	m ³ (cu.yd)				
PERFORMANCE:					
Travel speeds:	km/h (MPH)				
Forward 1st		4.0-13.0 (2.5-8.1)**	4.0-13.0 (2.5-8.1)**	4.0-13.0 (2.5-8.1)	6.6 (4.1)
2nd		13.0 (8.1)	13.0 (8.1)	13.0 (8.1)	11.7 (7.3)
3rd		18.0 (11.2)	18.7 (11.6)	18.7 (11.6)	20.9 (13.0)
4th		38.0 (23.6)	38.0 (23.6)	38.0 (23.6)	36.1 (22.4)
Reverse 1st		4.0-13.0 (2.5-8.1)**	4.0-13.0 (2.5-8.1)**	4.0-13.0 (2.5-8.1)	7.1 (4.4)
2nd		13.0 (8.1)	13.0 (8.1)	13.0 (8.1)	12.4 (7.7)
3rd		18.0 (11.2)	18.6 (11.6)	18.7 (11.6)	22.3 (13.9)
4th		38.0 (23.6)	38.0 (23.6)	38.0 (23.6)	38.6 (24.0)
Turning radius* (Outside corner of bucket)	mm (ft.in)				
Articulation angle: each dire./end stop	degree	38/40	38.5/40	38.5/40	35/40
DIMENSIONS*:	mm (ft.in)				
ENGINE:					
Model		KOMATSU SAA6D107E-1	KOMATSU SAA6D107E-1	KOMATSU SAA6D107E-1	KOMATSU SAA6D107E-2
No. of cylinders- bore × stroke	mm (in)	6-107 × 124 (4.21 × 4.88)	6-107 × 124 (4.21 × 4.88)	6-107 × 124 (4.21 × 4.88)	6-107 × 124 (4.21 × 4.88)
Piston displacement	ltr. (cu.in)	6.69 (408)	6.69 (408)	6.69 (408)	6.69 (408)
CAPACITY:					
Fuel tank	ltr. (U.S. Gal)	186 (49.1)	245 (64.7)	245 (64.7)	300 (79.3)

- * See PERFORMANCE DATA
- ** 1st speed can be set variably
- *** For USA
- *4 USA source
- EPA Tier 3 and EU Stage 3A model
- EPA Tier 4 and EU Stage 3B model

Specifications

WHEEL LOADERS

Item	Model	●WA430-6* ⁴	○WA470-7* ⁴	●WA480-6* ⁴	○WA500-7* ⁴
OPERATING WEIGHT*	kg (lb)				
HORSEPOWER SAE J1995 Gross ISO9249 /SAE J1349 Net Hyd. fan at max. speed Net	kW (HP)/RPM	173 (232)/2100	204 (273)/2000	224 (300)/2000	266 (357)/1900
	kW (HP)/RPM	172 (231)/2100	203 (272)/2000	223 (299)/2000	263 (353)/1900
	kW (HP)/RPM	163 (218)/2100	194 (260)/2000	211 (283)/2000	250 (335)/1900
BUCKET CAPACITY*	m ³ (cu.yd)				
PERFORMANCE:					
Travel speeds:	km/h (MPH)				
Forward					
1st	7.0 (4.4)	7.6 (4.7)	7.7 (4.8)	7.5 (4.7)	
2nd	12.3 (7.6)	13.1 (8.1)	13.1 (8.1)	12.9 (8.0)	
3rd	21.6 (13.4)	22.9 (14.2)	22.9 (14.2)	22.2 (13.8)	
4th	37.2 (23.1)	36.2 (22.5)	36.3 (22.6)	35.5 (22.1)	
Reverse					
1st	7.6 (4.7)	7.9 (4.9)	7.9 (4.9)	8.5 (5.3)	
2nd	12.9 (8.0)	13.5 (8.4)	13.5 (8.4)	12.9 (8.0)	
3rd	23.6 (14.3)	23.6 (14.7)	23.6 (14.7)	24.7 (15.3)	
4th	37.2 (23.1)	37.3 (23.2)	37.4 (23.2)	38.0 (23.6)	
Turning radius* (Outside corner of bucket)	mm (ft.in)				
Articulation angle: each dire./end stop	degree	35/40	35/40	35/40	36/40
DIMENSIONS*:	mm (ft.in)				
ENGINE:					
Model		KOMATSU SAA6D114E-3	KOMATSU SAA6D125E-6	KOMATSU SAA6D125E-5	KOMATSU SAA6D140E-6
No. of cylinders- bore × stroke	mm (in)	6-114 × 135 (4.49 × 5.31)	6-125 × 150 (4.92 × 5.91)	6-125 × 150 (4.92 × 5.91)	6-140 × 165 (5.51 × 6.50)
Piston displacement	ltr. (cu.in)	8.27 (505)	11.04 (674)	11.04 (674)	15.24 (930)
CAPACITY:					
Fuel tank	ltr. (U.S. Gal)	325 (85.9)	380 (100)	413 (109.1)	473 (125)

* See PERFORMANCE DATA

*⁴ USA source

*⁵ With large-capacity torque converter

● EPA Tier 3 and EU Stage 3A model

○ EPA Tier 4 and EU Stage 3B model

3. Germany sourced models

Item	Model	•WA65-6	•WA70-6	•WA80-6	•WA90-6
OPERATING WEIGHT*	kg (lb)				
HORSEPOWER SAE J1995 Gross ISO9249 /SAE J1349 Net Hyd. fan at max. speed Net	kW (HP)/RPM kW (HP)/RPM kW (HP)/RPM	40 (53.6)/2350	45 (60.3)/2350	50 (67.0)/2270	59 (79.1)/2350
BUCKET CAPACITY*	m ³ (cu.yd)				
PERFORMANCE: Travel speeds:	km/h (MPH)				
Forward		5.0 (3.1) 20.0 (12.4)	5.0 (3.1) 20.0 (12.4)	4.5 (2.8) 20.0 (12.4)	6.0 (3.7) 20.0 (12.4)
Reverse		5.0 (3.1) 20.0 (12.4)	5.0 (3.1) 20.0 (12.4)	4.5 (2.8) 20.0 (12.4)	6.0 (3.7) 20.0 (12.4)
Turning radius* (Outside corner of bucket)	mm (ft.in)				
Articulation angle: each dire./end stop	degree	40	40	42	40
DIMENSIONS*:	mm (ft.in)				
ENGINE: Model		KOMATSU 4D95LWE-5	KOMATSU 4D95LWE-5	KOMATSU S4D95LWE-5	KOMATSU SAA4D95LE-5
No. of cylinders- bore × stroke	mm (in)	4-95 × 115 (3.74 × 4.53)	4-95 × 115 (3.74 × 4.53)	4-95 × 115 (3.74 × 4.53)	4-95 × 115 (3.74 × 4.53)
Piston displacement	ltr. (cu.in)	3.3 (201)	3.3 (201)	3.3 (201)	3.3 (201)
CAPACITY: Fuel tank	ltr. (U.S. Gal)	132 (34.9)	132 (34.9)	140 (37.0)	140 (37.0)

Item	Model	•WA100M-6	•WA150PZ-6*4	•WA200PZ-6	•WA250PZ-6
OPERATING WEIGHT*	kg (lb)				
HORSEPOWER SAE J1995 Gross ISO9249 /SAE J1349 Net Hyd. fan at max. speed Net	kW (HP)/RPM kW (HP)/RPM kW (HP)/RPM	66 (88.5)/2350	73 (98)/2200	94 (126)/2000	103 (138)/2000
BUCKET CAPACITY*	m ³ (cu.yd)				
PERFORMANCE: Travel speeds:	km/h (MPH)				
Forward		5.0 (3.1)/6.6 (4.1)*** 20.0 (12.4)/30.0 (18.6)	5.5-13.6 (3.4-8.5)** 13.6 (8.5) 23.5 (14.6) 38.0 (23.6)	4.4-14.3 (2.7-8.9)** 14.3 (8.9) 22.0 (13.7) 38.0 (23.6)	4.0-13.0 (2.5-8.1)*** 13.0 (8.1) 18.0 (11.2) 38.0 (23.6)
Reverse		5.0 (3.1)/6.6 (4.1) 20.0(12.4)/30.0 (18.6)	5.5-13.6 (3.4-8.5) 13.6 (8.5) 23.5 (14.6) 38.0 (23.6)	4.4-14.3 (2.7-8.9)** 14.3 (8.9) 22.0 (13.7) 38.0 (23.6)	4.0-13.0 (2.5-8.1)*** 13.0 (8.1) 18.0 (11.2) 38.0 (23.6)
Turning radius* (Outside corner of bucket)	mm (ft.in)				
Articulation angle: each dire./end stop	degree	42	40	40	40
DIMENSIONS*:	mm (ft.in)				
ENGINE: Model		KOMATSU SAA4D95LE-5	KOMATSU SAA4D95LE-5	KOMATSU SAA4D107E-1	KOMATSU SAA6D107E-1
No. of cylinders- bore × stroke	mm (in)	4-95 × 115 (3.74 × 4.53)	4-95 × 115 (3.74 × 4.53)	4-107 × 124 (4.21 × 4.88)	6-107 × 124 (4.21 × 4.85)
Piston displacement	ltr. (cu.in)	3.26 (199)	3.26 (199)	4.46 (272)	6.69 (408)
CAPACITY: Fuel tank	ltr. (U.S. Gal)	140 (37.0)	133 (35.1)	177 (46.8)	186 (49.1)

* See PERFORMANCE DATA
 ** 1st speed can be set variably
 *** 20 km/h version / 30 km/h version
 *4 for EU
 • EPA Tier 3 and EU Stage 3A model

Item	Model	•WA320-6	•WA320PZ-6	○WA380-7***	•WA380-6
OPERATING WEIGHT*	kg (lb)				
HORSEPOWER SAE J1995 Gross ISO9249 /SAE J1349 Net Hyd. fan at max. speed Net	kW (HP)/RPM kW (HP)/RPM kW (HP)/RPM	125 (167)/2000	125 (167)/2000	142 (191)/2100	142 (191)/2100
BUCKET CAPACITY*	m ³ (cu.yd)				
PERFORMANCE:					
Travel speeds:	km/h (MPH)				
Forward		4-13 (2.5-8.1)**	4-13 (2.5-8.1)**	6.6 (4.1)/-	6.6 (4.1)
1st		13 (8.1)	13 (8.1)	11.7 (7.3)/12.4 (7.7) ^{*4}	11.5 (7.1)
2nd		19 (11.8)	19 (11.8)	20.9 (13)/22.5 (14) ^{*4}	20.2 (12.3)
3rd		38 (23.6)	38 (23.6)	36.1(22.4)/40 (25) ^{*4}	33.5 (20.8)
4th				7.1 (4.4)/-	7.1 (2.8)
Reverse		4-13 (2.5-8.1)**	4-13 (2.5-8.1)**	12.4 (7.4)/ 13.3 (8.3) ^{*4}	12.3 (7.6)
1st		13 (8.1)	13 (8.1)	22.3(13.9)/24.1(15) ^{*4}	21.5 (13.4)
2nd		19 (11.8)	19 (11.8)	38.6 (24)/40 (24.9) ^{*4}	39.0 (24.2)
3rd		38 (23.6)	38 (23.6)		
4th					
Turning radius* (Outside corner of bucket)	mm (ft.in)				
Articulation angle: each dire./end stop	degree	40	40	40	40
DIMENSIONS*:	mm (ft.in)				
ENGINE:					
Model		KOMATSU SAA6D107E-1	KOMATSU SAA6D107E-1	KOMATSU SAA6D107E-2	KOMATSU SAA6D107E-1
No. of cylinders- bore × stroke	mm (in)	6-107 × 124 (4.21 × 4.88)	6-107 × 124 (4.21 × 4.88)	6-107 × 124 (4.21 × 4.88)	6-107 × 124 (4.21 × 4.88)
Piston displacement	ltr. (cu.in)	6.69 (408)	6.69 (408)	6.69 (408)	6.69 (408)
CAPACITY:					
Fuel tank	ltr. (U.S. Gal)	245 (64.7)	245 (64.7)	300 (79.3)	300 (79.3)

Item	Model	•WA430-6	•WA470-6 ^{*5}	•WA480-6 ^{*5}	○WA500-7***
OPERATING WEIGHT*	kg (lb)				
HORSEPOWER SAE J1995 Gross ISO9249 /SAE J1349 Net Hyd. fan at max. speed Net	kW (HP)/RPM kW (HP)/RPM kW (HP)/RPM	173 (232)/2000	203 (272)/2000	223 (299)/2000	263 (353)/1900
BUCKET CAPACITY*	m ³ (cu.yd)				
PERFORMANCE:					
Travel speeds:	km/h (MPH)				
Forward		6.8 (4.2)	7.6 (4.7)	7.6 (4.7)	7.5 (4.7)/-
1st		12.4 (7.7)	13.2 (8.2)	13.2 (8.2)	12.9 (8.0)/13.1 (8.1) ^{*4}
2nd		21.5 (13.4)	22.7 (14.1)	22.7 (14.1)	22.2 (13.8)/23.7 (14.7) ^{*4}
3rd		35.0 (21.7)	36.2 (22.5)	36.2 (22.5)	35.5 (22.1)/37.3 (23.2) ^{*4}
4th					
Reverse		7.3 (4.5)	7.9 (4.9)	7.9 (4.9)	8.5 (5.3)/-
1st		12.9 (8.0)	13.5 (8.4)	13.5 (8.4)	12.9 (8.0)/13.0 (8.1) ^{*4}
2nd		22.7 (14.1)	23.5 (14.6)	23.5 (14.6)	24.7 (15.3)/26.6 (16.5) ^{*4}
3rd		36.0 (22.4)	37.3 (23.2)	37.3 (23.2)	38.0 (23.6)/38.0 (23.6) ^{*4}
4th					
Turning radius* (Outside corner of bucket)	mm (ft.in)				
Articulation angle: each dire./end stop	degree	40	37	37	40
DIMENSIONS*:	mm (ft.in)				
ENGINE:					
Model		KOMATSU SAA6D114E-2	KOMATSU SAA6D125E-5	KOMATSU SAA6D125E-5	KOMATSU SAA6D140E-6
No. of cylinders- bore × stroke	mm (in)	6-114 × 135 (4.49 × 5.31)	6-125 × 150 (4.92 × 5.91)	6-125 × 150 (4.92 × 5.91)	6-140 × 165 (5.51 × 6.5)
Piston displacement	ltr. (cu.in)	8.27 (505)	11.04 (674)	11.4 (674)	15.24 (930)
CAPACITY:					
Fuel tank	ltr. (U.S. Gal)	300 (79.3)	413 (109.1)	413 (109.1)	473 (125)

* See PERFORMANCE DATA

** 1st speed can be set variably

*** for EU

*4 with torque converter lock-up

*5 with large-capacity torque converter

• EPA Tier 3 and EU Stage 3A model

○ EPA Tier 4 Interim and EU Stage 3B model

Item	Model	*WA500-6			
OPERATING WEIGHT*	kg (lb)				
HORSEPOWER SAE J1995 Gross ISO9249 /SAE J1349 Net Hyd. fan at max. speed Net	kW (HP)/RPM kW (HP)/RPM kW (HP)/RPM	263 (353)/1900			
BUCKET CAPACITY*	m ³ (cu.yd)				
PERFORMANCE:	km/h (MPH)				
Travel speeds:					
Forward		7.7 (4.8)			
1st		12.5 (7.8)			
2nd		22.3 (13.9)			
3rd		35.0 (21.7)			
4th					
Reverse		8.6 (5.3)			
1st		13.0 (8.1)			
2nd		25.0 (15.5)			
3rd		37.5 (23.3)			
4th					
Turning radius*	mm (ft.in)				
(Outside corner of bucket)					
Articulation angle: each dire./end stop	degree	40			
DIMENSIONS*:	mm (ft.in)				
ENGINE:					
Model		KOMATSU SA6D140E-5			
No. of cylinders- bore × stroke	mm (in)	6-140 × 165 (5.51 × 6.5)			
Piston displacement	ltr. (cu.in)	15.24 (930)			
CAPACITY:					
Fuel tank	ltr. (U.S. Gal)	473 (125)			

* See PERFORMANCE DATA

** 1st speed can be set variably

*** for EU

*4 with torque converter lock-up

*5 with large-capacity torque converter

● EPA Tier 3 and EU Stage 3A model

○ EPA Tier 4 Interim and EU Stage 3B model

4. China and Brazil sourced models

Item		Model	WA200-5***	WA320-5**	WA320-5***	*WA380-6**
OPERATING WEIGHT*		kg (lb)				
HORSEPOWER SAE J1995 Gross ISO9249 /SAE J1349 Net Hyd. fan at max. speed Net		kW (HP)/RPM kW (HP)/RPM kW (HP)/RPM	95 (127)/2000	124 (166)/2000	127 (170)/2000 124 (166)/2000	143 (192)/2100 142 (191)/2100 133 (179)/2100
BUCKET CAPACITY*		m ³ (cu.yd)				
PERFORMANCE:						
Travel speeds:		km/h (MPH)				
Forward			4.0-13.0 (2.5-8.1)*4	4.0-13.0 (2.5-8.1)*4	4.0-13.0 (2.5-8.1)*4	6.6 (4.1) 11.5 (7.1) 20.2 (12.6) 34.0 (21.1)
1st						
2nd						
3rd						
4th						
Reverse			4.4-14.3 (2.7-8.9)*4	4.0-13.0 (2.5-8.1)*4	4.0-13.0 (2.5-8.1)*4	7.1 (4.4) 12.3 (7.6) 21.5 (13.4) 35.5 (22.1)
1st						
2nd						
3rd						
4th						
Turning radius* (Outside corner of bucket)		mm (ft.in)				
Articulation angle: each dire./end stop		degree	40	40	40	35/40
DIMENSIONS*:		mm (ft.in)				
ENGINE:						
Model			KOMATSU SAA6D102E-2	KOMATSU SAA6D102E-2-A	KOMATSU SAA6D102E-2-A	KOMATSU SAA6D107E-1
No. of cylinders- bore × stroke		mm (in)	6-102 × 120 (4.02 × 4.72)	6-102 × 120 (4.02 × 4.72)	6-102 × 120 (4.02 × 4.72)	6-107 × 124 (4.21 × 4.88)
Piston displacement		ltr. (cu.in)	5.88 (359)	5.88 (359)	5.88 (359)	6.69 (408)
CAPACITY:						
Fuel tank		ltr. (U.S. Gal)	175 (46.2)	228 (60.2)	228 (60.2)	300 (79.3)

Item		Model	*WA380Z-6**	*WA470-6**		
OPERATING WEIGHT*		kg (lb)				
HORSEPOWER SAE J1995 Gross ISO9249 /SAE J1349 Net Hyd. fan at max. speed Net		kW (HP)/RPM kW (HP)/RPM kW (HP)/RPM	143 (192)/2100 142 (191)/2100 133 (179)/2100	204 (273)/2000 203 (272)/2000 191 (256)/2000		
BUCKET CAPACITY*		m ³ (cu.yd)				
PERFORMANCE:						
Travel speeds:		km/h (MPH)				
Forward			6.6 (4.1) 11.5 (7.1) 20.2 (12.6) 34.0 (21.1)	7.6 (4.7) 13.1 (8.1) 22.9 (14.2) 36.2 (22.5)		
1st						
2nd						
3rd						
4th						
Reverse			7.1 (4.4) 12.3 (7.6) 21.5 (13.4) 35.5 (22.1)	7.9 (4.9) 13.5 (8.4) 23.6 (14.7) 37.3 (23.2)		
1st						
2nd						
3rd						
4th						
Turning radius* (Outside corner of bucket)		mm (ft.in)				
Articulation angle: each dire./end stop		degree	35/40	35/40		
DIMENSIONS*:		mm (ft.in)				
ENGINE:						
Model			KOMATSU SAA6D107E-1	KOMATSU SAA6D107E-1		
No. of cylinders- bore × stroke		mm (in)	6-107 × 124 (4.21 × 4.88)	6-107 × 124 (4.21 × 4.88)		
Piston displacement		ltr. (cu.in)	6.69 (408)	6.69 (408)		
CAPACITY:						
Fuel tank		ltr. (U.S. Gal)	300 (79.3)	300 (79.3)		

* See PERFORMANCE DATA

** China source models

*** Brazil source models

• EPA Tier 3 and EU Stage 3A model

WA50-6

Unit: mm (ft.in)

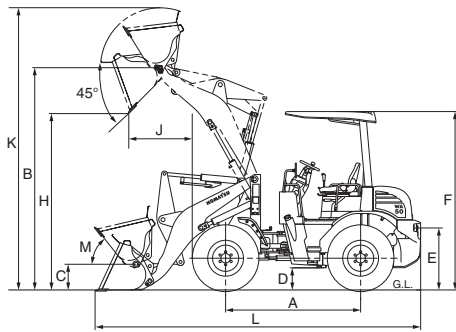

Tires	15.5/60-18-8PR(L-2)
Tread	1250 (4'1")
Width over tires	1650 (5'5")
A Wheelbase	1900 (6'3")
B Hinge pin height, max. height	3120 (10'3")
C Hinge pin height, carry position	360 (1'2")
D Ground clearance	310 (1'0")
E Hitch height	470 (1'7")
F Overall height, ROPS (canopy/cab)	2500 (8'2")/2540 (8'4")
M Tilt back angle	52°

Measured with 15.5/60-18-8PR (L2) tires

Bucket type		Stockpile bucket With Bolt-on Cutting Edge	
Bucket capacity	Heaped	m ³ (yd ³)	0.6 (0.8)
	Struck	m ³ (yd ³)	0.5 (0.7)
Bucket width		mm (ft.in)	1690 (5'7")
Bucket weight (with B.O.C.)		kg (lb)	215 (475)
Static tipping load	Straight (canopy/cab)	kg (lb)	2450 (5,400)/2580 (5,690)
	Full turn (canopy/cab)	kg (lb)	2000 (4,410)/2100 (4,630)
H. Dumping clearance, max. height and 45° dump angle**		mm (ft.in)	2475 (8'1")
Reach at 2130 mm (7') and 45° dump angle**		mm (ft.in)	
J. Reach at max. height and 45° dump angle**		mm (ft.in)	900 (2'11")
Reach with arm horizontal and bucket level**		mm (ft.in)	1945 (6'5")
K. Operating height (fully raised)		mm (ft.in)	3955 (13'0")
L. Overall length, bucket on ground		mm (ft.in)	4580 (15'0")
Turning radius*		mm (ft.in)	3825 (12'7")
Digging depth	0°	mm (ft.in)	43 (1.7")
	10°	mm (ft.in)	175 (6.9")
Breakout force		kN/kgf (lb)	29.9/3050 (6,720)
Operating weight (canopy/cab)		kg (lb)	3675 (8,100)/3825 (8,430)

* Bucket at carry, outside corner of bucket.

** At the end of B.O.C.

**Performance Data
Dimensions**

WHEEL LOADERS

WA120-3

	Capacity Heaped m ³ (cu.yd)	Struck m ³ (cu.yd)	Bucket width mm (ft.in)	Bucket weight kg (lb)	Breakout force kgf (lb)
I General-purpose bucket with bolt-on cutting edges; (Loading and excavating of soil, sand and variety of other commonly handled materials.)	1.4 (1.85)	1.2 (1.55)	2390 (7'10")	600 (1320)	6120 (13490)
II General-purpose bucket with teeth	1.3 (1.7)	1.1 (0.45)	2390 (7'10")	550 (1210)	6680 (14730)
III Excavating bucket with bolt-on cutting edges	1.2 (1.55)	1.0 (1.3)	2390 (7'10")	570 (1260)	6470 (14260)
IV Excavating bucket with teeth (Loading and excavating of crushed rock and blasted rock.)	1.2 (1.55)	1.0 (1.3)	2390 (7'10")	515 (1135)	7060 (15560)
V Light material bucket with bolt-on cutting edges; (A Lighter-weight, large-capacity bucket.)	1.7 (2.25)	1.5 (1.95)	2390 (7'10")	665 (1465)	5220 (11510)

Tires/Buckets	Operating weight kg/lb				Static tipping load kg/lb											
					Straight				35° turn				40° full turn			
	I	II	III	IV	I	II	III	IV	I	II	III	IV	I	II	III	IV
16.9-24-10PR (L-2)	7600 16760	7550 16640	7570 16690	7515 16570	6300 13890	6365 14030	6350 14000	6415 14140	5670 12500	5730 12630	5715 12600	5775 12730	5480 12080	5535 12200	5525 12180	5580 12300
16.9-24-10PR (L-3)	7700 16980	7650 16870	7670 16910	7615 16790	6370 14040	6435 14190	6420 14150	6485 14300	5730 12630	5790 12760	5785 12740	5835 12860	5540 12210	5595 12330	5585 12310	5640 12430
14.00-24-12PR (L-2)	7730 17040	7680 16930	7700 17000	7645 16850	6395 14100	6460 14240	6445 14210	6510 14350	5755 12690	5815 12820	5800 12790	5860 12920	5565 12270	5620 12390	5610 12370	5665 12490
15.5-25-8PR (L-2)	7610 16780	7560 16670	7580 16710	7525 16590	6310 13910	6375 14050	6360 14020	6425 14160	5680 12520	5340 11770	5725 12620	5785 12750	5485 12090	5540 12210	5530 12190	5585 12310
15.5-25-8PR (L-3)	7660 16890	7610 16780	7630 16820	7575 16700	6340 13980	6405 14120	6390 14090	6455 14230	5705 12580	5765 12710	5750 12680	5810 12810	5515 12160	5570 12780	5560 12260	5615 12380
15.5-25-12PR (L-2)	7750 17090	7700 17000	7720 17020	7665 16900	6410 14130	6475 14270	6460 14240	6525 14380	5770 12720	5830 142850	5815 12820	5875 12950	5580 12300	5635 12420	5625 12400	5680 12520
17.5-25-12PR (L-3)	7790 17170	7740 17060	7760 17110	7705 16990	6440 14200	6505 14340	6490 14310	6555 14450	5795 12780	5855 12910	5840 12870	5900 13010	5600 12350	5655 12470	5640 12430	5690 12540

- All dimensions, weights and performance values based on SAE J732c and J742b standards.
- Static tipping load and operating weight shown include lubricant, coolant, full fuel tank, ROPS cab, and operator.
- Machine stability and operating weight are affected by counterweight, tire size and other attachments.
Apply the following weight changes to operating weight and static tipping load.

Weight Changes

	Change in operating weight kg (lb)	Change in tipping load kg (lb)	
		Straight	Full turn
Remove ROPS cab	-500 (-1,100)	-470 (-1,040)	-410 (-900)
Install ROPS canopy 320 kg (710 lb)	-180 (-400)	-170 (-370)	-150 (-330)
Install steel cab 310 kg (680 lb)	-190 (-420)	-180 (-400)	-160 (-350)
Install additional counterweight	+280 (+620)	+530 (+1,170)	+460 (+1,010)

**Performance Data
Dimensions**

WHEEL LOADERS

WA120-3

Unit: mm (ft.in)

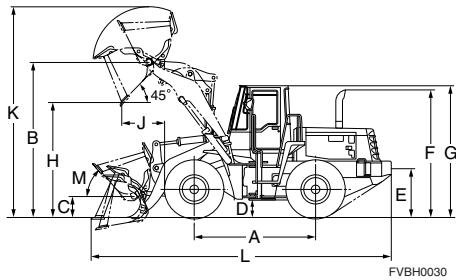

	16.9-24 tires	14.00-24 and 17.5-25 tires	15.5-25 tires
Tread	1780 (5'10")	1780 (5'10")	1780 (5'10")
Width over tires	2250 (7'5")	2185 (7'2") 2225 (7'4")	2180 (7'2")
A Wheelbase	2600 (8'6")	2600 (8'6")	2600 (8'6")
B Hinge pin height, max. height	3450 (11'4")	3475 (11'5)	3440 (11'3")
C Hinge pin height, carry position	360 (1'2")	355 (1'2")	365 (1'2")
D Ground clearance	400 (1'4")	425 (1'5")	390 (1'4")
E Hitch height	780 (2'7")	805 (2'8")	770 (2'6")
F Overall height, top of the stack	2955 (9'8")	2980 (9'9")	2945 (9'8")
G Overall height, ROPS cab	3075 (10'1")	3100 (10'2")	3065 (10'1")
M Tilt buck angle	46°	46°	46°

Measured with 16.9-24 tires

	Buckets	I	II	III	IV
H. Dumping clearance, max. height and 45° dump angle*		2700 (8'10")	2640 (8'8")	2730 (8'11")	2670 (8'9")
Reach at 2130 mm (7') cut edge clearance and 45° dump angle		1370 (4'6")	1390 (4'7")	1355 (4'5")	1375 (4'6")
J. Reach at max. height and 45° dump angle*		975 (3'2")	1025 (3'4")	945 (3'1")	995 (3'3")
Reach with arm horizontal and bucket level		2005 (6'7")	2080 (6'10")	1965 (6'5")	2040 (6'8")
K. Operating height (fully raised)		4545 (14'11")	4545 (14'11")	4445 (14'7")	4445 (14'7")
L. Overall length		5975 (19'7")	6055 (19'10")	5955 (19'6")	6015 (19'9")
Loader clearance circle (bucket at carry, outside corner of bucket)		10360 (34')	10400 (34'1")	10340 (33'11")	10380 (34'1")
Digging depth	0°	80 (3.1")	85 (3.3")	80 (3.1")	85 (3.3")
	10°	235 (9.3")	255 (10")	230 (9.1")	250 (9.8")

* At the end of teeth or BOC

Measured with 14.00-24 and 17.5-25 tires

	Buckets	I	II	III	IV
H. Dumping clearance, max. height and 45° dump angle*		2725 (8'11")	2665 (8'9")	2755 (9')	2695 (8'10")
Reach at 2130 mm (7') cut edge clearance and 45° dump angle		1365 (4'6")	1385 (4'7")	1350 (4'5")	1370 (4'6")
J. Reach at max. height and 45° dump angle*		955 (3'2")	1005 (3'4")	925 (3')	975 (3'3")
Reach with arm horizontal and bucket level		1985 (6'6")	2060 (6'9")	1945 (6'5")	2020 (6'8")
K. Operating height (fully raised)		4570 (15')	4570 (15')	4470 (14'8")	4470 (14'8")
L. Overall length		5950 (19'6")	6030 (19'9")	5930 (19'5")	5990 (19'8")
Loader clearance circle (bucket at carry, outside corner of bucket)		10340 (33'11")	10380 (34'1")	10320 (33'10")	10360 (34')
Digging depth	0°	55 (2.2")	60 (2.4")	55 (2.2")	60 (2.4")
	10°	210 (8.3")	230 (9.1")	205 (8.1")	225 (8.9")

* At the end of teeth or BOC

Measured with 15.5-25 tires

	Buckets	I	II	III	IV
H. Dumping clearance, max. height and 45° dump angle*		2690 (8'10")	2630 (8'8")	2720 (8'11")	2660 (8'8")
Reach at 2130 mm (7') cut edge clearance and 45° dump angle		1380 (4'6")	1400 (4'7")	1370 (4'6")	1390 (4'7")
J. Reach at max. height and 45° dump angle*		985 (3'3")	1035 (3'5")	955 (3'2")	1005 (3'4")
Reach with arm horizontal and bucket level		2015 (6'7")	2090 (6'10")	1975 (6'6")	2050 (6'9")
K. Operating height (fully raised)		4535 (14'11")	4535 (14'11")	4435 (14'7")	4435 (14'7")
L. Overall length		5985 (19'8")	6065 (19'11")	5965 (19'7")	6025 (19'9")
Loader clearance circle (bucket at carry, outside corner of bucket)		10380 (34'1")	10420 (34'2")	10360 (34')	10400 (34'1")
Digging depth	0°	90 (3.5")	95 (3.5")	90 (3.5")	95 (3.7")
	10°	245 (9.6")	265 (10.4")	240 (9.4")	260 (10.2")

* At the end of teeth or BOC

Performance Data Dimensions

WHEEL LOADERS

WA150-6

Unit: mm (ft.in)

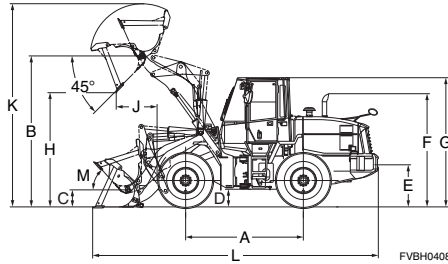

	16.9-24 tires	15.5-25 tires	17.5-25 tires
Tread	1780 (5'10")	1780 (5'10")	1780 (5'10")
Width over tires	2250 (7'5")	2180 (7'2")	2220 (7'3")
A Wheelbase	2600 (8'6")	2600 (8'6")	2600 (8'6")
B Hinge pin height, max. height	3485 (11'5")	3475 (11'5")	3510 (11'6")
C Hinge pin height, carry position	360 (1'2")	360 (1'2")	355 (1'2")
D Ground clearance	400 (1'4")	390 (1'3")	425 (1'5")
E Hitch height	800 (2'7")	790 (2'1")	825 (2'8")
F Overall height, top of the stack	2495 (8'2")	2485 (8'2")	2520 (8'3")
G Overall height, ROPS cab	3035 (9'11")	3025 (9'11")	3060 (10'0")
M Tilt back angle	46°	46°	46°

Measured with 16.9-24-10PR (L2) tires

Bucket type			Stockpile Bucket		Excavating Bucket		Light Material Bucket
			Bolt-on Cutting Edge	Teeth	Bolt-on Cutting Edge	Teeth	Bolt-on Cutting Edge
Bucket capacity	Heaped	m ³ (yd ³)	1.5 (2.0)	1.4 (1.8)	1.3 (1.7)	1.2 (1.6)	1.7 (2.2)
	Struck	m ³ (yd ³)	1.25 (1.6)	1.2 (1.6)	1.1 (1.4)	1.05 (1.4)	1.5 (2.0)
Bucket width		mm (ft.in)	2390 (7'10")	2390 (7'10")	2390 (7'10")	2390 (7'10")	2390 (7'10")
Bucket weight		kg (lb)	595 (1,310)	540 (1,190)	580 (1,280)	525 (1,160)	665 (1,470)
Static tipping load	Straight	kg (lb)	6635 (14,630)	6690 (14,750)	6675 (14,720)	6730 (14,840)	6540 (14,420)
	Full turn (38°)	kg (lb)	5775 (12,730)	5825 (12,840)	5810 (12,810)	5860 (12,920)	5695 (12,560)
H. Dumping clearance, max. height and 45° dump angle**		mm (ft.in)	2705 (8'10")	2645 (8'8")	2745 (9'0")	2685 (8'10")	2630 (8'8")
Reach at 2130 mm (7') and 45° dump angle**		mm (ft.in)	1385 (4'7")	1405 (4'7")	1365 (4'6")	1385 (4'7")	1420 (4'8")
J. Reach at max. height and 45° dump angle**		mm (ft.in)	970 (3'10")	1020 (3'4")	930 (3'1")	980 (3'3")	1045 (3'5")
Reach with arm horizontal and bucket level**		mm (ft.in)	2055 (6'9")	2130 (7'0")	1995 (6'6")	2070 (6'9")	2160 (7'1")
K. Operating height (fully raised)		mm (ft.in)	4630 (15'2")	4630 (15'2")	4560 (15'0")	4560 (15'0")	4710 (15'5")
L. Overall length, bucket on ground		mm (ft.in)	6310 (20'8")	6385 (20'11")	6250 (20'6")	6325 (20'6")	6415 (21'1")
Turning radius*		mm (ft.in)	5380 (17'8")	5400 (17'9")	5360 (17'7")	5385 (17'8")	5405 (17'9")
Digging depth	0°	mm (ft.in)	90 (3.5")	100 (3.9")	90 (3.5")	100 (3.9")	90 (3.5")
	10°	mm (ft.in)	255 (10.0")	275 (10.8")	245 (9.6")	265 (10.4")	270 (10.6")
Breakout force		kN kgf (lb)	72.6 7400 (16,310)	66.5 6780 (14,950)	78.6 8010 (17,660)	71.5 7290 (16,070)	64.0 6530 (14,400)
Operating weight		kg (lb)	7700 (16,980)	7645 (16,850)	7685 (16,940)	7630 (16,830)	7770 (17,130)

* Bucket at carry, outside corner of bucket.

** At the end of B.O.C.

- All dimensions, weights, and performance values based on SAE J732c and J742b standards.
- Static tipping load and operating weight shown include lubricant, coolant, full fuel tank, ROPS cab and operator.
- Machine stability and operating weight affected by counterweight, tire size, and other attachments.

Weight Changes

	Change in Operating Weight		Change in Tipping Load				Width Over Tire		Ground Clearance		Change in Vertical Dimensions		Change in Reach	
			Straight		Full Turn									
	kg	lb	kg	lb	kg	lb	mm	ft.in	mm	ft.in	mm	ft.in	mm	ft.in
15.5-25-8PR (L2)	+10	+22	+10	+22	+5	+11	2180	7'2"	390	1'3"	-10	-0.4"	+10	+0.4"
17.5-25-12PR (L2)	+150	+331	+110	+243	+95	+209	2220	7'3"	425	1'5"	+25	+1.0"	-25	-1.0"
Install ROPS canopy (instead of cab)	-150	-331	-160	-353	-150	-331								
Additional counterweight	+200	+441	+380	+838	+336	+728								

Performance Data Dimensions

WHEEL LOADERS

WA150-5

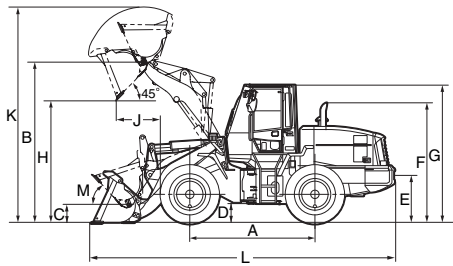

	Unit: mm (ft.in)			
	16.9-24-10PR (L2)	14.00-24-12PR (L2)	15.5-25-8PR (L2)	17.5-25-12PR (L2)
Tread	1780 (5'10")	1780 (5'10")	1780 (5'10")	1780 (5'10")
Width over tires	2250 (7'5")	2185 (7'2")	2180 (7'2")	2220 (7'3")
A Wheelbase	2600 (8'6")	2600 (8'6")	2600 (8'6")	2600 (8'6")
B Hinge pin height, max. height	3485 (11'5")	3510 (11'6")	3475 (11'5")	3510 (11'6")
C Hinge pin height, carry position	360 (1'2")	355 (1'2")	360 (1'2")	355 (1'2")
D Ground clearance	400 (1'4")	425 (1'5")	390 (1'3")	425 (1'5")
E Hitch height	800 (2'7")	825 (2'8")	790 (2'7")	825 (2'8")
F Overall height, top of the stack	2420 (7'11")	2445 (8'0")	2410 (7'11")	2445 (8'0")
G Overall height, ROPS cab	3035 (9'11")	3060 (10'0")	3025 (9'11")	3060 (10'0")
M Tilt back angle	46°	46°	46°	46°

Measured with 16.9-24-10PR (L2) tires

Bucket type			Stockpile Bucket With Bolt-on Cutting Edge	Excavating Bucket With Bolt-on Cutting Edge	Light Material Bucket With Bolt-on Cutting Edge
Bucket capacity	Heaped	m ³ (yd ³)	1.5 (2.0)	1.3 (1.7)	1.7 (2.2)
	Struck	m ³ (yd ³)	1.25 (1.6)	1.1 (1.4)	1.5 (2.0)
Bucket width		mm (ft.in)	2390 (7'10")	2390 (7'10")	2390 (7'10")
Bucket weight		kg (lb)	595 (1,312)	580 (1,279)	665 (1,466)
Static tipping load	Straight	kg (lb)	6370 (14,043)	6410 (14,132)	6280 (13,845)
	Full turn (40°)	kg (lb)	5540 (12,213)	5570 (12,280)	5460 (12,037)
H. Dumping clearance, max. height and 45° dump angle**		mm (ft.in)	2705 (8'10")	2745 (9'0")	2630 (8'8")
Reach at 2130 mm (7') and 45° dump angle**		mm (ft.in)	1385 (4'7")	1365 (4'6")	1420 (4'8")
J. Reach at max. height and 45° dump angle**		mm (ft.in)	970 (3'2")	930 (3'1")	1045 (3'5")
Reach with arm horizontal and bucket level**		mm (ft.in)	2055 (6'9")	1995 (6'6")	2160 (7'1")
K. Operating height (fully raised)		mm (ft.in)	4630 (15'2")	4560 (15'0")	4710 (15'5")
L. Overall length, bucket on ground		mm (ft.in)	6320 (20'9")	6260 (20'6")	6425 (21'1")
Turning radius*		mm (ft.in)	5185 (17'0")	5180 (17'0")	5225 (17'2")
Digging depth	0°	mm (ft.in)	90 (3.5")	90 (3.5")	90 (3.5")
	10°	mm (ft.in)	255 (10.0")	245 (9.6")	270 (10.6")
Breakout force		kgf (lb)	7400 (16,314)	8010 (17,659)	6530 (14,396)
Operating weight		kg (lb)	7425 (16,369)	7410 (16,336)	7495 (16,524)

* Bucket at carry, outside corner of bucket.

** At the end of B.O.C.

- All dimensions, weights, and performance values based on SAE J732c and J742b standards.
- Static tipping load and operating weight shown include lubricant, coolant, full fuel tank, ROPS cab and operator.
- Machine stability and operating weight affected by counterweight, tire size, and other attachments.

Weight Changes

	Change in Operating Weight		Change in Tipping Load				Width Over Tire		Ground Clearance		Change in Vertical Dimensions		Change in Reach	
	kg	lb	Straight		Full Turn		mm	ft.in	mm	ft.in	mm	ft.in	mm	ft.in
			kg	lb	kg	lb								
14.00-24-12PR (L2)	+130	+287	+95	+209	+85	+187	2185	7'2"	425	1'5"	+25	+1.0"	-25	-1.0"
15.5-25-8PR (L2)	+10	+22	+10	+22	+5	+11	2180	7'2"	390	1'3"	-10	-0.4"	+10	+0.4"
17.5-25-12PR (L2)	+150	+331	+110	+243	+95	+209	2220	7'3"	425	1'5"	+25	+1.0"	-25	-1.0"
Install ROPS canopy (instead of cab)	-110	-243	-110	-243	-95	-209								
Additional counterweight	+200	+441	+380	+838	+330	+728								
Air conditioner	+70	+154	+80	+176	+70	+154								

**Performance Data
Dimensions**

WHEEL LOADERS

WA180-3

	Capacity Heaped m ³ (cu.yd)	Struck m ³ (cu.yd)	Bucket width mm (ft.in)	Bucket weight kg (lb)	Breakout force kgf (lb)
I General-purpose bucket with bolt-on cutting edges; (Loading and excavating of soil, sand and variety of other commonly handled materials.)	1.7 (2.25)	1.55 (2.02)	2440 (8')	710 (1570)	7940 (17500)
II General-purpose bucket with teeth	1.6 (2.1)	1.34 (1.75)	2440 (8')	665 (1470)	8570 (18890)
III Excavating bucket with bolt-on cutting edges	1.5 (2.0)	1.3 (1.7)	2440 (8')	725 (1600)	8300 (18300)
IV Excavating bucket with teeth (Loading and excavating of crushed rock and blasted rock.)	1.5 (2.0)	1.27 (1.66)	2440 (8')	670 (1480)	8980 (19800)
V Light material bucket with bolt-on cutting edges; (A Lighter-weight, large-capacity bucket.)	2.2 (2.9)	1.9 (2.5)	2440 (8')	800 (1760)	6590 (14530)

Tires/Buckets	Operating weight kg/lb				Static tipping load kg/lb											
					Straight				35° turn				40° full turn			
	I	II	III	IV	I	II	III	IV	I	II	III	IV	I	II	III	IV
18.4-24-10PR (L-2)	8700 19180	8655 19080	8715 19210	8660 19090	7560 16670	7620 16800	7645 16860	7720 170200	6805 15000	6860 15130	6880 151700	6950 15320	6580 14510	6630 14620	6650 14660	6720 14820
14.00-24-12PR (L-2)	8720 19220	8675 19120	8735 19260	8810 19420	7570 16690	7630 16820	7655 16880	7730 17040	6815 15030	6870 15150	6890 15190	6960 15350	6590 14530	6640 14640	6660 14690	6725 14830
14.00-24-12PR (L-3)	8800 19400	8755 19300	8815 19430	8890 19600	7630 16820	7690 16960	7715 17010	7790 17180	6870 15150	6920 15260	6945 15310	7010 15460	6640 14640	6690 14750	6715 14810	6780 14950
15.5-25-12PR (L-2)	8630 19030	8585 18930	8645 19060	8720 19220	7510 16560	7570 16690	7595 16750	7670 16910	6760 14910	6815 15030	6835 15070	6905 15230	6535 14410	6585 14520	6610 14580	6675 14720
15.5-25-12PR (L-3)	8680 19140	8635 19040	8695 19170	8770 19330	7550 17090	7610 16780	7635 16840	7710 17000	6795 14980	6850 15100	6875 15160	6940 15300	6570 14490	6620 14600	6645 14650	6710 14800
17.5-25-12PR (L-2)	8750 19290	8705 19190	8765 19320	8840 19490	7600 16760	7660 16890	7685 16950	7760 17110	6840 15080	6895 15200	6920 15260	6985 15400	6615 14590	6665 14700	6685 14740	6750 14880
17.5-25-12PR (L-3)	8790 19380	8745 19280	8805 19410	8880 19580	7630 16820	7690 16960	7715 17010	7790 17180	6870 15150	6920 15260	6945 15310	7010 15460	6640 14640	6690 14750	6715 14810	6780 14950

- All dimensions, weights and performance values based on SAE J732c and J742b standards.
- Static tipping load and operating weight shown include lubricant, coolant, full fuel tank, ROPS cab, and operator.
- Machine stability and operating weight are affected by counterweight, tire size and other attachments. Apply the following weight changes to operating weight and static tipping load.

Weight Changes

	Change in operating weight kg (lb)	Change in tipping load kg (lb)	
		Straight	Full turn
Remove ROPS cab	-500 (-1100)	-460 (-1010)	-400 (-880)
Install ROPS canopy 320 kg (710 lb)	-180 (-400)	-170 (-370)	-140 (-310)
Install steel cab 310 kg (680 lb)	-190 (-420)	-175 (-390)	-150 (-330)
Install additional counterweight	+280 (+620)	+520 (+1150)	+450 (+990)

**Performance Data
Dimensions**

WHEEL LOADERS

WA180-3

Unit: mm (ft.in)

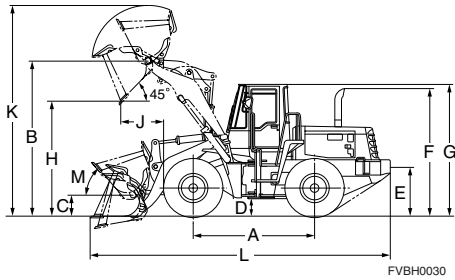

	18.4-24 tires	14.00-24 and 17.5-25 tires	15.5-25 tires
Tread	1820 (6')	1820 (6')	1820 (6')
Width over tires	2320 (7'7")	2225 (7'4") 2260 (7'5")	2220 (7'3")
A Wheelbase	2700 (8'10")	2700 (8'10")	2700 (8'10")
B Hinge pin height, max. height	3545 (11'7")	3535 (11'7")	3505 (11'6")
C Hinge pin height, carry position	365 (1'2")	365 (1'2")	375 (1'3")
D Ground clearance	430 (1'5")	420 (1'5")	390 (1'4")
E Hitch height	820 (2'8")	810 (2'8")	780 (2'7")
F Overall height, top of the stack	3000 (9'10")	2990 (9'10")	2960 (9'9")
G Overall height, ROPS cab	3100 (10'2")	3090 (10'2")	3060 (10')
M Tilt back angle	46°	46°	46°

Measured with 18.4-25 tires

Buckets	I	II	III	IV
H. Dumping clearance, max. height and 45° dump angle*	2720 (8'11")	2630 (8'8")	2745 (9')	2660 (8'9")
Reach at 2130 mm (7') cut edge clearance and 45° dump angle	1395 (4'7")	1420 (4'8")	1380 (4'6")	1410 (4'8")
J. Reach at max. height and 45° dump angle*	970 (3'2")	1040 (3'5")	940 (3'1")	1015 (3'4")
Reach with arm horizontal and bucket level	2085 (6'10")	2195 (7'2")	2045 (6'9")	2160 (7'1")
K. Operating height (fully raised)	4700 (15'5")	4700 (15'5")	4645 (15'3")	4645 (15'3")
L. Overall length	6410 (21')	6520 (21'5")	6375 (20'11")	6485 (21'3")
Loader clearance circle (bucket at carry, outside corner of bucket)	10770 (35'4")	10840 (35'7")	10750 (35'3")	10820 (35'6")
Digging depth	0°	115 (4.5")	125 (4.9")	115 (4.5")
	10°	285 (11.2")	310 (12.2")	275 (10.8")

* At the end of teeth or BOC

Measured with 14.00-24 and 17.5-25 tires

Buckets	I	II	III	IV
H. Dumping clearance, max. height and 45° dump angle*	2710 (8'11")	2620 (8'7")	2735 (9')	2650 (8'8")
Reach at 2130 mm (7') cut edge clearance and 45° dump angle	1405 (4'7")	1430 (4'8")	1390 (4'7")	1415 (4'8")
J. Reach at max. height and 45° dump angle*	980 (3'3")	1050 (3'5")	950 (3'1")	1025 (3'4")
Reach with arm horizontal and bucket level	2095 (6'10")	2205 (7'3")	2055 (6'9")	2170 (7'1")
K. Operating height (fully raised)	4690 (15'5")	4690 (15'5")	4635 (15'2")	4635 (15'2")
L. Overall length	6420 (21'1")	6530 (21'5")	6385 (20'11")	6495 (21'4")
Loader clearance circle (bucket at carry, outside corner of bucket)	10790 (35'5")	10860 (35'8")	10770 (35'4")	10840 (35'7")
Digging depth	0°	125 (4.9")	135 (5.3")	125 (4.9")
	10°	295 (11.6")	320 (12.6")	285 (11.2")

* At the end of teeth or BOC

Measured with 15.5-25 tires

Buckets	I	II	III	IV
H. Dumping clearance, max. height and 45° dump angle*	2680 (8'10")	2590 (8'6")	2705 (8'10")	2620 (8'7")
Reach at 2130 mm (7') cut edge clearance and 45° dump angle	1425 (4'8")	1445 (4'9")	1410 (4'8")	1435 (4'8")
J. Reach at max. height and 45° dump angle*	1010 (3'4")	1080 (3'7")	980 (3'3")	1055 (3'6")
Reach with arm horizontal and bucket level	2125 (7')	2235 (7'4")	2085 (6'10")	2200 (7'3")
K. Operating height (fully raised)	4660 (15'3")	4660 (15'3")	4605 (15'1")	4605 (15'1")
L. Overall length	6445 (21'2")	6555 (21'6")	6410 (21')	6520 (21'5")
Loader clearance circle (bucket at carry, outside corner of bucket)	10830 (35'6")	10900 (35'9")	10810 (35'6")	10880 (35'8")
Digging depth	0°	155 (6.1")	165 (6.5")	155 (6.1")
	10°	325 (12.8")	350 (13.8")	315 (12.4")

* At the end of teeth or BOC

Performance Data Dimensions

WHEEL LOADERS

WA200-6

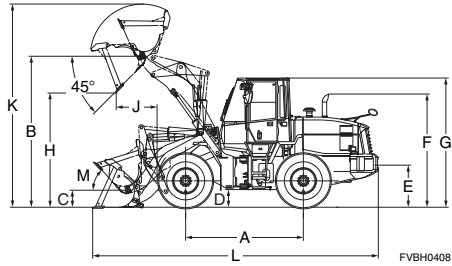

	17.5-25 tires	20.5-25 tires
Tread	1930 (6'4")	1930 (6'4")
Width over tires	2375 (7'10")	2470 (8'1")
A Wheelbase	2840 (9'4")	2840 (9'4")
B Hinge pin height, max. height	3635 (11'11")	3705 (12'2")
C Hinge pin height, carry position	410 (1'4")	380 (1'3")
D Ground clearance	425 (1'5")	495 (1'8")
E Hitch height	870 (2'10")	940 (3'1")
F Overall height, top of the stack	2725 (8'11")	2795 (9'2")
G Overall height, ROPS cab	3110 (10'2")	3180 (10'5")
M Tilt back angle	48°	

Measured with 17.5-25-12PR (L2) tires

Bucket type			Stockpile Bucket		Excavating Bucket		Light Material Bucket
			Bolt-on Cutting Edge	Teeth	Bolt-on Cutting Edge	Teeth	Bolt-on Cutting Edge
Bucket capacity	Heaped	m ³ (yd ³)	2.0 (2.6)	2.0 (2.6)	1.7 (2.2)	1.7 (2.2)	2.4 (3.1)
	Struck	m ³ (yd ³)	1.7 (2.2)	1.7 (2.2)	1.4 (1.8)	1.4 (1.8)	2.0 (2.6)
Bucket width		mm (ft.in)	2550 (8'4")	2550 (8'4")	2550 (8'4")	2550 (8'4")	2550 (8'4")
Bucket weight		kg (lb)	785 (1,731)	740 (1,631)	740 (1,631)	700 (1,543)	875 (1,929)
Static tipping load	Straight	kg (lb)	8655 (19,081)	8705 (19,191)	8715 (19,213)	8750 (19,290)	8505 (18,750)
	Full turn (38°)	kg (lb)	7455 (16,413)	7485 (16,501)	7505 (16,546)	7525 (16,590)	7295 (16,083)
H. Dumping clearance, max. height and 45° dump angle**		mm (ft.in)	2760 (9'1")	2655 (8'9")	2815 (9'3")	2725 (8'11")	2655 (8'9")
Reach at 2130 mm (7') and 45° dump angle**		mm (ft.in)	1480 (4'10")	1500 (4'11")	1455 (4'9")	1500 (4'11")	1530 (5'0")
J. Reach at max. height and 45° dump angle**		mm (ft.in)	1000 (3'3")	1085 (3'7")	945 (3'1")	1040 (3'5")	1105 (3'8")
Reach with arm horizontal and bucket level**		mm (ft.in)	2215 (7'3")	2345 (7'8")	2135 (7'0")	2265 (7'5")	2365 (7'9")
K. Operating height (fully raised)		mm (ft.in)	4885 (16'0")	4885 (16'0")	4765 (15'8")	4765 (15'8")	4995 (16'5")
L. Overall length, bucket on ground		mm (ft.in)	6895 (22'7")	7030 (23'1")	6815 (22'4")	6945 (22'9")	7050 (23'2")
Turning radius*		mm (ft.in)	5850 (19'2")	5890 (19'4")	5830 (19'2")	5865 (19'3")	5890 (19'4")
Digging depth	0°	mm (ft.in)	135 (5.3")	155 (6.1")	135 (5.3")	155 (6.1")	135 (5.3")
	10°	mm (ft.in)	320 (1'1")	360 (1'1")	305 (1'0")	345 (1'2")	345 (1'2")
Breakout force		kN (kgf (lb))	93.2 (9500 (20,944))	83.0 (8465 (18,662))	102.5 (10450 (23,038))	90.7 (9045 (20,038))	81.4 (8300 (18,298))
Operating weight		kg (lb)	9630 (21,231)	9590 (21,142)	9585 (21,131)	9585 (21,131)	9715 (21,418)

* Bucket at carry, outside corner of bucket.

** At the end of B.O.C.

- All dimensions, weights, and performance values based on SAE J732c and J742b standards.
- Static tipping load and operating weight shown include lubricant, coolant, full fuel tank, ROPS cab and operator.
- Machine stability and operating weight affected by counterweight, tire size, and other attachments.

Weight Changes

	Change in Operating Weight		Change in Tipping Load				Width Over Tire		Ground Clearance		Change in Vertical Dimensions		Change in Reach	
			Straight		Full Turn									
	kg	lb	kg	lb	kg	lb	mm	ft.in	mm	ft.in	mm	ft.in	mm	ft.in
17.5-25-12PR (L3)	+105	+231	+80	+176	+70	+154	2375	7'10"	425	1'5"	0	0"	0	0"
20.5-25-12PR (L2)	+400	+882	+305	+672	+270	+595	2470	8'1"	495	1'8"	+70	+2.8"	-70	-2.8"
20.5-25-12PR (L3)	+585	+1,290	+445	+981	+390	+860	2470	8'1"	495	1'8"	+70	+2.8"	-70	-2.8"
Install ROPS canopy (instead of cab)	-150	-331	-150	-331	-130	-287								
Additional counterweight	+300	+661	+590	+1,301	+510	+1,124								

Performance Data Dimensions

WHEEL LOADERS

WA200-5

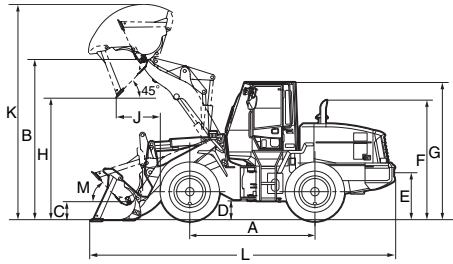

	17.5-25 tires	20.5-25 tires
Tread	1930 (6'4")	1930 (6'4")
Width over tires	2375 (7'10")	2470 (8'1")
A Wheelbase	2840 (9'4")	2840 (9'4")
B Hinge pin height, max. height	3635 (11'11")	3705 (12'2")
C Hinge pin height, carry position	410 (1'4")	380 (1'3")
D Ground clearance	425 (1'5")	495 (1'8")
E Hitch height	870 (2'10")	940 (3'1")
F Overall height, top of the stack	2715 (8'11")	2785 (9'2")
G Overall height, ROPS cab	3110 (10'2")	3180 (10'5")
M Tilt back angle	48°	

Measured with 17.5-25-12PR (L2) tires

Bucket type			Stockpile Bucket With Bolt-on Cutting Edge	Excavating Bucket With Bolt-on Cutting Edge	Light Material Bucket With Bolt-on Cutting Edge
Bucket capacity	Heaped	m ³ (yd ³)	2.0 (2.6)	1.7 (2.2)	2.4 (3.1)
	Struck	m ³ (yd ³)	1.7 (2.2)	1.4 (1.8)	2.0 (2.6)
Bucket width		mm (ft.in)	2550 (8'4")	2550 (8'4")	2550 (8'4")
Bucket weight		kg (lb)	785 (1,731)	740 (1,631)	875 (1,929)
Static tipping load	Straight	kg (lb)	8400 (18,519)	8460 (18,652)	8250 (18,188)
	Full turn (40°)	kg (lb)	7300 (16,094)	7360 (16,226)	7175 (15,818)
H. Dumping clearance, max. height and 45° dump angle**		mm (ft.in)	2760 (9'1")	2815 (9'3")	2655 (8'9")
Reach at 2130 mm (7') and 45° dump angle**		mm (ft.in)	1480 (4'10")	1455 (4'9")	1530 (5'0")
J. Reach at max. height and 45° dump angle**		mm (ft.in)	1000 (3'3")	945 (3'1")	1105 (3'8")
Reach with arm horizontal and bucket level**		mm (ft.in)	2215 (7'3")	2135 (7'0")	2365 (7'9")
K. Operating height (fully raised)		mm (ft.in)	4885 (16'0")	4765 (15'8")	4995 (16'5")
L. Overall length, bucket on ground		mm (ft.in)	6895 (22'7")	6820 (22'5")	7050 (23'2")
Turning radius*		mm (ft.in)	5650 (18'6")	5620 (18'5")	5715 (18'9")
Digging depth	0°	mm (ft.in)	135 (5.3")	135 (5.3")	135 (5.3")
	10°	mm (ft.in)	320 (1'1")	305 (1'0")	345 (1'2")
Breakout force		kgf (lb)	9500 (20,944)	10450 (23,038)	8300 (18,298)
Operating weight		kg (lb)	9470 (20,878)	9425 (20,779)	9555 (21,065)

* Bucket at carry, outside corner of bucket.

** At the end of B.O.C.

- All dimensions, weights, and performance values based on SAE J732c and J742b standards.
- Static tipping load and operating weight shown include lubricant, coolant, full fuel tank, ROPS cab and operator.
- Machine stability and operating weight affected by counterweight, tire size, and other attachments.

Weight Changes

	Change in Operating Weight		Change in Tipping Load				Width Over Tire		Ground Clearance		Change in Vertical Dimensions		Change in Reach	
			Straight		Full Turn									
	kg	lb	kg	lb	kg	lb	mm	ft.in	mm	ft.in	mm	ft.in	mm	ft.in
17.5-25-12PR (L3)	+105	+231	+80	+176	+70	+154	2375	7'10"	425	1'5"	0	0"	0	0"
20.5-25-12PR (L2)	+450	+992	+240	+529	+220	+485	2470	8'1"	495	1'8"	+70	+2.8"	-75	-3.0"
20.5-25-12PR (L3)	+665	+1,466	+355	+783	+320	+705	2470	8'1"	495	1'8"	+70	+2.8"	-75	-3.0"
Install ROPS canopy (instead of cab)	-250	-551	-250	-551	-220	-485								
Additional counterweight	+300	+661	+590	+1,301	+510	+1,124								
Air conditioner	+70	+154	+60	+132	+50	+110								

Performance Data Dimensions

WHEEL LOADERS

WA200PZ-6

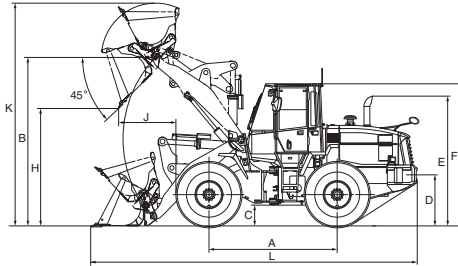

	Unit: mm (ft.in)	
Tread	17.5-25 tires	20.5-25 tires
Width over tires	1930 (6'4")	1930 (6'4")
A Wheelbase	2375 (7'10")	2470 (8'1")
B Hinge pin height, max. height	2840 (9'4")	2840 (9'4")
C Ground clearance	3815 (12'6")	3885 (12'9")
D Hitch height	425 (1'5")	495 (1'8")
E Overall height, top of the stack	870 (2'10")	940 (3'1")
F Overall height, ROPS cab	2725 (8'11")	2795 (9'2")

Bucket

Measured with 20.5-25-12PR (L2) tires

Bucket type			Stockpile Bucket With Bolt-on Cutting Edge	
Bucket capacity	Heaped	m ³ (yd ³)	2.0 (2.6)	
	Struck	m ³ (yd ³)	1.7 (2.2)	
Bucket width		mm (ft.in)	2540 (8'4")	
Bucket weight		kg (lb)	910 (2,005)	
Static tipping load	Straight	kg (lb)	7955 (17,540)	
	Full turn (40°)	kg (lb)	7000 (15,430)	
H. Dumping clearance, max. height and 45° dump angle*		mm (ft.in)	2810 (9'3")	
Reach at 2130 mm (7') and 45° dump angle*		mm (ft.in)	1645 (5'5")	
J. Reach at max. height and 45° dump angle*		mm (ft.in)	1090 (3'7")	
Reach with boom/bucket level*		mm (ft.in)	3275 (10'9")	
K. Operating height (fully raised)		mm (ft.in)	5305 (17'5")	
L. Overall length, bucket on ground		mm (ft.in)	7310 (24'0")	
Digging depth	0°	mm (ft.in)	120 (4.7")	
	10°	mm (ft.in)	345 (1'2")	
Breakout force		kN/kgf (lb)	88.4/9010 (19,865)	
Operating weight		kg (lb)	11450 (25,240)	

* At the end of B.O.C.

- All dimensions, weights, and performance values based on SAE J732c and J742b standards.
- Static tipping load and operating weight shown include lubricant, coolant, full fuel tank, ROPS cab and operator.
- Machine stability and operating weight affected by counterweight, tire size, and other attachments.

Weight Changes

	Change in Operating Weight		Change in Tipping Load				Width Over Tire		Ground Clearance		Change in Vertical Dimensions		Change in Reach	
			Straight		Full Turn									
	kg	lb	kg	lb	kg	lb	mm	ft.in	mm	ft.in	mm	ft.in	mm	ft.in
17.5-25-12PR (L2)	-325	-716	-215	-474	-185	-408	2375	7'10"	425	1'5"	-70	-2.8"	+75	+3.0"
17.5-25-12PR (L3)	-290	-639	-190	-419	-167	-368	2375	7'10"	425	1'5"	-70	-2.8"	+75	+3.0"
20.5-25-12PR (L3)	+165	+364	+105	+231	+95	+209	2470	8'1"	495	1'8"	0	0"	0	0"
Install ROPS canopy (instead of cab)	-167	-368	-152	-335	-134	-295								

Performance Data Dimensions

WHEEL LOADERS

WA200PZ-6

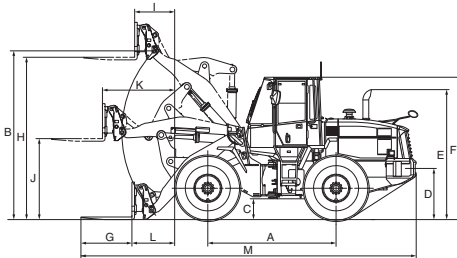

	17.5-25 tires	20.5-25 tires
Tread	1930 (6'4")	1930 (6'4")
Width over tires	2375 (7'10")	2470 (8'1")
A Wheelbase	2840 (9'4")	2840 (9'4")
B Hinge pin height, max. height	3815 (12'6")	3885 (12'9")
C Ground clearance	425 (1'5")	495 (1'8")
D Hitch height	870 (2'10")	940 (3'1")
E Overall height, top of the stack	2725 (8'11")	2795 (9'2")
F Overall height, ROPS cab	3110 (10'2")	3180 (10'5")

Unit: mm (ft.in)

Fork

Measured with 20.5-25-12PR (L2) tires

Static tipping load – boom level Fork level, 610 mm (24") load center	Straight	kg (lb)	6050 (13,340)
	Full turn (40°)	kg (lb)	5300 (11,680)
Operating weight		kg (lb)	11460 (25,260)
G. Fork tine length		mm (ft.in)	1220 (4'0")
H. Ground to top of tine at maximum lift		mm (ft.in)	3765 (12'4")
I. Reach at maximum lift		mm (ft.in)	775 (2'7")
J. Ground to top of Tine – boom and tine level		mm (ft.in)	1780 (5'10")
K. Reach – boom and tine level		mm (ft.in)	1675 (5'6")
L. Reach – tine level on ground		mm (ft.in)	1040 (3'5")
M. Overall length – tine level on ground		mm (ft.in)	7645 (25'1")
Operating load		kg (lb)	2650 (5,840)

Operating load per SAE J1197 (Feb. 1991), 50% of static tipping load.

Static tipping load and operating weight shown include lubricant, coolant, full fuel tank, ROPS cab and operator. Machine stability and operating weight affected by tire size and attachments.

Weight Changes

	Change in Operating Weight		Change in Tipping Load				Width Over Tire		Ground Clearance		Change in Vertical Dimensions		Change in Reach	
			Straight		Full Turn									
	kg	lb	kg	lb	kg	lb	mm	ft.in	mm	ft.in	mm	ft.in	mm	ft.in
17.5-25-12PR (L2)	-325	-716	-215	-474	-185	-408	2375	7'10"	425	1'5"	-70	-2'8"	+75	+3.0"
17.5-25-12PR (L3)	-290	-639	-190	-419	-167	-368	2375	7'10"	425	1'5"	-70	-2'8"	+75	+3.0"
20.5-25-12PR (L3)	+165	+364	+105	+231	+95	+209	2470	8'1"	495	1'8"	0	0"	0	0"
Install ROPS canopy (instead of cab)	-167	-368	-152	-335	-134	-295								

Performance Data Dimensions

WHEEL LOADERS

WA250-6

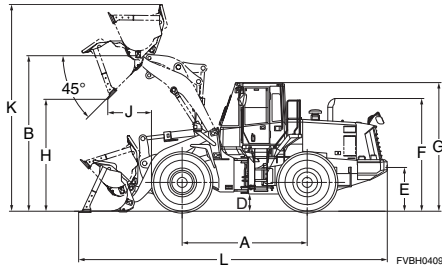

	17.5-25 tires	20.5-25 tires
Tread	1930 (6'4")	1930 (6'4")
Width over tires	2375 (7'10")	2470 (8'1")
A Wheelbase	2900 (9'6")	2900 (9'6")
B Hinge pin height, max. height	3725 (12'3")	3795 (12'5")
C Hinge pin height, carry position	375 (1'3")	450 (1'6")
D Ground clearance	395 (1'4")	465 (1'6")
E Hitch height	880 (2'11")	950 (3'1")
F Overall height, top of the stack	2855 (9'4")	2925 (9'7")
G Overall height, ROPS cab	3130 (10'3")	3200 (10'6")
M Tilt back angle	50°	

Measured with 17.5-25-16PR (L2) tires

Bucket type			Stockpile Bucket		Excavating Bucket		Light Material Bucket
			Bolt-on Cutting Edge	Teeth	Bolt-on Cutting Edge	Teeth	Bolt-on Cutting Edge
Bucket capacity	Heaped	m ³ (yd ³)	2.3 (3.0)	2.1 (2.7)	1.9 (2.5)	1.8 (2.4)	2.7 (3.5)
	Struck	m ³ (yd ³)	2.0 (2.6)	1.8 (2.4)	1.6 (2.1)	1.5 (2.0)	2.3 (3.0)
Bucket width		mm (ft.in)	2685 (8'10")	2705 (8'10")	2685 (8'10")	2705 (8'10")	2685 (8'10")
Bucket weight		kg (lb)	960 (2,116)	865 (1,907)	905 (1,995)	810 (1,786)	1050 (2,315)
Static tipping load	Straight	kg (lb)	11110 (24,495)	11205 (24,705)	11230 (24,760)	11325 (24,970)	10960 (24,160)
	Full turn (38°)	kg (lb)	9780 (21,560)	9860 (21,740)	9885 (21,790)	9965 (21,970)	9645 (21,265)
H. Dumping clearance, max. height and 45° dump angle**		mm (ft.in)	2780 (9'1")	2665 (8'9")	2855 (9'4")	2740 (9'0")	2685 (8'10")
Reach at 2130 mm (7') and 45° dump angle**		mm (ft.in)	1535 (5'0")	1560 (5'1")	1495 (4'11")	1530 (5'0")	1580 (5'2")
J. Reach at max. height and 45° dump angle**		mm (ft.in)	1055 (3'6")	1155 (3'9")	980 (3'3")	1080 (3'3")	1150 (3'9")
Reach with arm horizontal and bucket level**		mm (ft.in)	2305 (7'7")	2450 (8'0")	2200 (7'3")	2345 (7'3")	2430 (8'0")
K. Operating height (fully raised)		mm (ft.in)	4995 (16'5")	4995 (16'5")	4875 (16'0")	4875 (16'0")	5130 (16'10")
L. Overall length, bucket on ground		mm (ft.in)	7055 (23'2")	7200 (23'7")	6950 (22'10")	7095 (23'3")	7185 (23'7")
Turning radius*		mm (ft.in)	6030 (19'9")	6070 (19'11")	6015 (19'9")	6040 (19'10")	6110 (20'1")
Digging depth	0°	mm (ft.in)	145 (5.7")	160 (6.3")	145 (5.7")	160 (6.3")	145 (5.7")
	10°	mm (ft.in)	335 (1'1")	375 (1'3")	315 (1'0")	355 (1'2")	355 (1'2")
Breakout force		kN kgf (lb)	121 12340 (27,205)	106 10830 (23,875)	136 13850 (30,534)	117 12010 (26,475)	108 11000 (24,251)
Operating weight		kg (lb)	10965 (24,170)	10870 (23,965)	10910 (24,050)	10815 (23,845)	11055 (24,370)

* Bucket at carry, outside corner of bucket.

** At the end of B.O.C.

- All dimensions, weights, and performance values based on SAE J732c and J742b standards.
- Static tipping load and operating weight shown include lubricant, coolant, full fuel tank, ROPS cab and operator.
- Machine stability and operating weight affected by counterweight, tire size, and other attachments.

Weight Changes

	Change in Operating Weight		Change in Tipping Load				Width Over Tire		Ground Clearance		Change in Vertical Dimensions		Change in Reach	
			Straight		Full Turn									
	kg	lb	kg	lb	kg	lb	mm	ft.in	mm	ft.in	mm	ft.in	mm	ft.in
17.5-25-16PR (L3)	+55	+121	+45	+99	+35	+77	2375	7'10"	395	1'4"	0	0"	0	0"
20.5-25-12PR (L2)	+280	+617	+215	+474	+190	+419	2470	8'1"	465	1'6"	+70	+2.8"	-70	-2.8"
20.5-25-12PR (L3)	+430	+948	+325	+717	+280	+617	2470	8'1"	465	1'6"	+70	+2.8"	-70	-2.8"
Install ROPS canopy (instead of cab)	-150	-331	-150	-331	-130	-287								
Additional counterweight	+300	+661	+580	+1,279	+510	+1,124								

Performance Data Dimensions

WHEEL LOADERS

WA250-5

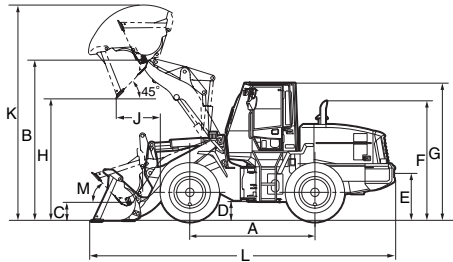

	17.5-25 tires	20.5-25 tires
Tread	1930 (6'4")	1930 (6'4")
Width over tires	2375 (7'10")	2470 (8'1")
A Wheelbase	2900 (9'6")	2900 (9'6")
B Hinge pin height, max. height	3725 (12'3")	3795 (12'5")
C Hinge pin height, carry position	375 (1'3")	450 (1'6")
D Ground clearance	395 (1'4")	465 (1'6")
E Hitch height	880 (2'11")	950 (3'1")
F Overall height, top of the stack	2665 (8'9")	2735 (9'0")
G Overall height, ROPS cab	3130 (10'3")	3200 (10'6")
M Tilt back angle	50°	

Measured with 17.5-25-16PR (L2) tires

Bucket type			Stockpile Bucket With Bolt-on Cutting Edge	Excavating Bucket With Bolt-on Cutting Edge	Light Material Bucket With Bolt-on Cutting Edge
Bucket capacity	Heaped	m ³ (yd ³)	2.3 (3.0)	1.9 (2.5)	2.7 (3.5)
	Struck	m ³ (yd ³)	2.0 (2.6)	1.6 (2.1)	2.3 (3.0)
Bucket width		mm (ft.in)	2685 (8'10")	2685 (8'10")	2685 (8'10")
Bucket weight		kg (lb)	960 (2,116)	905 (1,995)	1050 (2,315)
Static tipping load	Straight	kg (lb)	8985 (19,809)	9105 (20,073)	8825 (19,456)
	Full turn (40°)	kg (lb)	7900 (17,416)	8010 (17,659)	7910 (17,439)
H. Dumping clearance, max. height and 45° dump angle**		mm (ft.in)	2780 (9'1")	2855 (9'4")	2685 (8'10")
Reach at 2130 mm (7') and 45° dump angle**		mm (ft.in)	1535 (5'0")	1495 (4'11")	1580 (5'2")
J. Reach at max. height and 45° dump angle**		mm (ft.in)	1055 (3'6")	980 (3'3")	1150 (3'9")
Reach with arm horizontal and bucket level**		mm (ft.in)	2305 (7'7")	2200 (7'3")	2430 (8'0")
K. Operating height (fully raised)		mm (ft.in)	4995 (16'5")	4875 (16'0")	5130 (16'10")
L. Overall length, bucket on ground		mm (ft.in)	7055 (23'2")	6950 (22'10")	7185 (23'7")
Turning radius*		mm (ft.in)	5820 (19'0")	5780 (19'0")	5875 (19'3")
Digging depth	0°	mm (ft.in)	145 (5.7")	145 (5.7")	145 (5.7")
	10°	mm (ft.in)	335 (1'1")	315 (1'0")	355 (1'2")
Breakout force		kgf (lb)	12340 (27,205)	13850 (30,534)	11000 (24,251)
Operating weight		kg (lb)	10620 (23,413)	10565 (23,292)	10710 (23,611)

* Bucket at carry, outside corner of bucket.

** At the end of B.O.C.

- All dimensions, weights, and performance values based on SAE J732c and J742b standards.
- Static tipping load and operating weight shown include lubricant, coolant, full fuel tank, ROPS cab and operator.
- Machine stability and operating weight affected by counterweight, tire size, and other attachments.

Weight Changes

	Change in Operating Weight		Change in Tipping Load				Width Over Tire		Ground Clearance		Change in Vertical Dimensions		Change in Reach	
			Straight		Full Turn									
	kg	lb	kg	lb	kg	lb	mm	ft.in	mm	ft.in	mm	ft.in	mm	ft.in
17.5-25-16PR (L3)	+55	+121	+45	+99	+35	+77	2375	7'10"	395	1'4"	0	0"	0	0"
20.5-25-12PR (L2)	+280	+617	+215	+474	+190	+419	2470	8'1"	465	1'6"	+70	+2.8"	-70	-2.8"
20.5-25-12PR (L3)	+430	+948	+325	+717	+280	+617	2470	8'1"	465	1'6"	+70	+2.8"	-70	-2.8"
Install ROPS canopy (instead of cab)	-250	-551	-250	-551	-220	-485								
Additional counterweight	+300	+661	+580	+1,279	+510	+1,124								
Air conditioner	+70	+154	+50	+110	+40	+88								

Performance Data Dimensions

WHEEL LOADERS

WA250PZ-6

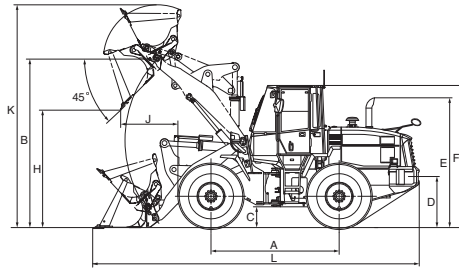

	Unit: mm (ft.in)	
Tread	17.5-25 tires	20.5-25 tires
Width over tires	1930 (6'4")	1930 (6'4")
A Wheelbase	2375 (7'10")	2470 (8'1")
B Hinge pin height, max. height	2900 (9'6")	2900 (9'6")
C Ground clearance	3895 (12'9")	3965 (13'0")
D Hitch height	395 (1'4")	465 (1'6")
E Overall height, top of the stack	880 (2'11")	950 (3'1")
F Overall height, ROPS cab	2855 (9'4")	2925 (9'7")
	3130 (10'2")	3200 (10'6")

Bucket

Measured with 20.5-25-16PR (L2) tires

Bucket type			Stockpile Bucket With Bolt-on Cutting Edge	
Bucket capacity	Heaped	m ³ (yd ³)	2.2 (2.9)	
	Struck	m ³ (yd ³)	2.1 (2.7)	
Bucket width		mm (ft.in)	2550 (8'4")	
Bucket weight		kg (lb)	960 (2,120)	
Static tipping load	Straight	kg (lb)	8940 (19,710)	
	Full turn (40°)	kg (lb)	7865 (17,340)	
H. Dumping clearance, max. height and 45° dump angle*		mm (ft.in)	2820 (9'3")	
Reach at 2130 mm (7') and 45° dump angle*		mm (ft.in)	1650 (5'5")	
J. Reach at max. height and 45° dump angle*		mm (ft.in)	1090 (3'7")	
Reach with boom/bucket level*		mm (ft.in)	3330 (10'11")	
K. Operating height (fully raised)		mm (ft.in)	5365 (17'7")	
L. Overall length, bucket on ground		mm (ft.in)	7410 (24'4")	
Digging depth	0°	mm (ft.in)	142 (5.6")	
	10°	mm (ft.in)	375 (1'3")	
Breakout force		kN/kgf (lb)	105/10730 (23,660)	
Operating weight		kg (lb)	12690 (27,980)	

* At the end of B.O.C.

- All dimensions, weights, and performance values based on SAE J732c and J742b standards.
- Static tipping load and operating weight shown include lubricant, coolant, full fuel tank, ROPS cab and operator.
- Machine stability and operating weight affected by counterweight, tire size, and other attachments.

Weight Changes

	Change in Operating Weight		Change in Tipping Load				Width Over Tire		Ground Clearance		Change in Vertical Dimensions		Change in Reach	
			Straight		Full Turn									
	kg	lb	kg	lb	kg	lb	mm	ft.in	mm	ft.in	mm	ft.in	mm	ft.in
17.5-25-16PR (L2)	-300	-661	-200	-441	-170	-375	2375	7'10"	395	1'4"	-70	-2.8"	+70	+2.8"
17.5-25-16PR (L3)	-260	-573	-170	-375	-150	-331	2375	7'10"	395	1'4"	-70	-2.8"	+70	+2.8"
20.5-25-12PR (L3)	+165	+364	+110	+243	+95	+209	2470	8'1"	465	1'6"	0	0"	0	0"
Install ROPS canopy (instead of cab)	-165	-364	-145	-320	-125	-276								

Performance Data Dimensions

WHEEL LOADERS

WA250PZ-6

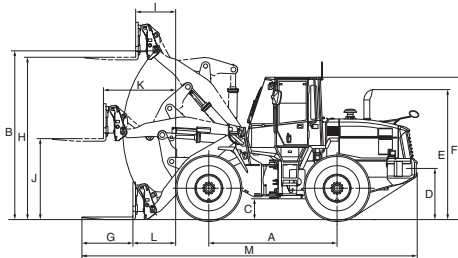

	Unit: mm (ft.in)	
Tread	17.5-25 tires	20.5-25 tires
Width over tires	1930 (6'4")	1930 (6'4")
A Wheelbase	2375 (7'10")	2470 (8'1")
B Hinge pin height, max. height	2900 (9'6")	2900 (9'6")
C Ground clearance	3895 (12'9")	3965 (13'0")
D Hitch height	395 (1'4")	465 (1'6")
E Overall height, top of the stack	880 (2'11")	950 (3'1")
F Overall height, ROPS cab	2855 (9'4")	2925 (9'7")
	3130 (10'3")	3200 (10'6")

Fork

Measured with 20.5-25-12PR (L2) tires

Static tipping load – boom level Fork level, 610 mm (24") load center	Straight	kg (lb)	6875 (15,160)
	Full turn (40°)	kg (lb)	5980 (13,180)
Operating weight		kg (lb)	12275 (27,060)
G. Fork tine length		mm (ft.in)	1220 (4'0")
H. Ground to top of tine at maximum lift		mm (ft.in)	3820 (12'6")
I. Reach at maximum lift		mm (ft.in)	790 (2'7")
J. Ground to top of Tine – boom and tine level		mm (ft.in)	1820 (6'0")
K. Reach – boom and tine level		mm (ft.in)	1690 (5'7")
L. Reach – tine level on ground		mm (ft.in)	1025 (3'4")
M. Overall length – tine level on ground		mm (ft.in)	7680 (25'2")
Operating load		kg (lb)	2990 (6,590)

Operating load per SAE J1197 (Feb. 1991), 50% of static tipping load.

Static tipping load and operating weight shown include lubricant, coolant, full fuel tank, ROPS cab and operator. Machine stability and operating weight affected by tire size and attachments.

Weight Changes

	Change in Operating Weight		Change in Tipping Load				Width Over Tire		Ground Clearance		Change in Vertical Dimensions		Change in Reach	
			Straight		Full Turn									
	kg	lb	kg	lb	kg	lb	mm	ft.in	mm	ft.in	mm	ft.in	mm	ft.in
17.5-25-12PR (L2)	-300	-661	-140	-309	-125	-276	2375	7'10"	395	1'4"	-70	-2.8"	+70	+2.8"
17.5-25-12PR (L3)	-260	-573	-125	-276	-110	-243	2375	7'10"	395	1'4"	-70	-2.8"	+70	+2.8"
20.5-25-12PR (L3)	+165	+364	+80	+176	+70	+154	2470	8'1"	465	1'6"	0	0"	0	0"
Install ROPS canopy (instead of cab)	-165	-364	-105	-231	-90	-198								

Performance Data Dimensions

WHEEL LOADERS

WA320-6

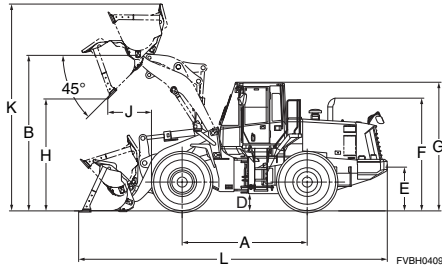

	Unit: mm (ft.in)
Tread	2050 (6'9")
Width over tires	2595 (8'6")
A Wheelbase	3030 (9'11")
B Hinge pin height, max. height	3905 (12'10")
C Hinge pin height, carry position	480 (1'7")
D Ground clearance	425 (1'5")
E Hitch height	1095 (3'7")
F Overall height, top of the stack	2915 (9'7")
G Overall height, ROPS cab	3200 (10'6")
M Tilt back angle	47°

Measured with 20.5-25-12PR (L3) tires

Bucket type			Stockpile Bucket		Excavating Bucket		Light Material Bucket	
			Bolt-on Cutting Edge	Teeth	Bolt-on Cutting Edge	Teeth	Bolt-on Cutting Edge	Teeth
Bucket capacity	Heaped	m ³ (yd ³)	2.8 (3.7)	2.6 (3.4)	2.3 (3.0)	2.1 (2.7)	3.2 (4.2)	3.0 (3.9)
	Struck	m ³ (yd ³)	2.4 (3.1)	2.2 (2.9)	2.0 (2.6)	1.8 (2.4)	2.8 (3.7)	2.6 (3.4)
Bucket width		mm (ft.in)	2740 (9'0")	2760 (9'1")	2740 (9'0")	2760 (9'1")	2685 (8'10")	2705 (8'10")
Bucket weight		kg (lb)	1230 (2,714)	1125 (2,480)	1195 (2,634)	1090 (2,403)	1410 (3,110)	1305 (2,877)
Static tipping load	Straight	kg (lb)	11520 (25,400)	11795 (26,005)	11735 (25,870)	11850 (26,125)	11595 (25,565)	11700 (25,795)
	Full turn (40°)	kg (lb)	10270 (22,640)	10550 (23,260)	10490 (23,130)	10600 (23,370)	10345 (22,810)	10450 (23,040)
H. Dumping clearance, max. height and 45° dump angle**		mm (ft.in)	2850 (9'4")	2740 (9'0")	2955 (9'8")	2845 (9'4")	2715 (8'11")	2665 (8'7")
Reach at 2130 mm (7') and 45° dump angle**		mm (ft.in)	1580 (5'2")	1615 (5'4")	1530 (5'0")	1565 (5'2")	1640 (5'5")	1665 (5'6")
J. Reach at max. height and 45° dump angle**		mm (ft.in)	1035 (3'5")	1125 (3'8")	930 (3'1")	1020 (3'4")	1170 (3'10")	1260 (4'2")
Reach with arm horizontal and bucket level**		mm (ft.in)	2525 (8'3")	2670 (9'1")	2380 (7'10")	2525 (8'3")	2720 (8'11")	2865 (9'5")
K. Operating height (fully raised)		mm (ft.in)	5325 (17'6")	5325 (17'6")	5135 (16'10")	5165 (16'11")	5405 (17'9")	5500 (18'1")
L. Overall length, bucket on ground		mm (ft.in)	7515 (24'8")	7600 (25'2")	7370 (24'2")	7515 (24'8")	7705 (25'3")	7850 (25'9")
Turning radius*		mm (ft.in)	6260 (20'6")	6310 (20'8")	6220 (20'5")	6270 (20'7")	6290 (20'8")	6345 (20'10")
Digging depth	0°	mm (ft.in)	85 (3.3")	100 (3.9")	85 (3.3")	100 (3.9")	85 (3.3")	100 (3.9")
	10°	mm (ft.in)	296 (11.7")	335 (1'1")	275 (10.8")	310 (1'1")	330 (1.1")	370 (1'3")
Breakout force		kN (kgf) (lb)	129 (13180) (29,060)	115 (11700) (25,795)	148 (15140) (33,380)	130 (13210) (29,125)	111 (11280) (24,870)	109 (11080) (24,430)
Operating weight		kg (lb)	13850 (30,535)	13745 (30,305)	13810 (30,450)	13705 (30,215)	14025 (30,920)	13920 (30,690)

* Bucket at carry, outside corner of bucket.

** At the end of tooth or B.O.C.

- All dimensions, weights, and performance values based on SAE J732c and J742b standards.
- Static tipping load and operating weight shown include lubricant, coolant, full fuel tank, ROPS cab, additional counterweight and operator.
- Machine stability and operating weight affected by counterweight, tire size, and other attachments.

Weight Changes

	Change in Operating Weight		Change in Tipping Load				Width Over Tire		Ground Clearance		Change in Vertical Dimensions	
			Straight		Full Turn							
	kg	lb	kg	lb	kg	lb	mm	ft.in	mm	ft.in	mm	ft.in
20.5-25-12PR (L2)	-210	-463	-165	-364	-164	-364	2590	8'6"	425	1'5"	0	0"
Install ROPS canopy (instead of cab)	-150	-331	-150	-371	-140	-309						
Additional counterweight	+520	+1,146	+1015	+2,238	+870	+1,918						

Performance Data Dimensions

WHEEL LOADERS

WA320PZ-6

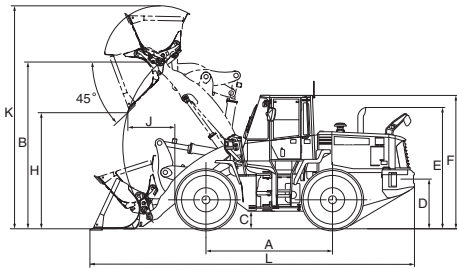

Unit: mm (ft.in)

Tread	2050 (6'9")
Width over tires	2590 (8'6")
A Wheelbase	3030 (9'11")
B Hinge pin height, max. height	4005 (13'2")
C Ground clearance	425 (1'5")
D Hitch height	1095 (3'7")
E Overall height, top of the stack	2915 (9'7")
F Overall height, ROPS cab	3200 (10'6")

Bucket

Measured with 20.5-25-12PR (L2) tires

Bucket type			Light Material Bucket With Bolt-on Cutting Edge
Bucket capacity	Heaped	m ³ (yd ³)	2.7 (3.5)
	Struck	m ³ (yd ³)	2.3 (3.0)
Bucket width		mm (ft.in)	2740 (9'0")
Bucket weight		kg (lb)	1140 (2,510)
Static tipping load	Straight	kg (lb)	10410 (22,950)
	Full turn (40°)	kg (lb)	9160 (20,190)
H. Dumping clearance, max. height and 45° dump angle*		mm (ft.in)	2800 (9'2")
Reach at 2130 mm (7') and 45° dump angle*		mm (ft.in)	1670 (5'6")
J. Reach at max. height and 45° dump angle*		mm (ft.in)	1130 (3'8")
Reach with boom/bucket level*		mm (ft.in)	2655 (8'9")
K. Operating height (fully raised)		mm (ft.in)	5355 (17'7")
L. Overall length, bucket on ground		mm (ft.in)	7770 (25'6")
Digging depth	0°	mm (ft.in)	130 (5.1")
	10°	mm (ft.in)	370 (1'3")
Breakout force		kN/kgf (lb)	141/14410 (31,770)
Operating weight		kg (lb)	15280 (33,690)

* At the end of B.O.C.

- All dimensions, weights, and performance values based on SAE J732c and J742b standards.
- Static tipping load and operating weight shown include lubricant, coolant, full fuel tank, ROPS cab and operator.
- Machine stability and operating weight affected by counterweight, tire size, and other attachments.

Fork

	Static tipping load - boom level Fork level, 610 mm 24" load center	Straight	kg (lb)	8235 (18,150)
		Full turn (40°)	kg (lb)	7055 (15,550)
			kg (lb)	14695 (32,400)
G	Fork tine length	mm (ft.in)	1220 (4'0")	
H	Ground to top of tine at maximum lift	mm (ft.in)	3810 (12'6")	
I	Reach at maximum lift	mm (ft.in)	835 (2'9")	
J	Ground to top of Tine - boom and tine level	mm (ft.in)	1795 (5'11")	
K	Reach - boom and tine level	mm (ft.in)	1730 (5'8")	
L	Reach - tine level on ground	mm (ft.in)	1100 (3'7")	
M	Overall Length - tine level on ground	mm (ft.in)	8035 (26'4")	
	Operating load	kg (lb)	3525 (7,770)	

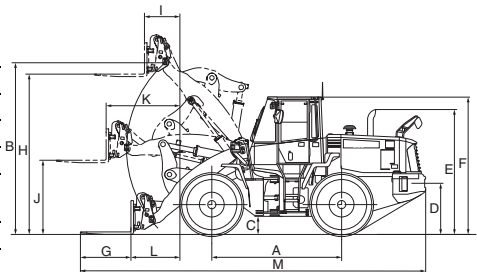

Operating load per SAE J1197 (Feb. 1991), 50% of static tipping load.

Static tipping load and operating weight shown include lubricant, coolant, full fuel tank, ROPS cab and operator. Machine stability and operating weight affected by tire size and attachments.

Weight Changes

	Change in Operating Weight		Change in Tipping Load				Width Over Tire		Ground Clearance		Change in Vertical Dimensions		Change in Reach	
	kg	lb	Straight		Full Turn		mm	ft.in	mm	ft.in	mm	ft.in	mm	ft.in
			kg	lb	kg	lb								
20.5-25-12PR (L3)	+165	+364	+105	+231	+95	+209	2590	8'6"	425	1'5"	0	0"	0	0"
Install ROPS canopy (instead of cab)	-290	-639	-135	-298	-120	-265								

Performance Data Dimensions

WHEEL LOADERS

WA320-5

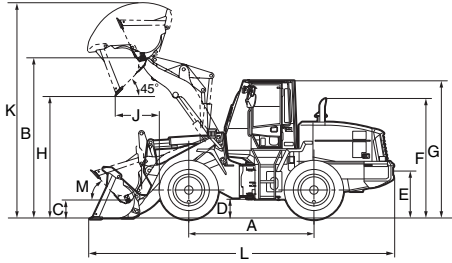

Unit: mm (ft.in)

Tread	2050 (6'9")
Width over tires	2585 (8'6")
A Wheelbase	3030 (9'11")
B Hinge pin height, max. height	3905 (12'10")
C Hinge pin height, carry position	480 (1'7")
D Ground clearance	425 (1'5")
E Hitch height	1095 (3'7")
F Overall height, top of the stack	2775 (9'1")
G Overall height, ROPS cab	3200 (10'6")
M Tilt back angle	49°

Measured with 20.5-25-12PR (L3) tires

Bucket type			Stockpile Bucket With Bolt-on Cutting Edge	Excavating Bucket With Bolt-on Cutting Edge	Light Material Bucket With Bolt-on Cutting Edge
Bucket capacity	Heaped	m ³ (yd ³)	2.8 (3.7)	2.3 (3.0)	3.2 (4.2)
	Struck	m ³ (yd ³)	2.4 (3.1)	2.0 (2.6)	2.8 (3.7)
Bucket width		mm (ft.in)	2740 (9'0")	2740 (9'0")	2740 (9'0")
Bucket weight		kg (lb)	1240 (2,734)	1330 (2,932)	1430 (3,153)
Static tipping load	Straight	kg (lb)	11250 (24,802)	11160 (24,604)	11060 (24,383)
	Full turn (40°)	kg (lb)	9800 (21,605)	9720 (21,429)	9630 (21,230)
H. Dumping clearance, max. height and 45° dump angle**		mm (ft.in)	2850 (9'4")	2955 (9'8")	2715 (8'11")
Reach at 2130 mm (7') and 45° dump angle**		mm (ft.in)	1570 (5'2")	1675 (5'6")	1435 (4'8")
J. Reach at max. height and 45° dump angle**		mm (ft.in)	1035 (3'5")	930 (3'1")	1170 (3'10")
Reach with arm horizontal and bucket level**		mm (ft.in)	2420 (7'11")	2275 (7'6")	2610 (8'7")
K. Operating height (fully raised)		mm (ft.in)	5330 (17'6")	5145 (16'11")	5415 (17'9")
L. Overall length, bucket on ground		mm (ft.in)	7455 (24'6")	7310 (24'0")	7645 (25'1")
Turning radius*		mm (ft.in)	6090 (20'0")	6030 (19'9")	6165 (20'2")
Digging depth	0°	mm (ft.in)	85 (3.3")	85 (3.3")	85 (3.3")
	10°	mm (ft.in)	296 (11.7")	275 (10.8")	322 (12.7")
Breakout force		kgf (lb)	13180 (29,057)	15100 (33,290)	11280 (24,868)
Operating weight		kg (lb)	13520 (29,806)	13610 (30,005)	13710 (30,225)

* Bucket at carry, outside corner of bucket.

** At the end of tooth or B.O.C.

- All dimensions, weights, and performance values based on SAE J732c and J742b standards.
- Static tipping load and operating weight shown include lubricant, coolant, full fuel tank, ROPS cab, additional counterweight and operator.
- Machine stability and operating weight affected by counterweight, tire size, and other attachments.

Weight Changes

	Change in Operating Weight		Change in Tipping Load				Width Over Tire		Ground Clearance		Change in Vertical Dimensions	
	kg	lb	Straight		Full Turn		mm	ft.in	mm	ft.in	mm	ft.in
			kg	lb	kg	lb						
20.5-25-12PR (L2)	-160	-353	-120	-265	-104	-229	2585	8'6"	425	1'5"	0	0"
Install ROPS canopy (instead of cab)	-150	-331	-107	-236	-93	-205						
Additional counterweight	+520	+1,146	+1010	+2,227	+880	+1,940						
Air conditioner	+70	+154	+90	+198	+80	+176						

Performance Data Dimensions

WHEEL LOADERS

WA320-3 CUSTOM

	Capacity Heaped m ³ (cu.yd)	Struck m ³ (cu.yd)	Bucket width mm (ft.in)	Bucket weight kg (lb)	Breakout force kgf (lb)
I General-purpose bucket with bolt-on cutting edges; (Loading and excavating of soil, sand and variety of other commonly handled materials.)	2.7 (3.53)	2.3 (3.01)	2740 (9')	1245 (2,745)	13050 (28,770)
II General-purpose bucket with teeth	2.5 (3.0)	1.95 (2.55)	2760 (9'1")	1125 (2,720)	14680 (32,360)
III Excavating bucket with bolt-on cutting edges	2.3 (3.0)	1.95 (2.55)	2740 (9')	1320 (2,910)	14010 (30,890)
IV Excavating bucket with teeth (Loading and excavating of crushed rock and blasted rock.)	2.1 (2.75)	1.8 (2.35)	2760 (9'1")	1210 (2,670)	15490 (34,150)
V Light material bucket with bolt-on cutting edges; (A Lighter-weight, large-capacity bucket.)	3.2 (4.2)	2.8 (3.7)	2740 (9')	1430 (3,150)	10450 (23,040)

Tires/ Buckets	Operating weight kg(lb)				Static tipping load kg(lb)											
					Straight				35° turn				40° full turn			
	I	II	III	IV	I	II	III	IV	I	II	III	IV	I	II	III	IV
20.5-25- 12PR (L-3)	12970 (2,8590)	12850 (2,8330)	13045 (2,8760)	12935 (2,8515)	10560 (2,3280)	10440 (2,3015)	10635 (2,3445)	10525 (2,3205)	9505 (2,0950)	9385 (2,0690)	9580 (2,1120)	9470 (2,0880)	9185 (2,0250)	9065 (1,9985)	9260 (2,0415)	9150 (2,0170)

- All dimensions, weights and performance values based on SAE J-732c and J-742b standards.
- Static tipping load and operating weight shown include lubricant, coolant, full fuel tank, ROPS cab, and operator.
- Machine stability and operating weight are affected by counterweight, tire size and other attachments.
Apply the following weight changes to operating weight and static tipping load.

Weight Changes

	Change in operating weight kg (lb)	Change in tipping load kg (lb)	
		Straight	Full turn
Remove ROPS cab	-310 (-683)	-280 (-620)	-245 (-540)
Install additional counterweight 325 kg (715 lb)	+325 (+715)	+830 (+1,830)	+690 (+1,520)

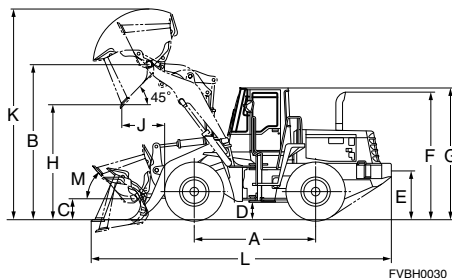

	Unit: mm (ft.in)
Tread	2050 (6'9")
Width over tires	2585 (8'6")
A Wheelbase	3030 (9'11")
B Hinge pin height, max. height	3885 (12'9")
C Hinge pin height, carry position	450 (1'6")
D Ground clearance	400 (1'4")
E Hitch height	1190 (3'11")
F Overall height, top of the stack	3235 (10'6")
G Overall height, ROPS cab	3335 (10'11")
M Tilt back angle	48°

Measured with 17.5-25 tires

	Unit: mm (ft.in)			
Buckets	I	II	III	IV
H. Dumping clearance, max. height and 45° dump angle**	2850 (9'4")	2715 (8'11")	2935 (9'8")	2800 (9'2")
Reach at 2130 mm (7') cut edge clearance and 45° dump angle	1570 (5'2")	1600 (5'3")	1530 (5')	1560 (5'1")
J. Reach at max. height and 45° dump angle**	1035 (3'5")	1155 (3'9")	950 (3'1")	1070 (3'6")
Reach with arm horizontal and bucket level	2395 (7'10")	2520 (8'3")	2275 (7'6")	2400 (7'10")
K. Operating height (fully raised)	5265 (17'3")	5265 (17'3")	5110 (16'9")	5110 (16'9")
L. Overall length	7410 (24'4")	7535 (24'9")	7290 (23'11")	7415 (24'4")
Turning radius*	6080 (19'11")	6125 (20'1")	6045 (19'10")	6090 (20'0")
Digging depth	0°	90 (3.5")	105 (4.1")	90 (3.5")
	10°	295 (11.6")	330 (1'13")	275 (10.8")
		310 (12'2")		

* Bucket at carry, outside corner of bucket.

** At the end of teeth or B.O.C.

Performance Data Dimensions

WHEEL LOADERS

WA380-6

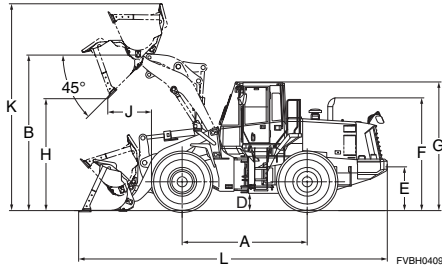

	Unit: mm (ft.in)
Tread	2160 (7'1")
Width over tires	2695 (8'10")
A Wheelbase	3300 (10'10")
B Hinge pin height, max. height	4030 (13'3")
C Hinge pin height, carry position	520 (1'8")
D Ground clearance	390 (1'3")
E Hitch height	1085 (3'7")
F Overall height, top of the stack	2885 (9'6")
G Overall height, ROPS cab	3315 (10'11")
M Tilt back angle	50°

Measured with 20.5-25-16PR (L3) tires

Bucket type			General Purpose Buckets		Excavating Buckets			Light Material Bucket
			Bolt-on Cutting Edges	Teeth	Bolt-on Cutting Edges	Teeth and Segments	Teeth	Bolt-on Cutting Edges
Bucket capacity	Heaped	m ³ (yd ³)	3.3 (4.3)	3.1 (4.1)	2.9 (3.8)	2.9 (3.8)	2.7 (3.5)	4.0 (5.2)
	Struck	m ³ (yd ³)	2.9 (3.8)	2.7 (3.5)	2.4 (3.1)	2.4 (3.1)	2.3 (3.0)	3.4 (4.4)
Bucket width		mm (ft.in)	2905 (9'6")	2925 (9'7")	2905 (9'6")	2925 (9'7")	2925 (9'7")	2905 (9'6")
Bucket weight		kg (lb)	1620 (3,570)	1540 (3,395)	1720 (3,790)	1765 (3,890)	1645 (3,627)	1835 (4,045)
Static tipping load	Straight	kg (lb)	13880 (30,600)	13970 (30,800)	13780 (30,380)	13710 (30,230)	13870 (30,580)	13640 (30,070)
	Full turn	kg (lb)	12000 (26,460)	12100 (26,680)	11900 (26,230)	11840 (26,100)	12000 (26,460)	11770 (25,950)
H. Dumping clearance, max. height and 45° dump angle**		mm (ft.in)	2885 (9'6")	2755 (9'0")	2960 (9'9")	2840 (9'4")	2840 (9'4")	2790 (9'2")
Reach at 2130 mm (7') clearance and 45° dump angle		mm (ft.in)	1210 (4'0")	1305 (4'3")	1125 (3'8")	1225 (4'0")	1225 (4'0")	1295 (4'3")
J. Reach at max. height and 45° dump angle**		mm (ft.in)	1760 (5'9")	1790 (5'10")	1720 (5'8")	1755 (5'9")	1755 (5'9")	1800 (5'11")
Reach with arm horizontal and bucket level		mm (ft.in)	2650 (8'8")	2810 (9'3")	2510 (8'3")	2680 (8'10")	2680 (8'10")	2775 (9'1")
K. Operating height (fully raised)		mm (ft.in)	5535 (18'2")	5535 (18'2")	5420 (17'9")	5420 (17'9")	5420 (17'9")	5670 (18'7")
L. Overall length		mm (ft.in)	8195 (26'11")	8365 (27'5")	8055 (26'5")	8225 (27'0")	8225 (27'0")	8320 (27'4")
Turning radius		mm (ft.in)	7220 (23'8")	7275 (23'10")	7185 (23'7")	7240 (23'9")	7240 (23'9")	7250 (23'9")
Digging depth	0°	mm (ft.in)	125 (4.9")	140 (5.5")	125 (4.9")	140 (5.5")	140 (5.5")	125 (4.9")
	10°	mm (ft.in)	360 (14'2")	400 (15'7")	335 (13'2")	380 (15'0")	380 (15'0")	380 (15'0")
Breakout force		kN kgf (lb)	158 16100 (35,495)	170 17300 (38,140)	176.5 18000 (39,680)	183 18700 (41,225)	191 19500 (42,990)	144 14700 (32,405)
Operating weight		kg (lb)	16610 (36,620)	16540 (36,460)	16720 (36,860)	16760 (36,950)	16650 (36,710)	16850 (37,150)

* Bucket at carry, outside corner of bucket.

** At the end of tooth or B.O.C.

- All dimensions, weights, and performance values based on SAE J732c and J742b standards.
- Static tipping load and operating weight shown include lubricant, coolant, full fuel tank, ROPS cab and operator.
- Machine stability and operating weight affected by counterweight, tire size, and other attachments. Apply the following weight changes to operating weight and static tipping load.

Weight Changes

	Change in Operating Weight		Change in Tipping Load				Width Over Tire		Ground Clearance		Change in Vertical Dimensions	
			Straight		Full Turn							
	kg	lb	kg	lb	kg	lb	mm	ft.in	mm	ft.in	mm	ft.in
20.5-25-16PR (L3)	0	0	0	0	0	0	2,695	8'10"	390	1'3"	0	0"
23.5-25-16PR (L3)	+970	+2,140	+770	+1,700	+680	+1,500	2,780	9'1"	455	1'6"	+65	3"
Install additional counterweight	+340	+750	+900	+1,985	+755	+1,655						

Performance Data Dimensions

WHEEL LOADERS

WA380Z-6 (Japan source)

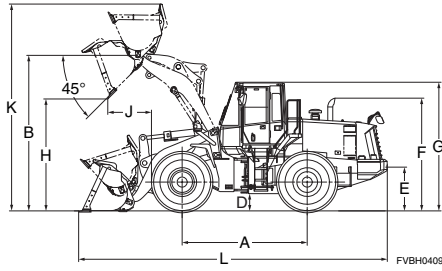

	Unit: mm (ft.in)
Tread	2160 (7'1")
Width over tires	2780 (9'1")
A Wheelbase	3300 (10'10")
B Hinge pin height, max. height	4095 (13'5")
C Hinge pin height, carry position	520 (1'8")
D Ground clearance	455 (1'6")
E Hitch height	1150 (3'9")
F Overall height, top of the stack	2975 (9'9")
G Overall height, ROPS cab	3390 (11'2")
M Tilt back angle	50°

Measured with 23.5-25-16PR (L3) tires, ROPS/FOPS cab

Bucket type			General Purpose Buckets		Excavating Buckets			Light Material Bucket
			Bolt-on Cutting Edges	Teeth	Bolt-on Cutting Edges	Teeth and Segments	Teeth	Bolt-on Cutting Edges
Bucket capacity	Heaped	m ³ (yd ³)	3.3 (4.3)	3.1 (4.1)	2.9 (3.8)	2.9 (3.8)	2.7 (3.5)	4.0 (5.2)
	Struck	m ³ (yd ³)	2.9 (3.8)	2.7 (3.5)	2.4 (3.1)	2.4 (3.1)	2.3 (3.0)	3.4 (4.4)
Bucket width		mm (ft.in)	2905 (9'6")	2925 (9'7")	2905 (9'6")	2925 (9'7")	2925 (9'7")	2905 (9'6")
Bucket weight		kg (lb)	1620 (3,571)	1540 (3,395)	1720 (3,792)	1765 (3,891)	1645 (3,627)	1835 (4,045)
Static tipping load	Straight	kg (lb)	14415 (31,780)	14560 (32,100)	14360 (31,660)	14335 (31,600)	14485 (31,930)	14075 (31,030)
	Full turn	kg (lb)	12470 (27,490)	12610 (27,800)	12410 (27,360)	12380 (27,290)	12530 (27,620)	12140 (26,760)
H. Dumping clearance, max. height and 45° dump angle**		mm (ft.in)	2950 (9'8")	2825 (9'3")	3025 (9'11")	2905 (9'6")	2905 (9'6")	2855 (9'4")
Reach at 2130 mm (7') clearance and 45° dump angle		mm (ft.in)	1730 (5'8")	1765 (5'9")	1675 (5'6")	1715 (5'8")	1715 (5'8")	1755 (5'9")
J. Reach at max. height and 45° dump angle**		mm (ft.in)	1150 (3'9")	1240 (4'1")	1045 (3'5")	1140 (3'9")	1140 (3'9")	1220 (4'0")
Reach with arm horizontal and bucket level		mm (ft.in)	2585 (8'6")	2450 (8'0")	2445 (8'0")	2615 (8'7")	2615 (8'7")	2710 (8'11")
K. Operating height (fully raised)		mm (ft.in)	5600 (18'4")	5600 (18'4")	5485 (18'0")	5485 (18'0")	5485 (18'0")	5735 (18'10")
L. Overall length		mm (ft.in)	8140 (26'8")	8295 (27'3")	8000 (26'3")	8155 (26'9")	8155 (26'9")	8265 (27'1")
Turning radius		mm (ft.in)	7210 (23'8")	7260 (23'10")	7175 (23'6")	7185 (23'7")	7225 (23'8")	7240 (23'9")
Digging depth	0°	mm (ft.in)	60 (2.4")	75 (3.0")	60 (2.4")	75 (3.0")	75 (3.0")	60 (2.4")
	10°	mm (ft.in)	290 (11.4")	335 (1'1")	270 (10.6")	315 (12.4")	315 (12.4")	315 (12.4")
Breakout force		kN kgf (lb)	158 16100 (35,490)	170 17300 (38,140)	176 18000 (39,680)	183 18700 (41,230)	191 19500 (42,990)	144 14700 (32,410)
Operating weight		kg (lb)	17200 (37,920)	17130 (37,760)	17300 (38,140)	17350 (38,250)	17230 (37,990)	17420 (38,400)

* Bucket at carry, outside corner of bucket.

** At the end of B.O.C. or teeth

- All dimensions, weights, and performance values based on SAE J732c and J742b standards.
- Static tipping load and operating weight shown include lubricant, coolant, full fuel tank, ROPS cab and operator.
- Machine stability and operating weight affected by counterweight, tire size, and other attachments.

Weight Changes

	Change in Operating Weight		Change in Tipping Load				Width Over Tire		Ground Clearance		Change in Vertical Dimensions	
			Straight		Full Turn							
	kg	lb	kg	lb	kg	lb	mm	ft.in	mm	ft.in	mm	ft.in
20.5-25-16PR (L3)	-970	-2138	-770	-1698	-680	-1499	2695	8'10"	390	1'3"	-65	-2.6"
Install additional counterweight	+340	+750	+900	+1984	+755	+1664						

Performance Data Dimensions

WHEEL LOADERS

WA380-5

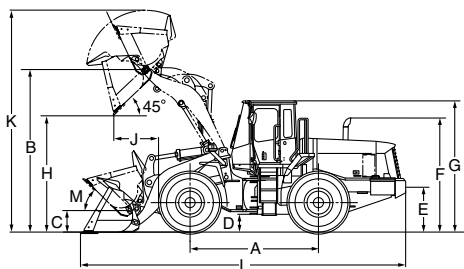

Unit: mm (ft.in)

Tread	2160 (7'1")
Width over tires	2695 (8'10")
A Wheelbase	3300 (10'10")
B Hinge pin height, max. height	4030 (13'3")
C Hinge pin height, carry position	520 (1'8")
D Ground clearance	390 (1'3")
E Hitch height	1085 (3'7")
F Overall height, top of the stack	2885 (9'6")
G Overall height, ROPS cab	3315 (10'11")
M Tilt back angle	50°

Measured with 20.5-25-16PR (L3) tires

Bucket type			General Purpose Buckets		Excavating Buckets			Light Material Bucket
			Bolt-on Cutting Edges	Teeth	Bolt-on Cutting Edges	Teeth and Segments	Teeth	Bolt-on Cutting Edges
Bucket capacity	Heaped	m ³ (yd ³)	3.3 (4.3)	3.1 (4.1)	2.9 (3.8)	2.9 (3.8)	2.7 (3.5)	4.0 (5.2)
	Struck	m ³ (yd ³)	2.9 (3.8)	2.7 (3.5)	2.4 (3.1)	2.4 (3.1)	2.3 (3.0)	3.4 (4.4)
Bucket width		mm (ft.in)	2905 (9'6")	2925 (9'7")	2905 (9'6")	2925 (9'7")	2925 (9'7")	2905 (9'6")
Bucket weight		kg (lb)	1645 (3,627)	1570 (3,461)	1720 (3,792)	1765 (3,891)	1645 (3,627)	1835 (4,045)
Static tipping load	Straight	kg (lb)	12880 (28,395)	12955 (28,561)	12805 (28,230)	12760 (28,131)	12880 (28,395)	12690 (27,976)
	40° full turn	kg (lb)	11200 (24,692)	11275 (24,857)	11125 (24,526)	11080 (24,427)	11200 (24,692)	11010 (24,273)
H. Dumping clearance, max. height and 45° dump angle**		mm (ft.in)	2885 (9'6")	2755 (9'0")	2960 (9'9")	2840 (9'4")	2840 (9'4")	2790 (9'2")
Reach at 2130 mm (7") clearance and 45° dump angle		mm (ft.in)	1760 (5'9")	1790 (5'10")	1720 (5'8")	1755 (5'9")	1755 (5'9")	1800 (5'11")
J. Reach at max. height and 45° dump angle**		mm (ft.in)	1210 (4'0")	1305 (4'3")	1125 (3'8")	1225 (4'0")	1225 (4'0")	1295 (4'3")
Reach with arm horizontal and bucket level		mm (ft.in)	2650 (8'8")	2810 (9'3")	2535 (8'4")	2695 (8'10")	2695 (8'10")	2775 (9'1")
K. Operating height (fully raised)		mm (ft.in)	5520 (18'1")	5520 (18'1")	5405 (17'9")	5405 (17'9")	5405 (17'9")	5655 (18'7")
L. Overall length		mm (ft.in)	8195 (26'11")	8350 (27'5")	8080 (26'6")	8235 (27'0")	8235 (27'0")	8320 (27'4")
Turning radius		mm (ft.in)	6580 (21'7")	6635 (21'9")	6545 (21'6")	6600 (21'8")	6600 (21'8")	6610 (21'8")
Digging depth	0°	mm (ft.in)	125 (4.9")	140 (5.5")	125 (4.9")	140 (5.5")	140 (5.5")	125 (4.9")
	10°	mm (ft.in)	360 (1'2")	400 (1'4")	335 (1'1")	380 (1'3")	380 (1'3")	380 (1'3")
Breakout force		kN kgf (lb)	148 15080 (33,245)	160 16315 (35,968)	163 16621 (36,642)	168 17131 (37,766)	177 18048 (39,789)	135 13766 (30,348)
Operating weight		kg (lb)	16230 (35,781)	16160 (35,626)	16310 (35,957)	16350 (36,045)	16230 (35,781)	16420 (36,200)

* Bucket at carry, outside corner of bucket.

** At the end of tooth or B.O.C.

- All dimensions, weights, and performance values based on SAE J732c and J742b standards.
- Static tipping load and operating weight shown include lubricant, coolant, full fuel tank, ROPS cab and operator.
- Machine stability and operating weight affected by counterweight, tire size, and other attachments. Apply the following weight changes to operating weight and static tipping load.

Weight Changes

	Change in Operating Weight		Change in Tipping Load				Width Over Tire		Ground Clearance		Change in Vertical Dimensions	
			Straight		Full Turn							
	kg	lb	kg	lb	kg	lb	mm	ft.in	mm	ft.in	mm	ft.in
20.5-25-16PR (L3)	0	0	0	0	0	0	2,695	8'10"	390	1'3"	0	0"
23.5-25-16PR (L3)	+1080	+2,381	+740	+1,632	+650	+1,433	2,780	9'1"	460	1'6"	+65	2.6"
Remove ROPS cab	-660	-1,455	-650	-1,433	-625	-1,378						
Install front/rear compartment	+120	+265	+120	+265	+115	+254						
Install additional counterweight	+325	+717	+860	+1,896	+715	+1,577						

Performance Data Dimensions

WHEEL LOADERS

WA380-5 (with high lift boom)

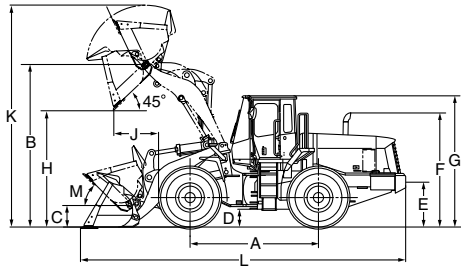

	Unit: mm (ft.in)
Tread	2160 (7'1")
Width over tires	2695 (8'10")
A Wheelbase	3330 (10'10")
B Hinge pin height, max. height	4560 (15'0")
C Hinge pin height, carry position	685 (2'3")
D Ground clearance	390 (1'3")
E Hitch height	1085 (3'7")
F Overall height, top of the stack	2885 (9'6")
G Overall height, ROPS cab	3315 (10'15")
M Tilt back angle	50°

Measured with 20.5-25-16PR (L3) tires

Bucket type			High-lift Bucket With Bolt-on Cutting Edge	High-lift Bucket With Teeth
Bucket capacity	Heaped	m ³ (yd ³)	2.9 (3.8)	2.7 (3.5)
	Struck	m ³ (yd ³)	2.4 (3.1)	2.3 (3.0)
Bucket width		mm (ft.in)	2905 (9'6")	2915 (9'7")
Bucket weight		kg (lb)	1720 (3,792)	1645 (3,627)
Static tipping load	Straight	kg (lb)	12020 (26,500)	12105 (26,685)
	Full turn (40°)	kg (lb)	10460 (23,060)	10535 (23,225)
H. Dumping clearance, max. height and 45° dump angle**		mm (ft.in)	3510 (11'6")	3400 (11'2")
Reach at 2130 mm (7') clearance and 45° dump angle		mm (ft.in)	2240 (7'4")	2305 (7'7")
J. Reach at max. height and 45° dump angle**		mm (ft.in)	1250 (4'1")	1360 (4'6")
Reach with arm horizontal and bucket level		mm (ft.in)	3000 (9'10")	3155 (10'4")
Operating height (fully raised)		mm (ft.in)	5920 (19'5")	5920 (19'5")
Overall length		mm (ft.in)	8800 (28'10")	8955 (29'5")
Turning radius*		mm (ft.in)	6800 (22'4")	6855 (22'6")
Digging depth	0°	mm (ft.in)	180 (7")	195 (8")
	10°	mm (ft.in)	385 (1'3")	415 (1'4")
Breakout force		kN	161.5	176
		kgf	16470	17950
		(lb)	(36,310)	(39,570)
Operating weight		kg (lb)	17200 (37,920)	17125 (37,750)

* Bucket at carry, outside corner of bucket.

** At the end of tooth or B.O.C.

- All dimensions, weights, and performance values based on SAE J732c and J742b standards.
- Static tipping load and operating weight shown include lubricant, coolant, full fuel tank, ROPS cab and operator.
- Machine stability and operating weight affected by counterweight, tire size, and other attachments. Apply the following weight changes to operating weight and static tipping load.

Weight Changes

	Change in Operating Weight		Change in Tipping Load				Width Over Tire		Ground Clearance		Change in Vertical Dimensions	
			Straight		Full Turn							
	kg	lb	kg	lb	kg	lb	mm	ft.in	mm	ft.in	mm	ft.in
20.5-25-16PR (L3)	0	0	0	0	0	0	2695	8'10"	390	1'3"	0	0"
23.5-25-16PR (L3)	+1080	+2,381	+740	+1,632	+650	+1,433	2780	9'1"	460	1'6"	+65	+2.6"
Remove ROPS cab	-660	-1,455	-650	-1,433	-625	-1,378						
Install front/rear compartment	+120	+265	+120	+265	+115	+254						
Install additional counterweight	+325	+717	+860	+1,896	+715	+1,577						

**Performance Data
Dimensions**

WHEEL LOADERS

WA380-3

	Capacity Heaped m ³ (cu.yd)	Struck m ³ (cu.yd)	Bucket width mm (ft.in)	Bucket weight kg (lb)	Breakout force kgf (lb)
I General-purpose bucket with bolt-on cutting edges; (Loading and excavating of soil, sand and variety of other commonly handled materials.)	3.2 (4.2)	2.7 (3.55)	2905 (9'6")	1630 (3,590)	15100 (33,300)
II General-purpose bucket with teeth	3.0 (3.9)	2.6 (3.4)	2920 (9'7")	1560 (3,440)	16300 (36,000)
III Excavating bucket with bolt-on cutting edges	2.8 (3.65)	2.35 (3.07)	2905 (9'6")	1710 (3,770)	16600 (36,600)
IV Excavating bucket with teeth (Loading and excavating of crushed rock and blasted rock.)	2.6 (3.4)	2.2 (2.9)	2920 (9'7")	1640 (3,620)	18100 (39,900)
V Light material bucket with bolt-on cutting edges; (A Lighter-weight, large-capacity bucket.)	4.0 (5.25)	3.4 (4.45)	2905 (9'6")	1830 (4,030)	13100 (28,900)

Tires/Buckets	Operating weight kg(lb)			
	I	II	III	IV
20.5-25-16PR (L-2)	16285 (3,5910)	16215 (35,755)	16365 (36,085)	16295 (35,930)
20.5-25-16PR (L-3)	16480 (36,340)	16410 (36,185)	16560 (36,515)	16490 (36,360)
23.5-25-12PR (L-2)	17030 (37,550)	16960 (37,400)	17110 (37,730)	17040 (37,575)
23.5-25-12PR (L-3)	17335 (38,225)	17265 (38,070)	17415 (38,400)	17345 (38,250)
23.5-25-16PR (L-2)	17070 (37,640)	17000 (37,485)	17150 (37,820)	17080 (37,660)
23.5-25-16PR (L-3)	17445 (38,470)	17375 (38,315)	17525 (38,645)	17455 (38,490)
23.5-25-20PR (L-2)	17135 (37,785)	17065 (37,630)	17215 (37,960)	17145 (37,805)
23.5-25-20PR (L-3)	17445 (38,470)	17375 (38,315)	17525 (38,645)	17455 (38,490)

Tires/Buckets	Static tipping load kg(lb)											
	Straight				35° turn				40° full turn			
	I	II	III	IV	I	II	III	IV	I	II	III	IV
20.5-25-16PR (L-2)	12480 (27,515)	12550 (27,665)	12385 (27,305)	12450 (27,455)	11180 (24,650)	11240 (24,790)	11090 (24,460)	11155 (24,600)	10805 (23,830)	10865 (23,960)	10720 (23,645)	10780 (23,775)
20.5-25-16PR (L-3)	12630 (27,845)	12700 (27,995)	12530 (27,635)	12600 (27,785)	11320 (24,950)	11375 (25,080)	11230 (24,760)	11290 (24,895)	10935 (24,115)	10995 (24,245)	10850 (23,930)	10910 (24,060)
23.5-25-12PR (L-2)	13050 (28,780)	13120 (28,930)	12955 (28,565)	13025 (28,720)	11700 (25,785)	11755 (25,920)	11610 (25,595)	11670 (25,730)	11300 (24,925)	11360 (25,055)	11220 (24,740)	11280 (24,870)
23.5-25-12PR (L-3)	13285 (29,295)	13355 (29,445)	13190 (29,085)	13260 (29,235)	11910 (26,250)	11965 (26,385)	11820 (26,060)	11880 (26,195)	11505 (25,370)	11565 (25,500)	11420 (25,190)	11480 (25,320)
23.5-25-16PR (L-2)	13080 (28,845)	13150 (28,995)	12985 (28,635)	13055 (28,785)	11725 (25,845)	11780 (25,980)	11635 (25,655)	11695 (25,790)	11330 (24,980)	11390 (25,110)	11245 (24,800)	11305 (24,930)
23.5-25-16PR (L-3)	13370 (29,480)	13440 (29,635)	13275 (29,270)	13345 (29,425)	11980 (26,415)	12040 (26,550)	11895 (26,225)	11955 (26,360)	11580 (25,535)	11640 (25,665)	11495 (25,350)	11555 (25,480)
23.5-25-20PR (L-2)	13130 (28,955)	13200 (29,105)	13035 (28,745)	13105 (28,895)	11770 (25,945)	11830 (26,080)	11680 (25,755)	11740 (25,890)	11370 (25,080)	11430 (25,210)	11290 (24,895)	11350 (25,025)
23.5-25-20PR (L-3)	13370 (29,480)	13440 (29,635)	13275 (29,270)	13345 (29,425)	11980 (26,415)	12040 (26,550)	11895 (26,225)	11955 (26,360)	11580 (25,535)	11640 (25,665)	11495 (25,350)	11555 (25,480)

- All dimensions, weights and performance values based on SAE J-732c and J-742b standards.
- Static tipping load and operating weight shown include lubricant, coolant, full fuel tank, steel cab, ROPS cab and operator.
- Machine stability and operating weight are affected by counterweight, tire size and other attachments. Apply the following weight changes to operating weight and static tipping load.

Weight Changes

	Change in operating weight kg (lb)	Change in tipping load kg (lb)	
		Straight	Full turn
Remove ROPS cab	-670 (-1,475)	-610 (-1,345)	-590 (-1,300)
Install additional counterweight 325 kg (715 lb)	+325 (+715)	+830 (+1,835)	+690 (+1,520)

Performance Data Dimensions

WHEEL LOADERS

WA380-3

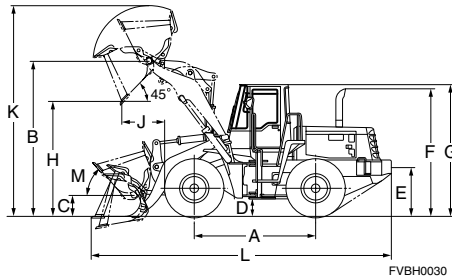

	20.5-25 tires	23.5-25 tires
Tread	2160 (7'1")	2160 (7'1")
Width over tires	2695 (8'10")	2780 (9'1")
A Wheelbase	3200 (10'6")	3200 (10'6")
B Hinge pin height, max. height	4030 (13'3")	4095 (13'5")
C Hinge pin height, carry position	520 (1'8")	505 (1'8")
D Ground clearance	390 (1'3")	455 (1'6")
E Hitch height	1085 (3'7")	1150 (3'9")
F Overall height, top of the stack	3280 (10'9")	3345 (11')
G Overall height, ROPS cab	3315 (10'10")	3380 (11'1")
M Tilt back angle		48°

Measured with 20.5-25 tires

	Buckets	I	II	III	IV
H. Dumping clearance, max. height and 45° dump angle**		2925 (9'7")	2800 (9'2")	3005 (9'10")	2880 (9'5")
Reach at 2130 mm (7') cut edge clearance and 45° dump angle		1745 (5'9")	1780 (5'10")	1705 (5'7")	1740 (5'9")
J. Reach at max. height and 45° dump angle**		1170 (3'10")	1270 (4'2")	1090 (3'7")	1190 (3'11")
Reach with arm horizontal and bucket level		2590 (8'6")	2745 (9')	2480 (8'2")	2635 (8'8")
K. Operating height (fully raised)		5455 (17'11")	5455 (17'11")	5310 (17'5")	5310 (17'5")
L. Overall length*		7965 (26'2")	8120 (26'8")	7855 (25'9")	8010 (26'3")
Turning radius		6430 (21'1")	6470 (21'3")	6400 (21'0")	6440 (21'2")
Digging depth	0°	125 (4.9")	145 (5.7")	125 (4.9")	145 (5.7")
	10°	345 (1'2")	390 (1'3")	325 (1'1")	370 (1'3")

Measured with 23.5-25 tires

	Buckets	I	II	III	IV
H. Dumping clearance, max. height and 45° dump angle**		2990 (9'10")	2865 (9'5")	3070 (10'1")	2945 (9'8")
Reach at 2130 mm (7') cut edge clearance and 45° dump angle		1715 (5'8")	1750 (5'9")	1675 (5'6")	1710 (5'7")
J. Reach at max. height and 45° dump angle**		1110 (3'8")	1210 (4')	1030 (3'5")	1130 (3'8")
Reach with arm horizontal and bucket level		2530 (8'4")	2685 (9')	2420 (7'11")	2575 (8'5")
K. Operating height (fully raised)		5520 (18'1")	5520 (18'1")	5375 (17'8")	5375 (17'8")
L. Overall length		7905 (25'11")	8060 (26'5")	7795 (25'7")	7950 (26'1")
Turning radius*		6405 (21'0")	6455 (21'2")	6375 (20'11")	6415 (21'1")
Digging depth	0°	65 (2.6")	80 (3.1")	65 (2.6")	80 (3.1")
	10°	280 (11")	325 (1'1")	260 (10.2")	305 (1')

* Bucket at carry, outside corner of bucket.

** At the end of teeth or B.O.C.

Performance Data Dimensions

WHEEL LOADERS

WA430-6

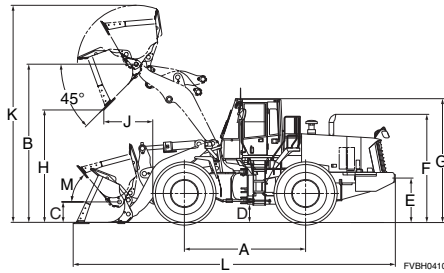

	Unit: mm (ft.in)
Tread	2200 (7'3")
Width over tires	2820 (9'3")
A Wheelbase	3300 (10'10")
B Hinge pin height, max. height	4165 (13'8")
C Hinge pin height, carry position	520 (1'8")
D Ground clearance	455 (1'6")
E Hitch height	1150 (3'9")
F Overall height, top of the stack	2940 (9'8")
G Overall height, ROPS cab	3390 (11'1")
M Tilt back angle	46°

Measured with 20.5-25-16PR (L3) tires

Bucket type			General Purpose Buckets		Excavating Buckets			Light Material Bucket
			Bolt-on Cutting Edges	Teeth	Bolt-on Cutting Edges	Teeth and Segments	Teeth	Bolt-on Cutting Edges
Bucket capacity	Heaped	m ³ (yd ³)	3.5 (4.6)	3.3 (4.3)	3.3 (4.3)	3.3 (4.3)	3.1 (4.1)	4.6 (6.0)
	Struck	m ³ (yd ³)	3.0 (3.9)	2.8 (3.7)	2.8 (3.7)	2.8 (3.7)	2.6 (3.4)	4.0 (5.2)
Bucket width		mm (ft.in)	3050 (10'0")	3065 (10'1")	3050 (10'0")	3065 (10'1")	3065 (10'1")	3050 (10'0")
Bucket weight		kg (lb)	1735 (3,820)	1665 (3,670)	1810 (3,990)	1870 (4,120)	1740 (3,840)	1990 (4,390)
Static tipping load	Straight	kg (lb)	13980 (30,820)	14320 (31,570)	13955 (30,770)	13885 (30,610)	14150 (31,200)	13665 (30,130)
	Full turn (40°)	kg (lb)	12990 (28,640)	13280 (29,280)	12985 (28,630)	12940 (28,530)	13145 (28,980)	12785 (28,190)
H. Dumping clearance, max. height and 45° dump angle**		mm (ft.in)	3020 (9'11")	2895 (9'6")	3090 (10'2")	2970 (9'9")	2970 (9'9")	2870 (9'5")
Reach at 2130 mm (7') clearance and 45° dump angle		mm (ft.in)	1835 (6'0")	1870 (6'2")	1795 (5'11")	1835 (6'0")	1835 (6'0")	1910 (6'3")
J. Reach at max. height and 45° dump angle**		mm (ft.in)	1190 (3'11")	1290 (4'3")	1120 (3'8")	1215 (4'0")	1215 (4'0")	1340 (4'5")
Reach with arm horizontal and bucket level		mm (ft.in)	2685 (8'10")	2840 (9'4")	2580 (8'6")	2735 (9'0")	2735 (9'0")	2895 (9'6")
K. Operating height (fully raised)		mm (ft.in)	5645 (18'6")	5645 (18'6")	5590 (18'4")	5590 (18'4")	5590 (18'4")	5945 (19'6")
L. Overall length		mm (ft.in)	8305 (27'3")	8460 (27'9")	8200 (26'11")	8355 (27'5")	8355 (27'5")	8515 (27'11")
Turning radius*		mm (ft.in)	7335 (24'1")	7380 (24'3")	7295 (23'11")	7350 (24'1")	7350 (24'1")	7380 (24'3")
Digging depth	0°	mm (ft.in)	120 (4.7")	135 (5.3")	120 (4.7")	135 (5.3")	135 (5.3")	120 (4.7")
	10°	mm (ft.in)	350 (1'2")	395 (1'4")	330 (1'1")	375 (1'3")	375 (1'3")	385 (1'3")
Breakout force		kN kgf (lb)	180 18400 (40,565)	194 19800 (43,650)	196 20000 (44,090)	198 20200 (44,530)	213 21700 (47,840)	155 15800 (34,830)
Operating weight		kg (lb)	18290 (40,320)	18220 (40,170)	18365 (40,490)	18425 (40,620)	18295 (40,330)	18545 (40,880)

* Bucket at carry, outside corner of bucket.

** At the end of tooth or B.O.C.

- All dimensions, weights, and performance values based on SAE J732c and J742b standards.
- Static tipping load and operating weight shown include lubricant, coolant, full fuel tank, ROPS cab and operator.
- Machine stability and operating weight affected by counterweight, tire size, and other attachments. Apply the following weight changes to operating weight and static tipping load.

Weight Changes

	Change in Operating Weight		Change in Tipping Load				Width Over Tire		Ground Clearance		Change in Vertical Dimensions	
			Straight		Full Turn							
	kg	lb	kg	lb	kg	lb	mm	ft.in	mm	ft.in	mm	ft.in
23.5-25-16PR (L3)	0	0	0	0	0	0	2820	9'3"	455	1'6"	0	0"
26.5-25-16PR (L3)	+420	+925	+330	+730	+290	+640	2940	9'8"	620	2'0"	+65	+2.6"
Install additional counterweight	+340	+750	+860	+1,900	+720	+1,590						

Performance Data Dimensions

WHEEL LOADERS

WA430-5

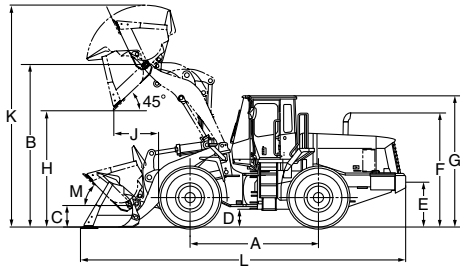

	Unit: mm (ft.in)
Tread	2200 (7'3")
Width over tires	2820 (9'3")
A Wheelbase	3350 (11'0")
B Hinge pin height, max. height	4250 (13'11")
C Hinge pin height, carry position	520 (1'8")
D Ground clearance	460 (1'6")
E Hitch height	1150 (3'9")
F Overall height, top of the stack	2965 (9'9")
G Overall height, ROPS cab	3380 (11'1")
M Tilt back angle	50°

Measured with 20.5-25-16PR (L3) tires

Bucket type			General Purpose Buckets		Excavating Buckets			Light Material Bucket	Rock Bucket
			Bolt-on Cutting Edges	Teeth	Bolt-on Cutting Edges	Teeth and Segments	Teeth	Bolt-on Cutting Edges	Teeth
Bucket capacity	Heaped	m ³ (yd ³)	3.7 (4.8)	3.5 (4.6)	3.3 (4.3)	3.3 (4.3)	3.1 (4.1)	4.6 (6.0)	3.1 (4.1)
	Struck	m ³ (yd ³)	3.2 (4.2)	3.0 (3.9)	2.8 (3.7)	2.8 (3.7)	2.6 (3.4)	4.0 (5.2)	2.7 (3.5)
Bucket width		mm (ft.in)	3050 (10'0")	3065 (10'1")	3050 (10'0")	3065 (10'1")	3065 (10'1")	3050 (10'0")	3050 (10'0")
Bucket weight		kg (lb)	1745 (3,847)	1670 (3,682)	1835 (4,045)	1885 (4,156)	1760 (3,880)	1980 (4,365)	1830 (4,034)
Static tipping load	Straight	kg (lb)	13800 (30,423)	13875 (30,589)	13710 (30,225)	13660 (30,115)	13785 (30,390)	13565 (29,905)	13715 (30,236)
	Full turn (40°)	kg (lb)	12000 (26,445)	12075 (26,621)	11910 (26,257)	11860 (26,147)	11985 (26,422)	11765 (25,937)	11915 (26,268)
H. Dumping clearance, max. height and 45° dump angle**		mm (ft.in)	3125 (10'3")	3000 (9'10")	3175 (10'5")	3055 (10'0")	3055 (10'0")	2955 (9'8")	2890 (9'6")
Reach at 2130 mm (7') clearance and 45° dump angle		mm (ft.in)	2615 (8'7")	2660 (8'9")	2585 (8'6")	2630 (8'8")	2630 (8'8")	2710 (8'11")	2730 (8'11")
J. Reach at max. height and 45° dump angle**		mm (ft.in)	1110 (3'8")	1210 (4'0")	1055 (3'6")	1155 (3'9")	1155 (3'9")	1280 (4'2")	1335 (4'5")
Reach with arm horizontal and bucket level		mm (ft.in)	3425 (11'3")	3585 (11'9")	3350 (11'0")	3505 (11'6")	3505 (11'6")	3665 (12'0")	3750 (12'4")
K. Operating height (fully raised)		mm (ft.in)	5825 (19'1")	5825 (19'1")	5745 (18'10")	5745 (18'10")	5745 (18'10")	6085 (20'0")	5745 (18'10")
L. Overall length		mm (ft.in)	8375 (27'6")	8530 (28'0")	8295 (27'3")	8455 (27'9")	8455 (27'9")	8610 (28'3")	8700 (28'7")
Turning radius*		mm (ft.in)	6720 (22'1")	6765 (22'2")	6685 (21'11")	6743 (22'1")	6743 (22'1")	6775 (22'3")	6743 (22'1")
Digging depth	0°	mm (ft.in)	120 (4.7")	135 (5.3")	120 (4.7")	135 (5.3")	135 (5.3")	120 (4.7")	125 (4.9")
	10°	mm (ft.in)	345 (1'2")	390 (1'3")	335 (1'1")	375 (1'3")	375 (1'3")	385 (1'3")	410 (1'4")
Breakout force		kgf (lb)	180 (40,565)	195 (43,870)	193 (43,430)	195 (43,870)	209 (46,960)	151 (33,950)	173 (38,800)
Operating weight		kg (lb)	18350 (40,455)	18275 (40,290)	18440 (40,655)	18490 (40,765)	18365 (40,485)	18585 (40,970)	18435 (40,640)

* Bucket at carry, outside corner of bucket.

** At the end of tooth or B.O.C.

- All dimensions, weights, and performance values based on SAE J732c and J742b standards.
- Static tipping load and operating weight shown include lubricant, coolant, full fuel tank, ROPS cab and operator.
- Machine stability and operating weight affected by counterweight, tire size, and other attachments. Apply the following weight changes to operating weight and static tipping load.

Weight Changes

	Change in Operating Weight		Change in Tipping Load				Width Over Tire		Ground Clearance		Change in Vertical Dimensions	
			Straight		Full Turn							
	kg	lb	kg	lb	kg	lb	mm	ft.in	mm	ft.in	mm	ft.in
23.5-25-16PR (L3)	0	0	0	0	0	0	2820	9'3"	460	1'6"	0	0"
26.5-25-16PR (L3)	+420	+925	+330	+730	+290	+640	2940	9'8"	525	1'9"	+65	+2.6"
Remove ROPS cab	-660	-1,455	-635	-1,400	-605	-1,335						
Install front/rear compartment	+120	+265	+115	+255	+110	+245						
Install additional counterweight	+325	+715	+880	+1,940	+735	+1,620						

Performance Data Dimensions

WHEEL LOADERS

WA470-6

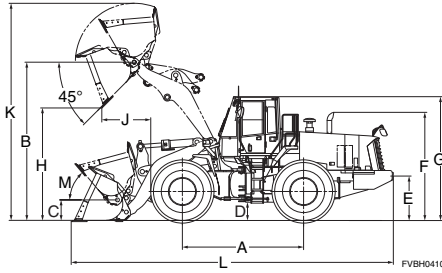

	Unit: mm (ft.in)
Tread	2300 (7'7")
Width over tires	3010 (9'11")
A Wheelbase	3450 (11'4")
B Hinge pin height, max. height	4360 (14'4")
C Hinge pin height, carry position	585 (1'11")
D Ground clearance	525 (1'9")
E Hitch height	1240 (4'1")
F Overall height, top of the stack	3080 (10'1")
G Overall height, ROPS cab	3500 (11'6")
M Tilt back angle	50°

Measured with 26.5-25-16PR (L3) tires

Bucket type		General Purpose Buckets						Rock Bucket	Loose Material Bucket	Light Material Bucket
		Stockpile		Excavating						
		Bolt-on Cutting Edges	Teeth	Bolt-on Cutting Edges	Teeth and Segments	Teeth	Teeth			
Bucket capacity	Heaped	m ³ (yd ³)	4.2 (5.5)	3.9 (5.1)	3.8 (5.0)	3.8 (5.0)	3.6 (4.7)	3.6 (4.7)	4.4 (5.8)	5.2 (6.8)
	Struck	m ³ (yd ³)	3.5 (4.6)	3.3 (4.3)	3.2 (4.2)	3.2 (4.2)	3.1 (4.1)	3.1 (4.1)	3.9 (5.1)	4.5 (5.9)
Bucket width		mm (ft.in)	3170 (10'5")	3190 (10'6")	3170 (10'5")	3190 (10'6")	3190 (10'6")	3170 (10'5")	3170 (10'5")	3170 (10'5")
Bucket weight		kg (lb)	2050 (4,519)	1970 (4,343)	2150 (4,740)	2200 (4,850)	2070 (4,564)	2165 (4,773)	2110 (4,652)	2185 (4,817)
Static tipping load	Straight	kg (lb)	18295 (40,330)	18370 (40,500)	18205 (40,130)	18160 (40,040)	18275 (40,290)	18190 (40,100)	18240 (40,210)	18175 (40,070)
	Full turn (40°)	kg (lb)	15720 (34,660)	15795 (34,820)	15630 (34,460)	15585 (34,360)	15705 (34,620)	15615 (34,420)	15665 (34,530)	15600 (34,390)
H. Dumping clearance, max. height and 45° dump angle**		mm (ft.in)	3185 (10'5")	3060 (10'0")	3235 (10'7")	3110 (10'2")	3110 (10'2")	2975 (9'9")	3055 (10'0")	3035 (9'11")
Reach at 2130 mm (7') clearance and 45° dump angle		mm (ft.in)	1935 (6'4")	1975 (6'6")	1905 (6'3")	1950 (6'5")	1950 (6'5")	2035 (6'8")	2010 (6'7")	2020 (6'8")
J. Reach at max. height and 45° dump angle**		mm (ft.in)	1235 (4'1")	1335 (4'5")	1185 (3'11")	1285 (4'3")	1285 (4'3")	1435 (4'8")	1365 (4'6")	1385 (4'7")
Reach with arm horizontal and bucket level		mm (ft.in)	2755 (9'0")	2910 (9'7")	2685 (8'10")	2840 (9'4")	2840 (9'4")	3040 (10'0")	2940 (9'8")	2965 (9'9")
K. Operating height (fully raised)		mm (ft.in)	5960 (19'7")	5960 (19'7")	5875 (19'3")	5875 (19'3")	5875 (19'3")	5875 (19'3")	5960 (19'7")	6185 (20'4")
L. Overall length		mm (ft.in)	8825 (28'11")	8980 (29'6")	8755 (28'9")	8910 (29'3")	8910 (29'3")	9210 (30'3")	9010 (29'7")	9035 (29'8")
Turning radius*		mm (ft.in)	7640 (25'1")	7690 (25'3")	7620 (25'0")	7670 (25'2")	7670 (25'2")	7640 (25'1")	7685 (25'3")	7690 (25'3")
Digging depth	0°	mm (ft.in)	80 (3.1")	100 (3.9")	80 (3.1")	100 (3.9")	100 (3.9")	85 (3.3")	80 (3.1")	80 (3.1")
	10°	mm (ft.in)	315 (1'0")	360 (1'2")	305 (1'0")	350 (1'2")	350 (1'2")	370 (1'3")	345 (1'2")	350 (1'2")
Breakout force		kN (kgf)	192 (43,160)	207 (46,560)	203 (45,660)	209 (47,020)	220 (49,490)	190 (42,750)	168 (37,790)	165 (37,130)
Operating weight		kg (lb)	22960 (50,620)	22880 (50,440)	23060 (50,840)	23110 (50,950)	22980 (50,660)	23075 (50,870)	23,020 (50,750)	23095 (50,910)

* Bucket at carry, outside corner of bucket.

** At the end of tooth or B.O.C.

- All dimensions, weights, and performance values based on SAE J732c and J742b standards.
- Static tipping load and operating weight shown include lubricant, coolant, full fuel tank, ROPS cab and operator.
- Machine stability and operating weight affected by counterweight, tire size, and other attachments. Apply the following weight changes to operating weight and static tipping load.

Weight Changes

	Change in Operating Weight		Change in Tipping Load				Width Over Tire		Ground Clearance		Change in Vertical Dimensions	
			Straight		Full Turn							
	kg	lb	kg	lb	kg	lb	mm	ft.in	mm	ft.in	mm	ft.in
23.5-25-20PR (L3)	-305	-672	-240	-529	-210	-463	2920	9'7"	460	1'6"	-65	-3"
23.5-25-20PR (L2)	-615	-1355	-480	-1058	-420	-926	2920	9'7"	460	1'6"	-65	-3"
26.5-25-16PR (L3)	0	0	0	0	0	0	3010	9'11"	525	1'9"	0	0"
26.5-25-20PR (L4)	+425	+937	+330	+728	+290	+639	3010	9'11"	525	1'9"	0	0"
Install additional counterweight	+400	+880	+1070	+2,358	+930	+2,050						

Performance Data Dimensions

WHEEL LOADERS

WA470-5

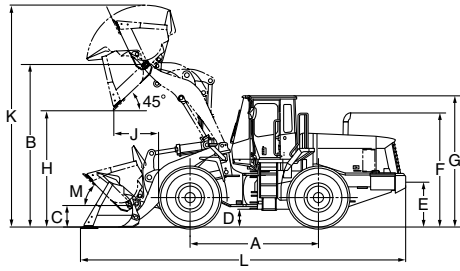

Unit: mm (ft.in)

Tread	2300 (7'7")
Width over tires	3010 (9'11")
A Wheelbase	3450 (11'4")
B Hinge pin height, max. height	4360 (14'4")
C Hinge pin height, carry position	585 (1'11")
D Ground clearance	525 (1'9")
E Hitch height	1240 (4'1")
F Overall height, top of the stack	3080 (10'1")
G Overall height, ROPS cab	3460 (11'4")
M Tilt back angle	50°

Measured with 26.5-25-20PR (L3) tires

Bucket type			General Purpose Buckets				
			Stockpile		Excavating		
			Bolt-on Cutting Edges	Teeth	Bolt-on Cutting Edges	Teeth and Segments	Teeth
Bucket capacity	Heaped	m ³ (yd ³)	4.2 (5.5)	3.9 (5.1)	3.8 (5.0)	3.8 (5.0)	3.6 (4.7)
	Struck	m ³ (yd ³)	3.5 (4.6)	3.3 (4.3)	3.2 (4.2)	3.2 (4.2)	3.1 (4.1)
Bucket width		mm (ft.in)	3170 (10'5")	3190 (10'6")	3170 (10'5")	3190 (10'6")	3190 (10'6")
Bucket weight		kg (lb)	2005 (4,420)	1930 (4,255)	2150 (4,740)	2200 (4,850)	2070 (4,564)
Static tipping load	Straight	kg (lb)	17215 (37,950)	17295 (38,130)	17005 (37,490)	16955 (37,380)	17085 (37,665)
	Full turn (40°)	kg (lb)	14975 (33,015)	15055 (33,190)	14770 (32,560)	14720 (32,450)	14850 (32,740)
H. Dumping clearance, max. height and 45° dump angle**		mm (ft.in)	3185 (10'5")	3060 (10'0")	3235 (10'7")	3110 (10'2")	3110 (10'2")
Reach at 2130 mm (7') clearance and 45° dump angle		mm (ft.in)	1910 (6'3")	1950 (6'5")	1880 (6'2")	1925 (6'4")	1925 (6'4")
J. Reach at max. height and 45° dump angle**		mm (ft.in)	1235 (4'1")	1335 (4'5")	1185 (3'11")	1285 (4'3")	1285 (4'3")
Reach with arm horizontal and bucket level		mm (ft.in)	2750 (9'0")	2905 (9'6")	2680 (8'10")	2835 (9'4")	2835 (9'4")
K. Operating height (fully raised)		mm (ft.in)	5960 (19'7")	5960 (19'7")	5875 (19'3")	5875 (19'3")	5875 (19'3")
L. Overall length		mm (ft.in)	8765 (28'9")	8920 (29'3")	8695 (28'6")	8850 (29'0")	8850 (29'0")
Turning radius*		mm (ft.in)	6980 (22'11")	7040 (23'1")	6965 (22'10")	7020 (23'0")	7020 (23'0")
Digging depth	0°	mm (ft.in)	80 (3.1")	100 (3.9")	80 (3.1")	100 (3.9")	100 (3.9")
	10°	mm (ft.in)	315 (1'0")	360 (1'2")	305 (1'0")	350 (1'2")	350 (1'2")
Breakout force		kN kgf (lb)	192 19580 (43,162)	207 21110 (46,534)	203 20710 (45,634)	209 21320 (46,983)	220 22440 (49,456)
Operating weight		kg (lb)	22165 (48,865)	22085 (48,690)	22205 (48,955)	22315 (49,195)	22185 (48,910)

* Bucket at carry, outside corner of bucket.

** At the end of tooth or B.O.C.

- All dimensions, weights, and performance values based on SAE J732c and J742b standards.
 - Static tipping load and operating weight shown include lubricant, coolant, full fuel tank, ROPS cab and operator.
 - Machine stability and operating weight affected by counterweight, tire size, and other attachments.
- Apply the following weight changes to operating weight and static tipping load.

Weight Changes

	Change in Operating Weight		Change in Tipping Load				Width Over Tire		Ground Clearance		Change in Vertical Dimensions	
			Straight		Full Turn							
	kg	lb	kg	lb	kg	lb	mm	ft.in	mm	ft.in	mm	ft.in
26.5-25-20PR (L3)	0	0	0	0	0	0	3010	9'11"	525	1'9"	0	0"
26.5-25-16PR (L3)	-70	-155	-50	-110	-45	-100	3010	9'11"	525	1'9"	0	0"
26.5-25-20PR (L4)	+355	+780	+270	+595	+235	+520	3010	9'11"	525	1'9"	0	0"
26.5-R25 (L3)	+115	+235	+90	+200	+75	+165	3010	9'11"	525	1'9"	0	0"
23.5-25-20PR (L3)	-460	-1,015	-350	-770	-300	-660	2920	9'7"	460	1'6"	-65	-3"
23.5-25-20PR (L2)	-775	-1,710	-585	-1,290	-505	-1,115	2920	9'7"	460	1'6"	-65	-3"
Remove ROPS cab with A/C	-730	-1,610	-670	-1,475	-585	-1,290						
Install additional counterweight	+400	+880	+1030	+2,270	+860	+1,895						

Performance Data Dimensions

WHEEL LOADERS

WA470-5

Unit: mm (ft.in)

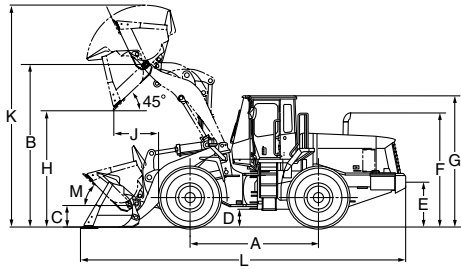

Tread	2300 (7'7")
Width over tires	3010 (9'11")
A Wheelbase	3450 (11'4")
B Hinge pin height, max. height	4360 (14'4")
C Hinge pin height, carry position	585 (1'11")
D Ground clearance	525 (1'9")
E Hitch height	1240 (4'1")
F Overall height, top of the stack	3080 (10'1")
G Overall height, ROPS cab	3460 (11'4")
M Tilt back angle	50°

Measured with 26.5-25-20PR (L3) tires

Bucket type			Rock Bucket	Loose Material Bucket		Light Material Bucket
			Teeth	Bolt-on Cutting Edges	Teeth	Bolt-on Cutting Edges
Bucket capacity	Heaped	m ³ (yd ³)	3.6 (4.7)	4.6 (6.0)	4.3 (5.6)	5.2 (6.8)
	Struck	m ³ (yd ³)	3.1 (4.1)	3.9 (5.1)	3.7 (4.8)	4.5 (5.9)
Bucket width		mm (ft.in)	3170 (10'5")	3170 (10'5")	3190 (10'6")	3170 (10'5")
Bucket weight		kg (lb)	2165 (4,773)	2110 (4,652)	2030 (4,465)	2185 (4,817)
Static tipping load	Straight	kg (lb)	16990 (37,455)	17045 (37,575)	17125 (37,755)	16970 (37,410)
	Full turn (40°)	kg (lb)	14755 (32,530)	14810 (32,650)	14890 (32,825)	14735 (32,485)
H. Dumping clearance, max. height and 45° dump angle**		mm (ft.in)	2975 (9'9")	3055 (10'0")	2930 (9'7")	3035 (9'11")
Reach at 2130 mm (7') clearance and 45° dump angle		mm (ft.in)	2010 (6'7")	1980 (6'6")	2020 (6'8")	1990 (6'6")
J. Reach at max. height and 45° dump angle**		mm (ft.in)	1435 (4'8")	1365 (4'6")	1465 (4'10")	1385 (4'7")
Reach with arm horizontal and bucket level		mm (ft.in)	3035 (9'11")	2935 (9'8")	3090 (10'2")	2960 (9'9")
K. Operating height (fully raised)		mm (ft.in)	5875 (19'3")	5960 (19'7")	5960 (19'7")	6185 (20'4")
L. Overall length		mm (ft.in)	9050 (29'8")	8950 (29'4")	9105 (29'10")	8975 (29'5")
Turning radius*		mm (ft.in)	6985 (22'11")	7030 (23'1")	7090 (23'3")	7040 (23'1")
Digging depth	0°	mm (ft.in)	85 (3.3")	60 (2.4")	80 (3.1")	60 (2.4")
	10°	mm (ft.in)	370 (1'3")	345 (1'2")	390 (1'3")	350 (1'2")
Breakout force		kN (kgf) (lb)	190 (19380) (42,712)	168 (17140) (37,766)	183 (18670) (41,140)	165 (16830) (37,092)
Operating weight		kg (lb)	22280 (49,120)	22225 (48,995)	22145 (48,820)	22300 (49,165)

* Bucket at carry, outside corner of bucket.

** At the end of tooth or B.O.C.

- All dimensions, weights, and performance values based on SAE J732c and J742b standards.
- Static tipping load and operating weight shown include lubricant, coolant, full fuel tank, ROPS cab and operator.
- Machine stability and operating weight affected by counterweight, tire size, and other attachments. Apply the following weight changes to operating weight and static tipping load.

**Performance Data
Dimensions**

WHEEL LOADERS

WA470-3

	Capacity Heaped m ³ (cu.yd)	Struck m ³ (cu.yd)	Bucket width mm (ft.in)	Bucket weight kg (lb)	Breakout force kgf (lb)
I General-purpose bucket with bolt-on cutting edges; (Loading and excavating of soil, sand and variety of other commonly handled materials.)	4.2 (5.5)	3.6 (4.7)	3170 (10'5")	2090 (4,610)	19600 (43,200)
II General-purpose bucket with teeth	3.9 (5.1)	3.4 (4.45)	3190 (10'6")	2015 (4,440)	21100 (46,500)
III Excavating bucket with bolt-on cutting edges	3.8 (5.0)	3.3 (4.3)	3170 (10'5")	2200 (4,850)	20700 (45,600)
IV Excavating bucket with teeth (Loading and excavating of crushed rock and blasted rock.)	3.6 (4.7)	3.1 (4.05)	3190 (10'6")	2130 (4,700)	22400 (49,400)
V Light material bucket with bolt-on cutting edges; (A Lighter-weight, large-capacity bucket.)	5.2 (6.8)	4.5 (5.9)	3170 (10'5")	2330 (5,140)	16800 (37,000)
VI Rock bucket with teeth ; (Spade nose). (Loading and excavating of blasted rock)	3.5 (4.6)	3.0 (3.9)	3170 (10'5")	2120 (4,670)	18600 (41,000)

Tires/Buckets	Operating weight kg(lb)			
	I	II	III	IV
23.5-25-20PR (L-2)	21610 (47,650)	21535 (47,485)	21700 (47,850)	21630 (47,695)
23.5-25-20PR (L-3)	21920 (48,335)	21845 (48,170)	22010 (48,535)	21940 (48,380)
26.5-25-16PR (L-3)	22225 (49,005)	22150 (48,845)	22315 (49,205)	22245 (49,050)
26.5-25-20PR (L-4)	22650 (49,945)	22575 (49,780)	22740 (50,145)	22670 (49,990)
26.5-25-20PR (L-5)	23050 (50,815)	22975 (50,650)	23140 (51,015)	23070 (50,860)

Tires/Buckets	Static tipping load kg(lb)											
	Straight				35° turn				40° full turn			
	I	II	III	IV	I	II	III	IV	I	II	III	IV
23.5-25-20PR (L-2)	16365 (36,090)	16440 (36,250)	16080 (35,455)	16150 (35,610)	14695 (32,405)	14765 (32,555)	14440 (31,840)	14500 (31,980)	14205 (31,325)	14270 (31,465)	13960 (30,775)	14020 (30,910)
23.5-25-20PR (L-3)	16600 (36,765)	16675 (36,765)	16310 (35,965)	16380 (36,120)	14905 (33,015)	14970 (33,015)	14650 (32,300)	14710 (32,435)	14400 (31,750)	14470 (31,910)	14160 (31,220)	14220 (31,350)
26.5-25-16PR (L-3)	16830 (37,275)	16905 (37,275)	16540 (36,470)	16610 (36,620)	15115 (33,470)	15180 (33,470)	14850 (32,750)	14915 (32,885)	14610 (32,215)	14670 (32,355)	14355 (31,655)	14415 (31,785)
26.5-25-20PR (L-4)	17150 (37,980)	17225 (37,980)	16855 (37,170)	16925 (37,320)	15400 (34,105)	15470 (34,105)	15135 (33,380)	15200 (33,515)	14890 (32,830)	14950 (32,965)	14630 (32,260)	14690 (32,395)
26.5-25-20PR (L-5)	17480 (38,535)	17555 (38,700)	17190 (37,900)	17260 (38,050)	15695 (34,600)	15760 (34,745)	15440 (34,040)	15500 (34,170)	15180 (33,465)	15250 (33,620)	14940 (32,935)	15000 (33,070)

- All dimensions, weights and performance values based on SAE J-732c and J-742b standards.
- Static tipping load and operating weight shown include lubricant, coolant, full fuel tank, steel cab, ROPS cab and operator.
- Machine stability and operating weight are affected by counterweight, tire size and other attachments.
Apply the following weight changes to operating weight and static tipping load.

Weight Changes

	Change in operating weight kg (lb)	Change in tipping load kg (lb)	
		Straight	Full turn
Remove ROPS cab	-670 (-1,475)	-600 (-1,325)	-580 (-1,280)
Install additional counterweight	+400 (+885)	+1010 (+2,220)	+845 (+1,865)

Performance Data Dimensions

WHEEL LOADERS

WA470-3

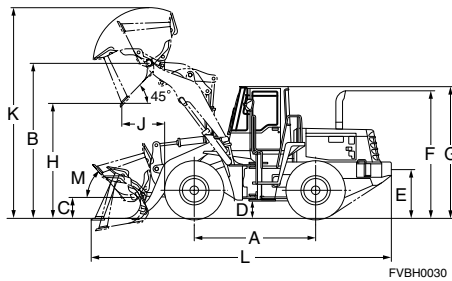

	23.5-25 tires	26.5-25 tires
Tread	2300 (7'7")	2300 (7'7")
Width over tires	2920 (9'7")	3010 (9'10")
A Wheelbase	3400 (11'2")	3400 (11'2")
B Hinge pin height, max. height	4295 (14'1")	4230 (14'4")
C Hinge pin height, carry position	590 (1'11")	570 (1'10")
D Ground clearance	460 (1'6")	525 (1'9")
E Hitch height	1175 (3'10")	1240 (4'1")
F Overall height, top of the stack	3385 (11'1")	3450 (11'4")
G Overall height, ROPS cab	3395 (11'2")	3460 (11'4")
M Tilt back angle		48°

Measured with 23.5-25 tires

	Buckets	I	II	III	IV
H. Dumping clearance, max. height and 45° dump angle**		3120 (10'3")	2995 (9'10")	3170 (10'5")	3045 (10')
Reach at 2130 mm (7") cut edge clearance and 45° dump angle		1885 (6'2")	1920 (6'4")	1860 (6'1")	1900 (6'3")
J. Reach at max. height and 45° dump angle**		1255 (4'1")	1355 (4'5")	1205 (3'11")	1305 (4'3")
Reach with arm horizontal and bucket level		2770 (9'1")	2930 (9'7")	2700 (8'10")	2860 (9'5")
K. Operating height (fully raised)		5895 (19'4")	5895 (19'4")	5850 (19'2")	5850 (19'2")
L. Overall length		8690 (28'6")	8845 (29')	8620 (28'3")	8775 (28'9")
Turning radius*		6890 (22'7")	6960 (22'10")	6870 (22'7")	6920 (22'8")
Digging depth	0°	145 (5.7")	165 (6.5")	145 (5.7")	165 (6.5")
	10°	380 (1'3")	420 (1'5")	365 (1'2")	410 (1'4")

Measured with 26.5-25 tires

	Buckets	I	II	III	IV
H. Dumping clearance, max. height and 45° dump angle*		3185 (10'5")	3060 (10')	3235 (10'7")	3110 (10'2")
Reach at 2130 mm (7") cut edge clearance and 45° dump angle		1850 (6'1")	1885 (6'2")	1825 (6')	1865 (6'1")
J. Reach at max. height and 45° dump angle*		1195 (3'11")	1295 (4'3")	1145 (3'9")	1245 (4'1")
Reach with arm horizontal and bucket level		2705 (8'11")	2860 (9'5")	2635 (8'8")	2790 (9'2")
K. Operating height (fully raised)		5960 (19'7")	5960 (19'7")	5915 (19'5")	5915 (19'5")
L. Overall length		8640 (28'4")	8795 (28'10")	8570 (28'1")	8725 (28'8")
Turning radius*		6870 (22'6")	6940 (22'9")	6850 (22'6")	6900 (22'8")
Digging depth	0°	80 (3.1")	100 (3.9")	80 (3.1")	100 (3.9")
	10°	315 (1')	355 (1'2")	300 (1')	345 (1'2")

* Bucket at carry, outside corner of bucket.

** At the end of teeth or B.O.C.

Performance Data Dimensions

WHEEL LOADERS

WA480-6

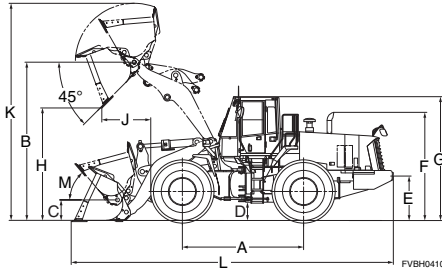

	Unit: mm (ft.in)
Tread	2300 (7'7")
Width over tires	3010 (9'11")
A Wheelbase	3450 (11'4")
B Hinge pin height, max. height	4505 (14'9")
C Hinge pin height, carry position	585 (1'11")
D Ground clearance	525 (1'9")
E Hitch height	1240 (4'1")
F Overall height, top of the stack	3080 (10'1")
G Overall height, ROPS cab	3500 (11'6")
M Tilt back angle	52°

Measured with 26.5-25-20PR (L3) tires

Bucket type			General Purpose Buckets					Loose Material Bucket	Light Material Bucket
			Stockpile		Excavating				
			Bolt-on Cutting Edges	Teeth	Bolt-on Cutting Edges	Teeth and Segments	Teeth		
Bucket capacity	Heaped	m ³ (yd ³)	4.6 (6.0)	4.3 (5.6)	4.1 (5.4)	4.1 (5.4)	3.8 (5.0)	4.9 (6.4)	6.1 (8.0)
	Struck	m ³ (yd ³)	4.0 (5.2)	3.8 (5.0)	3.5 (4.6)	3.5 (4.6)	3.2 (4.2)	4.2 (5.5)	5.2 (6.8)
Bucket width		mm (ft.in)	3170 (10'5")	3190 (10'6")	3170 (10'5")	3190 (10'6")	3190 (10'6")	3170 (10'5")	3170 (10'5")
Bucket weight		kg (lb)	2260 (4,982)	2165 (4,773)	2220 (4,894)	2255 (4,971)	2125 (4,685)	2340 (5,159)	2410 (5,313)
Static tipping load	Straight	kg (lb)	20030 (44,160)	20110 (44,330)	20060 (44,220)	20030 (44,160)	20145 (44,410)	19960 (44,000)	19900 (43,870)
	Full turn (40°)	kg (lb)	17125 (37,750)	17205 (37,930)	17160 (37,830)	17130 (37,760)	17240 (38,010)	17055 (37,600)	16995 (37,470)
H. Dumping clearance, max. height and 45° dump angle**		mm (ft.in)	3205 (10'6")	3080 (10'1")	3320 (10'11")	3195 (10'6")	3195 (10'6")	3150 (10'4")	3080 (10'1")
Reach at 2130 mm (7') clearance and 45° dump angle		mm (ft.in)	2135 (7'0")	2180 (7'2")	2060 (6'9")	2110 (6'11")	2110 (6'11")	2165 (7'1")	2205 (7'3")
J. Reach at max. height and 45° dump angle**		mm (ft.in)	1410 (4'8")	1510 (5'0")	1295 (4'3")	1395 (4'7")	1395 (4'7")	1465 (4'10")	1535 (5'0")
Reach with arm horizontal and bucket level		mm (ft.in)	3020 (9'11")	3175 (10'5")	2855 (9'4")	3010 (9'11")	3010 (9'11")	3100 (10'2")	3195 (10'6")
K. Operating height (fully raised)		mm (ft.in)	6175 (20'3")	6175 (20'3")	6025 (19'9")	6025 (19'9")	6025 (19'9")	6175 (20'3")	6450 (21'2")
L. Overall length		mm (ft.in)	9170 (30'1")	9325 (30'7")	9005 (29'7")	9160 (30'1")	9160 (30'1")	9250 (30'4")	9345 (30'8")
Turning radius*		mm (ft.in)	7700 (25'3")	7750 (25'5")	7655 (25'1")	7710 (25'4")	7710 (25'4")	7720 (25'4")	7745 (25'5")
Digging depth	0°	mm (ft.in)	90 (3.5")	110 (4.3")	90 (3.5")	110 (4.3")	110 (4.3")	90 (3.5")	90 (3.5")
	10°	mm (ft.in)	355 (1'2")	400 (1'4")	335 (1'1")	380 (1'3")	380 (1'3")	375 (1'3")	385 (1'3")
Breakout force		kN	212	226	231	237	249	196	189
		kgf (lb)	21600 (47,660)	23100 (50,810)	23600 (51,930)	24200 (53,280)	25400 (55,980)	20000 (44,060)	19300 (42,490)
Operating weight		kg (lb)	25005 (55,130)	24910 (54,920)	24965 (55,040)	25000 (55,110)	24870 (54,830)	25085 (55,300)	25155 (55,460)

* Bucket at carry, outside corner of bucket.

** At the end of tooth or B.O.C

- All dimensions, weights, and performance values based on SAE J732c and J742b standards.
- Static tipping load and operating weight shown include lubricant, coolant, full fuel tank, ROPS cab and operator.
- Machine stability and operating weight affected by counterweight, tire size, and other attachments. Apply the following weight changes to operating weight and static tipping load.

Weight Changes

	Change in Operating Weight		Change in Tipping Load				Width Over Tire		Ground Clearance		Change in Vertical Dimensions	
			Straight		Full Turn							
	kg	lb	kg	lb	kg	lb	mm	ft.in	mm	ft.in	mm	ft.in
26.5-25-20PR (L3)	0	0	0	0	0	0	3010	9'11"	525	1'9"	0	0"
26.5-25-20PR (L4)	+360	+794	+250	+551	+220	+485	3010	9'11"	525	1'9"	0	0"
Install additional counterweight	+400	+880	+980	+2,160	+850	+1,873						

Performance Data Dimensions

WHEEL LOADERS

WA500-6

Unit: mm (ft.in)

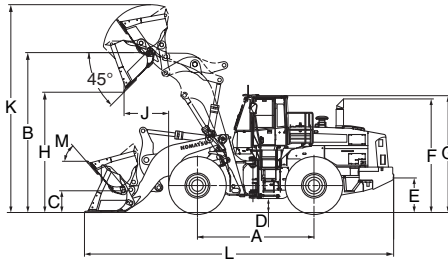

Tread	2400 (7'10")
Width over tires	3190 (10'6")
A Wheelbase	3780 (12'5")
B Hinge pin height, max. height	4755 (15'7")
C Hinge pin height, carry position	575 (1'11")
D Ground clearance	450 (1'6")
E Hitch height	1115 (3'8")
F Overall height, top of the stack	3665 (12'0")
G Overall height, ROPS cab	3785 (12'5")
M Tilt back angle	50°

Measured with 29.5-25-22PR (L3) tires

Bucket type			Standard boom				
			General Purpose Buckets		Excavating Buckets		
			Straight edge Bolt-on Cutting Edges	Straight edge Teeth	Straight edge Bolt-on Cutting Edges	Straight edge Teeth and Segments	Straight edge Teeth
Bucket capacity	Heaped	m ³ (yd ³)	5.6 (7.3)	5.3 (6.9)	5.2 (6.8)	5.2 (6.8)	5.0 (6.5)
	Struck	m ³ (yd ³)	4.8 (6.3)	4.5 (5.9)	4.2 (5.5)	4.2 (5.5)	4.0 (5.2)
Bucket width		mm (ft.in)	3400 (11'2")	3460 (11'4")	3400 (11'2")	3460 (11'4")	3460 (11'4")
Bucket weight		kg (lb)	3110 (6,855)	2955 (6,515)	3055 (6,735)	3145 (6,935)	2900 (6,395)
Static tipping load	Straight	kg (lb)	23450 (51,700)	23650 (52,140)	23600 (52,030)	23490 (51,785)	22850 (50,375)
	Full turn (40°)	kg (lb)	20400 (44,975)	20575 (45,360)	20500 (45,195)	20405 (44,985)	19870 (43,805)
H. Dumping clearance, max. height and 45° dump angle**		mm (ft.in)	3295 (10'10")	3165 (10'5")	3395 (11'2")	3265 (10'9")	3265 (10'9")
Reach at 2130 mm (7') clearance and 45° dump angle		mm (ft.in)	2300 (7'7")	2340 (7'8")	2215 (7'3")	2285 (7'6")	2285 (7'6")
J. Reach at max. height and 45° dump angle**		mm (ft.in)	1500 (4'11")	1600 (5'3")	1400 (4'7")	1495 (4'11")	1495 (4'11")
Reach with arm horizontal and bucket level		mm (ft.in)	3265 (10'9")	3425 (11'3")	3120 (10'3")	3280 (10'9")	3280 (10'9")
K. Operating height (fully raised)		mm (ft.in)	6430 (21'1")	6430 (21'1")	6415 (21'1")	6415 (21'1")	6415 (21'1")
L. Overall length		mm (ft.in)	9815 (32'2")	9975 (32'9")	9670 (31'9")	9790 (32'1")	9790 (32'1")
Turning radius*		mm (ft.in)	7650 (25'1")	7730 (25'3")	7610 (25'0")	7690 (25'3")	7690 (25'3")
Digging depth	0°	mm (ft.in)	135 (5")	155 (6")	135 (5")	155 (6")	155 (6")
	10°	mm (ft.in)	435 (1'5")	485 (1'7")	410 (1'4")	460 (1'6")	460 (1'6")
Breakout force		kN	245	262	268	274	288
		kgf (lb)	25000 (55,115)	26750 (58,975)	27300 (60,185)	27950 (61,620)	29400 (64,815)
Operating weight		kg (lb)	32220 (71,030)	32065 (70,690)	32165 (70,910)	32255 (71,110)	32010 (70,570)

* Bucket at carry, outside corner of bucket.

** At the end of tooth or B.O.C

- All dimensions, weights, and performance values based on SAE J732c and J742b standards.
- Static tipping load and operating weight shown include lubricant, coolant, full fuel tank, ROPS cab and operator.
- Machine stability and operating weight affected by counterweight, tire size, and other attachments. Apply the following weight changes to operating weight and static tipping load.

Performance Data Dimensions

WHEEL LOADERS

WA500-6

Unit: mm (ft.in)

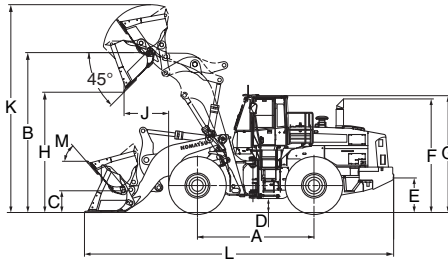

Tread	2400 (7'10")
Width over tires	3190 (10'6")
A Wheelbase	3780 (12'5")
B Hinge pin height, max. height	4755 (15'7")
C Hinge pin height, carry position	575 (1'11")
D Ground clearance	450 (1'6")
E Hitch height	1115 (3'8")
F Overall height, top of the stack	3665 (12'0")
G Overall height, ROPS cab	3785 (12'5")
M Tilt back angle	50°

Measured with 29.5-25-22PR (L3) tires

Bucket type			Standard boom		High lift boom		
			Rock Buckets		Excavating Buckets		
			Spade nose Teeth and Segments	Spade nose Teeth	Straight edge Bolt-on Cutting Edges	Straight edge Teeth and Segments	Straight edge Teeth
Bucket capacity	Heaped	m ³ (yd ³)	5.0 (6.5)	4.7 (6.1)	4.5 (5.9)	4.5 (5.9)	4.3 (5.6)
	Struck	m ³ (yd ³)	4.2 (5.5)	4.0 (5.2)	3.7 (4.8)	3.7 (4.8)	3.5 (4.6)
Bucket width		mm (ft.in)	3460 (11'4")	3460 (11'4")	3400 (11'2")	3460 (11'4")	3460 (11'4")
Bucket weight		kg (lb)	3745 (8,255)	3490 (7,695)	2885(6,360)	2975(6,560)	2730(6,020)
Static tipping load	Straight	kg (lb)	22850 (50,375)	23170 (51,080)	21555 (47,520)	21440 (47,265)	21745 (47,940)
	Full turn (40°)	kg (lb)	19870 (43,805)	20150 (44,425)	18750 (41,335)	18650 (41,115)	18915 (41,700)
H. Dumping clearance, max. height and 45° dump angle**		mm (ft.in)	3030 (9'11")	3030 (9'11")	3890 (12'9")	3920 (12'10")	3920 (12'10")
Reach at 2130 mm (7') clearance and 45° dump angle		mm (ft.in)	2400 (7'10")	2400 (7'10")	2585 (8'6")	2645 (8'8")	2645 (8'8")
J. Reach at max. height and 45° dump angle**		mm (ft.in)	1725 (5'8")	1725 (5'8")	1435 (4'8")	1405 (4'7")	1405 (4'7")
Reach with arm horizontal and bucket level		mm (ft.in)	3610 (11'10")	3610 (11'10")	3385 (11'1")	3545 (11'8")	3545 (11'8")
K. Operating height (fully raised)		mm (ft.in)	6630 (21'9")	6630 (21'9")	6715 (22'0")	6715 (22'0")	6715 (22'0")
L. Overall length		mm (ft.in)	10155 (33'4")	10155 (33'4")	10030 (32'11")	10190 (33'5")	10190 (33'5")
Turning radius*		mm (ft.in)	7645 (25'1")	7645 (25'1")	7805 (25'7")	7890 (25'11")	7890 (25'11")
Digging depth	0°	mm (ft.in)	165 (6")	165 (6")	210 (8")	235 (9")	235 (9")
	10°	mm (ft.in)	525 (1'9")	525 (1'9")	470(1'7")	520(1'8")	520(1'8")
Breakout force		kN	233	243	286	294	310
		kgf (lb)	23800 (52,470)	24750 (54,565)	29,140 (64,245)	30000 (66,140)	31620 (69,710)
Operating weight		kg (lb)	32855 (72,435)	32600 (71,870)	33240 (73,280)	33330 (73,480)	33085 (72,940)

* Bucket at carry, outside corner of bucket.

** At the end of tooth or B.O.C

- All dimensions, weights, and performance values based on SAE J732c and J742b standards.
 - Static tipping load and operating weight shown include lubricant, coolant, full fuel tank, ROPS cab and operator.
 - Machine stability and operating weight affected by counterweight, tire size, and other attachments.
- Apply the following weight changes to operating weight and static tipping load.

Weight Changes

	Change in Operating Weight		Change in Tipping Load				Width Over Tire		Ground Clearance		Change in Vertical Dimensions	
			Straight		Full Turn							
	kg	lb	kg	lb	kg	lb	mm	ft.in	mm	ft.in	mm	ft.in
29.5-25-22PR (L3)	0	0	0	0	0	0	3190	10'6"	450	1'6"	0	0"
Install additional counterweight	+900	+1,985	+1865	+4,110	+1645	+3,625						
Air conditioner	+65	+145	+33	+75	+30	+65						
Emergency steering	+70	+155	+65	+145	+55	+120						
Lock-up clutch torque converter	+45	+100	+60	+130	+50	+110						
ECCS (Electronically Controlled Suspension System)	+120	+265	+13	+30	+11	+24						

Performance Data Dimensions

WHEEL LOADERS

WA500-6R

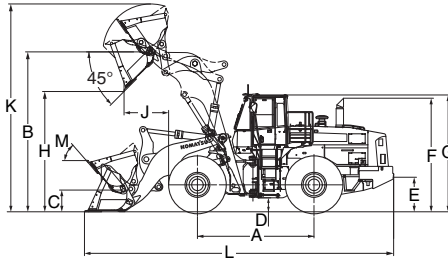

	Unit: mm (ft.in)
Tread	2400 (7'10")
Width over tires	3190 (10'6")
A Wheelbase	3780 (12'5")
B Hinge pin height, max. height	4755 (15'7")
C Hinge pin height, carry position	575 (1'11")
D Ground clearance	450 (1'6")
E Hitch height	1115 (3'8")
F Overall height, top of the stack	3665 (12'0")
G Overall height, ROPS cab	3785 (12'5")
M Tilt back angle	50°

Measured with 29.5-25-22PR (L3) tires

Bucket type			Standard boom				
			General Purpose Buckets		Excavating Buckets		
			Straight edge Bolt-on Cutting Edges	Straight edge Teeth	Straight edge Bolt-on Cutting Edges	Straight edge Teeth and Segments	Straight edge Teeth
Bucket capacity	Heaped	m ³ (yd ³)	5.6 (7.3)	5.3 (6.9)	5.2 (6.8)	5.2 (6.8)	5.0 (6.5)
	Struck	m ³ (yd ³)	4.8 (6.3)	4.5 (5.9)	4.2 (5.5)	4.2 (5.5)	4.0 (5.2)
Bucket width		mm (ft.in)	3400 (11'2")	3460 (11'4")	3400 (11'2")	3460 (11'4")	3460 (11'4")
Bucket weight		kg (lb)	3110 (6,855)	2955 (6,515)	3055 (6,735)	3145 (6,935)	2900 (6,395)
Static tipping load	Straight	kg (lb)	24300 (53,570)	24500 (54,010)	24450 (53,900)	24340 (53,660)	24655 (54,355)
	Full turn (40°)	kg (lb)	21000 (46,295)	21170 (46,670)	21130 (46,580)	21035 (46,370)	21305 (46,965)
H. Dumping clearance, max. height and 45° dump angle**		mm (ft.in)	3295 (10'10")	3165 (10'5")	3395 (11'2")	3265 (10'9")	3265 (10'9")
Reach at 2130 mm (7') clearance and 45° dump angle		mm (ft.in)	2300 (7'7")	2340 (7'8")	2215 (7'3")	2285 (7'6")	2285 (7'6")
J. Reach at max. height and 45° dump angle**		mm (ft.in)	1500 (4'11")	1600 (5'3")	1400 (4'7")	1495 (4'11")	1495 (4'11")
Reach with arm horizontal and bucket level		mm (ft.in)	3265 (10'9")	3425 (11'3")	3120 (10'3")	3280 (10'9")	3280 (10'9")
K. Operating height (fully raised)		mm (ft.in)	6430 (21'1")	6430 (21'1")	6415 (21'1")	6415 (21'1")	6415 (21'1")
L. Overall length		mm (ft.in)	9815 (32'2")	9975 (32'9")	9670 (31'9")	9790 (32'1")	9790 (32'1")
Turning radius*		mm (ft.in)	7650 (25'1")	7730 (25'3")	7610 (25'0")	7690 (25'3")	7690 (25'3")
Digging depth	0°	mm (ft.in)	135 (5")	155 (6")	135 (5")	155 (6")	155 (6")
	10°	mm (ft.in)	435 (1'5")	485 (1'7")	410 (1'4")	460 (1'6")	460 (1'6")
Breakout force		kN	245	262	268	274	288
		kgf (lb)	25000 (55,115)	26750 (58,975)	27300 (60,185)	27950 (61,620)	29400 (64,815)
Operating weight		kg (lb)	33360 (73,545)	33205 (73,200)	33305 (73,425)	33395 (73,620)	33150 (73,080)

* Bucket at carry, outside corner of bucket.

** At the end of tooth or B.O.C

- All dimensions, weights, and performance values based on SAE J732c and J742b standards.
- Static tipping load and operating weight shown include lubricant, coolant, full fuel tank, ROPS cab and operator.
- Machine stability and operating weight affected by counterweight, tire size, and other attachments.
Apply the following weight changes to operating weight and static tipping load.

Performance Data Dimensions

WHEEL LOADERS

WA500-6R

Unit: mm (ft.in)

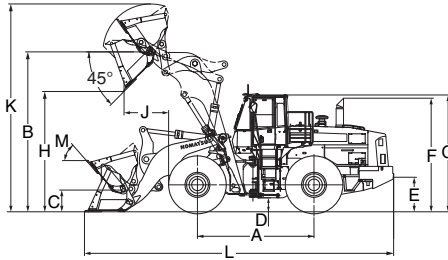

Tread	2400 (7'10")
Width over tires	3190 (10'6")
A Wheelbase	3780 (12'5")
B Hinge pin height, max. height	4755 (15'7")
C Hinge pin height, carry position	575 (1'11")
D Ground clearance	450 (1'6")
E Hitch height	1115 (3'8")
F Overall height, top of the stack	3665 (12'0")
G Overall height, ROPS cab	3785 (12'5")
M Tilt back angle	50°

Measured with 29.5-25-22PR (L3) tires

Bucket type			Standard boom		High lift boom		
			Rock Buckets		Excavating Buckets		
			Spade nose Teeth and Segments	Spade nose Teeth	Straight edge Bolt-on Cutting Edges	Straight edge Teeth and Segments	Straight edge Teeth
Bucket capacity	Heaped	m ³ (yd ³)	5.0 (6.5)	4.7 (6.1)	4.5 (5.9)	4.5 (5.9)	4.3 (5.6)
	Struck	m ³ (yd ³)	4.2 (5.5)	4.0 (5.2)	3.7 (4.8)	3.7 (4.8)	3.5 (4.6)
Bucket width		mm (ft.in)	3460 (11'4")	3460 (11'4")	3400 (11'2")	3460 (11'4")	3460 (11'4")
Bucket weight		kg (lb)	3745 (8,255)	3490 (7,695)	2885 (6,360)	2975 (6,560)	2730 (6,020)
Static tipping load	Straight	kg (lb)	23700 (52,245)	24020 (52,955)	22405 (49,395)	22290 (49,140)	22595 (49,810)
	Full turn (40°)	kg (lb)	20480 (45,150)	20755 (45,755)	19360 (42,680)	19260 (42,460)	19525 (43,045)
H. Dumping clearance, max. height and 45° dump angle**		mm (ft.in)	3030 (9'11")	3030 (9'11")	3890 (12'9")	3760 (12'4")	3760 (12'4")
Reach at 2130 mm (7') clearance and 45° dump angle		mm (ft.in)	2400 (7'10")	2400 (7'10")	2585 (8'6")	2645 (8'8")	2645 (8'8")
J. Reach at max. height and 45° dump angle**		mm (ft.in)	1725 (5'8")	1725 (5'8")	1435 (4'8")	1530 (5'0")	1530 (5'0")
Reach with arm horizontal and bucket level		mm (ft.in)	3610 (11'10")	3610 (11'10")	3385 (11'1")	3545 (11'8")	3545 (11'8")
Operating height (fully raised)		mm (ft.in)	6630 (21'9")	6630 (21'9")	6715 (22'0")	6715 (22'0")	6715 (22'0")
K. Overall length		mm (ft.in)	10155 (33'4")	10155 (33'4")	10030 (32'11")	10190 (33'5")	10190 (33'5")
L. Turning radius*		mm (ft.in)	7645 (25'1")	7645 (25'1")	7805 (25'7")	7890 (25'11")	7890 (25'11")
Digging depth	0°	mm (ft.in)	165 (6")	165 (6")	210 (8")	235 (9")	235 (9")
	10°	mm (ft.in)	525 (1'9")	525 (1'9")	470(1'7")	520(1'8")	520(1'8")
Breakout force		kN	233	243	286	294	310
		kgf (lb)	23800 (52,470)	24750 (54,565)	29,140 (64,245)	30000 (66,140)	31620 (69,710)
Operating weight		kg (lb)	33995 (75,945)	33740 (74,380)	34380 (75,795)	34470 (75,990)	34225 (75,450)

* Bucket at carry, outside corner of bucket.

** At the end of tooth or B.O.C

- All dimensions, weights, and performance values based on SAE J732c and J742b standards.
 - Static tipping load and operating weight shown include lubricant, coolant, full fuel tank, ROPS cab and operator.
 - Machine stability and operating weight affected by counterweight, tire size, and other attachments.
- Apply the following weight changes to operating weight and static tipping load.

Weight Changes

	Change in Operating Weight		Change in Tipping Load				Width Over Tire		Ground Clearance		Change in Vertical Dimensions	
			Straight		Full Turn							
	kg	lb	kg	lb	kg	lb	mm	ft.in	mm	ft.in	mm	ft.in
29.5-25-22PR (L3)	0	0	0	0	0	0	3190	10'6"	450	1'6"	0	0"
Install additional counterweight	+900	+1,985	+1865	+4,110	+1645	+3,625						
Air conditioner	+65	+145	+33	+75	+30	+65						
Emergency steering	+70	+155	+65	+145	+55	+120						
Lock-up clutch torque converter	+45	+100	+60	+130	+50	+110						
ECCS (Electronically Controlled Suspension System)	+120	+265	+13	+30	+11	+24						

**Performance Data
Dimensions**

WHEEL LOADERS

WA500-3

	Capacity Heaped m ³ (cu.yd)	Struck m ³ (cu.yd)	Bucket width mm (ft.in)	Bucket weight kg (lb)	Breakout force kgf (lb)
I Excavating bucket (straight edge) with teeth	4.3 (5.6)	3.7 (4.8)	3460 (11'4")	2570 (5,670)	27000 (59,520)
II Excavating bucket (spade nose) with tip teeth	4.3 (5.6)	3.7 (4.8)	3400 (11'2")	2960 (6,530)	21780 (48,020)
III General-purpose bucket with bolt on cutting edge without teeth ; Loading stockpile products	5.0 (6.5)	4.3 (5.6)	3400 (11'2")	2760 (6,080)	23700 (52,250)
IV Loose material bucket with bolt on cutting edge	5.5 (7.2)	4.7 (6.1)	3400 (11'2")	2880 (6,350)	21200 (46,740)

Tires/Buckets	Operating weight kg(lb)							
	I	II	III	IV				
26.5-25-20PR (L3)	28220 (62,210)	28610 (63,070)	28410 (62,630)	27910 (61,530)				
29.5-25-22PR (L3)	28770 (63,430)	29160 (64,290)	28960 (63,850)	28460 (62,750)				
26.5-25-20PR (L4)	28620 (63,100)	29010 (63,960)	28810 (63,520)	28310 (62,420)				
26.5-25-20PR (L5)	28980 (63,890)	29370 (64,750)	29170 (64,310)	28670 (63,210)				
29.5-25-28PR (L4)	29310 (64,620)	29700 (65,480)	29500 (65,040)	29000 (63,940)				

Tires/Buckets	Static tipping load kg(lb)							
	Straight							
	I	II	III	IV				
26.5-25-20PR (L3)	21920 (48,330)	21440 (47,270)	21750 (47,950)	21610 (47,650)				
29.5-25-22PR (L3)	22330 (49,230)	21850 (48,170)	22160 (48,860)	22020 (48,550)				
26.5-25-20PR (L4)	22215 (48,980)	21735 (47,920)	22045 (48,600)	21905 (48,300)				
26.5-25-20PR (L5)	22485 (49,580)	22005 (48,520)	22315 (49,200)	22175 (48,900)				
29.5-25-28PR (L4)	22730 (50,120)	22250 (49,060)	22560 (49,740)	22420 (49,430)				

Tires/Buckets	Static tipping load kg(lb)							
	40° full turn							
	I	II	III	IV				
26.5-25-20PR (L3)	18980 (41,840)	18560 (40,920)	18830 (41,510)	18670 (41,160)				
29.5-25-22PR (L3)	19335 (42,630)	18915 (41,700)	19185 (42,300)	19025 (41,950)				
26.5-25-20PR (L4)	19235 (42,410)	18815 (41,480)	19085 (42,080)	18925 (41,730)				
26.5-25-20PR (L5)	19470 (42,930)	19050 (42,000)	19320 (42,600)	19160 (42,250)				
29.5-25-28PR (L4)	19680 (43,390)	19260 (42,470)	19530 (43,060)	19370 (42,710)				

- All dimensions, weights and performance values based on SAE J-732c and J-742b standards.
- Static tipping load and operating weight shown include lubricant, coolant, full fuel tank, steel cab, ROPS canopy and operator.
- Machine stability and operating weight are affected by counterweight, tire size and other attachments.
Apply the following weight changes to operating weight and static tipping load.

Weight Changes

	Change in operating weight kg (lb)	Change in tipping load kg (lb)	
		Straight	Full turn
Remove ROPS cab	-585 (-1,290)	-510 (-1,125)	-490 (-1,080)
Remove steel cab	-460 (-1,015)	-400 (-880)	-385 (-850)
Remove front half fender	-45 (-100)	-14 (-30)	-14 (-30)
Remove teeth	-315 (-690)	-415 (-910)	-415 (-915)
Install additional counterweight	+1000 (+2,205)	+2400 (+5,290)	+2000 (+4,410)

Performance Data Dimensions

WHEEL LOADERS

WA500-3

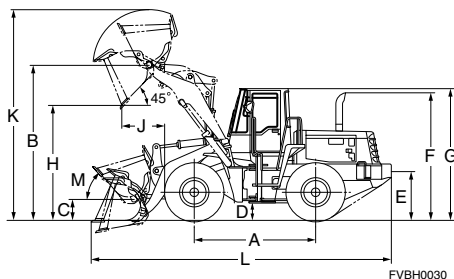

	26.5-25 tires	29.5-25 tires
Tread	2400(7'10")	2400(7'10")
Width over tires	3090(10'2")	3190(10'6")
A Wheelbase	3600(11'10")	3600(11'10")
B Hinge pin height, max. height	4455(14'7")	4500(14'9")
C Hinge pin height, carry position	520(1'8")	565(1'10")
D Ground clearance	405(1'4")	450(1'5")
E Hitch height	1195(3'11")	1240(4'1")
F Overall height, top of the stack	3660(12')	3705(12'2")
G Overall height, ROPS canopy	3815(12'6")	3860(12'8")
M Tilt back angle		48°

Measured with 26.5-25 tires

	Buckets	I	II	III	IV
H. Dumping clearance, max. height and 45° dump angle**		3025 (9'11")	2770 (9'1")	3125 (10'3")	3015 (9'11")
Reach at 2130 mm (7") cut edge clearance and 45° dump angle		2030 (6'8")	2160 (7'1")	2060 (6'9")	2140 (7'0")
J. Reach at max. height and 45° dump angle**		1490 (4'11")	1740 (5'9")	1430 (4'8")	1540 (5'11")
Reach with arm horizontal and bucket level		2800 (9'2")	3130 (10'3")	2995 (9'10")	3150 (10'4")
K. Operating height (fully raised)		6070 (19'11")	6255 (20'6")	6130 (20'1")	6175 (20'3")
L. Overall length		9055 (29'9")	9395 (30'10")	9250 (30'4")	9405 (30'10")
Turning radius*		7390 (24'3")	7380 (24'3")	7320 (24'0")	7265 (23'10")
Digging depth	0°	180(7.1")	185(7.3")	150(6")	155(6")
	10°	470(18.5")	535(21.1")	420(16.5")	445(17.5")

Measured with 29.5-25 tires

	Buckets	I	II	III	IV
H. Dumping clearance, max. height and 45° dump angle*		3070(10'1")	2815(9'3")	3170(10'5")	3060(10'0")
Reach at 2130 mm (7") cut edge clearance and 45° dump angle		1995(6'6")	2125(7')	2025(6'8")	2100(6'11")
J. Reach at max. height and 45° dump angle*		1425(4'8")	1675(5'6")	1365(4'6")	1480(4'10")
Reach with arm horizontal and bucket level		2740(9'0")	3070(10'1")	2935(9'8")	3090(10'2")
K. Operating height (fully raised)		6115(20'1")	6300(20'8")	6175(20'3")	6220(20'5")
L. Overall length		9020(29'7")	9360(30'8")	9215(30'3")	9370(30'9")
Turning radius*		7390(24'3")	7380(24'3")	7320(24'0")	7265(23'10")
Digging depth	0°	135(5.3")	140(5.5")	110(4.3")	110(4.3")
	10°	425(1'5")	490(1'7")	375(1'3")	400(1'4")

* Bucket at carry, outside corner of bucket.

** At the end of teeth or B.O.C.

Performance Data Dimensions

WHEEL LOADERS

WA500-3 (with high lift boom)

	Capacity Heaped m ³ (cu.yd)	Struck m ³ (cu.yd)	Bucket width* mm (ft.in)	Bucket weight kg (lb)	Breakout force kgf (lb)
I Excavating bucket (straight edge) with teeth	4.2 (5.6)	3.6 (4.8)	3460 (11'4")	2580 (5,690)	28450 (62,720)

* Excluding tire protectors

	Operating weight kg(lb)	Static tipping load kg(lb)	
		Straight	40° full turn
Tires/Buckets	I	I	I
29.5-25-22PR (L-3)	29740 (65,560)	21765 (47,980)	18800 (41,450)

- All dimensions, weights and performance values based on SAE J-732c and J-742b standards.
- Static tipping load and operating weight shown include lubricant, coolant, full fuel tank, steel cab, ROPS canopy and operator.
- Machine stability and operating weight are affected by counterweight, tire size and other attachments.
Apply the following weight changes to operating weight and static tipping load.

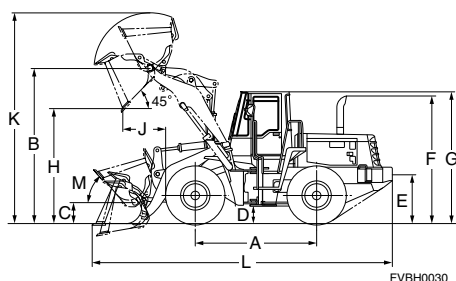

	Unit: mm (ft.in)
Tread	29.5-25 tires 2400 (7'20")
Width over tires	3190 (10'6")
A Wheelbase	3600 (11'10")
B Hinge pin height, max. height	4905 (16'1")
C Hinge pin height, carry position	565 (1'10")
D Ground clearance	450 (1'5")
E Hitch height	1240 (4'1")
F Overall height, top of the stack	3635 (11'11")
G Overall height, ROPS canopy	3860 (12'8")
M Tilt back angle	48°

Measured with 29.5-25 tires

Unit: mm (ft.in)

	Buckets	I
H. Dumping clearance, max. height and 45° dump angle**		3565 (11'8")
Reach at 2130 mm (7') cut edge clearance and 45° dump angle		
J. Reach at max. height and 45° dump angle**		1570 (5'2")
Reach with arm horizontal and bucket level		
K. Operating height (fully raised)		6520 (21'5")
L. Overall length		9910 (32'6")
Turning radius*		7585 (24'11")
Digging depth	0°	205 (8.1")
	10°	475 (1'7")

* Bucket at carry, outside corner of bucket.

** At the end of teeth or B.O.C.

Performance Data Dimensions

WHEEL LOADERS

WA600-6

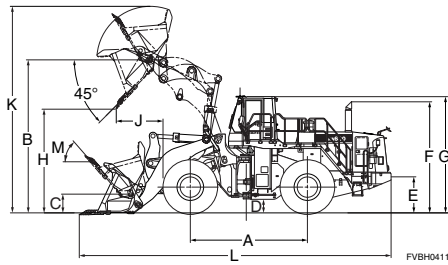

	Unit: mm (ft.in)
	3990 mm 13'1" 3850 mm 12'8"
	Boom Boom
Tread	2650 (8'8")
Width over tires	3540 (11'9")
A Wheelbase	4500 (14'9")
B Hinge pin height, max. height	5885 (19'3") 5665 (18'7")
C Hinge pin height, carry position	720 (2'4") 670 (2'3")
D Ground clearance	525 (1'9")
E Hitch height	1385 (4'7")
F Overall height, top of the stack	4270 (14'0")
G Overall height, ROPS cab	4460 (14'8")
M Tilt back angle	50°

Measured with 35/65-33-36PR (L4) tires

Bucket type			3990 mm 13'1" Boom			3850 mm 12'8" Boom	
			Excavating Buckets		Stockpile Bucket	Excavating Buckets	
			Spade nose Teeth and WSE***	Straight edge Teeth and BSE**4	Spade nose Teeth and WSE***	Spade nose Teeth and WSE***	Straight edge Teeth and BSE**4
Bucket capacity	Heaped	m ³ (yd ³)	6.4 (8.4)	6.5 (8.5)	7.0 (9.2)	7.0 (9.2)	7.0 (9.2)
	Struck	m ³ (yd ³)	5.3 (6.9)	5.4 (7.1)	5.8 (7.6)	5.8 (7.6)	5.8 (7.6)
Bucket width		mm (ft.in)	3685 (12'1")	3685 (12'1")	3685 (12'1")	3685 (12'1")	3685 (12'1")
Bucket weight		kg (lb)	5115 (11,280)	4735 (10,440)	5255 (11,590)	5245 (11,570)	4865 (10,730)
Static tipping load	Straight	kg (lb)	34200 (75,400)	34580 (76,240)	34060 (75,090)	35400 (78,040)	35780 (78,880)
	Full turn (43°)	kg (lb)	28500 (62,830)	28880 (63,670)	28360 (62,520)	29500 (65,040)	29880 (65,870)
H. Dumping clearance, max. height and 45° dump angle**		mm (ft.in)	3995 (13'1")	4180 (13'9")	3945 (12'11")	3730 (12'3")	3905 (12'10")
Reach at 2130 mm (7') clearance and 45° dump angle		mm (ft.in)	3015 (9'11")	2875 (9'5")	3050 (10'0")	2900 (9'6")	2775 (9'1")
J. Reach at max. height and 45° dump angle**		mm (ft.in)	1800 (5'11")	1610 (5'3")	1850 (6'1")	1885 (6'2")	1690 (5'7")
Reach with arm horizontal and bucket level		mm (ft.in)	4135 (13'7")	3870 (12'8")	4205 (13'9")	4065 (13'4")	3800 (12'6")
K. Operating height (fully raised)		mm (ft.in)	7925 (20'6")	7925 (20'6")	7995 (26'3")	7775 (25'6")	7775 (25'6")
L. Overall length		mm (ft.in)	11985 (39'4")	11725 (38'6")	12055 (39'7")	11870 (38'11")	11610 (38'1")
Turning radius*		mm (ft.in)	8500 (27'1")	8530 (28'0")	8520 (27'11")	8440 (27'8")	8460 (27'9")
Digging depth	0°	mm (ft.in)	130 (5.1")	135 (5.3")	130 (5.1")	130 (5.1")	140 (5.5")
	10°	mm (ft.in)	515 (1'8")	480 (1'7")	530 (1'9")	530 (1'9")	495 (1'7")
Breakout force	kN		387	448	375	378	433
	kgf (lb)		39500 (87,080)	45680 (100,710)	38200 (84,220)	38600 (85,100)	44150 (97,340)
Operating weight	kg		52700	52320	52840	52900	52500
	(lb)		(116,180)	(115,340)	(116,490)	(116,620)	(115,740)

* Bucket at carry, outside corner of bucket.

** At the end of tooth or B.O.C

*** Weld on segment edges

**4 Bolt on segment edges

- All dimensions, weights, and performance values based on SAE J732c and J742b standards.
- Static tipping load and operating weight shown include lubricant, coolant, full fuel tank, ROPS cab and operator.
- Machine stability and operating weight affected by counterweight, tire size, and other attachments.
Apply the following weight changes to operating weight and static tipping load.

**Performance Data
Dimensions**

WHEEL LOADERS

Weight Changes

3990 mm (13'1") boom

	Change in Operating Weight		Tipping Load				Width Over Tire		Ground Clearance		Change in Vertical Dimensions	
			Straight		Full Turn							
	kg	lb	kg	lb	kg	lb	mm	ft.in	mm	ft.in	mm	ft.in
35/65-33-36PR (L4)	0	0	0	0	0	0	3,540	11'7"	525	1'9"	0	0'0"
35/65-33-36PR (L5)	+1000	+2,205	+715	+1,575	+595	+1,310	3,540	11'7"	525	1'9"	0	0'0"
35/65-33-42PR (L4)	+20	+45	+15	+30	+10	+25	3,555	11'8"	525	1'9"	0	0'0"
35/65 R33* (L4)	-780	-1,720	-555	-1,230	-465	-1,025	3,565	11'8"	460	1'6"	-65	-2.6"
35/65 R33* (L5)	-235	-520	-170	-375	-140	-310	3,565	11'8"	460	1'6"	-65	-2.6"
OPT Counterweight	+1000	+2,205	+2380	+5,245	+1985	+4,370						

3850 mm (12'8") boom

	Change in Operating Weight		Tipping Load				Width Over Tire		Ground Clearance		Change in Vertical Dimensions	
			Straight		Full Turn							
	kg	lb	kg	lb	kg	lb	mm	ft.in	mm	ft.in	mm	ft.in
35/65-33-36PR (L4)	0	0	0	0	0	0	3,540	11'7"	525	1'9"	0	0'0"
35/65-33-36PR (L5)	+1000	+2,205	+745	+1,640	+620	+1,365	3,540	11'7"	525	1'9"	0	0'0"
35/65-33-42PR (L4)	+20	+45	+15	+35	+15	+30	3,555	11'8"	525	1'9"	0	0'0"
35/65 R33* (L4)	-780	-1,720	-580	-1,280	-485	-1,065	3,565	11'8"	460	1'6"	-65	-2.6"
35/65 R33* (L5)	-235	-520	-175	-390	-145	-320	3,565	11'8"	460	1'6"	-65	-2.6"
OPT Counterweight	+1000	+2,205	+2480	+5,265	+2065	+4,555						

Performance Data Dimensions

WHEEL LOADERS

WA600-6R

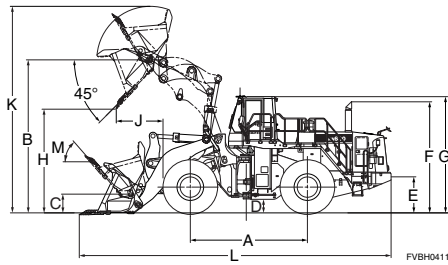

	Unit: mm (ft.in)
	3990 mm 13'1" 3850 mm 12'8"
	Boom Boom
Tread	2650 (8'8")
Width over tires	3540 (11'9")
A Wheelbase	4500 (14'9")
B Hinge pin height, max. height	5885 (19'3") 5665 (18'7")
C Hinge pin height, carry position	720 (2'4") 670 (2'3")
D Ground clearance	525 (1'9")
E Hitch height	1385 (4'7")
F Overall height, top of the stack	4270 (14'0")
G Overall height, ROPS cab	4460 (14'8")
M Tilt back angle	50°

Measured with 35/65-33-36PR (L4) tires

Bucket type			3990 mm 13'1" Boom			3850 mm 12'8" Boom	
			Excavating Buckets		Stockpile Bucket	Excavating Buckets	
			Spade nose Teeth and WSE***	Straight edge Teeth and BSE**4	Spade nose Teeth and WSE***	Spade nose Teeth and WSE***	Straight edge Teeth and BSE**4
Bucket capacity	Heaped	m ³ (yd ³)	6.4 (8.4)	6.5 (8.5)	7.0 (9.2)	7.0 (9.2)	7.0 (9.2)
	Struck	m ³ (yd ³)	5.3 (6.9)	5.4 (7.1)	5.8 (7.6)	5.8 (7.6)	5.8 (7.6)
Bucket width		mm (ft.in)	3685 (12'1")	3685 (12'1")	3685 (12'1")	3685 (12'1")	3685 (12'1")
Bucket weight		kg (lb)	5115 (11,280)	4735 (10,440)	5255 (11,590)	5245 (11,570)	4865 (10,730)
Static tipping load	Straight	kg (lb)	34200 (75,400)	34580 (76,240)	34060 (75,090)	35400 (78,040)	35780 (78,880)
	Full turn (43°)	kg (lb)	28500 (62,830)	28880 (63,670)	28360 (62,520)	29500 (65,040)	29880 (65,870)
H. Dumping clearance, max. height and 45° dump angle**		mm (ft.in)	3995 (13'1")	4180 (13'9")	3945 (12'11")	3730 (12'3")	3905 (12'10")
Reach at 2130 mm (7') clearance and 45° dump angle		mm (ft.in)	3015 (9'11")	2875 (9'5")	3050 (10'0")	2900 (9'6")	2775 (9'1")
J. Reach at max. height and 45° dump angle**		mm (ft.in)	1800 (5'11")	1610 (5'3")	1850 (6'1")	1885 (6'2")	1690 (5'7")
Reach with arm horizontal and bucket level		mm (ft.in)	4135 (13'7")	3870 (12'8")	4205 (13'9")	4065 (13'4")	3800 (12'6")
K. Operating height (fully raised)		mm (ft.in)	7925 (20'0")	7925 (20'0")	7995 (26'3")	7775 (25'6")	7775 (25'6")
L. Overall length		mm (ft.in)	11985 (39'4")	11725 (38'6")	12055 (39'7")	11870 (38'11")	11610 (38'1")
Turning radius*		mm (ft.in)	8500 (27'1")	8530 (28'0")	8520 (27'11")	8440 (27'8")	8460 (27'9")
Digging depth	0°	mm (ft.in)	130 (5.1")	135 (5.3")	130 (5.1")	130 (5.1")	140 (5.5")
	10°	mm (ft.in)	515 (1'8")	480 (1'7")	530 (1'9")	530 (1'9")	495 (1'7")
Breakout force	kN		387	448	375	378	433
	kgf (lb)		39500 (87,080)	45680 (100,710)	38200 (84,220)	38600 (85,100)	44150 (97,340)
Operating weight	kg		52700	52320	52840	52900	52500
	(lb)		(116,180)	(115,340)	(116,490)	(116,620)	(115,740)

* Bucket at carry, outside corner of bucket.

** At the end of tooth or B.O.C

*** Weld on segment edges

**4 Bolt on segment edges

- All dimensions, weights, and performance values based on SAE J732c and J742b standards.
- Static tipping load and operating weight shown include lubricant, coolant, full fuel tank, ROPS cab and operator.
- Machine stability and operating weight affected by counterweight, tire size, and other attachments.
Apply the following weight changes to operating weight and static tipping load.

**Performance Data
Dimensions**

WHEEL LOADERS

Weight Changes

3990 mm (13'1") boom

	Change in Operating Weight		Tipping Load				Width Over Tire		Ground Clearance		Change in Vertical Dimensions	
			Straight		Full Turn							
	kg	lb	kg	lb	kg	lb	mm	ft.in	mm	ft.in	mm	ft.in
35/65-33-36PR (L4)	0	0	0	0	0	0	3,540	11'7"	525	1'9"	0	0'0"
35/65-33-36PR (L5)	+1000	+2,205	+715	+1,575	+595	+1,310	3,540	11'7"	525	1'9"	0	0'0"
35/65-33-42PR (L4)	+20	+45	+15	+30	+10	+25	3,555	11'8"	525	1'9"	0	0'0"
35/65 R33* (L4)	-780	-1,720	-555	-1,230	-465	-1,025	3,565	11'8"	460	1'6"	-65	-2.6"
35/65 R33* (L5)	-235	-520	-170	-375	-140	-310	3,565	11'8"	460	1'6"	-65	-2.6"
OPT Counterweight	+1000	+2,205	+2380	+5,245	+1985	+4,370						

3850 mm (12'8") boom

	Change in Operating Weight		Tipping Load				Width Over Tire		Ground Clearance		Change in Vertical Dimensions	
			Straight		Full Turn							
	kg	lb	kg	lb	kg	lb	mm	ft.in	mm	ft.in	mm	ft.in
35/65-33-36PR (L4)	0	0	0	0	0	0	3,540	11'7"	525	1'9"	0	0'0"
35/65-33-36PR (L5)	+1000	+2,205	+745	+1,640	+620	+1,365	3,540	11'7"	525	1'9"	0	0'0"
35/65-33-42PR (L4)	+20	+45	+15	+35	+15	+30	3,555	11'8"	525	1'9"	0	0'0"
35/65 R33* (L4)	-780	-1,720	-580	-1,280	-485	-1,065	3,565	11'8"	460	1'6"	-65	-2.6"
35/65 R33* (L5)	-235	-520	-175	-390	-145	-320	3,565	11'8"	460	1'6"	-65	-2.6"
OPT Counterweight	+1000	+2,205	+2480	+5,265	+2065	+4,555						

**Performance Data
Dimensions**

WHEEL LOADERS

WA600-3

	Capacity Heaped m ³ (cu.yd)	Struck m ³ (cu.yd)	Bucket width* mm (ft.in)	Bucket weight kg (lb)	Breakout force kgf (lb)
I Excavating bucket (straight edge) with tip teeth	6.1 (8.0)	5.1 (6.7)	3685 (12'1")	4250 (9,370)	37600 (82,890)
II Excavating bucket (spade nose) with tip teeth	6.1 (8.0)	5.1 (6.7)	3685 (12'1")	4305 (9,490)	43750 (96,450)
III Coal bucket (straight edge)	11.0 (14.4)	9.5 (12.4)	4200 (13'9")	4420 (9,740)	31950 (70,440)

* Excluding tire protectors

Tires/Buckets	Operating weight kg(lb)		
	I	II	III
35/65-33-24PR (L4)	45180 (99,600)	45235 (99,730)	45350 (99,980)
35/65-33-24PR (L5)	46320 (102,120)	46375 (102,240)	46490 (102,490)
29.5-29-28PR (L4)	44510 (98,130)	44565 (98,250)	44680 (98,500)

Tires/Buckets	Static tipping load kg(lb)								
	Straight			35° turn			40° full turn		
	I	II	III	I	II	III	I	II	III
35/65-33-24PR (L4)	31410 (69,250)	31355 (69,130)	31240 (68,870)	28550 (62,940)	28495 (62,820)	28380 (62,570)	27740 (61,160)	27685 (61,030)	27570 (60,780)
35/65-33-24PR (L5)	32200 (70,990)	32145 (70,870)	32030 (70,610)	29270 (64,530)	29215 (64,410)	29100 (64,150)	28440 (62,700)	28385 (62,580)	28270 (62,320)
29.5-29-28PR (L4)	30945 (68,220)	30890 (68,100)	30775 (67,850)	28130 (62,020)	28075 (61,890)	27960 (61,640)	27330 (60,250)	27275 (60,130)	27160 (59,880)

- All dimensions, weights and performance values based on SAE J-732c and J-742b standards.
- Static tipping load and operating weight shown include lubricant, coolant, full fuel tank, steel cab, ROPS canopy, front half fenders, tip type teeth and operator.
- Machine stability and operating weight are affected by counterweight or ballast, tire size and other attachments. Use either counterweight or ballast, not both. Apply the following weight changes to operating weight and static tipping load.

Weight Changes

	Change in operating weight kg (lb)	Change in tipping load kg (lb)	
		Straight	Full turn
Remove ROPS canopy	-800 (-1,760)	-700 (-1,540)	-615 (-1,360)
Remove steel cab	-430 (-950)	-310 (-680)	-275 (-610)
Remove teeth	-372 (-820)	-475 (-1,050)	-475 (-1,050)
Install additional counterweight	+1000 (+2,200)	+2300 (+5,070)	+2030 (+4,480)

Performance Data Dimensions

WHEEL LOADERS

WA600-3

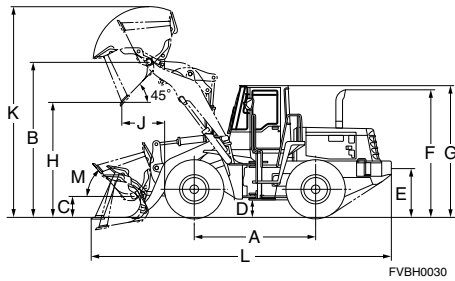

		Unit: mm (ft.in)
	35/65-33 tires	29.5-29 tires
Tread	2650 (8'8")	2650 (8'8")
Width over tires	3570 (11'9")	3480 (11'5")
A Wheelbase	4100 (13'5")	4100 (13'5")
B Hinge pin height, max. height	5155 (16'11")	5110 (16'9")
C Hinge pin height, carry position	670 (2'2")	625 (2'1")
D Ground clearance	495 (1'7")	450 (1'6")
E Hitch height	1295 (4'3")	1250 (4'1")
F Overall height, top of the stack	4125 (13'6")	4080 (13'5")
G Overall height, ROPS canopy	4250 (13'11")	4205 (13'10")
Overall height, ROPS and cab	4250 (13'11")	4205 (13'10")
M Tilt back angle		49.5°

Measured with 35/65-33 tires

	Buckets	I	II	III
H. Dumping clearance, max. height and 45° dump angle**		3530 (11'7")	3350 (11')	3370 (11'1")
Reach at 2130 mm (7') cut edge clearance and 45° dump angle		2470 (8'1")	2600 (8'6")	2735 (9')
J. Reach at max. height and 45° dump angle**		1795 (5'11")	1990 (6'6")	2005 (6'7")
Reach with arm horizontal and bucket level		3240 (10'8")	3500 (11'6")	3745 (12'3")
K. Operating height (fully raised)		7165 (23'6")	7165 (23'6")	7440 (24'5")
L. Overall length		10840 (35'7")	11105 (36'5")	11010 (36'1")
Turning radius*		8265 (27'1")	8260 (27'1")	8590 (28'2")
Digging depth	0°	100 (3.9")	100 (3.9")	40 (1.6")
	10°	440 (1'5")	470 (1'7")	395 (1'3")

Measured with 29.5-29 tires

Unit: mm (ft.in)

	Buckets	I	II	III
H. Dumping clearance, max. height and 45° dump angle**		3485 (11'5")	3305 (10'10")	3325 (10'11")
Reach at 2130 mm (7') cut edge clearance and 45° dump angle		2500 (8'2")	2630 (8'7")	2765 (9'1")
J. Reach at max. height and 45° dump angle**		1825 (6')	2020 (6'8")	2035 (6'8")
Reach with arm horizontal and bucket level		3270 (10'9")	3530 (11'7")	3775 (12'5")
K. Operating height (fully raised)		7120 (23'4")	7120 (23'4")	7395 (24'3")
L. Overall length		10880 (35'8")	11145 (36'7")	11050 (36'3")
Turning radius*		8265 (27'1")	8260 (27'1")	8590 (28'2")
Digging depth	0°	145 (5.7")	145 (5.7")	85 (3.3")
	10°	485 (1'7")	515 (1'8")	440 (1'5")

* Bucket at carry, outside corner of bucket.

** At the end of teeth or B.O.C.

Performance Data Dimensions

WHEEL LOADERS

WA600-3 (with high lift boom)

	Capacity Heaped m ³ (cu.yd)	Struck m ³ (cu.yd)	Bucket width* mm (ft.in)	Bucket weight kg (lb)	Breakout force kgf (lb)
I Excavating bucket (straight edge) with tip teeth	5.6 (7.3)	4.0 (5.2)	3685 (12'1")		44500 (98,210)
II Excavating bucket (spade nose) with tip teeth	5.6 (7.3)	4.0 (5.2)	3685 (12'1")	4400 (9,700)	37500 (82,670)

* Excluding tire protectors

Tires/Buckets	Operating weight kg(lb)		Static tipping load kg(lb)			
	I	II	Straight		40° full turn	
			I	II	I	II
35/65-33-24PR (L4)	46100 (101,630)	46600 (102,730)	28600 (63,050)	29100 (64,150)	25240 (55,640)	25650 (56,550)

- All dimensions, weights and performance values based on SAE J-732c and J-742b standards.
- Static tipping load and operating weight shown include lubricant, coolant, full fuel tank, steel cab, ROPS canopy, front half fenders, tip type teeth, 3820kg (8420 lb) counterweight for high lift boom and operator.
- Machine stability and operating weight are affected by counterweight or ballast, tire size and other attachments. Use either counterweight or ballast, not both. Apply the following weight changes to operating weight and static tipping load.

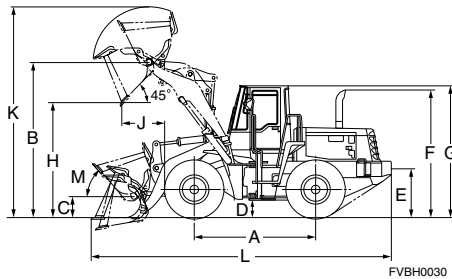

	Unit: mm (ft.in)
Tread	35/65-33 tires
Width over tires	2650 (8'8")
A Wheelbase	3570 (11'9")
B Hinge pin height, max. height	4100 (13'5")
C Hinge pin height, carry position	5770 (18'11")
D Ground clearance	670 (2'2")
E Hitch height	7720 (25'4")
F Overall height, top of the stack	7720 (37'10")
G Overall height, ROPS canopy	11850 (38'11")
Overall height, ROPS and cab	4250 (13'11")
M Tilt back angle	4250 (13'11")
	49.5°

Measured with 35/65-33 tires

	Buckets	I	II
H. Dumping clearance, max. height and 45° dump angle**		4180 (13'9")	3995 (13'1")
J. Reach at max. height and 45° dump angle**		1690 (5'7")	1885 (6'2")
K. Operating height (fully raised)		7720 (25'4")	7720 (37'10")
L. Overall length		11520 (37'10")	11850 (38'11")
Turning radius*		8480 (27'10")	8480 (27'10")
Digging depth	0°	50 (1.9")	125 (4.8")
	10°	410 (1'4")	485 (1'7")

* Bucket at carry, outside corner of bucket.

** At the end of teeth or B.O.C.

Performance Data Dimensions

WHEEL LOADERS

WA600-3 (for Load & Carry)

	Capacity Heaped m ³ (cu.yd)	Struck m ³ (cu.yd)	Bucket width* mm (ft.in)	Bucket weight kg (lb)	Breakout force kgf (lb)
I Excavating bucket (spade nose) with tip teeth	7.5 (9.8)	6.8 (8.9)	3685 (12'1")	5075 (11,190)	35400 (78,040)

* Excluding tire protectors

	Operating weight kg(lb)	Static tipping load kg(lb)	
		Straight	40° full turn
Tires/Buckets	I	I	I
35/65-33-42PR (L4)	49400 (108,910)	38900 (85,760)	34300 (75,620)

- All dimensions, weights and performance values based on SAE J-732c and J-742b standards.
- Static tipping load and operating weight shown include lubricant, coolant, full fuel tank, steel cab, ROPS canopy, front half fenders, tip type teeth, 5300kg (11680 lb) counterweight for Load & Carry and operator.
- Machine stability and operating weight are affected by counterweight or ballast, tire size and other attachments.
Use either counterweight or ballast, not both. Apply the following weight changes to operating weight and static tipping load.

	Unit: mm (ft.in)
	35/65-33 tires
	Tread
	Width over tires
	A Wheelbase
	B Hinge pin height, max. height
	C Hinge pin height, carry position
	D Ground clearance
	E Hitch height
	F Overall height, top of the stack
	G Overall height, ROPS canopy
	Overall height, ROPS and cab
	M Tilt back angle

Measured with 35/65-33 tires

	Buckets	I
H. Dumping clearance, max. height and 45° dump angle**		2920 (9'7")
J. Reach at max. height and 45° dump angle**		2105 (6'11")
K. Operating height (fully raised)		7065 (23'2")
L. Overall length		11395 (37'5")
Turning radius*		8225 (27'0")
Digging depth	0°	105 (4.1")
	10°	505 (1'8")

* Bucket at carry, outside corner of bucket.

** At the end of teeth or B.O.C.

Performance Data Dimensions

WHEEL LOADERS

WA600-3 (for stone handling)

	Capacity Heaped m ³ (cu.yd)	Struck m ³ (cu.yd)	Bucket width mm (ft.in)	Bucket weight kg (lb)	Breakout force kgf (lb)
I Stone handling bucket	—	—	—	—	38800 (85,540)

	Operating weight kg(lb)	Static tipping load kg(lb)	
		Straight	40° full turn
Tires/Buckets	I	I	I
35/36-33-42PR (L5)	41740 (92,010)	32900 (72,530)	28850 (63,600)

- All dimensions, weights and performance values based on SAE J-732c and J-742b standards.
- Static tipping load and operating weight shown include lubricant, coolant, full fuel tank, steel cab, ROPS canopy, front half fenders, tip type teeth, 4300kg (9480 lb) counterweight for stone handling and operator.
- Machine stability and operating weight are affected by counterweight or ballast, tire size and other attachments. Use either counterweight or ballast, not both. Apply the following weight changes to operating weight and static tipping load.

Unit: mm (ft.in)

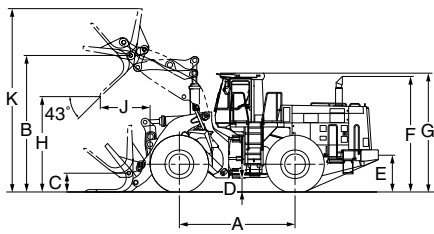

FVBH0107

Tread	35/65-33 tires
Width over tires	2650 (8'8")
A Wheelbase	3570 (11'9")
B Hinge pin height, max. height	4100 (13'5")
C Hinge pin height, carry position	4850 (15'11")
D Ground clearance	670 (2'2")
E Hitch height	495 (1'7")
F Overall height, top of the stack	1385 (4'7")
G Overall height, ROPS canopy	4125 (13'6")
Overall height, ROPS and cab	4250 (13'11")

Measured with 35/65-33 tires

	Buckets	I
H. Dumping clearance, max. height and 45° dump angle**		3335 (10'11")
J. Reach at max. height and 45° dump angle**		1850 (6'1")
K. Operating height (fully raised)		
L. Overall length		10550 (34'7")
Turning radius*		
Digging depth	0°	45 (1.8")
	10°	361 (12")

* Bucket at carry, outside corner of bucket.

** At the end of teeth or B.O.C.

NOTE:

- It forbids riding over obstacle during stone handling (Allowable riding over height must be 50 mm (2") or less).
- Travel speed is set only to 1st gear during stone handling.

Performance Data Dimensions

WHEEL LOADERS

WA700-3

	Capacity Heaped m ³ (cu.yd)	Struck m ³ (cu.yd)	Bucket width* mm (ft.in)	Bucket weight kg (lb)	Breakout force kgf (lb)
I Excavating bucket (straight edge) without tip teeth	8.7 (11.4)	7.6 (9.9)	4330 (14'2")	6770 (14,925)	64700 (142,640)
II Excavating bucket (spade nose) without tip teeth	8.7 (11.4)	7.6 (9.9)	4330 (14'2")	7150 (15,760)	52700 (116,180)
III General-purpose bucket (straight edge) without tip teeth	9.4 (12.3)	8.2 (10.7)	4330 (14'2")	7150 (15,760)	62400 (137,600)

* Excluding tire protectors

Tires/Buckets	Operating weight kg(lb)			Static tipping load kg(lb)					
	I	II	III	Straight			40° full turn		
				I	II	III	I	II	III
40/65-39-36 PR (L5)	70620 (155,690)	71000 (156,530)	71000 (156,530)	46400 (102,290)	46050 (101,520)	46700 (102,955)	40730 (89,790)	40440 (89,070)	41080 (90,565)
41.25/70-39-34 PR (L5)	71220 (157,010)	71600 (157,850)	71600 (157,850)	46830 (103,240)	46480 (102,470)	47130 (103,900)	41100 (90,610)	40750 (89,840)	41450 (91,380)
45/65-R39 (L5)	71700 (158,070)	72080 (158,910)	72080 (158,910)	47160 (103,970)	46810 (103,200)	47460 (104,630)	41400 (91,270)	41070 (90,540)	41750 (92,040)

- All dimensions, weights and performance values based on SAE J-732c and J-742b standards.
- Static tipping load and operating weight shown include lubricant, coolant, full fuel tank, steel cab, ROPS canopy, front half-fenders and tip type teeth and operator.
- Machine stability and operating weight are affected by counterweight or ballast, tire size and other attachments. Use either counterweight or ballast, not both. Apply the following weight changes to operating weight and static tipping load.

Weight Changes

	Change in operating weight kg (lb)	Change in tipping load kg (lb)	
		Straight	Full turn
Remove ROPS canopy	-1050 (-2,315)	-965 (-2,130)	-850 (-1,870)
Remove steel cab	-430 (-950)	-315 (-690)	-275 (-610)
Remove teeth and adapter	-890 (-1,960)	+1150 (+2,535)	+1005 (+2,220)

Unit: mm (ft.in)

	40/65-39-36PR (L5) tires	45/65 R39 (L5) tires
Tread	3000 (9'10")	3060 (10')
Width over tires	4040 (13'3")	4160 (13'8")
A Wheelbase	4800 (15'9")	4800 (15'9")
B Hinge pin height, max. height	5990 (19'8")	6035 (19'10")
C Hinge pin height, carry position	720 (2'4")	765 (2'6")
D Ground clearance	540 (1'9")	585 (1'11")
E Hitch height	1530 (5')	1575 (5'2")
F Overall height, top of the stack	4825 (15'10")	4870 (16')
G Overall height, ROPS canopy	4790 (15'9")	4835 (15'10")
M Tilt back angle	50°	

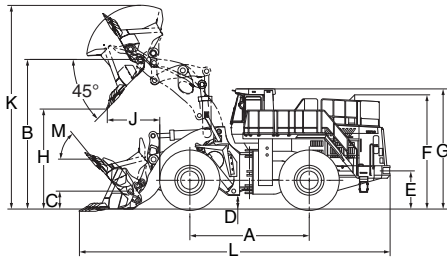

Buckets	Measured with 40/65-39-36 PR (L5) tires			Measured with 45/65-R39 (L5) tires		
	I	II	III	I	II	III
H. Dumping clearance, max. height and 45° dump angle**	4280 (14'1")	4040 (13'3")	4195 (13'9")	4325 (14'2")	4085 (13'5")	4240 (13'11")
J. Reach at max. height and 45° dump angle**	1890 (6'2")	2135 (7')	1975 (6'6")	1890 (6'2")	2135 (7')	1975 (6'6")
Reach at 2130 mm (7") cut edge clearance and 45° dump angle	2770 (9'1")	2985 (9'10")	2850 (9'4")	2770 (9'1")	2985 (9'10")	2850 (9'4")
Reach with arm horizontal and bucket level	3500 (11'6")	3840 (12'7")	3620 (11'10")	3500 (11'6")	3840 (12'7")	3620 (11'10")
K. Operating height (fully raised)	8170 (26'10")	8170 (26'10")	8320 (27'3")	8215 (26'11")	8215 (26'11")	8365 (27'5")
L. Overall length (with tipteeth)	12160 (39'11")	12500 (41')	12280 (40'3")	12135 (39'10")	12475 (40'11")	12255 (40'2")
Turning radius*	9630 (31'7")	9615 (31'7")	9660 (31'8")	9630 (31'7")	9615 (31'7")	9660 (31'8")
Digging depth	0°	170 (7")	170 (7")	170 (7")	125 (4.9")	125 (4.9")
	10°	510 (1'8")	570 (1'10")	535 (1'9")	465 (1'6")	525 (1'9")

* Bucket at carry, outside corner of bucket.

** At the end of tooth

Performance Data Dimensions

WHEEL LOADERS

WA700-3 (with high lift boom)

	Capacity Heaped m ³ (cu.yd)	Struck m ³ (cu.yd)	Bucket width* mm (ft.in)	Bucket weight kg (lb)	Breakout force kgf (lb)
I Excavating bucket (spade nose) with tip teeth	8.0 (10.5)	7.0 (9.2)	4330 (14'2")	6830 (15,060)	55800 (123,020)
II Stockpile bucket (spade nose) with tip teeth	8.7 (11.4)	7.6 (9.9)	4330 (14'2")	7150 (15,760)	52700 (116,180)

* Excluding tire protectors

Tires/Buckets	Operating weight kg(lb)		Static tipping load kg(lb)			
			Straight		40° turn	
	I	II	I	II	I	II
40/65-39-36PR (L5)	72200 (159,170)	72400 (159,610)	41900 (92,370)	41600 (91,710)	36400 (80,250)	36100 (79,590)

- All dimensions, weights and performance values based on SAE J-732c and J-742b standards.
- Static tipping load and operating weight shown include lubricant, coolant, full fuel tank, steel cab, ROPS canopy, front half-fenders, additional counterweight 1040 kg (2290 lb) and tip type teeth and operator.
- Machine stability and operating weight are affected by counterweight or ballast, tire size and other attachments.
Use either counterweight or ballast, not both. Apply the following weight changes to operating weight and static tipping load.

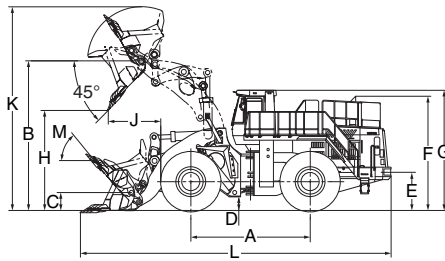

	Unit: mm (ft.in)
Tread	3000 (9'10")
Width over tires	4040 (13'3")
A Wheelbase	4800 (15'9")
B Hinge pin height, max. height	6550 (21'6")
C Hinge pin height, carry position	720 (2'4")
D Ground clearance	540 (1'9")
E Hitch height	1545 (5'1")
F Overall height, top of the stack	4580 (15')
G Overall height, ROPS and cab	4790 (15'9")
M Tilt back angle	50°

Measured with 40/65-39-36 PR (L5) tires

	Buckets	
	I	II
H. Dumping clearance, max. height and 45° dump angle**	4645 (15'3")	4575 (15'0")
J. Reach at max. height and 45° dump angle**	2120 (6'11")	2190 (7'2")
K. Operating height (fully raised)	8625 (28'6")	8720 (28'7")
L. Overall length	13315 (43'8")	13410 (44'0")
Turning radius*	9840 (32'3")	9865 (32'4")
Digging depth	0°	185 (7.3")
	10°	570 (1'10")

* Bucket at carry, outside corner of bucket.

** At the end of teeth

Performance Data Dimensions

WHEEL LOADERS

WA800-3E0

Unit: mm (ft.in)

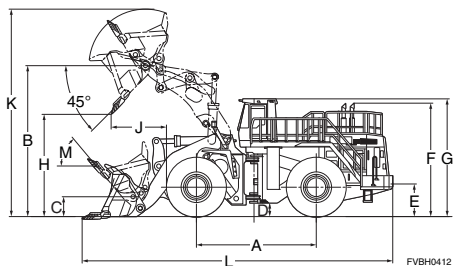

	Standard boom	High lift boom	Short boom
Tread		3350 (11'0")	
Width over tires		4585 (15'1")	
A Wheelbase		5450 (17'11")	
B Hinge pin height, max. height	6785 (22'3")	7265 (23'10")	6140 (20'2")
C Hinge pin height, carry position		850 (2'9")	
D Ground clearance		550 (1'10")	
E Hitch height		1390 (4'7")	
F Overall height, top of the stack		5130 (16'10")	
G Overall height, ROPS cab		5275 (17'4")	
M Tilt back angle		50°	

Measured with 45/65-45-46PR (L5) tires

Bucket type			Standard boom		High lift boom	Short boom
			Excavating Bucket	Stockpile Bucket	Rock Bucket	Load & Carry
			Spade nose Teeth	Spade nose Teeth	Spade nose Teeth	Spade nose Teeth
Bucket capacity	Heaped	m ³ (yd ³)	11.0 (14.4)	12.3 (16.1)	10.0 (13.1)	14.0 (18.3)
	Struck	m ³ (yd ³)	9.3 (12.2)	10.4 (13.6)	8.5 (11.1)	11.5 (15.0)
Bucket width		mm (ft.in)	4810 (15'9")	4810 (15'9")	4810 (15'9")	5090 (16'8")
Bucket weight		kg (lb)	11430 (25,200)	12150 (26,790)	10750 (23,700)	12080 (26,630)
Static tipping load	Straight	kg (lb)	61090 (134,680)	60320 (132,980)	58710 (129,430)	68860 (151,810)
	Full turn (43°)	kg (lb)	53740 (118,480)	52970 (116,780)	51640 (113,850)	60660 (133,730)
H. Dumping clearance, max. height and 45° dump angle**		mm (ft.in)	4630 (15'2")	4252 (14'10")	5210 (17'1")	3820 (12'6")
Reach at 2130 mm (7') clearance and 45° dump angle		mm (ft.in)	3455 (11'4")	3550 (11'8")	3915 (12'10")	3350 (11'0")
J. Reach at max. height and 45° dump angle**		mm (ft.in)	2385 (7'10")	2495 (8'2")	2315 (7'7")	2690 (8'10")
Reach with arm horizontal and bucket level		mm (ft.in)	4360 (14'4")	4510 (14'10")	5010 (16'5")	4550 (14'11")
K. Operating height (fully raised)		mm (ft.in)	9300 (30'6")	9430 (30'11")	9625 (31'7")	8740 (28'8")
Overall length		mm (ft.in)	13960 (45'10")	14110 (46'4")	14695 (48'3")	13685 (44'11")
Turning radius*		mm (ft.in)	10900 (35'9")	10965 (36'0")	11100 (36'5")	11020 (36'2")
Digging depth	0°	mm (ft.in)	165 (6.5")	165 (6.5")	200 (7.9")	200 (7.9")
	10°	mm (ft.in)	605 (20")	630 (2'1")	620 (2'0")	670 (2'2")
Breakout force	kN		676.7	629.3	703.5	657.3
	kgf (lb)		69000 (152,120)	64170 (141,470)	71790 (158,270)	67000 (147,710)
Operating weight	kg		101900	102620	103420	104500
	(lb)		(224,650)	(226,240)	(228,000)	(230,380)

* Bucket at carry, outside corner of bucket.

** At the end of tooth or B.O.C

- All dimensions, weights, and performance values based on SAE J732c and J742b standards.
- Static tipping load and operating weight shown include lubricant, coolant, full fuel tank, ROPS cab and operator.
- Machine stability and operating weight affected by counterweight, tire size, and other attachments. Apply the following weight changes to operating weight and static tipping load.

Weight Changes

	Operating weight		Tipping Load			
			Straight		Full Turn	
	kg	lb	kg	lb	kg	lb
Remove ROPS canopy	-1385	-3,055	-1220	-2,690	-1180	-2,600
Remove steel cab	-430	-950	-335	-740	-330	-730
Install additional counter weight	+1600	+3,530	+3850	+8,490	+3400	+7,500

Performance Data Dimensions

WHEEL LOADERS

WA800-3

	Capacity Heaped m ³ (cu.yd)	Struck m ³ (cu.yd)	Bucket width* mm (ft.in)	Bucket weight kg (lb)	Breakout force kgf (lb)
I Excavating bucket (spade nose) with tip teeth	11.0 (14.4)	9.3 (12.2)	4810 (15'9")	11430 (25,200)	69000 (152,120)
II Stock pile (spade nose) with teeth	12.3 (16.1)	10.4 (13.6)	4810 (15'9")	12150 (26,790)	64170 (141,470)

* Excluding tire protectors

Tires/Buckets	Operating weight kg(lb)		Static tipping load kg(lb)			
			Straight		40° full turn	
	I	II	I	II	I	II
45/65-45-46PR(L5)	98300 (216,710)	99020 (218,300)	57400 (126,540)	56680 (124,960)	50500 (111,330)	49780 (109,740)
45/65-45-50PR(L4)	96580 (212,920)	97300 (214,510)	54820 (120,860)	54100 (119,270)	48260 (106,390)	47540 (104,810)
45/65-45-50PR(L5)	98500 (217,150)	99220 (218,740)	57700 (127,210)	56980 (125,620)	50760 (111,910)	50040 (110,320)

- All dimensions, weights and performance values based on SAE J732c and J742b standards.
- Static tipping load and operating weight shown include lubricant, coolant, full fuel tank, steel cab, ROPS canopy, air conditioner, tip type teeth and operator.
- Machine stability and operating weight are affected by counterweight, or ballast, tire size and other attachments. Use either counterweight or ballast, not both. Apply the following weight changes to operating weight and static tipping load.

Weight Changes

	Change in operating weight kg (lb)	Change in tipping load kg (lb)	
		Straight	Full turn
Remove ROPS canopy	-1385 (-3,055)	-1220 (-2,690)	-1180 (-2,600)
Remove steel cab	-430 (-950)	-335 (-740)	-330 (-730)
Install additional counter weight	+1600 (+3,530)	+3850 (+8,490)	+3400 (+7,500)

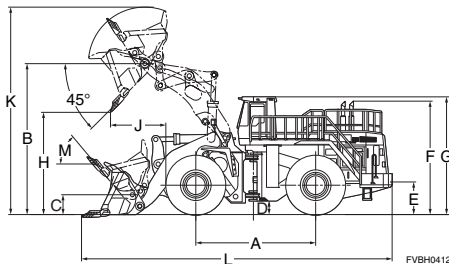

Tread	3350 (11')
Width over tires	4585 (15'1")
A Wheelbase	5450 (17'11")
B Hinge pin height, max. height	6785 (22'3")
C Hinge pin height, carry position	850 (2'9")
D Ground clearance	550 (1'10")
E Hitch height	1390 (4'7")
F Overall height, top of the stack	5080 (16'8")
G Overall height, ROPS and cab	5275 (17'4")
M Tilt back angle	50°

Unit: mm (ft.in)

45/65-45 tires

Measured with 45/65-45 tires

	Buckets	I	II
H. Dumping clearance, max. height and 45° dump angle**		4630 (15'2")	4525 (14'10")
Reach at 2130 mm (7') cut edge clearance and 45° dump angle		3455 (11'4")	3550 (11'8")
J. Reach at max. height and 45° dump angle**		2385 (7'10")	2495 (8'2")
Reach with arm horizontal and bucket level		4360 (14'4")	4510 (14'10")
K. Operating height (fully raised)		9300 (30'6")	9430 (30'11")
L. Overall length		13730 (45')	13880 (45'6")
Turning radius*		10900 (35'9")	10965 (36'0")
Digging depth	0°	165 (6.5")	165 (6.5")
	10°	605 (1'11")	630 (2'1")

* Bucket at carry, outside corner of bucket.

** At the end of teeth or B.O.C.

Performance Data Dimensions

WHEEL LOADERS

WA800-3 (with high lift boom)

	Capacity Heaped m ³ (cu.yd)	Struck m ³ (cu.yd)	Bucket width* mm (ft.in)	Bucket weight kg (lb)	Breakout force kgf (lb)
I Excavating bucket (spade nose) with tip teeth	10.0 (13.1)	8.5 (11.1)	4810 (15'9")		71790 (158,270)

* Excluding tire protectors

Tires/Buckets	Operating weight kg(lb)		Static tipping load kg(lb)			
			Straight		40° full turn	
	I	II	I	II	I	II
45/65-45-46PR(L5)	99820 (220,060)		55160 (121,610)		48530 (106,990)	

- All dimensions, weights and performance values based on SAE J732c and J742b standards.
- Static tipping load and operating weight shown include lubricant, coolant, full fuel tank, steel cab, ROPS canopy, air conditioner, tip type teeth, 4500kg (9920 lb) counterweight for high lift boom and operator.
- Machine stability and operating weight are affected by counterweight, or ballast, tire size and other attachments.
Use either counterweight or ballast, not both. Apply the following weight changes to operating weight and static tipping load.

Weight Changes

Weight Changes	Change in operating weight kg (lb)	Change in tipping load kg (lb)	
		Straight	Full turn
Remove ROPS canopy	-1385 (-3,055)	-1220 (-2,690)	-1180 (-2,600)
Remove steel cab	-430 (-950)	-335 (-740)	-330 (-730)
Install additional counter weight	+1600 (+3,530)	+3850 (+8,490)	+3400 (+7,500)

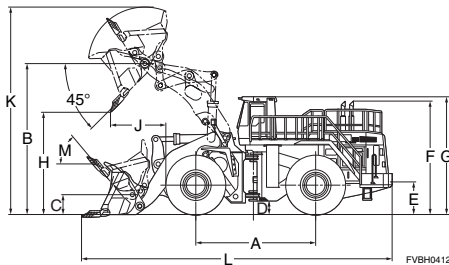

Tread	
Width over tires	
A Wheelbase	
B Hinge pin height, max. height	
C Hinge pin height, carry position	
D Ground clearance	
E Hitch height	
F Overall height, top of the stack	
G Overall height, ROPS and cab	
M Tilt back angle	

Unit: mm (ft.in)

45/65-45 tires	
3350 (11')	
4585 (15'1")	
5450 (17'11")	
7265 (23'10")	
850 (2'9")	
550 (1'10")	
1390 (4'7")	
5080 (16'8")	
5275 (17'4")	
50°	

Measured with 45/65-45 tires

	Buckets	I	II
H. Dumping clearance, max. height and 45° dump angle**		5210 (17'1")	
J. Reach at max. height and 45° dump angle**		2315 (7'7")	
K. Operating height (fully raised)		9625 (31'7")	
L. Overall length		14480 (47'6")	
Turning radius*		11100 (35'8")	
Digging depth	0°	200 (7.9")	
	10°	620 (2'0")	

* Bucket at carry, outside corner of bucket.

** At the end of teeth or B.O.C.

Performance Data Dimensions

WHEEL LOADERS

WA800-3 (for Load & Carry)

	Capacity Heaped m ³ (cu.yd)	Struck m ³ (cu.yd)	Bucket width* mm (ft.in)	Bucket weight kg (lb)	Breakout force kgf (lb)
I Excavating bucket (spade nose) with tip teeth	14.0 (18.3)	11.5 (15.0)	5040 (16'6")		67000 (147,710)

* Excluding tire protectors

Tires/Buckets	Operating weight kg(lb)		Static tipping load kg(lb)			
			Straight		40° full turn	
	I	II	I	II	I	II
45/65-45-58PR(L4)	100900 (222,440)		64700 (142,640)		57000 (125,660)	

- All dimensions, weights and performance values based on SAE J732c and J742b standards.
- Static tipping load and operating weight shown include lubricant, coolant, full fuel tank, steel cab, ROPS canopy, air conditioner, tip type teeth, 5500kg (12130 lb) counterweight for Load & Carry and operator.
- Machine stability and operating weight are affected by counterweight, or ballast, tire size and other attachments.
Use either counterweight or ballast, not both. Apply the following weight changes to operating weight and static tipping load.

Weight Changes

	Change in operating weight kg (lb)	Change in tipping load kg (lb)	
		Straight	Full turn
Remove ROPS canopy	-1385 (-3,055)	-1220 (-2,690)	-1180 (-2,600)
Remove steel cab	-430 (-950)	-335 (-740)	-330 (-730)
Install additional counter weight	+1600 (+3,530)	+3850 (+8,490)	+3400 (+7,500)

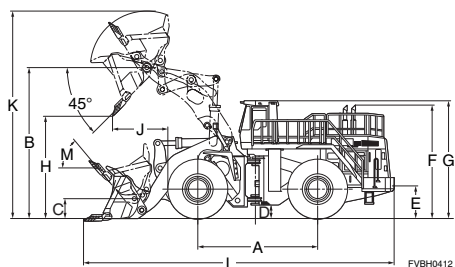

Tread	
Width over tires	
A Wheelbase	
B Hinge pin height, max. height	
C Hinge pin height, carry position	
D Ground clearance	
E Hitch height	
F Overall height, top of the stack	
G Overall height, ROPS and cab	
M Tilt back angle	

Unit: mm (ft.in)

45/65-45 tires

Tread	3350 (11')
Width over tires	4585 (15'1")
A Wheelbase	5450 (17'11")
B Hinge pin height, max. height	6140 (20'2")
C Hinge pin height, carry position	850 (2'9")
D Ground clearance	550 (1'10")
E Hitch height	1390 (4'7")
F Overall height, top of the stack	5080 (16'8")
G Overall height, ROPS and cab	5275 (17'4")
M Tilt back angle	50°

Measured with 45/65-45 tires

	Buckets	I	II
H. Dumping clearance, max. height and 45° dump angle**		3810 (12'6")	
J. Reach at max. height and 45° dump angle**		2680 (8'10")	
K. Operating height (fully raised)		8740 (28'8")	
L. Overall length		13280 (43'7")	
Turning radius*		11020 (36'2")	
Digging depth	0°	200 (7.9")	
	10°	670 (2'2")	

* Bucket at carry, outside corner of bucket.

** At the end of teeth or B.O.C.

Performance Data Dimensions

WHEEL LOADERS

WA900-3E0

Unit: mm (ft.in)

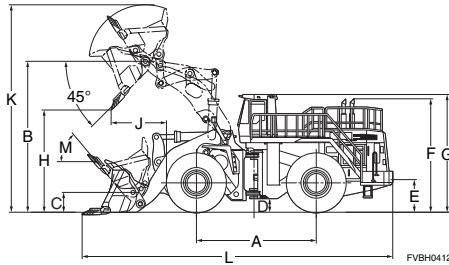

Tread	Standard boom	High lift boom
Width over tires	3350 (11'0")	
A Wheelbase	4585 (15'1")	
B Hinge pin height, max. height	5450 (17'11")	
C Hinge pin height, carry position	6960 (22'10")	7445 (24'5")
D Ground clearance	800 (27")	
E Hitch height	550 (1'10")	
F Overall height, top of the stack	1390 (4'7")	
G Overall height, ROPS cab	5130 (16'10")	
M Tilt back angle	5275 (17'4")	50°

Measured with 45/65-45-58 (L5) tires

Bucket type			Standard boom		High lift boom	
			Excavating Bucket		Excavating Bucket	
			Spade nose Tipteeth		Spade nose Teeth	
Bucket capacity	Heaped	m ³ (yd ³)	13.0 (17.0)		11.5 (15.0)	
	Struck	m ³ (yd ³)	11.0 (14.4)		9.7 (12.7)	
Bucket width		mm (ft.in)	4810 (15'9")		4810 (15'9")	
Bucket weight		kg (lb)	12330 (27,180)		11370 (25,070)	
Static tipping load	Straight	kg (lb)	65670 (144,780)		62540 (137,880)	
	Full turn (43°)	kg (lb)	57430 (126,610)		55030 (121,320)	
H. Dumping clearance, max. height and 45° dump angle**		mm (ft.in)	4640 (15'3")		5255 (17'3")	
Reach at 2130 mm (7') clearance and 45° dump angle		mm (ft.in)	3650 (12'0")		4020 (13'2")	
J. Reach at max. height and 45° dump angle**		mm (ft.in)	2450 (8'0")		2235 (7'4")	
Reach with arm horizontal and bucket level		mm (ft.in)	4640 (15'3")		4760 (15'7")	
K. Operating height (fully raised)		mm (ft.in)	9680 (31'9")		9875 (32'5")	
L. Overall length		mm (ft.in)	14490 (47'6")		14685 (48'2")	
Turning radius*		mm (ft.in)	11000 (72'2")		11100 (72'10")	
Digging depth	0°	mm (ft.in)	165 (6.5")		160 (6.3")	
	10°	mm (ft.in)	645 (2'1")		610 (2'0")	
Breakout force		kN kgf (lb)	666 67900 (149,690)		703 71700 (158,070)	
Operating weight		kg (lb)	107200 (236,340)		107350 (236,670)	

* Bucket at carry, outside corner of bucket.

** At the end of tooth or B.O.C

- All dimensions, weights, and performance values based on SAE J732c and J742b standards.
- Static tipping load and operating weight shown include lubricant, coolant, full fuel tank, ROPS cab and operator.
- Machine stability and operating weight affected by counterweight, tire size, and other attachments.
Apply the following weight changes to operating weight and static tipping load.

Weight Changes

	Operating weight		Tipping Load			
			Straight		Full Turn	
	kg	lb	kg	lb	kg	lb
Remove ROPS canopy	-1385	-3,055	-1220	-2,690	-1180	-2,600
Remove steel cab	-430	-950	-335	-740	-330	-730

Performance Data Dimensions

WHEEL LOADERS

WA900-3

	Capacity Heaped m ³ (cu.yd)	Struck m ³ (cu.yd)	Bucket width* mm (ft.in)	Bucket weight kg (lb)	Breakout force kgf (lb)
I Excavating bucket (spade nose) with tip teeth	13.0 (17.0)	11.0 (14.4)	4810 (15'9")	12320 (27,160)	67900 (149,690)

* Excluding tire protectors

	Operating weight kg(lb)	Static tipping load kg(lb)	
		Straight	40° full turn
Tires/Buckets	I	I	I
45/65-45-58PR(L5)	101550 (223,880)	66140 (145,810)	58200 (128,310)

- All dimensions, weights and performance values based on SAE J732c and J742b standards.
- Static tipping load and operating weight shown include lubricant, coolant, full fuel tank, steel cab, ROPS canopy, air conditioner, tip type teeth and operator.
- Machine stability and operating weight are affected by counterweight, or ballast, tire size and other attachments. Use either counterweight or ballast, not both. Apply the following weight changes to operating weight and static tipping load.

Weight Changes

	Change in operating weight kg (lb)	Change in tipping load kg (lb)	
		Straight	Full turn
Remove ROPS canopy	-1385 (-3,055)	-1220 (-2,690)	-1180 (-2,600)
Remove steel cab	-430 (-950)	-335 (-740)	-330 (-730)

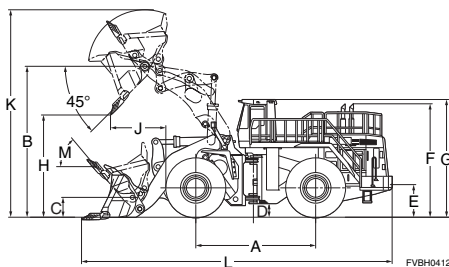

Tread	3350 (11')
Width over tires	4585 (15'1")
A Wheelbase	5450 (17'11")
B Hinge pin height, max. height	6960 (22'10")
C Hinge pin height, carry position	800 (2'7")
D Ground clearance	550 (1'10")
E Hitch height	1300 (4'3")
F Overall height, top of the stack	5080 (16'8")
G Overall height, ROPS and cab	5275 (17'4")
M Tilt back angle	50°

Unit: mm (ft.in)

45/65-45-Tires

Measured with 45/65-45 tires

	Bucket	I
H. Dumping clearance, max. height and 45° dump angle**	4640 (15'3")	
Reach at 2130 mm (7') cut edge clearance and 45° dump angle	3650 (12')	
J. Reach at max. height and 45° dump angle*	2450 (8')	
Reach with arm horizontal and bucket level	4640 (15'3")	
K. Operating height (fully raised)	9680 (31'9")	
L. Overall length	14270 (46'10")	
Turning radius*	11000 (36'1")	
Digging depth	0°	165 (6.5")
	10°	645 (2'1")

* Bucket at carry, outside corner of bucket.

** At the end of teeth or B.O.C.

Performance Data Dimensions

WHEEL LOADERS

WA900-3 (with high lift boom)

	Capacity Heaped m ³ (cu.yd)	Struck m ³ (cu.yd)	Bucket width* mm (ft.in)	Bucket weight kg (lb)	Breakout force kgf (lb)
I Excavating bucket (spade nose) with tip teeth	11.5 (15.0)	9.7 (12.7)	4810 (15'9")		71700 (158,070)

* Excluding tire protectors

	Operating weight kg(lb)	Static tipping load kg(lb)	
		Straight	40° full turn
Tires/Buckets	I	I	I
45/65-45-58PR(L5)	101920 (224,690)	62540 (137,880)	55030 (121,320)

- All dimensions, weights and performance values based on SAE J732c and J742b standards.
- Static tipping load and operating weight shown include lubricant, coolant, full fuel tank, steel cab, ROPS canopy, air conditioner, tip type teeth 5900kg (13010 lb) counterweight for high lift boom and operator.
- Machine stability and operating weight are affected by counterweight, or ballast, tire size and other attachments.
Use either counterweight or ballast, not both. Apply the following weight changes to operating weight and static tipping load.

Weight Changes

	Change in operating weight kg (lb)	Change in tipping load kg (lb)	
		Straight	Full turn
Remove ROPS canopy	-1385 (-3,055)	-1220 (-2,690)	-1180 (-2,600)
Remove steel cab	-430 (-950)	-335 (-740)	-330 (-730)

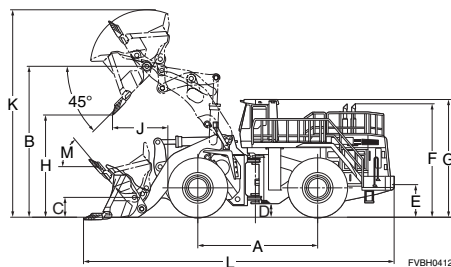

Tread	
Width over tires	
A Wheelbase	
B Hinge pin height, max. height	
C Hinge pin height, carry position	
D Ground clearance	
E Hitch height	
F Overall height, top of the stack	
G Overall height, ROPS and cab	
M Tilt back angle	

Unit: mm (ft.in)

45/65-45-Tires	3350 (11')
	4585 (15'1")
	5450 (17'11")
	7445 (24'5")
	800 (2'7")
	550 (1'10")
	1390 (4'7")
	5080 (16'8")
	5275 (17'4")
	50°

Measured with 45/65-45 tires

	Bucket	I
H. Dumping clearance, max. height and 45° dump angle**	5255 (17'3")	
Reach at 2130 mm (7') cut edge clearance and 45° dump angle	3650 (12')	
J. Reach at max. height and 45° dump angle**	2235 (7'4")	
Reach with arm horizontal and bucket level	4640 (15'3")	
K. Operating height (fully raised)	9875 (32'5")	
L. Overall length	14790 (47'6")	
Turning radius*	11200 (36'9")	
Digging depth	0°	160 (6")
	10°	610 (2'0")

* Bucket at carry, outside corner of bucket.

** At the end of teeth or B.O.C.

Performance Data Dimensions

WHEEL LOADERS

WA1200-6 (Standard boom)

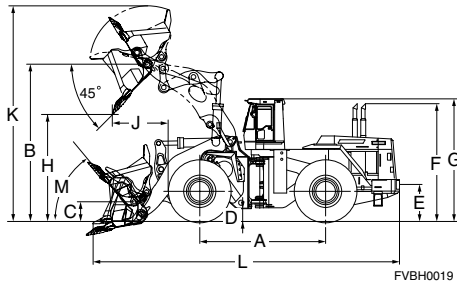

	Unit: mm (ft.in)	
Tread	60/80 R57 tires	58/85-57-84PR
Width over tires	4300 (14'1")	4300 (14'1")
A Wheelbase	5820 (19'1")	5720 (18'9")
B Hinge pin height, max. height	7100 (23'4")	7100 (23'4")
C Hinge pin height, carry position	8850 (29'0")	8855 (29'1")
D Ground clearance	1150 (3'5")	1150 (3'5")
E Hitch height	760 (2'6")	765 (2'6")
F Overall height, top of the stack	1415 (4'8")	1420 (4'8")
G Overall height, ROPS and cab	6735 (22'1")	6740 (22'1")
M Tilt back angle	6970 (22'10")	6975 (22'11")
		50°

Boom			Standard Boom 6200mm (20'3")			
Tire			60/80 R57		58/85-57-84PR	
Bucket type			Rock Bucket	Coal Bucket	Rock Bucket	Coal Bucket
			Spade nose with teeth	Spade nose without teeth	Spade nose with teeth	Spade nose without teeth
Bucket capacity	Heaped	m ³ (yd ³)	20.0 (26.2)	35.0 (45.8)	20.0 (26.2)	35.0 (45.8)
	Struck	m ³ (yd ³)	17.2 (22.5)	30.2 (39.5)	17.2 (22.5)	30.2 (39.5)
Bucket width		mm (ft.in)	6400 (21'0")	6400 (21'0")	6400 (21'0")	6400 (21'0")
Bucket width with tire protector		mm (ft.in)	6550 (21'6")	-	6550 (21'6")	-
Bucket weight		kg (lb)	22780 (50,220)	24620 (54,280)	22780 (50,220)	24620 (54,280)
Static tipping load	Straight	kg (lb)	121930 (268,800)	120530 (265,730)	122530 (270,130)	121130 (267,050)
	Full turn (43°)	kg (lb)	107060 (236,000)	105830 (233,320)	107580 (237,180)	106350 (234,460)
H. Dumping clearance, max. height and 45° dump angle**		mm (ft.in)	6305 (20'8")	6310 (20'8")	6310 (20'8")	6315 (20'9")
J. Reach at max. height and 45° dump angle**		mm (ft.in)	2890 (9'6")	3030 (9'11")	2890 (9'6")	3030 (9'11")
K. Operating height (fully raised)		mm (ft.in)	12205 (40'1")	12980 (42'7")	12210 (40'1")	12985 (42'7")
L. Overall length		mm (ft.in)	18310 (60'1")	18405 (60'5")	18305 (60'1")	18400 (60'4")
Turning radius*		mm (ft.in)	14330 (47'0")	14320 (47'0")	14330 (47'0")	14320 (47'0")
Digging depth	0°	mm (ft.in)	250 (9.8")	145 (5.7")	245 (9.6")	140 (5.5")
	10°	mm (ft.in)	785 (2'7")	700 (2'4")	780 (2'7")	695 (2'3")
Breakout force		kN kgf (lb)	1275 130000 (286,600)	1029 105000 (231,500)	1275 130000 (286,600)	1029 105000 (231,500)
Operating weight		kg (lb)	216400 (477,100)	217800 (480,200)	217220 (478,900)	218620 (482,000)

* Bucket at carry, outside corner of bucket.

** At the end of B.O.C. or teeth

- All dimensions, weights, and performance values based on SAE J732c and J742b standards.
- Static tipping load and operating weight shown include lubricant, coolant, full fuel tank, ROPS cab and operator.
- Machine stability and operating weight affected by counterweight, tire size, and other attachments.
- Use either counterweight or ballast, not both.

Weight Changes

Tires or attachments	Change in Operating Weight		Change in Tipping Load				Width Over Tire		Ground Clearance		Change in Vertical Dimensions	
			Straight		Full Turn							
	kg	lb	kg	lb	kg	lb	mm	ft.in	mm	ft.in	mm	ft.in
58/85-57-84PR	+820	+1,810	+600	+1,320	+520	+1,150	5720	18'9"	465	2'6"	+5	+0.2"

Performance Data Dimensions

WHEEL LOADERS

WA1200-6 (with high lift boom)

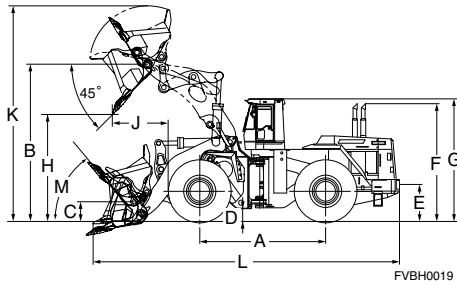

		Unit: mm (ft.in)	
Tread	60/80 R57 tires	58/85-57-84PR	
Width over tires	4300 (14'1")	4300 (14'1")	
A Wheelbase	5820 (19'1")	5720 (18'9")	
B Hinge pin height, max. height	7100 (23'4")	7100 (23'4")	
C Hinge pin height, carry position	8850 (29'0")	8855 (29'1")	
D Ground clearance	1150 (3'5")	1150 (3'5")	
E Hitch height	760 (2'6")	765 (2'6")	
F Overall height, top of the stack	1415 (4'8")	1420 (4'8")	
G Overall height, ROPS and cab	6735 (22'1")	6740 (22'1")	
M Tilt back angle	6970 (22'10")	6975 (22'11")	50°

Boom			High Lift Boom 6780mm (22'2")			
Tire			60/80 R57		58/85-57-84PR	
Bucket type			Rock Bucket	Coal Bucket	Rock Bucket	Coal Bucket
			Spade nose with teeth	Spade nose without teeth	Spade nose with teeth	Spade nose without teeth
Bucket capacity	Heaped	m ³ (yd ³)	18.0 (23.5)	35.0 (45.8)	18.0 (23.5)	35.0 (45.8)
	Struck	m ³ (yd ³)	15.0 (19.6)	30.2 (39.5)	15.0 (19.6)	30.2 (39.5)
Bucket width		mm (ft.in)	6400 (21'0")	6400 (21'0")	6400 (21'0")	6400 (21'0")
Bucket width with tire protector		mm (ft.in)	6550 (21'6")	-	6550 (21'6")	-
Bucket weight		kg (lb)	22400 (49,380)	24620 (54,280)	22400 (49,380)	24620 (54,280)
Static tipping load	Straight	kg (lb)	110950 (244,580)	108850 (239,970)	111550 (245,920)	109450 (241,300)
	Full turn (43°)	kg (lb)	97410 (214,760)	95570 (210,700)	97940 (215,920)	96100 (211,860)
H. Dumping clearance, max. height and 45° dump angle**		mm (ft.in)	7065 (23'2")	6990 (22'11")	7070 (23'2")	6995 (22'11")
J. Reach at max. height and 45° dump angle**		mm (ft.in)	2930 (9'7")	3135 (10'3")	2930 (9'7")	3135 (10'3")
K. Operating height (fully raised)		mm (ft.in)	12785 (41'11")	13660 (44'10")	12790 (42'0")	13665 (44'10")
L. Overall length		mm (ft.in)	18945 (62'2")	19140 (62'10")	18940 (62'2")	19135 (62'9")
Turning radius*		mm (ft.in)	14615 (47'11")	14650 (48'1")	14615 (47'11")	14650 (48'1")
Digging depth	0°	mm (ft.in)	250 (9.8")	145 (5.7")	245 (9.6")	140 (5.5")
	10°	mm (ft.in)	770 (2'6")	685 (2'3")	765 (2'6")	680 (2'3")
Breakout force		kN kgf (lb)	1236 126000 (277,780)	1000 102000 (224,800)	1236 126000 (277,780)	1000 102000 (224,800)
Operating weight		kg (lb)	218300 (481,300)	219700 (484,400)	219150 (483,150)	220550 (486,250)

* Bucket at carry, outside corner of bucket.

** At the end of B.O.C. or teeth

- All dimensions, weights, and performance values based on SAE J732c and J742b standards.
- Static tipping load and operating weight shown include lubricant, coolant, full fuel tank, ROPS cab and operator.
- Machine stability and operating weight affected by counterweight, tire size, and other attachments.
- Use either counterweight or ballast, not both.

Weight Changes

Tires or attachments	Change in Operating Weight		Change in Tipping Load				Width Over Tire		Ground Clearance		Change in Vertical Dimensions	
			Straight		Full Turn							
	kg	lb	kg	lb	kg	lb	mm	ft.in	mm	ft.in	mm	ft.in
58/85-57-84PR	+820	+1,810	+540	+1,190	+470	+1,040	5720	18'9"	765	2'6"	+5	+0.2"

Performance Data Dimensions

WHEEL LOADERS

WA150-6 (for USA)

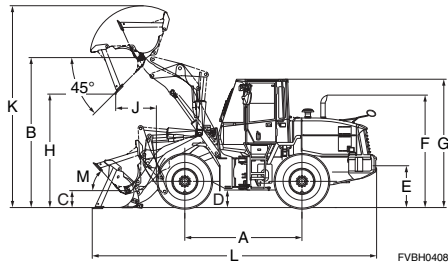

	15.5-25 tires	17.5-25 tires
Tread	1780 (5'10")	1780 (5'11")
Width over tires	2180 (7'2")	2220 (7'3")
A Wheelbase	2600 (8'6")	2600 (8'6")
B Hinge pin height, max. height	3475 (11'5")	3510 (11'6")
C Hinge pin height, carry position	360 (1'2")	355 (1'2")
D Ground clearance	390 (1'3")	425 (1'5")
E Hitch height	790 (2'7")	825 (2'8")
F Overall height, top of the stack	2485 (8'2")	2520 (8'3")
G Overall height, ROPS cab	3025 (9'11")	3060 (10'0")
M Tilt back angle	46°	

Measured with 17.5-25-12PR (L2) tires, ROPS/FOPS cab

Bucket type			Stockpile Bucket With Bolt-on Cutting Edge	Excavating Bucket With Bolt-on Cutting Edge	Light Material Bucket With Bolt-on Cutting Edge
Bucket capacity	Heaped	m ³ (yd ³)	1.5 (2.0)	1.3 (1.7)	1.7 (2.2)
	Struck	m ³ (yd ³)	1.25 (1.6)	1.1 (1.4)	1.5 (2.0)
Bucket width		mm (ft.in)	2390 (7'10")	2390 (7'10")	2390 (7'10")
Bucket weight		kg (lb)	595 (1,310)	580 (1,280)	665 (1,470)
Static tipping load	Straight	kg (lb)	6745 (14,873)	6785 (14,963)	6650 (14,863)
	Full turn (40°)	kg (lb)	5870 (12,939)	5905 (13,014)	5790 (12,769)
H. Dumping clearance, max. height and 45° dump angle**		mm (ft.in)	2730 (8'11")	2770 (9'1")	2655 (8'9")
Reach at 2130 mm (7') and 45° dump angle**		mm (ft.in)	1360 (4'6")	1340 (4'5")	1395 (4'7")
J. Reach at max. height and 45° dump angle**		mm (ft.in)	945 (3'1")	905 (3'0")	1020 (3'4")
Reach with arm horizontal and bucket level**		mm (ft.in)	2030 (6'8")	1970 (6'5")	2135 (7'0")
K. Operating height (fully raised)		mm (ft.in)	4655 (15'3")	4685 (15'4")	4735 (15'6")
L. Overall length, bucket on ground		mm (ft.in)	6310 (20'8")	6250 (20'6")	6415 (21'1")
Turning radius*		mm (ft.in)	5380 (17'8")	5360 (17'7")	5405 (17'9")
Digging depth	0°	mm (ft.in)	65 (2.5")	65 (2.5")	65 (2.5")
	10°	mm (ft.in)	230 (9.0")	220 (8.6")	245 (9.6")
Breakout force		kN kgf (lb)	72.6 7400 (16,310)	78.6 8010 (17,660)	64.0 6530 (14,400)
Operating weight		kg (lb)	7850 (17,311)	7835 (17,271)	7920 (17,461)

* Bucket at carry, outside corner of bucket.

** At the end of B.O.C.

- All dimensions, weights, and performance values based on SAE J732c and J742b standards.
- Static tipping load and operating weight shown include lubricant, coolant, full fuel tank, ROPS cab and operator.
- Machine stability and operating weight affected by counterweight, tire size, and other attachments.

Weight Changes

	Change in Operating Weight		Change in Tipping Load				Change in Width Over Tires		Change in Ground Clearance		Change in Vertical Dimensions		Change in Reach	
	kg	lb	Straight		Full Turn		mm	ft.in	mm	ft.in	mm	ft.in	mm	ft.in
			kg	lb	kg	lb								
15.5-25-8PR (L2)	-140	-309	-100	-221	-90	-198	2180	7'2"	390	1'3"	-35	-1.4"	15	0.6"
Install ROPS canopy (instead of cab)	-150	-331	-160	-353	-150	-331								
Additional counterweight	+200	+441	+380	+838	+330	+728								

Performance Data Dimensions

WHEEL LOADERS

WA200-6 (for USA)

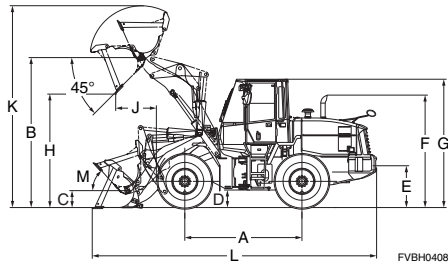

	Unit: mm (ft.in)	
Tread	17.5-25 tires	20.5-25 tires
Width over tires	1930 (6'4")	1930 (6'4")
A Wheelbase	2375 (7'10")	2470 (8'1")
B Hinge pin height, max. height	2840 (9'4")	2840 (9'4")
C Hinge pin height, carry position	3635 (11'11")	3705 (12'2")
D Ground clearance	410 (1'4")	380 (1'3")
E Hitch height	425 (1'5")	495 (1'8")
F Overall height, top of the stack	870 (2'10")	940 (3'1")
G Overall height, ROPS cab	2725 (8'11")	2795 (9'2")
M Tilt back angle	3110 (10'2")	3180 (10'5")
		48°

Measured with 20.5-25-12PR (L3) tires, ROPS/FOPS cab

Bucket type			Stockpile Bucket With Bolt-on Cutting Edge	Excavating Bucket With Bolt-on Cutting Edge	Light Material Bucket With Bolt-on Cutting Edge
Bucket capacity	Heaped	m ³ (yd ³)	2.0 (2.6)	1.7 (2.2)	2.4 (3.1)
	Struck	m ³ (yd ³)	1.7 (2.2)	1.4 (1.8)	2.0 (2.6)
Bucket width		mm (ft.in)	2550 (8'4")	2550 (8'4")	2550 (8'4")
Bucket weight		kg (lb)	785 (1,731)	740 (1,631)	875 (1,929)
Static tipping load	Straight	kg (lb)	9690 (21,363)	9750 (21,495)	9540 (21,032)
	Full turn (40°)	kg (lb)	8345 (18,397)	8405 (18,530)	8195 (18,067)
H. Dumping clearance, max. height and 45° dump angle**		mm (ft.in)	2830 (9'3")	2885 (9'6")	2725 (8'11")
Reach at 2130 mm (7') and 45° dump angle**		mm (ft.in)	1410 (4'8")	1385 (4'7")	1460 (4'9")
J. Reach at max. height and 45° dump angle**		mm (ft.in)	930 (3'1")	875 (2'10")	1035 (3'5")
Reach with arm horizontal and bucket level**		mm (ft.in)	2145 (7'0")	2065 (6'9")	2295 (7'6")
K. Operating height (fully raised)		mm (ft.in)	4955 (16'3")	4835 (15'10")	5065 (16'7")
L. Overall length, bucket on ground		mm (ft.in)	6895 (22'7")	6815 (22'4")	7050 (23'2")
Turning radius*		mm (ft.in)	5850 (19'2")	5830 (18'5")	5890 (19'4")
Digging depth	0°	mm (ft.in)	65 (2.6")	65 (2.6")	65 (2.6")
	10°	mm (ft.in)	250 (9.8")	235 (9.3")	275 (10.8")
Breakout force		kN	93.2	102.5	81.4
		kgf (lb)	9500 (20,944)	10450 (23,038)	8300 (18,298)
Operating weight		kg (lb)	10550 (23,259)	10505 (23,160)	10640 (23,457)

* Bucket at carry, outside corner of bucket.

** At the end of B.O.C.

- All dimensions, weights, and performance values based on SAE J732c and J742b standards.
- Static tipping load and operating weight shown include lubricant, coolant, full fuel tank, ROPS cab and operator.
- Machine stability and operating weight affected by counterweight, tire size, and other attachments.

Weight Changes

	Change in Operating Weight		Change in Tipping Load				Change in Vertical Dimensions		Change in Reach	
	kg	lb	Straight		Full Turn		mm	ft.in	mm	ft.in
			kg	lb	kg	lb				
17.5-25-12PR (L2)	-585	-1,290	-445	-981	-390	-860	-70	-2.8"	70	2.8"
17.5-25-12PR (L3)	-480	-1,058	-365	-805	-320	-705	-70	-2.8"	70	2.8"
20.5-25-12PR (L2)	-185	-331	-140	-309	-120	-265	0	0"	0	0"
Install ROPS canopy (instead of cab)	-150	-331	-150	-331	-130	-287				

Performance Data Dimensions

WHEEL LOADERS

WA200PZ-6 (for USA)

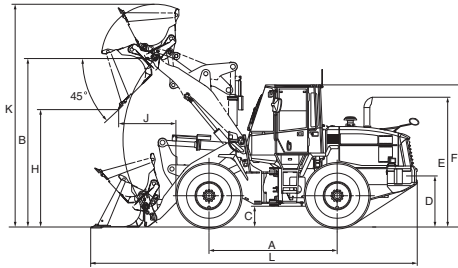

	Unit: mm (ft.in)
	20.5-25 tires
Tread	1930 (6'4")
Width over tires	2375 (7'10")
A Wheelbase	2840 (9'4")
B Hinge pin height, max. height	3815 (12'6")
C Ground clearance	425 (1'5")
D Hitch height	870 (2'10")
E Overall height, top of the stack	2725 (8'11")
F Overall height, ROPS cab	3110 (10'2")

Bucket

Measured with 20.5-25-12PR (L2) tires

Bucket type			Stockpile Bucket With Bolt-on Cutting Edge	
Bucket capacity	Heaped	m ³ (yd ³)	1.9 (2.5)	2.1 (2.75)
	Struck	m ³ (yd ³)	1.6 (2.1)	1.8 (2.3)
Bucket width		mm (ft.in)	2550 (8'4")	2550 (8'4")
Bucket weight		kg (lb)	937 (2,066)	1005 (2,215)
Static tipping load	Straight	kg (lb)	8145 (17,955)	8020 (17,680)
	Full turn (40°)	kg (lb)	7085 (15,620)	6975 (15,375)
H. Dumping clearance, max. height and 45° dump angle*		mm (ft.in)	2815 (9'3")	2760 (9'0")
Reach at 2130 mm (7') and 45° dump angle*		mm (ft.in)	1630 (5'4")	1650 (5'5")
J. Reach at max. height and 45° dump angle*		mm (ft.in)	1075 (3'6")	1130 (3'8")
Reach with arm horizontal and bucket level*		mm (ft.in)	2515 (8'3")	2590 (8'6")
K. Operating height (fully raised)		mm (ft.in)	5145 (16'10")	5230 (17'2")
L. Overall length, bucket on ground		mm (ft.in)	7405 (24'4")	7480 (24'6")
Digging depth	0°	mm (ft.in)	126 (5.0")	110 (4.3")
	10°	mm (ft.in)	347 (13.7")	338 (13.3")
Breakout force		kN kgf (lb)	89.8 9167 (20,210)	84.4 8614 (18,990)
Operating weight		kg (lb)	11465 (25,275)	11530 (25,420)

* At the end of B.O.C.

- All dimensions, weights, and performance values based on SAE J732c and J742b standards.
- Static tipping load and operating weight shown include lubricant, coolant, full fuel tank, ROPS cab and operator.
- Machine stability and operating weight affected by counterweight, tire size, and other attachments.

Weight Changes

	Change in Operating Weight		Change in Tipping Load				Change in Vertical Dimensions		Change in Reach	
			Straight		Full Turn					
	kg	lb	kg	lb	kg	lb	mm	ft.in	mm	ft.in
17.5-25-16PR (L2)	-325	-716	-215	-474	-185	-408	-70	-2.8"	+75	+3.0"
17.5-25-16PR (L3)	-290	-639	-190	-419	-167	-368	-70	-2.8"	+75	+3.0"
20.5-25-12PR (L3)	+165	+364	+105	+231	+95	+209	0	0"	0	0"
Install ROPS canopy (instead of cab)	-167	-368	-152	-335	-134	-295				

Performance Data Dimensions

WHEEL LOADERS

WA200PZ-6 (for USA)

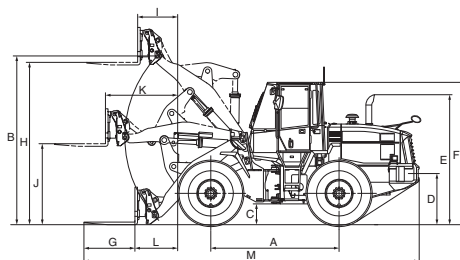

	Tread	20.5-25 tires
	Width over tires	1930 (6'4")
	A Wheelbase	2375 (7'10")
	B Hinge pin height, max. height	2840 (9'4")
	C Ground clearance	3815 (12'6")
	D Hitch height	425 (1'5")
	E Overall height, top of the stack	870 (2'10")
	F Overall height, ROPS cab	2725 (8'11")
		3110 (10'2")

Unit: mm (ft.in)

Fork

Measured with 20.5-25-12PR (L2) tires, ROPS/FOPS cab

G	Fork tine length	mm (in)	1220 (48")
	Fork weight	kg (lb)	683 (1506)
H	Ground to top of tine at maximum lift	mm (ft.in)	3740 (12'3")
I	Reach at maximum height	mm (ft.in)	2030 (6'8")
J	Ground to top of tine - boom and tine level	mm (ft.in)	1750 (5'9")
K	Reach - boom and tine level	mm (ft.in)	2935 (9'7")
L	Reach - tine level on ground	mm (ft.in)	2330 (7'8")
M	Overall length - tine level on ground	mm (ft.in)	7810 (25'7")
	Operating height, fully raised	mm (ft.in)	4980 (16'4")
	Operating load	kg (lb)	2542 (5,605)
	Static tipping load - boom and fork level, 610 mm (24") load center		
	Straight	kg (lb)	5845 (12,885)
	Full turn (40°)		
	Operating weight	kg (lb)	11470 (25,285)

Operating load per SAE J1197 (Feb. 1991), 50% of static tipping load.

Static tipping load and operating weight shown include lubricant, coolant, full fuel tank, ROPS cab and operator. Machine stability and operating weight affected by tire size and attachments.

Weight Changes

	Change in Operating Weight		Change in Tipping Load				Change in Vertical Dimensions		Change in Reach	
			Straight		Full Turn					
	kg	lb	kg	lb	kg	lb	mm	ft.in	mm	ft.in
17.5-25-16PR (L2)	-325	-716	-215	-474	-185	-408	-70	-2.8"	+75	+3.0"
17.5-25-16PR (L3)	-290	-639	-190	-419	-167	-368	-70	-2.8"	+75	+3.0"
20.5-25-12PR (L3)	+165	+364	+105	+231	+95	+209	0	0"	0	0"
Install ROPS canopy (instead of cab)	-167	-368	-152	-335	-134	-295				

Performance Data Dimensions

WHEEL LOADERS

WA250-6 (for USA)

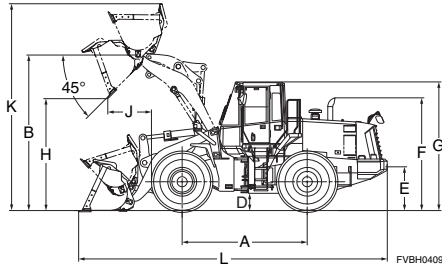

	17.5-25 tires	20.5-25 tires
Tread	1930 (6'4")	1930 (6'4")
Width over tires	2375 (7'10")	2470 (8'1")
A Wheelbase	2900 (9'6")	2900 (9'6")
B Hinge pin height, max. height	3725 (12'3")	3795 (12'5")
C Hinge pin height, carry position	375 (1'3")	450 (1'6")
D Ground clearance	395 (1'4")	465 (1'6")
E Hitch height	880 (2'11")	950 (3'1")
F Overall height, top of the stack	2855 (9'4")	2925 (9'7")
G Overall height, ROPS cab	3130 (10'3")	3200 (10'6")
M Tilt back angle	50°	

Measured with 20.5-25-12PR (L2) tires, ROPS/FOPS cab

Bucket type			Stockpile Bucket with Bolt-on Cutting Edge	Excavating Bucket with Bolt-on Cutting Edge	Light Material Bucket with Bolt-on Cutting Edge
Bucket capacity	Heaped	m ³ (yd ³)	2.3 (3.0)	1.9 (2.5)	2.7 (3.5)
	Struck	m ³ (yd ³)	2.0 (2.6)	1.6 (2.1)	2.3 (3.0)
Bucket width		mm (ft.in)	2685 (8'10")	2685 (8'10")	2685 (8'10")
Bucket weight		kg (lb)	960 (2,116)	905 (1,995)	1050 (2,315)
Static tipping load	Straight	kg (lb)	11960 (26,367)	12080 (26,632)	11805 (26,026)
	Full turn (40°)	kg (lb)	10525 (23,204)	10630 (23,435)	10385 (22,895)
H. Dumping clearance, max. height and 45° dump angle**		mm (ft.in)	2850 (9'4")	2925 (9'7")	2755 (9'0")
Reach at 2130 mm (7') and 45° dump angle**		mm (ft.in)	1495 (4'11")	1455 (4'9")	1540 (5'1")
J. Reach at max. height and 45° dump angle**		mm (ft.in)	985 (3'3")	910 (3'0")	1080 (3'7")
Reach with arm horizontal and bucket level**		mm (ft.in)	2235 (7'4")	2130 (7'0")	2360 (7'9")
K. Operating height (fully raised)		mm (ft.in)	5065 (16'7")	4945 (16'3")	5200 (17'1")
L. Overall length, bucket on ground		mm (ft.in)	7055 (23'2")	6015 (19'9")	7185 (23'7")
Turning radius*		mm (ft.in)	6030 (19'9")	5780 (19'0")	6110 (20'1")
Digging depth	0°	mm (ft.in)	75 (3.0")	75 (3.0")	75 (3.0")
	10°	mm (ft.in)	265 (10.4")	245 (9.7")	285 (11.2")
Breakout force		kN	121	136	108
		kgf (lb)	12340 (27,210)	13850 (30,535)	11000 (24,250)
Operating weight		kg (lb)	11545 (25,448)	11540 (25,441)	11685 (25,761)

* Bucket at carry, outside corner of bucket.

** At the end of B.O.C.

- All dimensions, weights, and performance values based on SAE J732c and J742b standards.
- Static tipping load and operating weight shown include lubricant, coolant, full fuel tank, ROPS cab and operator.
- Machine stability and operating weight affected by counterweight, tire size, and other attachments.

Weight Changes

	Change in Operating Weight		Change in Tipping Load				Change in Vertical Dimensions		Change in Reach	
	kg	lb	Straight		Full Turn		mm	ft.in	mm	ft.in
			kg	lb	kg	lb				
17.5-25-16PR (L2)	-280	-617	-215	-474	-190	-419	-70	-2.8"	+70	+2.8"
17.5-25-16PR (L3)	-225	-496	-170	-375	-155	-342	-70	-2.8"	+70	+2.8"
20.5-25-12PR (L3)	+150	+331	+110	+243	+90	+198	0	0"	0	0"
Install ROPS canopy (instead of cab)	-150	-331	-150	-331	-130	-287				

Performance Data Dimensions

WHEEL LOADERS

WA250PZ-6 (for USA)

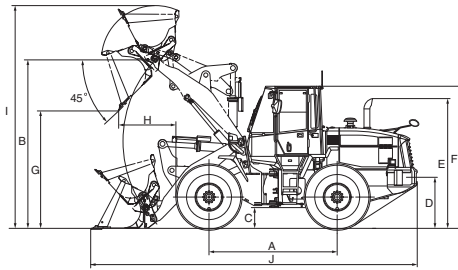

	Unit: mm (ft.in)	
Standard tire	17.5/25-12PR (L2)	20.5/25-12PR (L2)
Tread	1930 (6'4")	1930 (6'4")
Width over tires	2375 (7'10")	2464 (8'1")
A Wheelbase	2900 (9'6")	2900 (9'6")
B Hinge pin height, max. height	3895 (12'9")	3861 (12'8")
C Ground clearance	395 (1'4")	465 (1'6")
D Hitch height	880 (2'11")	965 (3'2")
E Overall height, top of the stack	2855 (9'4")	3124 (10'3")
F Overall height, ROPS cab	3130 (10'3")	3251 (10'8")

Bucket

Measured with 20.5-25-12PR (L2) tires

Bucket type			Stockpile Bucket with Bolt-on Cutting Edge	
Bucket capacity	Heaped	m ³ (yd ³)	1.9 (2.5)	2.3 (3.0)
	Struck	m ³ (yd ³)	1.6 (2.1)	2.0 (2.6)
Bucket width		mm (ft.in)	2685 (8'10")	2692 (8'10")
Bucket weight		kg (lb)	1015 (2,236)	1092 (2,408)
Static tipping load	Straight	kg (lb)	9420 (20,767)	8925 (19,676)
	Full turn (40°)	kg (lb)	8195 (18,067)	7765 (17,119)
H. Dumping clearance, max. height and 45° dump angle*		mm (ft.in)	2935 (9'8")	2861 (9'5")
Reach at 2130 mm (7') and 45° dump angle*		mm (ft.in)	1637 (5'4")	1672 (5'6")
J. Reach at max. height and 45° dump angle*		mm (ft.in)	1015 (3'4")	1088 (3'7")
Reach with arm horizontal and bucket level*		mm (ft.in)	2448 (8'0")	2552 (8'4")
K. Operating height (fully raised)		mm (ft.in)	5255 (17'3")	5358 (17'7")
L. Overall length, bucket on ground		mm (ft.in)	7233 (23'9")	7337 (24'1")
Digging depth	0°	mm (ft.in)	110 (4.3")	110 (4.3")
	10°	mm (ft.in)	320 (12.6")	338 (13'3")
Breakout force		kN	118	108
		kgf (lb)	12015 (26,490)	11000 (24,250)
Operating weight		kg (lb)	12520 (27,601)	12600 (27,778)

* At the end of B.O.C.

- All dimensions, weights, and performance values based on SAE J732c and J742b standards.
- Static tipping load and operating weight shown include lubricant, coolant, full fuel tank, ROPS cab and operator.
- Machine stability and operating weight affected by counterweight, tire size, and other attachments.

Weight Changes

	Change in Operating Weight		Change in Tipping Load				Change in Vertical Dimensions		Change in Reach	
			Straight		Full Turn					
	kg	lb	kg	lb	kg	lb	mm	ft.in	mm	ft.in
17.5-25-16PR (L2)	-300	-661	-200	-441	-170	-375	-70	-2.8"	+70	+2.8"
17.5-25-16PR (L3)	-260	-573	-170	-375	-150	-331	-70	-2.8"	+70	+2.8"
20.5-25-12PR (L3)	+165	+364	+110	+243	+95	+209	0	0"	0	0"
Install ROPS canopy (instead of cab)	-165	-364	-145	-320	-125	-276				

Performance Data Dimensions

WHEEL LOADERS

WA250PZ-6 (for USA)

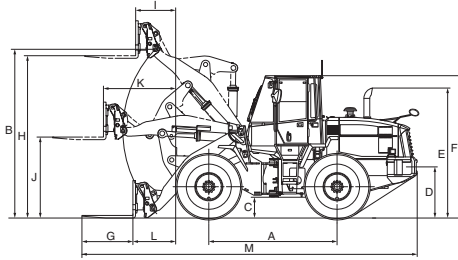

		Unit: mm (ft.in)	
		17.5/25-12PR (L2)	20.5/25-12PR (L2)
	Standard tire	1930 (6'4")	1930 (6'4")
	Tread	2375 (7'10")	2464 (8'1")
	Width over tires	2900 (9'6")	2900 (9'6")
A	Wheelbase	3895 (12'9")	3861 (12'8")
B	Hinge pin height, max. height	395 (1'4")	465 (1'6")
C	Ground clearance	880 (2'11")	965 (3'2")
D	Hitch height	2855 (9'4")	3124 (10'3")
E	Overall height, top of the stack	3130 (10'3")	3251 (10'8")
F	Overall height, ROPS cab		

Fork

Measured with 20.5-25-12PR (L2) tires, ROPS/FOPS cab

G	Fork tine length	mm (in)	1524 (60")
	Fork weight	kg (lb)	683 (1,506)
H	Ground to top of tine at maximum lift	mm (ft.in)	3820 (12'6")
I	Reach at maximum height	mm (ft.in)	2324 (7'7")
J	Ground to top of tine - boom and tine level	mm (ft.in)	1817 (6'0")
K	Reach - boom and tine level	mm (ft.in)	3233 (10'7")
L	Reach - tine level on ground	mm (ft.in)	2573 (8'5")
M	Overall length - tine level on ground	mm (ft.in)	8034 (26'4")
	Static tipping load - boom and fork level, 610 mm (24") load center		
	Straight	kg (lb)	6630 (14,616)
	Full turn (40°)		5770 (12,721)
	Operating height, fully raised	mm (ft.in)	5255 (17'3")
	Operating load	kg (lb)	2885 (6,360)
	Operating weight	kg (lb)	12160 (26,808)

Operating load per SAE J1197 (Feb. 1991), 50% of static tipping load.

Static tipping load and operating weight shown include lubricant, coolant, full fuel tank, ROPS cab and operator. Machine stability and operating weight affected by tire size and attachments.

Weight Changes

	Change in Operating Weight		Change in Tipping Load				Change in Vertical Dimensions		Change in Reach	
			Straight		Full Turn					
	kg	lb	kg	lb	kg	lb	mm	ft.in	mm	ft.in
17.5-25-16PR (L2)	-300	-661	-140	-309	-170	-375	-70	-2.8"	+70	+2.8"
17.5-25-16PR (L3)	-260	-573	-125	-276	-150	-331	-70	-2.8"	+70	+2.8"
20.5-25-12PR (L3)	+165	+364	+80	+176	+95	+209	0	0"	0	0"
Install ROPS canopy (instead of cab)	-165	-364	-105	-231	-125	-276				

Performance Data Dimensions

WHEEL LOADERS

WA320-6 (USA source)

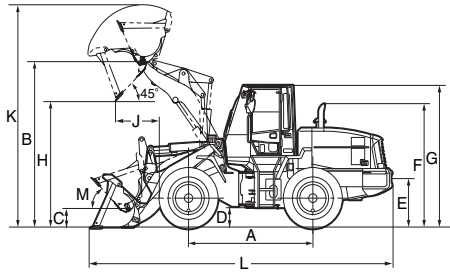

Unit: mm (ft.in)

Tread	2050 (6'9")
Width over tires	2585 (8'6")
A Wheelbase	3030 (9'11")
B Hinge pin height, max. height	3905 (12'10")/4545 (14'10")***
C Hinge pin height, carry position	480 (1'7")/645 (2'1")***
D Ground clearance	425 (1'5")
E Hitch height	1095 (3'7")
F Overall height, top of the stack	2975 (9'9")
G Overall height, ROPS cab	3200 (10'6")
M Tilt back angle	47°

Measured with 20.5-25-12PR (L2) tires

Bucket type			Stockpile Bucket With Bolt-on Cutting Edge	Excavating Bucket With Bolt-on Cutting Edge	Light Material Bucket With Bolt-on Cutting Edge	Boom High Lift Stockpile Bucket
Bucket capacity	Heaped	m ³ (yd ³)	2.8 (3.7)	2.3 (3.0)	3.2 (4.2)	2.3 (3.0)
	Struck	m ³ (yd ³)	2.4 (3.1)	2.0 (2.6)	2.8 (3.7)	2.0 (2.6)
Bucket width		mm (ft.in)	2740 (9'0")	2740 (9'0")	2685 (8'10")	2740 (9'0")
Bucket weight		kg (lb)	1230 (2,712)	1195 (2,634)	1410 (3,110)	1195 (2,634)
Static tipping load	Straight	kg (lb)	12535 (27,635)	12750 (28,110)	12610 (27,800)	9520 (20,090)
	Full turn (40°)	kg (lb)	11140 (24,560)	11360 (25,045)	11215 (24,725)	8460 (18,650)
H. Dumping clearance, max. height and 45° dump angle**		mm (ft.in)	2850 (9'4")	2955 (9'8")	2715 (8'11")	3595 (11'10")
Reach at 2130 mm (7') and 45° dump angle		mm (ft.in)	1580 (5'2")	1530 (5'0")	1640 (5'5")	2080 (6'10")
J. Reach at max. height and 45° dump angle**		mm (ft.in)	1035 (3'5")	930 (3'1")	1170 (3'10")	950 (3'1")
Reach with arm horizontal and bucket level		mm (ft.in)	2420 (7'11")	2275 (7'6")	2610 (8'7")	2785 (9'2")
K. Operating height (fully raised)		mm (ft.in)	5325 (17'6")	5135 (16'10")	5405 (17'9")	5775 (18'11")
L. Overall length, bucket on ground		mm (ft.in)	7415 (24'8")	7370 (24'2")	7705 (25'3")	8005 (26'3")
Turning radius*		mm (ft.in)	6260 (20'6")	6220 (20'5")	6290 (20'8")	6330 (20'9")
Digging depth	0°	mm (ft.in)	85 (3.3")	85 (3.3")	85 (3.3")	131 (5.2")
	10°	mm (ft.in)	296 (11.6")	275 (11")	320 (1'1")	316 (1'1")
Breakout force		kN	129	148	111	133
		kgf (lb)	13180 (29,060)	15140 (33,380)	11280 (24,870)	13000 (29,980)
Operating weight		kg (lb)	14370 (31,680)	14330 (31,590)	14545 (32,070)	14550 (32,080)

* Bucket at carry, outside corner of bucket.

** At the end of tooth or B.O.C.

*** High lift boom

- All dimensions, weights, and performance values based on SAE J732c and J742b standards.
- Static tipping load and operating weight shown include lubricant, coolant, full fuel tank, ROPS cab, additional counterweight and operator.
- Machine stability and operating weight affected by counterweight, tire size, and other attachments.

Weight Changes

	Change in Operating Weight		Change in Tipping Load				Width Over Tire		Ground Clearance		Change in Vertical Dimensions	
			Straight		Full Turn							
	kg	lb	kg	lb	kg	lb	mm	ft.in	mm	ft.in	mm	ft.in
20.5-25-12PR (L2)	-210	-463	-165	-364	-165	-364	2585	8'6"	425	1'5"	0	0
Install ROPS canopy (instead of cab)	-150	-331	-150	-331	-140	-309						

Performance Data Dimensions

WHEEL LOADERS

WA320PZ-6 (for USA)

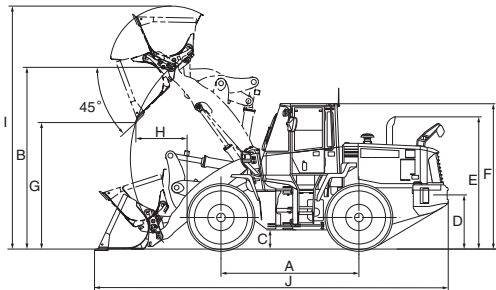

Unit: mm (ft.in)

Tread	2050 (6'9")
Width over tires	2590 (8'6")
A Wheelbase	3030 (9'11")
B Hinge pin height, max. height	4005 (13'2")
C Hinge pin height, carry position	440 (1'5")
D Ground clearance	425 (1'5")
E Hitch height	1095 (3'7")
F Overall height, top of the stack	2915 (9'7")
G Overall height, ROPS cab	3200 (10'6")

Bucket

Measured with 20.5-25-12PR (L2) tires

Bucket type			Light Material Bucket W/B.O.C	General Purpose Bucket W/B.O.C
Bucket capacity	Heaped	m ³ (yd ³)	2.7 (3.5)	2.5 (3.25)
	Struck	m ³ (yd ³)	2.2 (2.9)	2.1 (2.75)
Bucket width		mm (ft.in)	2740 (9'0")	2740 (9'0")
Bucket weight		kg (lb)	1260 (2,780)	1230 (2,712)
Static tipping load	Straight	kg (lb)	10880 (23,990)	10990 (24,228)
	Full turn (40°)	kg (lb)	9580 (21,110)	9670 (21,320)
H. Dumping clearance, max. height and 45° dump angle*		mm (ft.in)	2785 (9'2")	2820 (9'3")
Reach at 2130 mm (7') and 45° dump angle*		mm (ft.in)	1770 (5'10")	1755 (5'9")
J. Reach at max. height and 45° dump angle*		mm (ft.in)	1240 (4'1")	1200 (3'11")
Reach with boom and bucket level*		mm (ft.in)	2735 (9'0")	2680 (8'10")
K. Operating height (fully raised)		mm (ft.in)	5395 (17'8")	5355 (17'7")
L. Overall length, bucket on ground		mm (ft.in)	7800 (25'7")	7750 (25'5")
Digging depth	0°	mm (ft.in)	65 (2.5")	65 (2.5")
	10°	mm (ft.in)	440 (1'5")	385 (1'3")
Breakout force		kN/kgf (lb)	136/13900 (30,620)	142/14430 (31,810)
Operating weight		kg (lb)	15380 (33,900)	15350 (33,830)

* At the end of B.O.C.

- All dimensions, weights, and performance values based on SAE J732c and J742b standards.
- Static tipping load and operating weight shown include lubricant, coolant, full fuel tank, ROPS cab and operator.
- Machine stability and operating weight affected by counterweight, tire size, and other attachments.

Fork

Static tipping load - boom level Fork level, 610 mm (24") load center	Straight	kg (lb)	7815 (17,230)
	Full turn (40°)	kg (lb)	6720 (14,810)
Operating weight		kg (lb)	14730 (32,480)
G Fork tine length		mm (ft.in)	1524 (5'0")
H Ground to top of tine at maximum lift		mm (ft.in)	3860 (12'8")
I Reach at maximum lift		mm (ft.in)	840 (2'9")
J Ground to top of Tine - boom and tine level		mm (ft.in)	1855 (6'1")
K Reach - boom and tine level		mm (ft.in)	1735 (5'8")
L Reach - tine level on ground		mm (ft.in)	1065 (3'6")
M Overall Length - tine level on ground		mm (ft.in)	8320 (27'3")
Operating load		kg (lb)	4805 (10,590)

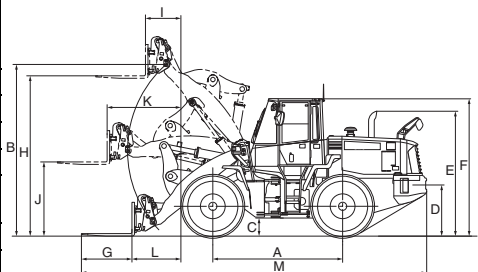

Operating load per SAE J1197 (Feb. 1991), 50% of static tipping load.

Static tipping load and operating weight shown include lubricant, coolant, full fuel tank, ROPS cab and operator. Machine stability and operating weight affected by tire size and attachments.

Weight Changes

	Change in Operating Weight		Change in Tipping Load				Width Over Tire		Ground Clearance		Change in Vertical Dimensions		Change in Reach	
	kg	lb	Straight		Full Turn		mm	ft.in	mm	ft.in	mm	ft.in	mm	ft.in
			kg	lb	kg	lb								
20.5-25-12PR (L3)	+165	+364	+105	+231	+95	+209	2590	8'6"	425	1'5"	0	0"	0	0"

Performance Data Dimensions

WHEEL LOADERS

WA380-7 (USA source)

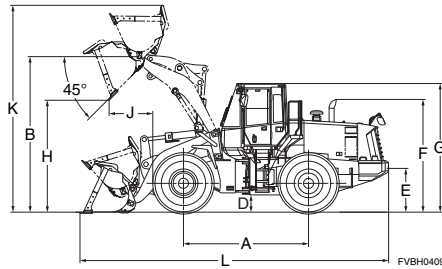

	Unit: mm (ft.in)
Tread	2160 (7'1")
Width over tires	2780 (9'1")
A Wheelbase	3330 (10'10")
B Hinge pin height, max. height	
Standard boom	4095 (13'5")
High lift boom	4625 (15'2")
C Hinge pin height, carry position	
Standard boom	520 (1'8")
High lift boom	680 (2'3")
D Ground clearance	455 (1'6")
E Hitch height	1150 (3'9")
F Overall height, top of the stack	3145 (10'3")
G Overall height, ROPS cab	3390 (11'2")
M Tilt back angle	50°

Measured with 23.5 R25 (L3) tires, ROPS/FOPS cab

Bucket type			General Purpose Buckets	Excavating Bucket	Light Material Bucket	High Lift Boom Excavating Bucket
			Bolt-on Cutting Edge	Bolt-on Cutting Edge	Bolt-on Cutting Edge	Bolt-on Cutting Edge
Bucket capacity	Heaped	m ³ (yd ³)	3.3 (4.3)	2.9 (3.8)	4.0 (5.2)	2.9 (3.8)
	Struck	m ³ (yd ³)	2.9 (3.8)	2.4 (3.1)	3.4 (4.4)	2.4 (3.1)
Bucket width		mm (ft.in)	2905 (9'6")	2905 (9'6")	2905 (9'6")	2905 (9'6")
Bucket weight		kg (lb)	1605 (3,570)	1715 (3,790)	1835 (4,045)	1715 (3,790)
Static tipping load	Straight	kg (lb)	15565 (34,140)	15450 (33,885)	15330 (33,620)	14660 (32,320)
	Full turn (40°)	kg (lb)	13295 (29,145)	13180 (28,900)	13055 (28,625)	10500 (23,150)
H. Dumping clearance, max. height and 45° dump angle**		mm (ft.in)	2950 (9'8")	3045 (10'0")	2855 (9'4")	3575 (11'9")
Reach at 2130 mm (7') cutting edge clearance and 45° dump angle		mm (ft.in)	1735 (5'8")	1630 (5'6")	1780 (5'10")	2205 (7'3")
J. Reach at max. height and 45° dump angle		mm (ft.in)	1150 (3'9")	1055 (3'6")	1240 (4'1")	1185 (3'11")
Reach with arm horizontal and bucket level**		mm (ft.in)	2590 (8'6")	2450 (8'0")	2715 (8'11")	2940 (9'8")
K. Operating height (fully raised)		mm (ft.in)	5600 (18'5")	5450 (17'11")	5720 (18'9")	5985 (19'7")
L. Overall length		mm (ft.in)	8280 (26'8")	8140 (26'3")	8255 (27'1")	8780 (28'10")
Turning radius*						
Digging depth	0°	mm (ft.in)	60 (2.4")	60 (2.4")	60 (2.4")	110 (4.3")
	10°	mm (ft.in)	290 (11.4")	265 (10.4")	315 (12.4")	320 (12.6")
Breakout force		kN	158	175	144	183
		kgf (lb)	16100 (35,495)	17850 (39,680)	14700 (32,405)	18700 (41,220)
Operating weight		kg (lb)	18155 (39,840)	18265 (40,170)	18385 (40,950)	18650 (41,115)

* Bucket at carry, outside corner of bucket.

** At the end of B.O.C. or teeth

- All dimensions, weights, and performance values based on SAE J732c and J742b standards.
- Static tipping load and operating weight shown include lubricant, coolant, full fuel tank, ROPS cab and operator.
- Machine stability and operating weight affected by counterweight, tire size, and other attachments.

Weight Changes

	Change in Operating Weight		Change in Tipping Load			
			Straight		Full Turn	
	kg	lb	kg	lb	kg	lb
Remove additional counterweight	-245	-540	-855	-1,885	-715	-1,575

Performance Data Dimensions

WHEEL LOADERS

WA430-6 (USA source)

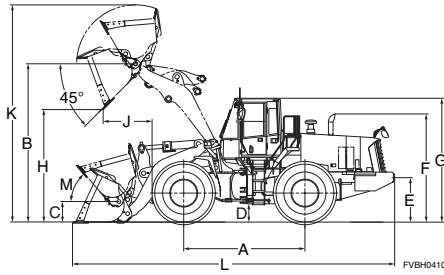

	Unit: mm (ft.in)
Tread	2200 (7'3")
Width over tires	2820 (9'3")
A Wheelbase	3300 (10'10")
B Hinge pin height, max. height	4165 (13'8")
C Hinge pin height, carry position	520 (1'8")
D Ground clearance	455 (1'6")
E Hitch height	1150 (3'9")
F Overall height, top of the stack	2940 (9'8")
G Overall height, ROPS cab	3390 (11'1")
M Tilt back angle	46°

Measured with 23.5 R25 (L3) tires, ROPS/FOPS cab

Bucket type			General Purpose Bolt-on Cutting Edge	Excavating Bolt-on Cutting Edge	Light Material Bolt-on Cutting Edge
Bucket capacity	Heaped	m ³ (yd ³)	3.5 (4.6)	3.1 (4.1)	4.3 (5.6)
	Struck	m ³ (yd ³)	3.0 (3.9)	2.6 (3.4)	3.7 (4.8)
Bucket width		mm (ft.in)	2905 (9'6")	2905 (9'6")	2905 (9'6")
Bucket weight		kg (lb)	1630 (3,593)	1720 (3,792)	1800 (3,968)
Static tipping load	Straight	kg (lb)	14960 (32,981)	14915 (32,882)	14710 (32,430)
	Full turn (40°)	kg (lb)	13785 (30,390)	13770 (30,358)	13615 (30,016)
H. Dumping clearance, max. height and 45° dump angle**		mm (ft.in)	3015 (9'11")	3090 (10'2")	2890 (9'6")
Reach at 2130 mm (7') and 45° dump angle		mm (ft.in)	1840 (6'0")	1795 (5'11")	1900 (6'3")
J. Reach at max. height and 45° dump angle**		mm (ft.in)	1195 (3'11")	1120 (3'8")	1320 (4'4")
Reach with arm horizontal and bucket level		mm (ft.in)	2690 (8'10")	2580 (8'6")	2865 (9'5")
K. Operating height (fully raised)		mm (ft.in)	5710 (18'9")	5590 (18'4")	5895 (19'4")
L. Overall length, bucket on ground		mm (ft.in)	8460 (27'9")	8350 (27'5")	8640 (28'4")
Turning radius*		mm (ft.in)	7270 (23'10")	7230 (23'9")	7310 (24'0")
Digging depth	0°	mm (ft.in)	120 (4.7")	120 (4.7")	120 (4.7")
	10°	mm (ft.in)	350 (1'2")	330 (1'1")	380 (1'3")
Breakout force		kN kgf (lb)	179 18300 (40,333)	196 19980 (44,048)	158 16135 (35,572)
Operating weight		kg (lb)	18530 (40,852)	18620 (41,050)	18700 (41,226)

* Bucket at carry, outside corner of bucket.

** At the end of tooth or B.O.C.

- All dimensions, weights, and performance values based on SAE J732c and J742b standards.
- Static tipping load and operating weight shown include lubricant, coolant, full fuel tank, ROPS cab, additional counterweight and operator.
- Machine stability and operating weight affected by counterweight, tire size, and other attachments.

Weight Changes

	Operating Weight		Tipping Load Straight		Tipping Load Full Turn	
	kg	lb	kg	lb	kg	lb
Remove additional counterweight	-340	-750	-860	-1,900	-720	-1,590

Performance Data Dimensions

WHEEL LOADERS

WA470-7 (USA source)

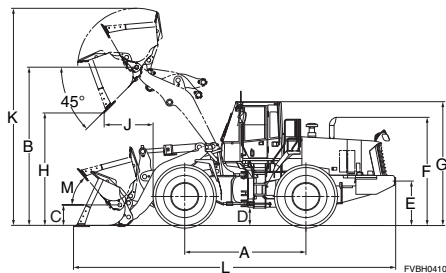

	Unit: mm (ft.in)
Tread	2300 (7'7")
Width over tires	3010 (9'11")
A Wheelbase	3450 (11'4")
B Hinge pin height, max. height	4360 (14'4")
C Hinge pin height, carry position	585 (1'11")
D Ground clearance	525 (1'9")
E Hitch height	1210 (4'0")
F Overall height, top of the stack	3300 (10'10")
G Overall height, ROPS cab	3500 (11'6")
M Tilt back angle	50°

Measured with 26.5 R25 (L3) tires, ROPS/FOPS cab

Bucket type			General Purpose Bolt-on Cutting Edge	Excavating Bolt-on Cutting Edge	Light Material Bolt-on Cutting Edge
Bucket capacity	Heaped	m ³ (yd ³)	4.2 (5.5)	3.8 (5.0)	4.4 (5.8)
	Struck	m ³ (yd ³)	3.5 (4.6)	3.2 (4.2)	3.9 (5.1)
Bucket width		mm (ft.in)	3170 (10'5")	3170 (10'5")	3170 (10'5")
Bucket weight		kg (lb)	2020 (4,453)	2170 (4,784)	2210 (4,872)
Static tipping load	Straight	kg (lb)	19110 (42,130)	18970 (41,820)	18930 (41,730)
	Full turn (40°)	kg (lb)	16470 (36,310)	16330 (36,000)	16300 (35,935)
H. Dumping clearance, max. height and 45° dump angle**		mm (ft.in)	3185 (10'5")	3235 (10'7")	3055 (10'0")
Reach at 2130 mm (7') and 45° dump angle		mm (ft.in)	1935 (6'4")	1905 (6'3")	2010 (6'7")
J. Reach at max. height and 45° dump angle**		mm (ft.in)	1235 (4'1")	1185 (3'11")	1365 (4'6")
Reach with arm horizontal bucket level		mm (ft.in)	2755 (9'0")	2685 (8'10")	2940 (9'8")
K. Operating height (fully raised)		mm (ft.in)	5960 (19'7")	5910 (19'5")	5960 (19'7")
L. Overall length, bucket on ground		mm (ft.in)	8825 (28'11")	8755 (28'9")	9010 (29'7")
Turning radius*		mm (ft.in)	7650 (25'1")	7630 (25'0")	7695 (25'3")
Digging depth	0°	mm (ft.in)	80 (3.1")	80 (3.1")	80 (3.1")
	10°	mm (ft.in)	315 (12.4")	305 (12.0")	345 (13.6")
Breakout force		kN	192	203	168
		kgf (lb)	19600 (43,160)	20710 (45,640)	17140 (37,770)
Operating weight		kg (lb)	23590 (57,010)	23740 (52,340)	23780 (52,430)

* Bucket at carry, outside corner of bucket.

** At the end of B.O.C. or teeth

- All dimensions, weights, and performance values based on SAE J732c and J742b standards.
- Static tipping load and operating weight shown include lubricant, coolant, full fuel tank, ROPS cab and operator.
- Machine stability and operating weight affected by counterweight, tire size, and other attachments.

Weight Changes

	Change in Operating Weight		Change in Tipping Load			
			Straight		Full Turn	
	kg	lb	kg	lb	kg	lb
Remove additional counterweight	-400	-882	-1300	-2,866	-1100	-2,425

Performance Data Dimensions

WHEEL LOADERS

WA480-6 (USA source)

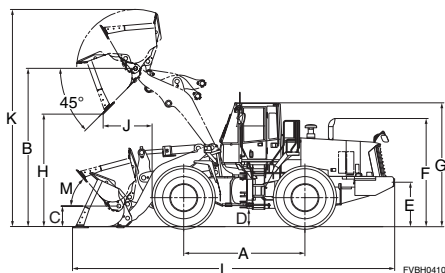

	Unit: mm (ft.in)
Tread	2300 (7'7")
Width over tires	3010 (9'11")
A Wheelbase	3450 (11'4")
B Hinge pin height, max. height	4505 (14'9")
C Hinge pin height, carry position	585 (1'11")
D Ground clearance	525 (1'9")
E Hitch height	1240 (4'1")
F Overall height, top of the stack	3080 (10'1")
G Overall height, ROPS cab	3500 (11'6")
M Tilt back angle	52°

Measured with 26.5 R25 (L3) tires

Bucket type			General Purpose Buckets		Loose Material Bucket	Light Material Bucket
			Stockpile	Excavating		
			Bolt-on Cutting Edge	Bolt-on Cutting Edge	Bolt-on Cutting Edge	Bolt-on Cutting Edge
Bucket capacity	Heaped	m ³ (yd ³)	4.6 (6.0)	4.1 (5.4)	4.9 (6.4)	6.1 (8.0)
	Struck	m ³ (yd ³)	4.0 (5.2)	3.5 (4.6)	4.2 (5.5)	5.2 (6.8)
Bucket width		mm (ft.in)	3170 (10'5")	3170 (10'5")	3170 (10'5")	3170 (10'5")
Bucket weight		kg (lb)	2260 (4,982)	2220 (4,894)	2340 (5,159)	2410 (5,313)
Static tipping load	Straight	kg (lb)	20925 (46,130)	20955 (46,200)	20855 (45,975)	20795 (45,845)
	Full turn (40°)	kg (lb)	17995 (39,670)	18020 (39,725)	17935 (39,540)	17885 (39,430)
H. Dumping clearance, max. height and 45° dump angle**		mm (ft.in)	3205 (10'6")	3295 (10'10")	3125 (10'3")	3080 (10'1")
Reach at 2130 mm (7') cutting edge clearance and 45° dump angle		mm (ft.in)	2135 (7'0")	2080 (6'10")	2180 (7'2")	2205 (7'3")
J. Reach at max. height and 45° dump angle		mm (ft.in)	1410 (4'8")	1320 (4'4")	1490 (4'11")	1535 (5'0")
Reach with arm horizontal and bucket level		mm (ft.in)	3020 (9'11")	2895 (9'6")	3135 (10'3")	3195 (10'6")
K. Operating height (fully raised)		mm (ft.in)	6175 (20'3")	6025 (19'9")	6175 (20'3")	6450 (21'2")
L. Overall length	Bucket on ground	mm (ft.in)	9345 (30'8")	9180 (30'1")	9425 (30'11")	9520 (31'3")
Turning radius*		mm (ft.in)	7700 (25'3")	7655 (25'1")	7720 (25'4")	7745 (25'5")
Digging depth	0°	mm (ft.in)	90 (3.5")	90 (3.5")	90 (3.5")	90 (3.5")
	10°	mm (ft.in)	355 (1'2")	335 (1'1")	375 (1'3")	385 (1'3")
Breakout force	kN		212	231	196	189
	kgf (lb)		21600 (47,660)	23600 (51,930)	20000 (44,060)	19300 (42,490)
Operating weight		kg (lb)	25405 (56,010)	25365 (55,920)	25485 (56,185)	25555 (56,340)

* Bucket at carry, outside corner of bucket.

** At the end of tooth or B.O.C.

- All dimensions, weights, and performance values based on SAE J732c and J742b standards.
- Static tipping load and operating weight shown include lubricant, coolant, full fuel tank, ROPS cab, additional counterweight and operator.
- Machine stability and operating weight affected by counterweight, tire size, and other attachments.

Weight Changes

	Operating Weight		Tipping Load Straight		Tipping Load Full Turn	
	kg	lb	kg	lb	kg	lb
Remove additional counterweight	-400	-880	-980	-2,160	-850	-1,873

Performance Data Dimensions

WHEEL LOADERS

WA500-7 (USA source)

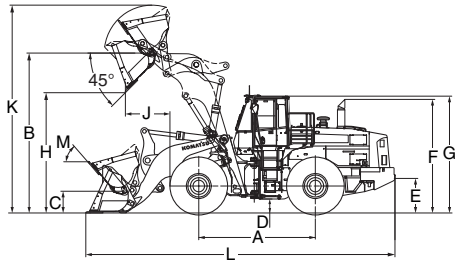

	Unit: mm (ft.in)
Tread	2400 (7'10")
Width over tires	3190 (10'6")
A Wheelbase	3780 (12'5")
B Hinge pin height, max. height	4755 (15'7")
C Hinge pin height, carry position	575 (1'11")
D Ground clearance	450 (1'6")
E Hitch height	1115 (3'8")
F Overall height, top of the stack	3665 (12'0")
G Overall height, ROPS cab	3785 (12'5")
M Tilt back angle	50°

Measured with 29.5-22PR (L3) tires, ROPS/FOPS cab

Bucket type			General Purpose Bucket	Excavating Bucket	Light Material Bucket
			Bolt-on Cutting Edge	Bolt-on Cutting Edge	Bolt-on Cutting Edge
Bucket capacity	Heaped	m ³ (yd ³)	5.6 (7.3)	5.2 (6.8)	6.3 (8.2)
	Struck	m ³ (yd ³)	4.8 (6.3)	4.2 (5.5)	5.3 (6.9)
Bucket width		mm (ft.in)	3400 (11'2")	3400 (11'2")	3400 (11'2")
Bucket weight		kg (lb)	3110 (6,855)	3055 (6,735)	3485 (7,683)
Static tipping load	Straight	kg (lb)	27140 (59,830)	27180 (59,920)	26850 (59,190)
	Full turn (40°)	kg (lb)	24580 (54,190)	24620 (54,280)	24290 (53,550)
H. Dumping clearance, max. height and 45° dump angle**		mm (ft.in)	3295 (10'10")	3395 (11'2")	3210 (10'6")
Reach at 2130 mm (7') and 45° dump angle		mm (ft.in)	2300 (7'7")	2215 (7'3")	2350 (7'8")
J. Reach at max. height and 45° dump angle**		mm (ft.in)	1500 (4'11")	1400 (4'7")	1585 (5'2")
Reach with arm horizontal bucket level		mm (ft.in)	3265 (10'9")	3120 (10'3")	3385 (11'11")
K. Operating height (fully raised)		mm (ft.in)	6430 (21'1")	6415 (21'1")	6540 (21'5")
L. Overall length, bucket on ground		mm (ft.in)	9915 (32'6")	9770 (32'1")	10035 (32'11")
Turning radius*		mm (ft.in)	8220 (27'0")	8180 (26'10")	8250 (27'1")
Digging depth	0°	mm (ft.in)	135 (5.3")	135 (5.3")	135 (5.3")
	10°	mm (ft.in)	435 (1'5")	410 (1'4")	455 (1'6")
Breakout force		kN	245	268	227
		kgf (lb)	25000 (55,115)	27000 (60,185)	23200 (51,150)
Operating weight		kg (lb)	34750 (76,610)	34705 (76,510)	35125 (77,440)

* Bucket at carry, outside corner of bucket.

** At the end of B.O.C. or teeth

- All dimensions, weights, and performance values based on SAE J732c and J742b standards.
- Static tipping load and operating weight shown include lubricant, coolant, full fuel tank, ROPS cab and operator.
- Machine stability and operating weight affected by counterweight, tire size, and other attachments.

Weight Changes

	Change in Operating Weight		Change in Tipping Load			
			Straight		Full Turn	
	kg	lb	kg	lb	kg	lb
Remove additional counterweight	-900	-1,984	-1990	-4,387	-1720	-3,792

Performance Data Dimensions

WHEEL LOADERS

WA65-6 (Germany source)

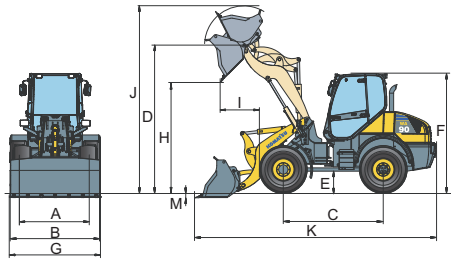

	Unit: mm (ft.in)
A Tread	1306 (4'3")
B Width over tires	1625 (5'4")
C Wheelbase	2050 (6'9")
D Hinge pin height, max. height	3115 (10'3")
E Ground clearance	280 (11")
F Overall height, ROPS cab	2450 (8'10")
Turning radius at corner of tire	3680 (12'1")

Measured with 12.0-18 tires

Bucket type			Universal		Light material	4-in-1
			With teeth	Without teeth	Without teeth	With teeth
Bucket capacity	Heaped	m ³ (yd ³)	0.70 (0.92)	0.70 (0.92)	1.0 (1.31)	0.55 (0.72)
	Struck	m ³ (yd ³)	—	—	—	—
G Bucket width		mm (ft.in)	1660 (5'5")	1660 (5'5")	1870 (6'2")	1700 (5'7")
Bucket weight without teeth		kg (lb)	258 (569)	240 (530)	300 (660)	490 (1,080)
Static tipping load	Straight	kg (lb)	3650 (8,050)	3770 (8,310)	3630 (8,000)	3500 (7,720)
	Full turn (40°)	kg (lb)	3200 (7,055)	3280 (7,230)	3150 (8,940)	3000 (6,610)
H. Dumping clearance, max. height and 45° dump angle**		mm (ft.in)	2430 (8'0")	2450 (8'0")	2310 (7'7")	2395 (7'10")
Reach at 2130 mm (7') cutting edge clearance and 45° dump angle		mm (ft.in)	—	—	—	—
I. Reach at max. height and 45° dump angle	Reach at max. height and 45° dump angle	mm (ft.in)	965 (3'2")	945 (3'1")	986 (3'3")	945 (3'1")
	Reach with arm horizontal and bucket level	mm (ft.in)	—	—	—	—
J. Operating height (fully raised)		mm (ft.in)	4060 (13'4")	4060 (13'4")	4000 (13'1")	3910 (12'10")
K. Overall length	Bucket on ground	mm (ft.in)	5425 (17'10")	5320 (17'5")	5380 (17'8")	5410 (17'9")
	Turning radius	Bucket edge	mm (ft.in)	4095 (13'5")	4095 (13'5")	4250 (13'11")
M Digging depth	0°	mm (ft.in)	95 (3.7")	95 (3.7")	165 (6.5")	135 (5.3")
	10°	mm (ft.in)	—	—	—	—
Breakout force		kN kgf (lb)	37.1 3780 (8,340)	37.1 3780 (8,340)	30.9 3150 (6,950)	34.8 3550 (7,830)
Operating weight		kg (lb)	4660 (10,270)	4640 (8,025)	4700 (10,360)	4890 (10,780)

Performance Data Dimensions

WHEEL LOADERS

WA70-6 (Germany source)

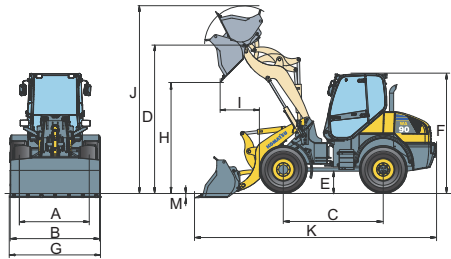

	Unit: mm (ft.in)
A Tread	1306 (4'3")
B Width over tires	1625 (5'4")
C Wheelbase	2050 (6'9")
D Hinge pin height, max. height	3150 (10'4")
E Ground clearance	305 (12")
F Overall height, ROPS cab	2465 (8'1")
Turning radius at corner of tire	3680 (12'1")

Measured with 12.0-18 tires

Bucket type			Universal		Light materials		4-in-1
			With teeth	Without teeth	Without teeth	Without teeth	With teeth
Bucket capacity	Heaped	m ³ (yd ³)	0.85 (1.11)	0.85 (1.11)	1.00 (1.31)	1.25 (1.64)	0.75 (0.98)
	Struck	m ³ (yd ³)	–	–	–	–	–
G Bucket width		mm (ft.in)	1800 (5'11")	1800 (5'11")	1870 (6'2")	1870 (6'2")	1800 (5'11")
Bucket weight without teeth		kg (lb)	295 (650)	273 (602)	301 (664)	337 (743)	592 (1,305)
Static tipping load	Straight	kg (lb)	4200 (9,260)	4300 (9,480)	4170 (9,130)	4080 (8,995)	3900 (8,600)
	Full turn (40°)	kg (lb)	3650 (8,050)	3750 (8,270)	3620 (7,980)	3540 (7,800)	3350 (7,385)
H. Dumping clearance, max. height and 45° dump angle**		mm (ft.in)	2415 (7'11")	2435 (8'0")	2335 (7'8")	2260 (7'5")	2355 (7'9")
Reach at 2130 mm (7') cutting edge clearance and 45° dump angle		mm (ft.in)	–	–	–	–	–
I. Reach at max. height and 45° dump angle		mm (ft.in)	935 (3'1")	915 (3'0")	960 (3'2")	1030 (3'5")	980 (3'3")
Reach with arm horizontal and bucket level		mm (ft.in)	–	–	–	–	–
J. Operating height (fully raised)		mm (ft.in)	4070 (13'4")	4070 (13'4")	4025 (13'2")	4190 (13'9")	3950 (13'0")
K. Overall length	Bucket on ground	mm (ft.in)	5445(17'10")	5310 (17'5")	5375 (17'8")	5475 (18'0")	5470 (17'11")
	Turning radius	mm (ft.in)	4175 (13'8")	4175 (13'8")	4245 (13'11")	4280 (14'1")	4250 (13'11")
M. Digging depth	0°	mm (ft.in)	100 (3.9")	100 (3.9")	140 (5.5")	140 (5.5")	110 (4.3")
	10°	mm (ft.in)	–	–	–	–	–
Breakout force		kN kgf (lb)	41 4180 (9,220)	41 4180 (9,220)	35 3570 (7,870)	31 3160 (6,970)	36 3670 (8,095)
Operating weight		kg (lb)	5060 (11,160)	5035 (11,100)	5065 (11,170)	5100 (11,240)	5355 (11,810)

Performance Data Dimensions

WHEEL LOADERS

WA80-6 (Germany source)

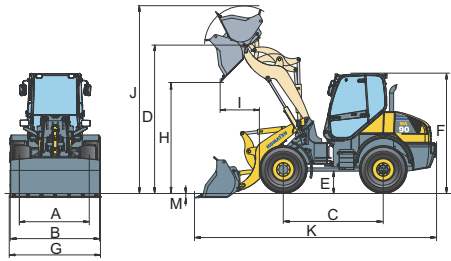

	Unit: mm (ft.in)
A Tread	1470 (4'10")
B Width over tires	1875 (6'2")
C Wheelbase	2260 (7'5")
D Hinge pin height, max. height	3210 (10'6")
E Ground clearance	300 (11'8")
F Overall height, ROPS cab	2665 (8'9")
Turning radius at corner of tire	3985 (13'1")

Measured with 405/70 R18 tires

Bucket type			Universal		Light materials	4-in-1
			With teeth	Without teeth	Without teeth	Without teeth
Bucket capacity	Heaped	m ³ (yd ³)	1.0 (1.31)	1.0 (1.31)	1.25 (1.64)	0.8 (1.05)
	Struck	m ³ (yd ³)	—	—	—	—
G Bucket width		mm (ft.in)	1915 (6'3")	1915 (6'3")	1870 (6'2")	1900 (6'3")
Bucket weight without teeth		kg (lb)	422 (930)	400 (882)	340 (750)	615 (1,356)
Static tipping load	Straight	kg (lb)	4310 (9,500)	4340 (9,570)	4295 (9,470)	4035 (8,900)
	Full turn (40°)	kg (lb)	3720 (8,200)	3750 (8,270)	3710 (8,180)	3445 (7,595)
H. Dumping clearance, max. height and 45° dump angle**		mm (ft.in)	2425 (7'11")	2425 (7'11")	2330 (7'8")	2425 (7'11")
Reach at 2130 mm (7') cutting edge clearance and 45° dump angle		mm (ft.in)	—	—	—	—
I. Reach at max. height and 45° dump angle	Reach at max. height and 45° dump angle	mm (ft.in)	995 (3'3")	995 (3'3")	1035 (3'5")	985 (3'3")
	Reach with arm horizontal and bucket level	mm (ft.in)	—	—	—	—
J. Operating height (fully raised)		mm (ft.in)	4170 (13'8")	4170 (13'8")	4250 (13'11")	4100 (13'8")
K. Overall length	Bucket on ground	mm (ft.in)	5630 (18'6")	5495 (18'0")	5720 (18'9")	5710 (18'9")
	Turning radius	Bucket edge	mm (ft.in)	4420 (14'6")	4420 (14'6")	4550 (14'11")
M. Digging depth	0°	mm (ft.in)	90 (3.5")	90 (3.5)	135 (5.3")	100 (3.9")
	10°	mm (ft.in)	—	—	—	—
Breakout force		kN kgf (lb)	56.7 5780 (12,750)	56.7 5780 (12,750)	41.8 4260 (9,400)	48.5 4950 (10,910)
Operating weight		kg (lb)	5545 (12,220)	5525 (12,180)	5560 (12,260)	5835 (12,860)

Performance Data Dimensions

WHEEL LOADERS

WA90-6 (Germany source)

Unit: mm (ft.in)

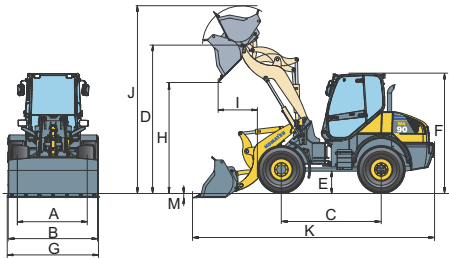

A Tread	1590 (5'3")
B Width over tires	2015 (6'7")
C Wheelbase	2300 (7'7")
D Hinge pin height, max. height	3450 (11'4")
E Ground clearance	350 (1'2")
F Overall height, ROPS cab	2820 (9'3")
Turning radius at corner of tire	4040 (13'3")

Measured with 405/70 R20 tires

Bucket type			Universal		Light material	Multi-purpose
			With teeth	Without teeth	Without teeth	With teeth
Bucket capacity	Heaped	m ³ (yd ³)	1.1 (1.44)	1.1 (1.44)	1.60 (2.09)	0.90 (1.18)
	Struck	m ³ (yd ³)	—	—	—	—
G Bucket width		mm (ft.in)	2050 (6'9")	2050 (6'9")	2200 (7'3")	2050 (6'9")
Bucket weight		kg (lb)	383 (844)	360 (794)	461 (1,016)	625 (1,378)
Static tipping load	Straight	kg (lb)	5010 (11,045)	5030 (11,090)	4910 (10,825)	4800 (10,580)
	Full turn (40°)	kg (lb)	4265 (9,400)	4290 (9,460)	4170 (9,190)	4050 (8,930)
H. Dumping clearance, max. height and 45° dump angle**		mm (ft.in)	2600 (8'6")	2640 (8'8")	2440 (8'0")	2505 (8'3")
Reach at 2130 mm (7') cutting edge clearance and 45° dump angle		mm (ft.in)	—	—	—	—
I. Reach at max. height and 45° dump angle		mm (ft.in)	1030 (3'5")	950 (3'1")	1140 (3'9")	1120 (3'8")
Reach with arm horizontal and bucket level		mm (ft.in)	—	—	—	—
J. Operating height (fully raised)		mm (ft.in)	4370 (14'4")	4370 (14'4")	4445 (14'7")	4300 (14'1")
K. Overall length	Bucket on ground	mm (ft.in)	5850 (19'2")	5860 (19'3")	6130 (20'1")	6035 (19'10")
	Turning radius	mm (ft.in)	4500 (14'9)	4500 (14'9)	4650 (15'3")	4550 (14'11")
M. Digging depth	0°	mm (ft.in)	95 (3.7")	95 (3.7")	135 (5.3")	95 (3.7")
	10°	mm (ft.in)	—	—	—	—
Breakout force	kN		71.4	71.4	59.5	74.2
	kgf (lb)		7280 (16,060)	7280 (16,060)	6070 (13,380)	7570 (16,685)
Operating weight		kg (lb)	6500 (14,330)	6475 (14,275)	6580 (14,510)	6740 (14,860)

Performance Data Dimensions

WHEEL LOADERS

WA100M-6 (Germany source)

Unit: mm (ft.in)

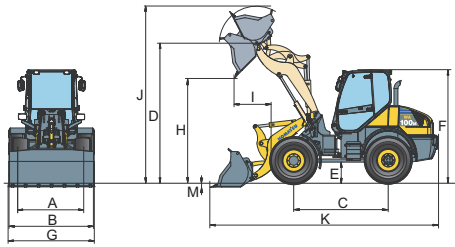

A Tread	1635 (5'4")
B Width over tires	2080 (6'10")
C Wheelbase	2400 (7'10")
D Hinge pin height, max. height	3540 (11'7")
E Ground clearance	380 (1'3")
F Overall height, ROPS cab	2840 (9'4")
Turning radius at corner of tire	4230 (13'11")

Measured with 455/70 R24 tires

Bucket type			Universal		Light material		4 · in · 1
			With teeth	Without teeth	Without teeth	With teeth	With teeth
Bucket capacity	Heaped	m ³ (yd ³)	1.25 (1.63)	1.25 (1.63)	1.60 (2.09)	1.80 (2.35)	1.05 (1.37)
	Struck	m ³ (yd ³)	—	—	—	—	—
G Bucket width		mm (ft.in)	2200 (7'3")	2200 (7'3")	2200 (7'3")	2200 (7'3")	2200 (7'3")
Bucket weight		kg (lb)	415 (915)	390 (860)	461 (1,016)	496 (1,093)	695 (1,532)
Static tipping load	Straight	kg (lb)	5880 (12,960)	6000 (13,230)	5670 (12,500)	5675 (12,510)	5970 (13,160)
	Full turn (40°)	kg (lb)	5030 (11,090)	5140 (11,330)	4840 (10,670)	4840 (10,670)	5070 (11,180)
H. Dumping clearance, max. height and 45° dump angle**		mm (ft.in)	2710 (8'11")	2730 (8'11")	2560 (8'5")	2485 (8'2")	2620 (8'7")
Reach at 2130 mm (7') cutting edge clearance and 45° dump angle		mm (ft.in)	—	—	—	—	—
I. Reach at max. height and 45° dump angle		mm (ft.in)	885 (2'11")	845 (2'9")	965 (3'2")	965 (3'2")	960 (3'2")
Reach with arm horizontal and bucket level		mm (ft.in)	—	—	—	—	—
J. Operating height (fully raised)		mm (ft.in)	4515 (14'10")	4515 (14'10")	4565 (15'0")	4635 (15'2")	4510 (14'10")
K. Overall length	Bucket on ground	mm (ft.in)	6000 (19'8")	5865 (19'3")	6105 (20'0")	6195 (20'4")	6015 (19'9")
	Turning radius	mm (ft.in)	4750 (15'7")	4750 (15'7")	4765 (15'8")	4805 (15'9")	4745 (15'7")
M. Digging depth	0°	mm (ft.in)	85 (3.3")	85 (3.3")	125 (4.9")	175 (6.9")	85 (3.3")
	10°	mm (ft.in)	—	—	—	—	—
Breakout force	kN		74.3	74.3	58.4	55.2	71.7
	kgf (lb)		7580 (16,710)	7580 (16,710)	5955 (13,130)	5630 (12,410)	7310 (16,120)
Operating weight		kg (lb)	6900 (15,210)	6875 (15,160)	6946 (15,310)	6981 (15,390)	7180 (15,830)

Performance Data Dimensions

WHEEL LOADERS

WA150PZ-6 (for EU)

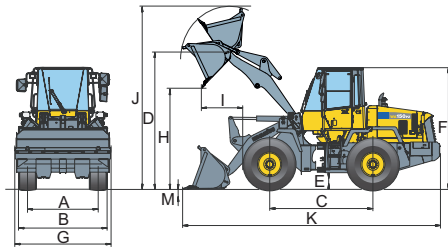

	Unit: mm (ft.in)
A Tread	1780 (5'10")
B Width over tires	2220 (7'3")
C Wheelbase	2600 (8'6")
D Hinge pin height, max. height	3695 (12'1")
E Ground clearance	425 (1'5")
F Overall height, ROPS cab	3060 (10'0")
Turning radius at corner of tire	4735 (15'6")

Measured with 17.5 R25 tires

Bucket type			Universal		Stock pile		4-in-1
			with Teeth	with B.O.C.	with Teeth	with B.O.C.	with Teeth
Bucket capacity	Heaped	m ³ (yd ³)	1.5 (2.0)	1.6 (2.1)	1.6 (2.1)	1.7 (2.2)	1.2 (1.6)
	Struck	m ³ (yd ³)	–	–	–	–	–
G. Bucket width		mm (ft.in)	2395 (7'10")	2405 (7'11")	2395 (7'10")	2405 (7'11")	2350 (7'9")
Bucket weight		kg (lb)	705 (1,554)	750 (1,653)	800 (1,764)	845 (1,863)	960 (2,116)
Static tipping load	Straight	kg (lb)	6590 (14,530)	6490 (14,310)	6470 (14,260)	6370 (14,040)	6070 (13,380)
	Full turn (40°)	kg (lb)	5780 (12,740)	5680 (12,520)	5660 (12,480)	5560 (12,260)	5290 (11,660)
H. Dumping clearance, max. height and 45° dump angle**		mm (ft.in)	2620 (8'7")	2708 (8'11")	2600 (8'6")	2686 (8'10")	2560 (8'5")
Reach at 2130 mm (7") clearance and 45° dump angle		mm (ft.in)	–	–	–	–	–
I. Reach at max. height and 45° dump angle**		mm (ft.in)	1063 (3'6")	945 (3'1")	1083 (3'7")	967 (3'2")	1080 (3'7")
Reach with arm horizontal and bucket level		mm (ft.in)	–	–	–	–	–
J. Operating height (fully raised)		mm (ft.in)	5070 (16'8")	5070 (16'8")	5070 (16'8")	5070 (16'8")	5070 (16'8")
K. Overall length, bucket on ground		mm (ft.in)	6916 (22'8")	6788 (22'3")	6946 (22'9")	6818 (22'4")	6997 (22'11")
Turning radius*		mm (ft.in)	5330 (17'6")	5300 (17'5")	5340 (17'6")	5305 (17'5")	5335 (17'6")
Digging depth	0°	mm (ft.in)	100 (3.9")	120 (4.7")	100 (3.9")	120 (4.7")	135 (5.3")
	10°	mm (ft.in)	–	–	–	–	–
Breakout force	kN		80.9	76.9	78.6	74.5	76.5
	kgf (lb)		8250 (18,190)	7840 (17,280)	8010 (17,660)	7600 (16,750)	7800 (17,200)
Operating weight		kg (lb)	9100 (20,060)	9145 (20,160)	9195 (20,270)	9240 (20,370)	9355 (20,620)

* Bucket at carry, outside corner of bucket.

** At the end of B.O.C. or teeth

Fork tines

Fork tine length	mm (ft.in)	1200 (3'11")
A Max. reach at ground level	mm (ft.in)	860 (2'10")
B Max. reach	mm (ft.in)	1495 (4'11")
C Max. reach at max. stacking height	mm (ft.in)	630 (2'1")
a Max. height fork-carrier	mm (ft.in)	4495 (14'9")
b Hinge pin height	mm (ft.in)	3695 (12'1")
c Max. stacking height	mm (ft.in)	3570 (11'9")
d Height of forks at maximum reach	mm (ft.in)	1700 (5'7")
Max. tipping load, straight	kg (lb)	5060 (11,160)
Max. tipping load, articulated	kg (lb)	4450 (9,810)
Max. payload as per EN 474-3, 80%	kg (lb)	3560 (7,850)
Max. payload as per EN 474-3, 60%	kg (lb)	2670 (5,890)
Weight in working order with fork tines	kg (lb)	8820 (19,440)

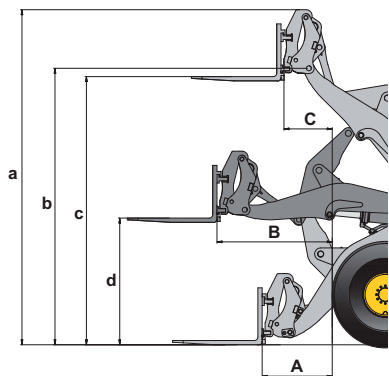

Performance Data Dimensions

WHEEL LOADERS

WA200PZ-6 (Germany source)

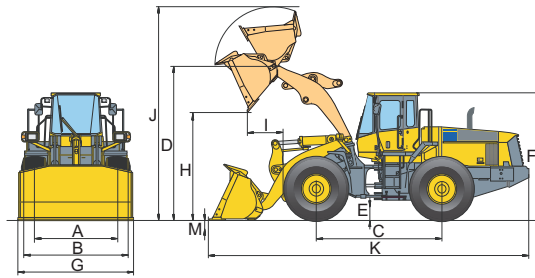

Unit: mm (ft.in)

A Tread	1930 (6'4")
B Width over tires	2470 (8'1")
C Wheelbase	2840 (9'4")
D Hinge pin height, max. height	3885 (12'9")
E Ground clearance	495 (1'7")
F Overall height, ROPS cab	3180 (10'5")
Turning radius at corner of tire	5150 (16'11")

Bucket (With Quick Coupler)

Measured with 20.5 R25 tires

Bucket type			Earthmoving		Stockpile		Universal	
			With teeth	With B.O.C.	With teeth	With B.O.C.	With teeth	With B.O.C.
Bucket capacity	Heaped	m ³ (yd ³)	1.9 (2.5)	2.0 (2.6)	2.0 (2.6)	2.1 (2.7)	1.9 (2.5)	2.0 (2.6)
	Struck	m ³ (yd ³)	–	–	–	–	–	–
Bucket width		mm (ft.in)	2545 (8'4")	2540 (8'4")	2545 (8'4")	2540 (8'4")	2545 (8'4")	2540 (8'4")
Bucket weight		kg (lb)	860 (1,896)	935 (2,061)	875 (1,929)	950 (2,094)	825 (1,819)	900 (1,984)
Static tipping load	Straight	kg (lb)	8440 (18,610)	8280 (18,250)	8385 (18,490)	8260 (18,210)	8430 (18,590)	8290 (18,280)
	40° full turn	kg (lb)	7355 (16,220)	7205 (15,880)	7305 (16,110)	7185 (15,840)	7355 (16,220)	7215 (15,910)
H. Dumping clearance, max. height and 45° dump angle**		mm (ft.in)	2750 (9'0")	2830 (9'3")	2730 (8'11")	2805 (9'2")	2805 (9'2")	2730 (8'11")
Reach at 2130 mm (7') clearance and 45° dump angle		mm (ft.in)	–	–	–	–	–	–
I. Reach at max. height and 45° dump angle**		mm (ft.in)	1215 (4'0")	1100 (3'7")	1235 (4'1")	1120 (3'8")	1205 (3'11")	1095 (3'7")
Reach with arm horizontal and bucket level		mm (ft.in)	–	–	–	–	–	–
J. Operating height (fully raised)		mm (ft.in)	5315 (17'5")	5315 (17'5")	5315 (17'5")	5315 (17'5")	5290 (17'4")	5290 (17'4")
K. Overall length		mm (ft.in)	7420 (24'4")	7305 (24'0")	7450 (24'5")	7335 (24'1")	7450 (24'5")	7335 (24'1")
Turning radius*		mm (ft.in)	5800 (19'0")	5765 (18'11")	5810 (19'1")	5775 (18'11")	5810 (19'1")	5770 (18'11")
M. Digging depth	0°	mm (ft.in)	75 (3.0")	100 (3.9")	75 (3.0")	100 (3.9")	95 (3.7")	120 (4.7")
	10°	mm (ft.in)	–	–	–	–	–	–
Breakout force	kN		96	91.6	93.6	89.3	95.3	90.9
	kgf (lb)		9790 (21,590)	9340 (20,600)	9550 (21,050)	9110 (20,080)	9720 (21,430)	9270 (20,440)
Operating weight		kg (lb)	11765 (25,940)	11840 (26,100)	11780 (25,970)	11855 (26,140)	11730 (25,860)	11805 (26,030)

* Bucket at carry, outside corner of bucket.

** At the end of tooth or B.O.C.

Fork tines

Fork tine length	mm (ft.in)	1200 (3'11")
A Max. reach at ground level	mm (ft.in)	985 (3'3")
B Max. reach	mm (ft.in)	1620 (5'4")
C Max. reach at max. stacking height	mm (ft.in)	720 (2'4")
a Max. height fork-carrier	mm (ft.in)	4705 (15'5")
b Hinge pin height	mm (ft.in)	3885 (12'9")
c Max. stacking height	mm (ft.in)	3765 (12'4")
d Height of forks at maximum reach	mm (ft.in)	1780 (5'10")
Max. tipping load, straight	kg (lb)	6310 (13,910)
Max. tipping load, articulated	kg (lb)	5520 (12,170)
Max. payload as per EN 474-3, 80%	kg (lb)	4415 (9,730)
Max. payload as per EN 474-3, 60%	kg (lb)	3325 (7,330)
Weight in working order with fork tines	kg (lb)	11470 (25,290)

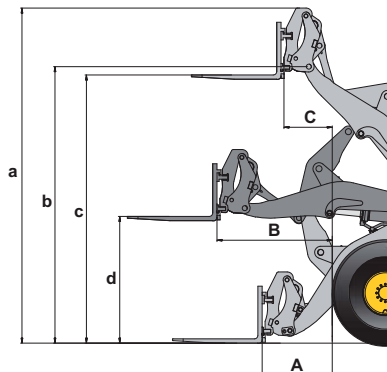

Performance Data Dimensions

WHEEL LOADERS

WA250PZ-6 (Germany source)

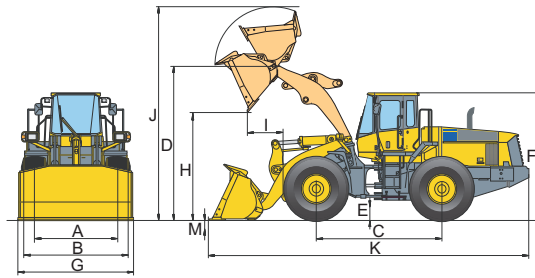

Unit: mm (ft.in)

A Tread	1930 (6'4")
B Width over tires	2470 (8'1")
C Wheelbase	2900 (9'6")
D Hinge pin height, max. height	3965 (13'0")
E Ground clearance	465 (1'6")
F Overall height, ROPS cab	3200 (10'6")
Turning radius at corner of tire	5240 (17'2")

Bucket (With Quick Coupler)

Measured with 20.5 R25 (L3) tires

Bucket type			Earthmoving		Stockpile		Universal	
			With teeth	With B.O.C.	With teeth	With B.O.C.	With teeth	With B.O.C.
Bucket capacity	Heaped	m ³ (yd ³)	2.2 (2.9)	2.3 (3.0)	2.3 (3.0)	2.5 (3.3)	2.1 (2.7)	2.2 (2.9)
	Struck	m ³ (yd ³)	–	–	–	–	–	–
Bucket width		mm (ft.in)	2550 (8'4")	2540 (8'4")	2550 (8'4")	2540 (8'4")	2550 (8'4")	2540 (8'4")
Bucket weight		kg (lb)	1080 (2,381)	1085 (2,392)	1105 (2,436)	1110 (2,447)	955 (2,105)	960 (2,116)
Static tipping load	Straight	kg (lb)	8985 (19,810)	8955 (19,740)	8955 (19,740)	8905 (19,630)	9125 (20,120)	9105 (20,070)
	40° full turn	kg (lb)	7800 (17,200)	7765 (17,120)	7765 (17,120)	7720 (17,020)	7935 (17,490)	7915 (17,450)
H. Dumping clearance, max. height and 45° dump angle**		mm (ft.in)	2710 (8'11")	2815 (9'3")	2685 (8'10")	2790 (9'2")	2715 (8'11")	2815 (9'3")
Reach at 2130 mm (7') clearance and 45° dump angle		mm (ft.in)	–	–	–	–	–	–
I. Reach at max. height and 45° dump angle**		mm (ft.in)	1230 (4'0")	1095 (3'7")	1255 (4'1")	1120 (3'8")	1230 (4'0")	1090 (3'7")
Reach with arm horizontal and bucket level		mm (ft.in)	–	–	–	–	–	–
J. Operating height (fully raised)		mm (ft.in)	5450 (17'11")	5450 (17'11")	5450 (17'11")	5450 (17'11")	5390 (17'8")	5390 (17'8")
K. Overall length		mm (ft.in)	7585 (24'11")	7440 (24'5")	7620 (25'0")	7620 (25'0")	7580 (24'10")	7435 (24'5")
Turning radius		mm (ft.in)	5905 (19'4")	5855 (19'3")	5915 (19'5")	5865 (19'3")	5905 (19'4")	5855 (19'3")
M. Digging depth	0°	mm (ft.in)	125 (4.9")	150 (5.9")	125 (4.9")	150 (5.9")	125 (4.9")	150 (5.9")
	10°	mm (ft.in)	–	–	–	–	–	–
Breakout force	kN		111.9	107.2	108.9	104	112.4	107.4
	kgf (lb)		11410 (25,160)	10930 (24,110)	11110 (24,490)	10610 (23,390)	11460 (25,280)	10950 (24,150)
Operating weight		kg (lb)	13025 (28,720)	13030 (28,730)	13050 (28,770)	13055 (28,780)	12900 (28,440)	12905 (28,450)

* Bucket at carry, outside corner of bucket.

**At the end of tooth or B.O.C.

Fork tines

Fork tine length	mm (ft.in)	1200 (3'11")
A Max. reach at ground level	mm (ft.in)	965 (3'2")
B Max. reach	mm (ft.in)	1630 (5'4")
C Max. reach at max. stacking height	mm (ft.in)	725 (2'5")
a Max. height fork-carrier	mm (ft.in)	4765 (15'8")
b Hinge pin height	mm (ft.in)	3965 (13'0")
c Max. stacking height	mm (ft.in)	3820 (12'6")
d Height of forks at maximum reach	mm (ft.in)	1820 (6'0")
Max. tipping load, straight	kg (lb)	7005 (15,440)
Max. tipping load, articulated	kg (lb)	6120 (13,490)
Max. payload as per EN 474-3, 80%	kg (lb)	4895 (10,790)
Max. payload as per EN 474-3, 60%	kg (lb)	3670 (8,090)
Weight in working order with fork tines	kg (lb)	12510 (27,580)

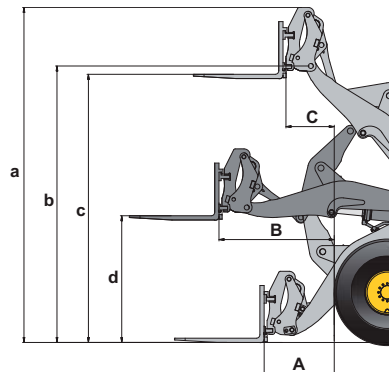

Performance Data Dimensions

WHEEL LOADERS

WA320-6 (Germany source)

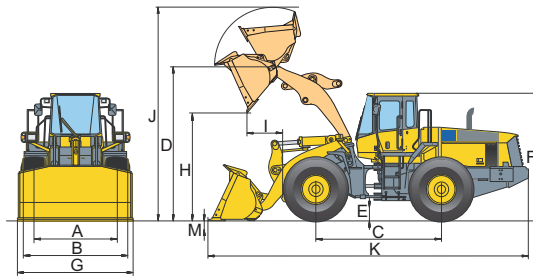

Unit: mm (ft.in)

A Tread	2050 (6'9")
B Width over tires	2580 (8'6")
C Wheelbase	3030 (9'11")
D Hinge pin height, max. height	3910 (12'10")
E Ground clearance	465 (1'6")
F Overall height, ROPS cab	3200 (10'6")
Turning radius at corner of tire	5475 (18'0")

Measured with 17.5 R25 tires

Bucket type			Earthmoving		Stock pile		Universal	
			with Teeth	with B.O.C.	with Teeth	with B.O.C.	with Teeth	with B.O.C.
Bucket mount			Direct	Direct	Direct	Direct	Direct	Direct
Bucket capacity	Heaped	m ³ (yd ³)	2.7 (3.5)	2.9 (3.8)	3.0 (3.9)	3.2 (4.2)	2.7 (3.5)	2.9 (3.8)
	Struck	m ³ (yd ³)	–	–	–	–	–	–
G. Bucket width		mm (ft.in)	2740 (9'0")	2750 (9'0")	2740 (9'0")	2750 (9'0")	2740 (9'0")	2750 (9'0")
Bucket weight		kg (lb)	1295 (2,855)	1385 (3,053)	1220 (2,690)	1310 (2,888)	1165 (2,568)	1255 (2,767)
Static tipping load	Straight	kg (lb)	12740 (25,280)	12520 (27,600)	12760 (28,130)	12535 (27,630)	12855 (28,340)	12620 (27,820)
	Full turn (40°)	kg (lb)	10860 (23,940)	10650 (23,480)	10890 (24,010)	10675 (23,530)	10980 (24,210)	10760 (23,720)
H. Dumping clearance, max. height and 45° dump angle**		mm (ft.in)	2678 (8'9")	2780 (9'1")	2642 (8'8")	2746 (9'0")	2682 (8'10")	2785 (9'2")
Reach at 2130 mm (7') clearance and 45° dump angle		mm (ft.in)	–	–	–	–	–	–
I. Reach at max. height and 45° dump angle**		mm (ft.in)	1147 (3'9")	1025 (3'4")	1183 (3'11")	1060 (3'6")	1143 (3'9")	1020 (3'4")
Reach with arm horizontal and bucket level		mm (ft.in)	–	–	–	–	–	–
J. Operating height (fully raised)		mm (ft.in)	5260 (17'3")	5260 (17'3")	5415 (17'9")	5415 (17'9")	5320 (17'5")	5320 (17'5")
K. Overall length, bucket on ground		mm (ft.in)	7770 (25'6")	7635 (25'1")	7820 (25'8")	7685 (25'3")	7765 (25'6")	7630 (25'0")
Turning radius*		mm (ft.in)	6160 (20'3")	6125 (20'1")	6170 (20'3")	6135 (20'2")	6155 (20'2")	6120 (20'1")
Digging depth	0°	mm (ft.in)	105 (4.1")	135 (5.3")	105 (4.1")	135 (5.3")	105 (4.1")	135 (5.3")
	10°	mm (ft.in)	–	–	–	–	–	–
Breakout force		kN (kgf)	157.6 (16070)	156.5 (15960)	155.8 (15890)	154.8 (15780)	156.8 (15990)	155.8 (15890)
Operating weight		kg (lb)	14940 (32,940)	15030 (33,140)	14865 (32,770)	14955 (32,970)	14810 (32,650)	14900 (32,850)

* Bucket at carry, outside corner of bucket.

** At the end of B.O.C. or teeth

Weight Changes

	Change in Operating Weight		Change in Tipping Load				Width Over Tire		Change in Reach at 45°		Change in Vertical Dimensions	
			Straight		Full Turn							
	kg	lb	kg	lb	kg	lb	mm	ft.in	mm	ft.in	mm	ft.in
20.5 R25 (L2)	-200	-441	-140	-309	-130	-287	0	0"	0	0"	-40	-1.6"
20.5 R25 (L5)	+660	+1,455	+480	+1,058	+425	+937	0	0"	-25	-1"	+25	+1"
23.5 R25 (L2)	+340	+750	+245	+540	+220	+485	+75	+3.0"	-60	-2.4"	+60	+2.4"

Performance Data Dimensions

WHEEL LOADERS

WA320-6 (Germany source)

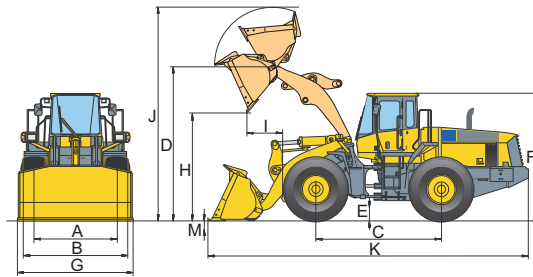

	Unit: mm (ft.in)
A Tread	2050 (6'9")
B Width over tires	2580 (8'6")
C Wheelbase	3030 (9'11")
D Hinge pin height, max. height	3910 (12'10")
E Ground clearance	465 (1'6")
F Overall height, ROPS cab	3200 (10'6")
Turning radius at corner of tire	5475 (18'0")

Bucket (with quick coupler)

Measured with 20.5 R25 tires

Bucket type			Earthmoving		Stock pile		Universal	
			with Teeth	with B.O.C.	with Teeth	with B.O.C.	with Teeth	with B.O.C.
Bucket mount			QC	QC	QC	QC	QC	QC
Bucket capacity	Heaped	m ³ (yd ³)	2.7 (3.5)	2.9 (3.8)	3.0 (3.9)	3.2 (4.2)	2.7 (3.5)	2.9 (3.8)
	Struck	m ³ (yd ³)	–	–	–	–	–	–
G. Bucket width		mm (ft.in)	2740 (9'0")	2750 (9'0")	2740 (9'0")	2750 (9'0")	2740 (9'0")	2750 (9'0")
Bucket weight		kg (lb)	1665 (3,671)	1755 (3,869)	1560 (3,439)	1650 (3,638)	1510 (3,329)	1600 (3,527)
Static tipping load	Straight	kg (lb)	11800 (22,050)	11595 (25,560)	11880 (26,190)	11680 (25,750)	11910 (26,260)	11755 (25,920)
	Full turn (40°)	kg (lb)	10000 (23,940)	9815 (21,640)	10095 (22,260)	9905 (21,840)	10120 (22,310)	9975 (21,990)
H. Dumping clearance, max. height and 45° dump angle**		mm (ft.in)	2532 (8'4")	2635 (8'8")	2502 (8'3")	2605 (8'7")	2540 (8'4")	2645 (8'8")
Reach at 2130 mm (7') clearance and 45° dump angle		mm (ft.in)	–	–	–	–	–	–
I. Reach at max. height and 45° dump angle**		mm (ft.in)	1308 (4'3")	1185 (3'11")	1338 (4'5")	1215 (4'0")	1300 (4'3")	1175 (3'10")
Reach with arm horizontal and bucket level		mm (ft.in)	–	–	–	–	–	–
J. Operating height (fully raised)		mm (ft.in)	5420 (17'9")	5420 (17'9")	5575 (18'3")	5575 (18'3")	5480 (18'0")	5480 (18'0")
K. Overall length, bucket on ground		mm (ft.in)	7980 (26'2")	7845 (25'9")	8020 (26'4")	7885 (25'10")	7965 (26'2")	7830 (25'8")
Turning radius*		mm (ft.in)	6225 (20'5")	6185 (20'4")	6235 (20'5")	6200 (20'4")	6220 (20'5")	6180 (20'3")
Digging depth	0°	mm (ft.in)	100 (3.9")	130 (5.1")	100 (3.9")	130 (5.1")	100 (3.9")	130 (5.1")
	10°	mm (ft.in)	–	–	–	–	–	–
Breakout force		kN (kgf (lb))	149.4 (15230 (33,580))	148.9 (15180 (33,470))	145.3 (14820 (32,670))	143 (14580 (32,140))	149 (15190 (33,490))	147.7 (15060 (33,200))
Operating weight		kg (lb)	15310 (33,750)	15400 (33,950)	15205 (33,520)	15295 (33,720)	15155 (33,410)	15245 (33,610)

* Bucket at carry, outside corner of bucket.

** At the end of B.O.C. or teeth

Performance Data Dimensions

WHEEL LOADERS

WA320PZ-6 (Germany source)

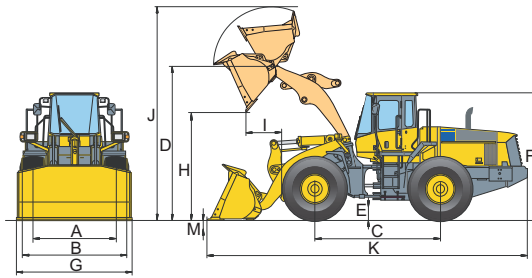

Unit: mm (ft.in)

A Tread	2050 (6'9")
B Width over tires	2580 (8'6")
C Wheelbase	3030 (9'11")
D Hinge pin height, max. height	4010 (13'2")
E Ground clearance	465 (1'6")
F Overall height, ROPS cab	3200 (10'6")
Turning radius at corner of tire	5475 (18'0")

Measured with 20.5 R25 tires

Bucket type			Earthmoving		Stockpile		Universal	
			With teeth	With B.O.C.	With teeth	With B.O.C.	With teeth	With B.O.C.
Bucket mount			Direct	Direct	Direct	Direct	Direct	Direct
Bucket capacity	Heaped	m ³ (yd ³)	2.7 (3.5)	2.9 (3.8)	3.0 (3.9)	3.2 (4.2)	2.7 (3.5)	2.9 (3.8)
	Struck	m ³ (yd ³)	—	—	—	—	—	—
G. Bucket width		mm (ft.in)	2740 (9'0")	2750 (9'0")	2740 (9'0")	2750 (9'0")	2740 (9'0")	2750 (9'0")
Bucket weight		kg (lb)	1325 (2,921)	1415 (3,120)	1265 (2,789)	1355 (2,987)	1210 (2,668)	1300 (2,866)
Static tipping load	Straight	kg (lb)	11465 (25,280)	11300 (24,910)	11470 (25,290)	11235 (24,770)	11560 (25,490)	11360 (25,040)
	40° full turn	kg (lb)	9850 (21,720)	9695 (21,370)	9860 (21,740)	9645 (21,260)	9950 (21,940)	9765 (21,530)
H. Dumping clearance, max. height and 45° dump angle**		mm (ft.in)	2750 (9'0")	2840 (9'4")	2715 (8'11")	2800 (9'2")	2750 (9'0")	2840 (9'4")
I. Reach at max. height and 45° dump angle**		mm (ft.in)	1145 (3'9")	1015 (3'4")	1185 (3'11")	1055 (3'6")	1145 (3'9")	1015 (3'4")
J. Operating height (fully raised)		mm (ft.in)	5335 (17'6")	5335 (17'6")	5500 (18'1")	5500 (18'1")	5400 (17'9")	5400 (17'9")
K. Overall length, bucket on ground		mm (ft.in)	7850 (25'9")	7725 (25'4")	7905 (25'11")	7780 (25'6")	7850 (25'9")	7725 (25'4")
Turning radius*		mm (ft.in)	6180 (20'3")	6150 (20'2")	6195 (20'4")	6165 (20'3")	6180 (20'3")	6150 (20'2")
Digging depth	0°	mm (ft.in)	150 (5.9")	180 (7.1")	150 (5.9")	180 (7.1")	150 (5.9")	180 (7.1")
	10°	mm (ft.in)	—	—	—	—	—	—
Breakout force		kN	171.5	160.6	163.5	153.6	171.5	160.6
		kgf (lb)	17490 (35,560)	16380 (36,110)	16670 (36,750)	15660 (34,520)	17490 (38,560)	16380 (36,110)
Operating weight		kg (lb)	15350 (33,840)	15440 (34,040)	15290 (33,710)	15380 (33,910)	15235 (33,590)	15325 (33,790)

* Bucket at carry, outside corner of bucket.

** At the end of B.O.C. or teeth

Weight Changes

	Change in Operating Weight		Change in Tipping Load				Width Over Tire		Change in Reach at 45°		Change in Vertical Dimensions	
			Straight		Full Turn							
	kg	lb	kg	lb	kg	lb	mm	ft.in	mm	ft.in	mm	ft.in
20.5 R25 (L2)	-200	-441	-130	-287	-115	-254	0	0"	-40	-1.6"	-40	-1.6"
20.5 R25 (L5)	+660	+1,455	+430	+948	+380	+838	0	0"	-25	-1.0"	+25	+1"
23.5 R25 (L3)	+340	+750	+200	+441	+175	+386	+75	+3.0"	-60	-2.4"	+60	+2.4"

Fork tines

Fork tine length	mm (ft.in)	1200 (3'11")
A Max. reach at ground level	mm (ft.in)	1015 (3'4")
B Max. reach	mm (ft.in)	1665 (5'6")
C Max. reach at max. stacking height	mm (ft.in)	770 (2'6")
a Max. height fork-carrier	mm (ft.in)	4765 (15'8")
b Hinge pin height	mm (ft.in)	4010 (13'2")
c Max. stacking height	mm (ft.in)	3825 (12'7")
d Height of forks at maximum reach	mm (ft.in)	1815 (5'11")
Max. tipping load, straight	kg (lb)	8870 (19,560)
Max. tipping load, articulated	kg (lb)	7655 (16,880)
Max. payload as per EN 474-3, 80%	kg (lb)	6120 (13,490)
Max. payload as per EN 474-3, 60%	kg (lb)	4600 (10,140)
Weight in working order with fork tines	kg (lb)	15055 (33,190)

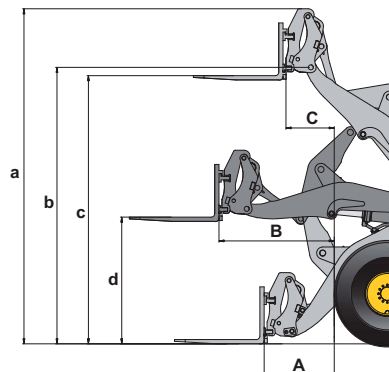

Performance Data Dimensions

WHEEL LOADERS

WA320PZ-6 (Germany source)

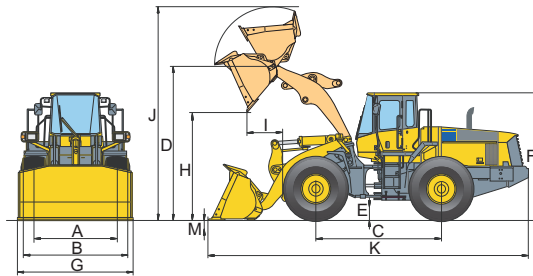

	Unit: mm (ft.in)
A Tread	2050 (6'9")
B Width over tires	2580 (8'6")
C Wheelbase	3030 (9'11")
D Hinge pin height, max. height	4010 (13'2")
E Ground clearance	465 (1'6")
F Overall height, ROPS cab	3200 (10'6")
Turning radius at corner of tire	5475 (18'0")

Bucket (with quick coupler)

Measured with 20.5 R25 tires

Bucket type			Earthmoving		Stockpile		Universal	
			With teeth	With B.O.C.	With teeth	With B.O.C.	With teeth	With B.O.C.
Bucket mount			Quick Coupler	Quick Coupler	Quick Coupler	Quick Coupler	Quick Coupler	Quick Coupler
Bucket capacity	Heaped	m ³ (yd ³)	2.7 (3.5)	2.9 (3.8)	3.0 (3.9)	3.2 (4.2)	2.6 (345)	2.7 (3.5)
	Struck	m ³ (yd ³)	–	–	–	–	–	–
G. Bucket width		mm (ft.in)	2740 (9'0")	2750 (9'0")	2740 (9'0")	2750 (9'0")	2740 (9'0")	2750 (9'0")
Bucket weight		kg (lb)	1230 (2,712)	1320 (2,910)	1130 (2,491)	1220 (2,690)	1025 (2,260)	1115 (2,458)
Static tipping load	Straight	kg (lb)	10850 (23,920)	10655 (23,490)	10920 (24,070)	10735 (23,670)	11135 (24,550)	10945 (24,130)
	40° full turn	kg (lb)	9275 (20,450)	9090 (20,040)	9350 (20,610)	9175 (20,230)	9550 (21,050)	9370 (20,660)
H. Dumping clearance, max. height and 45° dump angle**		mm (ft.in)	2660 (8'9")	2745 (9'0")	2630 (8'8")	2715 (8'11")	2715 (8'11")	2800 (9'2")
I. Reach at max. height and 45° dump angle**		mm (ft.in)	1315 (4'4")	1185 (3'11")	1345 (4'5")	1215 (4'0")	1260 (4'2")	1135 (3'9")
J. Operating height (fully raised)		mm (ft.in)	5500 (18'1")	5500 (18'1")	5660 (18'7")	5660 (18'7")	5495 (18'0")	5495 (18'0")
K. Overall length, bucket on ground		mm (ft.in)	7990 (26'3")	7865 (25'10")	8035 (26'4")	7910 (25'11")	7920 (26'0")	7795 (25'7")
Turning radius*		mm (ft.in)	6215 (20'5")	6180 (20'3")	6225 (20'5")	6195 (20'4")	6190 (20'4")	6160 (20'3")
Digging depth	0°	mm (ft.in)	95 (3.7")	125 (4.9")	95 (3.7")	125 (4.9")	95 (3.7")	125 (4.9")
	10°	mm (ft.in)	–	–	–	–	–	–
Breakout force		kN	147.6	139.5	143	135.4	156.3	147.3
		kgf (lb)	15050 (33,180)	14220 (31,350)	14580 (32,140)	13810 (30,450)	15940 (35,140)	15020 (33,110)
Operating weight		kg (lb)	15710 (34,630)	15800 (34,830)	15610 (34,741)	15700 (34,610)	15505 (34,180)	15595 (34,380)

* Bucket at carry, outside corner of bucket.

** At the end of B.O.C. or teeth

Performance Data Dimensions

WHEEL LOADERS

WA380-7 (for EU)

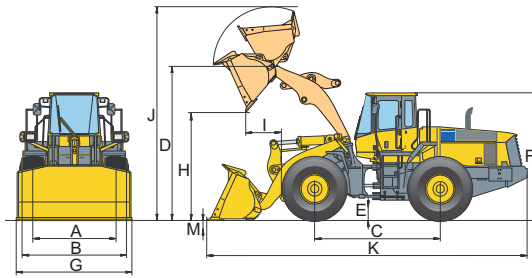

Unit: mm (ft.in)

A Tread	2160 (7'1")
B Width over tires	2765 (9'1")
C Wheelbase	3300 (10'10")
D Hinge pin height, max. height	4095 (13'5")
E Ground clearance	450 (1'6")
F Overall height, ROPS cab	3395 (11'2")
Turning radius at corner of tire	6320 (20'9")

Measured with 23.5 R25 (L3) tires

Bucket with raised bottom

Bucket type			Universal		Stockpile	
			with Teeth	with B.O.C.	with Teeth	with B.O.C.
Bucket mount			Direct	Direct	Direct	Direct
Bucket capacity	Heaped	m ³ (yd ³)	3.2 (4.2)	3.35 (4.4)	3.6 (4.7)	3.75 (4.9)
	Struck	m ³ (yd ³)	–	–	–	–
G. Bucket width			2990 (9'10")	2990 (9'10")	2990 (9'10")	2990 (9'10")
Bucket weight			1615 (3,560)	1725 (3,803)	1690 (3,726)	1800 (3,968)
Static tipping load	Straight	kg (lb)	14565 (32,110)	14290 (31,500)	14645 (32,290)	14370 (31,680)
	Full turn (40°)	kg (lb)	12890 (28,420)	12265 (27,040)	12960 (28,570)	12695 (27,990)
H. Dumping clearance, max. height and 45° dump angle**			2790 (9'2")	2895 (9'6")	2790 (9'2")	2895 (9'6")
I. Reach at max. height and 45° dump angle**			1235 (4'1")	1110 (3'8")	1235 (4'1")	1110 (3'8")
J. Operating height (fully raised)			5585 (18'4")	5585 (18'4")	5760 (18'11")	5760 (18'11")
K. Overall length, bucket on ground			8225 (27'0")	8380 (27'6")	8225 (27'0")	8380 (27'6")
Turning radius*			7305 (24'0")	7265 (23'10")	7305 (24'0")	7265 (23'10")
Digging depth	0°	mm (ft.in)	120 (4.7")	120 (4.7")	90 (3.5")	90 (3.5")
	10°	mm (ft.in)	–	–	–	–
Breakout force			163 kgf (lb)	151 kgf (lb)	162 kgf (lb)	150 kgf (lb)
Operating weight			18510 (40,810)	18625 (41,060)	18585 (40,970)	18695 (41,210)

* Bucket at carry, outside corner of bucket.

** At the end of B.O.C. or teeth

Weight and Dimension Changes

	Change in Operating Weight		Change in Tipping Load				Width Over Tire		Change in Reach		Change in Vertical Dimensions	
			Straight		Full Turn							
	kg	lb	kg	lb	kg	lb	mm	ft.in	mm	ft.in	mm	ft.in
XMINE L5 tires	+720	+1,587	+550	+1,213	+460	+1,014	+35	+1.4	-25	-1.0"	+45	+1.8"
Additional counterweight	+245	+1,455	+855	+948	+715	+838	0	0"	0	0"	0	0"
High lift boom (with add. CW)	+665	+1,466	-3275	-7,220	-2770	-6,107	0	0	+140	+9.4"	+530	+1'9"

Fork tines

Fork tine length	mm (ft.in)	1500 (4'11")
A Max. reach at ground level	mm (ft.in)	1020 (3'4")
B Max. reach	mm (ft.in)	1680 (5'6")
C Max. reach at max. stacking height	mm (ft.in)	820 (2'8")
a Max. height fork-carrier	mm (ft.in)	4930 (16'2")
b Hinge pin height	mm (ft.in)	4095 (13'5")
c Max. stacking height	mm (ft.in)	3925 (12'11")
d Height of forks at maximum reach	mm (ft.in)	1885 (6'2")
Max. tipping load, straight	kg (lb)	10250 (22,600)
Max. tipping load, articulated	kg (lb)	9195 (20,270)
Max. payload as per EN 474-3, 80%	kg (lb)	7000 (15,430)
Max. payload as per EN 474-3, 60%	kg (lb)	5375 (11,850)
Weight in working order with fork tines	kg (lb)	18115 (39,940)

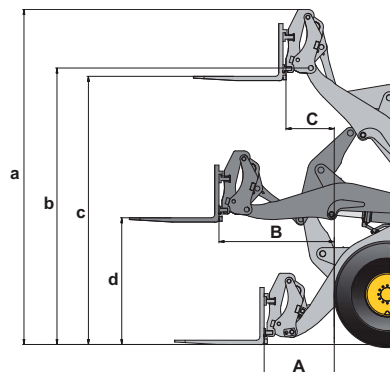

Performance Data Dimensions

WHEEL LOADERS

WA380-7 (for EU)

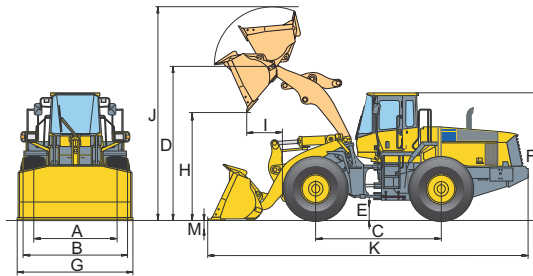

Unit: mm (ft.in)

A Tread	2160 (7'1")
B Width over tires	2765 (9'1")
C Wheelbase	3300 (10'10")
D Hinge pin height, max. height	4095 (13'5")
E Ground clearance	450 (1'6")
F Overall height, ROPS cab	3395 (11'2")
Turning radius at corner of tire	6320 (20'9")

Measured with 23.5 R25 (L3) tires

Bucket with flat bottom

Bucket type			Universal		Stockpile	
			with Teeth	with B.O.C.	with Teeth	with B.O.C.
Bucket mount			Direct	Direct	Direct	Direct
Bucket capacity	Heaped	m ³ (yd ³)	3.1 (4.1)	3.25 (4.3)	3.5 (4.6)	3.65 (4.8)
	Struck	m ³ (yd ³)	–	–	–	–
G. Bucket width			2990 (9'10")	2990 (9'10")	2990 (9'10")	2990 (9'10")
Bucket weight			1650 (3,638)	1760 (3,880)	1720 (3,792)	1835 (4,045)
Static tipping load	Straight	kg (lb)	14335 (31,660)	14105 (31,100)	14460 (31,880)	14185 (31,270)
	Full turn (40°)	kg (lb)	12690 (27,980)	12465 (27,480)	12790 (28,200)	12520 (27,660)
H. Dumping clearance, max. height and 45° dump angle**			2800 (9'2")	2905 (9'6")	2800 (9'2")	2905 (9'6")
I. Reach at max. height and 45° dump angle**			1225 (4'0")	1100 (3'7")	1225 (4'0")	1100 (3'7")
J. Operating height (fully raised)			5575 (18'3")	5575 (18'3")	5750 (18'10")	5750 (18'10")
K. Overall length, bucket on ground			8195 (26'11")	8365 (27'5")	8195 (26'11")	8365 (27'5")
Turning radius*			7300 (23'11")	7260 (23'10")	7300 (23'11")	7260 (23'10")
Digging depth	0°	mm (ft.in)	120 (4.7")	120 (4.7")	90 (3.5")	90 (3.5")
	10°	mm (ft.in)	–	–	–	–
Breakout force			164 kgf (lb)	153 kgf (lb)	164 kgf (lb)	152 kgf (lb)
Operating weight			18545 (40,880)	18655 (41,130)	18620 (41,050)	18730 (41,290)

* Bucket at carry, outside corner of bucket.

** At the end of B.O.C. or teeth

Weight and Dimension Changes

	Change in Operating Weight		Change in Tipping Load				Width Over Tire		Change in Reach		Change in Vertical Dimensions	
			Straight		Full Turn							
	kg	lb	kg	lb	kg	lb	mm	ft.in	mm	ft.in	mm	ft.in
XMINE L5 tires	+720	+1,587	+550	+1,213	+460	+1,014	+35	+1.4	–25	–1.0"	+45	+1.8"
Additional counterweight	+245	+1,455	+855	+948	+715	+838	0	0"	0	0"	0	0"
High lift boom (with add. CW)	+665	+1,466	–3275	–7,220	–2770	–6,107	0	0	+140	+9.4"	+530	+1'9"

**Performance Data
Dimensions**

WHEEL LOADERS

WA380-6 (Germany source)

Measured with 23.5 R25 (L3) tires

Bucket type			Stockpile			Heavy Duty		
			W/O teeth	With teeth	With B.O.C.	W/O teeth	With teeth	With B.O.C.
Bucket capacity	Heaped	m ³ (yd ³)	3.45 (4.51)	3.45 (4.51)	3.6 (4.71)	3.0 (3.92)	3.0 (3.92)	3.2 (3.92)
	Struck	m ³ (yd ³)	–	–	–	–	–	–
Bucket width		mm (ft.in)	2915 (9'7")	2915 (9'7")	2925 (9'7")	2915 (9'7")	2915 (9'7")	2925 (9'7")
Bucket weight		kg (lb)	1690 (3,726)	1750 (3,858)	1910 (4,211)	1680 (3704)	1740 (3,836)	1900 (4,189)
Static tipping load	Straight	kg (lb)	15025 (33,120)	14945 (32,950)	14640 (32,280)	15080 (33,250)	15000 (33,070)	14690 (32,390)
	40° full turn	kg (lb)	13355 (29,440)	13235 (29,180)	12940 (28,530)	13365 (29,460)	13290 (29,300)	12990 (28,640)
H. Dumping clearance, max. height and 45° dump angle**		mm (ft.in)	2955 (9'8")	2795 (9'2")	2880 (9'5")	3040 (10'0")	2880 (9'5")	2970 (9'9")
Reach at 2130 mm (7') clearance and 45° dump angle		mm (ft.in)	–	–	–	–	–	–
I. Reach at max. height and 45° dump angle**		mm (ft.in)	1165 (3'10")	1325 (4'4")	1200 (3'11")	1070 (3'6")	1230 (4'0")	1105 (3'8")
Reach with arm horizontal and bucket level		mm (ft.in)	–	–	–	–	–	–
J. Operating height (fully raised)		mm (ft.in)	5565 (18'3")	5565 (18'3")	5565 (18'3")	5460 (17'11")	5460 (17'11")	5460 (17'11")
K. Overall length		mm (ft.in)	8155 (26'9")	8380 (27'6")	8250 (27'1")	8030 (26'4")	8255 (27'1")	8125 (26'8")
Turning radius		mm (ft.in)	7200 (23'7")	7265 (23'10")	7230 (23'9")	7170 (23'6")	7230 (23'9")	7195 (23'7")
M. Digging depth	0°	mm (ft.in)	80 (3.1")	80 (3.1")	110 (4.3")	85 (3.3")	85 (3.3")	115 (4.5")
	10°	mm (ft.in)	–	–	–	–	–	–
Breakout force		kN kgf (lb)	165 16830 (37,100)	165 16830 (37,100)	155 15810 (34,850)	184 18770 (41,380)	184 18770 (41,380)	172 17540 (38,670)
Operating weight		kg (lb)	17840 (39,330)	17890 (39,440)	18060 (39,820)	17830 (39,310)	17890 (39,440)	18050 (39,790)

Measured with 23.5 R25 (L3) tires

Bucket type			Universal (Quick Coupler mount***)			Universal (High-lift)
			W/O teeth	With teeth	With B.O.C.	W/O teeth
Bucket capacity	Heaped	m ³ (yd ³)	3.1 (4.05)	3.1 (4.05)	3.25 (4.25)	3.1 (4.05)
	Struck	m ³ (yd ³)	–	–	–	–
Bucket width		mm (ft.in)	2160 (7'1")	2160 (7'1")	2160 (7'1")	2160 (7'1")
Bucket weight		kg (lb)	1280 (2,820)	1360 (3,000)	1500 (3,310)	1420 (3,130)
Static tipping load	Straight	kg (lb)	14470 (31,900)	14355 (31,650)	14090 (31,060)	11560 (25,490)
	40° full turn	kg (lb)	12815 (28,250)	12700 (28,000)	12445 (27,440)	10200 (22,490)
H. Dumping clearance, max. height and 45° dump angle**		mm (ft.in)	2850 (9'4")	2690 (8'10")	2775 (9'1")	3520 (11'7")
Reach at 2130 mm (7') clearance and 45° dump angle		mm (ft.in)	–	–	–	–
I. Reach at max. height and 45° dump angle**		mm (ft.in)	1310 (4'4")	1470 (4'10")	1340 (4'5")	1215 (4'0")
Reach with arm horizontal and bucket level		mm (ft.in)	–	–	–	–
J. Operating height (fully raised)		mm (ft.in)	5640 (18'6")	5640 (18'6")	5640 (18'6")	6000 (19'8")
K. Overall length		mm (ft.in)	8305 (27'3")	8530 (28'0")	8405 (27'7")	8700 (28'7")
Turning radius		mm (ft.in)	7240 (23'9")	7305 (24'0")	7270 (23'10")	7810 (25'7")
M. Digging depth	0°	mm (ft.in)	50 (2.0")	50 (2.0")	80 (3.1")	135 (5.3")
	10°	mm (ft.in)	–	–	–	–
Breakout force		kN kgf (lb)	145 14790 (32,610)	145 14790 (32,610)	137 13970 (30,800)	163 16630 (36,660)
Operating weight		kg (lb)	17940 (39,550)	18020 (39,730)	18160 (40,040)	17910 (39,480)

* Bucket at carry, outside corner of bucket.

** At the end of tooth or B.O.C.

*** Market compatible

Performance Data Dimensions

WHEEL LOADERS

WA380-6 (Germany source)

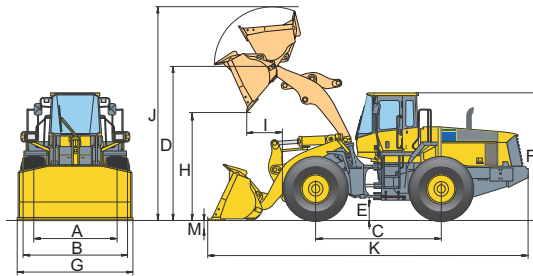

	Unit: mm (ft.in)
A Tread	2160 (7'1")
B Width over tires	2765 (9'1")
C Wheelbase	3300 (10'10")
D Hinge pin height, max. height	4095 (13'5")
E Ground clearance	450 (1'6")
F Overall height, ROPS cab	3390 (11'1")
Turning radius at corner of tire	6660 (21'10")

Measured with 23.5 R25 (L3) tires

Bucket type			Universal			Earthmoving		
			W/O teeth	With teeth	With B.O.C.	W/O teeth	With teeth	With B.O.C.
Bucket capacity	Heaped	m ³ (yd ³)	3.1 (4.05)	3.1 (4.05)	3.25 (4.25)	3.1 (4.05)	3.1 (4.05)	3.25 (4.25)
	Struck	m ³ (yd ³)	–	–	–	–	–	–
Bucket width		mm (ft.in)	2915 (9'7")	2915 (9'7")	2925 (9'7")	2915 (9'7")	2915 (9'7")	2925 (9'7")
Bucket weight		kg (lb)	1420 (3,130)	1480 (3,263)	1640 (3,615)	1540 (3,395)	1600 (3,527)	1725 (3,803)
Static tipping load	Straight	kg (lb)	15300 (33,730)	15200 (33,510)	14905 (32,860)	15165 (33,430)	15085 (33,260)	14805 (32,640)
	40° full turn	kg (lb)	13595 (29,970)	13515 (29,800)	13210 (29,120)	13455 (29,660)	13380 (29,500)	13110 (28,900)
H. Dumping clearance, max. height and 45° dump angle**		mm (ft.in)	3040 (10'0")	2880 (9'5")	2970 (9'9")	2850 (9'4")	2690 (8'10")	2775 (9'1")
Reach at 2130 mm (7') clearance and 45° dump angle		mm (ft.in)	–	–	–	–	–	–
I. Reach at max. height and 45° dump angle**		mm (ft.in)	1070 (3'6")	1230 (4'0")	1105 (3'8")	1310 (4'4")	1470 (4'10")	1340 (4'5")
Reach with arm horizontal and bucket level		mm (ft.in)	–	–	–	–	–	–
J. Operating height (fully raised)		mm (ft.in)	5460 (17'11")	5460 (17'11")	5460 (17'11")	5640 (18'6")	5640 (18'6")	5640 (18'6")
K. Overall length		mm (ft.in)	8030 (26'4")	8255 (27'1")	8125 (26'8")	8305 (27'3")	8530 (28'0")	8405 (27'7")
Turning radius		mm (ft.in)	7170 (23'6")	7230 (23'9")	7195 (23'7")	7240 (23'9")	7305 (24'0")	7270 (23'10")
M. Digging depth	0°	mm (ft.in)	85 (3.3")	85 (3.3")	115 (4.5")	50 (2.0")	50 (2.0")	80 (3.1")
	10°	mm (ft.in)	–	–	–	–	–	–
Breakout force	kN		184	184	174	145	145	137
	kgf (lb)		18770 (41,380)	18770 (41,380)	17750 (39,130)	14790 (32,600)	14790 (32,600)	13970 (30,800)
Operating weight		kg (lb)	17830 (39,310)	17890 (39,440)	18050 (39,790)	17940 (39,550)	18020 (39,730)	18160 (40,040)

* Bucket at carry, outside corner of bucket.

** At the end of tooth or B.O.C.

Weight Changes

	Change in Operating Weight		Change in Tipping Load				Width Over Tire		Ground Clearance		Change in Vertical Dimensions	
			Straight		Full Turn							
	kg	lb	kg	lb	kg	lb	mm	ft.in	mm	ft.in	mm	ft.in
23.5 R25 XMINE D2 (L5)	+720	+1,585	+550	+1,210	+500	+1,100	+35	+1.4"	+45	+1.8"	+45	+1.8"
Install additional counterweight (rear)	+325	+715	+840	+1,850	+730	+1610	+140	+5.5"				
Install additional counterweight (rear + sides)	+525	+1,155	+1250	+2,755	+1100	+2,425	+140	+5.5"				

Performance Data Dimensions

WHEEL LOADERS

WA430-6 (Germany source)

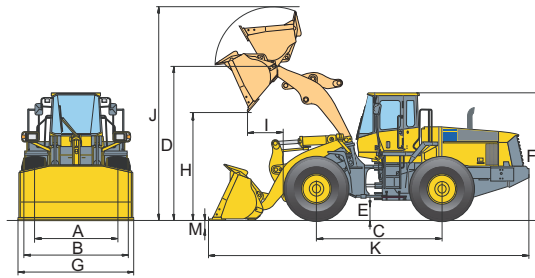

Unit: mm (ft.in)

A Tread	2280 (7'6")
B Width over tires	2885 (9'6")
C Wheelbase	3300 (10'10")
D Hinge pin height, max. height	4155 (13'8")
E Ground clearance	450 (1'6")
F Overall height, ROPS cab	3390 (11'1")
G Turning radius at corner of tire	6720 (22'1")

Measured with 23.5 R25 tires

Bucket type			Universal				
			With teeth	With B.O.C.	W/O teeth	With teeth	With B.O.C.
Bucket capacity	Heaped	m ³ (yd ³)	3.3 (4.3)	3.45 (4.5)	3.6 (4.7)	3.6 (4.7)	3.75 (4.9)
	Struck	m ³ (yd ³)	–	–	–	–	–
G. Bucket width		mm (ft.in)	2990 (9'10")	3000 (9'10")	2990 (9'10")	2990 (9'10")	3000 (9'10")
Bucket weight		kg (lb)	1750 (3,860)	1800 (3,970)	1607 (3,540)	1763 (3,890)	1833 (4,040)
Static tipping load	Straight	kg (lb)	14765 (32,550)	14630 (32,250)	14940 (32,940)	14725 (32,460)	14550 (3,210)
	40° full turn	kg (lb)	13215 (29,130)	13085 (28,850)	13390 (29,520)	13175 (29,050)	13010 (28,680)
H. Dumping clearance, max. height and 45° dump angle**		mm (ft.in)	2815 (9'3")	2935 (9'8")	2980 (9'9")	2795 (9'2")	2905 (9'6")
Reach at 2130 mm (7') clearance and 45° dump angle		mm (ft.in)	–	–	–	–	–
I. Reach at max. height and 45° dump angle**		mm (ft.in)	1340 (4'5")	1180 (3'10")	1180 (3'10")	1365 (4'6")	1210 (4'0")
Reach with arm horizontal and bucket level		mm (ft.in)	–	–	–	–	–
J. Operating height (fully raised)		mm (ft.in)	5555 (18'3")	5555 (18'3")	5670 (18'7")	5670 (18'7")	5670 (18'7")
K. Overall length		mm (ft.in)	8690 (28'6")	8515 (27'11")	8460 (27'9")	8735 (28'8")	8560 (28'1")
Turning radius		mm (ft.in)	7360 (24'2")	7315 (24'0")	7295 (23'11")	7370 (24'2")	7330 (24'1")
M. Digging depth	0°	mm (ft.in)	160 (6.3")	190 (7.5")	160 (6.3")	160 (6.3)	190 (7.5")
	10°	mm (ft.in)	–	–	–	–	–
Breakout force		kN	164	154	159	159	149
		kgf (lb)	16730 (36,880)	15710 (34,630)	16220 (35,760)	16220 (35,760)	15200 (33,510)
Operating weight		kg (lb)	19100 (42,110)	19145 (42,210)	18955 (41,790)	19120 (42,150)	19180 (42,280)

* Bucket at carry, outside corner of bucket.

** At the end of tooth or B.O.C.

Weight Changes

	Change in Operating Weight		Change in Tipping Load				Width Over Tire		Overall length		Change in Vertical Dimensions		Change in Reach	
			Straight		Full Turn									
	kg	lb	kg	lb	kg	lb	mm	ft.in	mm	ft.in	mm	ft.in	mm	ft.in
23.5 R25 XLD D1A L4	+570	+1,257	+425	+937	+385	+849	+40	+1.6"	–	–	+35	+1.4"	-28	-1.1"
23.5 R25 XMINE D2 L5	+720	+1,587	+535	+1,179	+485	+1,069	+35	+1.4"	–	–	+45	+1.8"	-25	-1.0"
26.5 R25 XHA L3	+325	+716	+815	+1,797	+710	+1,565	–	–	+140	+5.5"	–	–	–	–
Additional counterweight (rear)	+600	+1,323	+445	+981	+405	+893	-10	-0.4"						
Additional counterweight (rear + side)	+815		+1670	+3,682	+1475	+3,252	–	–	+140	+5.5"	–	–	–	–

**Performance Data
Dimensions**

WHEEL LOADERS

WA430-6 (Germany source)

Measured with 23.5 R25 tires

Bucket type			Stockpile					
			W/O teeth	With teeth	With B.O.C.	W/O teeth	With teeth	With B.O.C.
Bucket capacity	Heaped	m ³ (yd ³)	3.6 (4.7)	3.6 (4.7)	3.75 (4.9)	4.0 (5.2)	4.0 (5.2)	4.2 (5.5)
	Struck	m ³ (yd ³)	–	–	–	–	–	–
G. Bucket width		mm (ft.in)	2990 (9'10")	2990 (9'10")	3000 (9'10")	2990 (9'10")	2990 (9'10")	3000 (9'10")
Bucket weight		kg (lb)	1735 (3,820)	1902 (4,190)	1962 (4,325)	1902 (4,190)	2068 (4,560)	2124 (4,680)
Static tipping load	Straight	kg (lb)	14645 (32,290)	14425 (31,800)	14255 (31,430)	14545 (47,720)	14325 (31,580)	14155 (31,210)
	40° full turn	kg (lb)	13110 (28,900)	12890 (28,420)	12725 (28,050)	13005 (28,670)	12785 (28,190)	12625 (27,830)
H. Dumping clearance, max. height and 45° dump angle**		mm (ft.in)	2960 (9'9")	2775 (9'1")	2885 (9'6")	2920 (9'7")	2735 (9'0")	2845 (9'4")
Reach at 2130 mm (7') clearance and 45° dump angle		mm (ft.in)	–	–	–	–	–	–
I. Reach at max. height and 45° dump angle**		mm (ft.in)	1195 (3'11")	1380 (4'6")	1330 (4'4")	1235 (4'1")	1420 (4'8")	1265 (4'2")
Reach with arm horizontal and bucket level		mm (ft.in)	–	–	–	–	–	–
J. Operating height (fully raised)		mm (ft.in)	5535 (18'2")	5535 (18'2")	5535 (18'2")	5770 (18'11")	5770 (18'11")	5770 (18'11")
K. Overall length		mm (ft.in)	8485 (27'10")	8760 (28'9")	8585 (28'2")	8540 (28'0")	8815 (28'11")	8640 (28'4")
Turning radius*		mm (ft.in)	7305 (24'2")	7380 (24'3")	7340 (24'1")	7320 (24'0")	7395 (24'3")	7355 (24'2")
M. Digging depth	0°	mm (ft.in)	160 (6.3")	160 (6.3")	190 (7.5")	160 (6.3")	160 (6.3")	190 (7.5")
	10°	mm (ft.in)	–	–	–	–	–	–
Breakout force	kN		155	155	146	149	149	141
	kgf (lb)		15810 (34,850)	15810 (34,850)	14890 (32,830)	15200 (33,510)	15200 (33,510)	14380 (31,700)
Operating weight		kg (lb)	19080 (42,060)	19250 (42,440)	19310 (42,570)	19250 (42,440)	19415 (42,800)	19470 (42,920)

Bucket type			Earthmoving		Heavy Duty		Universal (High-lift)***
			With teeth	With B.O.C.	With teeth	With B.O.C.	W/O teeth
Bucket capacity	Heaped	m ³ (yd ³)	3.4 (4.4)	3.55 (4.6)	3.4 (4.4)	3.5 (4.6)	3.3 (4.3)
	Struck	m ³ (yd ³)	–	–	–	–	–
G. Bucket width		mm (ft.in)	2990 (9'10")	3000 (9'10")	2990 (9'10")	3000 (9'10")	2990 (9'10")
Bucket weight		kg (lb)	1748 (3,850)	1808 (3,990)	1980 (4,370)	2040 (4,500)	1580 (3,480)
Static tipping load	Straight	kg (lb)	14660 (32,320)	14475 (31,910)	14415 (31,780)	14235 (31,380)	13135 (28,960)
	40° full turn	kg (lb)	13115 (43,030)	12945 (28,540)	12870 (28,370)	12700 (28,000)	11700 (25,890)
H. Dumping clearance, max. height and 45° dump angle**		mm (ft.in)	2810 (9'3")	2920 (9'7")	2825 (9'3")	2935 (9'8")	3500 (11'6")
Reach at 2130 mm (7') clearance and 45° dump angle		mm (ft.in)	–	–	–	–	–
I. Reach at max. height and 45° dump angle**		mm (ft.in)	1345 (4'5")	1195 (3'11")	1335 (4'5")	1180 (3'10")	1255 (4'1")
Reach with arm horizontal and bucket level		mm (ft.in)	–	–	–	–	–
J. Operating height (fully raised)		mm (ft.in)	5535 (18'2")	5535 (18'2")	5535 (18'2")	5535 (18'2")	6045 (19'10")
K. Overall length		mm (ft.in)	8710 (28'7")	8535 (28'0")	8690 (28'6")	8515 (27'11")	8950 (29'4")
Turning radius		mm (ft.in)	7365 (24'2")	7325 (24'0")	7360 (24'2")	7315 (24'0")	7500 (24'7")
M. Digging depth	0°	mm (ft.in)	160 (6.3")	190 (7.5")	160 (6.3")	190 (7.5")	205 (8'1")
	10°	mm (ft.in)	–	–	–	–	–
Breakout force	kN		162	152	164	154	157
	kgf (lb)		16520 (36,420)	15500 (34,170)	16720 (36,860)	15710 (34,630)	16010 (35,300)
Operating weight		kg (lb)	19005 (41,900)	19155 (42,230)	19325 (42,600)	19390 (42,750)	20010 (44,110)

* Bucket at carry, outside corner of bucket.

** At the end of tooth or B.O.C.

*** Market compatible

Performance Data Dimensions

WHEEL LOADERS

WA470-6 (Germany source)

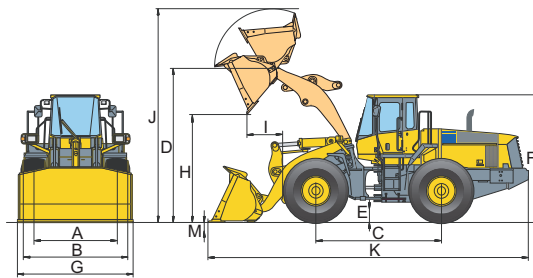

	Unit: mm (ft.in)
A Tread	2300 (7'7")
B Width over tires	2975 (9'9")
C Wheelbase	3450 (11'4")
D Hinge pin height, max. height	4335 (14'3")
E Ground clearance	505 (1'8")
F Overall height, ROPS cab	3470 (11'5")
Turning radius at corner of tire	6990 (22'11")

Measured with 23.5 R25 tires

Bucket type			Universal				
			With teeth	With B.O.C.	W/O teeth	With teeth	With B.O.C.
Bucket capacity	Heaped	m ³ (yd ³)	4.1 (5.4)	4.25 (5.56)	4.5 (5.9)	4.5 (5.9)	4.65 (6.1)
	Struck	m ³ (yd ³)	–	–	–	–	–
G. Bucket width		mm (ft.in)	2995 (9'10")	3000 (9'10")	3160 (10'4")	3165 (10'5")	3170 (10'5")
Bucket weight		kg (lb)	2015 (4,440)	2090 (4,610)	1923 (4,240)	2085 (4,600)	2162 (4,770)
Static tipping load	Straight	kg (lb)	18505 (40,800)	18275 (40,290)	18650 (41,120)	18430 (40,630)	18180 (40,080)
	37° full turn	kg (lb)	16510 (36,400)	16300 (35,930)	16660 (36,730)	16440 (36,240)	16200 (35,710)
H. Dumping clearance, max. height and 45° dump angle**		mm (ft.in)	2900 (9'6")	3010 (9'11")	3085 (10'1")	2900 (9'6")	3010 (9'11")
Reach at 2130 mm (7') clearance and 45° dump angle		mm (ft.in)	–	–	–	–	–
I. Reach at max. height and 45° dump angle**		mm (ft.in)	1465 (4'10")	1315 (4'4")	1280 (4'2")	1465 (4'10")	1315 (4'4")
Reach with arm horizontal and bucket level		mm (ft.in)	–	–	–	–	–
J. Operating height (fully raised)		mm (ft.in)	5975 (19'7")	5975 (19'7")	5975 (19'7")	5975 (19'7")	5975 (19'7")
K. Overall length		mm (ft.in)	9230 (30'3")	9070 (29'9")	8970 (29'5")	9230 (30'3")	9070 (29'9")
Turning radius*		mm (ft.in)	7670 (25'2")	7625 (25'0")	7665 (25'2")	7745 (25'5")	7700 (25'3")
M. Digging depth	0°	mm (ft.in)	125 (4.9")	155 (6.1")	125 (4.9")	125 (4.9")	155 (6.1")
	10°	mm (ft.in)	–	–	–	–	–
Breakout force		kN kgf (lb)	194 19790 (43,630)	183 18670 (41,160)	194 19790 (43,630)	193 19690 (43,410)	183 18670 (41,160)
Operating weight		kg (lb)	23060 (50,840)	23140 (51,010)	22970 (50,640)	23130 (50,990)	23210 (51,170)

* Bucket at carry, outside corner of bucket.

** At the end of tooth or B.O.C.

Weight Changes

	Change in Operating Weight		Change in Tipping Load				Width Over Tire		Overall length		Change in Vertical Dimensions		Change in Reach	
			Straight		Full Turn									
	kg	lb	kg	lb	kg	lb	mm	ft.in	mm	ft.in	mm	ft.in	mm	ft.in
26.5 R25 XLD D1A L4	+392	+864	+294	+848	+265	+584	+17	+0.7"	–	–	+35	+1.4"	-35	-1.4"
26.5 R25 XMINE D2 L5	+1124	+2,478	+840	+1,852	+760	+1,675	+45	+1.8"	–	–	+45	+1.8"	-29	-1.1"
Additional counterweight (rear)	+400	+882	+1020	+2,249	+890	+1,962	–	–	+165	+6.5"	–	–	–	–
Heavy counterweight (rear)	+1085	+2,392	+2620	+5,776	+2290	+5,049	–	–	+165	+6.5"	–	–	–	–

**Performance Data
Dimensions**

WHEEL LOADERS

WA470-6 (Germany source)

Measured with 26.5 R25 tires

Bucket type			Earthmoving		Light material	Stockpile		
			With teeth	With B.O.C.	With B.O.C.	W/O teeth	With teeth	With B.O.C.
Bucket capacity	Heaped	m ³ (yd ³)	4.2 (5.5)	4.35 (5.7)	6.0 (7.8)	4.6 (6.0)	4.6 (6.0)	4.9 (6.4)
	Struck	m ³ (yd ³)	–	–	–	–	–	–
G. Bucket width		mm (ft.in)	2995 (9'10")	3000 (9'10")	3250 (10'8")	2990 (9'10")	2995 (9'10")	3170 (10'5")
Bucket weight		kg (lb)	2187 (4,820)	2257 (4,980)	2305 (5,080)	2267 (5,000)	2422 (5,340)	2543 (5,610)
Static tipping load	Straight	kg (lb)	18285 (40,310)	18035 (39,760)	18490 (40,760)	18165 (40,050)	17950 (39,570)	17730 (39,090)
	37° full turn	kg (lb)	16300 (35,930)	16060 (35,410)	16465 (36,300)	18180 (40,080)	15970 (35,210)	15760 (34,740)
H. Dumping clearance, max. height and 45° dump angle**		mm (ft.in)	2885 (9'6")	2995 (9'10")	2935 (9'8")	3015 (9'11")	2835 (9'4")	2970 (9'9")
Reach at 2130 mm (7') clearance and 45° dump angle		mm (ft.in)	–	–	–	–	–	–
I. Reach at max. height and 45° dump angle**		mm (ft.in)	1480 (4'10")	1330 (4'4")	1460 (4'9")	1350 (4'5")	1535 (5'0")	1355 (4'5")
Reach with arm horizontal and bucket level		mm (ft.in)	–	–	–	–	–	–
J. Operating height (fully raised)		mm (ft.in)	5950 (19'6")	5950 (19'6")	6265 (20'7")	5980 (19'7")	5980 (19'7")	5980 (19'7")
K. Overall length		mm (ft.in)	9250 (30'4")	9090 (29'10")	9190 (30'2")	9065 (29'9")	9325 (30'7")	9130 (29'11")
Turning radius*		mm (ft.in)	7675 (25'2")	7630 (25'0")	7765 (25'6")	7615 (25'0")	7695 (25'3")	7645 (25'1")
M. Digging depth	0°	mm (ft.in)	125 (4.9")	155 (6.1")	105 (4.1")	125 (4.9")	125 (4.9")	155 (6.1")
	10°	mm (ft.in)	–	–	–	–	–	–
Breakout force		kN kgf (lb)	192 19580 (43,170)	181 18460 (40,700)	167 17030 (37,540)	182 18560 (40,920)	182 18560 (40,920)	176 17950 (39,570)
Operating weight		kg (lb)	23235 (51,220)	23305 (51,380)	23350 (51,480)	23315 (51,400)	23470 (51,740)	23590 (52,010)

Bucket type			Heavy Duty		Universal (High-lift)
			With teeth	With teeth	W/O teeth
Bucket capacity	Heaped	m ³ (yd ³)	4.1 (5.4)	4.25 (5.56)	4.1 (5.4)
	Struck	m ³ (yd ³)	–	–	–
Bucket width		mm (ft.in)	2995 (9'10")	3000 (9'10")	2990 (9'10")
Bucket weight		kg (lb)	2388 (5,260)	2450 (5,400)	1865 (4,110)
Static tipping load	Straight	kg (lb)	18055 (39,800)	17835 (39,320)	16410 (36,180)
	37° full turn	kg (lb)	16060 (35,410)	15860 (34,960)	14520 (32,010)
H. Dumping clearance, max. height and 45° dump angle**		mm (ft.in)	2905 (9'6")	3015 (9'11")	3600 (11'10")
Reach at 2130 mm (7') clearance and 45° dump angle		mm (ft.in)	–	–	–
I. Reach at max. height and 45° dump angle**		mm (ft.in)	1460 (4'9")	1310 (4'4")	1455 (4'9")
Reach with arm horizontal and bucket level		mm (ft.in)	–	–	–
J. Operating height (fully raised)		mm (ft.in)	5950 (19'6")	5950 (19'6")	6485 (21'3")
K. Overall length		mm (ft.in)	9225 (30'3")	9065 (29'9")	9740 (31'11")
Turning radius*		mm (ft.in)	7665 (25'2")	7625 (5'4")	7830 (25'8")
M. Digging depth	0°	mm (ft.in)	125 (4.9")	155 (6.1")	265 (10.4")
	10°	mm (ft.in)	–	–	–
Breakout force		kN kgf (lb)	195 19890 (43,850)	184 18770 (41,380)	189 19280 (42,500)
Operating weight		kg (lb)	23435 (51,660)	23500 (51,810)	24290 (53,550)

* Bucket at carry, outside corner of bucket.

** At the end of tooth or B.O.C.

Performance Data Dimensions

WHEEL LOADERS

WA480-6 (Germany source)

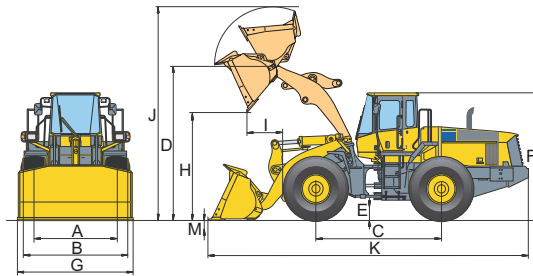

Unit: mm (ft.in)

A Tread	2300 (7'7")
B Width over tires	2975 (9'9")
C Wheelbase	3450 (11'4")
D Hinge pin height, max. height	4483 (14'9")
E Ground clearance	500 (1'8")
F Overall height, ROPS cab	3465 (11'4")
Turning radius at corner of tire	7000 (23'0")

Measured with 26.5 R25 tires

Bucket type			Universal			Earthmoving	
			W/O teeth	With teeth	With B.O.C.	With teeth	With B.O.C.
Bucket capacity	Heaped	m ³ (yd ³)	4.65 (6.1)	4.65 (6.1)	4.8 (6.3)	4.5 (5.9)	4.65 (6.1)
	Struck	m ³ (yd ³)	–	–	–	–	–
Bucket width		mm (ft.in)	3160 (10'4")	3165 (10'5")	3170 (10'5")	3165 (10'5")	3170 (10'5")
Bucket weight		kg (lb)	2105 (4,640)	2260 (4,980)	2345 (5,170)	2365 (5,210)	2445 (5,390)
Static tipping load	Straight	kg (lb)	21125 (46,570)	20915 (46,110)	20670 (45,570)	20705 (45,650)	20465 (45,120)
	37° full turn	kg (lb)	18740 (41,310)	18530 (40,850)	18305 (40,360)	18325 (40,440)	18100 (39,900)
H. Dumping clearance, max. height and 45° dump angle**		mm (ft.in)	3230 (10'7")	3045 (10'0")	3160 (10'4")	3032 (9'11")	3143 (10'4")
Reach at 2130 mm (7') clearance and 45° dump angle		mm (ft.in)	–	–	–	–	–
I. Reach at max. height and 45° dump angle**		mm (ft.in)	1360 (4'6")	1530 (5'0")	1375 (4'6")	1542 (5'1")	1389 (4'7")
Reach with arm horizontal and bucket level		mm (ft.in)	–	–	–	–	–
J. Operating height (fully raised)		mm (ft.in)	6170 (20'3")	6170 (20'3")	6170 (20'3")	6110 (20'1")	6110 (20'1")
K. Overall length		mm (ft.in)	9140 (30'0")	9400 (30'10")	9235 (30'4")	9420 (30'11")	9420 (30'11")
Turning radius*		mm (ft.in)	7675 (25'2")	7750 (25'5")	7710 (25'4")	7760 (25'6")	7715 (25'4")
M. Digging depth	0°	mm (ft.in)	130 (5.1")	130 (5.1")	160 (6.3")	130 (5.1")	160 (6.3")
	10°	mm (ft.in)	–	–	–	–	–
Breakout force		kN kgf (lb)	244 24890 (54,870)	244 24890 (54,870)	232 23660 (52,160)	240 24480 (53,970)	227 23150 (51,050)
Operating weight		kg (lb)	25140 (55,420)	25295 (55,770)	25380 (55,950)	25000 (55,120)	25080 (55,290)

* Bucket at carry, outside corner of bucket.

** At the end of tooth or B.O.C.

Weight Changes

	Change in Operating Weight		Change in Tipping Load				Width Over Tire		Overall length		Change in Vertical Dimensions		Change in Reach	
			Straight		Full Turn									
	kg	lb	kg	lb	kg	lb	mm	ft.in	mm	ft.in	mm	ft.in	mm	ft.in
26.5 R25 XLD D1A L4	+392	+864	+280	+617	+250	+551	+17	+0.7"	–	–	+35	+1.4"	-35	-1.4"
26.5 R25 XMINE D2 L5	+1124	+2,478	+795	+1,753	+720	+1,587	+45	+1.8"	–	–	+45	+1.8"	-29	-1.1"
Without additional counterweight (rear)	-400	-882	-1020	-2,249	-890	-1,962	–	–	-165	-6.5"	–	–	–	–

**Performance Data
Dimensions**

WHEEL LOADERS

WA480-6 (Germany source)

Measured with 26.5 R25 tires

Bucket type			Stockpile (With flat bottom)			Stockpile (With raised bottom)		
			W/O teeth	With teeth	With B.O.C.	W/O teeth	With teeth	With B.O.C.
Bucket capacity	Heaped	m ³ (yd ³)	4.9 (6.4)	4.9 (6.4)	5.0 (6.5)	4.9 (6.4)	4.9 (6.4)	5.0 (6.5)
	Struck	m ³ (yd ³)	–	–	–	–	–	–
G. Bucket width		mm (ft.in)	3160 (10'4")	3165 (10'5")	3170 (10'5")	3160 (10'4")	3165 (10'5")	3170 (10'5")
Bucket weight		kg (lb)	2335 (5,150)	2495 (5,500)	2570 (5,670)	2135 (4,710)	2295 (5,060)	2270 (5,000)
Static tipping load	Straight	kg (lb)	20735 (45,710)	20520 (45,240)	20295 (44,740)	20835 (45,930)	20620 (45,460)	20395 (44,960)
	37° full turn	kg (lb)	18365 (40,490)	18145 (40,000)	17935 (39,540)	18465 (40,710)	18245 (40,220)	18035 (39,760)
H. Dumping clearance, max. height and 45° dump angle*		mm (ft.in)	3165 (10'5")	2980 (9'9")	3090 (10'2")	3165 (10'5")	2980 (9'9")	3090 (10'2")
Reach at 2130 mm (7') clearance and 45° dump angle		mm (ft.in)	–	–	–	–	–	–
I. Reach at max. height and 45° dump angle**		mm (ft.in)	1410 (4'8")	1595 (5'3")	1440 (4'9")	1410 (4'8")	1595 (5'3")	1440 (4'9")
Reach with arm horizontal and bucket level		mm (ft.in)	–	–	–	–	–	–
J. Operating height (fully raised)		mm (ft.in)	6140 (20'2")	6140 (20'2")	6140 (20'2")	6140 (20'2")	6140 (20'2")	6140 (20'2")
K. Overall length		mm (ft.in)	9235 (30'4")	9495 (31'2")	9330 (30'7")	9235 (30'4")	9495 (31'2")	9330 (30'7")
Turning radius*		mm (ft.in)	7700 (25'3")	7780 (25'6")	7735 (25'5")	7700 (25'3")	7785 (25'6")	7735 (25'5")
M. Digging depth	0°	mm (ft.in)	130 (5.1")	130 (5.1")	160 (6.3")	130 (5.1")	130 (5.1")	160 (6.3")
	10°	mm (ft.in)	–	–	–	–	–	–
Breakout force		kN	228	228	217	228	228	217
		kgf (lb)	23260 (51,280)	23260 (51,280)	22130 (48,790)	23260 (51,270)	23260 (51,270)	22130 (48,800)
Operating weight		kg (lb)	24970 (55,050)	25130 (55,400)	25205 (55,570)	25370 (55,930)	25530 (56,280)	25605 (56,450)

Bucket type			Universal		
			W/O teeth	With teeth	With B.O.C.
Bucket capacity	Heaped	m ³ (yd ³)	4.65 (6.1)	4.65 (6.1)	4.8 (6.3)
	Struck	m ³ (yd ³)	–	–	–
G. Bucket width		mm (ft.in)	3160 (10'4")	3165 (10'5")	3170 (10'5")
Bucket weight		kg (lb)	2105 (4,640)	2260 (4,980)	2345 (5,170)
Static tipping load	Straight	kg (lb)	21125 (46,570)	20915 (46,110)	20670 (45,570)
	37° full turn	kg (lb)	18740 (41310)	18530 (40,850)	18305 (40,360)
H. Dumping clearance, max. height and 45° dump angle**		mm (ft.in)	3230 (10'7")	3045 (10'0")	3160 (10'4")
Reach at 2130 mm (7') clearance and 45° dump angle		mm (ft.in)	–	–	–
I. Reach at max. height and 45° dump angle**		mm (ft.in)	1360 (4'6")	1530 (5'0")	1375 (4'6")
Reach with arm horizontal and bucket level		mm (ft.in)	–	–	–
J. Operating height (fully raised)		mm (ft.in)	6170 (20'3")	6170 (20'3")	6170 (20'3")
K. Overall length		mm (ft.in)	9140 (30'0")	9400 (30'10")	9235 (30'4")
Turning radius*		mm (ft.in)	7675 (25'2")	7750 (25'5")	7710 (25'4")
M. Digging depth	0°	mm (ft.in)	130 (5.1")	130 (5.1")	160 (6.3")
	10°	mm (ft.in)	–	–	–
Breakout force		kN	244	244	232
		kgf (lb)	24890 (54,870)	24890 (54,870)	23660 (52,170)
Operating weight		kg (lb)	25140 (55,420)	25295 (55,770)	25380 (55,950)

* Bucket at carry, outside corner of bucket.

** At the end of tooth or B.O.C.

Performance Data Dimensions

WHEEL LOADERS

WA500-7 (for EU)

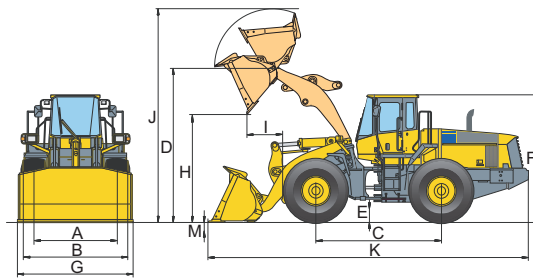

Unit: mm (ft.in)

A Tread	2400 (7'10")
B Width over tires	3150 (10'4")
C Wheelbase	3780 (12'5")
D Hinge pin height, max. height	4795 (15'9")
E Ground clearance	460 (1'6")
F Overall height, ROPS cab	3820 (12'6")
Turning radius at corner of tire	6870 (22'6")

Measured with 29.5 R25 (XLDD1A) tires

Bucket type			Universal		Rock Straight edge		Rock Spade nose	
			with Teeth	with B.O.C.	without Teeth	with B.O.C.	without Teeth	with B.O.C.
Bucket capacity	Heaped	m ³ (yd ³)	5.3 (6.9)	5.6 (7.3)	5.3 (6.9)	5.6 (7.3)	5.2 (6.8)	5.6 (7.3)
	Struck	m ³ (yd ³)	—	—	—	—	—	—
G. Bucket width		mm (ft.in)	3430 (11'3")	3440 (11'3")	3430 (11'3")	3440 (11'3")	3430 (11'3")	3440 (11'3")
Bucket weight		kg (lb)	2875 (6,338)	2915 (6,426)	3015 (6,647)	3060 (6,746)	3240 (7,143)	3280 (7,231)
Static tipping load	Straight	kg (lb)	26760 (59,000)	26530 (58,490)	26695 (58,850)	26445 (58,300)	26125 (57,600)	25965 (57,240)
	Full turn (40°)	kg (lb)	22880 (50,440)	22680 (50,000)	22810 (50,290)	22590 (49,800)	22320 (49,210)	22135 (48,800)
H. Dumping clearance, max. height and 45° dump angle**		mm (ft.in)	3265 (10'9")	3325 (10'11")	3265 (10'9")	3265 (10'9")	3265 (10'9")	3265 (10'9")
I. Reach at max. height and 45° dump angle**		mm (ft.in)	1545 (5'1")	1360 (4'6")	1545 (5'1")	1360 (4'6")	1545 (5'1")	1585 (5'2")
J. Operating height (fully raised)		mm (ft.in)	6535 (21'5")	6535 (21'5")	6715 (22'0")	6715 (22'0")	6715 (22'0")	6715 (22'0")
K. Overall length, bucket on ground		mm (ft.in)	9890 (32'5")	9680 (31'9")	9890 (32'5")	9680 (31'9")	9900 (32'6")	10000 (32'10")
Turning radius*		mm (ft.in)	7660 (25'2")	7600 (24'11")	7660 (25'2")	7600 (24'11")	7660 (25'2")	7700 (25'3")
Digging depth	0°	mm (ft.in)	95 (3.7")	125 (4.9")	95 (3.7")	125 (4.9")	120 (4.7")	125 (4.9")
	10°	mm (ft.in)	—	—	—	—	—	—
Breakout force		kN kgf (lb)	287 29265 (64,520)	273 27840 (61,380)	287 29265 (64,520)	273 27840 (61,380)	235 23960 (52,820)	225 22940 (50,570)
Operating weight		kg (lb)	35095 (77,370)	35335 (77,900)	35435 (78,120)	35480 (78,220)	35660 (78,620)	35700 (78,700)

* Bucket at carry, outside corner of bucket.

** At the end of B.O.C. or teeth

Weight and Dimension Changes

	Change in Operating Weight		Change in Tipping Load				Width over Tire		Change in Reach at 45°		Change in Dump Height at 45°		Overall Height	
			Straight		Full Turn									
	kg	lb	kg	lb	kg	lb	mm	ft.in	mm	ft.in	mm	ft.in	mm	ft.in
XHA L3 tires	-500	-1,102	-360	-794	-315	-694	-20	-0.8"	+20	+0.8"	-20	-0.8"	-20	-0.8"
XMINE L5 tires	+635	+1,400	+450	+992	+400	+882	+35	+1.4"	+5	+0.2"	+10	+0.4"	+20	+0.8"

Performance Data Dimensions

WHEEL LOADERS

WA500-7 (for UK)

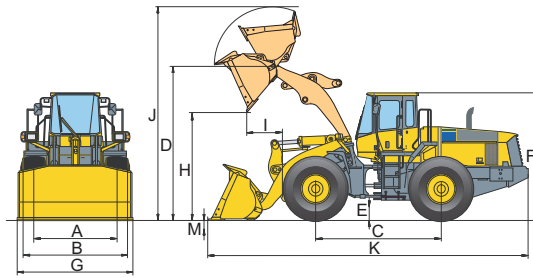

Unit: mm (ft.in)

A Tread	2400 (7'10")
B Width over tires	3150 (10'4")
C Wheelbase	3780 (12'5")
D Hinge pin height, max. height	4795 (15'9")
E Ground clearance	460 (1'6")
F Overall height, ROPS cab	3820 (12'6")
Turning radius at corner of tire	6870 (22'6")

Measured with 29.5 R25 (XLDD1A) tires

Bucket type			Stockpile				
			w/o teeth	with teeth	with B.O.C.	w/o teeth	with B.O.C.
Bucket capacity	Heaped	m ³ (yd ³)	5.6 (7.3)	5.6 (7.3)	5.9 (7.7)	6.0 (7.8)	6.3 (8.2)
	Struck	m ³ (yd ³)	–	–	–	–	–
Bucket width		mm (ft.in)	3430 (11'3")	3430 (11'3")	3440 (11'3")	3430 (11'3")	3440 (11'3")
Bucket weight		kg (lb)	2765 (6,096)	2975 (6,559)	3025 (6,669)	2870 (6,327)	3125 (6,889)
Static tipping load	Straight	kg (lb)	24805 (54,690)	24520 (54,060)	26270 (57,910)	24840 (54,760)	26060 (57,450)
	Full turn (40°)	kg (lb)	21220 (46,780)	20935 (46,150)	22440 (49,470)	21230 (46,800)	22245 (49,040)
H. Dumping clearance, max. height and 45° dump angle**		mm (ft.in)	3455 (11'4")	3235 (10'7")	3280 (10'9")	3340 (11'0")	3225 (10'7")
I. Reach at max. height and 45° dump angle**		mm (ft.in)	1360 (4'6")	1580 (5'2")	1395 (4'7")	1415 (4'8")	1445 (4'9")
J. Operating height (fully raised)		mm (ft.in)	6605 (21'8")	6605 (21'8")	6605 (21'8")	6685 (21'11")	6685 (21'11")
K. Overall length, bucket on ground		mm (ft.in)	9630 (31'7")	9940 (32'7")	9730 (31'11")	9705 (31'10")	9805 (32'2")
Turning radius*		mm (ft.in)	7590 (24'11")	7680 (25'2")	7620 (25'0")	7610 (25'0")	7640 (25'1")
Digging depth	0°	mm (ft.in)	95 (3.7")	95 (3.7")	95 (3.7")	95 (3.7")	125 (4.9")
	10°	mm (ft.in)	–	–	–	–	–
Breakout force		kN	277	277	264	264	252
		kgf (lb)	28,245 (62,270)	28,245 (62,270)	26920 (59,350)	26,920 (59,350)	25700 (56,660)
Operating weight		kg (lb)	34985 (77,130)	35195 (77,590)	35440 (78,130)	35090 (77,360)	35545 (78,360)

Bucket type			Universal (High lift)	
			with teeth	with B.O.C.
Bucket capacity	Heaped	m ³ (yd ³)	4.5 (5.9)	4.7 (6.1)
	Struck	m ³ (yd ³)	–	–
Bucket width		mm (ft.in)	3430 (11'3")	3440 (11'3")
Bucket weight		kg (lb)	2570 (6,338)	2620 (6,426)
Static tipping load	Straight	kg (lb)	21190 (46,720)	21065 (46,440)
	Full turn (40°)	kg (lb)	18030 (39,750)	17915 (39,500)
H. Dumping clearance, max. height and 45° dump angle**		mm (ft.in)	3800 (12'6")	3945 (12'11")
I. Reach at max. height and 45° dump angle**		mm (ft.in)	1545 (5'1")	1355 (4'5")
J. Operating height (fully raised)		mm (ft.in)	6795 (22'4")	6795 (22'4")
K. Overall length, bucket on ground		mm (ft.in)	10205 (33'6")	10190 (33'5")
Turning radius*		mm (ft.in)	7840 (25'9")	7780 (25'6")
Digging depth	0°	mm (ft.in)	170 (6.7")	200 (7.9")
	10°	mm (ft.in)	–	–
Breakout force		kN	320	303
		kgf (lb)	32630 (71,940)	30900 (68,120)
Operating weight		kg (lb)	35170 (77,540)	35215 (77,630)

* Bucket at carry, outside corner of bucket.

** At the end of B.O.C. or teeth

Performance Data Dimensions

WHEEL LOADERS

WA500-6 (Germany source)

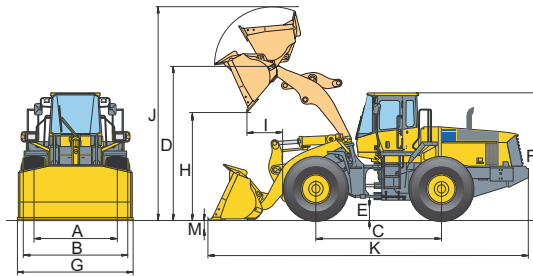

	Unit: mm (ft.in)
A Tread	2400 (7'10")
B Width over tires	3150 (10'4")
C Wheelbase	3780 (12'5")
D Hinge pin height, max. height	4770 (15'8")
E Ground clearance	460 (1'6")
F Overall height, ROPS cab	3795 (12'5")
Turning radius at corner of tire	6870 (22'6")

Measured with 29.5 R25 tires

Bucket type			Universal			Rock Straight edge	
			W/O teeth	With teeth	With B.O.C.	With teeth	With B.O.C.
Bucket capacity	Heaped	m ³ (yd ³)	5.3 (5'9")	5.3 (6.9)	5.6 (7.3)	5.2 (6.8)	5.5 (7.2)
	Struck	m ³ (yd ³)	–	–	–	–	–
G. Bucket width		mm (ft.in)	3430 (11'3")	3430 (11'3")	3440 (11'3")	3430 (11'3")	3440 (11'3")
Bucket weight		kg (lb)	2660 (5,860)	2875 (6,340)	2915 (6,430)	3015 (6,650)	3060 (6,750)
Static tipping load	Straight	kg (lb)	24000 (52,910)	23700 (52,250)	23480 (51,760)	23645 (52,130)	23400 (51,590)
	40° full turn	kg (lb)	20930 (46,140)	20640 (45,500)	20440 (45,060)	20565 (45,340)	20350 (44,860)
H. Dumping clearance, max. height and 45° dump angle**		mm (ft.in)	3460 (11'4")	3240 (10'8")	3390 (11'1")	3240 (10'8")	3390 (11'1")
Reach at 2130 mm (7') clearance and 45° dump angle		mm (ft.in)	–	–	–	–	–
I. Reach at max. height and 45° dump angle**		mm (ft.in)	1350 (4'5")	1570 (5'2")	1385 (4'7")	1570 (5'2")	1385 (4'7")
Reach with arm horizontal and bucket level		mm (ft.in)	–	–	–	–	–
J. Operating height (fully raised)		mm (ft.in)	6510 (21'4")	6510 (21'4")	6510 (21'4")	6690 (21'11")	6690 (21'11")
K. Overall length		mm (ft.in)	9580 (31'5")	9890 (32'5")	9680 (31'9")	9890 (32'5")	9680 (31'9")
Turning radius		mm (ft.in)	7570 (24'10")	7660 (25'2")	7600 (24'11")	7660 (25'2")	7600 (24'11")
M. Digging depth	0°	mm (ft.in)	120 (4.7")	120 (4.7")	150 (5.9")	120 (4.7")	150 (5.9")
	10°	mm (ft.in)	–	–	–	–	–
Breakout force	kN		274	272	259	271	258
	kgf (lb)		27950 (61,620)	27740 (61,160)	26420 (58,250)	27640 (60,940)	26320 (58,030)
Operating weight		kg (lb)	31700 (69,890)	31915 (70,360)	31955 (70,450)	32055 (70,670)	32100 (70,770)

* Bucket at carry, outside corner of bucket.

** At the end of tooth or B.O.C.

Weight Changes

	Change in Operating Weight		Change in Tipping Load				Width Over Tire		Overall length		Change in Vertical Dimensions		Change in Reach	
			Straight		Full Turn									
	kg	lb	kg	lb	kg	lb	mm	ft.in	mm	ft.in	mm	ft.in	mm	ft.in
29.5 R25 XLD D1A-L4	+500	+1,102	+360	+794	+315	+694	+20	+0.8"	–	–	+20	+0.8"	-25	-1.0"
29.5 R25 XMINE-L5	+1140	+2,513	+810	+1,786	+710	+1,565	+55	+2.2"	–	–	+30	+1.2"	-20	-0.8"
Additional counterweight	+900	+1,984	+1880	+4,145	+1580	+3,483	–	–	–	–	–	–	–	–

**Performance Data
Dimensions**

WHEEL LOADERS

WA500-6 (Germany source)

Measured with 29.5 R25 tires

Bucket type			Rock Spade nose		Stockpile		
			With teeth	With B.O.C.	W/O teeth	With teeth	With B.O.C.
Bucket capacity	Heaped	m ³ (yd ³)	5.2 (6.8)	5.5 (7.2)	5.6 (7.3)	5.6 (7.3)	5.9 (7.7)
	Struck	m ³ (yd ³)	–	–	–	–	–
G. Bucket width		mm (ft.in)	3430 (11'3")	3440 (11'3")	3430 (11'3")	3430 (11'3")	3440 (11'3")
Bucket weight		kg (lb)	3240 (7,140)	3280 (7,230)	2765 (6,100)	2975 (6,560)	3020 (6,660)
Static tipping load	Straight	kg (lb)	23080 (50,880)	22930 (50,550)	23755 (52,370)	23470 (51,740)	23245 (51,250)
	40° full turn	kg (lb)	20040 (44,180)	19900 (43,870)	20700 (45,640)	20420 (45,020)	20215 (44,570)
H. Dumping clearance, max. height and 45° dump angle*		mm (ft.in)	4770 (15'8")	4770 (15'8")	4770 (15'8")	4770 (15'8")	4770 (15'8")
Reach at 2130 mm (7') clearance and 45° dump angle		mm (ft.in)	–	–	–	–	–
I. Reach at max. height and 45° dump angle**		mm (ft.in)	1570 (5'2")	1610 (5'3")	1385 (4'7")	1605 (5'3")	1420 (4'8")
Reach with arm horizontal and bucket level		mm (ft.in)	–	–	–	–	–
J. Operating height (fully raised)		mm (ft.in)	6690 (21'11")	6690 (21'11")	6590 (21'7")	6590 (21'7")	6590 (21'7")
K. Overall length		mm (ft.in)	9900 (32'6")	10000 (32'10")	9630 (31'7")	9940 (32'7")	9730 (31'11")
Turning radius*		mm (ft.in)	7660 (25'2")	7700 (25'3")	7590 (24'11")	7680 (25'2")	7620 (25'0")
M. Digging depth	0°	mm (ft.in)	120 (4.7")	150 (5.9")	120 (4.7")	120 (4.7")	150 (5.9")
	10°	mm (ft.in)	–	–	–	–	–
Breakout force		kN kgf (lb)	220 22440 (49,470)	210 21420 (47,220)	264 26930 (59,370)	262 76720 (58,910)	249 25400 (56,000)
Operating weight		kg (lb)	32280 (71,160)	32320 (71,250)	31800 (70,110)	32010 (70,570)	32055 (70,670)

Bucket type			Stockpile		Universal (High-lift)	
			W/O teeth	With B.O.C.	With teeth	With B.O.C.
Bucket capacity	Heaped	m ³ (yd ³)	6.0 (7.85)	6.3 (8.24)	4.5 (5.9)	4.7 (6.15)
	Struck	m ³ (yd ³)	–	–	–	–
G. Bucket width		mm (ft.in)	3430 (11'3")	3440 (11'3")	3430 (11'3")	3440 (11'3")
Bucket weight		kg (lb)	2870 (6,330)	3125 (6,890)	2570 (5,670)	2620 (5,780)
Static tipping load	Straight	kg (lb)	23540 (51,900)	23015 (50,740)	20200 (44,530)	20080 (44,270)
	40° full turn	kg (lb)	20500 (45,190)	20000 (44,090)	17510 (38,600)	17400 (38,360)
H. Dumping clearance, max. height and 45° dump angle**		mm (ft.in)	3375 (11'1")	3300 (10'10")	3775 (12'5")	3920 (12'10")
Reach at 2130 mm (7') clearance and 45° dump angle		mm (ft.in)	–	–	–	–
I. Reach at max. height and 45° dump angle**		mm (ft.in)	1440 (4'9")	1470 (4'10")	1570 (5'2")	1380 (4'6")
Reach with arm horizontal and bucket level		mm (ft.in)	–	–	–	–
J. Operating height (fully raised)		mm (ft.in)	6660 (21'10")	6660 (21'10")	6770 (22'3")	6770 (22'3")
K. Overall length		mm (ft.in)	9705 (31'10")	9805 (32'2")	10205 (33'6")	10190 (33'5")
Turning radius*		mm (ft.in)	7610 (25'0")	7640 (25'0")	7840 (25'9")	7780 (25'6")
M. Digging depth	0°	mm (ft.in)	120 (4.7")	150 (5.9")	195 (7.7")	225 (8.9")
	10°	mm (ft.in)	–	–	–	–
Breakout force		kN kgf (lb)	250 25500 (56,220)	237 24170 (53,290)	307 31310 (69,030)	290 29580 (65,210)
Operating weight		kg (lb)	31910 (70,350)	31165 (68,710)	31760 (70,020)	31810 (70,130)

* Bucket at carry, outside corner of bucket.

** At the end of tooth or B.O.C.

Performance Data Dimensions

WHEEL LOADERS

WA320-5 (China source)

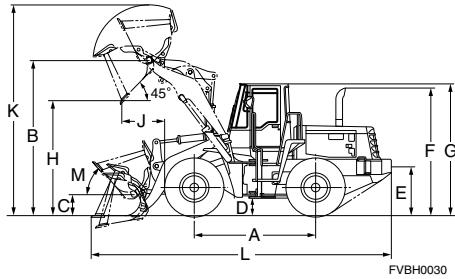

	Unit: mm
Tread	2050
Width over tires	2585
A Wheelbase	3030
B Hinge pin height, max. height	4235
C Hinge pin height, carry position	
D Ground clearance	425
E Hitch height	
F Overall height, top of the stack	2775
G Overall height, ROPS cab	3200
M Tilt back angle	49°

Measured with 20.5-25-16PR (L3) tires

Bucket type			Standard Boom		Semi High Lift Boom		High Lift Boom
			General Purpose Buckets		Excavating Buckets		Light Material Bucket
			Teeth	Bolt-on Cutting Edge	Teeth + Segment	Bolt-on Cutting Edge	Bolt-on Cutting Edge
Bucket capacity	Heaped	m ³	2.6	2.8	2.7	2.7	3.2
	Struck	m ³	2.2	2.4	2.3	2.3	2.8
Bucket width		mm	2760	2740	2760	2740	2740
Bucket weight		kg	–	–	–	–	–
Static tipping load	Straight	kg	11490	11350	9940	9965	9030
	Full turn (40°)	kg	10,110	9,965	8695	8715	7935
H. Dumping clearance, max. height and 45° dump angle**		mm	2755	2850	3100	3200	3355
J. Reach at max. height and 45° dump angle**		mm	1110	1030	1100	1020	1185
K. Operating height (fully raised)		mm	5320	5320	5615	5615	5415
L. Overall length, bucket on ground		mm	7580	7455	7875	7750	7645
Turning radius*		mm	–	–	6295	–	–
Digging depth	0°	mm	46	32	46	32	85
	10°	mm	330	295	325	290	322
Breakout force		kN	126	126	136.5	136.5	96.6
		kgf	12850	12850	13920	13920	9850
Operating weight		kg	13480	13590	13995	13980	14530

* Bucket at carry, outside corner of bucket.

** At the end of B.O.C. or teeth

- All dimensions, weights, and performance values based on SAE J732c and J742b standards.
- Static tipping load and operating weight shown include lubricant, coolant, full fuel tank, ROPS cab and operator.
- Machine stability and operating weight affected by counterweight, tire size, and other attachments.

Performance Data Dimensions

WHEEL LOADERS

WA380-6 (China source)

Unit: mm

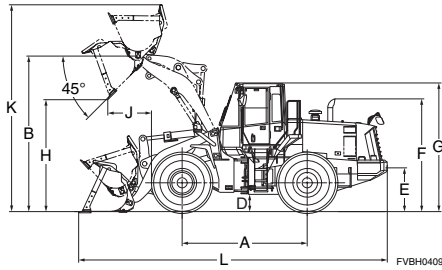

Tread	2160
Width over tires	2780
A Wheelbase	3300
B Hinge pin height, max. height	4095
C Hinge pin height, carry position	520
D Ground clearance	455
E Hitch height	1150
F Overall height, top of the stack	2975
G Overall height, ROPS cab	3395
M Tilt back angle	50°

Measured with 23.5-25-16PR (L3) tires

Bucket type			General Purpose Buckets			Excavating Buckets			Light Material Bucket
			Bolt-on Cutting Edge	Teeth and Segment	Teeth	Bolt-on Cutting Edge	Teeth and Segment	Teeth	Bolt-on Cutting Edge
Bucket capacity	Heaped	m ³	3.3	3.3	3.1	2.9	2.9	2.7	4.0
	Struck	m ³	2.9	2.9	2.7	2.4	2.4	2.3	3.4
Bucket width		mm	2905	2915	2915	2905	2915	2915	2905
Bucket weight		kg	1620	1665	1540	1720	1765	1645	1835
Static tipping load	Straight	kg	14790	14630	14940	14710	14670	14850	14450
	Full turn (40°)	kg	13030	12990	13170	12950	12900	13080	12700
H. Dumping clearance, max. height and 45° dump angle**		mm	2945	2820	2820	3045	2920	2920	2855
J. Reach at max. height and 45° dump angle**		mm	1150	1245	1245	1050	1150	1150	1240
K. Operating height (fully raised)		mm	5590	5590	5590	5485	5485	5485	5735
L. Overall length, bucket on ground		mm	8140	8300	8300	8000	8160	8160	8265
Turning radius*		mm	7220	7270	7270	7150	7230	7230	7250
Digging depth	0°	mm	60	75	75	60	75	75	60
	10°	mm	290	335	335	265	310	310	315
Breakout force		kN	158	162	170	178	183	193	144
		kgf	16100	16500	17400	18100	18600	19700	14700
Operating weight		kg	17570	17610	17500	17710	17750	17640	17830

* Bucket at carry, outside corner of bucket.

** At the end of B.O.C. or teeth

- All dimensions, weights, and performance values based on SAE J732c and J742b standards.
- Static tipping load and operating weight shown include lubricant, coolant, full fuel tank, ROPS cab and operator.
- Machine stability and operating weight affected by counterweight, tire size, and other attachments.

Weight Changes

	Change in Operating Weight	Change in Tipping Load		Width Over Tire	Ground Clearance	Change in Vertical Dimensions
		Straight	Full Turn			
	kg	kg	kg	mm	mm	mm
20.5-25-16PR (L3)	-970	-770	-680	2695	390	-65
Install additional counterweight	+340	+900	+755			

Performance Data Dimensions

WHEEL LOADERS

WA380Z-6 (China source)

Unit: mm

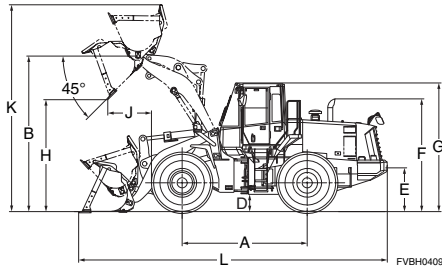

Tread	2160
Width over tires	2780
A Wheelbase	3300
B Hinge pin height, max. height	4095
C Hinge pin height, carry position	520
D Ground clearance	455
E Hitch height	1150
F Overall height, top of the stack	2975
G Overall height, ROPS cab	3395
M Tilt back angle	50°

Measured with 23.5-25-16PR (L3) tires

Bucket type			Standard Boom			Semi High Lift Boom				
			General Purpose Buckets			Excavating Buckets			Light Material Buckets	
			Teeth	Teeth and Segment	Bolt-on Cutting Edge	Teeth	Teeth and Segment	Bolt-on Cutting Edge	Teeth	Bolt-on Cutting Edge
Bucket capacity	Heaped	m ³	3.1	3.3	3.3	2.8	3.0	3.0	3.6	3.8
	Struck	m ³	2.7	2.9	2.9	2.4	2.6	2.6	3.2	3.4
Bucket width		mm	2915	2915	2905	2915	2915	2905	2915	2905
Bucket weight		kg	1540	1665	1620	1480	1585	1560	1730	1810
Static tipping load	Straight	kg	14480	14290	14320	13130	12950	12970	12790	12650
	40° full turn	kg	12540	12370	12400	11200	11060	11070	10920	10790
H. Dumping clearance, max. height and 45° dump angle**		mm	2820	2820	2945	3100	3100	3225	2925	3045
J. Reach at max. height and 45° dump angle**		mm	1245	1245	1150	1170	1170	1075	1350	1250
K. Operating height (fully raised)		mm	5600	5600	5600	5680	5680	5680	5910	5910
L. Overall length, bucket on ground		mm	8300	8300	8140	8360	8360	8205	8610	8455
Turning radius*		mm	7265	7265	7215	7315	7315	7245	7390	7320
M. Digging depth	0°	mm	75	75	60	75	75	60	75	60
	10°	mm	335	335	290	315	315	270	360	315
Breakout force		kN	171	162	158	187	177	172	151	141
		kgf	17410	16500	16100	19100	18070	17580	15430	14430
Operating weight		kg	16900	17010	16980	17010	17120	17090	17260	17340

Bucket type			High Lift Boom			
			Excavating Buckets		Light Material Buckets	
			Teeth	Bolt-on Cutting Edge	Teeth	Bolt-on Cutting Edge
Bucket capacity	Heaped	m ³	2.7	2.9	3.4	3.6
	Struck	m ³	2.3	2.5	3.0	3.2
Bucket width		mm	2915	2905	2915	2905
Bucket weight		kg	1475	1555	1650	1730
Static tipping load	Straight	kg	11590	11450	11280	11150
	40° full turn	kg	9890	9770	9630	9520
H. Dumping clearance, max. height and 45° dump angle**		mm	3450	3575	3305	3430
J. Reach at max. height and 45° dump angle**		mm	1290	1190	1435	1335
K. Operating height (fully raised)		mm	5985	5985	6205	6205
L. Overall length, bucket on ground		mm	8915	8760	9120	8965
Turning radius*		mm	7450	7375	7565	7485
M. Digging depth	0°	mm	130	115	130	115
	10°	mm	365	320	405	360
Breakout force		kN	184	169	153	143
		kgf	18730	17200	15630	14550
Operating weight		kg	17520	17600	17700	17780

* Bucket at carry, outside corner of bucket.

** At the end of B.O.C. or teeth

- All dimensions, weights, and performance values based on SAE J732c and J742b standards.
- Static tipping load and operating weight shown include lubricant, coolant, full fuel tank, ROPS cab and operator.
- Machine stability and operating weight affected by counterweight, tire size, and other attachments.

**Performance Data
Dimensions**

WHEEL LOADERS

Weight Changes

	Change in Operating Weight	Change in Tipping Load		Width Over Tire	Ground Clearance	Change in Vertical Dimensions
		Straight	Full Turn			
	kg	kg	kg	mm	mm	mm
20.5-25-16PR (L3)	-970	-770	-680	2695	390	-65
Install additional counterweight	+340	+900	+755			

Performance Data Dimensions

WHEEL LOADERS

WA470-6 (China source)

Unit: mm

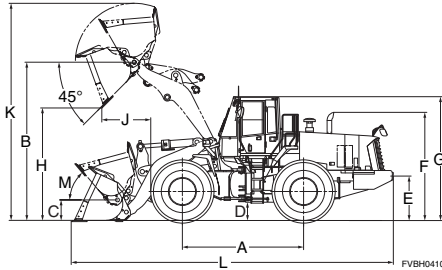

Tread	2300
Width over tires	3010
A Wheelbase	3450
B Hinge pin height, max. height	4360
C Hinge pin height, carry position	585
D Ground clearance	520
E Hitch height	1240
F Overall height, top of the stack	3080
G Overall height, ROPS cab	3500
M Tilt back angle	50°

Measured with 26.5-25-20PR (L3) tires

Bucket type			General Purpose Buckets					
			Stockpile Buckets			Excavating Buckets		
			Bolt-on Cutting Edge	Teeth + Segment	Teeth	Bolt-on Cutting Edge	Teeth + Segment	Teeth
Bucket capacity	Heaped	m ³	4.2	4.2	3.9	3.8	3.8	3.6
	Struck	m ³	3.5	3.5	3.3	3.2	3.2	3.1
Bucket width		mm	3170	3190	3190	3170	3190	3190
Bucket weight		kg	2050	2100	1970	2150	2200	2070
Static tipping load	Straight	kg	18330	18280	18410	17220	17170	17300
	40° full turn	kg	15745	15695	14870	14990	14945	15055
H. Dumping clearance, max. height and 45° dump angle**		mm	3185	3065	3065	3235	3110	3110
J. Reach at max. height and 45° dump angle**		mm	1235	1330	1330	1185	1285	1285
K. Operating height (fully raised)		mm	5960	5960	5960	5875	5875	5875
L. Overall length, bucket on ground		mm	8825	8980	8980	8755	8910	8910
Turning radius*		mm	7640	7705	7705	7635	7685	7685
Digging depth	0°	mm	80	100	100	80	100	100
	10°	mm	315	360	360	305	350	350
Breakout force		kN kgf	192 19600	192 19600	207 21120	203 20710	209 21330	220 22450
Operating weight		kg	23020	23070	22940	23120	23170	23040

Bucket type			Rock Bucket	Loose Material Bucket	Loose Material Bucket
			Teeth	Bolt-on Cutting Edge	Bolt-on Cutting Edge
Bucket capacity	Heaped	m ³	3.6	4.6	5.2
	Struck	m ³	3.1	3.9	4.5
Bucket width		mm	3170	3170	3170
Bucket weight		kg	2165	2110	2185
Static tipping load	Straight	kg	17205	17260	17185
	40° full turn	kg	14975	15020	14955
H. Dumping clearance, max. height and 45° dump angle**		mm	2990	3060	3040
J. Reach at max. height and 45° dump angle**		mm	1410	1365	1385
K. Operating height (fully raised)		mm	5875	5960	6185
L. Overall length, bucket on ground		mm	9085	8940	9035
Turning radius*		mm	7655	7700	7705
Digging depth	0°	mm	100	80	80
	10°	mm	380	335	350
Breakout force		kN kgf	190 19390	168 17140	165 16840
Operating weight		kg	23135	23080	23155

* Bucket at carry, outside corner of bucket.

** At the end of B.O.C. or teeth

- All dimensions, weights, and performance values based on SAE J732c and J742b standards.
- Static tipping load and operating weight shown include lubricant, coolant, full fuel tank, ROPS cab and operator.
- Machine stability and operating weight affected by counterweight, tire size, and other attachments.

Performance Data Dimensions

WHEEL LOADERS

WA200-5 (Brazil source)

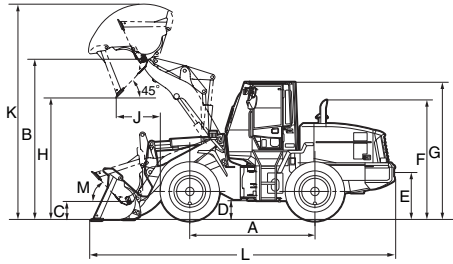

Unit: mm (ft.in)

	17.5-25 tires	20.5-25 tires
Tread	1930 (6'4")	1930 (6'4")
Width over tires	2375 (7'10")	2470 (8'1")
A Wheelbase	2840 (9'4")	2840 (9'4")
B Hinge pin height, max. height	3635 (11'11")	3705 (12'2")
C Hinge pin height carry position	410 (1'4")	480 (1'7")
D Ground clearance	425 (1'5")	495 (1'8")
E Hitch height	870 (2'10")	940 (3'1")
F Overall height, top of the stack	3150 (10'3")	3220 (10'7")
G Overall height, ROPS cab	3110 (10'2")	3180 (10'5")
M Tilt back angle	49°	49°

Measured with 17.5-25-12PR (L2) tires

Bucket type			Stockpile Bucket	Excavating Bucket	Light Material Bucket
			Bolt-on Cutting Edge	Bolt-on Cutting Edge	Bolt-on Cutting Edge
Bucket Capacity	Heaped	m ³ (yd ³)	2.0 (2.6)	1.7 (2.2)	2.4 (3.1)
	Struck	m ³ (yd ³)	1.7 (2.2)	1.4 (1.8)	2.0 (2.6)
Bucket width		mm (ft.in)	2535 (8'4")	2535 (8'4")	2550 (8'4")
Bucket weight		kg (lb)	770 (1,698)	740 (1,631)	875 (1,929)
Static tipping load	Straight	kg (lb)	8990 (19,820)	9050 (19,950)	8840 (19,490)
	Full turn (40°)	kg (lb)	7810 (17,220)	7870 (17,350)	13055 (16,940)
H. Dumping clearance, max. height and 45° dump angle**		mm (ft.in)	2740 (9'0")	2770 (9'1")	2655 (8'9")
Reach at 2130 mm (7') and 45° dump angle**		mm (ft.in)	1490 (4'11")	1520 (5'0")	1530 (5'0")
J. Reach at max. height and 45° dump angle**		mm (ft.in)	1015 (3'4")	1045 (3'5")	1105 (3'8")
Reach with arm horizontal and bucket level**		mm (ft.in)	2240 (7'4")	2210 (7'3")	2365 (7'9")
K. Operating height (fully raised)		mm (ft.in)	5005 (16'5")	4975 (16'4")	4995 (16'5")
L. Overall length, bucket on ground		mm (ft.in)	6920 (22'8")	6850 (22'6")	7050 (23'2")
Turning radius*		mm (ft.in)	5650 (18'6")	5620 (18'5")	5715 (18'9")
Digging depth	0°	mm (ft.in)	140 (5.5")	120 (4.7")	165 (6.5")
	10°	mm (ft.in)	325 (1'1")	305 (1'0")	350 (1'2")
Breakout force		kN kgf (lb)	93.2 9500 (20,940)	102.5 10450 (23,040)	81.4 8300 (18,300)
Operating weight		kg (lb)	10300 (22,710)	10200 (22,490)	10330 (22,770)

* Bucket at carry, outside corner of bucket.

** At the end of B.O.C. or teeth

- All dimensions, weights, and performance values based on SAE J732c and J742b standards.
- Static tipping load and operating weight shown include lubricant, coolant, full fuel tank, ROPS cab and operator.
- Machine stability and operating weight affected by counterweight, tire size, and other attachments.

Weight Changes

	Change in Operating Weight		Change in Tipping Load				Width Over Tire		Ground clearance		Change in Vertical Dimensions		Change in Reach	
			Straight		Full Turn									
	kg	lb	kg	lb	kg	lb	mm	ft.in	mm	ft.in	mm	ft.in	mm	ft.in
20.5-25-12PR (L3)	+665	+1,466	+355	+783	+320	+705	2470	8'1"	495	1'8"	+70	+2.8"	+75	+3.5"
17.5-25-12PR (L3)	+105	+231	+80	+176	+70	+154	2375	7'10"	425	1'5"	0	0	0	0

Performance Data Dimensions

WHEEL LOADERS

WA320-5 (Brazil source)

Unit: mm (ft.in)

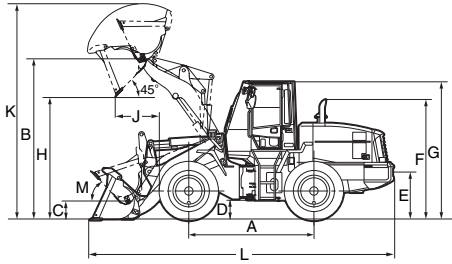

Tread	2050 (6'9")
Width over tires	2585 (8'6")
A Wheelbase	3030 (9'11")
B Hinge pin height, max. height	3905 (12'10")
C Hinge pin height, carry position	480 (1'7")
D Ground clearance	425 (1'5")
E Hitch height	1095 (3'7")
F Overall height, top of the stack	2775 (9'1")
G Overall height, ROPS cab	3200 (10'6")
M Tilt back angle	49°

Measured with 20.5-25-12PR (L3) tires

Bucket type			Stockpile Bucket	Excavating Bucket	Light Material Bucket
			Bolt-on Cutting Edge	Bolt-on Cutting Edge	Bolt-on Cutting Edge
Bucket capacity	Heaped	m ³ (yd ³)	2.8 (3.7)	2.5 (3.3)	3.2 (4.2)
	Struck	m ³ (yd ³)	2.4 (3.1)	2.2 (2.9)	2.8 (3.7)
Bucket width		mm (ft.in)	2770 (9'1")	2770 (9'1")	2740 (9'0")
Bucket weight		kg (lb)	1240 (2,734)	1190 (2,623)	1430 (3,153)
Static tipping load	Straight	kg (lb)	12200 (26,900)	12240 (26,980)	12010 (26,480)
	Full turn (40°)	kg (lb)	10600 (23,370)	10640 (23,460)	10410 (22,950)
H. Dumping clearance, max. height and 45° dump angle**		mm (ft.in)	2850 (9'4")	2775 (9'1")	2715 (8'11")
Reach at 2130 mm (7') and 45° dump angle**		mm (ft.in)	1570 (5'2")	1600 (5'3")	1435 (4'8")
J. Reach at max. height and 45° dump angle**		mm (ft.in)	1035 (3'5")	1090 (3'7")	1170 (3'10")
Reach with arm horizontal and bucket level**		mm (ft.in)	2420 (7'11")	2520 (8'3")	2610 (8'7")
K. Operating height (fully raised)		mm (ft.in)	5330 (17'6")	5300 (17'5")	5415 (17'9")
L. Overall length, bucket on ground		mm (ft.in)	7455 (24'6")	7310 (24'0")	7645 (25'1")
Turning radius*		mm (ft.in)	6090 (20'0")	6030 (19'9")	6165 (20'2")
Digging depth	0°	mm (ft.in)	85 (3.3")	85 (3.3")	85 (3.3")
	10°	mm (ft.in)	296 (11.7")	285 (11.2")	322 (12.7")
Breakout force		kN	129.3	148.1	110.6
		kgf (lb)	13180 (29,060)	15100 (33,290)	11,280 (24,870)
Operating weight		kg (lb)	14310 (31,550)	14260 (31,440)	14500 (31,970)

* Bucket at carry, outside corner of bucket.

** At the end of B.O.C. or teeth

- All dimensions, weights, and performance values based on SAE J732c and J742b standards.
- Static tipping load and operating weight shown include lubricant, coolant, full fuel tank, ROPS cab and operator.
- Machine stability and operating weight affected by counterweight, tire size, and other attachments.

Weight Changes

	Change in Operating Weight		Change in Tipping Load				Width Over Tire		Ground clearance		Change in Vertical Dimensions	
			Straight		Full Turn							
	kg	lb	kg	lb	kg	lb	mm	ft.in	mm	ft.in	mm	ft.in
20.5-25-12PR (L2)	-190	-419	-140	-309	-125	-276	2585	8'6"	425	1'5"	0	0"
Additional counterweight	-520	-1,146	-1010	-2,227	-880	-1,940	-	-	-	-	-	-
Air conditioner	-70	-154	-90	-198	-80	-176	-	-	-	-	-	-

USE OF TRAVEL TIME CHARTS

The following explanation applies to travel time charts for Wheel Loaders.

1) How to read graph:

The vertical axis indicates the distance and the horizontal axis indicates the time. First, check the travel resistance of the jobsite. Then, obtain the intersection point of the resistance line and the distance. The value of the horizontal axis at this point is the travel time. This graph does not include the acceleration time.

2) Explanation of travel resistance:

The item indicated by percentage is the travel resistance. The travel resistance is the total of the grade resistance and rolling resistance. The rolling resistance varies with the road condition. Set it to 3.3% usually.

3) Empty and loaded curves:

The empty curve indicates the weight and travel curve of the machine of the ordinary specification. The loaded curve indicates the total of the weight of the empty machine and the rated load.

Example:

Haul...

Using the graph for the Loaded machine, read from the Travel Distance (one way) scale at 300 m (980 feet) across to the 6% total resistance line (point A). From (point A) read down to the Travel Time (one way) scale to determine haul time = 1.5 minutes.

Return...

Using the graph for the Empty machine, read from the Travel Distance (one way) scale at 400 m (1310 feet) across to the 2% total resistance line (point A). From (point A) read down to the Travel Time (one way) scale to determine haul time = 1.0 minutes.

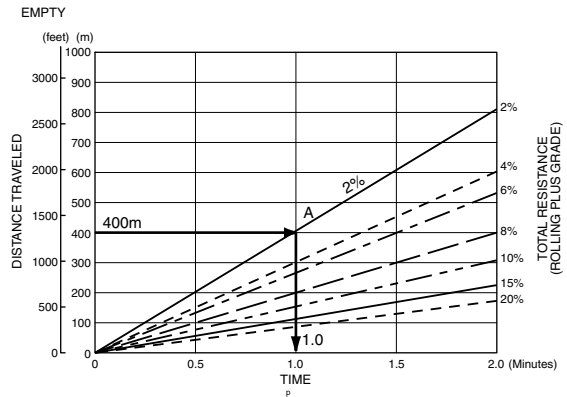
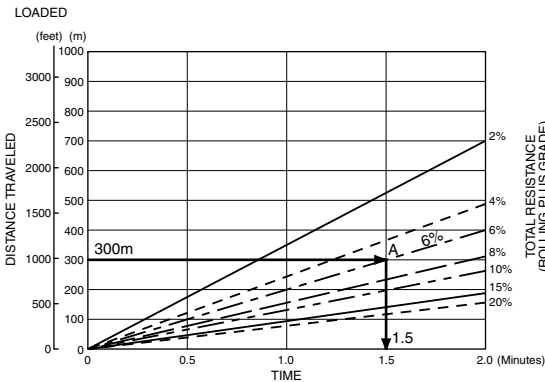

NOTE: Curves assume use of highest operating speed attainable. It is important to consult the tire manufacturer on Ton-Mile-Per-Hour ratings and pressure recommendations.

WA500-3 LOADED

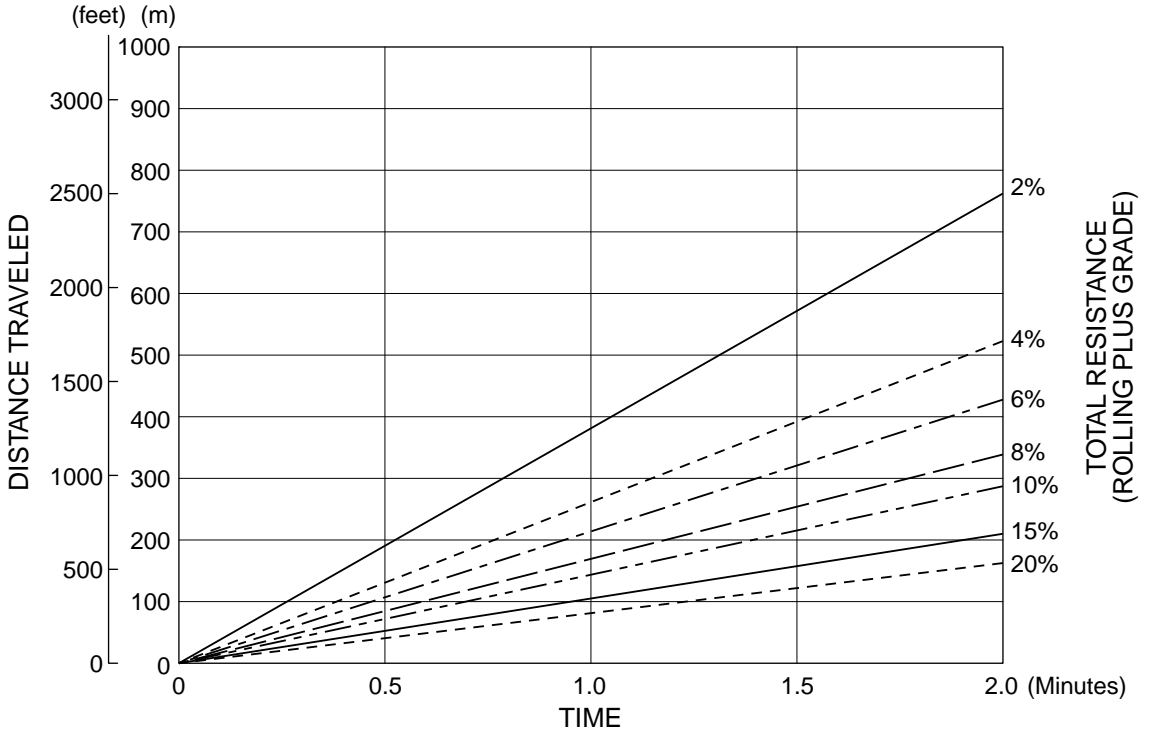

FVBH0274

WA500-3 EMPTY

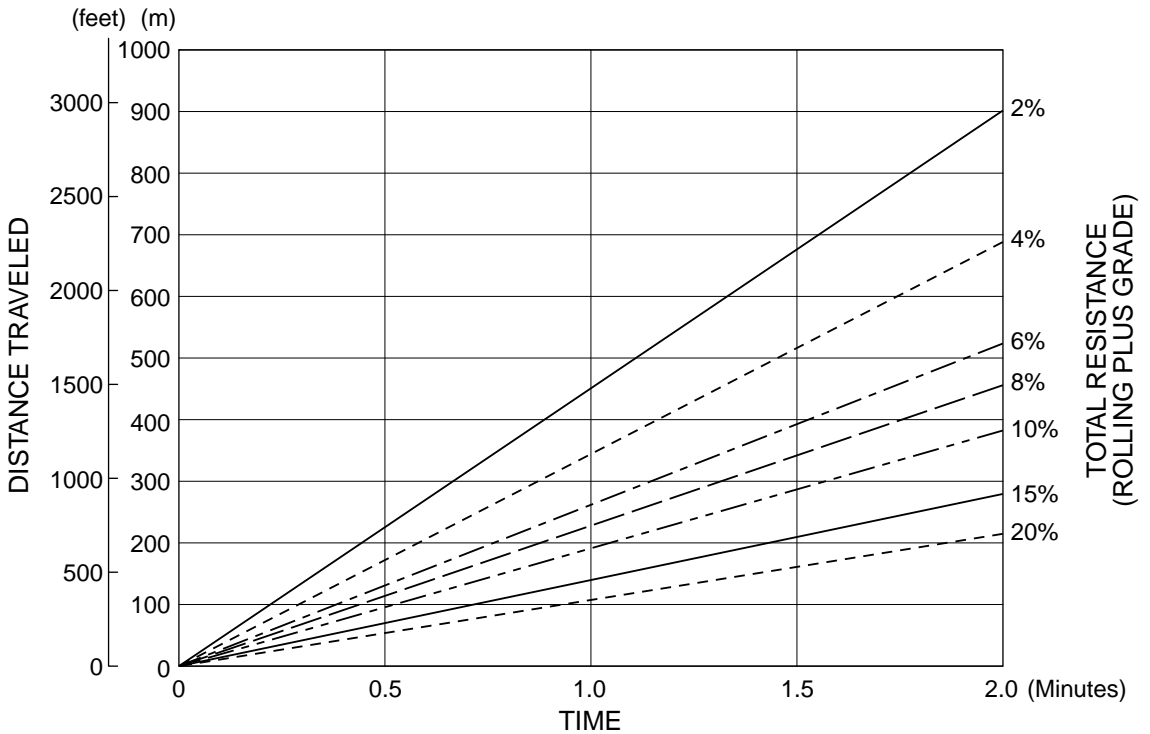

FVBH0273

Performance Curves
Travel Time Charts

WHEEL LOADERS

WA600-3 LOADED

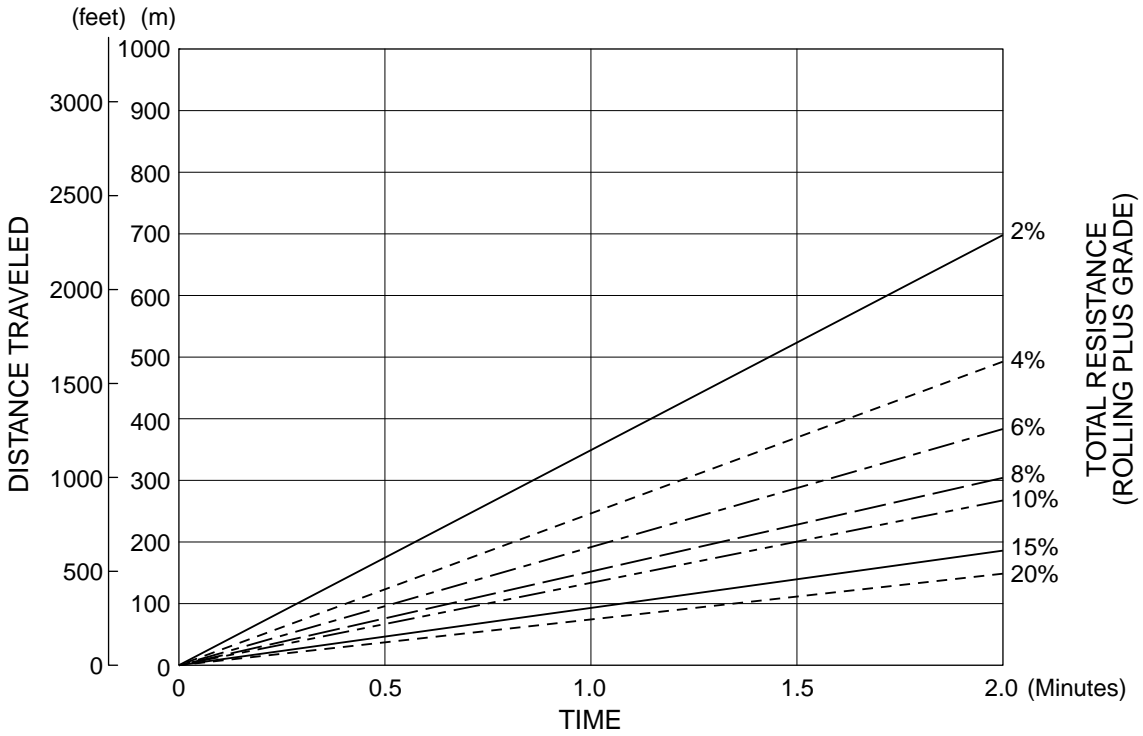

FVBH0276

WA600-3 EMPTY

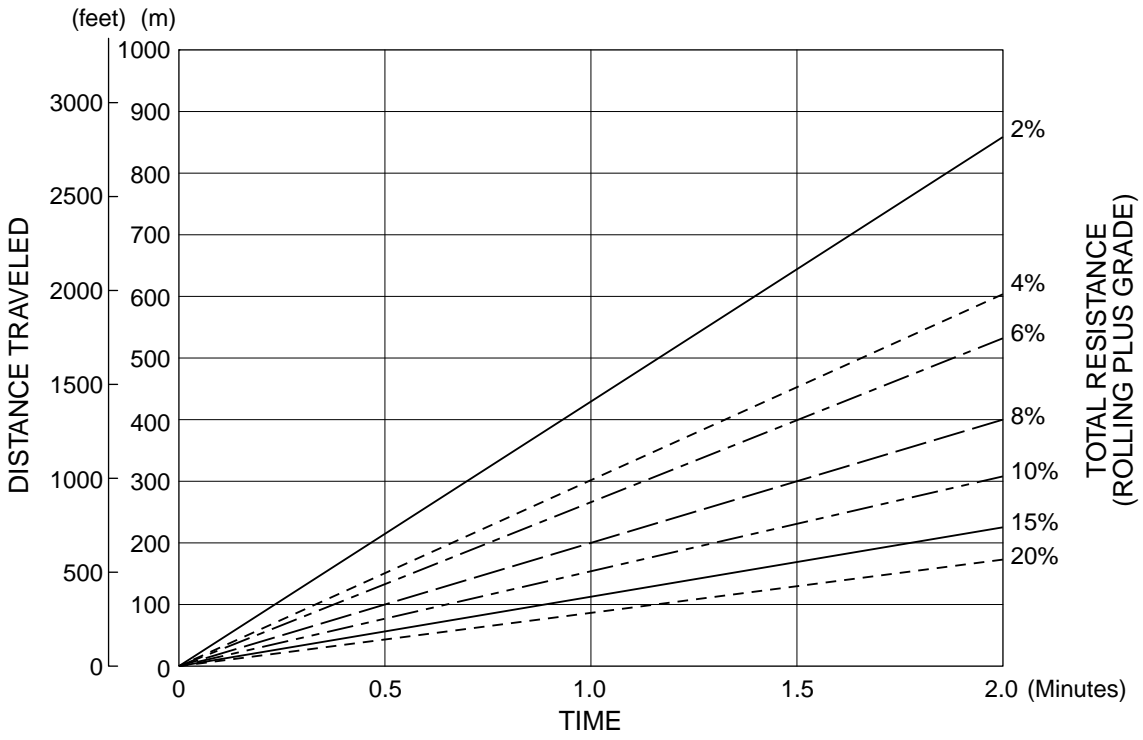

FVBH0275

Performance Curves
Travel Time Charts

WHEEL LOADERS

WA700-3 LOADED

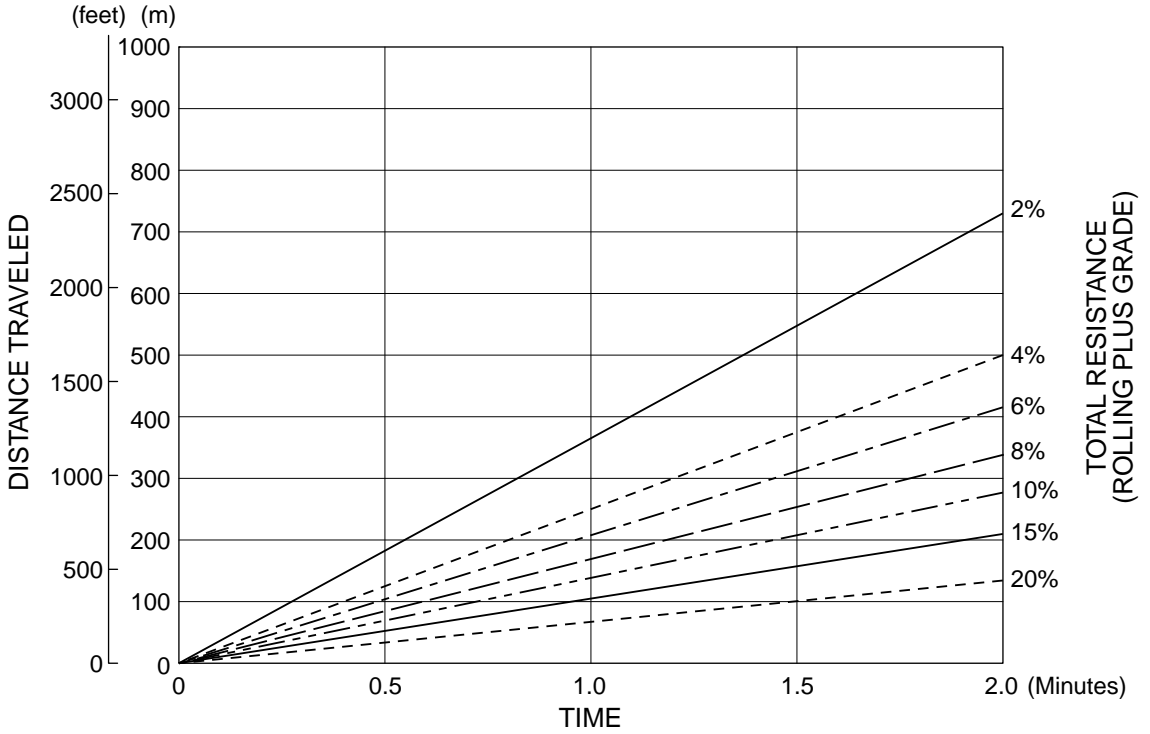

FVBH0278

WA700-3 EMPTY

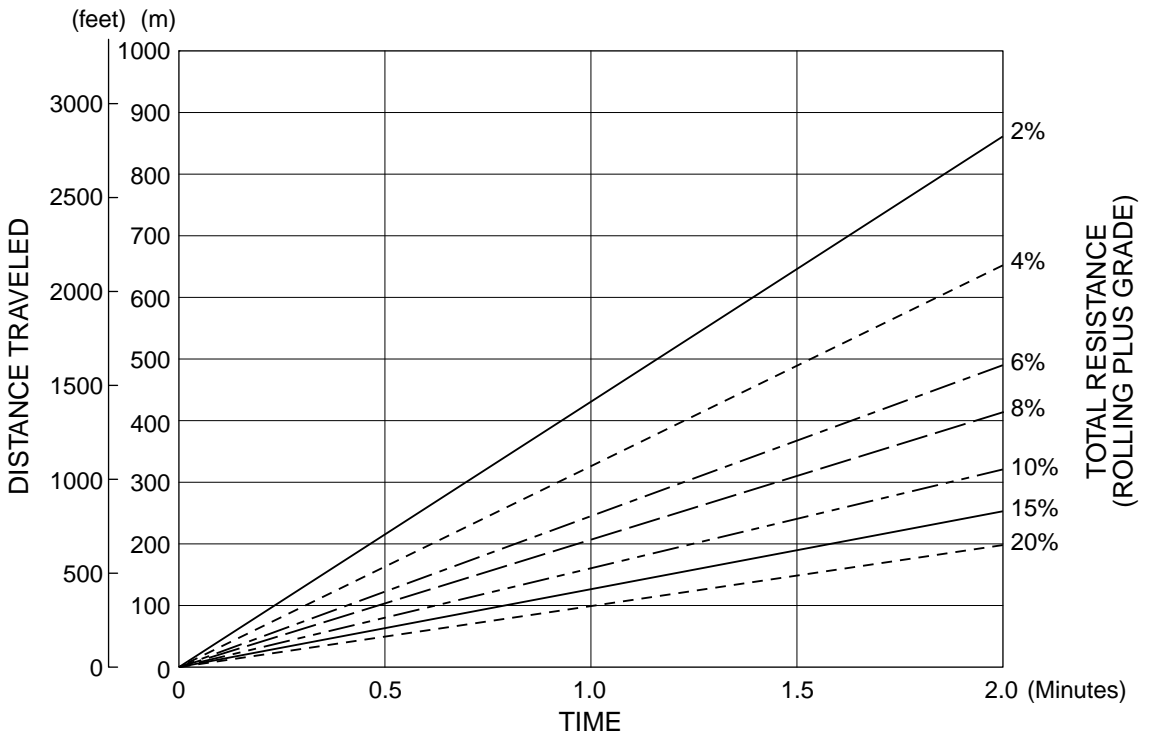

FVBH0277

Performance Curves
Travel Time Charts

WHEEL LOADERS

WA800-3 LOADED

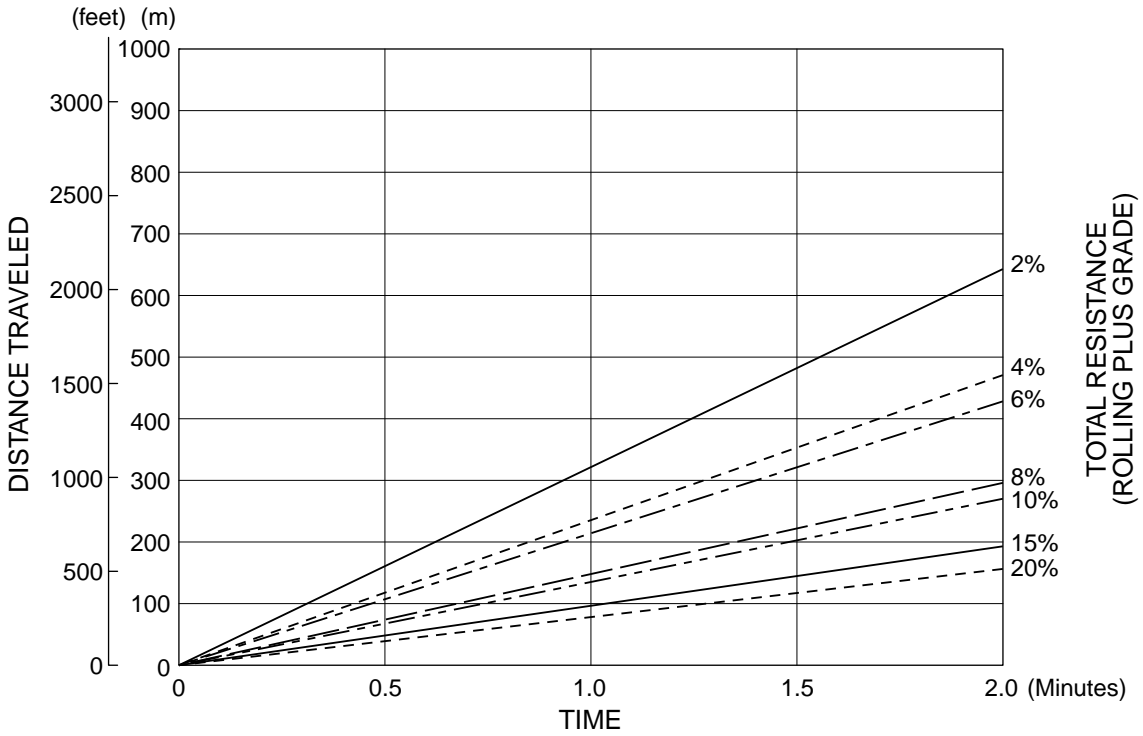

FVBH0280

WA800-3 EMPTY

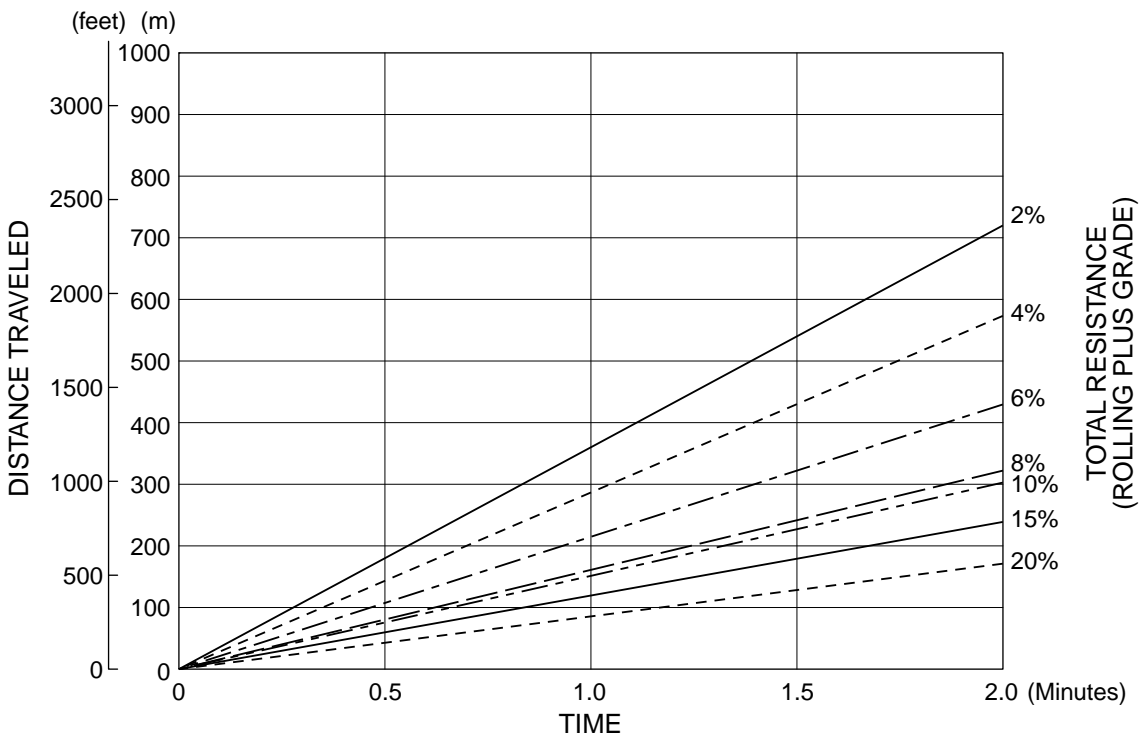

FVBH0279

WA900-3 LOADED

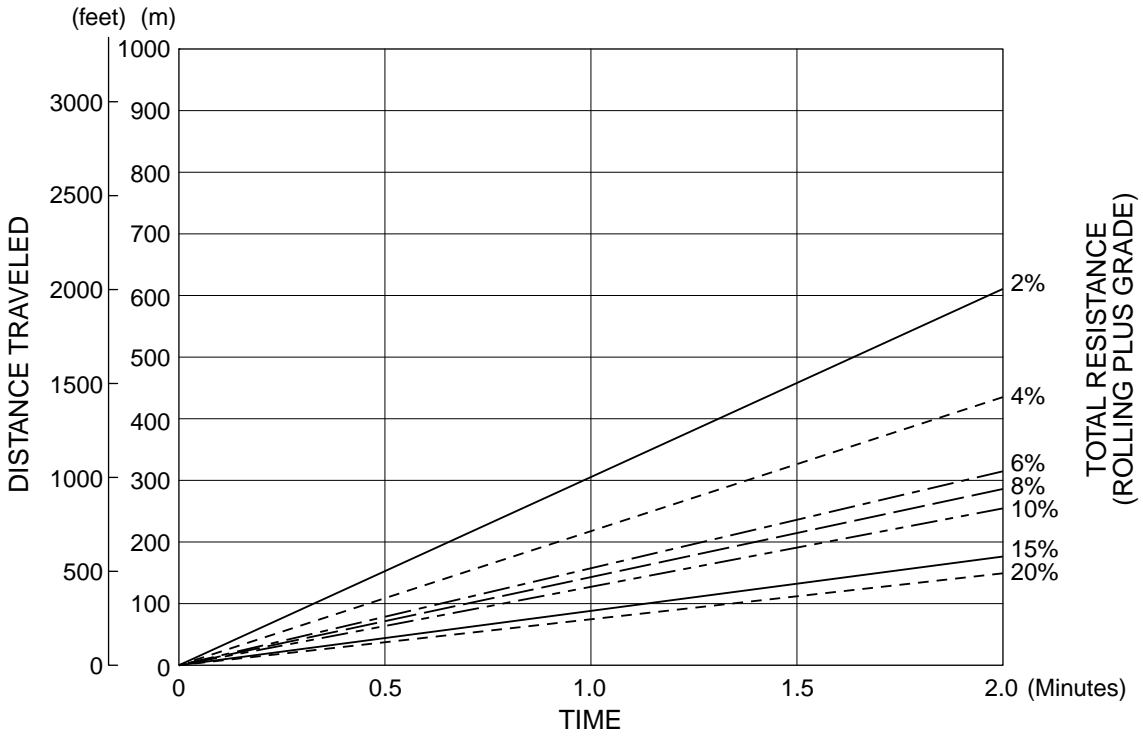

FVBH0282

WA900-3 EMPTY

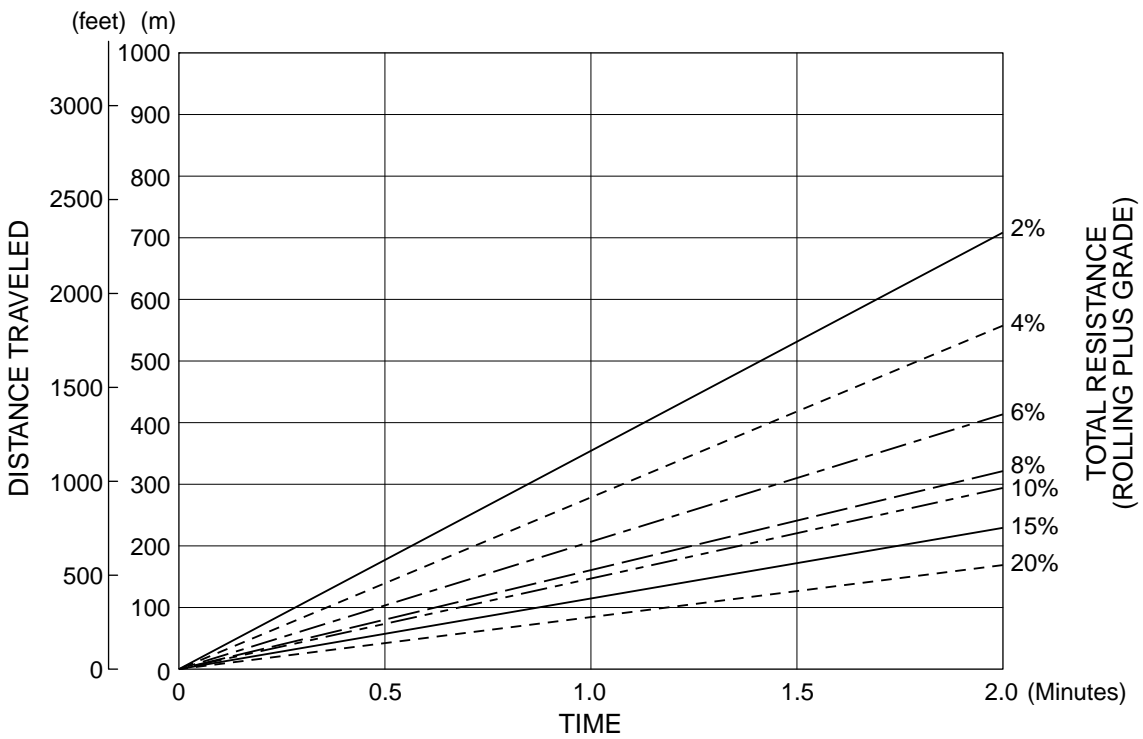

FVBH0281

Performance Curves
Travel Time Charts

WHEEL LOADERS

WA1200-3 LOADED

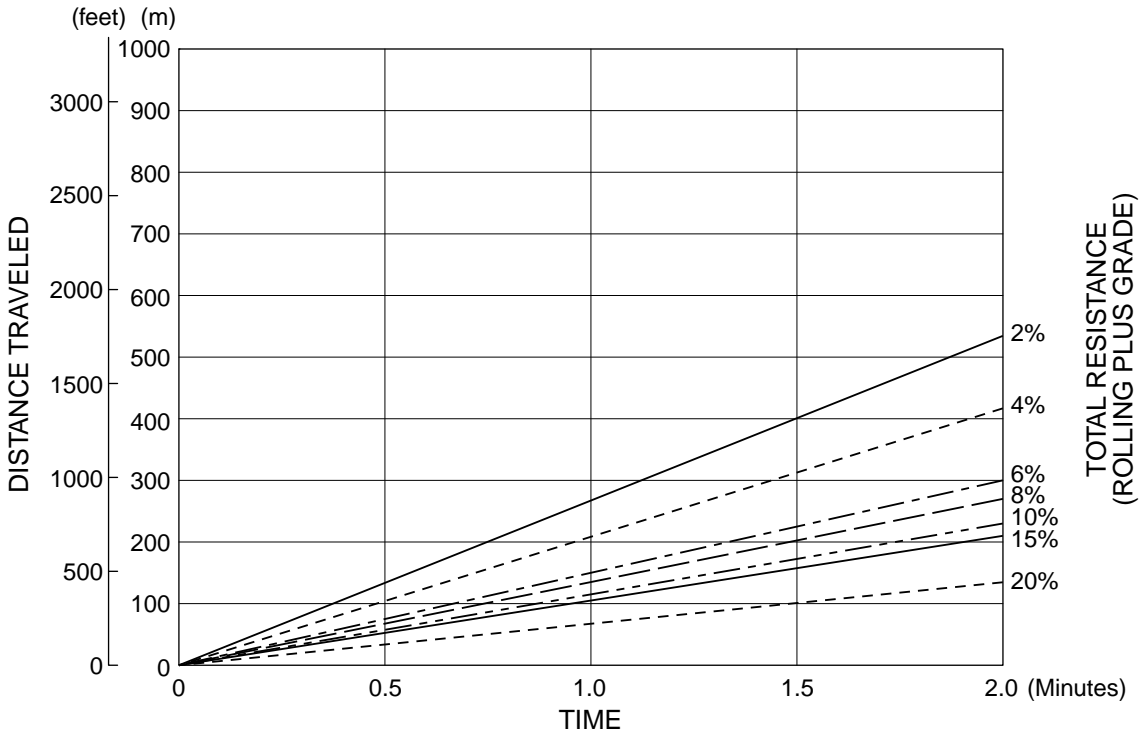

FVBH0284

WA1200-3 EMPTY

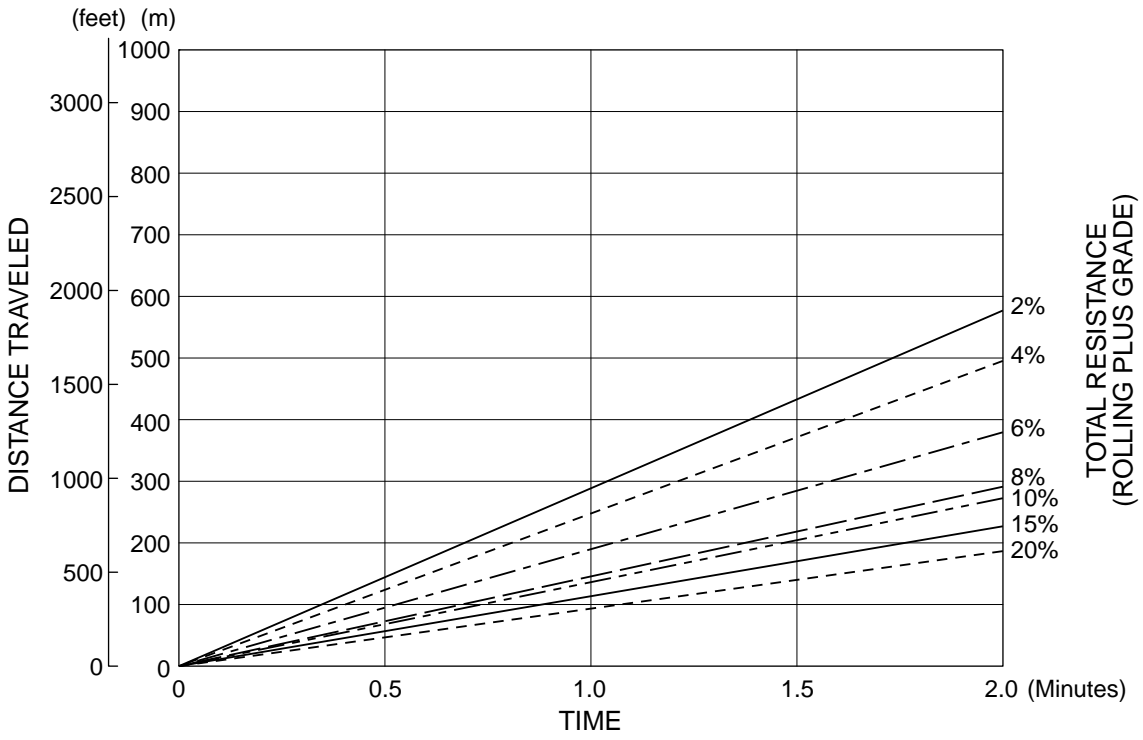

FVBH0283

1. OPERATING WEIGHT

The total mass in kilograms (pounds) of the machine as specified and fully serviced, including a full fuel tank and 80 kg (175 lb) operator.

2. BUCKET CAPACITY (BY SAE)

The bucket capacity of wheel loaders is calculated as follows:

The struck capacity is defined as the volume of material retained in the bucket after a heaped load is struck by drawing a straight edge across the width of bucket with one end of the straight edge resting on the cutting edge and the other end resting on the uppermost portion of the bucket back sheet or spill guard. The struck capacity (Vs) can be expressed by the following equation:

$$V_s = AW - \frac{2}{3} a^2b$$

A = cross sectional area at the center of the bucket, mm² (in²).

W = average inside width of the bucket, mm (in.).

a = height of the spill guard at the center of the bucket normal to the strike line, mm (in.).

b = length of opening at the center of the bucket, mm (in.).

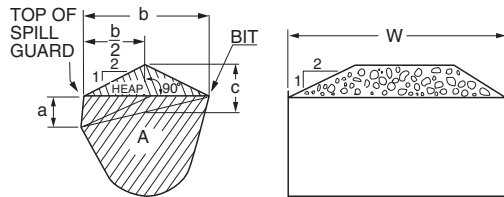

FVBH0009

Using the 2 : 1 angle of repose of the heaped material, the heaped capacity (Vh) is expressed as follow:

$$V_h = V_s + \frac{b^2W}{8} - \frac{b^2}{6} (a+c)$$

Where c is the length on a normal to the strike line. On one end it is terminated by the assumed crest of the material.

On the other end it is terminated by the intersection with a line from the bit or cutting edge tip to the base of the spill guard.

This method applies primarily to irregular buckets having parallel sides and a cutting edge parallel to the edge of the spill guard or back sheet. Moderately clipped spill guard corners will introduce no appreciable errors.

3. BUCKET LOAD

The bucket load should not exceed 50% of the TIPPING LOAD for wheel loaders or 35% of the TIPPING LOAD for crawler loaders, and will be considered as operating under the following conditions:

1. Lifting ability of the machine in all bucket positions to be no less than the specified operating load.
2. Bucket attachment of specified size and type.
3. Maximum travel speed of 6 km/h (3.7 mph).
4. Operating surface.
 - (a) Shall be hard, moderately smooth and level for wheel loaders.
 - (b) General operating conditions of crawler loaders are such that they normally are not operating on hard, moderately smooth level surface.
For this reason, the rating on crawler loaders is set at the lower figure of 35%.

4. BREAKOUT FORCE

Breakout force in kilograms (and kilo-Newton or pounds) is the maximum sustained vertical upward force exerted 100 mm (4 in) behind the tip of the bucket cutting edge and is achieved through the ability to lift and/or roll-back the bucket about the specified pivot point under the following conditions:

- (a) Machine with transmission in neutral.
- (b) All brakes released.
- (c) Unit at standard operating weight, rear of machine not tied down.

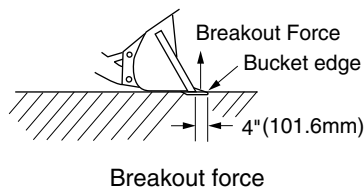

FVBH0010

- (d) Bottom of cutting edge parallel to and not more than 25 mm (1 in) above or below the ground line.
- (e) When bucket circuit is used, the pivot point must be specified as the bucket hinge pin, and the unit blocked under the bucket hinge pin pivot point in order to minimize linkage movement.
- (f) When the lift circuit is used, the pivot point must be specified as the lift arm hinge pin.
Wheel loaders shall have front axle blocked to eliminate change in position of pivot pins due to tire deflection.
- (g) If both circuits are used simultaneously, the dominating pivot point listed in (e) or (f) must be specified.
- (h) If the circuit used causes the rear of the machine to leave the ground then the vertical force value required to raise the rear of the machine is the breakout force.
- (i) For irregular shaped buckets, the tip of the bucket cutting edge, referred to above shall mean the farthest forward point of the cutting edge.

5. STATIC TIPPING LOAD

The minimum mass in kilograms (pounds) at the center of gravity of the SAE rated load in the bucket which will rotate the machine to a point where, on the crawler units, the front track rollers are clear of the track and, on wheel loaders, the rear wheels are clear of the ground under the following conditions:

- (a) Maximum bucket rollback.
- (b) Center of gravity of load at the maximum forward position in the raising cycle.
- (c) Machine at operating weight and equipment as specified.
Articulated steer loader shall be in full turn position (specify angle).

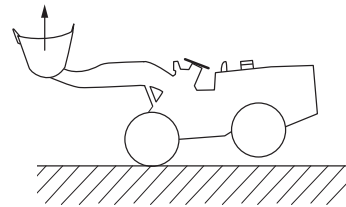

Tipping Load

FVBH0011

6. LIFTING CAPACITY

The maximum mass in kilograms (pounds) at the center of gravity of SAE rated load in the bucket that can be lifted at a specified height with the bucket positioned to retain maximum load under the following conditions:

- (a) Machine with rear end tied down.
- (b) Machine at operating weight and equipment as specified.

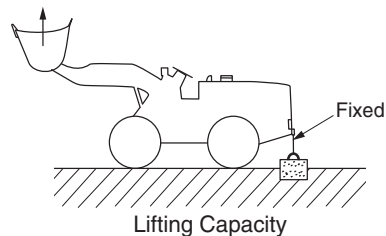

Lifting Capacity

FVBH0012

7. HYDRAULIC CYCLE TIMES

- Raising Time — The time in seconds required to raise the bucket, rolled back, from the ground level position to full height with the specified SAE operating load.
- Lowering time — The time in seconds required to lower the empty bucket from the full height to a level position on the ground.
- Dump Time — The time in seconds required to move the bucket from the load carrying position at maximum height to the full dump position while dumping the specified SAE operating load.

8. DUMPING CLEARANCE AND REACH

- Dumping clearance — The vertical distance in millimeters (inches) from the ground to the lowest point of the cutting edge with the bucket hinge pin at maximum height and the bucket at a 45 degree dump angle. If the dump angle is less than 45 degree, specify the angle.
- Dumping reach — The horizontal distance in millimeters (inches) from the foremost point on the machine (including tires, tracks, or loader frames) to the rearmost point of the bucket cutting edge with bucket hinge pin at maximum height and bucket at a 45 degree dump angle. If the dump angle is less than 45 degree, specify the angle.

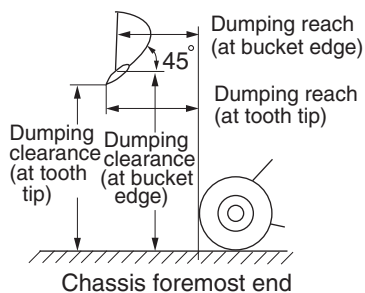

FVBH0013

9. CARRY POSITION

The vertical distance from the ground in millimeters (inches) to the centerline of the bucket hinge pin, with the angle of approach at 15 degree.

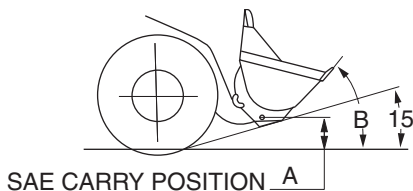

- A: Carry height
- B: Mex tilt-back angle (At carry position)

FVBH0014

**Attachment
Availability**

WHEEL LOADERS

Unit: m³ (cu.yd)

		WA50-6	WA120-3	WA150-6	WA150-5	WA180-3	WA200-6
GENERAL PURPOSE BUCKET (STOCKPILE)	W/B.O.C	0.6 (0.8)	1.4 (1.85)	1.5 (2.0)	1.5 (2.0)	1.7 (2.25)	2.0 (2.6)
	W/teeth		1.3 (1.7)	1.4 (1.8)		1.6 (2.1)	2.0 (2.6)
	W/segment edge						
GENERAL PURPOSE BUCKET (EXCAVATING)	W/B.O.C		1.2 (1.55)	1.3 (1.7)	1.3 (1.7)	1.5 (1.95)	1.7 (2.2)
	W/teeth		1.2 (1.55)	1.2 (1.6)	1.3 (1.7)	1.5 (1.95)	1.7 (2.2)
	W/segment edge						
SPADE NOSE ROCK BUCKET	W/tip type teeth						
LIGHT MATERIAL BUCKET	W/B.O.C		1.7 (2.25)	1.7 (2.2)	1.7 (2.2)	2.2 (2.9)	2.4 (3.1)
	BARE		1.6 (2.1)		1.6 (2.1)	2.1 (2.75)	
LIGHT MATERIAL BUCKET	For multi-coupler						
MULTI-PURPOSE BUCKET			1.0 (1.3)			1.2 (1.65)	
GENERAL PURPOSE BUCKET (STOCKPILE) FOR HIGH LIFT BOOM	W/B.O.C		1.2 (1.55)		1.3 (1.7)	1.5 (1.95)	1.7 (2.2)
	W/teeth		1.2 (1.55)		1.3 (1.7)	1.5 (1.95)	1.7 (2.2)
GENERAL PURPOSE BUCKET FOR SUPER HIGH LIFT BOOM (STOCKPILE)	W/B.O.C		1.0 (1.3)				
	W/teeth		1.0 (1.3)				
HIGH LIFT BOOM			○	○	○	○	○
SUPER-HIGH LIFT BOOM			○				
B.O.C (BOLT-ON CUTTING EDGE)		○	○	○	○	○	○
B.O.C, LONG LIFE							
SEGMENT EDGE							
TEETH	Bolt-on teeth		○	○	○	○	○
	Bolt-on teeth for limestone						
	Bolt-on teeth for long life						
	Tip type teeth		○	○	○	○	○
LOG GRAPPLE	Pin on type						
LUMBER GRAPPLE			○			○**	
DUMPING FORK	Pin-on type		○				
	Multi-coupler						
LUMBER FORK	Pin-on type		○			○	
	Multi-coupler		○				
EXTENSION FORK							
MULTI-COUPLER	Mech. type						
	Hyd. type						
COUNTERWEIGHT	Additional		○	○	○	○	○
	For log & fork						○
BUCKET CYLINDER (LARGE SIZED)					○		
BUCKET CYLINDER	For high lift				○		

*: Install the 0.7 m³ (0.9 cu.yd) general purpose bucket (stockpile).

** : Install the additional counterweight.

**Attachment
Availability**

WHEEL LOADERS

Unit: m³ (cu.yd)

		WA200-5	WA200PZ-6	WA250-6	WA250-5	WA250PZ-6	WA250-3
GENERAL PURPOSE BUCKET (STOCKPILE)	W/B.O.C	2.0 (2.6)	2.0 (2.6)	2.3 (3.0)	2.3 (3.0)	2.2 (2.9)	2.1 (2.75)
	W/teeth	1.9 (2.5)	1.9 (2.5)	2.1 (2.75)	2.1 (2.75)		1.9 (2.5)
	W/segment edge						
GENERAL PURPOSE BUCKET (EXCAVATING)	W/B.O.C	1.7 (2.2)		1.9 (2.5)	1.9 (2.5)		1.9 (2.5)
	W/teeth	1.6 (2.1)		1.8 (2.4)	1.8 (2.35)		1.8 (2.35)
	W/segment edge						
SPADE NOSE ROCK BUCKET	W/tip type teeth						
LIGHT MATERIAL BUCKET	W/B.O.C	2.4 (3.1)		2.7 (3.5)	2.7 (3.35)		2.7 (3.35)
	W/teeth						
	BARE	2.3 (3.0)		2.5 (3.25)	2.5 (3.25)		2.5 (3.25)
LIGHT MATERIAL BUCKET	For multi-coupler						
MULTI-PURPOSE BUCKET							
GENERAL PURPOSE BUCKET (STOCKPILE) FOR HIGH LIFT BOOM	W/B.O.C	1.7 (2.2)		1.9 (2.5)	1.9 (2.5)		1.9 (2.5)
	W/teeth	1.7 (2.2)		1.8 (2.35)	1.8 (2.35)		1.8 (2.35)
GENERAL PURPOSE BUCKET FOR SUPER HIGH LIFT BOOM (STOCKPILE)	W/B.O.C						
	W/teeth						1.5 (1.95)
HIGH LIFT BOOM		○		○	○		○
SUPER-HIGH LIFT BOOM							
B.O.C (BOLT-ON CUTTING EDGE)		○	○	○	○	○	○
B.O.C, LONG LIFE							
SEGMENT EDGE							
TEETH	Bolt-on teeth	○	○	○	○	○	○
	Bolt-on teeth for limestone						
	Bolt-on teeth for long life						
	Tip type teeth	○	○	○	○	○	○
LOG GRAPPLE	Pin on type			○	○		○
LUMBER GRAPPLE					○		○
DUMPING FORK	Pin-on type						○
	Multi-coupler						
LUMBER FORK	Pin-on type	○			○		○
	Multi-coupler						
EXTENSION FORK							
QUICK-COUPLER	Mech. type						
	Hyd. type		○ (STD)		○	○ (STD)	○
COUNTERWEIGHT	Additional	○	○ (STD)	○	○	○ (STD)	○
	For log & fork			○			
BUCKET CYLINDER (LARGE SIZED)							
BUCKET CYLINDER	For high lift				○		
PALLET FORK	W/coupler		○			○	

		WA320-6	WA320-5	WA320PZ-6	WA320-3 CUSTOM	WA380-6	WA380Z-6
GENERAL PURPOSE BUCKET (STOCKPILE)	W/B.O.C	2.8 [○] (2.7)	2.8 [○] (3.7)	2.7 [○] (3.5)	2.7 [○] (3.55)	3.3 [○] (4.3)	3.3 [○] (4.3)
	W/teeth	2.6 [○] (3.4)	2.6 [○] (3.25)		2.5 [○] (3.25)	3.1 [○] (4.1)	3.1 [○] (4.1)
	W/segment edge						
GENERAL PURPOSE BUCKET (EXCAVATING)	W/B.O.C	2.3 [○] (3.0)	2.3 [○] (3.0)			2.9 [○] (3.8)	2.9 [○] (3.8)
	W/teeth	2.1 [○] (2.7)	2.1 [○] (2.75)			2.7 [○] (3.5)	2.7 [○] (3.5)
	W/segment edge					2.9 [○] (3.8)	2.9 [○] (3.8)
SPADE NOSE ROCK BUCKET	W/tip type teeth						
LIGHT MATERIAL BUCKET	W/B.O.C	3.2 [○] (4.2)	3.2 [○] (4.2)			4.0 [○] (5.2)	4.0 [○] (5.2)
	W/teeth	3.0 [○] (3.9)					
	BARE		3.0 [○] (3.9)				
LIGHT MATERIAL BUCKET	For multi- coupler		2.5 [○] (3.25)				
GENERAL PURPOSE BUCKET (STOCKPILE) FOR HIGH LIFT BOOM	W/B.O.C		2.4 [○] (3.0)			2.9 [○] (3.8)	2.9 [○] (3.8)
	W/teeth		2.2 [○] (2.75)			2.7 [○] (3.5)	2.7 [○] (3.5)
GENERAL PURPOSE BUCKET FOR SUPER HIGH LIFT BOOM (STOCKPILE)	W/B.O.C						
	W/teeth						
HIGH LIFT BOOM		○	○			○	○
SUPER-HIGH LIFT BOOM							
B.O.C (BOLT ON CUTTING EDGE)		○	○	○	○	○	○
B.O.C, LONG LIFE			○		○		
SEGMENT EDGE			○		○	○	○
TEETH	Bolt-on teeth	○	○	○	○	○	○
	Bolt-on teeth for limestone						
	Bolt-on teeth for long life						
	Tip type teeth	○	○	○	○	○	○
LOG GRAPPLE	Pin on type	○	○		○	○	○
LUMBER GRAPPLE			○				
DUMPING FORK	Pin-on type		○		○		
	Multi-coupler						
LUMBER FORK	Pin-on type		○		○		
	Multi-coupler						
EXTENSION FORK							
QUICK-COUPLER	Mech. type						
	Hyd. type			○ (STD)			
COUNTERWEIGHT	Additional	○	○		○	○	○
	For log & fork		○			○	○
BUCKET CYLINDER (LARGE SIZED)	For log & fork		○				
BUCKET CYLINDER	For high lift		○				
PALLET FORK	W/coupler			○			

		WA380-5	WA380-3	WA430-6	WA430-5	WA430-6	WA430-5
GENERAL PURPOSE BUCKET (STOCKPILE)	W/B.O.C	3.3 (4.3)	3.2 (4.2)	3.5 (4.6)	3.7 (4.8)	3.5 (4.6)	3.7 (4.8)
	W/teeth	3.1 (4.1)	3.0 (3.9)	3.3 (4.3)	3.5 (4.6)	3.3 (4.3)	3.5 (4.6)
	W/segment edge		3.2 (4.2)				
GENERAL PURPOSE BUCKET (EXCAVATING)	W/B.O.C	2.9 (3.8)	2.8 (3.65)	3.3 (4.3)	3.3 (4.3)	3.3 (4.3)	3.3 (4.3)
	W/teeth	2.7 (3.5)	2.6 (3.4)	3.1 (4.1)		3.1 (4.1)	3.1 (4.1)
	W/segment edge	2.9 (3.8)	2.8 (3.65)	3.3 (4.3)		3.3 (4.3)	
SPADE NOSE ROCK BUCKET	W/tip type teeth				3.1 (4.1)		3.1 (4.1)
LIGHT MATERIAL BUCKET	W/B.O.C	4.0 (5.2)	4.0 (5.25)	4.6 (6.0)	4.6 (6.0)	4.6 (6.0)	4.6 (6.0)
	W/teeth						
	BARE		3.8 (4.95)				
LIGHT MATERIAL BUCKET	For multi-coupler		3.1 (4.0)				
GENERAL PURPOSE BUCKET (STOCKPILE) FOR HIGH LIFT BOOM	W/B.O.C	2.9 (3.8)	2.8 (3.65)	3.3 (4.3)	3.3 (4.3)	3.3 (4.3)	3.3 (4.3)
	W/teeth	2.7 (3.5)	2.6 (3.4)	3.1 (4.0)	3.1 (4.0)	3.1 (4.0)	3.1 (4.0)
GENERAL PURPOSE BUCKET FOR SUPER HIGH LIFT BOOM (STOCKPILE)	W/B.O.C						
	W/teeth						
HIGH LIFT BOOM		○	○	○	○	○	○
SUPER-HIGH LIFT BOOM							
B.O.C (BOLT ON CUTTING EDGE)		○	○	○	○	○	○
B.O.C, LONG LIFE			○				○
SEGMENT EDGE		○	○	○	○	○	○
TEETH	Bolt-on teeth	○	○	○	○	○	○
	Bolt-on teeth for limestone		○		○		○
	Bolt-on teeth for long life		○		○		○
	Tip type teeth		○	○	○	○	○
LOG GRAPPLE	Pin on type	○	○	○ ^{*8}	○ ^{*8}	○ ^{*8}	○ ^{*8}
LUMBER GRAPPLE							
DUMPING FORK	Pin-on type	○	○				
	Multi-coupler						
LUMBER FORK	Pin-on type	○	○				
	Multi-coupler						
EXTENSION FORK							
MULTI-COUPLER	Mech. type						
	Hyd. type						
COUNTERWEIGHT	Additional	○	○	○	○	○	○
	For log & fork	○	○	○	○	○	○
BUCKET CYLINDER (LARGE SIZED)	For log & fork	○					
BUCKET CYLINDER	For high lift	○	○		○		○
PALLAET FORK							

*8 : Install the counterweight for log & fork attachments.

**Attachment
Availability**

WHEEL LOADERS

Unit: m³ (cu.yd)

		WA470-6	WA470-5	WA470-3	WA480-6
GENERAL PURPOSE BUCKET (STOCKPILE)	W/B.O.C	4.2 (5.5)	4.2 (5.5)	4.2 (5.5)	4.6 (6.0)
	W/teeth	3.9 (5.1)	3.9 (5.1)	3.9 (5.1)	4.3 (5.6)
	W/segment edge			4.2 (5.5)	
GENERAL PURPOSE BUCKET (EXCAVATING)	W/B.O.C	3.8 (5.0)	3.8 (5.0)	3.8 (4.95)	4.1 (5.4)
	W/teeth	3.6 (4.7)	3.6 (4.7)	3.6 (4.7)	3.8 (5.0)
	W/segment edge	3.8 (5.0)	3.8 (5.0)	3.8 (4.95)	4.1 (5.4)
GENERAL PURPOSE BUCKET FOR HIGH LIFT BOOM (STOCKPILE)	W/B.O.C	3.8 (5.0)	3.8 (5.0)	3.8 (4.95)	
	W/teeth		3.6 (4.7)	3.6 (4.7)	
	W/O teeth				
LOOSE MATERIAL BUCKET	W/B.O.C	4.6 (6.0)	4.6 (6.0)		4.9 (6.4)
	BARE	5.2 (6.8)	4.3 (5.6)		
LIGHT MATERIAL BUCKET	W/B.O.C		5.2 (6.8)	5.2 (6.8)	6.1 (8.0)
	BARE		4.9 (6.4)	4.9 (6.4)	
SPADE NOSE ROCK BUCKET (V-EDGE)	W/tip type teeth		3.6 (4.7)	3.5 (4.6)	
	W/O teeth		3.6 (4.7)	3.5 (4.6)	
ROCK BUCKET (STRAIGHT EDGE)	W/teeth	3.6 (4.7)			
	W/O teeth				
HEAVY-DUTY BUCKET (SPADE NOSE)	W/teeth bolt on segments				
	W/O teeth				
BUCKET FOR TWO-WAY DUMP	W/B.O.C		3.0 (3.9)		
	W/O teeth		3.0 (3.9)		
COAL BUCKET					
HIGH LIFT BOOM			○	○	
SHORT BOOM	For load & carry specs.				
	For stone handling specs.				
B.O.C(BOLT ON CUTTING EDGE)		○	○	○	
B.O.C, LONG LIFE			○	○	○
SEGMENT EDGE		○	○	○	○
TEETH	Bolt-on teeth	○	○	○	○
	Bolt-on teeth for long life		○	○	
	Bolt-on teeth for limestone		○	○	
	Tip type bolt on	○	○	○	○
	Tip type teeth for semi-long				
	Tip type weld on		○		
	Tip type weld on (sharp)				
	Tip type teeth for long life				
Tip type teeth for limestone (sharp)					
LOG GRAPPLE			○*8	○*8	
LOG-LUMBER FORK					
LOG-LUMBER GRAPPLE					
PIPE GRAPPLE					
ROLLING GUSSET					
COUNTER-WEIGHT	Additional	○	○	○	○
	For log & fork ATT.		○	○	
	For high lift boom		○		
	For load & carry specs, with short boom				
	For stone handling specs.with short boom				
BUCKET CYLINDER (LARGE SIZED)	For log & fork				
BUCKET CYLINDER	For high lift		○	○	

*8 : Install the counterweight for log & fork attachments.

**Attachment
Availability**

WHEEL LOADERS

Unit: m³ (cu.yd)

		WA500-6	WA500-6R	WA500-3	WA600-6	WA600-6R	WA600-3
GENERAL PURPOSE BUCKET (STOCKPILE)	W/B.O.C	○ 5.6 (7.3)	○ 5.6 (7.3)	○ 5.0 (6.5)			
	W/teeth	○ 5.3 (6.9)	○ 5.3 (6.9)	○ 4.7 (6.1)			
	W/segment edge				○ 7.0 (9.2)	○ 7.0 (9.2)	
GENERAL PURPOSE BUCKET (EXCAVATING)	W/B.O.C	○ 5.2 (6.8)	○ 5.2 (6.8)	○ 4.5 (5.9)			○ 6.4 (8.4)
	W/teeth	○ 5.0 (6.5)	○ 5.0 (6.5)	○ 4.3 (5.6)	○ 6.5 (8.5)	○ 6.5 (8.5)	○ 6.1 (8.0)
	W/segment edge	○ 5.2 (6.8)	○ 5.2 (6.8)	○ 4.5 (5.9)			
GENERAL PURPOSE BUCKET FOR HIGH LIFT BOOM (STOCKPILE)	W/B.O.C						
	W/teeth			○ 4.2 (5.5)			○ 5.6 (7.3)
	W/O teeth						○ 5.6 (7.3)
GENERAL PURPOSE BUCKET (EXCAVATING) FOR HIGH LIFT STRAIGHT EDGE	W/B.O.C	○ 4.5 (5.9)	○ 4.5 (5.9)	○ 4.2 (5.5)			
	W/teeth	○ 4.3 (5.6)	○ 4.3 (5.6)	○ 4.0 (5.25)			○ 5.6 (7.3)
	W/segment edge	○ 4.5 (5.9)	○ 4.5 (5.9)	○ 4.2 (5.5)			
LIGHT MATERIAL BUCKET	W/B.O.C			○ 5.5 (7.15)			
	BARE			○ 5.2 (6.8)			
SPADE NOSE ROCK BUCKET (V-EDGE)	W/tip type teeth			○ 4.3 (5.6)			○ 6.1 (8.0)
	W/O teeth			○ 4.3 (5.6)			○ 6.1 (8.0)
	W/segment edge				○ 6.4 (8.4)	○ 6.4 (8.4)	
SPADE NOSE ROCK BUCKET (V-EDGE) FOR HIGH LIFT BOOM	W/tip type teeth						○ 5.6 (7.3)
	W/O teeth						○ 5.6 (7.3)
SPADE NOSE ROCK BUCKET (V-EDGE) FOR LOAD & CARRY SPECS, WITH SHORT ARM.	Tip type teeth with Weld-on						○ 7.5 (9.8)
ROCK BUCKET (STRAIGHT EDGE)	W/teeth						
	W/O teeth						
HEAVY-DUTY ROCK BUCKET (SPADE NOSE)	W/teeth bolt on segments	○ 5.0 (6.5)	○ 5.0 (6.5)	○ 4.5 (5.9)			
	W/O teeth	○ 4.7 (6.1)	○ 4.7 (6.1)				
COAL BUCKET							○ 11.0(14.4)
HIGH LIFT BOOM		○	○	○*3			○*4
SHORT BOOM					○*9	○*9	
SHORT BOOM	For load & carry specs.						○*6
	For stone handling specs.						○
BOC(BOLT ON CUTTING EDGE)		○	○	○	○	○	○
BOC, LONG LIFE							
SEGMENT EDGE				○	○	○	○
TEETH	Bolt-on teeth	○	○	○			○
	Bolt-on teeth for long life						
	Bolt-on teeth for limestone						
	Tip type bolt on	○	○	○	○	○	○
	Tip type teeth for semi-long						
LOG GRAPPLE	Tip type weld on			○			○
		○*8		○*8			
COUNTER- WEIGHT	Additional	○	○	○	○	○	○
	For log & fork ATT.	○		○	○	○	○
	For high lift boom	○		○			○
	For load & carry specs, with short boom						○
	For stone handling specs,with short boom						

*3 : Install the 4.2 m³ (5.5 cu.yd) general purpose bucket and counterweight for high lift boom.

*4 : Install the 5.6 m³ (7.3 cu.yd) general purpose bucket and counterweight for high lift boom.

*6 : Install the 7.5 m³ (9.8 cu.yd) spade nose bucket and counterweight for load & carry specs.

*7 : Install the 14.0 m³ (18.3 cu.yd) spade nose bucket and additional counterweight.

*8 : Install the counterweight for log & fork attachments.

*9 : Boom length 3850 mm (12'8")

**Attachment
Availability**

WHEEL LOADERS

Unit: m³ (cu.yd)

		WA700-3	WA800-3E0	WA800-3	WA900-3E0	WA900-3	WA1200-6
GENERAL PURPOSE BUCKET (STOCKPILE)	W/B.O.C						
	W/teeth	9.4 (12.3)					
	W/segment edge	9.4 (12.3)					
GENERAL PURPOSE BUCKET (EXCAVATING)	W/B.O.C						
	W/teeth	8.7 (11.4)					
	W/segment edge	8.7 (11.4)					
GENERAL PURPOSE BUCKET FOR HIGH LIFT BOOM (STOCKPILE)	W/B.O.C						
	W/teeth						
	W/O teeth						
GENERAL PURPOSE BUCKET (EXCAVATING) FOR HIGH LIFT STRAIGHT EDGE	W/B.O.C						
	W/teeth						
	W/segment edge						
LOOSE MATERIAL BUCKET	W/B.O.C						
	BARE						
LIGHT MATERIAL BUCKET	W/B.O.C						
	BARE						
SPADE NOSE ROCK BUCKET (V-EDGE)	W/tip type teeth	8.7 (11.4)	11.0 (14.4)	11.0 (14.4)	13.0 (17.0)	13.0 (17.0)	20.0 (26.2)
	W/O teeth	8.7 (11.4)	11.0 (14.4)	11.0 (14.4)	13.0 (17.0)	13.0 (17.0)	20.0 (26.2)
	W/segment edge						
SPADE NOSE STOCK PILE	W/ teeth		12.3 (16.1)	12.3 (16.1)			
	W/B.O.C		11.0 (14.4)	11.0 (14.4)			
SPADE NOSE ROCK BUCKET (V-EDGE) FOR HIGH LIFT BOOM	W/tip type teeth		10.0 (13.1)	10.0 (13.1)	11.5 (15.0)	11.5 (15.0)	18.0 (23.5)
	W/O teeth						
SPADE NOSE ROCK BUCKET (V-EDGE) FOR LOAD & CARRY SPECS, WITH SHORT ARM.	Tip type teeth with Weld-on		○	○			
ROCK BUCKET (STRAIGHT EDGE)	W/teeth						
	W/O teeth						
HEAVY-DUTY ROCK BUCKET (SPADE NOSE)	W/teeth bolt on segments	8.7 (11.4)	11.0 (14.4)	11.0 (14.4)			
	W/O teeth						
COAL BUCKET				20.5 (26.8)			35.0 (45.8)
HIGH LIFT BOOM			○ ^{*5}	○ ^{*5}	○	○	○
SHORT BOOM							
SHORT BOOM	For load & carry specs.		○ ^{*7}	○ ^{*7}			
	For stone handling specs.						
BOC(BOLT ON CUTTING EDGE)							
BOC, LONG LIFE							
SEGMENT EDGE							
TEETH	Bolt-on teeth						
	Bolt-on teeth for long life						
	Bolt-on teeth for limestone						
	Tip type bolt on						
	Tip type teeth for semi-long		○	○	○	○	
	Tip type weld on	○	○	○	○	○	
	Tip type weld on (sharp)	○	○	○	○	○	○
	Tip type teeth for long life				○	○	
Tip type teeth for limestone (sharp)	○	○	○	○	○		
LOG GRAPPLE	○ ^{*8}						
COUNTER- WEIGHT	Additional	○	○	○			
	For log & fork ATT.	○					
	For high lift boom	○	○	○	○	○	
	For load & carry specs, with short boom		○	○			
	For stone handling specs,with short boom						

*5 : Install the 10.0 m³ (13.1 cu.yd) bucket and additional counterweight.

*6 : Install the 7.5 m³ (9.8 cu.yd) spade nose bucket and counterweight for load & carry specs.

*7 : Install the 14.0 m³ (18.3 cu.yd) spade nose bucket and additional counterweight.

*8 : Install the counterweight for log & fork attachments.

1. General Purpose Bucket (Stockpile):

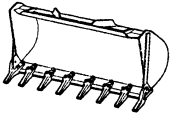

This bucket is used for loading stockpile products, such as crushed rock and construction materials.

2. General Purpose Bucket (Excavating):

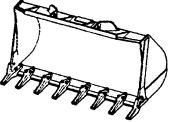

This bucket is used for excavating and loading blasted rock on rock crushing job sites, or for excavating natural ground. It has a flat-blade, straight cutting edge, and provides superior rigidity and wear resistance.

3. Light Material Bucket:

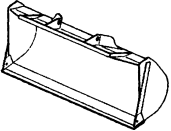

This bucket is used for loading materials with comparatively light specific gravity [below 1.2 t/m³ (2000 lb/cu.yd)], such as snow, fertilizer, and livestock feed. It is based on the general purpose bucket, with a lengthened cutting edge and width to give increased capacity. There is also a large capacity coal bucket for loading loose coal with a specific gravity of below 0.89 t/m³ (1500 lb/cu.yd).

4. Spade-nose Rock Bucket (V-edge type):

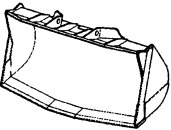

This bucket is used for excavating and loading blasted rock on rock crushing job sites. It has a pointed cutting edge, and provides superior rigidity and wear resistance.

5. Heavy-duty Bucket:

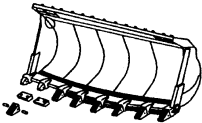

This bucket is used for digging and loading blasted rock on rubble mounds and rock crushing job sites. It has 1-class-larger teeth, and a large, thicker wear plate, large corner edge/side guard, and strengthened spill guard.

NOTE: When installing this bucket on machines other than the WA700 or WA800, to maintain the stability of the machine, please install an additional counterweight and an orifice (or retainer) for reducing the dumping shock of the bucket .

6. Chip Bucket:

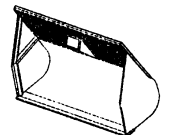

This is a large bucket used for loading loose materials with low specific gravity [below 0.55 t/m³ (930 lb/cu.yd)], such as chips and grain. The back and top are made of a wire mesh to reduce the weight. This bucket can demonstrate its power in bucket operations in the paper-manufacturing business and sawmills.

7. Skeleton Bucket:

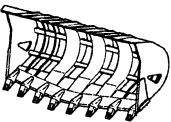

This bucket is used for digging and loading blasted rock on rubble mounds and rock crushing job sites. It has a lattice structure allows it to sift out soil and small rocks, thereby enabling it to select only the rock materials.

8. Side Dump Bucket:

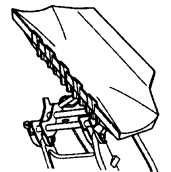

This bucket is capable of dumping its load to the front, to one side, or to both sides. These features make it the choice for jobs like tunneling work, road construction or snow clearance, where narrow operating areas restrict maneuverability.

9. Multi-purpose Bucket:

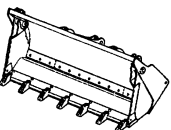

This is a versatile bucket that performs scraping, dozing, scooping and various other tasks in addition to excavating and loading jobs. It is especially suited to leveling work and material transport.

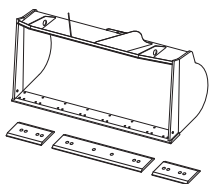
1. Bolt-on Cutting Edge:

FVBH0217

This edge is made for use in loading loose sand and soil, or for loading stockpiled materials. It is bolted to the leading edge of general purpose buckets and may be detached and reversed. The cutting edges are manufactured from especially heat treated, high tension steel, and since they are reversible, both edges can be used. This effectively doubles their working life.

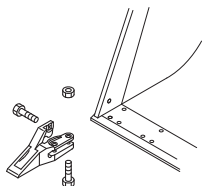
2. Bolt-on Teeth:

FVBH0218

These teeth are suitable for loading or excavation of piles of earth or sand, blasted rock, and jobs in the field that involve digging into the side of slopes. The special heat treated, tensile strength steel alloy used in their production assures that they will wear and have a long service life.

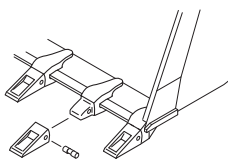
3. Tip-type Teeth:

FVBH0219

These teeth tips which are attached to an adapter that is welded or bolted to the bucket edge. This means that an interchangeable part, the tooth tip, absorbs most of the wear and protects the actual bucket edge. They give excellent performance when used to handle blasted rock, piles of earth and similarly heavy duty tasks.

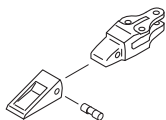

FVBH0220

4. Tip-type Teeth (Long Life):

These teeth are larger than the normal teeth and provide an extended wear life, so they are suitable for use on job sites where there is rapid wear.

5. Tip-type Teeth (Sharp):

These teeth are sharper than the normal size teeth. They are suitable for work in handling large lumps of soft rock, or for grubbing work.

6. Bolt-on Teeth or Tip-type Teeth for Limestone:

These teeth are suitable for excavating or loading soft rock with a low silica content. (For example, limestone, shale or mudstone with low silica content.) These teeth are painted white.

NOTE: These teeth are not suitable for operation in rock with a high silica content, or with hard rocks. If they are used on such job sites, their life will be reduced. In such cases, use the normal teeth.

1. Hensley teeth

1) Features

Tooth

- Penetrative ability can be maintained for long period of time by performing the rotation/ reverse.
- Wear resistance is reinforced with "Through-Hard" (hardened entirely).



Adapter

- Adapter nose is large and sturdy.
- Shape of the adapter is smoothly round which prevents concentration of stress.



Tooth lock pin

- It can be removed and installed easily by using socket wrench.
- It is able to use several times, and economical.



KMAX is easier

KMAX is locked with a latch. This ensures the easiest, safest and most secure locking method for a hammer-less system. No prying or special tools are needed. The teeth can be changed quickly and with minimal effort.



Locked and open position









Remark: The photo shows the tooth for excavators.

2) Teeth Selection

Application model		
Series		Wheel loaders
KMAX	XS	STANDARD/HEAVY DUTY
	XS04	WA75-WA100
	XS05	WA120-WA180
	XS10	WA200
K15	XS15	WA250-WA380
K20	XS20	WA400-WA450
K25	XS25	WA500
K30	XS30	WA260-1
K40	XS40	WA600
K50	XS50	WA600
K70	XS70	WA700
K85	XS85	WA700-WA800
	XS115	WA800-WA900
	XS145	WA1200

KMAX and XS teeth

AG Abrasion: High abrasion	
RP1 Rock penetrator: Good bottom wear and penetration	
RP2 Rock Penetrator: Greater bottom wear and penetration	
ABR Heavy Abrasion: Maximum bottom wear material	
BPS General Purpose: General applications	
RPX Rock Penetrator Heavy: Offers more material for longer wear life	

2. K VX teeth system

1) Features

KVX GET is a "system", where the lip and other GET components work together to bring you unique benefits:

1. Recessed bolt heads mean:

- better penetration & roductivity
- less hang-ups during dumping
- no exposed nuts inside the bucket

2. Threaded lip and/or GET components mean:

- positive retention throughout wear life
- more useable wear material (no mounts or plough bolt heads to wear off)
- elimination of troublesome nuts, washers, lock or retainers

3. KVX bolts mean:

- far superior GET retention than both plough bolt systems & pinned/locked systems
- high strength, enhancing impact resistance & allowing fitment of longer-life components which protrude further in front of the lip than conventional bolt or pin/lock systems can retain

4. Flat faced components mean up to 100% useable steel!

- after use as a GET components, competitive shrouds, adapters & teeth are discarded as scrap (often more than 50% "throw-away"). In contrast, KVX's "flat" GET components are re-used as wear & impact liners elsewhere in the mining operation, saving you money on alterative wear products

5. Adapterless & retainerless KVX design means:

- no adapters, retainers or profile bars to repair or replace
- no adapter, mount or profile bar welding
- almost zero risk of GET loss
- less risk of significant repair and downtime related to site costs due to lost GET parts damaging other plant
- excellent protection for underside of lip & bucket (minimal bucket underside wear)
- thinner frontal GET/lip profile for superior productivity and fuel efficiency plus less wheel spin

6. Sagitta steel means:

- longer GET life than typical castings (due to toughness, hardness and available steel)
- fewer change-outs and less bucket & GET Maintenance
- superior reliability



2) Teeth selection

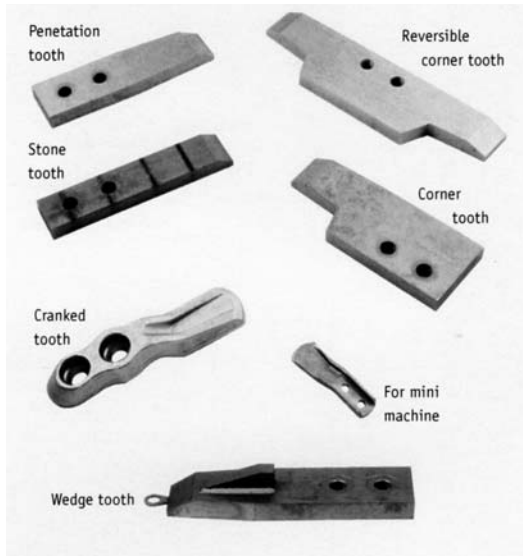

How to select the right K VX system

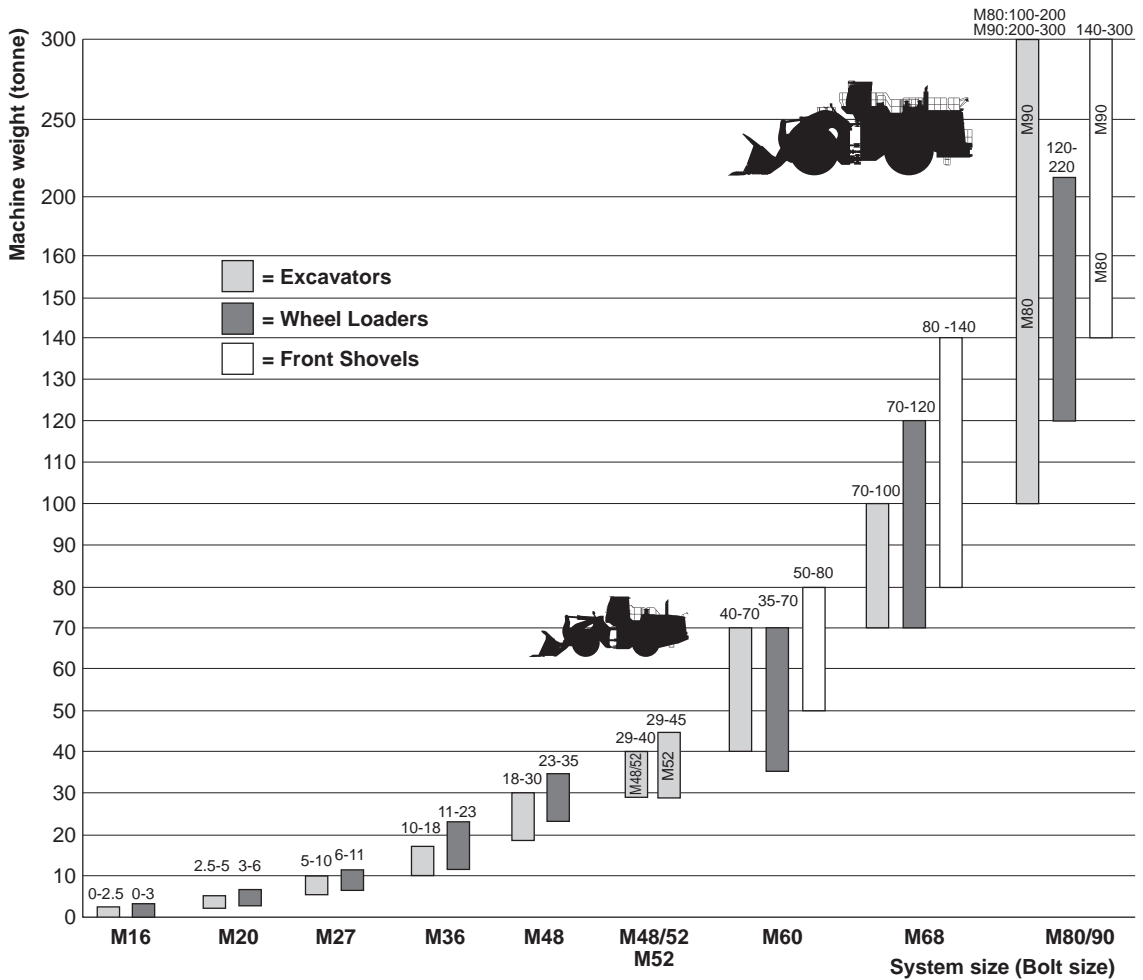

The graph indicates the recommended K VX system based on machine weight.

If in doubt, choose the larger system.

BUCKET SELECTION GUIDE FOR WHEEL LOADER

The optimum bucket type and capacity are determined in consideration of the "type of work" and the "operational stability".

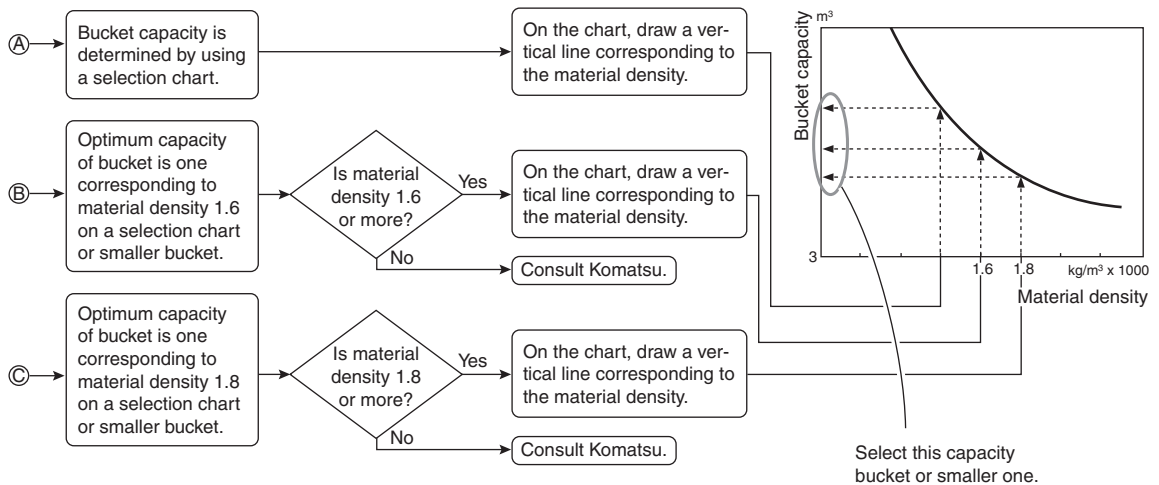
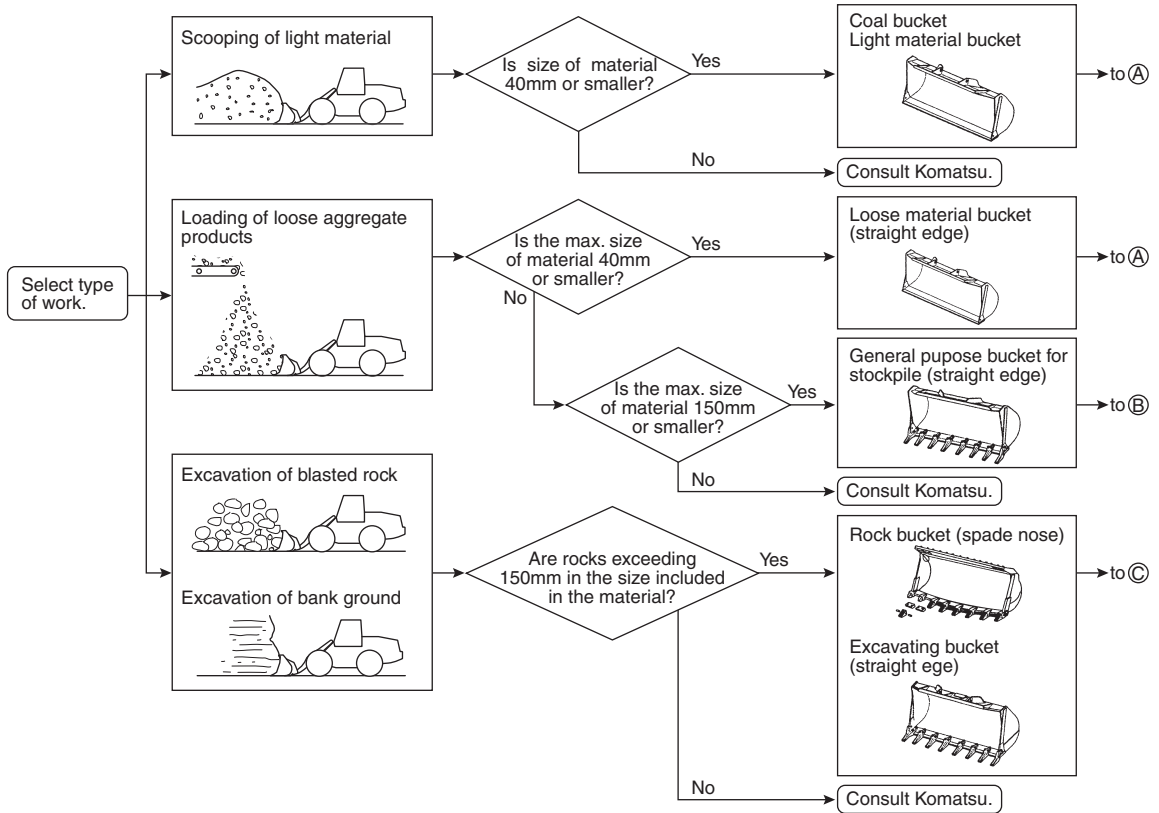

Bucket selection for wheel loader

The appropriate bucket capacity for each model is determined in relation with the density of material that the bucket carries.

The graphs are shown for the models WA120-3. The capacity of the currently available buckets for each model are shown there. Komatsu can develop other sizes of buckets according to these graphs, if it is requested through a distributor.

Bucket capacity in the graphs means SAE heaped capacity (Calculation method indicated on page 3A-130). The line in the graph shows the case when the bucket fill factor is 100%.

WA120-3

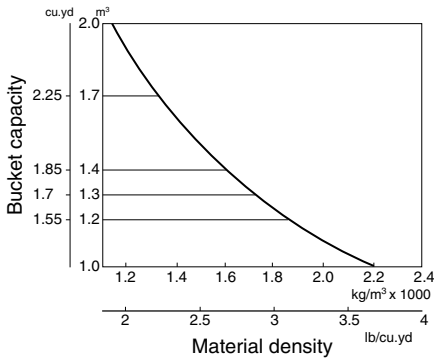

	Capacity Heaped m ³ (cu.yd)	Struck m ³ (cu.yd)
I General-purpose bucket with bolt-on cutting edge; (Loading and excavating of soil, sand and variety of other commonly handled materials)	1.4 (1.85)	1.2 (1.55)
II General-purpose bucket with teeth	1.3 (1.7)	1.1 (1.45)
III Excavating bucket with bolt-on cutting edges	1.2 (1.55)	1.0 (1.3)
IV Excavating bucket with teeth; (Loading and excavating of crushed rock and blasted rock)	1.2 (1.55)	1.0 (1.3)
V Light material bucket with bolt-on cutting edges; (A lighter-weight, large-capacity bucket)	1.7 (2.25)	1.5 (1.95)

WA150-6, WA150-5

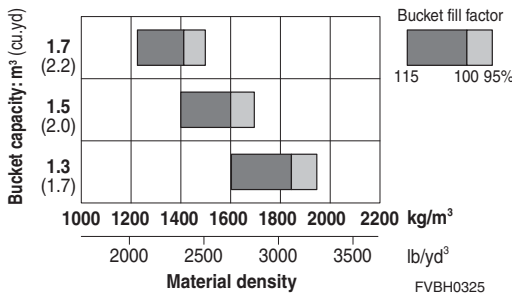

1.7 m ³ (2.2 cu.yd)	Light Material Bucket (Scooping and loading of light material)
1.5 m ³ (2.0 cu.yd)	Stockpile Bucket (Loading and excavating of soil, sand and a variety of other commonly handled material)
1.3 m ³ (1.7 cu.yd)	Excavating Bucket (Loading and excavating of crushed or blasted rock)

WA180-3

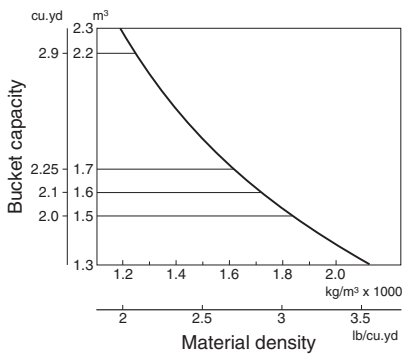

	Capacity Heaped m ³ (cu.yd)	Struck m ³ (cu.yd)
I General-purpose bucket with bolt-on cutting edge; (Loading and excavating of soil, sand and variety of other commonly handled materials)	1.7 (2.25)	1.4 (1.85)
II General-purpose bucket with teeth	1.6 (2.1)	1.3 (1.7)
III Excavating bucket with bolt-on cutting edges	1.5 (2.0)	1.3 (1.7)
IV Excavating bucket with teeth; (Loading and excavating of crushed rock and blasted rock)	1.5 (2.0)	1.2 (1.55)
V Light material bucket with bolt-on cutting edges; (A lighter-weight, large-capacity bucket)	2.2 (2.9)	1.9 (2.5)

WA200-6

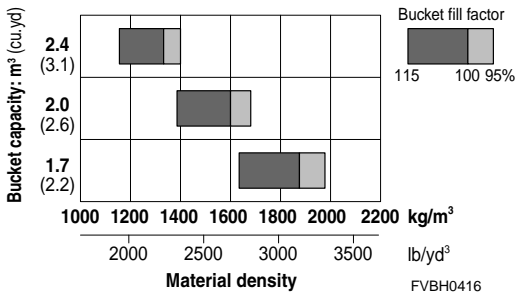

- 2.4 m³ (3.1 cu.yd) Light Material Bucket (Scooping and loading of light material)
- 2.0 m³ (2.6 cu.yd) Stockpile Bucket (Loading and excavating of soil, sand and a variety of other commonly handled material)
- 1.7 m³ (2.2 cu.yd) Excavating Bucket (Loading and excavating of crushed or blasted rock)

WA200-5

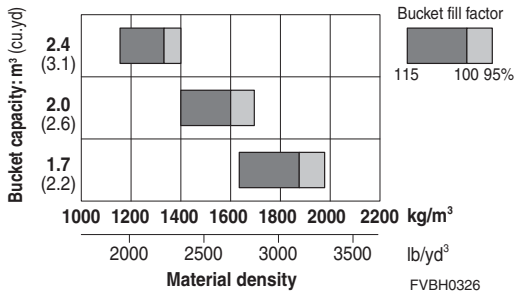

- 2.4 m³ (3.1 cu.yd) Light Material Bucket (Scooping and loading of light material)
- 2.0 m³ (2.6 cu.yd) Stockpile Bucket (Loading and excavating of soil, sand and a variety of other commonly handled material)
- 1.7 m³ (2.2 cu.yd) Excavating Bucket (Loading and excavating of crushed or blasted rock)

WA200PZ-6

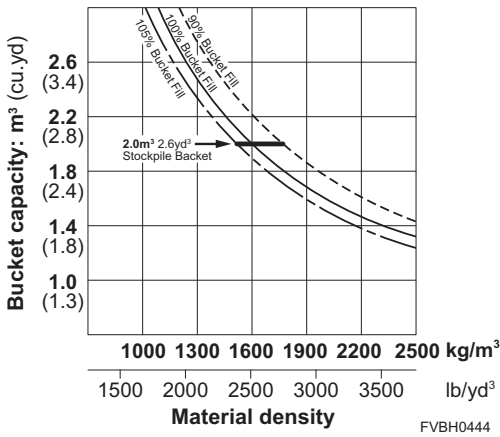

- 2.0 m³ (2.6 cu.yd) Stockpile Bucket (Loading and excavating of soil, sand and a variety of other commonly handled material)

WA250-6

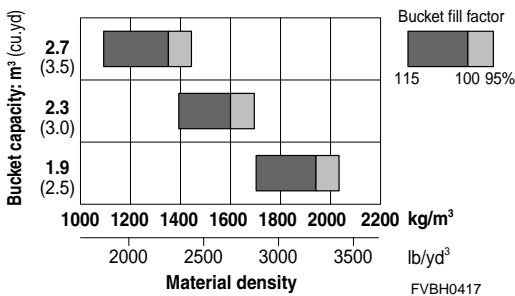

- 2.7 m³ (3.5 cu.yd) Light Material Bucket (Scooping and loading of light material)
- 2.3 m³ (3.0 cu.yd) Stockpile Bucket (Loading and excavating of soil, sand and a variety of other commonly handled material)
- 1.9 m³ (2.5 cu.yd) Excavating Bucket (Loading and excavating of crushed or blasted rock)

WA250-5

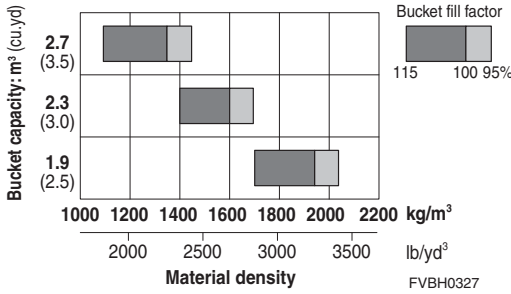

- 2.7 m³ (3.5 cu.yd) Light Material Bucket (Scooping and loading of light material)
- 2.3 m³ (3.0 cu.yd) Stockpile Bucket (Loading and excavating of soil, sand and a variety of other commonly handled material)
- 1.9 m³ (2.5 cu.yd) Excavating Bucket (Loading and excavating of crushed or blasted rock)

WA250PZ-6

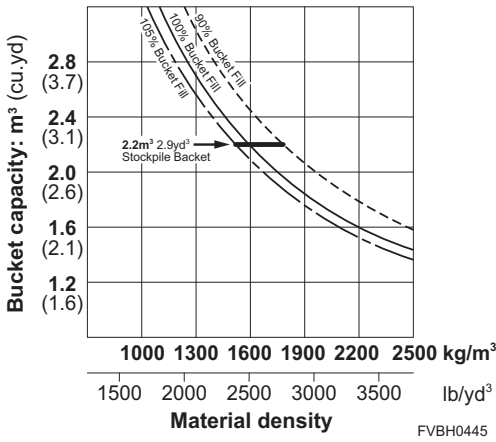

- 2.2 m³ (2.9 cu.yd) Stockpile Bucket (Loading and excavating of soil, sand and a variety of other commonly handled material)

WA320-6

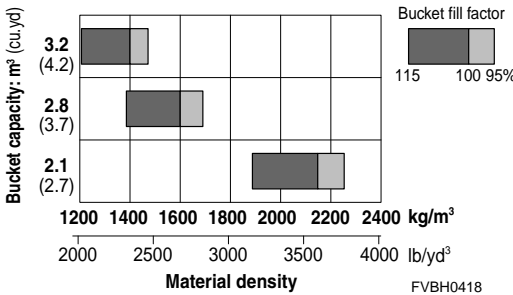

- 3.2 m³ (4.2 cu.yd) Light Material Bucket with B.O.C. (Scooping and loading of light material)
- 2.8 m³ (3.7 cu.yd) Stockpile Bucket with B.O.C. (Loading and excavating of soil, sand and a variety of other commonly handled material)
- 2.1 m³ (2.7 cu.yd) Excavating Bucket with Teeth (Loading and excavating of crushed or blasted rock)

WA320PZ-6

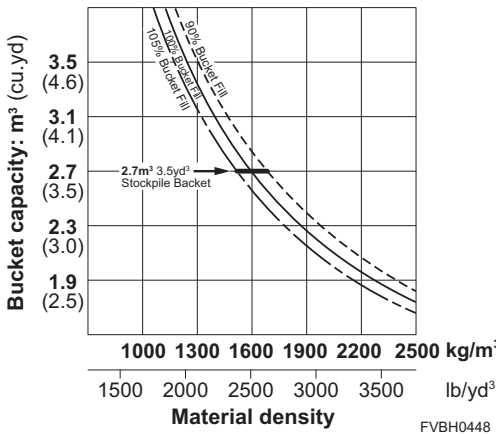

- 2.7 m³ (3.5 cu.yd) Stockpile Bucket (Loading and excavating of soil, sand and a variety of other commonly handled material)

WA320-5

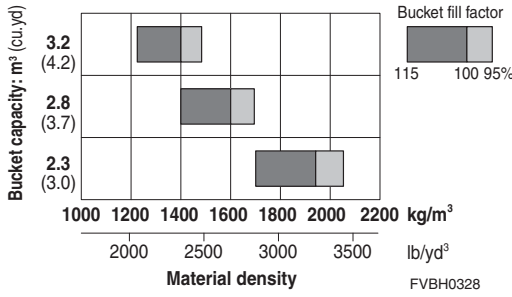

- 3.2 m³ (4.2 cu.yd) Light Material Bucket (Scooping and loading of light material)
- 2.8 m³ (3.7 cu.yd) Stockpile Bucket (Loading and excavating of soil, sand and a variety of other commonly handled material)
- 2.3 m³ (3.0 cu.yd) Excavating Bucket (Loading and excavating of crushed or blasted rock)

WA320-3 CUSTOM

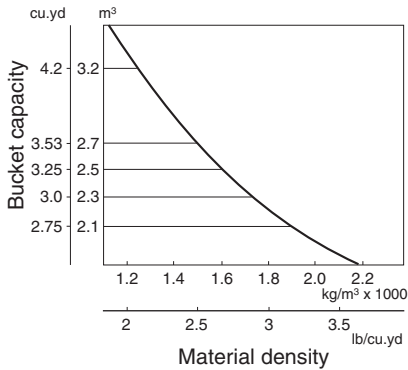

- | | Capacity Heaped m ³ (cu.yd) | Struck m ³ (cu.yd) |
|--|--|-------------------------------|
| I General-purpose bucket with bolt-on cutting edge; (Loading and excavating of soil, sand and variety of other commonly handled materials) | 2.7 (3.53) | 2.3 (3.01) |
| II General-purpose bucket with teeth | 2.5 (3.0) | 1.95 (2.55) |
| III Excavating bucket with bolt-on cutting edges | 2.3 (3.0) | 1.95 (2.55) |
| IV Excavating bucket with teeth (Loading and excavating of crushed rock and blasted rock) | 2.1 (2.75) | 1.8 (2.35) |
| V Light material bucket with bolt-on cutting edges; (A lighter-weight, large-capacity bucket) | 3.2 (4.2) | 2.8 (3.7) |

WA380-6, WA380Z-6

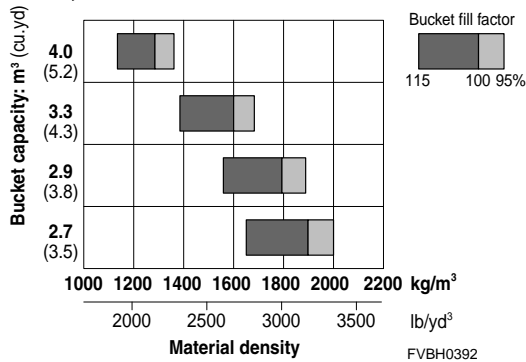

- 4.0 m³ (5.2 cu.yd) Light Material Bucket with B.O.C. (Scooping and loading of light material)
- 3.3 m³ (4.3 cu.yd) General Purpose Bucket with B.O.C. (Loading and excavating of soil, sand and a variety of other commonly handled material)
- 2.9 m³ (3.8 cu.yd) Excavating Bucket with B.O.C. Excavating Bucket with Teeth and Segment Edge (Loading and excavating of crushed or blasted rock)
- 2.7 m³ (3.5 cu.yd) Excavating Bucket with Teeth (Loading and excavating of blasted rock)

WA380-5

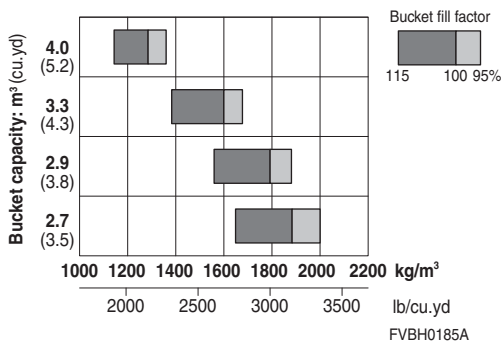

- 4.0 m³ (5.2 cu.yd) Light Material Bucket with B.O.C. (Scooping and loading of light material)
- 3.3 m³ (4.3 cu.yd) General Purpose Bucket with B.O.C. (Loading and excavating of soil, sand and a variety of other commonly handled material)
- 2.9 m³ (3.8 cu.yd) Excavating Bucket with B.O.C. Excavating Bucket with Teeth and Segment Edge (Loading and excavating of crushed or blasted rock)
- 2.7 m³ (3.5 cu.yd) Excavating Bucket with Teeth (Loading and excavating of blasted rock)

WA380-3

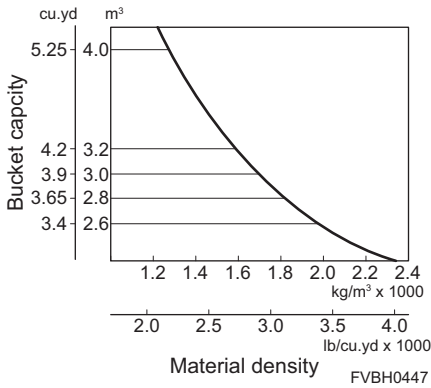

	Capacity Heaped m³ (cu.yd)	Struck m³ (cu.yd)
I General-purpose bucket with bolt-on cutting edge; (Loading and excavating of soil, sand and variety of other commonly handled materials)	3.2 (4.2)	2.7 (3.55)
II General-purpose bucket with teeth	3.0 (3.9)	2.6 (3.9)
III Excavating bucket with bolt-on cutting edges	2.8 (3.65)	2.35 (3.07)
IV Excavating bucket with teeth; (Loading and excavating of crushed rock and blasted rock)	2.6 (3.4)	2.2 (2.9)
V Light material bucket with bolt-on cutting edges; (A lighter-weight, large-capacity bucket)	4.0 (5.25)	3.4 (4.45)

WA430-6

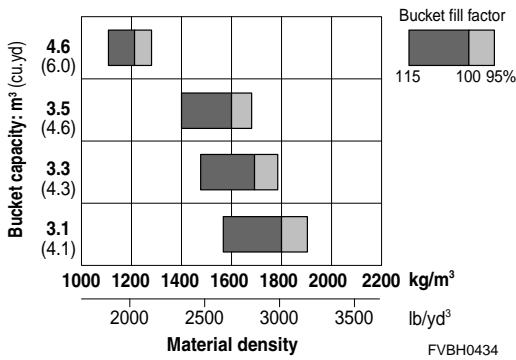

4.6 m³ (6.0 cu.yd)	Light Material Bucket with B.O.C. (Scooping and loading of light material)
3.5 m³ (4.6 cu.yd)	General Purpose Bucket with B.O.C. (Loading and excavating of soil, sand and a variety of other commonly handled material)
3.3 m³ (4.3 cu.yd)	Excavating Bucket with B.O.C. Excavating Bucket with Teeth and Segment Edge (Loading and excavating of crushed or blasted rock)
3.1 m³ (4.1 cu.yd)	Excavating Bucket with Teeth (Loading and excavating of blasted rock)

WA430-5

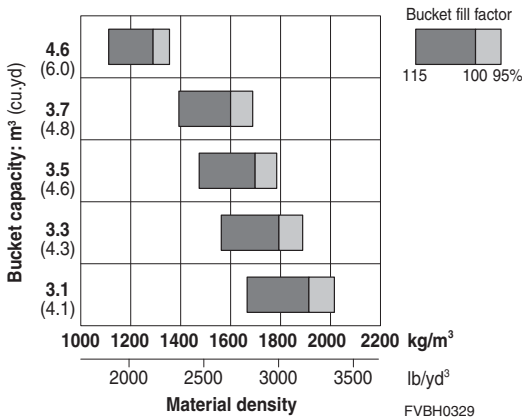

4.6 m³ (6.0 cu.yd)	Light Material Bucket with B.O.C. (Scooping and loading of light material)
3.7 m³ (4.8 cu.yd)	General Purpose Bucket with B.O.C. (Loading of crushed stone and dry sand)
3.5 m³ (4.6 cu.yd)	General Purpose Bucket with Teeth (Loading and excavating of soil, sand and a variety of other commonly handled material)
3.3 m³ (4.3 cu.yd)	Excavating Bucket with B.O.C. Excavating Bucket with Bolt-on Teeth and Segments (Loading or excavating of blasted rock)
3.1 m³ (4.1 cu.yd)	Excavating Bucket with Teeth Rock Bucket with Teeth (Spade Nose) (Loading or excavating of blasted rock)

WA470-6

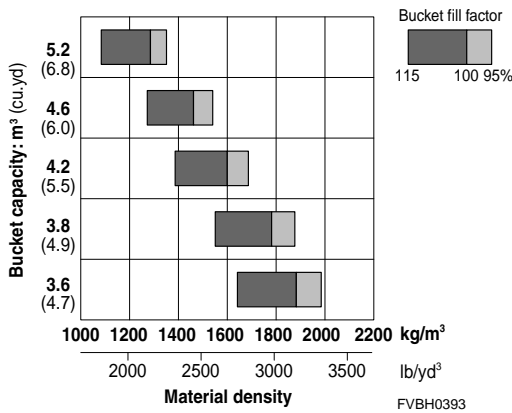

- 5.2 m³ (6.8 cu.yd) Light Material Bucket with B.O.C. (Scooping and loading of light material)
- 4.6 m³ (6.0 cu.yd) Loose Material Bucket with B.O.C. (Loading of crushed stone and dry sand)
- 4.2 m³ (5.5 cu.yd) Stockpile Bucket with B.O.C. (Loading and excavating of soil, sand and a variety of other commonly handled material)
- 3.8 m³ (5.0 cu.yd) Excavating Bucket with B.O.C. Excavating Bucket with Teeth and Segment Edge (Loading and excavating of crushed or blasted rock)
- 3.6 m³ (4.7 cu.yd) Excavating Bucket with Teeth Rock Bucket with Teeth (Spade Nose) (Loading and excavating of blasted rock)

WA470-5

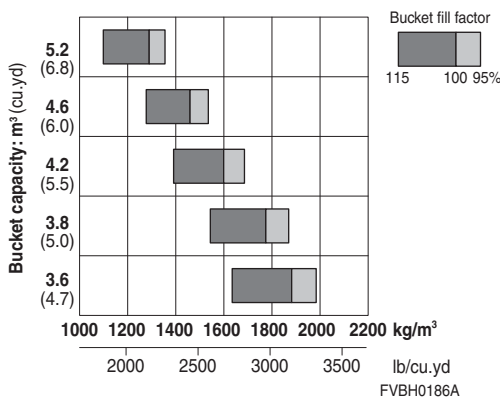

- 5.2 m³ (6.8 cu.yd) Light Material Bucket with B.O.C. (Scooping and loading of light material)
- 4.6 m³ (6.0 cu.yd) Loose Material Bucket with B.O.C. (Loading of crushed stone and dry sand)
- 4.2 m³ (5.5 cu.yd) Stockpile Bucket with B.O.C. (Loading and excavating of soil, sand and a variety of other commonly handled material)
- 3.8 m³ (5.0 cu.yd) Excavating Bucket with B.O.C. Excavating Bucket with Teeth and Segment Edge (Loading and excavating of crushed or blasted rock)
- 3.6 m³ (4.7 cu.yd) Excavating Bucket with Teeth Rock Bucket with Teeth (Spade Nose) (Loading and excavating of blasted rock)

WA470-3

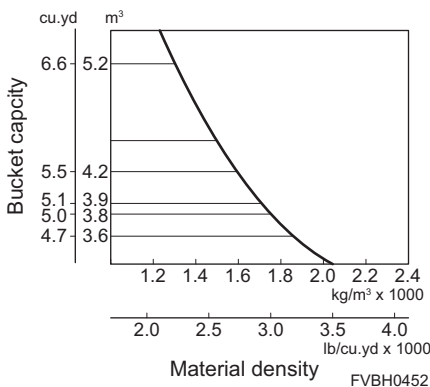

- | | Capacity Heaped m³ (cu.yd) | Struck m³ (cu.yd) |
|--|----------------------------|-------------------|
| I General-purpose bucket with bolt-on cutting edge; (Loading and excavating of soil, sand and variety of other commonly handled materials) | 4.2 (5.5) | 3.6 (4.7) |
| II General-purpose bucket with teeth | 3.9 (5.1) | 3.4 (4.45) |
| III Excavating bucket with bolt-on cutting edges | 3.8 (5.0) | 3.3 (4.3) |
| IV Excavating bucket with teeth; (Loading and excavating of crushed rock and blasted rock) | 3.6 (4.7) | 3.1 (4.05) |
| V Light material bucket with bolt-on cutting edges; (A lighter-weight, large-capacity bucket) | 5.2 (6.8) | 4.5 (5.9) |
| VI Rock bucket with teeth; (Spade nose). (Loading and excavating of blasted rock) | 3.5 (4.6) | 3.0 (3.9) |

WA480-6

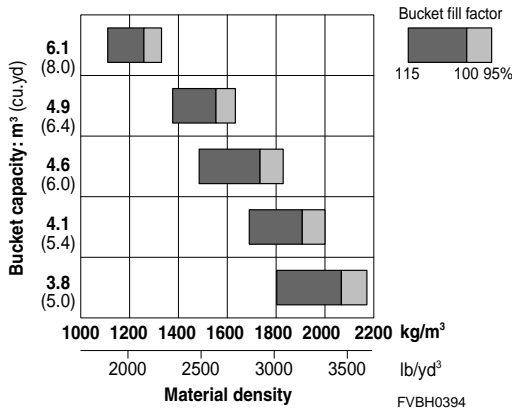

- 6.1 m³ (8.0 cu.yd) Light Material Bucket with B.O.C. (Loading of light material)
- 4.9 m³ (6.4 cu.yd) Loose Material Bucket with B.O.C. (Loading of crushed stone and dry sand)
- 4.6 m³ (6.0 cu.yd) Stockpile Bucket with B.O.C. (Loading and excavating of soil, sand and a variety of other commonly handled material)
- 4.1 m³ (5.4 cu.yd) Excavating Bucket with B.O.C. Excavating Bucket with Teeth and Segment Edge (Loading and excavating of crushed or blasted rock)
- 3.8 m³ (5.0 cu.yd) Excavating Bucket with Teeth (Loading and excavating of blasted rock)

WA500-6, WA500-6R

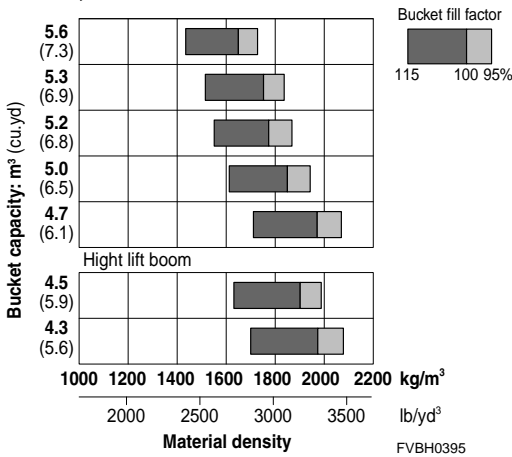

- 5.1 m³ (6.7 cu.yd) General Purpose Bucket with B.O.C.
- 5.3 m³ (6.9 cu.yd) Excavating Bucket with Teeth
- 5.2 m³ (6.8 cu.yd) Excavating Bucket with B.O.C. Excavating Bucket with Teeth and Segments
- 5.0 m³ (6.5 cu.yd) Excavating Bucket with Teeth Rock Bucket with Teeth and Segments (Spade Nose)
- 4.7 m³ (6.1 cu.yd) Rock Bucket with Teeth (Spade Nose)
- 4.5 m³ (5.9 cu.yd) Excavating Bucket with B.O.C. Excavating Bucket with Teeth and Segments
- 4.3 m³ (5.6 cu.yd) Excavating Bucket with Teeth

WA500-3

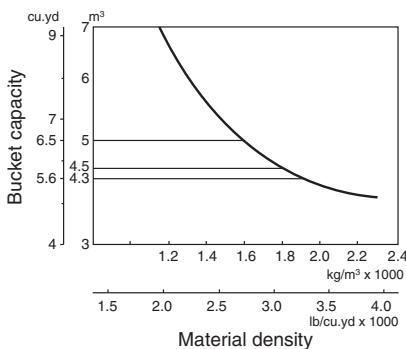

- | | | Capacity Heaped m ³ (cu.yd) | Struck m ³ (cu.yd) |
|-----|---|--|-------------------------------|
| I | Excavating bucket (straight edge) with teeth | 4.3 (5.6) | 3.6 (4.7) |
| II | Excavating bucket (spade nose) with teeth and segment edge | 4.5 (5.9) | 4.1 (5.4) |
| III | General-purpose bucket with bolt on cutting edge without teeth ; Loading stockpile products | 5.0 (6.5) | 4.6 (6.0) |

WA500-3 (High-lift)

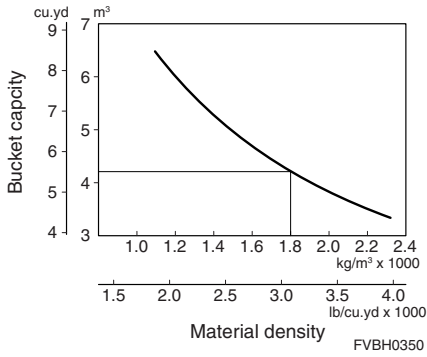

	Capacity Heaped m ³ (cu.yd)	Struck m ³ (cu.yd)
I Excavating bucket (straight edge) with teeth	4.2 (5.6)	3.6 (4.8)

WA600-6, WA600-6R

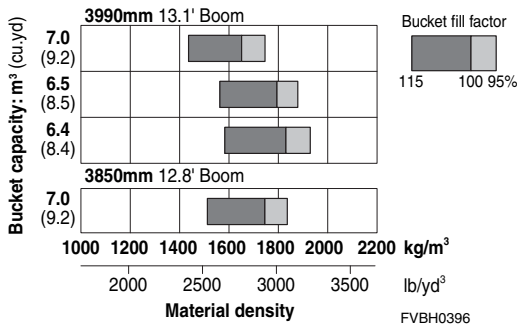

7.0 m ³ (9.2 cu.yd)	Stockpile Bucket with Teeth and weld on Segment edges
6.5 m ³ (8.5 cu.yd)	Excavating Bucket with Teeth and bolt on Segment edges
6.4 m ³ (8.4 cu.yd)	Excavating Bucket with Teeth and weld on Segments edges
7.0 m ³ (9.2 cu.yd)	Excavating Bucket with Teeth and bolt or weld on Segments edges

WA600-3

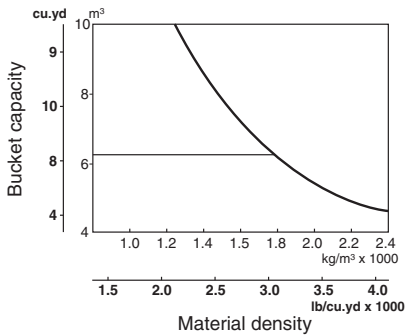

	Capacity Heaped m ³ (cu.yd)	Struck m ³ (cu.yd)
I Excavating bucket (straight edge) with tip teeth	6.1 (8.0)	5.1 (6.7)
II Excavating bucket (spade nose) with tip teeth	6.1 (8.0)	5.1 (6.7)
III Coal bucket (straight edge)	11.0 (14.4)	9.5 (12.4)

WA600-3 (High-lift)

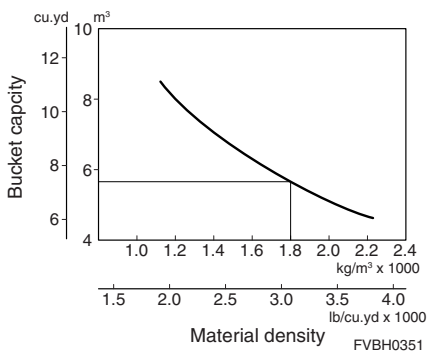

	Capacity Heaped m ³ (cu.yd)	Struck m ³ (cu.yd)
I Excavating bucket (straight edge) with teeth	5.6 (7.3)	4.0 (5.2)
II Excavating bucket (spade nose) with teeth	5.6 (7.3)	4.0 (5.2)

WA700-3

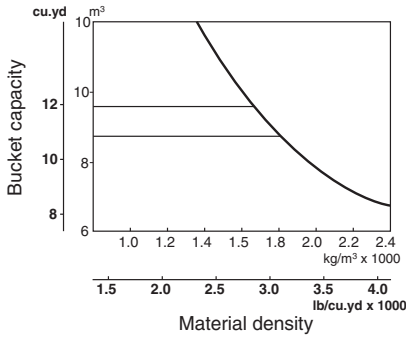

	Capacity Heaped m ³ (cu.yd)	Struck m ³ (cu.yd)
I Excavating bucket (straight edge) without tip teeth	8.7 (11.4)	7.6 (9.9)
II Excavating bucket (spade nose) without tip teeth	8.7 (11.4)	7.6 (9.9)
III General-purpose bucket (straight edge) without tip teeth	9.4 (12.3)	8.2 (10.7)

WA700-3 (High-lift)

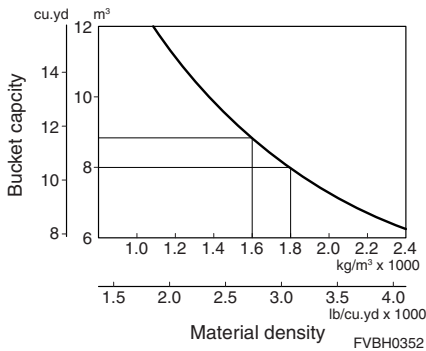

	Capacity Heaped m ³ (cu.yd)	Struck m ³ (cu.yd)
I Excavating bucket (straight edge) with teeth	8.0 (10.5)	7.0 (9.2)
II Stock pile bucket (spade nose) with teeth	8.7 (11.4)	7.6 (5.2)

WA800-3E0

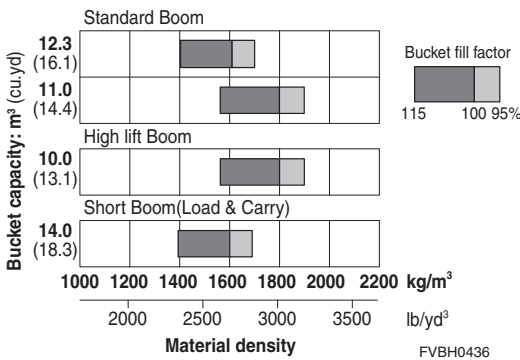

12.3 m ³ (16.1 cu.yd)	Stockpile Bucket (spade nose) with teeth
11.0 m ³ (14.4 cu.yd)	Excavating Bucket (spade nose) with teeth
10.0 m ³ (13.1 cu.yd)	Rock Bucket (spade nose) with teeth
14.0 m ³ (18.3 cu.yd)	Bucket for Load & Carry (spade nose) with teeth

WA800-3

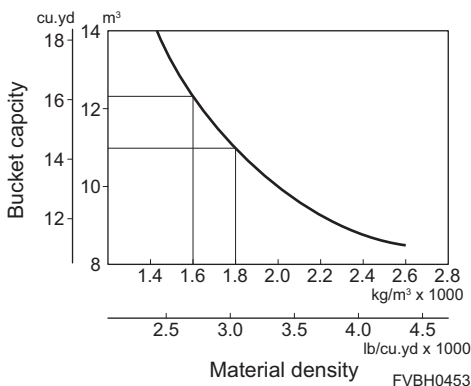

	Capacity Heaped m ³ (cu.yd)	Struck m ³ (cu.yd)
I Excavating bucket (spade nose) with tip teeth	11.0 (14.4)	9.3 (12.2)
II Stockpile (spade nose) with teeth	12.3 (16.1)	10.4 (13.6)

WA800-3 (High-lift)

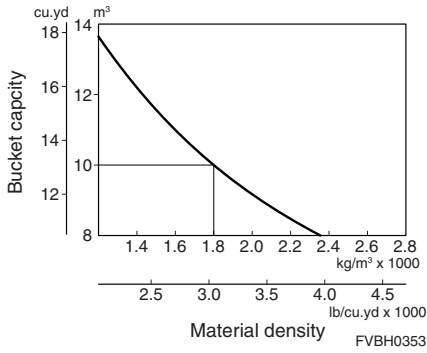

I Excavating bucket (straight edge) with teeth

Capacity Heaped m ³ (cu.yd)	Struck m ³ (cu.yd)
10.0 (13.1)	8.5 (11.1)

WA900-3E0

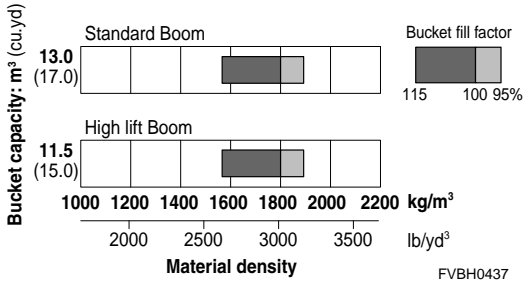

13.0 m³ (17.0 cu.yd) Excavating Bucket (spade nose) with teeth

11.5 m³ (15.0 cu.yd) Rock Bucket (spade nose) with teeth

WA900-3

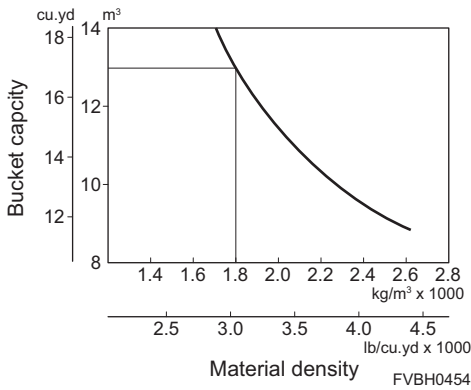

I Excavating bucket (spade nose) with tip teeth

Capacity Heaped m ³ (cu.yd)	Struck m ³ (cu.yd)
13.0 (17.0)	11.0 (14.4)

WA900-3 (High-lift)

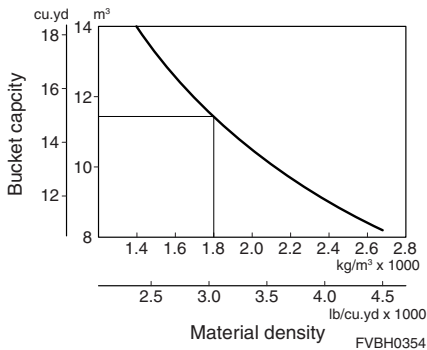

I Excavating bucket (straight edge) with teeth

Capacity Heaped m ³ (cu.yd)	Struck m ³ (cu.yd)
11.5 (15.0)	9.7 (12.7)

WA1200-6

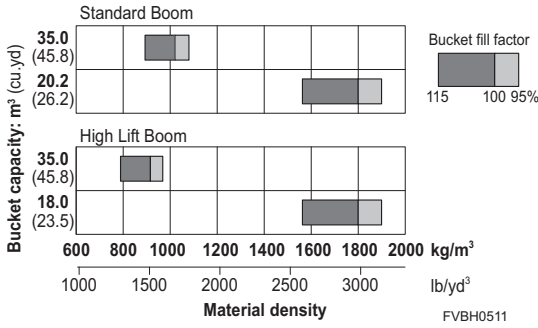

- 35.0 m³ (45.8 cu.yd) Coal Bucket (Spade nose without teeth)
- 20.2 m³ (26.2 cu.yd) Rock Bucket (Spade nose with teeth)
- 35.0 m³ (45.8 cu.yd) Coal Bucket (Spade nose without teeth)
- 18.0 m³ (23.5 cu.yd) Rock Bucket (Spade nose with teeth)

WA200PZ-6 (for USA)

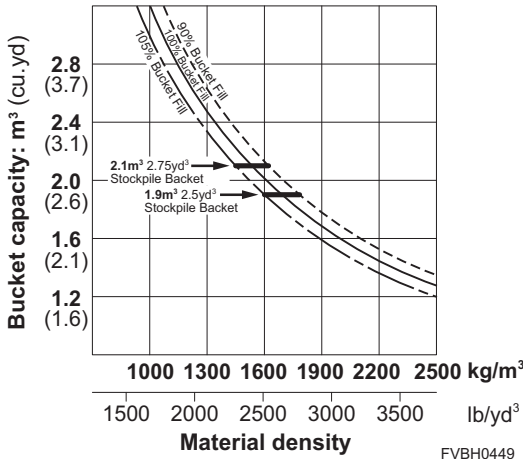

- 2.1 m³ (2.75 cu.yd) Stockpile Bucket with B.O.C. (Loading and excavating of soil, sand and a variety of other commonly handled materials)
- 1.9 m³ (2.5 cu.yd) Stockpile Bucket with B.O.C. (Loading and excavating of soil, sand and a variety of other commonly handled materials)

WA250PZ-6 (for USA)

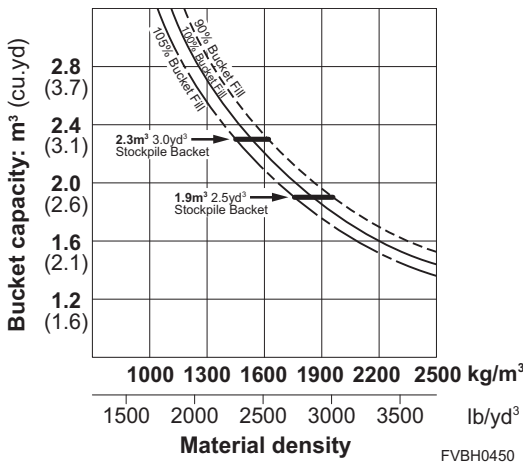

- 2.3 m³ (3.6 cu.yd) Stockpile Bucket with B.O.C. (Loading and excavating of soil, sand and a variety of other commonly handled materials)
- 1.9 m³ (2.5 cu.yd) Stockpile Bucket with B.O.C. (Loading and excavating of soil, sand and a variety of other commonly handled materials)

WA320-6 (USA source)

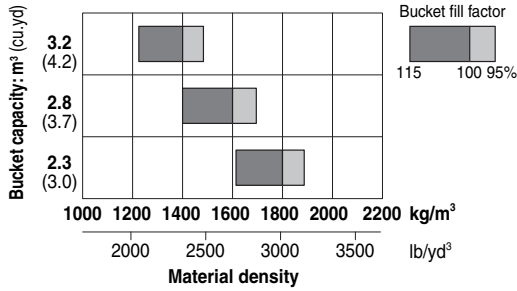

3.2 m³ (4.2 cu.yd) Light Material Bucke (Scooping and loading of light material)

2.8 m³ (3.7 cu.yd) Stockpile Bucket with B.O.C. (Loading and excavating of soil, sand and a variety of other commonly handled material)

2.3 m³ (3.0 cu.yd) Excavating Bucket with B.O.C. (Loading and excavating of crushed or blasted rock)

WA320PZ-6 (for USA)

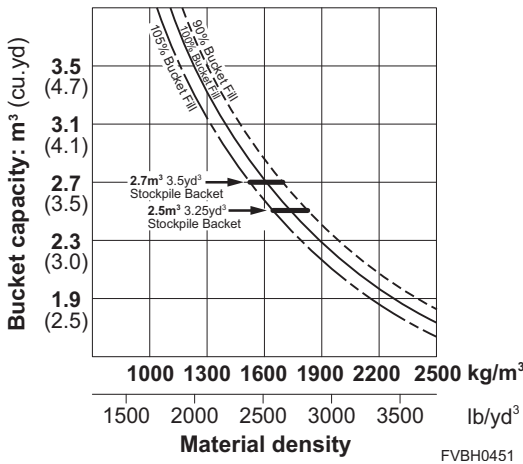

2.7 m³ (3.5 cu.yd) Light Material Bucket with B.O.C. (Scooping and loading of light material)

2.5 m³ (3.25 cu.yd) General Purpose Bucket with B.O.C. (Loading and excavating of soil, sand and a variety of other commonly handled materials)

WA380-7 (USA source)

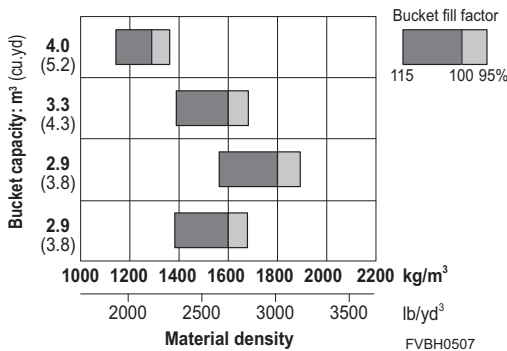

4.0 m³ (5.2 cu.yd) Light Material Bucket with B.O.C. (Scooping and loading of light material)

3.3 m³ (4.3 cu.yd) General Purpose Bucket with B.O.C. (Loading and excavating of soil, sand and a variety of other commonly handled materials)

2.9 m³ (3.8 cu.yd) Excavating Bucket with B.O.C. Excavating Bucket with Teeth and Segment Edge (Loading and excavating of crushed or blasted rock.)

2.9 m³ (3.8 cu.yd) High Lift Boom Excavating Bucket with B.O.C.

WA430-6 (USA source)

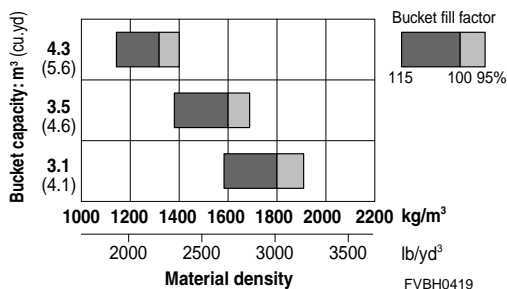

4.3 m³ (5.6 cu.yd) Light Material Bucket with B.O.C. (Scooping and loading of light material)

3.5 m³ (4.6 cu.yd) General Purpose Bucket with B.O.C. (Loading and excavating of soil, sand and a variety of other commonly handled material)

3.1 m³ (4.1 cu.yd) Excavating Bucket with B.O.C. (Loading and excavating of crushed or blasted rock)

WA470-7 (USA source)

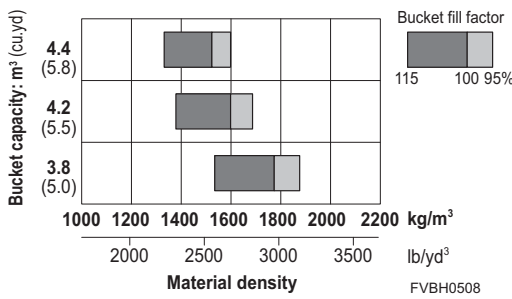

4.4 m³
(5.8 cu.yd)

Loose Material Bucket with B.O.C.

4.2 m³
(5.5 cu.yd)

General Purpose
(Loading and excavating of soil, sand and a variety of other commonly handled material)

3.8 m³
(5.0 cu.yd)

Excavating Bucket with B.O.C.
(Loading and excavating of crushed or blasted rock)

FVBH0508

WA480-6 (USA source)

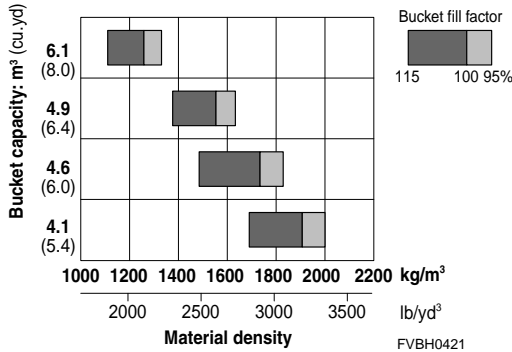

6.1 m³
(8.0 cu.yd)

Light Material Bucket with B.O.C.
(Loading of light material)

4.9 m³
(6.4 cu.yd)

Loose Material Bucket with B.O.C.
(Loading of crushed stone and dry sand)

4.6 m³
(6.0 cu.yd)

Stockpile Bucket with B.O.C.
(Loading and excavating of soil, sand and a variety of other commonly handled material)

4.1 m³
(5.4 cu.yd)

Excavating Bucket with B.O.C.
(Loading and excavating of crushed or blasted rock)

FVBH0421

WA500-7 (USA source)

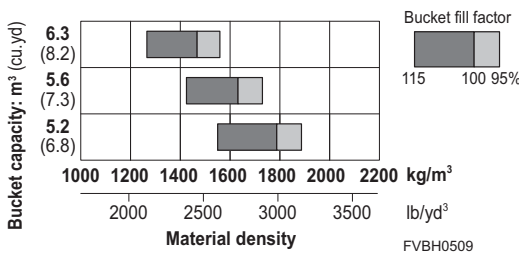

6.3 m³
(8.2 cu.yd)

Loose Material Bucket with B.O.C.E.

5.6 m³
(7.3 cu.yd)

General Purpose Bucket with B.O.C.E.

5.2 m³
(6.8 cu.yd)

Excavating Bucket with B.O.C.E.
Excavating Bucket with teeth & segments
(Spade Nose)

FVBH0509

WA380-7 (for EU)

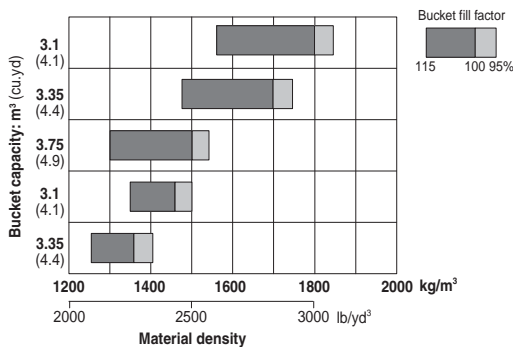

3.1 m³
(4.1 cu.yd)

Bucket with flat bottom w.teeth

3.35 m³
(4.4 cu.yd)

Bucket with raised botom w.BOC

3.75 m³
(4.9 cu.yd)

Bucket with raised botom w.BOC

3.1 m³
(4.1 cu.yd)

Bucket with flat bottom w.teeth
(high-lift mount)

3.35 m³
(4.4 cu.yd)

Bucket with raised bottom w.BOC
(hight-lift-mount)

WA380-6 (Germany source)

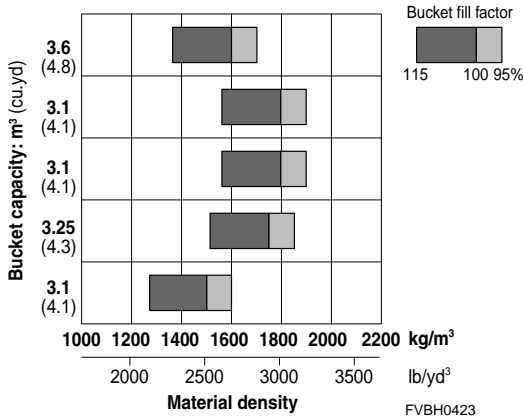

- 3.6 m³ (4.8 cu.yd) Stockpile bucket
Loading loosened or broken material
- 3.1 m³ (4.1 cu.yd) Universal/Earth-moving bucket
Ideal for road-building or earthworks, or for load & carry uses
- 3.1 m³ (4.1 cu.yd) Heavy-duty bucket
Loading and loosening of particularly abrasive materials
- 3.25 m³ (4.3 cu.yd) Universal bucket (quick coupler mount)
Ideal for road-building or earthworks, or for load & carry uses
- 3.1 m³ (4.1 cu.yd) Universal/Earth-moving bucket (high-lift mount)
Ideal for road-building or earthworks, or for load & carry uses

WA430-6 (Germany source)

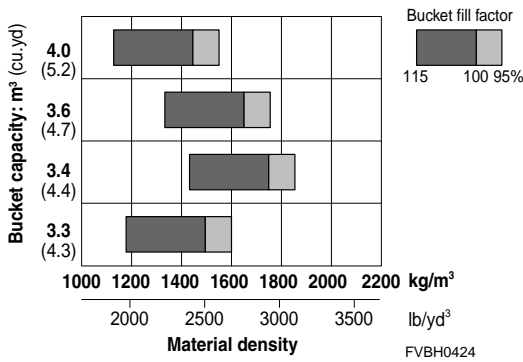

- 4.0 m³ (5.2 cu.yd) Stockpile bucket
Loading loosened or broken fill material
- 3.6 m³ (4.7 cu.yd) Universal/Earth-moving bucket
Ideal for road-building or earthworks, or for load & carry uses
- 3.4 m³ (4.4 cu.yd) Heavy-duty bucket
Loading and loosening of particularly abrasive materials
- 3.3 m³ (4.3 cu.yd) Universal/Earth-moving bucket (high-lift mount)
Ideal for road-building or earthworks, or for load & carry uses

WA470-6 (Germany source)

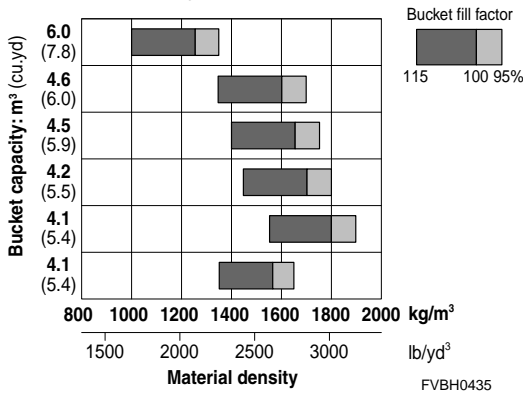

- 6.0 m³ (7.8 cu.yd) Light materials bucket
Ideal for industrial use such as loading lightweight recycling materials or wood chips or shavings
- 4.6 m³ (6.0 cu.yd) Stockpile bucket
Loading loosened or broken material
- 4.5 m³ (5.9 cu.yd) Universal/Earth-moving bucket
Ideal for road-building or earthworks, or for load & carry uses
- 4.2 m³ (5.5 cu.yd) Heavy-duty bucket
Loading and loosening of particularly abrasive materials
- 4.1 m³ (5.4 cu.yd) Rock bucket
Loading blasted and particularly abrasive material
- 4.1 m³ (5.4 cu.yd) Universal/Earth-moving bucket (high-lift mount)
Ideal for road-building or earthworks, or for load & carry uses

WA480-6 (Germany source)

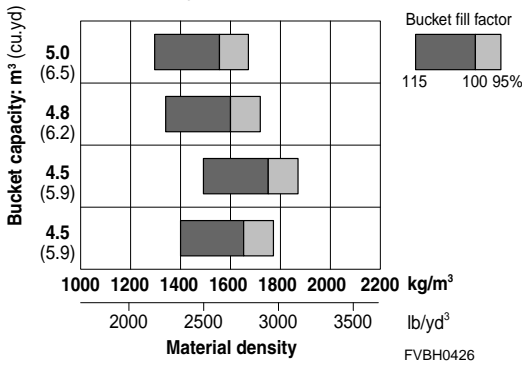

- 5.0 m³ (6.5 cu.yd) Stockpile bucket
Loading loosened or broken material
- 4.8 m³ (6.2 cu.yd) Universal/Earth-moving bucket
Ideal for road-building or earthworks, or for load & carry uses
- 4.5 m³ (5.9 cu.yd) Heavy-duty bucket
Loading and loosening of particularly abrasive materials
- 4.5 m³ (5.9 cu.yd) Rock bucket
Loading and loosening of particularly abrasive materials

WA500-6 (Germany source), WA500-7 (for EU)

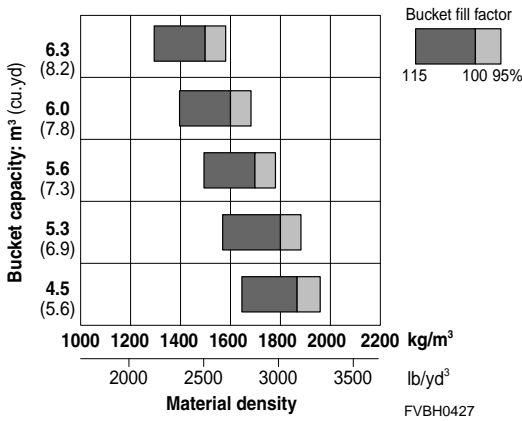

- 6.3 m³ (8.2 cu.yd) Stockpile bucket
Loading loosened material
- 6.0 m³ (7.8 cu.yd) Stockpile bucket
Loading loosened or broken material, or load & carry
- 5.6 m³ (7.3 cu.yd) Universal and stockpile bucket
Earthworks, broken material or load & carry
- 5.3 m³ (6.9 cu.yd) Rock bucket
Loading blasted and particularly abrasive material
- 4.5 m³ (5.6 cu.yd) Rock bucket
Loading blasted and particularly abrasive material in combination with high-lift boom

- Log grapple

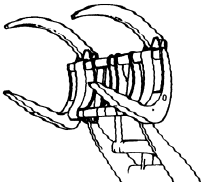

This is a special log attachment for use with logs ranging from small-diameter short logs to large-diameter long logs. Its shape enables it to grip the log well with little rolling shock, and it is designed so that the center of gravity of the log is close to the machine body. This enables the machine to maintain its stability when loading and hauling.

- Log-lumber grapple

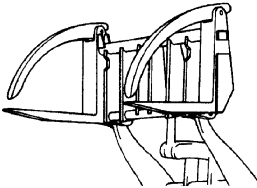

The log-lumber grapple is an all-round tool for log and lumber handling capable of dealing with lumber, long logs of large diameter or short logs of small diameter as well as lumber. However, forks of log-lumber grapple are fixed for strength so it is not suitable for use in forklift operations.

- Log-lumber fork

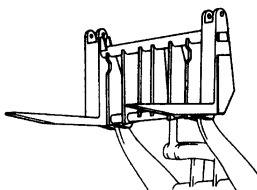

Log-lumber fork has the same features as log-lumber grapple. This attachment has no top clamps.

- Lumber grapple

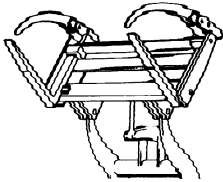

The "L" type forks of the lumber fork permit handling of lumber and logs of smaller diameter and shorter length. Clearance between left and right forks is adjustable according to the materials being handled.

- Lumber fork

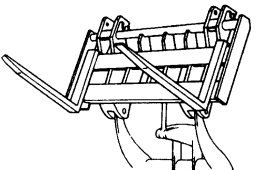

Lumber fork has the same features as lumber grapple. This attachment has no top clamps.

- Dumping fork



Useful for truck-loading pulpwood from stacks, and for gathering and loading pulpwood into stacks or onto trucks. Also usable in handling logs of smaller diameter and shorter length. A lighter, handy version of log handling attachments. It has no top clamp. It can load logs when tilted back to prevent them rolling over the fork.

- Pipe grapple

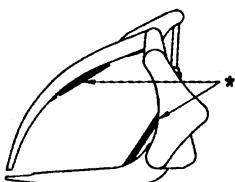

This is a log grapple with cushioning material to allow it to handle pipes and similar materials.

* : Cushioning material

- Rolling gusset

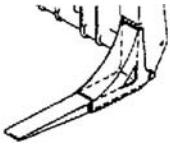

If a rolling gusset is installed to the log lumber fork or log lumber grapple, the rolling shock can be reduced when loading logs.

- Extension fork

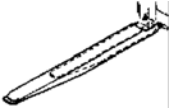

If an extension fork is installed to the lumber fork, the efficiency of handling light materials such as small diameter short logs can be improved.

- Multi-coupler

This is an attachment replacement device that makes it possible to speed up the replacement of attachments and reduce the burden on the operator.

It is possible to remove and install attachments to match the purpose of the work simply when sitting in the operator's seat, thereby greatly reducing time and labor.

Hydraulic type

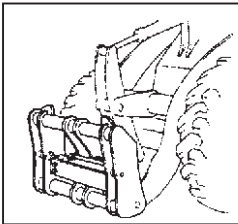

Mechanical type

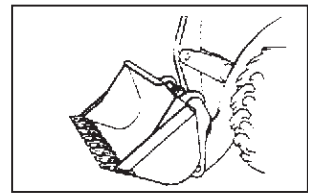
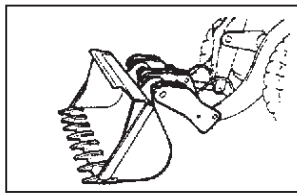
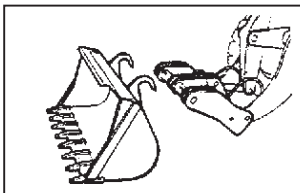
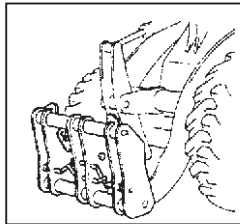

A. Scooping

1. Forward the machine to insert forks under piled logs while watching fork tips.
2. Once logs are scooped by forks and tilted back fully, then close the arms.
3. Lift fork 30-50 cm above the ground to carry.

NOTE: Use both forks evenly to scoop and grapple the center of logs.

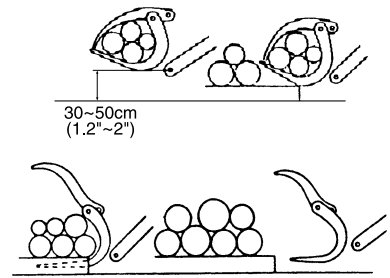

B. Loading work

1. Raise booms and forward the machine gradually to the destination while keeping the fork in a full backward tilt.
2. Open clamper arms and unload logs while slowly lowering forks.

After unloading logs, shift the fork control lever to the "tilt" position and the fork will return automatically to its preset position.

After closing the arms and reversing the machine, lower the booms.

NOTE: When dumping a full load of logs, lower engine revolutions to achieve gradual dumping.

Avoid sudden braking or steering with a full load of logs.

When loading onto trucks, be careful forks and logs do not hit the sticks mounted on the truck's body sides.

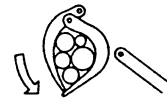

C. Log selection work (for loaders with log clamps)

1. Pick-up selection
 - 1) Open the arms, lower the fork and grab selected logs with fork tips.
 - 2) Pick up logs by tilting back the fork or raising the booms.

NOTE: When picking up a log with fork tips, adjust the tips so they grab the log tightly. More than half of the log's diameter should be grabbed to prevent slippage. Release the arm control lever after arm cylinder is relieved. Logs larger than 40 cm in diameter should be lifted one at a time. Use both forks evenly when grabbing the center of the log.

2. Pull-out selection
 - 1) Open the arms and dump them at 10°-15°, and grab the end of the selected log lengthwise using the fork tips.
 - 2) Reversing the machine to pull out selected log without steering.

NOTE: Do not lift chosen log higher than required.

Hold the log securely and close arm, then carry it.

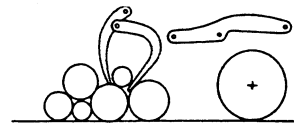

D. Other operations

1. To push logs, open the clamp arms and push them with the inside of the fork, forming right angles with the logs.

NOTE: The dumping angle should be within 20°.

Avoid pushing logs with the front of the closed clamp arms.

2. To retract logs, lower fork and raise fork tips 50-100 cm above the ground, then reverse the machine and retract the logs.

NOTE: Do not uproot tree roots with forks.

Dangerous operations, such as throwing grabbed logs for placement in the depth of loading site, should be conducted in open areas and only after the work site has been properly cleared. Do not conduct these operations where damage to the machine or other equipment is possible.

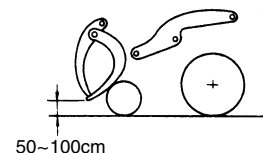
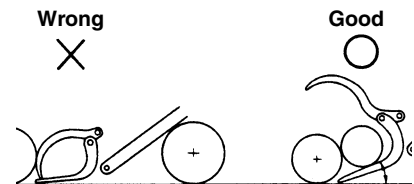

Lumber Grapple Specifications

WHEEL LOADERS

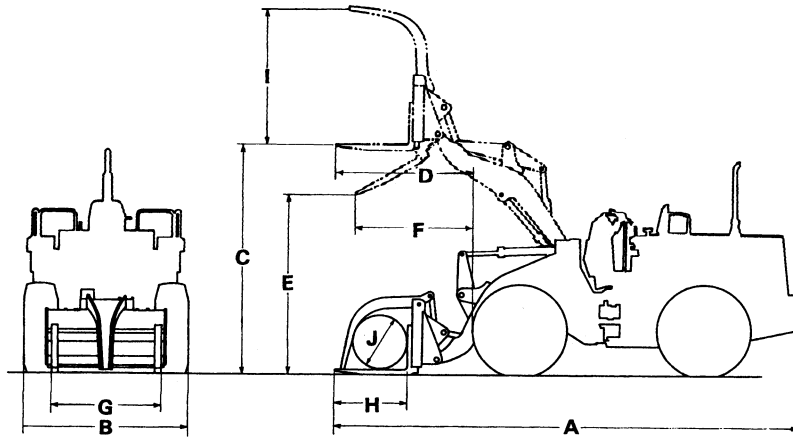

Item	Model	WA180-3**	WA250-5**	WA320-5**
OPERATING WEIGHT	kg (lb)	9140 (20,150)	11330 (24,980)	14270 (31,470)
A. OVERALL LENGTH	mm (ft.in)	6910 (22'8")	7625 (25'0")	8040 (26'5")
B. OVERALL WIDTH	mm (ft.in)	2210 (7'3")	2470 (8'1")	2585 (8'6")
C. Max. tine height with tine level	mm (ft.in)	3390 (11'1")	3645 (12'0")	3765 (12'4")
D. Reach, max. tine height with tine level	mm (ft.in)	1980 (6'6")	2085 (6'10")	2155 (7'1")
E. Dumping clearance*	mm (ft.in)	2610 (8'7")	2795 (9'2")	2860 (9'5")
F. Dumping reach*	mm (ft.in)	1680 (5'6")	1780 (5'10")	1840 (6'0")
G. Overall tine width	mm (ft.in)	1875 (6'2")	2045 (6'9")	2165 (7'1")
H. Tine length	mm (ft.in)	1120 (3'7")	1220 (4'0")	1320 (4'4")
I. Max. clamp opening height	mm (ft.in)	2190 (7'2")	2360 (7'9")	2470 (8'1")
J. Top clamp min. closure diameter	mm (ft.in)	900 (2'11")	950 (3'1")	1000 (3'3")
TIRE SIZE		14.00-24-12PR	20.5-25-12PR (L2)	20.5-25-16PR (L3)
Add. counterweight	kg (lb)	280 (620)	300 (660)	520 (1,150)

* At 30° discharge angle
 ** With ROPS cab

Dumping Fork Specifications

WHEEL LOADERS

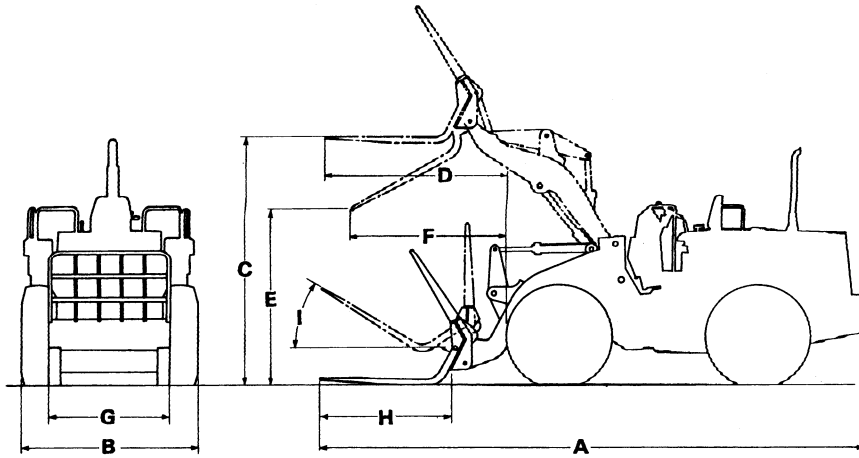

Item	Model	WA250-5**	WA320-5**	WA320-3 CUSTOM*3	WA380-3**
OPERATING WEIGHT	kg (lb)	11030 (24,320)	13870 (30,580)	13580 (29,940)	16750 (36,930)
A. OVERALL LENGTH	mm (ft.in)	7845 (25'9")	8360 (27'5")	8485 (27'10")	8945 (29'4")
B. OVERALL WIDTH	mm (ft.in)	2470 (8'1")	2585 (8'6")	2585 (8'6")	2695 (8'8")
C. Max. tine height with tine level	mm (ft.in)	3580 (11'9")	3695 (12'2")	3675 (12'1")	3820 (12'6")
D. Reach, max. tine height with tine level	mm (ft.in)	2240 (7'4")	2405 (7'11")	2430 (8'0")	2505 (8'3")
E. Dumping clearance*	mm (ft.in)	2665 (8'9")	2670 (8'9")	2650 (8'8")	2790 (9'2")
F. Dumping reach*	mm (ft.in)	1880 (6'2")	2025 (6'8")	2045 (6'9")	2120 (7')
G. Overall tine width	mm (ft.in)	1850 (6'1")	2100 (6'11")	2100 (6'11")	2100 (6'11")
H. Tine length	mm (ft.in)	1675 (5'6")	1890 (6'2")	1890 (6'2")	1890 (6'2")
I. Max. tilt-back angle	degree	29	31	30	31
TIRE SIZE		20.5-25-12PR (L2)	20.5-25-16PR (L3)	20.5-25-12PR	20.5-25-16PR
Add. counterweight	kg (lb)	300 (660)	520 (1,150)	750 (1,650)	750 (1,650)

* At 30° discharge angle

** With ROPS cab

*3 With cab

Lumber Fork Specifications

WHEEL LOADERS

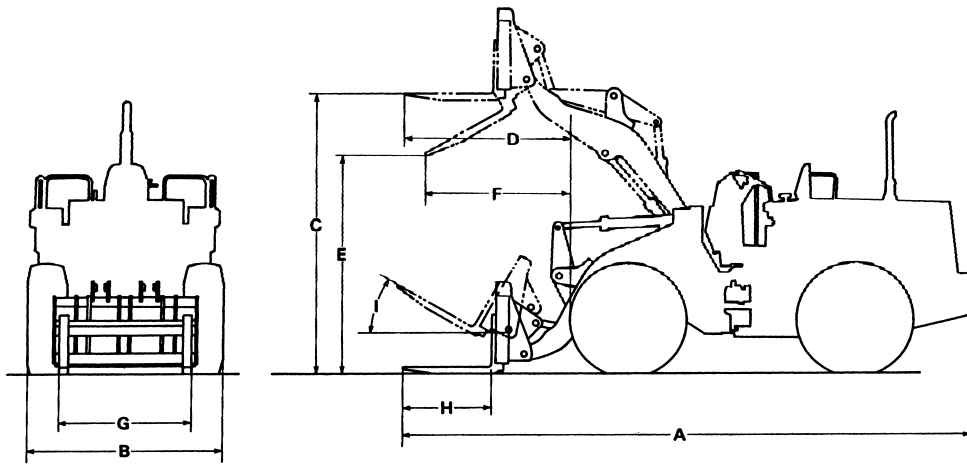

Item	Model	WA180-3**	WA200-5**	WA250-5**	WA320-5**
OPERATING WEIGHT	kg (lb)	8920 (19,670)	9830 (21,680)	11090 (24,450)	13910 (30,670)
A. OVERALL LENGTH	mm (ft.in)	6910 (22'9")	7615 (25'0")	7625 (25'0")	8040 (26'5")
B. OVERALL WIDTH	mm (ft.in)	2210 (7'3")	2375 (7'10")	2470 (8'1")	2585 (8'6")
C. Max. tine height with tine level	mm (ft.in)	3390 (11'1")	3485 (11'5")	3645 (12'0")	3765 (12'4")
D. Reach, max. tine height with tine level	mm (ft.in)	1980 (6'6")	2095 (6'11")	2085 (6'10")	2155 (7'1")
E. Dumping clearance*	mm (ft.in)	2610 (8'7")	2635 (8'8")	2795 (9'2")	2860 (9'5")
F. Dumping reach*	mm (ft.in)	1680 (5'6")	1785 (5'10")	1780 (5'10")	1840 (6'0")
G. Overall tine width	mm (ft.in)	1875 (6'2")	2045 (6'9")	2045 (6'9")	2165 (7'1")
H. Tine length	mm (ft.in)	1120 (3'8")	1220 (4'0")	1220 (4'0")	1320 (4'4")
I. Max. tilt-back angle	degree	28	27	26	27
TIRE SIZE		14.00-24-12PR	17.5-25-12PR (L2)	20.5-25-12PR (L2)	20.5-25-16PR (L3)
Add. counterweight	kg (lb)	280 (620)	300 (660)	300 (660)	520 (1,150)

* At 30° discharge angle

** With high lift

Item	Model	WA320-3 CUSTOM* ³	WA380-3**	WA380-5**	
OPERATING WEIGHT	kg (lb)	13620 (30,030)	16960 (37,390)	16700 (36,820)	
A.OVERALL LENGTH	mm (ft.in)	8165 (26'9")	8740 (28'8")	8915 (29'3")	
B.OVERALL WIDTH	mm (ft.in)	2585 (8'6")	2695 (8'10")	2695 (8'10")	
C. Max. tine height with tine level	mm (ft.in)	3745 (12'3")	3870 (12'8")	3870 (12'8")	
D. Reach, max. tine height with tine level	mm (ft.in)	2180 (7'2")	2345 (7'8")	2345 (7'8")	
E. Dumping clearance*	mm (ft.in)	2840 (9'4")	2915 (9'7")	2915 (9'7")	
F. Dumping reach*	mm (ft.in)	1865 (6'1")	2005 (6'7")	2005 (6'7")	
G. Overall tine width	mm (ft.in)	2165 (7'1")	2250 (7'5")	2250 (7'5")	
H. Tine length	mm (ft.in)	1320 (4'4")	1420 (4'10")	1420 (4'10")	
I. Max. tilt-back angle	degree	27	28	28	
TIRE SIZE		20.5-25-12PR	20.5-25-16PR	20.5-25-20PR	
Add. counterweight	kg (lb)	750 (1,650)	750 (1,650)	708 (1,550)	

* At 30° discharge angle

** With ROPS cab

*³ With cab

Log Grapple Specifications

WHEEL LOADERS

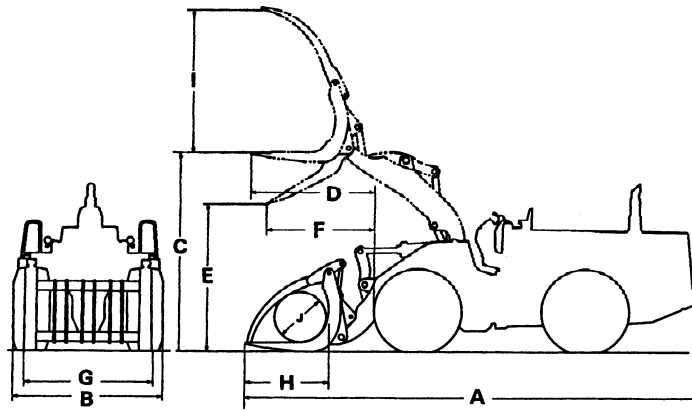

Item	Model	WA320-5**	WA320-3*** CUSTOM	WA380-3**	WA380-5**
OPERATING WEIGHT	kg (lb)	13970 (30,800)	13680 (30,160)	16980 (37,430)	16790 (37,020)
A. OVERALL LENGTH	mm (ft.in)	7720 (25'4")	7845 (25'9")	8455 (27'9")	8627 (28'4")
B. OVERALL WIDTH	mm (ft.in)	2585 (8'6")	2585 (8'6")	2695 (8'10")	2695 (8'10")
C. Max. tine height with tine level	mm (ft.in)	3875 (12'9")	3855 (12'8")	3985 (13'1")	3985 (13'1")
D. Reach, max. tine height with tine level	mm (ft.in)	1855 (6'1")	1880 (6'2")	2080 (6'10")	2080 (6'10")
E. Dumping clearance*	mm (ft.in)	3095 (10'2")	3075 (10'1")	3140 (10'4")	3140 (10'4")
F. Dumping reach*	mm (ft.in)	1635 (5'4")	1660 (5'5")	1835 (6')	1835 (6')
G. Overall tine width	mm (ft.in)	2200 (7'3")	2200 (7'3")	2300 (7'7")	2300 (7'7")
H. Tine length	mm (ft.in)	1320 (4'4")	1320 (4'4")	1420 (4'8")	1420 (4'8")
I. Max. clamp opening height	mm (ft.in)	2280 (7'6")	2280 (7'6")	2415 (7'11")	2415 (7'11")
J. Top clamp min. closure diameter	mm (ft.in)	850 (2'9")	850 (2'9")	900 (2'11")	900 (2'11")
TIRE SIZE		20.5-25-16PR (L3)	20.5-25-12PR	20.5-25-16PR	20.5-25-20PR
Add. counterweight	kg (lb)	520 (1,150)	750 (1,650)	750 (1,650)	705 (1,550)

* At 30° discharge angle

** With ROPS cab

*** With steel cab

Item	Model	WA470-5**	WA470-3***	WA500-3***	
OPERATING WEIGHT	kg (lb)	22550 (49,710)	22790 (50,240)	33090 (72,950)	
A. OVERALL LENGTH	mm (ft.in)	9425 (31'0")	9315 (30'7")	10105 (33'2")	
B. OVERALL WIDTH	mm (ft.in)	2920 (9'7")	2920 (9'7")	3190 (10'6")	
C. Max. tine height with tine level	mm (ft.in)	4230 (13'11")	4230 (13'11")	4375 (14'4")	
D. Reach, max. tine height with tine level	mm (ft.in)	2315 (7'7")	2265 (7'5")	2590 (8'6")	
E. Dumping clearance*	mm (ft.in)	3315 (10'11")	3315 (10'11")	3300 (10'10")	
F. Dumping reach*	mm (ft.in)	2045 (6'9")	1995 (6'7")	2250 (7'5")	
G. Overall tine width	mm (ft.in)	2645 (8'8")	2645 (8'8")	2745 (9')	
H. Tine length	mm (ft.in)	1525 (5')	1525 (5')	1830 (6')	
I. Max. clamp opening height	mm (ft.in)	2765 (9'1")	2765 (9'1")	3035 (9'11")	
J. Top clamp min. closure diameter	mm (ft.in)	1000 (3'3")	1000 (3'3")	1150 (3'9")	
TIRE SIZE		23.5-25-24PR	23.5-25-20PR	29.5-25-22PR	
Add. counterweight	kg (lb)	1030 (2,270)	1045 (2,300)	2250 (4,960)	

* At 30° discharge angle

** With ROPS cab

*** Rear tires are filled with calcium chloride, with steel cab & ROPS canopy

WA250-5

Curves based on machine equipped with 20.5-25-12PR (L2) TL and counterweight

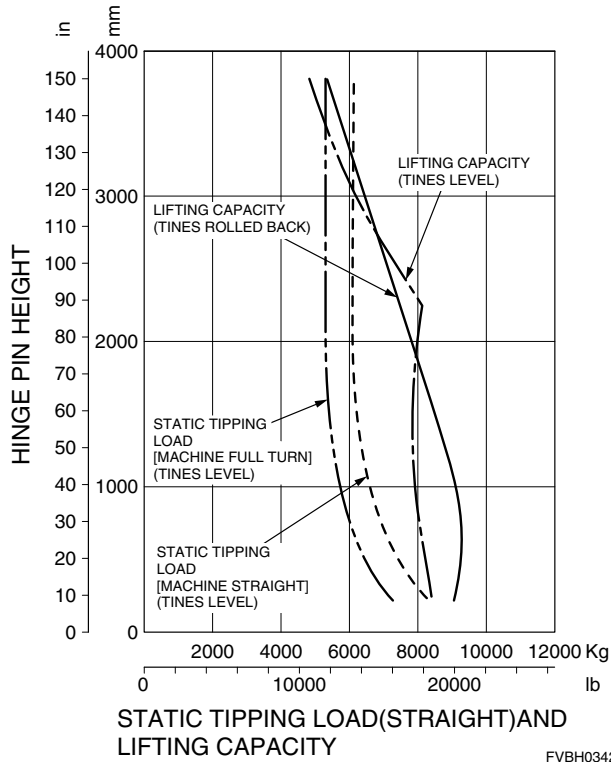

WA320-5

Curves based on machine equipped with 20.5-25-16PR (L3) TL and counterweight

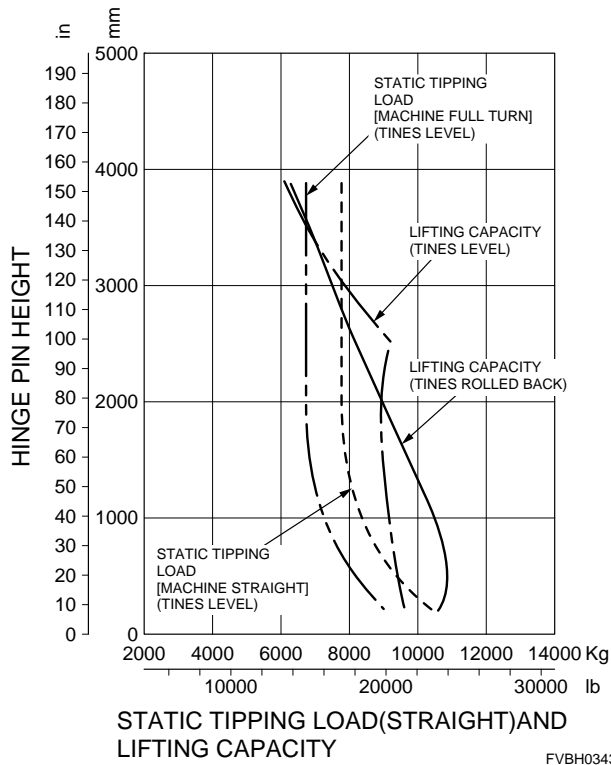

WA200-5

Curves based on machine equipped with 17.00-25-12PR (L2) TL and counterweight

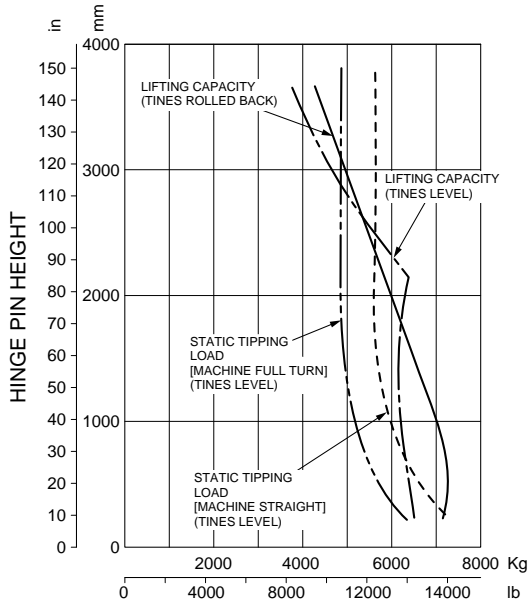

FVBH0344

STATIC TIPPING LOAD (STRAIGHT) AND LIFTING CAPACITY

WA250-5

Curves based on machine equipped with 20.5-25-12PR (L2) TL and counterweight

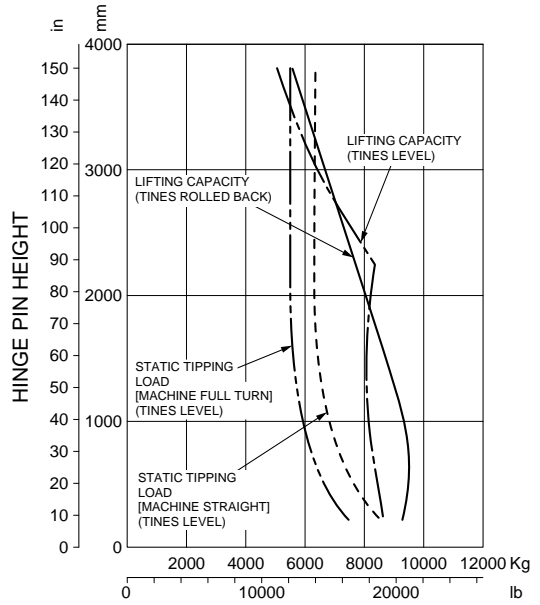

FVBH0345

STATIC TIPPING LOAD (STRAIGHT) AND LIFTING CAPACITY

WA320-5

Curves based on machine equipped with 20.5-25-16PR (L3) TL and counterweight

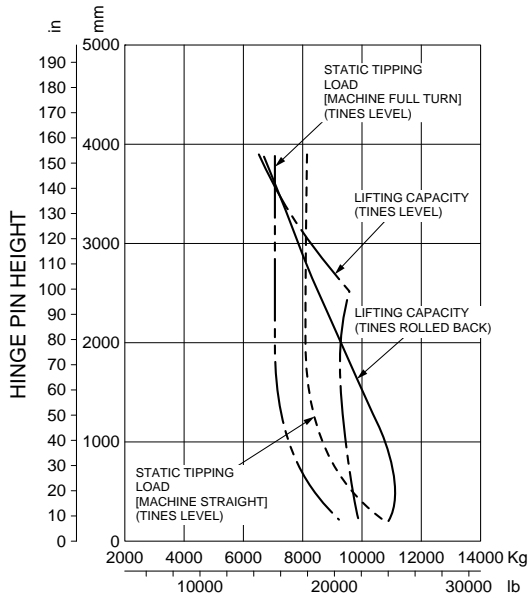

FVBH0346

STATIC TIPPING LOAD (STRAIGHT) AND LIFTING CAPACITY

WA320-3 CUSTOM

Curves based on machine equipped with 20.5-25-12PR (L3) TL and counterweight for logger

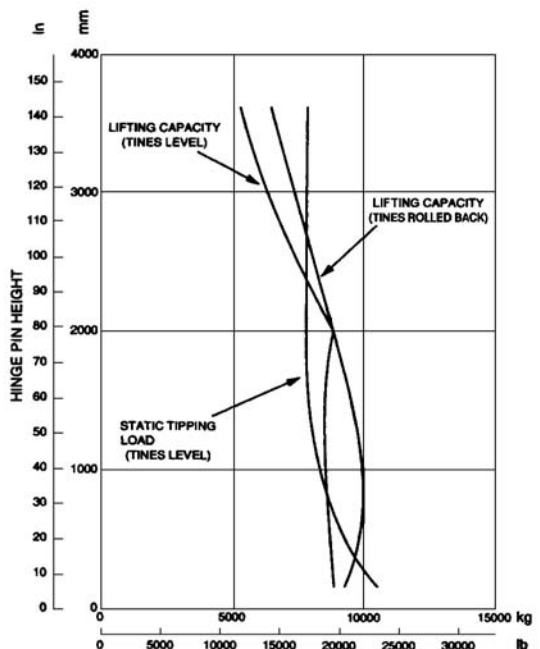

STATIC TIPPING LOAD (STRAIGHT) AND LIFTING CAPACITY

WA380-3

Curves based on machine equipped with 20.5-25-16PR (L3) TL and counterweight for logger

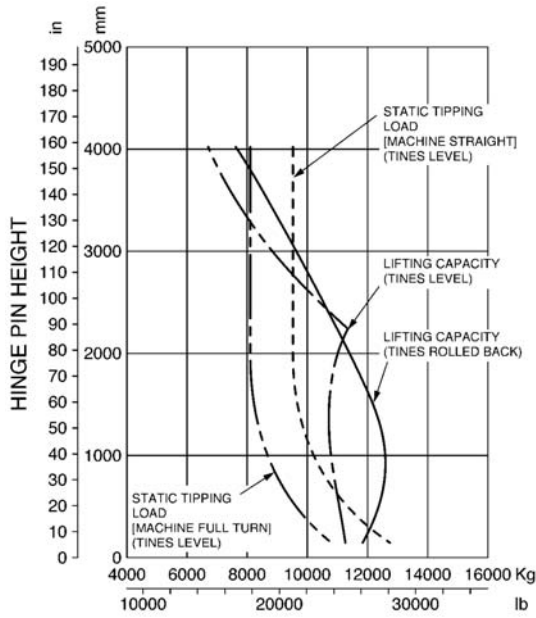

STATIC TIPPING LOAD (STRAIGHT) AND LIFTING CAPACITY

WA380-5

Curves based on machine equipped with 20.5-25-20PR (L3) TL and counterweight for logger

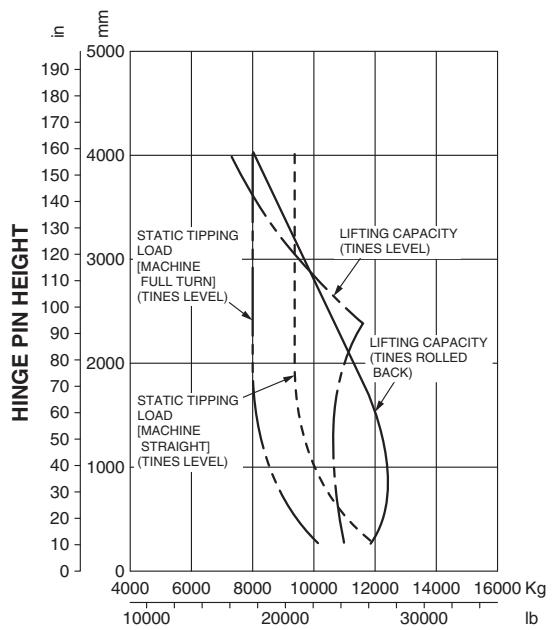

STATIC TIPPING LOAD (STRAIGHT) AND LIFTING CAPACITY

WA250-5

Curves based on machine equipped with 20.5-25-12PR (L2) TL and counterweight

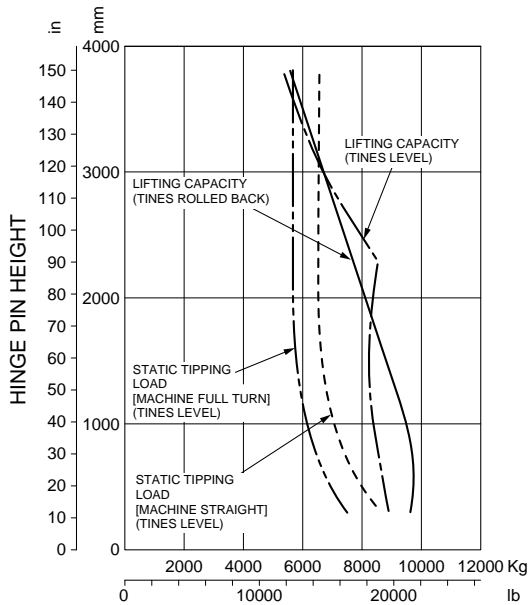

FVBH0347

STATIC TIPPING LOAD (STRAIGHT) AND LIFTING CAPACITY

WA320-5

Curves based on machine equipped with 20.5-25-16PR (L3) TL and counterweight

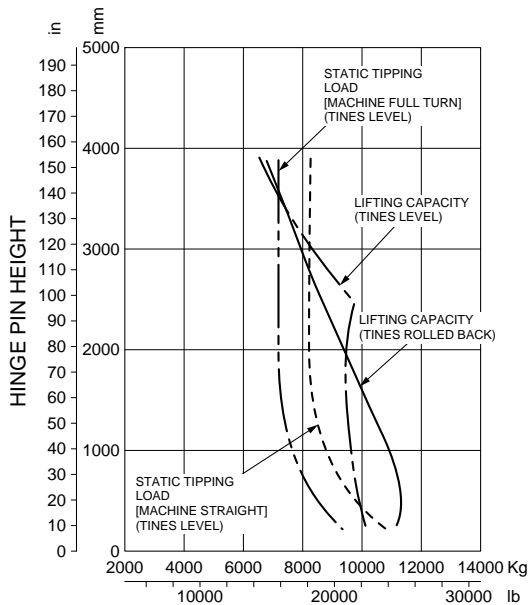

FVBH0348

STATIC TIPPING LOAD (STRAIGHT) AND LIFTING CAPACITY

WA320-3 CUSTOM

Curves based on machine equipped with 20.5-25-12PR (L3) TL and counterweight for logger

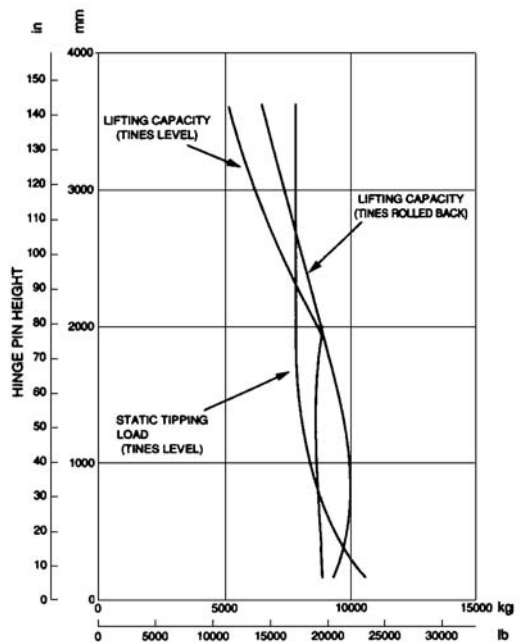

STATIC TIPPING LOAD (STRAIGHT) AND LIFTING CAPACITY

WA380-3

Curves based on machine equipped with 20.5-25-16PR (L3) TL and counterweight for logger

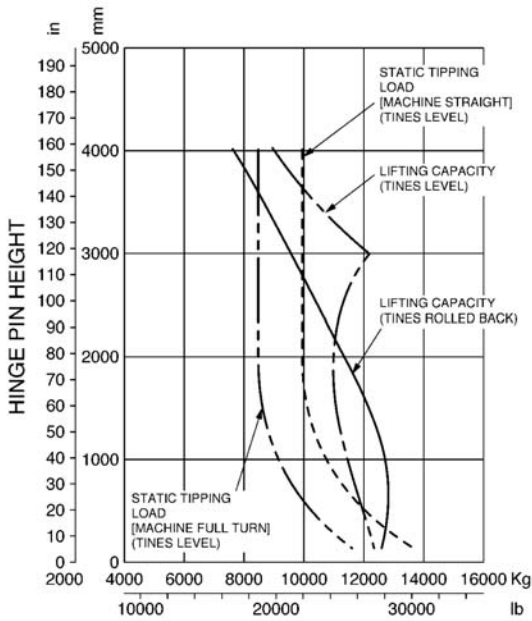

STATIC TIPPING LOAD (STRAIGHT) AND LIFTING CAPACITY

WA380-5

Curves based on machine equipped with 20.5-25-20PR (L3) TL and counterweight for logger

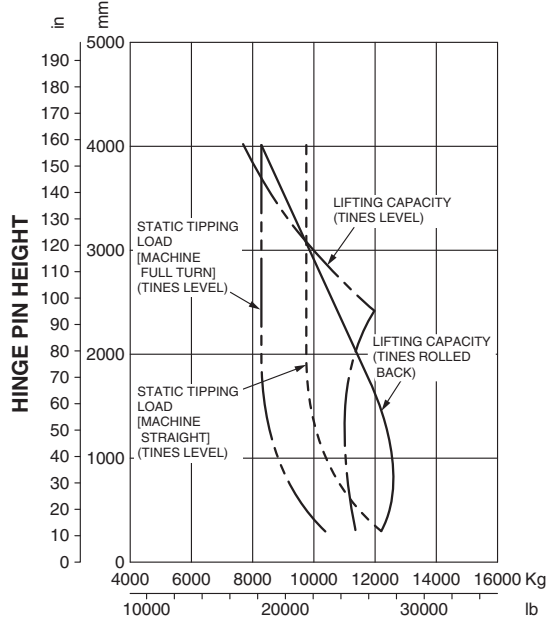

STATIC TIPPING LOAD (STRAIGHT) AND LIFTING CAPACITY

WA320-5

Curves based on machine equipped with 20.5-25-16PR (L3) TL and counterweight

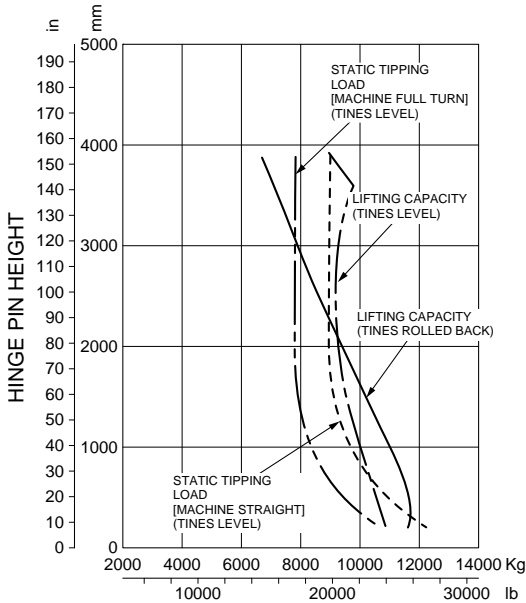

FVBH0349

STATIC TIPPING LOAD (STRAIGHT) AND LIFTING CAPACITY

WA320-3 CUSTOM

Curves based on machine equipped with 20.5-25-12PR (L3) TL and counterweight for logger

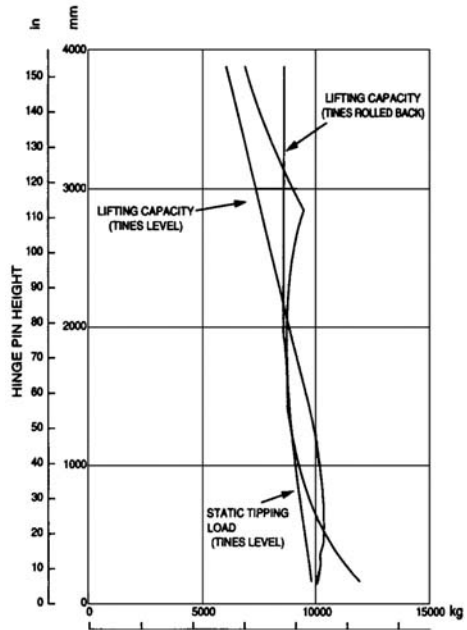

STATIC TIPPING LOAD (STRAIGHT) AND LIFTING CAPACITY

WA380-3

Curves based on machine equipped with 20.5-25-16PR (L3) TL and counterweight for logger

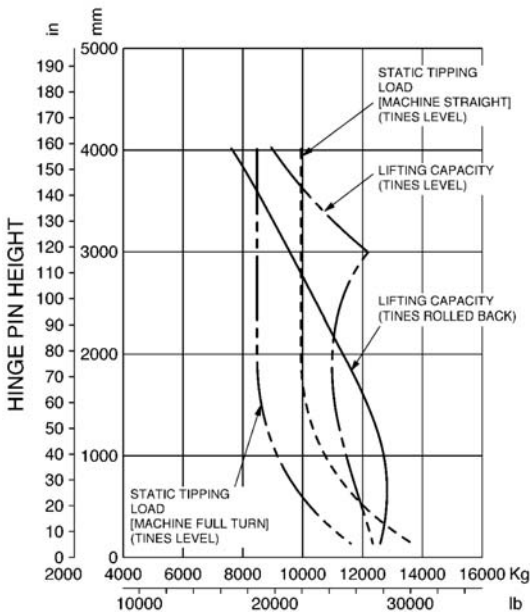

STATIC TIPPING LOAD (STRAIGHT) AND LIFTING CAPACITY

WA380-5

Curves based on machine equipped with 20.5-25-20PR (L3) TL and counterweight for logger

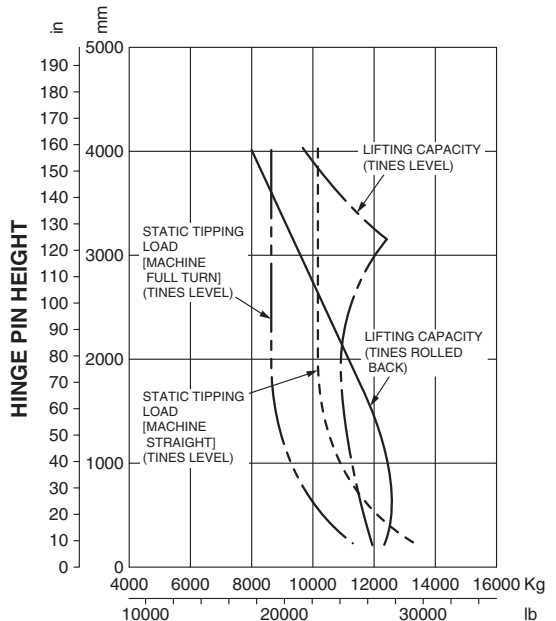

STATIC TIPPING LOAD (STRAIGHT) AND LIFTING CAPACITY

WA470-3

Curves based on machine equipped with 23.5-25-20PR (L3) TL and counterweight for logger

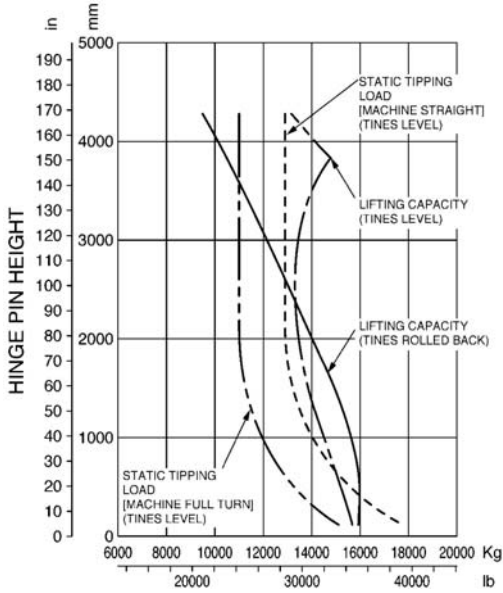

STATIC TIPPING LOAD (STRAIGHT) AND LIFTING CAPACITY

WA500-3

Curves based on machine equipped with 29.5-25-22PR (L3) TL and counterweight for logger

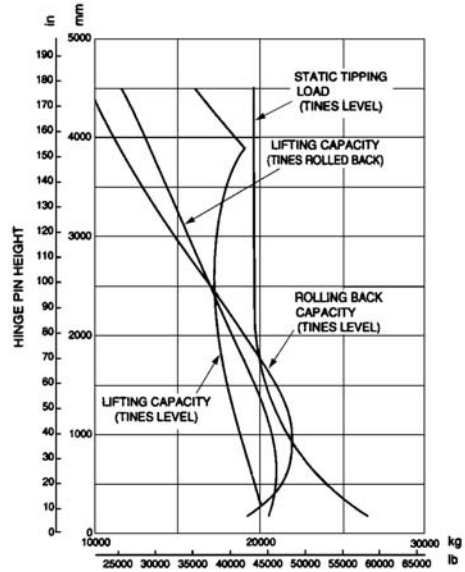

STATIC TIPPING LOAD (STRAIGHT) AND LIFTING CAPACITY

High Lift Boom Specifications

WHEEL LOADERS

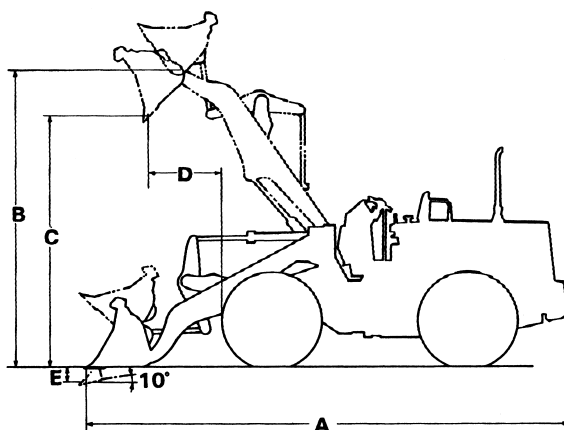

Item		Model	WA120-3***	WA150-5***	WA180-3***	WA200-5***
OPERATING WEIGHT	kg (lb)		7660 (16,890)	7645 (16,850)	8830 (19,470)	10010 (22,070)
BACKET CAPACITY	m ³ (cu.yd)		1.2 (1.6)	1.3 (1.7)	1.5 (2.0)	1.7 (2.2)
A. OVERALL LENGTH	mm (ft.in)		6240 (20'6")	6320 (20'9")	6725 (22'1")	7485 (24'7")
OVERALL WIDTH	mm (ft.in)		2390 (7'10")	2390 (7'10")	2440 (8')	2550 (8'4")
B. Hinge pin height, max. height	mm (ft.in)		3745 (12'3")	4025 (13'2")	4015 (13'2")	4225 (13'10")
C. Dumping clearance*	mm (ft.in)		3030 (9'11")**	3310 (10'10")**	3250 (10'8")**	3410 (11'2")**
D. Dumping reach*	mm (ft.in)		980 (3'3")**	1020 (3'4")**	1060 (3'6")**	1040 (3'5")**
E. Digging depth	mm (ft.in)		225 (9")	285 (11'2")	335 (1'1")	435 (1'5")
TIRE SIZE			16.9-24-10PR	16.9-24-10PR	18.4-24-10PR	17.5-25-12PR
Add. counterweight	kg (lb)			200 (441)		300 (661)

- * At 45° discharge angle
- ** At 44° discharge angle
- *** With ROPS cab and B.O.C.

Item		Model	WA250-5***	WA320-5***	WA380-5***	WA380-3***
OPERATING WEIGHT	kg (lb)		11560 (25,490)	14110 (31,110)	18050 (39,790)	17100 (37,700)
BACKET CAPACITY	m ³ (cu.yd)		1.9 (2.5)	2.4 (3.1)	2.9 (3.8)	2.8 (3.7)
A. OVERALL LENGTH	mm (ft.in)		7515 (24'8")	8040 (26'5")	8760 (28'9")	8450 (27'9")
OVERALL WIDTH	mm (ft.in)		2685 (8'10")	2740 (9'0")	2905 (9'6")	2905 (9'6")
B. Hinge pin height, max. height	mm (ft.in)		4390 (14'5")	4545 (14'11")	4625 (15'2")	4560 (15')
C. Dumping clearance*	mm (ft.in)		3520 (11'6")	3530 (11'7")	3575 (11'9")	3530 (11'7")
D. Dumping reach*	mm (ft.in)		945 (3'1")	1015 (3'4")	1185 (3'11")	1125 (4')
E. Digging depth	mm (ft.in)		250 (9.8")	235 (9.3")	320 (1'1")	320 (1'1")
TIRE SIZE			17.5-25-12PR	20.5-25-12PR	23.5-25-16PR	20.5-25-16PR
Add. counterweight	kg (lb)		300 (661)	520 (1146)	700 (1543)	750 (1650)

- * At 45° discharge angle
- *** With ROPS cab and B.O.C.

Item		Model	WA430-5***	WA470-5***	WA470-3	
OPERATING WEIGHT	kg (lb)		19720 (43,470)	23770 (52,400)	23075 (50,870)	
BACKET CAPACITY	m ³ (cu.yd)		3.3 (4.3)	3.8 (4.5)	3.8 (4.5)	
A. OVERALL LENGTH	mm (ft.in)		8980 (29'6")	9515 (31'3")	9360 (30'9")	
OVERALL WIDTH	mm (ft.in)		3050 (10')	3170 (10'5")	3170 (10'5")	
B. Hinge pin height, max. height	mm (ft.in)		4730 (15'6")	4870 (16'0")	4870 (16'0")	
C. Dumping clearance*	mm (ft.in)		3635 (11'11")	3750 (12'4")	3760 (12'4")	
D. Dumping reach*	mm (ft.in)		1155 (3'9")	1355 (4'5")	1305 (4'3")	
E. Digging depth	mm (ft.in)		440 (1'5")	440 (1'5")	435 (1'5")	
TIRE SIZE			23.5-25-16PR	26.5-25-16PR	26.5-25-16PR	
Add. counterweight	kg (lb)		775 (1708)	1045 (2304)	1045 (2304)	

- * At 45° discharge angle
- *** With ROPS cab and B.O.C.

WA500 over see PERFORMANCE DATA

WA50-6	WA120-3	WA150-6	WA150-5	WA180-3	WA200-6
●15.5/60-18-8PR L2 T/L	●16.9-24-10PR L2 T/L	●16.9-24-10PR L2 T/L	●16.9-24-10PR L2 T/L	●18.4-24-10PR L2 T/L	●17.5-25-12PR L2 T/L
	16.9-24-10PR L3 T/L	15.5-25-8PR L2 T/L	16.9-24-10PR L3 T/L	14.00-24-12PR L2 T/L	17.5-25-12PR L3 T/L
	14.00-24-12PR L2 T/L	17.5-25-12PR L2 T/L	14.00-24-12PR L2 T/L	14.00-24-12PR L3 T/L	20.5-25-12PR L2 T/L
	15.5-25-8PR L2 T/L		15.5-25-8PR L2 T/L	15.5-25-12PR L2 T/L	20.5-25-12PR L3 T/L
	15.5-25-8PR L3 T/L		15.5-25-8PR L3 T/L	15.5-25-12PR L3 T/L	
	17.5-25-12PR L2 T/L		17.5-25-12PR L2 T/L	17.5-25-12PR L2 T/L	
	17.5-25-12PR L3 T/L		17.5-25-12PR L3 T/L	17.5-25-12PR L3 T/L	
	15.5 R25		15.5 R25	17.5 R25	

WA200-5	WA200PZ-6	WA250-6	WA250-5	WA250PZ-6	WA320-6
●17.5-25-12PR L2 T/L	●20.5-25-12PR L2 T/L	●17.5-25-16PR L2 T/L	●17.5-25-12PR L2 T/L	●20.5-25-12PR L2 T/L	●20.5-25-12PR L3 T/L
17.5-25-12PR L3 T/L	17.5-25-12PR L2 T/L	17.5-25-16PR L3 T/L	17.5-25-12PR L3 T/L	17.5-25-16PR L3 T/L	20.5-25-12PR L2 T/L
20.5-25-12PR L2 T/L	17.5-25-12PR L3 T/L	20.5-25-12PR L2 T/L	20.5-25-12PR L2 T/L	17.5-25-16PR L2 T/L	
20.5-25-12PR L3 T/L		20.5-25-12PR L3 T/L	20.5-25-12PR L3 T/L	20.5-25-12PR L3 T/L	

WA320PZ-6	WA320-5	WA320-3 CUSTOM	WA380-6	WA380Z-6	WA380-5
●20.5-25-12PR L2 T/L	●20.5-25-12PR L3 T/L	●20.5-25-12PR L3 T/L	●20.5-25-16PR L3 T/L	●23.5-25-16PR L3 T/L	●20.5-25-16PR L3 T/L
20.5-25-12PR L3 T/L	20.5-25-12PR L2 T/L	20.5-25-12PR L3 W/T	23.5-25-16PR L3 T/L	20.5-25-16PR L3 T/L	23.5-25-16PR L3 T/L
					23.5-25-16PR L4 T/L

WA380-3	WA430-6	WA430-5	WA470-5	WA470-6	WA470-3
●20.5-25-16PR L3 T/L	●23.5-25-16PR L3 T/L	●23.5-25-16PR L3 T/L	●26.5-25-20PR L3 T/L	●26.5-25-16PR L3 T/L	●23.5-25-20PR L3 T/L
20.5-25-16PR L2 T/L	26.5-25-16PR L2 T/L	26.5-25-16PR L2 T/L	23.5-25-20PR L2 T/L	23.5-25-20PR L3 T/L	23.5-25-20PR L2 T/L
23.5-25-12PR L2 T/L			26.5-25-16PR L3 T/L	23.5-25-20PR L2 T/L	26.5-25-16PR L3 T/L
23.5-25-12PR L3 T/L			26.5-25-20PR L4 T/L	26.5-25-20PR L4 T/L	26.5-25-20PR L3 T/L
23.5-25-16PR L2 T/L			23.5-25-20PR L3 T/L		26.5-25-20PR L4 T/L
23.5-25-16PR L3 T/L			26.5-R25 L3		26.5-25-20PR L5 T/L
23.5-25-20PR L2 T/L					
23.5-25-20PR L3 T/L					

● : Standard tire
 T/L : Tubeless tire
 W/T : Tubed tire
 SB : Steel breaker tire
 SSB : Side steel breaker tire

WA480-6	WA480-5	WA500-6 WA500-6R	WA500-3	WA600-6 WA600-6R	WA600-3
•26.5-25-20PR L3 T/L	•26.5-25-20PR L3 T/L	•29.5-25-22PR L3 T/L	•26.5-25-20PR L3 T/L	•35/65-33-36PR L4 T/L	•35/65-33-24PR L4 T/L
26.5-25-20PR L4 T/L	26.5-25-20PR L3 T/L		26.5-25-20PR L3 W/T	35/65-33-36PR L5 T/L	29.5-29-28PR L4 T/L
	26.5-25-20PR L5 T/L		26.5-25-20PR L3 W/T SB	35/65-33-42PR L4 T/L	35/65-33-24PR L5 T/L
	26.5-25-20PR L4 T/L		26.5-25-20PR L4 T/L	35/65 R33 L4 T/L	35/65-33-30PR L5 T/L
	26.5-25-24PR L3 T/L		26.5-25-20PR L5 T/L	35/65 R33* L5 T/L	35/65-33-30PR L4 T/L
			26.5-25-24PR L3 T/L		
			29.5-25-22PR L3 T/L		
			29.5-25-22PR L3 W/T		
			29.5-25-22PR L4 T/L		
			29.5-25-22PR L5 T/L		
			29.5-25-28PR L4 T/L		

WA700-3	WA800-3E0	WA800-3	WA900-3E0	WA900-3	WA1200-6
•45/65-39-36PR L5 T/L	•45/65-45-46PR L5 T/L	•45/65-45-46PR L5 T/L	•45/65-45-58PR L5 T/L	•45/65-45-58PR L5 T/L	•60/80-R57 L5 radial
41.25/70-39-34PR L5 T/L	45/65-45-50PR L5 T/L	45/65-45-50PR L4 T/L	45/65 R45 L5 T/L		58/85-57-84PR L5 T/L
	45/65 R45 L5 T/L				

WA320-6*	WA380-7*	WA430-6*	WA470-7*	WA480-6*	WA500-7*
•20.5-25-12PR L3 T/L	•23.5-R25 L3 radial	•23.5 R25 L3 radial	•26.5 R25 L3 radial	•26.5 R25 L3 radial	•29.5-25-R22PR L3
20.5-25-12PR L2 T/L					

WA200PZ-6***	WA250PZ-6***	WA320PZ-6***	WA65-6**	WA70-6**	WA80-6**
•20.5-25-12PR L2	•20.5-25-12PR L2	•20.5-25-12PR L2	•12.0-18	•12.5-18	•405/70 R18
17.5-25-16PR L3	17.5-25-16PR L2	20.5-25-12PR L3			
17.5-25-16PR L3	17.5-25-16PR L3				
	20.5-25-12PR L3				

WA90-6**	WA100M-6**	WA150PZ-6**	WA200PZ-6**	WA250PZ-6**	WA320PZ-6** WA320-6**
•405/70 R20	•455/70 R24	•17.5 R25 L-3	•20.5 R25 L2	•20.5 R25 L3	•20.5 R25 L3
			20.5 R25 L3	20.5 R25 L2	20.5 R25 L2
			20.5 R25 L5	20.5 R25 L5	20.5 R25 L5
			17.5 R25 L2		23.5 R25 L3
			17.5 R25 L3		
			17.5 R25 L5		

• : Standard tire
T/L : Tubeless tire
W/T : Tubed tire
SB : Steel breaker tire
SSB : Side steel breaker tire

* : USA source
** : Germany source
*** : for USA

WA380-7*6	WA380-6**	WA430-6**	WA470-6**	WA480-6**	WA500-7*6
•23.5 R25 L3	•23.5 R25 L3	•23.5 R25 L3	•26.5 R25 L3	•26.5 R25 L3	•29.5 R25 L4
23.5 R25 L2	650/65 R25	750/65 R25	23.5 R25 L2	26.5 R25 L2	29.5 R25 L3
23.5 R25 L5	23.5 R25 L2	650/65 R25	23.5 R25 L4	26.5 R25 L4	29.5 R25 L5
650/65 R25 L3	23.5 R25 L4	23.5 R25 L2	23.5 R25 L5	26.5 R25 L5	
	23.5 R25 L5	23.5 R25 L4			
		23.5 R25 L5			
		26.5 R25 L2			
		26.5 R25 L3			

WA500-6**	WA320-5*4	WA380-6*4	WA380Z-6	WA470-6	WA200-5*5
•29.5 R25 L3	•20.5-25 16PR	•23.5-25 16PR	•23.5-25 16PR	•26.5-25 20PR	•17.5-25 12PR
29.5 R25 L4	L3 T/L	L3 T/L	L3 T/L	L3 T/L	L2 T/L
29.5 R25 L5		20.5-25 16PR	20.5-25 16PR		17.5-25 12PR
26.5 R25		L3 T/L	L3 T/L		L3 T/L
					20.5-25 12PR
					L3 T/L

WA320-5*5					
•20.5-25 12PR					
L3 T/L					
20.5-25 16PR					
L3 T/L					

• : Standard tire
 T/L : Tubeless tire
 W/T : Tubed tire
 SB : Steel breaker tire
 SSB : Side steel breaker tire

* : USA source
 ** : Germany source
 *** : for USA
 *4 : China source
 *5 : Brazil source
 *6 : for EU

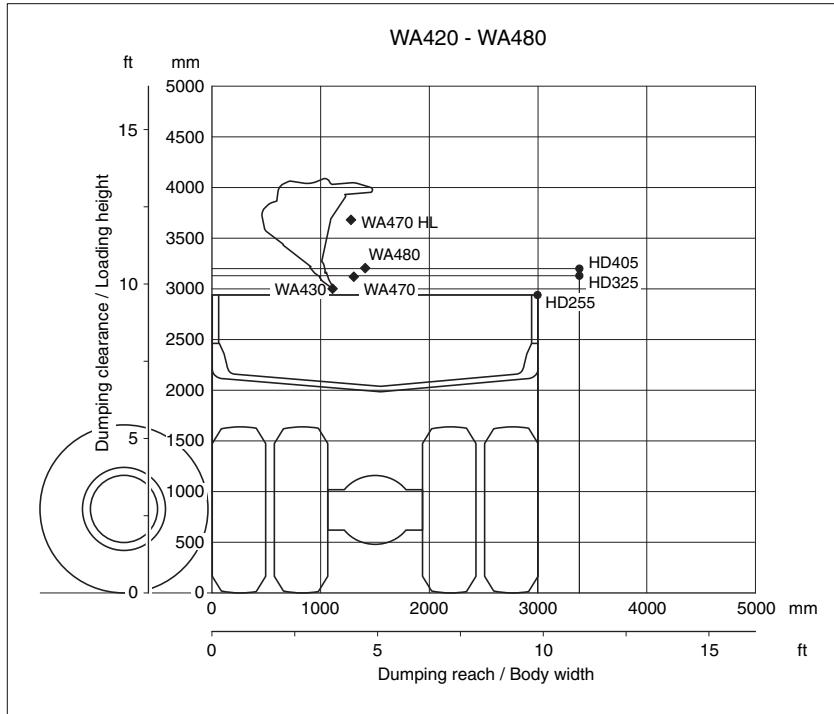

Chart shows dumping reach and dumping clearance of standard size buckets. HL means high lift boom.

- ◆ : Indicates dumping reach and clearance at the end of teeth or BOC.
- : Indicates the top corner of body.

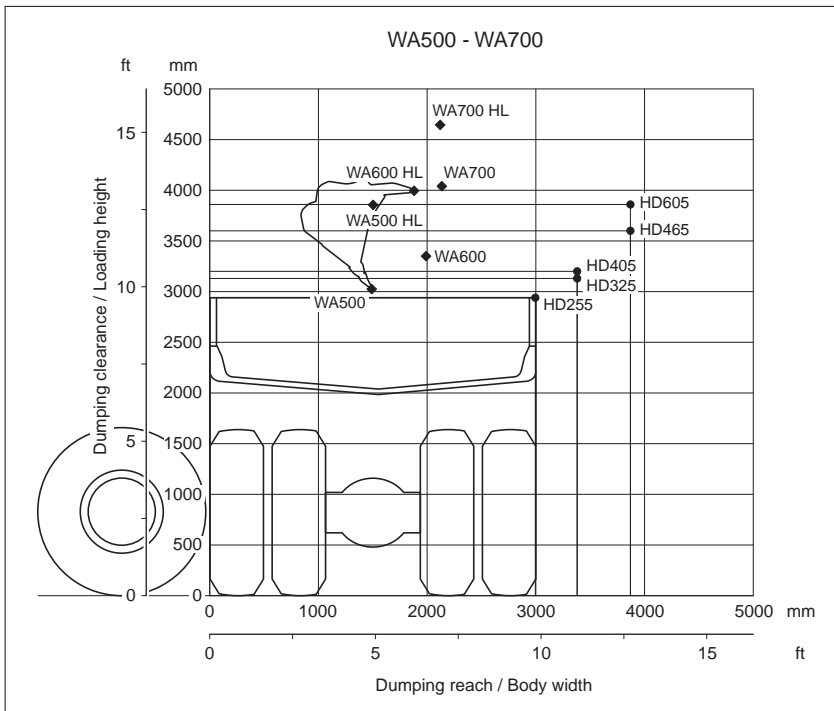

Chart shows dumping reach and dumping clearance of standard size buckets. HL means high lift boom.

- ◆ : Indicates dumping reach and clearance at the end of teeth or BOC.
- : Indicates the top corner of body.

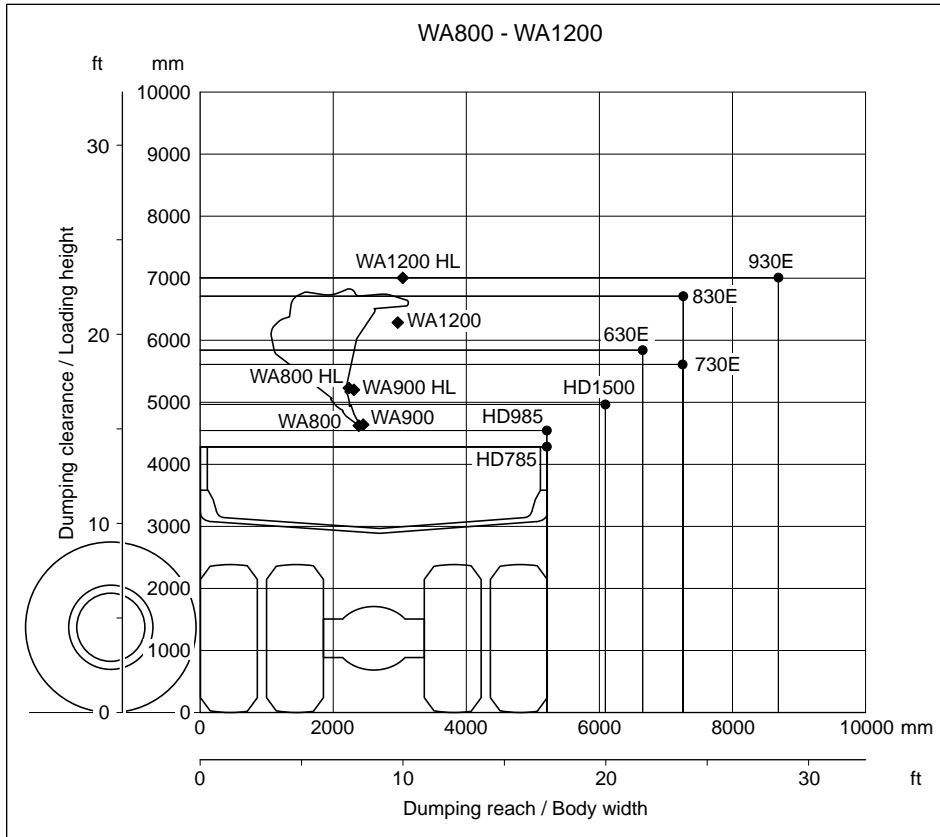

Chart shows dumping reach and dumping clearance of standard size buckets.
HL means high lift boom.

- ◆ : Indicates dumping reach and clearance at the end of teeth or BOC.
- : Indicates the top corner of body.

Wheel Loader and Dump Truck Combination

WHEEL LOADERS

Wheel loader				Dump truck (Loading height)*1					
Model	Heaped bucket capacity m ³ (cu.yd)	Bucket type	*1 Dumping clearance. At the end of teeth or BOC mm (ft.in)	HD255 (2975 mm) (9'9")	HD325-6 (3200 mm) (10'6") HD325-7 (3220 mm) (10'7")	HD405-6 (3430 mm) (11'3") HD405-7 (3450 mm) (11'4")	HD465 (3600 mm) (11'10")	HD605 (3860 mm) (12'8")	HD785 (4285 mm) (14'1")
				Payload in ton (U.S. ton)					
				25 (27.6)	36.5 (40)	41 (55)	55 (61)	63 (69)	91 (100)
				17.7 m ³ (23.2 yd ³)	24 m ³ (31.4 yd ³)	27.3 m ³ (35.7 yd ³)	34.2 m ³ (44.7 yd ³)	40 m ³ (52.3 yd ³)	60 m ³ (78.5 yd ³)
WA430	3.5 (4.6)	General purpose (stock pile) with bolt-on cutting edges	3020 (9'11")	4					
	3.3 (4.3)	General purpose (stock pile) with teeth	2895 (9'6")	4					
WA470	4.2 (5.5)	General purpose (stock pile) with bolt-on cutting edges	3120 (10'3")	3					
	3.9 (5.1)	General purpose (stock pile) with teeth	2995 (9'10")	4					
WA480	4.6 (6.0)	General-purpose bucket with bolt-on cutting edges	3205 (10'6")	3	4				
	4.3 (5.6)	General-purpose bucket with teeth	3080 (10'1")	3					
WA500	4.3 (5.6)	General purpose (excavating, straight edges) with teeth	3025 (9'11")	3					
	4.3 (5.6)	Spade nose rock bucket with tip teeth	2770 (9'1")						
WA500 High lift	4.2 (5.5)	General purpose (excavating, straight edges) with teeth	3565 (11'8")	3	5	5			
WA600	6.1 (8.0)	Spade nose rock bucket with teeth	3350 (11'0")	2	3	4			
WA600 High lift	5.6 (7.3)	Spade nose rock bucket with teeth	3995 (13'1")	2	4	4	5	6	
WA700	8.7 (11.4)	Spade nose rock bucket with teeth	4040 (13'3")	2	2	3	4	4	
WA700 High lift	8.0 (10.5)	Spade nose rock bucket with teeth	4645 (15'3")	2	3	3	4	4	6

Wheel loader				Dump truck (Loading height)*1							
Model	Heaped bucket capacity m ³ (cu.yd)	Bucket type	*1 Dumping clearance. At the end of teeth or BOC mm (ft.in)	HD465 (3600 mm) (11'10")	HD605 (3860 mm) (12'8")	HD785 (4285 mm) (14'1")	HD1500 (4965 mm) (16'3")	730E (5610 mm) (18'5")	830E (6710 mm) (22'0")	860E (6390 mm) (20'11")	930E (7060 mm) (23'7")
				Payload m ton (U.S. ton)							
				55 (61)	63 (69)	91 (100)	144 (159)	184 (203)	222 (255)	254 (280)	292 (320)
				34.2 m ³ (44.7 yd ³)	40 m ³ (52.3 yd ³)	60 m ³ (78.5 yd ³)	78 m ³ (102 yd ³)	111 m ³ (145 yd ³)	147 m ³ (193 yd ³)	169 m ³ (221 yd ³)	211 m ³ (276 yd ³)
WA800	11.0 (14.4)	Spade nose rock bucket with teeth	4630 (15'2")	3	3	5					
WA800 High lift	10.0 (13.1)	Spade nose rock bucket with teeth	5200 (17'1")	3	4	5	8				
WA900	13.0 (17.0)	Spade nose rock bucket with teeth	4640 (15'3")	2	3	4					
WA900 High lift	11.5 (15.0)	Spade nose rock bucket with teeth	5230 (17'3")	3	3	4	7				
WA1200	20.0 (26.2)	Spade nose rock bucket with teeth	6305 (20'8")				4	5			
WA1200 High lift	18.0 (23.5)	Spade nose rock bucket with teeth	7065 (23'2")				4	6	7	8	9

Number of loading times is calculated based on following condition.

1. Calculate number of loading times from maximum payload of dump truck. Please see formula 1.
2. Calculate number of loading times from body capacity of dump truck. Please see formula 2.
3. Adopt lower number between formula 1 and formula 2.

Formula 1

Number of loading = Payload of truck (metric tonnes) / (Bucket capacity of loader (m³) × loose density × bucket factor)

Formula 2

Number of loading = Body capacity (cubic meter) / (Bucket capacity of loader (m³) × bucket factor)

We adopt following condition.

Density = 1.8 metric tonnes per cubic meter

Bucket factor = 1.0

Wheel Loader and Dump Truck Combination

WHEEL LOADERS

*1: Dumping clearance and loading height change depending on tires.

Above combination is determined by following method;

(1) Suitable loading times (n): 3-5 times

$$n = \frac{\text{Max. payload of dump truck}}{\text{Bucket capacity} \times \text{Bucket fill factor} \times \text{Specific weight}}$$

or

$$n = \frac{\text{Heaped capacity of dump truck}}{\text{Bucket capacity} \times \text{Bucket fill factor}}$$

(2) Dumping clearance (DC)

Small and medium sized loaders: $DC \geq H$

Large sized loaders: $DC \geq H + (W/12)$

(3) Dumping reach (DR)

Small and medium sized loaders: $DR \geq (W/6) + 500 \text{ mm}$

Large sized loaders: $DC \geq W/3$

(4) Body length (L)

The dump truck's body length should be 1.3 to 1.7 times longer than the width of the bucket.

WA500-6/WA500-6R (General purpose bucket with BOC)		Dimension	HD255-5	HD325-6	HD325-7 HD325-7R
Dumping clearance (DC)	3295 (10'10")	Body height (H)	2940 (9'8")	3200 (10'6")	3220 (10'7")
Dumping reach (DR)	1500 (4'11")	Body width (W)	2995 (9'10")	3380 (11'1")	3380 (11'1")
Bucket width	3400 (11'2")	Body length (L)	4570 (15')	5500 (18'1")	5500 (18'1")

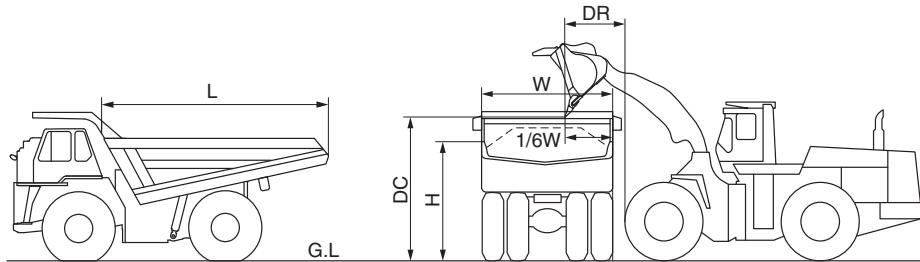

FVBH0298

WA470-6/WA470-5 (Stockpile bucket)		Dimension	HD255-5
Dumping clearance (DC)	3120 (10'3")	Body height (H)	2975 (9'9")
Dumping reach (DR)	1305 (4'3")	Body width (W)	2995 (9'10")
Bucket width	3170 (10'5")	Body length (L)	4570 (15')

WA470-7 (General purpose bucket)		Dimension	HD255-5
Dumping clearance (DC)	3185 (10'5")	Body height (H)	2975 (9'9")
Dumping reach (DR)	1235 (4'1")	Body width (W)	2995 (9'10")
Bucket width	3170 (10'5")	Body length (L)	4570 (15')

WA480-6/WA480-5 (Stockpile bucket)		Dimension	HD255-5
Dumping clearance (DC)	3205 (10'6")	Body height (H)	2940 (9'8")
Dumping reach (DR)	1410 (4'8")	Body width (W)	2995 (9'10")
Bucket width	3170 (10'5")	Body length (L)	4570 (15')

WA500-3 (Excavating bucket with straight edge)		Dimension	HD255-5	HD325-6	HD325-7 HD325-7R
Dumping clearance (DC)	3025 (9'11")	Body height (H)	2940 (9'8")	3200 (10'6")	3220 (10'7")
Dumping reach (DR)	1490 (4'11")	Body width (W)	2995 (9'10")	3380 (11'1")	3380 (11'1")
Bucket width	3460 (11'4")	Body length (L)	4570 (15')	5500 (18'1")	5500 (18'1")

WA500-7 (General purpose bucket)		Dimension	HD255-5	HD325-6	HD325-7 HD325-7R
Dumping clearance (DC)	3295 (10'10")	Body height (H)	2940 (9'8")	3200 (10'6")	3220 (10'7")
Dumping reach (DR)	1500 (4'11")	Body width (W)	2995 (9'10")	3380 (11'1")	3380 (11'1")
Bucket width	3400 (11'2")	Body length (L)	4570 (15')	5500 (18'1")	5500 (18'1")

Wheel Loader and Dump Truck Combination

WHEEL LOADERS

WA600-6/WA600-6R (Excavating bucket with spade nose)		Dimension	HD255-5	HD325-6	HD405-6	HD405-7 HD405-7R
Dumping clearance (DC)	3995 (13'1")	Body height (H)	2940 (9'8")	3200 (10'6")	3430 (11'3")	3450 (11'4")
Dumping reach (DR)	1800 (5'11")	Body width (W)	2995 (9'10")	3380 (11'1")	3380 (11'1")	3380 (11'1")
Bucket width	3685 (12'1")	Body length (L)	4570 (15')	5500 (18'1")	5590 (18'4")	5590 (18'4")

WA600-3 (Excavating bucket with spade nose)		Dimension	HD255-5	HD325-6	HD405-6	HD405-7 HD405-7R
Dumping clearance (DC)	3350 (11')	Body height (H)	2940 (9'8")	3200 (10'6")	3430 (11'3")	3450 (11'4")
Dumping reach (DR)	1990 (6'6")	Body width (W)	2995 (9'10")	3380 (11'1")	3380 (11'1")	3380 (11'1")
Bucket width	3685 (12'1")	Body length (L)	4570 (15')	5500 (18'1")	5590 (18'4")	5590 (18'4")

WA700-3 (Excavating bucket with spade nose)		Dimension	HD325-7 HD325-7R	HD325-6	HD405-7 HD405-7R	HD405-6	HD465-7E0 HD465-7 HD465-7R	HD605-7E0 HD605-7 HD605-7R	HD785-5
Dumping clearance (DC)	4040 (13'3")	Body height (H)	3220 (10'7")	3200 (10'6")	3450 (11'4")	3430 (11'3")	3600 (11'10")	3860 (12'8")	4285 (14'1")
Dumping reach (DR)	2135 (7')	Body width (W)	3380 (11'1")	3380 (11'1")	3380 (11'1")	3380 (11'1")	3870 (12'8")	3870 (12'8")	4880 (16')
Bucket width	4330 (14'2")	Body length (L)	5500 (18'1")	5500 (18'1")	5590 (18'4")	5590 (18'4")	6450 (21'2")	6600 (21'8")	7480 (24'6")

WA800-3/WA800-3E0 (Excavating bucket)		Dimension	HD465-7	HD605-7	HD785-5	HD785-7
Dumping clearance (DC)	4630 (15'2")	Body height (H)	3600 (11'10")	3860 (12'8")	4285 (14'1")	4285 (14'1")
Dumping reach (DR)	2385 (7'10")	Body width (W)	3870 (12'8")	3870 (12'8")	4880 (16')	5200 (17'1")
Bucket width	4810 (15'7")	Body length (L)	6450 (21'2")	6600 (21'8")	7480 (24'6")	7065 (23'2")

WA900-3/WA900-3E0		Dimension	HD465-7	HD605-7	HD785-5	HD785-7
Dumping clearance (DC)	4640 (15'3")	Body height (H)	3600 (11'10")	3860 (12'8")	4285 (14'1")	4285 (14'1")
Dumping reach (DR)	2450 (8')	Body width (W)	3870 (12'8")	3870 (12'8")	4880 (16')	5200 (17'1")
Bucket width	4810 (15'9")	Body length (L)	6450 (21'2")	6600 (21'8")	7480 (24'6")	7065 (23'2")

WA1200-6		Dimension	HD1500-7
Dumping clearance (DC)	6305 (20'8")	Body height (H)	4965 (16'3")
Dumping reach (DR)	2890 (9'6")	Body width (W)	5705 (18'9")
Bucket width	6400 (21'0")	Body length (L)	7625 (25')

Standard Production – Loading (m³/h)

Cycle Time (min)	Cycles Per Hr	Bucket Size** (cu.m)														
		1.0	1.5	2.0	2.5	3.0	3.5	4.0	4.5	5.0	5.5	6.0	6.5	7.0	7.5	
0.35	171				White area indicates average production											
0.40	150	150	225	300	375	450										
0.45	133	133	200	266	332	400	466	530	600	665						
0.50	120	120	180	240	300	360	420	480	540	600	660	720	780	840	900	
0.55	109	109	164	218	272	328	382	436	480	545	600	655	705	785	820	
0.60	100	100	180	200	250	300	350	400	450	500	550	600	650	700	750	
0.65	92	92	138	184	230	278	322	368	416	460	505	555	600	645	690	
0.70	86						300	342	386	430	471	515	555	600	645	
0.75	80										440	480	520	560	600	

Cycle Time (min)	Cycles Per Hr	Bucket Size** (cu.m)													
		8.0	8.5	9.0	9.5	10.0	10.5	11.0	12.0	13.0	14.0	16.0	18.0	20.0	
0.35	171				White area indicates average production										
0.40	150														
0.45	133														
0.50	120	960	1020	1080	1140	1200	1200	1320	1440	1560	1680	1920	2160	2400	
0.55	109	870	925	980	1040	1090	1150	1200	1310	1420	1530	1750	1960	2180	
0.60	100	800	850	900	950	1000	1050	1100	1200	1300	1400	1600	1800	2000	
0.65	92	735	780	830	875	920	965	1010	1110	1200	1290	1480	1660	1850	
0.70	86	685	730	770	815	855	900	945	1030	1110	1200	1370	1540	1710	
0.75	80	640	680	720	780	800	840	880	960	1040	1120	1280	1440	1600	

* Actual production = (Standard production) × (Bucket fill factor) × (Job efficiency)

** Bucket size: Heaped bucket capacity

Bucket fill factor (K)

Loading conditions	K
Easy loading	1.0 ~ 1.1
Average loading	0.85 ~ 0.95
Rather difficult loading	0.8 ~ 0.85
Difficult loading	0.75 ~ 0.8

Job efficiency (E)

Operating conditions	E
Good	0.83
Average	0.75
Rather poor	0.67
Poor	0.58

MEMO

A series of horizontal dashed lines for writing.

SECTION **3B**

WHEEL DOZERS

CONTENTS

Features 3B-2
Specifications 3B-3
Dimensions 3B-4

- Komatsu components throughout the machine assure years of reliability and high-performance service.
- Adjustment-free wet disc brakes for steady braking and extended service life.
- Electronic Display and Monitoring System for minimized maintenance.
- A large drawbar horsepower with fuel-efficient, powerful Komatsu diesel engine for high productivity and maneuverability.
- Fingertip control with Electrically Controlled Transmission.
- A tiltable steering wheel and fully adjustable suspension seat.

Specifications

WHEEL DOZERS

Item	Model	WD600-6	WD600-3	WD900-3	
OPERATING WEIGHT	kg (lb)	48100 (106,040)	42900 (94,577)	100000 (220,460)	
HORSEPOWER	kW (HP)/rpm	393 (527)/1800	362 (485)/2000	637 (853)/2000	
BLADE CAPACITY	m ³ (cu.yd)	8.0 (10.5)	8.0 (10.5)	26.0 (34.0)	
PERFORMANCE:					
Travel speed	km/h (MPH)				
Forward					
1st		6.7 (4.2)	6.5 (4.0)	7.0 (4.3)	
2nd		11.7 (7.3)	11.8 (7.3)	12.3 (7.6)	
3rd		20.3 (12.6)	20.8 (12.9)	28.0 (17.4)	
4th		33.0 (20.5)	36.2 (22.5)	—	
Reverse					
1st		7.3 (4.5)	7.2 (4.5)	7.1 (4.4)	
2nd		12.8 (8.0)	13.0 (8.1)	12.4 (7.7)	
3rd		22.0 (13.7)	23.0 (14.3)	28.3 (17.6)	
4th		36.0 (22.4)	40.0 (24.9)	—	
Turning radius (Outside corner of blade)	mm (ft.in)	8610 (28'3")	8500 (27'11")	9200 (30'2")	
Max. rim pull	kg (lb)	43800 (96,580)	42800 (94,360)	100000 (220,460)	
DIMENSIONS:					
Overall length	mm (ft.in)	9930 (32'7")	9285 (30'6")	12035 (39'6")	
Overall width (without blade)	mm (ft.in)	3570 (11'9")	3570 (11'9")	4460 (14'8")	
Overall height	mm (ft.in)	4460 (14'8")	4245 (13'11")	5215 (17'1")	
Wheelbase	mm (ft.in)	4500 (14'9")	4100 (13'5")	5450 (31')	
Treads (front and rear)	mm (ft.in)	2650 (11'9")	2650 (8'8")	3350 (11')	
Articulation angle	degree	43	40	40	
ENGINE:					
Model		KOMATSU SAA6D170E-5	KOMATSU SAA6D170E-3	KOMATSU SA12V140	
No. of cylinders- bore × stroke	mm (in)	6-170 x 170 (6.69 x 6.69)	6-170 x 170 (6.69 x 6.69)	12-140 × 165 (5.5 × 6.5)	
Piston displacement	ltr. (cu.in)	23.15 (1413)	23.15 (1413)	30.5 (1861)	
CAPACITY:					
Fuel tank	ltr. (U.S. Gal)	718 (190)	670 (177)	1430 (378)	
TIRE:					
(front)		35/65-33-24PR	35/65-33-24PR	45/65-R45XLDD (L4)	
(rear)		35/65-33-24PR	35/65-33-24PR	45/65-R45XLDD (L4)	

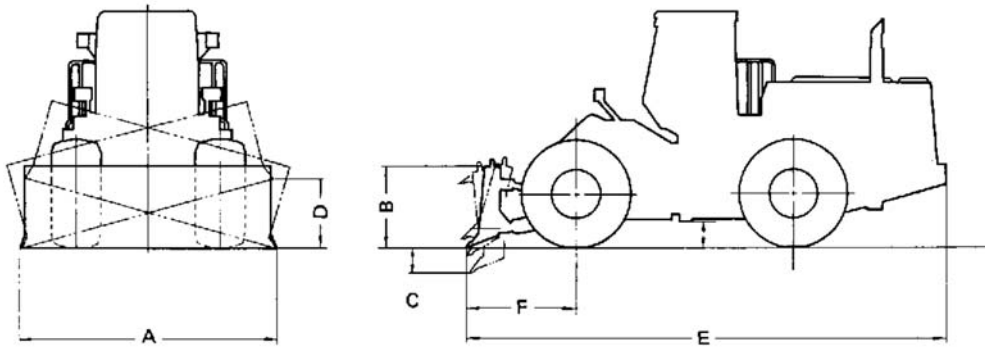

	Model	WD600-6	WD600-6	WD600-3
Blade type	—	Straight Blade	U-blade	Straight Blade
Blade capacity (SAE Rated)	m ³ (cu.yd)	8.0 (10.5)	10.6 (13.8)	8.0 (10.5)
A Blade width	mm (ft.in)	5100 (16'9")	4870 (16'0")	5100 (16'9")
B Max. lift above ground	mm (ft.in)	1500 (4'11")	1485 (4'10")	1500 (4'11")
C Max. drop below ground	mm (ft.in)	450 (17.7")	490 (1'7")	450 (17.7")
D Max. tilt adjustment	mm (ft.in)	1430 (4'8")	1340 (4'5")	1430 (4'8")
Max. pitch angle adjustment	degree	23°		23°
E Overall length	mm (ft.in)	9930 (32'7")		9285 (30'6")
F Front overhang	mm (ft.in)	2220 (7'3")		2205 (7'3")
Turning radius	mm (ft.in)	8610 (28'3")		
Operating weight (include ROPS)	kg (lb)	48100 (106,040)	49115 (108,280)	42900 (94,360)

	Model	WD900-3	
Blade type	—	Semi-U blade	Coal blade
Blade capacity (SAE Rated)	m ³ (cu.yd)	26.0 (34.0)	45.0 (58.9)
A Blade width	mm (ft.in)	6470 (21'3")	7400 (24'3")
B Max. lift above ground	mm (ft.in)	1580 (5'2")	1560 (5'1")
C Max. drop below ground	mm (ft.in)	680 (2'3")	680 (3'3")
D Max. tilt adjustment	mm (ft.in)	1330 (4'4")	1710 (5'7")
Max. pitch angle adjustment	degree	8°	8°
E Overall length	mm (ft.in)	12035 (39'6")	
F Front overhang	mm (ft.in)	3385 (11'1")	
Turning radius	mm (ft.in)	11285 (37')	
Operating weight (include ROPS)	kg (lb)	100000 (220460)	

CONTENTS

INDEX

SECTION **4**

RIGID DUMP TRUCKS Sec 4A

ARTICULATED DUMP TRUCKS Sec 4B

SECTION **4A**

**RIGID
DUMP TRUCKS**

CONTENTS

Features 4A-2
Specifications 4A-5
Dimensions 4A-9
Use of Performance Curve 4A-12
Performance Curves:
 HD255-5 4A-13
 HD325-7, HD325-7R 4A-15
 HD325-6 4A-17
 HD405-7, HD405-7R 4A-19
 HD405-6 4A-21
 HD465-7E0, HD465-7R 4A-23
 HD465-7 4A-25
 HD605-7E0, HD605-7R 4A-27
 HD785-7 4A-29
 HD1500-7 4A-32
 730E 4A-33
 830E-AC 4A-34
 860E-1K 4A-35
 930E-4 4A-36
 930E-4SE 4A-37
 960E-2 4A-38
 960E-2K 4A-39
Attachments and Options 4A-40
Tire Selection 4A-44
Body Selection 4A-52
Production 4A-60

Ecology Features

ecot3 (EPA Tier 3, EU Stage 3A certified engine)

Komatsu develops and produces all major components, such as engines, electronics and hydraulic components in house.

With this “Komatsu Technology”, and adding customer feedback, Komatsu is achieving great advancements in technology.

To achieve high levels of productivity and ecology, Komatsu developed the main components with an advanced control system.

The result is a new generation of high performance and environment friendly machines.



Fuel efficient electronic controlled engine

The engine is EPA Tier 3 and EU Stage 3A emission regulation certified. The engine is turbocharged and features Common Rail Injection System (CRI) and air-to-air aftercooling to maximize power, fuel efficiency and emission compliance.

To minimize noise and vibration, the engine is mounted to the main frame with rubber cushions.

(HD325/405-7, HD465/605-7E0)

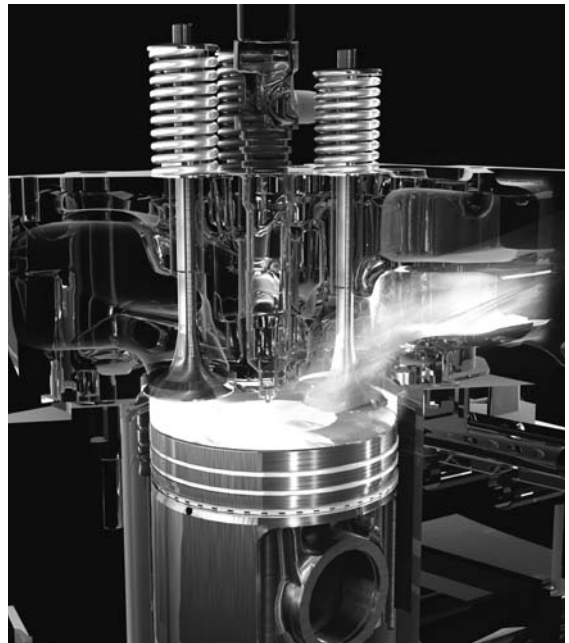

■ High productivity

The result of total performance: High performance, minimum downtime, and easy operation

■ Dependable and high-performance components

- Komatsu diesel engine delivers high-output and direct injection system provides high fuel efficiency
- Full-automatic TORQFLOW transmission: A microcomputer built into the shift controller automatically selects the optimum gear position according to travel speed, load and road conditions assuring effort-free operation.
- High-performance, durable brakes: Sealed, oil-cooled, multiple-disc brakes on rear wheels are designed for extended operation. The large-capacity rear wheel brakes also act as retarders as a precaution against engine overrunning when descending steep inclines.
- High maneuverability: The MacPherson strut type front suspension system has a special A-frame between each wheel and the main frame. The wider space created between the front wheels and the main frame increases the turning angle of the wheels. The larger this turning angle, the smaller the turning radius of the truck.
- Extra sturdiness: Box-section, ladder type frame construction of high-tensile-strength steel plate and cast steel offer unfaltering durability for long service.
- Rigorous dump body design: The dump body is made of high-tensile-strength steel for excellent rigidity and reduced maintenance costs. The V-shape design also increases structural strength. The side and bottom plates of the dump section are reinforced with ribs for added strength.

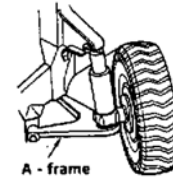
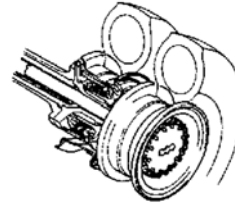
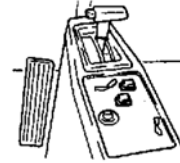
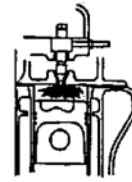

A - frame

Painted part casting steel

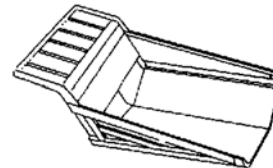
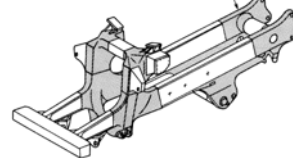

■ Easy maintenance

- Advanced monitoring system: The Komatsu advanced monitoring system identifies maintenance items, reduces diagnostic times, indicates oil and filter replacement hours and displays abnormality codes. This monitor system helps to maximize machine production time.
- Greasing points have been centralized. Fuel and engine oil filters are also located together on the right-hand remote mount for easy, remote inspection from the ground.



■ Automatic Retard Speed Control (ARSC)

ARSC allows the operator to simply set the downhill travel speed and go down slopes at a constant speed. As a result, the operator can concentrate on steering. The speed can be set at increments of 1 km/h 0.6 MPH per click (± 5 km/h 3.1 MPH of maximum speed adjustment) to match the optimum speed for the slope. Also, since the retarder cooling oil temperature is always monitored, the speed is automatically lowered.

(STD for HD465/605-7, 7E0, 7R, HD785-7)

(Option for HD325/405-7, 7R)

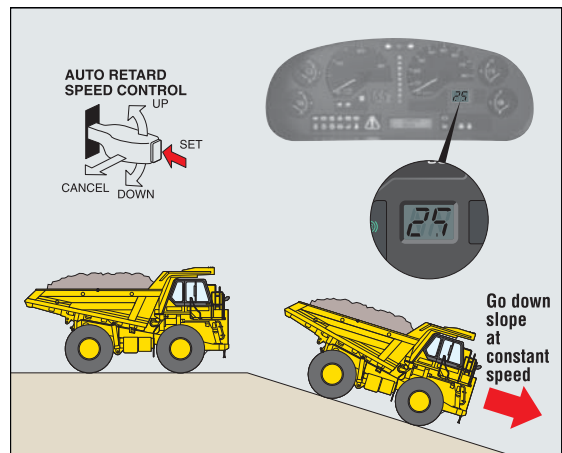

VHMS (Vehicle Health Monitoring System) (Option for HD465/605-7, 7E0, 7R, HD785-5, HD785-7)

VHMS controller monitors the health conditions of major components, enables remote analysis of the machine and its operation. This process is supported by the Komatsu distributors, factory and design team. This contributes to reduced repair costs and to maintaining maximum availability.

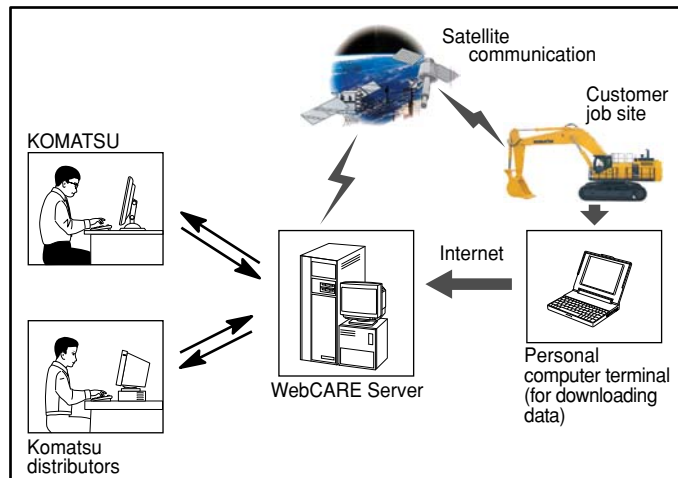

■ Merits of Using VHMS

Diagnosis

- Machine health information that used to take approximately 1 hour to be measured can now be downloaded by personal computer in approximately 10 minutes, shortening the vehicle's down time.
- Furthermore, if the satellite communications function is equipped, the machine information can be gathered without stopping the vehicle at all. (Not available in some regions.)

Recommendation

- An appropriate recommendation can be made by viewing these data over the Internet.
 - Proper driving methods
 - Formulation of maintenance plans in advance that suit the customer's production schedule.

Customer's Benefit

- Sudden break down can be prevented through utilization of data trend (change over time).
- Ascertaining the facts and searching for the cause of the breakdown are simplified, thus enabling problems to be resolved quickly.
- Down time can be shortened by the systematic use of Reman components.
- Machine life can be extended significantly by proper operation and proper maintenance.

Specifications

RIGID DUMP TRUCKS

Model		HD255-5	•HD325-7	HD325-7R
Source	—	Japan	Japan	Japan
WEIGHT:	kg (lb)			
Empty vehicle weight*		22450 (49,490)	31600 (69,700)	31600 (69,700)
Distribution (front)		10775 (23,750)	16337 (36,020)	16337 (36,020)
(rear)		11675 (25,740)	15263 (33,650)	15263 (33,650)
Gross vehicle weight		47525 (104,770)	63680 (140,390)	63680 (140,390)
Distribution (front)		15210 (33,530)	21014 (46,330)	21014 (46,330)
(rear)		32315 (71,240)	42666 (94,060)	42666 (94,060)
Max. gross vehicle weight**		—	69280 (152,740)	69280 (152,740)
Gross horsepower	kW (HP)/RPM	241 (323)/2100	386 (518)/2000	386 (518)/2000
Net horsepower	kW (HP)/RPM	235 (316)/2100	371 (498)/2000	371 (498)/2000
HAULING CAPACITY:				
Maximum payload	m. ton (U.S. ton)	25 (27.6)	36.5 (40)	36.5 (40)
Heaped capacity (2:1)	m ³ (yd ³)	17.7 (23.2)	24.0 (31.4)	24.0 (31.4)
PERFORMANCE:				
Maximum speed	km/h (MPH)	47.0 (29.2)	70 (43.5)	70 (43.5)
Turning radius	m (ft.in)	7.0 (23')	7.2 (23'7")	7.2 (23'7")
ENGINE:				
Model		KOMATSU SAA6D125E-3	KOMATSU SAA6D140E-5	KOMATSU SAA6D140E-5
No. of cylinders-		6	6	6
bore × stroke	mm (in)	125 × 150 (4.92 × 5.91)	140 × 165 (5.51 × 6.50)	140 × 165 (5.51 × 6.50)
Displacement	ltr. (in ³)	11.04 (674)	15.24 (930)	15.24 (930)
DIMENSION:		See DIMENSIONS		
TIRES:				
Front tire		16.00-25-28PR × 2	18.00-33-32PR × 2	18.00-33-32PR × 2
Rear tire		16.00-25-28PR × 4	18.00-33-32PR × 4	18.00-33-32PR × 4
CAPACITY: Fuel tank	ltr. (U.S. Gal)	374 (98.8)	484 (127.9)	484 (127.9)

Model		HD325-6	•HD405-7	HD405-7R
Source	—	Japan	Japan	Japan
WEIGHT:	kg (lb)			
Empty vehicle weight*		28700 (63,270)	34400 (75,840)	34400 (75,840)
Distribution (front)		13780 (30,380)	17440 (38,450)	17440 (38,450)
(rear)		14920 (32,890)	16960 (37,390)	16960 (37,390)
Gross vehicle weight		60780 (134,000)	74480 (164,200)	74480 (164,200)
Distribution (front)		19450 (42,880)	24430 (53,860)	24430 (53,860)
(rear)		41330 (92,120)	50050 (110,340)	50050 (110,340)
Max. gross vehicle weight**		65200 (143,740)	75080 (165,520)	75080 (165,520)
Gross horsepower	kW (HP)/RPM	379 (508)/2000	386 (518)/2000	386 (518)/2000
Net horsepower	HP	364 (488)/2000	371 (498)/2000	371 (498)/2000
HAULING CAPACITY:				
Maximum payload	m. ton (U.S. ton)	36.5 (40)	41 (45.2)	41 (45.2)
Heaped capacity (2:1)	m ³ (yd ³)	24.0 (31.4)	27.3 (35.7)	27.3 (35.7)
PERFORMANCE:				
Maximum speed	km/h (MPH)	70 (43.5)	70 (43.5)	70 (43.5)
Turning radius	m (ft.in)	7.2 (23'7")	7.2 (23'7")	7.2 (23'7")
ENGINE:				
Model		KOMATSU SAA6D140E-3	KOMATSU SAA6D140E-5	KOMATSU SAA6D140E-5
No. of cylinders-		6	6	6
bore × stroke	mm (in)	140 × 165 (5.51 × 6.50)	140 × 165 (5.51 × 6.50)	140 × 165 (5.51 × 6.50)
Displacement	ltr. (in ³)	15.23 (930)	15.24 (930)	15.24 (930)
DIMENSION:		See DIMENSIONS		
TIRES:				
Front tire		18.00-33-28PR × 2	18.00 R33 × 2	18.00 R33 × 2
Rear tire		18.00-33-28PR × 4	18.00 R33 × 4	18.00 R33 × 4
CAPACITY: Fuel tank	ltr. (U.S. Gal)	500 (132.0)	484 (127.9)	484 (127.9)

* Weight includes lubricants, coolant, full fuel tank and standard body.

** Max. gross vehicle weight, including optional equipment, lubricants, coolant, full fuel tank and payload, with large tires installed, shall not be exceeded.

- Tier 3 and Stage 3A model

Specifications

RIGID DUMP TRUCKS

Item	Model	HD405-6	•HD465-7E0	HD465-7R
Source	—	Japan	Japan, India	Japan
WEIGHT:	kg (lb)			
Empty vehicle weight*		32050 (70,660)	43100 (95,020)	43100 (95,020)
Distribution (front)		14420 (31,790)	20257 (44,660)	20257 (44,660)
(rear)		17630 (38,870)	22843 (50,360)	22843 (50,360)
Gross vehicle weight		72125 (159,010)	99680 (219,760)	99680 (219,760)
Distribution (front)		22850 (50,380)	31898 (70,320)	31898 (70,320)
(rear)		49275 (108,630)	67782 (149,430)	67782 (149,430)
Max. gross vehicle weight**		73175 (161,320)	—	—
Gross horsepower	kW (HP)/RPM	379 (508)/2000	551 (739)/2000	551 (739)/2000
Net horsepower	kW (HP)/RPM	364 (488)/2000	533 (715)/2000	533 (715)/2000
HAULING CAPACITY:				
Maximum payload	m. ton (U.S. ton)	41 (45)	55 (60.6)	55 (60.6)
Heaped capacity (2:1)	m ³ (yd ³)	27.3 (35.7)	34.2 (44.7)	34.2 (44.7)
PERFORMANCE:				
Maximum speed	km/h (MPH)	70 (43.5)	70 (43.5)	70 (43.5)
Turning radius	m (ft.in)	7.2 (23'7")	8.5 (27'11")	8.5 (27'11")
ENGINE:				
Model		KOMATSU SAA6D140E-3	KOMATSU SAA6D170E-5	KOMATSU SAA6D170E-5
No. of cylinders-		6	6	6
bore × stroke	mm (in)	140 × 165 (5.91 × 6.50)	170 × 170 (6.69 × 6.69)	170 × 170 (6.69 × 6.69)
Displacement	ltr. (in ³)	15.23 (930)	23.15 (1413)	23.15 (1413)
DIMENSION:		See DIMENSIONS		
TIRES:				
Front tire		18.00 R33 × 2	24.00-35-36PR × 2	24.00-35-36PR × 2
Rear tire		18.00 R33 × 4	24.00-35-36PR × 4	24.00-35-36PR × 4
CAPACITY: Fuel tank	ltr. (U.S. Gal)	500 (132.0)	780 (206.1)	780 (206.1)

Item	Model	HD465-7	•HD605-7E0	HD605-7R
Source	—	Japan	Japan	Japan
WEIGHT:	kg (lb)			
Empty vehicle weight*		42800 (94,360)	46200 (101,850)	46200 (101,850)
Distribution (front)		20120 (44,360)	21714 (47,870)	21714 (47,870)
(rear)		22680 (50,000)	24486 (53,980)	24486 (53,980)
Gross vehicle weight		97875 (215,780)	110180 (242,900)	110180 (242,900)
Distribution (front)		31320 (69,050)	35258 (77,730)	35258 (77,730)
(rear)		66555 (146,730)	74922 (165,170)	74922 (165,170)
Max. gross vehicle weight**		98800 (217,810)	—	—
Gross horsepower	kW (HP)/RPM	551 (739)/2000	551 (739)/2000	551 (739)/2000
Net horsepower	HP	533 (715)/2000	533 (715)/2000	533 (715)/2000
HAULING CAPACITY:				
Maximum payload	m. ton (U.S. ton)	55 (61)	63 (69.4)	63 (69.4)
Heaped capacity (2:1)	m ³ (yd ³)	34.2 (44.7)	40.0 (52.3)	40.0 (52.3)
PERFORMANCE:				
Maximum speed	km/h (MPH)	70 (43.5)	70 (43.5)	70 (43.5)
Turning radius	m (ft.in)	8.5 (27'11")	8.5 (27'11")	8.5 (27'11")
ENGINE:				
Model		KOMATSU SAA6D170E-3	KOMATSU SAA6D170E-5	KOMATSU SAA6D170E-5
No. of cylinders-		6	6	6
bore × stroke	mm (in)	170 × 170 (6.69 × 6.69)	170 × 170 (6.69 × 6.69)	170 × 170 (6.69 × 6.69)
Displacement	ltr. (in ³)	23.15 (1.413)	23.15 (1413)	23.15 (1413)
DIMENSION:		See DIMENSIONS		
TIRES:				
Front tire		24.00-35-36PR × 2	24.00 R35 × 2	24.00 R35 × 2
Rear tire		24.00-35-36PR × 4	24.00 R35 × 4	24.00 R35 × 4
CAPACITY: Fuel tank	ltr. (U.S. Gal)	780 (206.1)	780 (206.1)	780 (206.1)

* Weight includes lubricants, coolant, full fuel tank and standard body.

** Max. gross vehicle weight, including optional equipment, lubricants, coolant, full fuel tank and payload, with large tires installed, shall not be exceeded.

- Tier 3 and Stage 3A model

Specifications

RIGID DUMP TRUCKS

Item	Model			
		HD785-7	HD1500-7	HD1500-7
Source	—	Japan, Indonesia***	Japan	USA
WEIGHT:	kg (lb)			
Empty vehicle weight*		72000 (158,730)	105300 (232,140)	105755 (233,150)
Distribution (front)		33840 (74,600)	51175 (112,820)	51715 (114,010)
(rear)		38160 (84,130)	54125 (119,320)	54040 (119,140)
Gross vehicle weight		163080 (359,530)	249478 (550,000)	249478 (550,000)
Distribution (front)		51370 (113,250)	81828 (180,400)	81828 (180,400)
(rear)		111710 (246,280)	167650 (369,600)	167650 (369,600)
Max. gross vehicle weight**		166000 (366,000)	249478 (550,000)	249478 (550,000)
Gross horsepower	kW (HP)/RPM	895 (1200)/1900	1109 (1487)/1900	1119 (1500)/1900
Net horsepower	kW (HP)/RPM	879 (1178)/1900	1048 (1406)/1900	1044 (1399)/1900
HAULING CAPACITY:				
Maximum payload	m. ton (US ton)	91 (100)	144.1 (158.9)	144.1 (158.9)
Heaped capacity (2:1)	m ³ (yd ³)	60 (78.5)	78 (102)	78 (102)
PERFORMANCE:				
Maximum speed	km/h(MPH)	65 (40.4)	58 (36.0)	58 (36.0)
Turning radius	m (ft.in)	10.1 (33'2")	12.2 (40'0")	12.2 (40'0")
ENGINE:				
Model		KOMATSU SAA12V140E-3	KOMATSU SDA12V160	KOMATSU SDA16V159E-2
No. of cylinders-		12	12	16
bore × stroke	mm (in)	140 × 165 (5.51 × 6.50)	159 × 190 (6.26 × 7.48)	159 × 159 (6.26 × 6.26)
Displacement	ltr. (in ³)	30.48 (1860)	45.0 (2746)	50.5 (3082)
DIMENSION:		See DIMENSIONS		
TIRES:				
Front tire		27.00 R49 × 2	33.00 R51 × 2	33.00 R51 × 2
Rear tire		27.00 R49 × 4	33.00 R51 × 4	33.00 R51 × 4
CAPACITY: Fuel tank	ltr.(U.S. Gal)	1308 (345.6)	2120 (560)	2120 (560)

Item	Model			
		730E	830E-AC	860E-1K
Source	—	USA	USA	USA
WEIGHT:	kg (lb)			
Empty vehicle weight*		146060 (322,000)	164200 (362,000)	200351 (441,700)
Distribution (front)		73030 (161,000)	81279 (179,190)	98361 (216,850)
(rear)		73030 (161,000)	82921 (182,810)	101990 (224,850)
Gross vehicle weight		327499 (722,000)	385848 (850,640)	454363 (1,001,700)
Distribution (front)		110040 (242,592)	127330 (280,710)	152392 (335,871)
(rear)		217459 (479,408)	258518 (569,930)	301971 (665,829)
Max. gross vehicle weight**		327499 (722,000)	385848 (850,640)	454363 (1,001,700)
Gross horsepower	kW (HP)/RPM	1492 (2000)/1900	1865 (2500)/1900	2014 (2700)/1900
Net horsepower	kW (HP)/RPM	1405 (1884)/1900	1761 (2360)/1900	1902 (2550)/1900
HAULING CAPACITY:				
Nominal payload	m. ton (US ton)	181 (200)	221.6 (244)	254 (280)
Heaped capacity (2:1)	m ³ (yd ³)	148 (193)	147 (193)	169 (221)
PERFORMANCE:				
Maximum speed	km/h (MPH)	55.7 (34.6)	64.0 (40)	64.5 (40)
Turning radius	m (ft.in)	14.0 (46')	14.2 (46'5")	15.5 (50'10")
ENGINE:				
Model		KOMATSU SSDA16V159	KOMATSU SDA16V160	KOMATSU SSDA16V160
No. of cylinders-		16	16	16
bore × stroke	mm (in)	159 × 159 (6.26 × 6.26)	159 × 190 (6.26 × 7.48)	159 × 190 (6.26 × 7.48)
Displacement	ltr. (in ³)	50.3 (3069)	60.2 (3673)	60.2 (3673)
DIMENSION:		See DIMENSIONS		
TIRES:				
Front tire		37.00 R57 × 2	40.00 R57 × 2	50/80 R57 × 2
Rear tire		37.00 R57 × 4	40.00 R57 × 4	50/80 R57 × 4
CAPACITY: Fuel tank	ltr. (U.S. Gal)	3028 (800)	4542 (1200)	4542 (1200)

* Weight includes lubricants, coolant, full fuel tank and standard body.

** Max. gross vehicle weight, including optional equipment, lubricants, coolant, full fuel tank and payload, with large tires installed, shall not be exceeded.

*** Including India and Russia

*4 Weight includes lubricants, coolant, 50% fuel tank and standard body. Max. gross vehicle weight, including optional equipment, lubricants, coolant, 50% fuel tank and payload, with large tires installed, shall not be exceeded.

- Tier 3 and Stage 3A model

Specifications

RIGID DUMP TRUCKS

Item	Model	930E-4**4	930E-4SE**4	960E-2
Source	—	USA	USA	USA
WEIGHT:	kg (lb)			
Empty vehicle weight*		210187 (463,383)	215307 (474,670)	249475 (550,000)
Distribution (front)		99711 (219,826)	104459 (230,293)	123490 (272,250)
(rear)		110476 (243,557)	110847 (244,377)	125985 (272,750)
Gross vehicle weight		501974 (1,106,670)	505755 (1,115,000)	576072 (1,270,000)
Distribution (front)		165651 (365,201)	165956 (365,871)	190104 (419,100)
(rear)		336323 (741,469)	339649 (748,799)	385968 (850,900)
Max. gross vehicle weight**		501974 (1,106,670)	505755 (1,115,000)	576072 (1,270,000)
Gross horsepower	kW (HP)/RPM	2014 (2700)/1900	2611 (3500)/1900	2610 (3500)/1900
Net horsepower	kW (HP)/RPM	1902 (2550)/1900	2495 (3346)/1900	2495 (3346)/1900
HAULING CAPACITY:				
Nominal payload	m. ton (US ton)	291.8 (320)	290.4 (320)	327 (360)
Heaped capacity (2:1)	m ³ (yd ³)	211 (276)	211 (276)	214 (280)
PERFORMANCE:				
Maximum speed	km/h (MPH)	64.5 (40)	64.5 (40.0)	64.5 (40)
Turning radius	m (ft.in)	15.2 (48'9")	14.85 (48'9")	16 (52'6")
ENGINE:				
Model		KOMATSU SSDA16V160	KOMATSU SSDA18V170	KOMATSU SSDA18V170
No. of cylinders-		16	18	18
bore × stroke	mm (in)	159 × 190 (6.26 × 7.48)	170 × 190 (6.69 × 7.48)	170 × 190 (6.69 × 7.48)
Displacement	ltr. (in ³)	60.2 (3673)	70.0 (4271)	70.0 (7271)
DIMENSION:		See DIMENSIONS		
TIRES:				
Front tire		53/80 R63 × 2	53/80 R63 × 2	56/80 R63 × 2
Rear tire		53/80 R63 × 4	53/80 R63 × 4	56/80 R63 × 4
CAPACITY: Fuel tank	ltr. (U.S. Gal)	4542 (1200)	5300 (1,400)	5300 (1400)

Item	Model	960E-2K		
Source	—	USA		
WEIGHT:	kg (lb)			
Empty vehicle weight*		249475 (550,000)		
Distribution (front)		123490 (272,250)		
(rear)		125985 (272,750)		
Gross vehicle weight		576072 (1,270,000)		
Distribution (front)		190104 (419,100)		
(rear)		385968 (850,900)		
Max. gross vehicle weight**		576072 (1,270,000)		
Gross horsepower	kW (HP)/RPM	2610 (3500)/1900		
Net horsepower	kW (HP)/RPM	2495 (3346)/1900		
HAULING CAPACITY:				
Nominal payload	m. ton (US ton)	327 (360)		
Heaped capacity (2:1)	m ³ (yd ³)	214 (280)		
PERFORMANCE:				
Maximum speed	km/h (MPH)	64.5 (40)		
Turning radius	m (ft.in)	16 (52'6")		
ENGINE:				
Model		KOMATSU SSDA18V170		
No. of cylinders-		18		
bore × stroke	mm (in)	170 × 190 (6.69 × 7.48)		
Displacement	ltr. (in ³)	70.0 (7271)		
DIMENSION:				
TIRES:				
Front tire		56/80 R63 × 2		
Rear tire		56/80 R63 × 4		
CAPACITY: Fuel tank	ltr. (U.S. Gal)	5300 (1400)		

* Weight includes lubricants, coolant, full fuel tank and standard body.

** Max. gross vehicle weight, including optional equipment, lubricants, coolant, full fuel tank and payload, with large tires installed, shall not be exceeded .

*** Including India and Russia

**4 Weight includes lubricants, coolant, 50% fuel tank and standard body. Max. gross vehicle weight, including optional equipment, lubricants, coolant, 50% fuel tank and payload, with large tires installed, shall not be exceeded.

Dimensions

RIGID DUMP TRUCKS

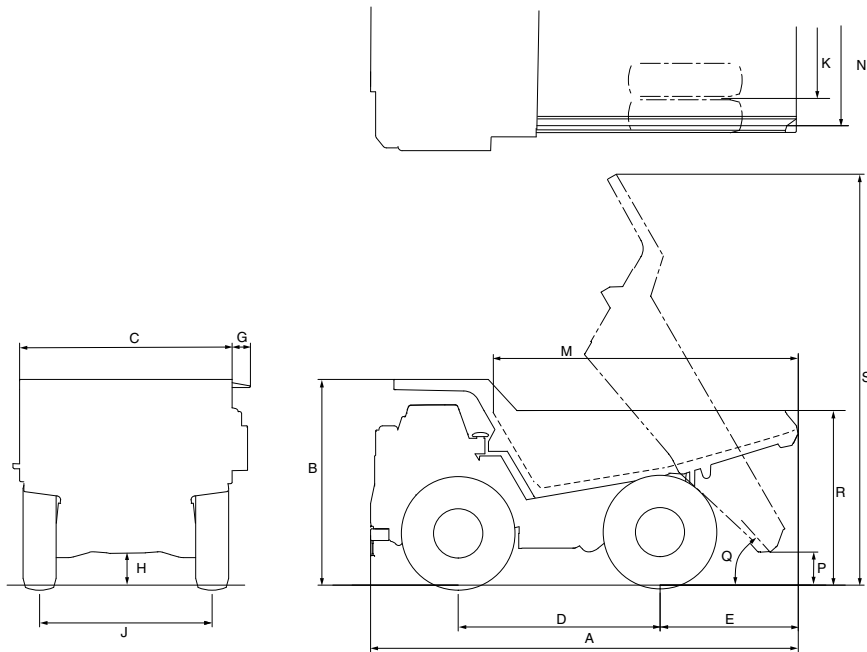

Unit: mm (ft.in)

	HD255-5	HD325-7 HD325-7R	HD325-6	HD405-7 HD405-7R	HD405-6	HD465-7E0 HD465-7R
Tires	16.00 R25	18.00-33-32PR	18.00-33-28PR	18.00 R33	18.00 R33	24.00-35-36PR
A	7390 (24'3")	8465 (27'9")	8365 (27'5")	8465 (27'9")	8365 (27'5")	9355 (30'8")
B*	3590 (11'9")	4150 (13'7")	4150 (13'7")	4150 (13'7")	4150 (13'7")	4400 (14'5")
C	3200 (10'6")	3660 (12'0")	3660 (12'0")	3660 (12'0")	3660 (12'0")	4170 (13'8")
D	3600 (11'10")	3750 (12'4")	3750 (12'4")	3750 (12'4")	3750 (12'4")	4300 (14'1")
E	2140 (7')	2730 (8'11")	2630 (8'8")	2730 (8'11")	2630 (8'8")	3070 (10'1")
G	495 (1'7")	—	480 (1'7")	—	480 (1'7")	—
H	410 (1'4")	500 (1'8")	500 (1'8")	500 (1'8")	500 (1'8")	604 (2'0")
J	2700 (8'10")	3150 (10'4")	3150 (10'4")	3150 (10'4")	3150 (10'4")	3515 (11'6")
K	2225 (7'4")	2550 (8'4")	2550 (8'4")	2550 (8'4")	2550 (8'4")	3080 (10'1")
M	4570 (15')	5500 (18'1")	5500 (18'1")	5590 (18'4")	5590 (18'4")	6450 (21'2")
N	2995 (9'10")	3380 (11'1")	3380 (11'1")	3380 (11'1")	3380 (11'1")	3870 (12'8")
P	560 (1'10")	480 (1'7")	530 (1'9")	480 (1'7")	530 (1'9")	560 (1'6")
Q	49°	48°	48°	48°	48°	48°
R	2975 (9'9")	3220 (10'7")	3200 (10'6")	3450 (11'4")	3430 (11'3")	3600 (11'10")
S	7110 (23'4")	8000 (26'3")	7885 (25'10")	8000 (26'3")	7885 (25'10")	8800 (28'10")

* Includes canopy spill guard.

** USA source

Dimensions

RIGID DUMP TRUCKS

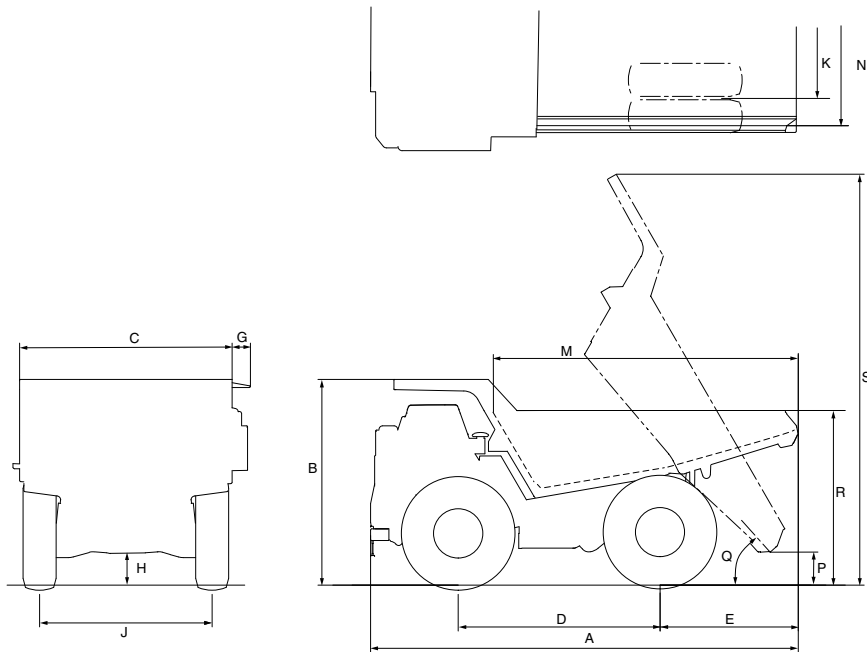

Unit: mm (ft.in)

	HD465-7	HD605-7E0 HD605-7R	HD785-7	HD1500-7	HD1500-7**	730E
Tires	24.00-35-36PR	24.00 R35	27.00 R49	33.00 R51	33.00 R51	37.00 R57
A	9355 (30'8")	9355 (30'8")	10290 (33'9")	11370 (37'4")	11546 (37'11")	13700 (45'0")
B*	4400 (14'5")	4400 (14'5")	5050 (16'7")	5850 (19'2")	5850 (19'2")	6810 (22'4")
C	4170 (13'8")	4170 (13'8")	5530 (18'2")	6090 (20'0")	6090 (20'0")	7140 (23'5")
D	4300 (14'1")	4300 (14'1")	4950 (16'3")	5400 (17'9")	5400 (17'9")	5840 (19'2")
E	3070 (10'1")	3070 (10'1")	3190 (10'6")	3495 (11'6")	3495 (11'6")	3850 (12'6")
G	480 (1'7")	—	450 (1'6")	530 (1'9")	530 (1'9")	—
H	645 (2'1")	604 (2'0")	775 (2'7")	880 (2'11")	880 (2'11")	—
J	3515 (11'6")	3515 (11'6")	4325 (14'2")	5010 (16'5")	5010 (16'5")	5700 (18'8")
K	3080 (10'1")	3080 (10'1")	3500 (11'6")	4020 (13'2")	4020 (13'2")	4580 (15'0")
M	6450 (21'2")	6600 (21'8")	7065 (23'2")	7625 (25'0")	7625 (25'0")	8380 (27'6")
N	3870 (12'8")	3870 (12'8")	5200 (17'1")	5705 (18'9")	5705 (18'9")	6870 (22'7")
P	560 (1'10")	560 (1'6")	985 (3'3")	1650 (5'5")	1650 (5'5")	1940 (6'4")
Q	48°	48°	48°	45°	45°	40.85°
R	3600 (11'10")	3860 (12'8")	4285 (14'1")	4965 (16'3")	4965 (16'3")	6030 (19'8")
S	8800 (28'10")	8800 (28'10")	10080 (33'1")	11440 (37'6")	11440 (37'6")	13100 (42'11")

* Includes canopy spill guard.

** USA source

Dimensions

RIGID DUMP TRUCKS

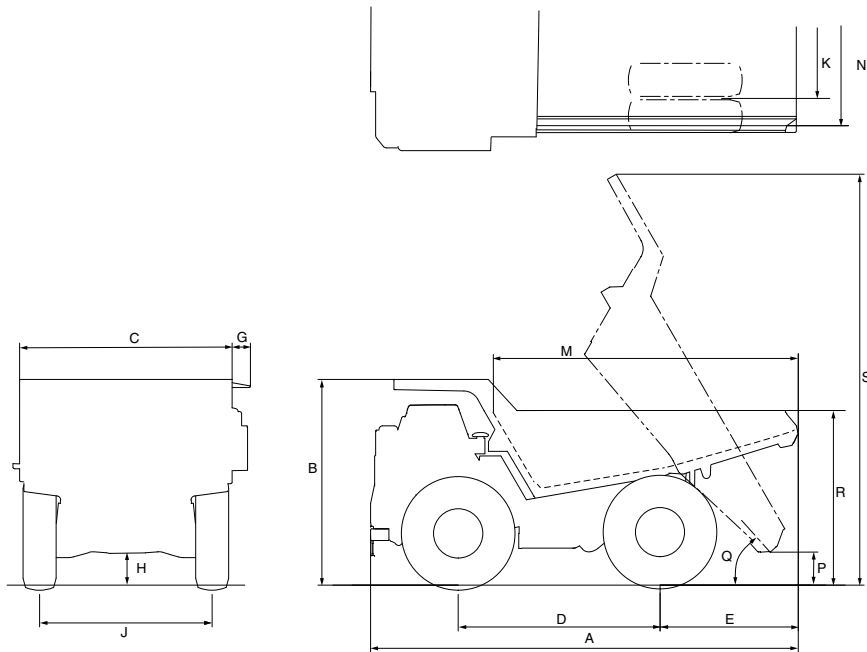

Unit: mm (ft.in)

	830E-AC	860E-1K	930E-4	930E-4SE	960E-2	960E-2K
Tires	40.00 R57	50/80 R57	53/80 R63	53/80 R63	56/80 R63	56/80 R63
A	14400 (47'3")	14930 (49'0")	15600 (51'2")	15600 (51'2")	15600 (51'2")	15340 (50'4")
B*	6880 (22'7")	7300 (23'11")	7370 (24'2")	7370 (24'2")	7370 (24'2")	7670 (25'2")
C	7260 (23'10")	8330 (27'4")	8690 (28'6")	8690 (28'6")	9190 (30'2")	9190 (30'2")
D	6350 (20'10")	6300 (20'8")	6350 (20'10")	6350 (20'10")	6650 (21'10")	6630 (21'9")
E	3990 (13'1")	4160 (13'8")	4780 (15'8")	4800 (15'9")	4470 (14'8")	4240 (13'11")
G	60 (2.4")	—	—	—	—	—
H	1280 (4'2")	850 (2'9")	940 (3'1")	940 (3'1")	1020 (3'4")	1020 (3'4")
J	5770 (18'11")	6090 (20'0")	6150 (20'2")	6150 (20'2")	6300 (20'8")	6290 (20'8")
K	4880 (16'0")	5150 (16'11")	5360 (17'7")	5360 (17'7")	5640 (18'6")	5640 (18'6")
M	8870 (29'1")	9210 (30'3")	9450 (31'0")	9380 (30'9")	9500 (31'2")	9290 (30'6")
N	6860 (22'6")	7650 (25'1")	8150 (26'9")	8150 (26'9")	8660 (28'5")	7260 (23'10")
P	1840 (6'0")	1930 (6'4")	1550 (5'1")	1550 (5'1")	1700 (5'7")	2080 (6'8")
Q	45°	45°	45°	45°	45°	45°
R	6710 (22'0")	6390 (20'11")	7060 (23'2")	7060 (23'2")	7140 (23'5")	7390 (24'3")
S	13410 (44'0")	14040 (46'1")	14020 (46'0")	14020 (46'0")	14100 (46'3")	15510 (51'1")

* Includes canopy spill guard.

How to use the travel performance curve

For assessing a vehicle's grade-ability, travel speed, rim pull, etc. First, draw a vertical line according to the vehicle's weight (A) and mark the point (B) corresponding to total resistance (the sum of rolling resistance and grade resistance). Next, draw a horizontal line from (B), then mark (C) where the line intersects the rim pull curve and read (E) for the rim pull. For travel speed (D), draw a vertical line downward from (C).

For instance, when traveling an 8% gradient and encountering a 5% rolling resistance, a vehicle with a 32 ton (35-U.S. ton) payload should have a rim pull of 8 tons (17,640 lb) and travel at a speed of 15 km/h (9.3 MPH) in forward 2nd gear.

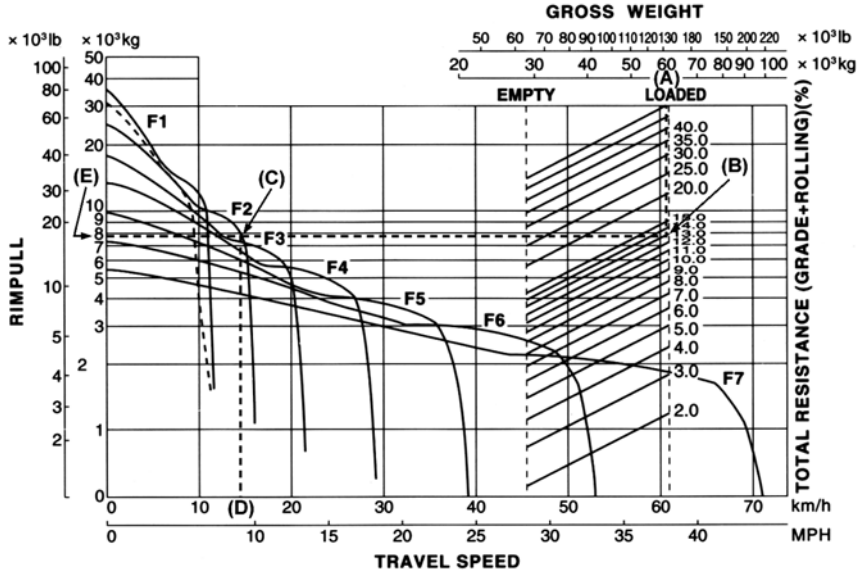

How to use the brake performance curve

These curves are provided for establishing the maximum speed and gearshift position for safe descent of a road with a given gradient at a given distance.

For example, let us assume the total resistance is -15% (gradient resistance -16% plus rolling resistance +1%) on the 1500m (4,920 ft) graph.

First, draw a vertical line from the total vehicle weight (A) so that it crosses the slanted line of -15% total resistance (B). From (B), draw a horizontal line to the left and it will cross the stair curve at (C). Finally, draw a vertical line from (C) and read (D) the maximum speed for driving safely down the slope.

In this case, a vehicle with a 32-ton payload should travel at approximately 22km/h (13.7MPH) with the F3 gear.

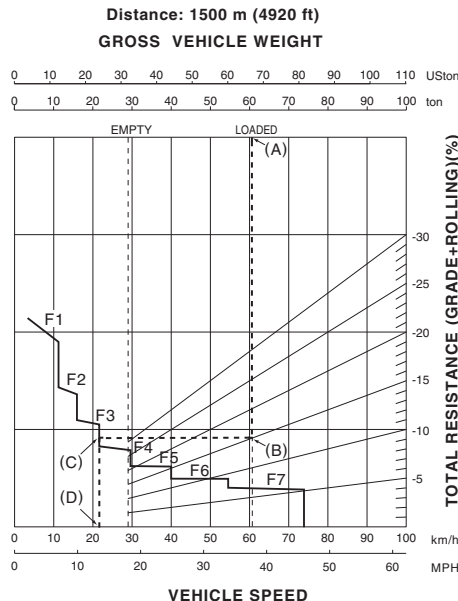

FVBH0068A

Travel Performance Curve

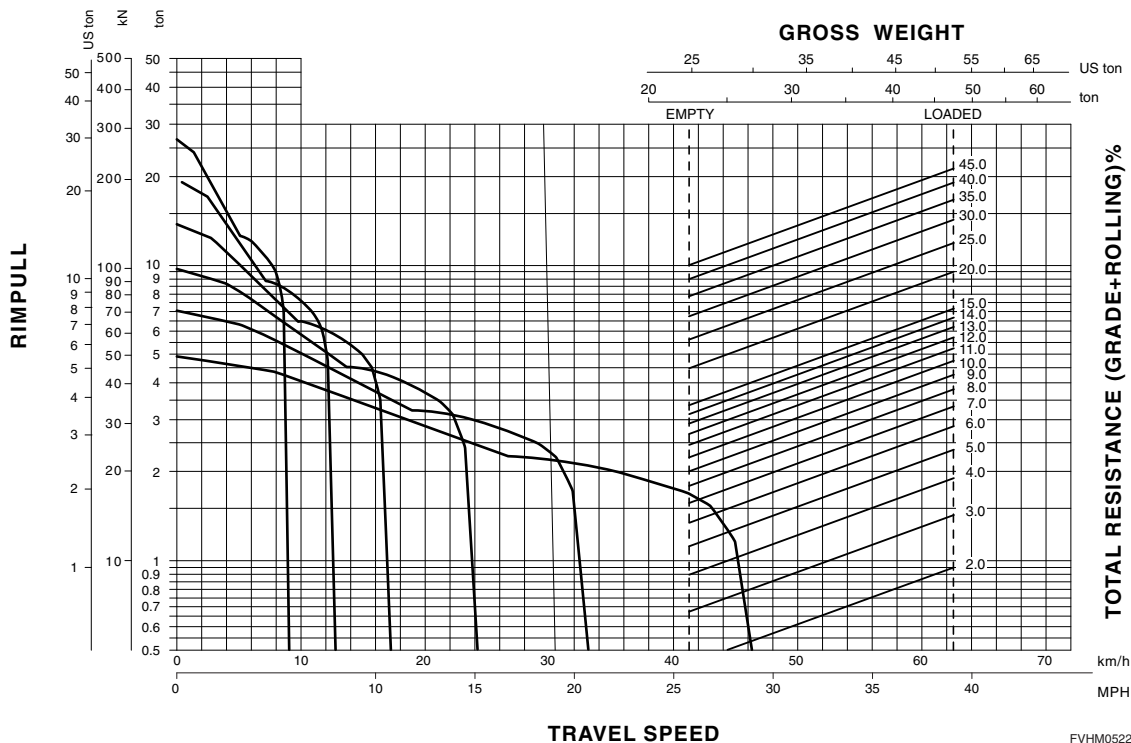

FVHM0522

Brake performance

GRADE DISTANCE: Continuous

GRADE DISTANCE: 450 m (1,500 ft)

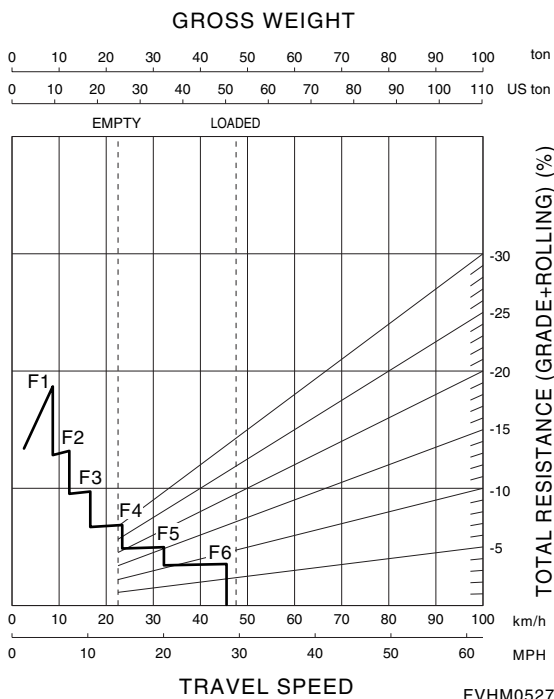

FVHM0527

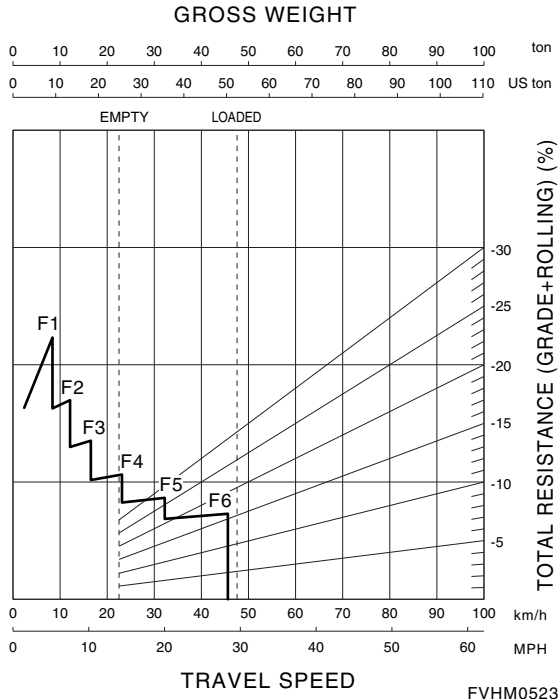

FVHM0523

Brake performance

GRADE DISTANCE: 600 m (2,000 ft)

GRADE DISTANCE: 900 m (3,000 ft)

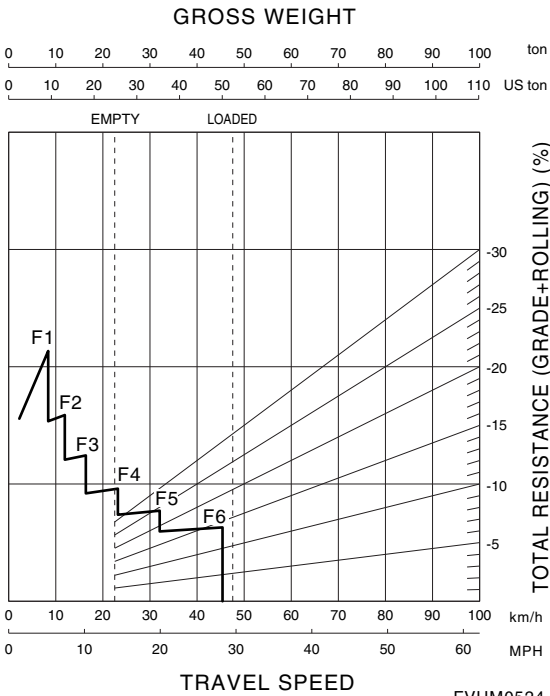

FVHM0524

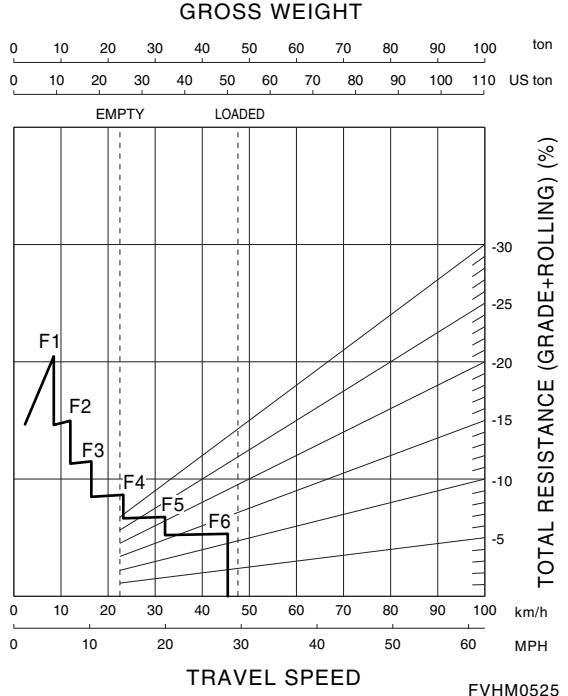

FVHM0525

GRADE DISTANCE: 1500 m (5,000 ft)

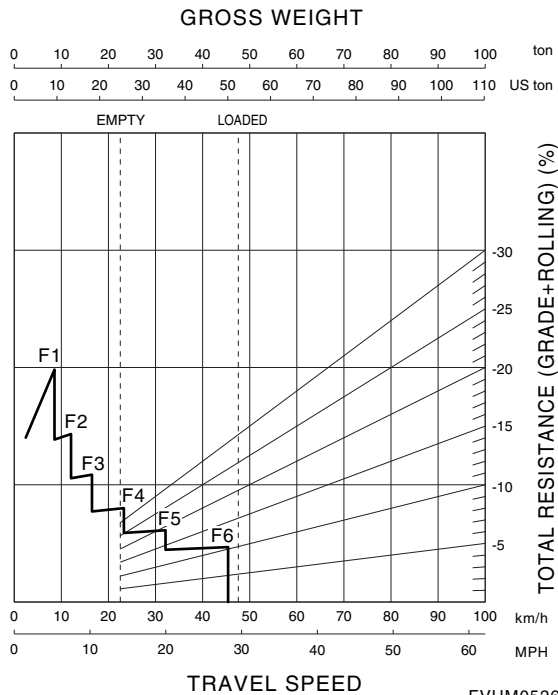

FVHM0526

Travel Performance Curve

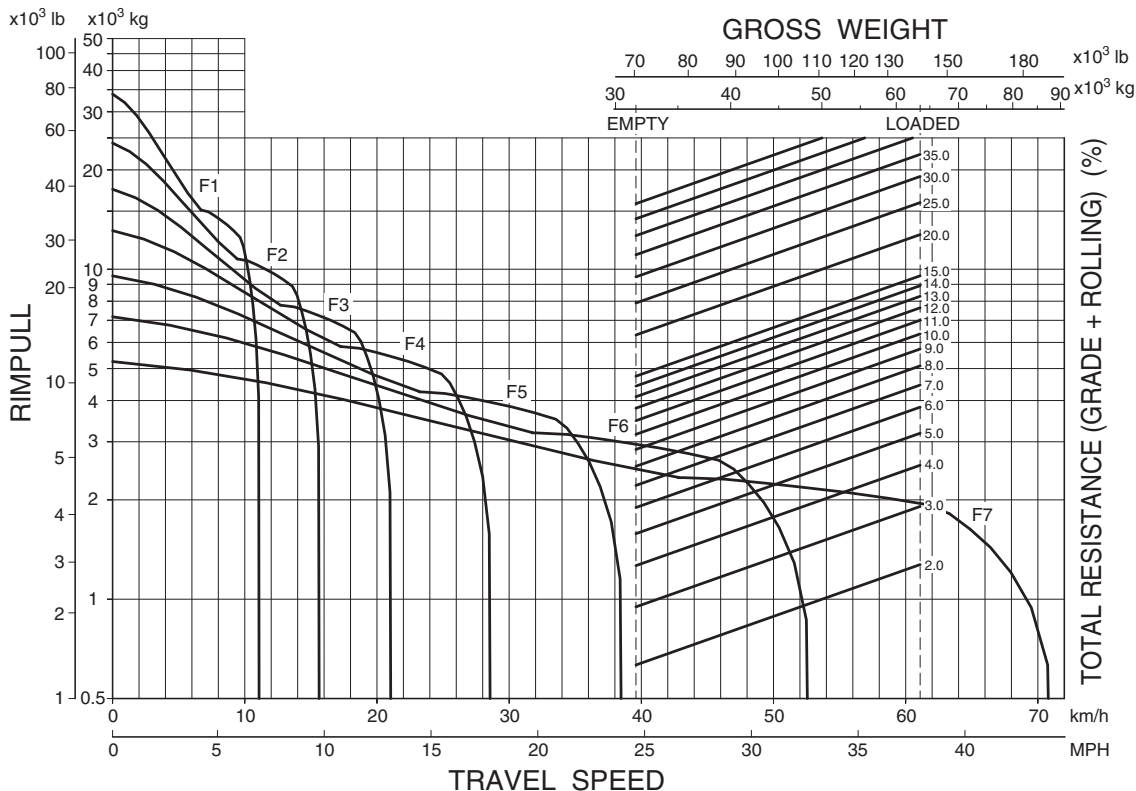

Brake performance

GRADE DISTANCE : CONTINUOUS DESCENT

GRADE DISTANCE : 450 m (1,500 ft)

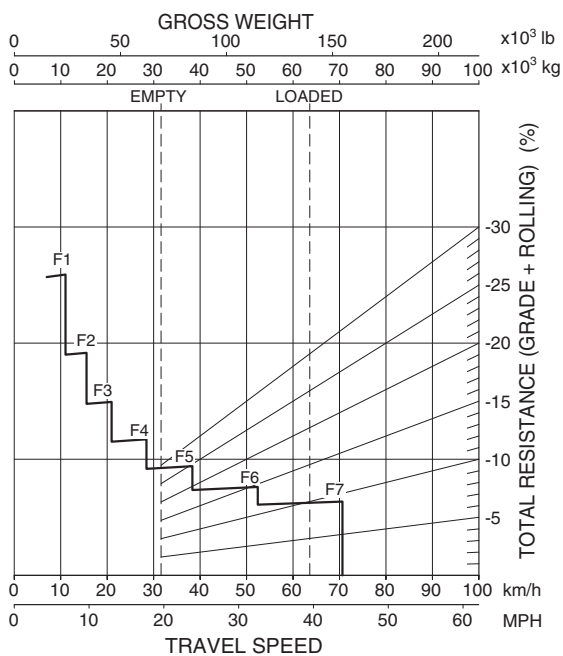
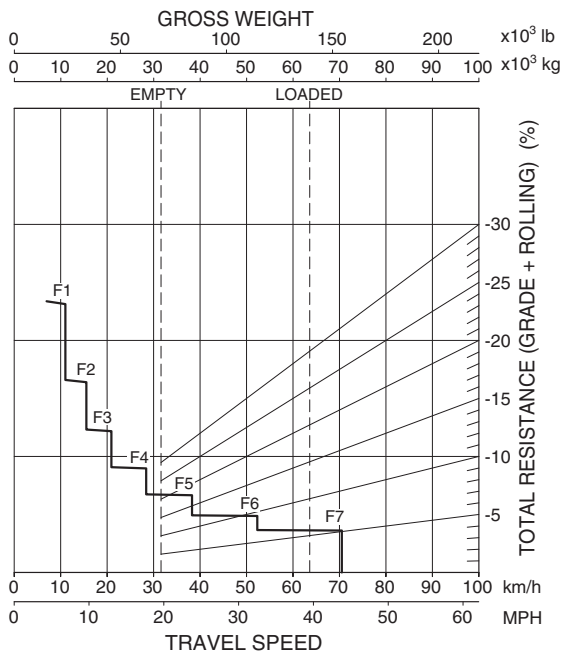

Brake performance

GRADE DISTANCE : 600 m (2,000 ft)

GRADE DISTANCE : 900 m (3,000 ft)

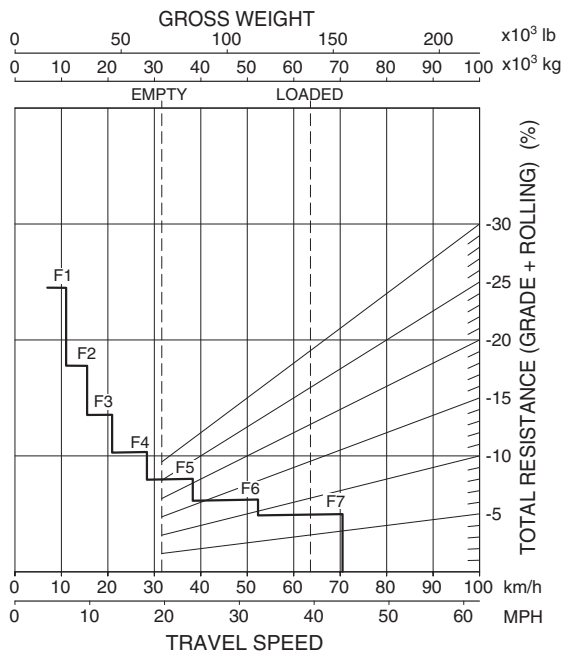
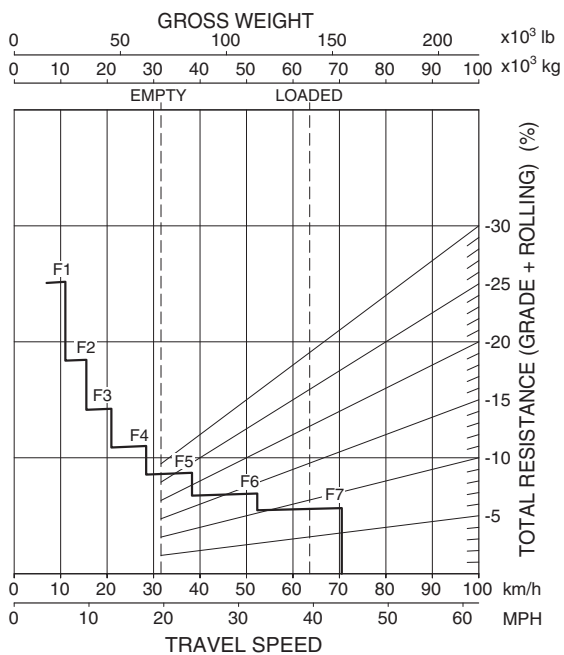

GRADE DISTANCE : 1500 m (5,000 ft)

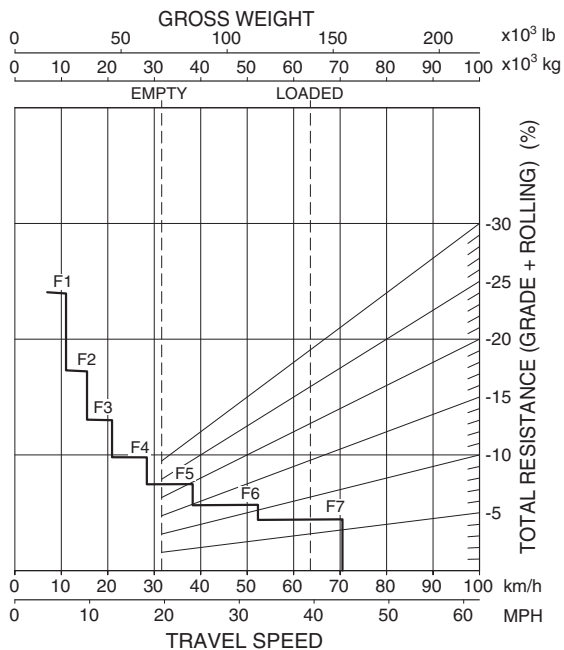

Travel Performance Curve

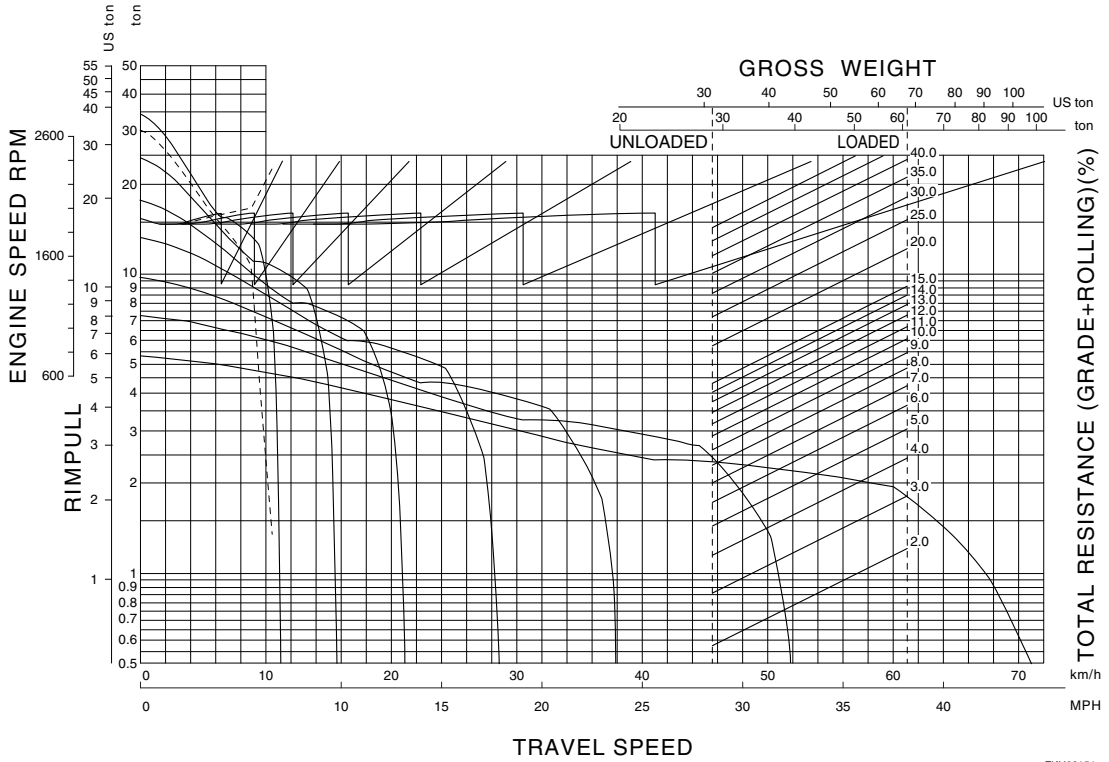

FKH00151

Brake performance

Distance: Continuous
GROSS VEHICLE WEIGHT

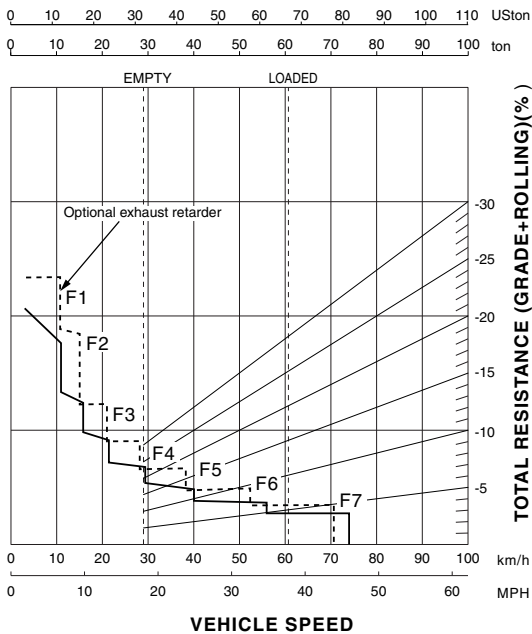

FVBH0064

Distance: 450 m (1500 ft)
GROSS VEHICLE WEIGHT

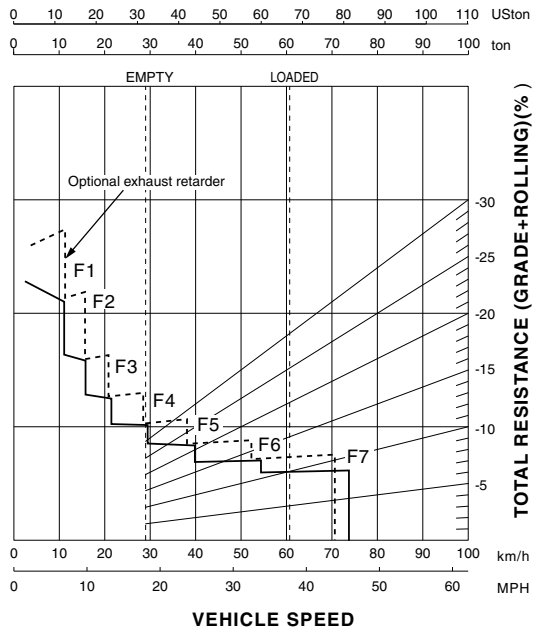

FVBH0065

Brake performance

Distance: 600 m (2000 ft)

GROSS VEHICLE WEIGHT

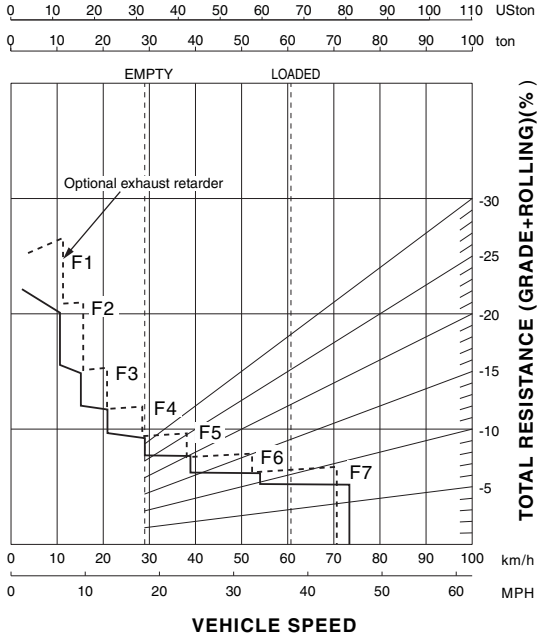

FVBH0066

Distance: 900 m (3000 ft)

GROSS VEHICLE WEIGHT

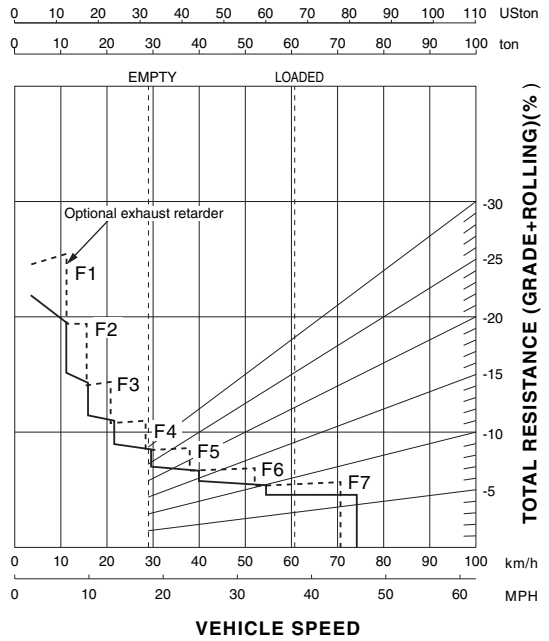

FVBH0067

Distance: 1500 m (5000 ft)

GROSS VEHICLE WEIGHT

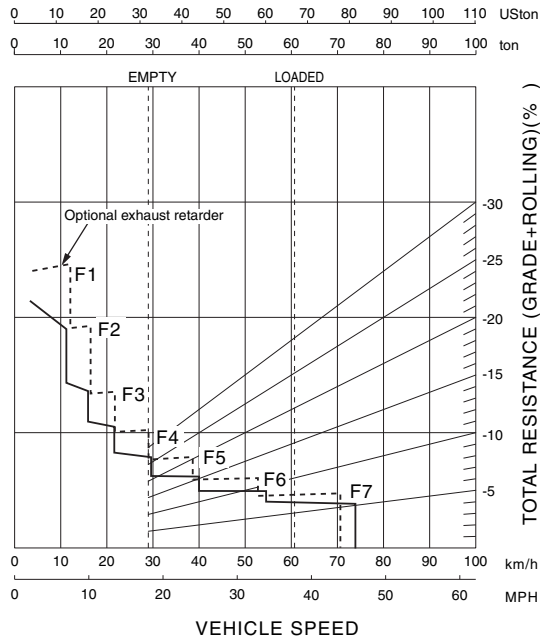

FVBH0068

Travel Performance Curve

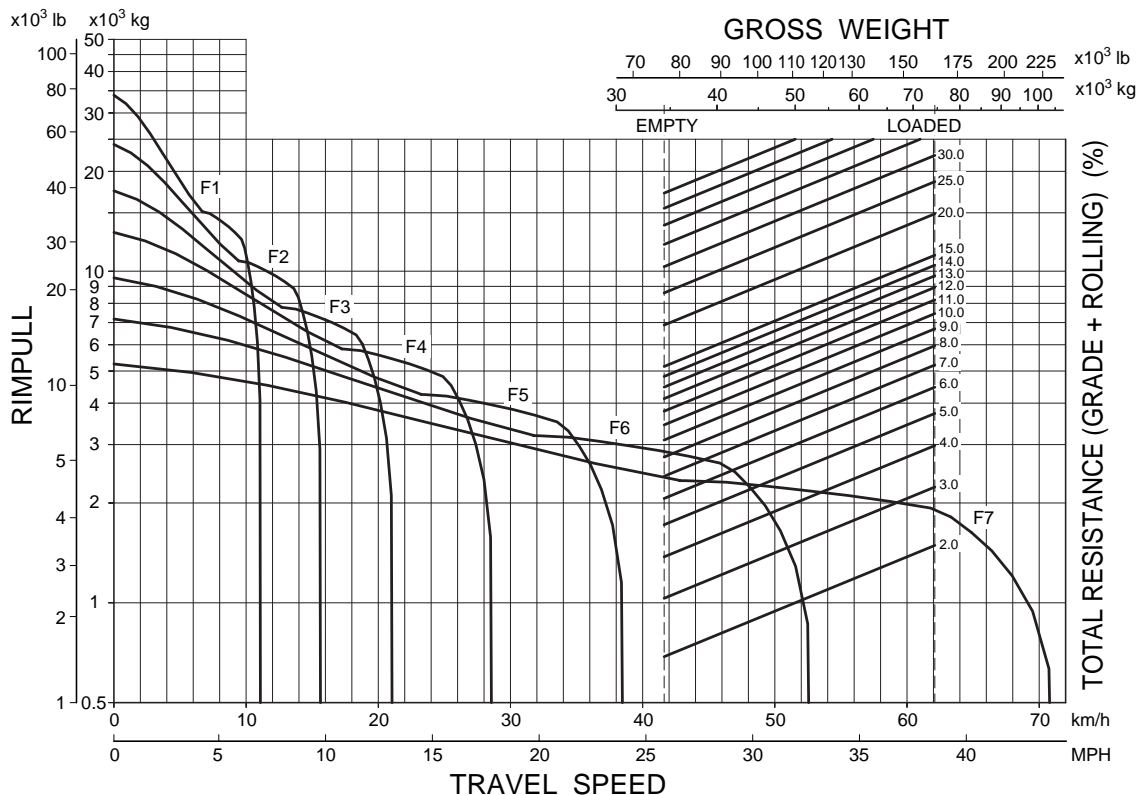

Brake performance

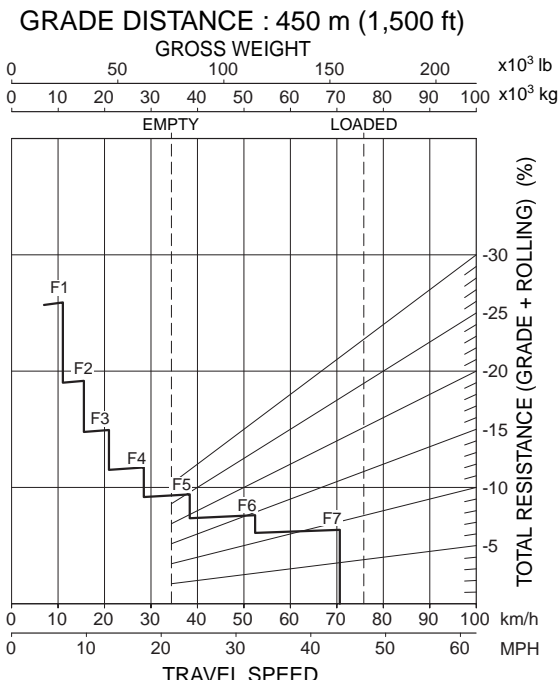
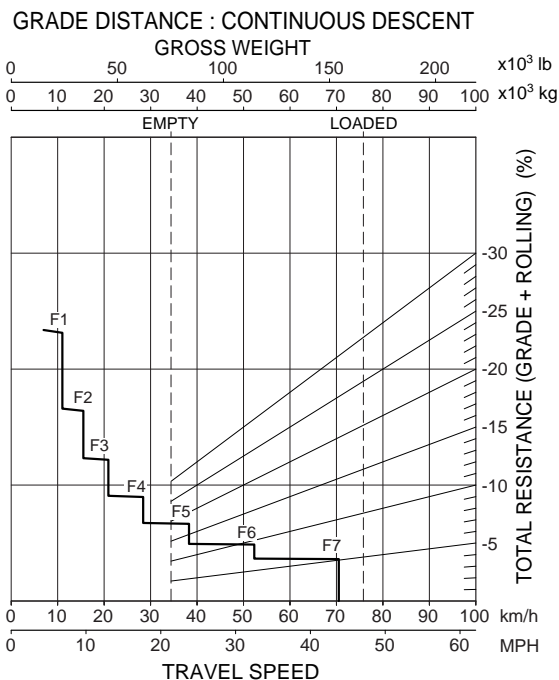

Brake performance

GRADE DISTANCE : 600 m (2,000 ft)

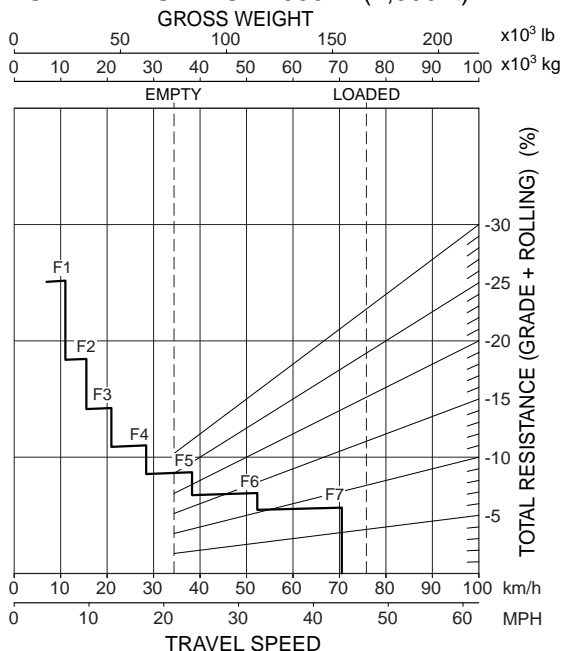

GRADE DISTANCE : 900 m (3,000 ft)

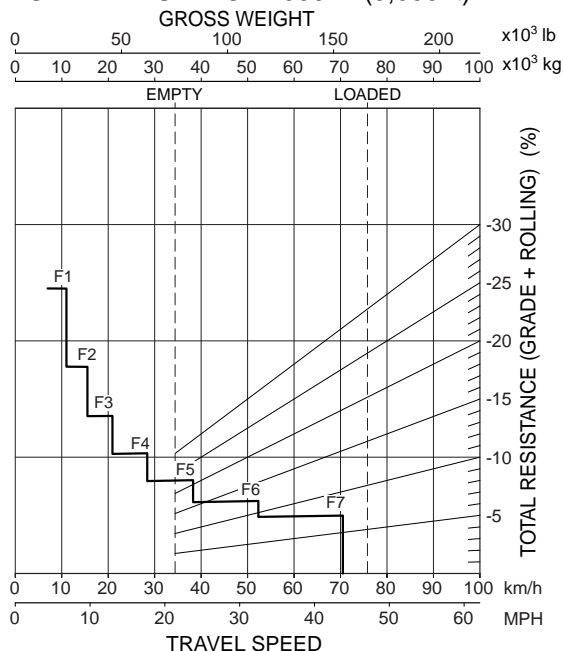

GRADE DISTANCE : 1500 m (5,000 ft)

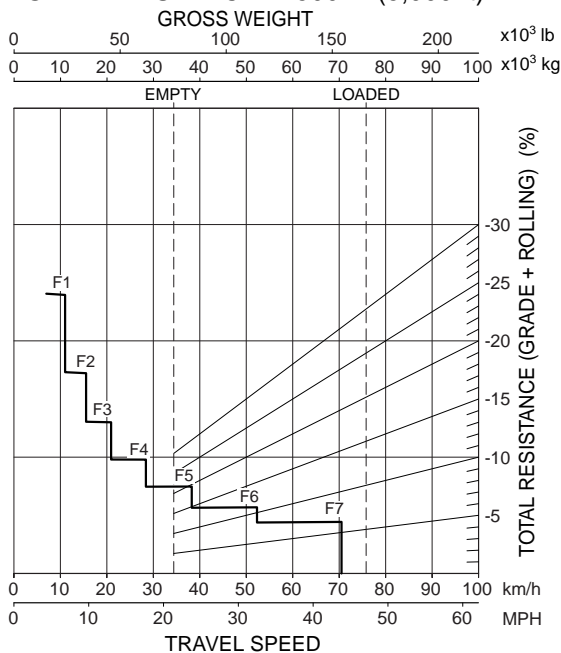

Travel Performance Curve

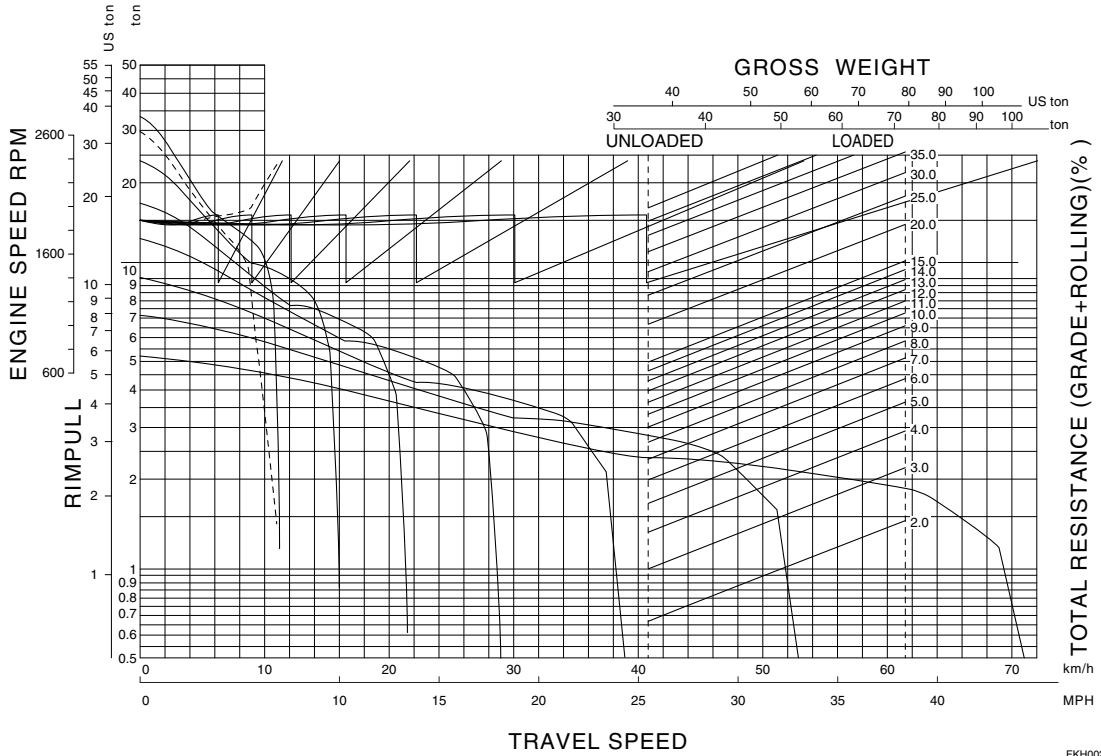

FKH00220

Brake performance

Distance: Continuous Descent
GROSS VEHICLE WEIGHT

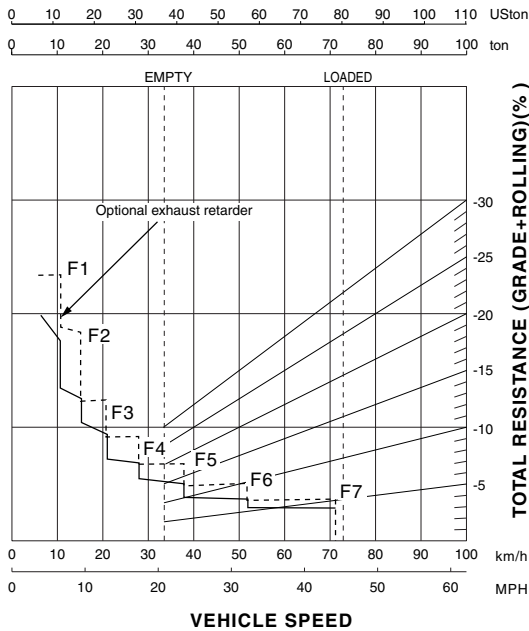

FVBH0069

Distance: 450 m (1500 ft)
GROSS VEHICLE WEIGHT

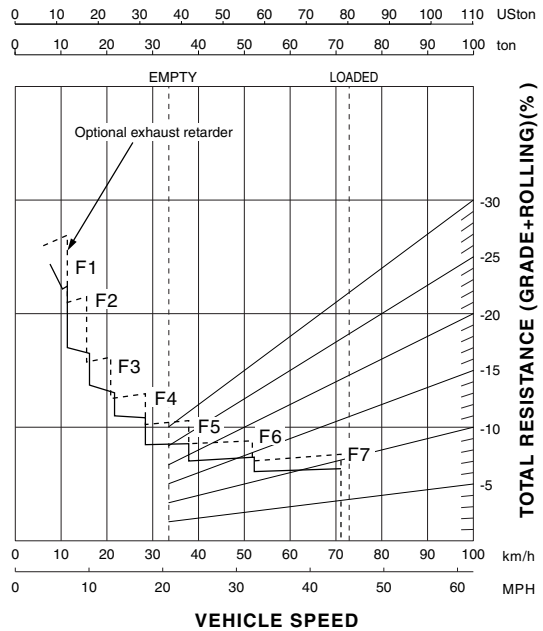

FVBH00070

Brake performance

Distance: 600 m (2000 ft)

GROSS VEHICLE WEIGHT

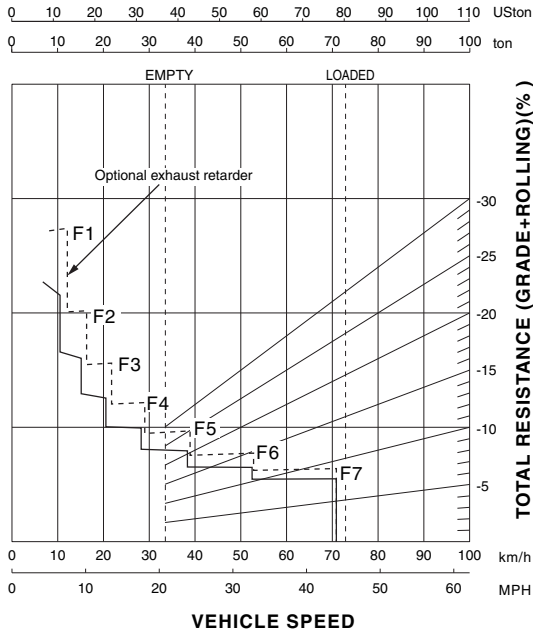

FVBH0071

Distance: 900 m (3000 ft)

GROSS VEHICLE WEIGHT

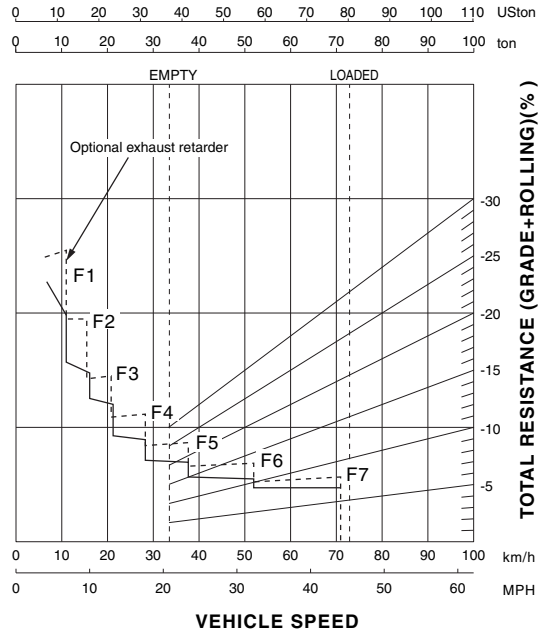

FVBH0072

Distance: 1500 m (5000 ft)

GROSS VEHICLE WEIGHT

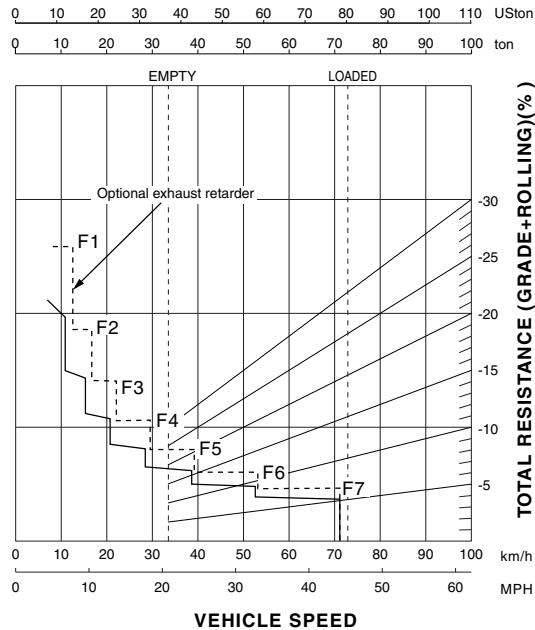

FVBH0073

Travel Performance Curve

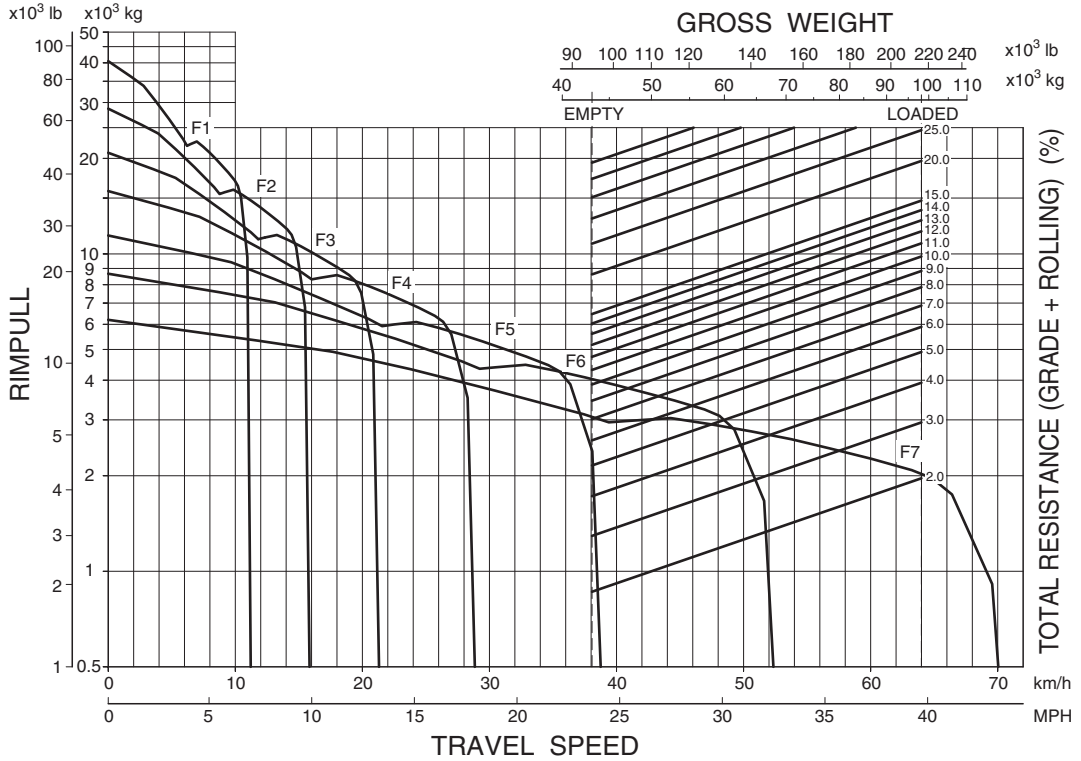

Brake performance

GRADE DISTANCE : CONTINUOUS DESCENT

GRADE DISTANCE : 450 m (1,500 ft)

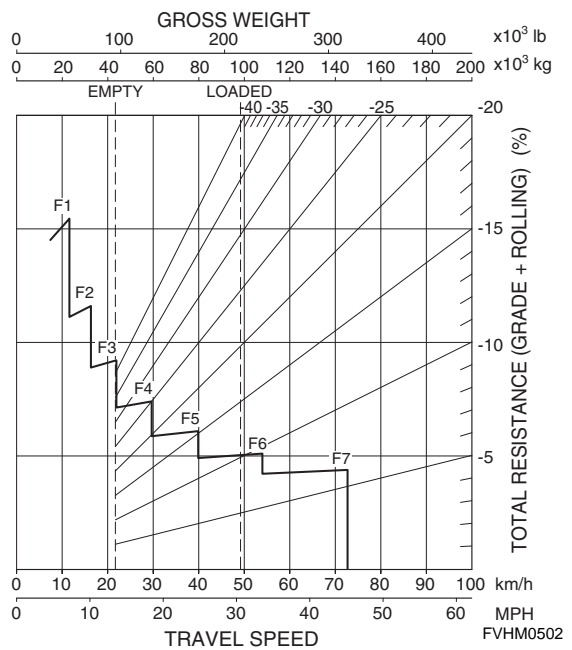
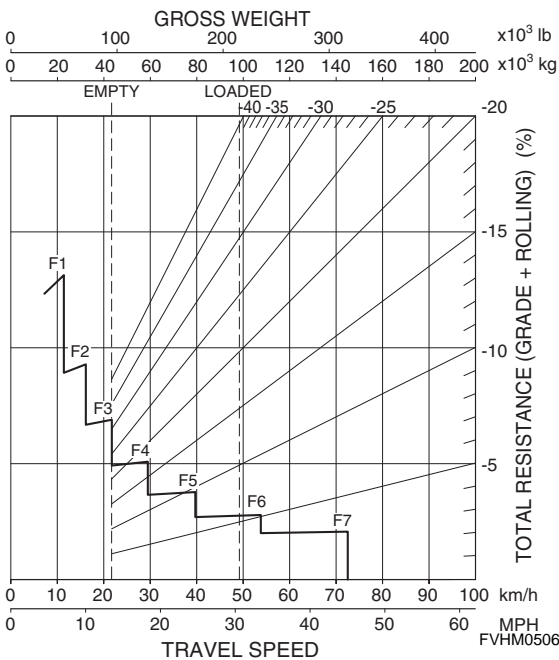

Brake performance

GRADE DISTANCE : 600 m (2,000 ft)

GRADE DISTANCE : 900 m (3,000 ft)

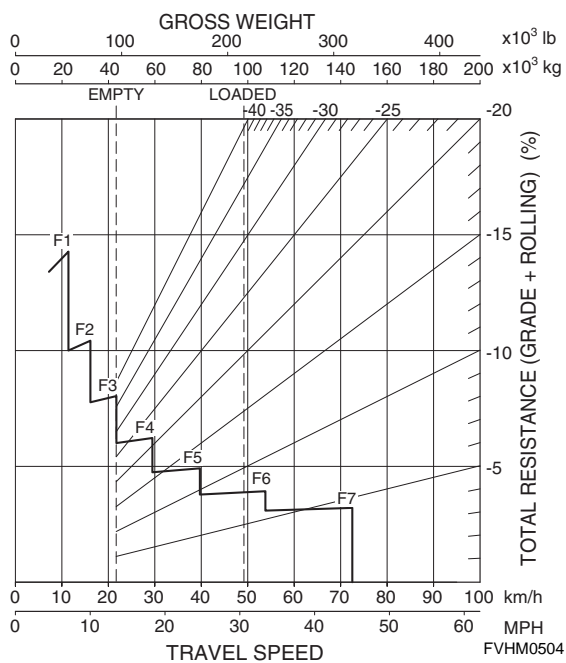
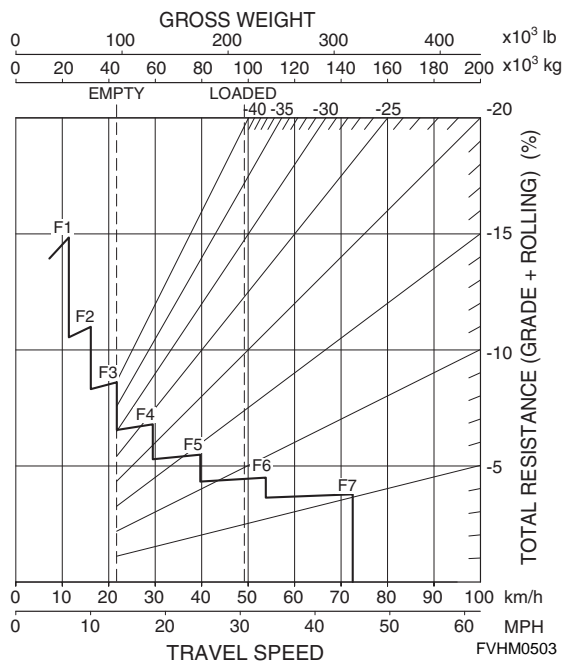

GRADE DISTANCE : 1500 m (5,000 ft)

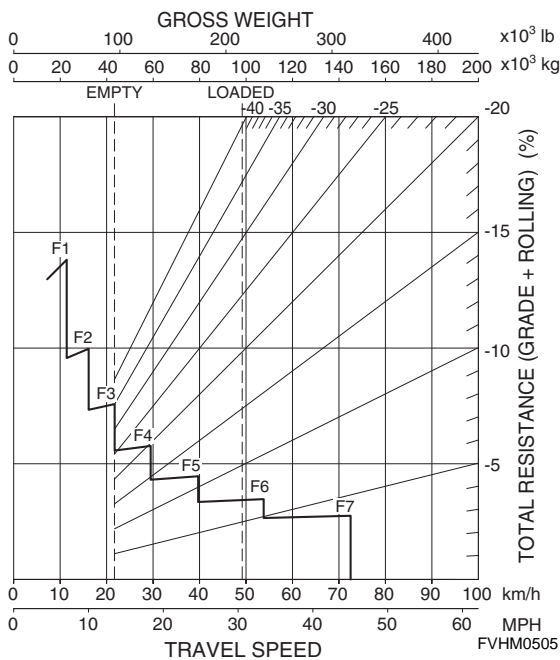

Travel Performance Curve

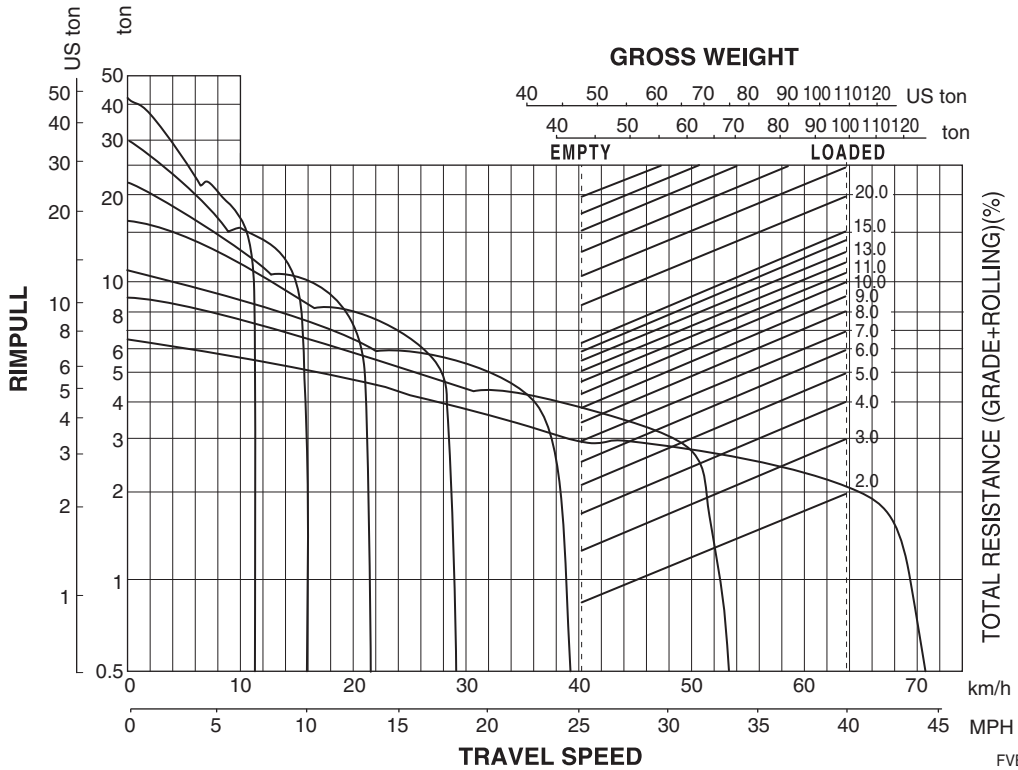

FVBH0150

Brake performance

GRADE DISTANCE: Continuous

GRADE DISTANCE: 450 m (1,500 ft)

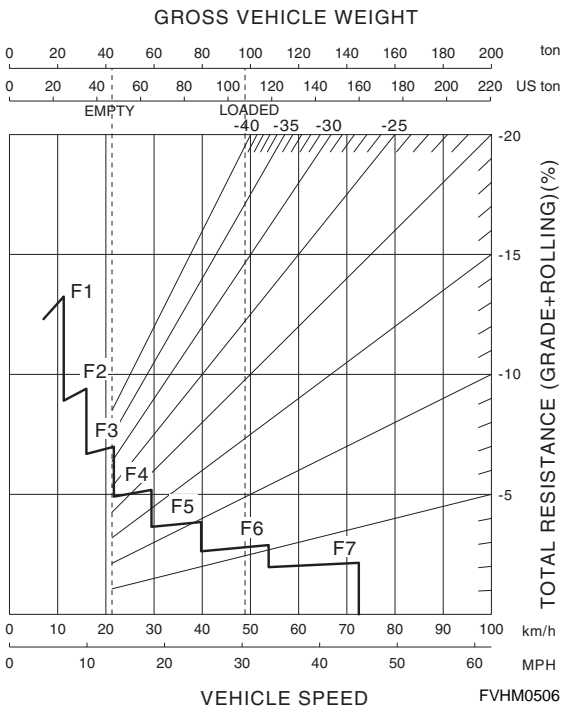

FVHM0506

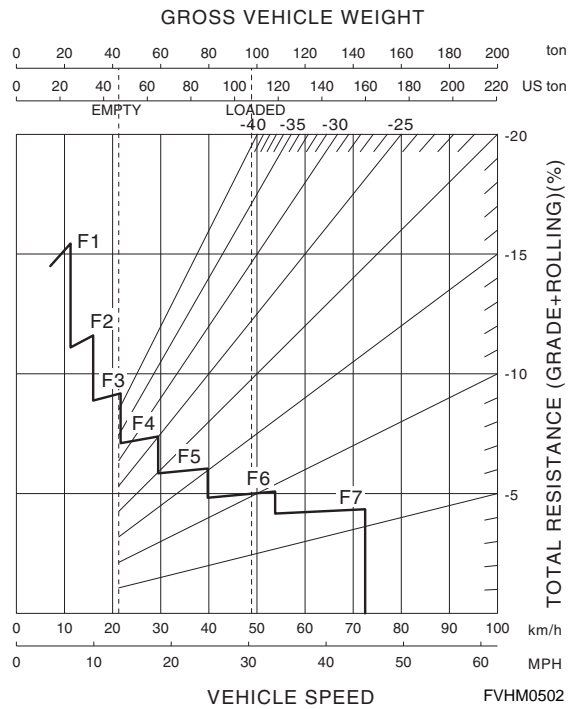

FVHM0502

Brake performance

Grade distance: 600 m (2,000 ft)

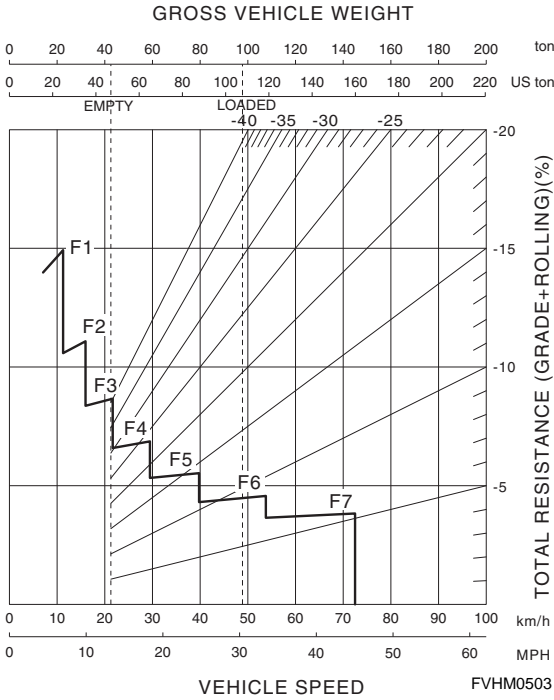

Grade distance: 900 m (3,000 ft)

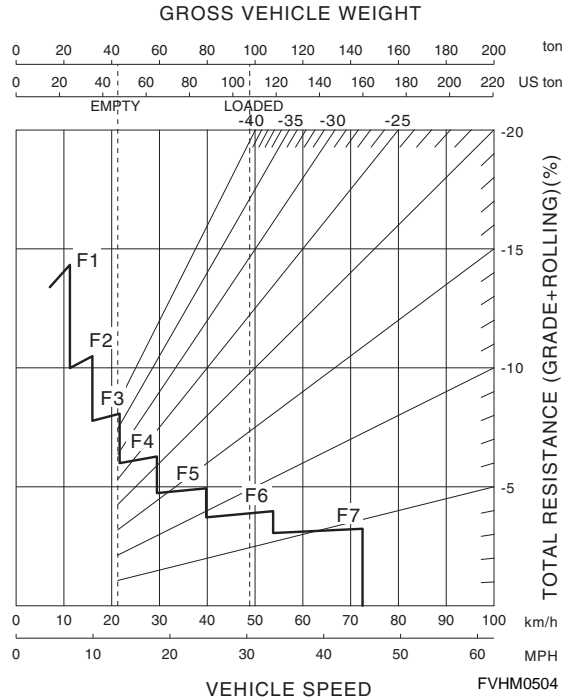

Grade distance: 1500 m (5,000 ft)

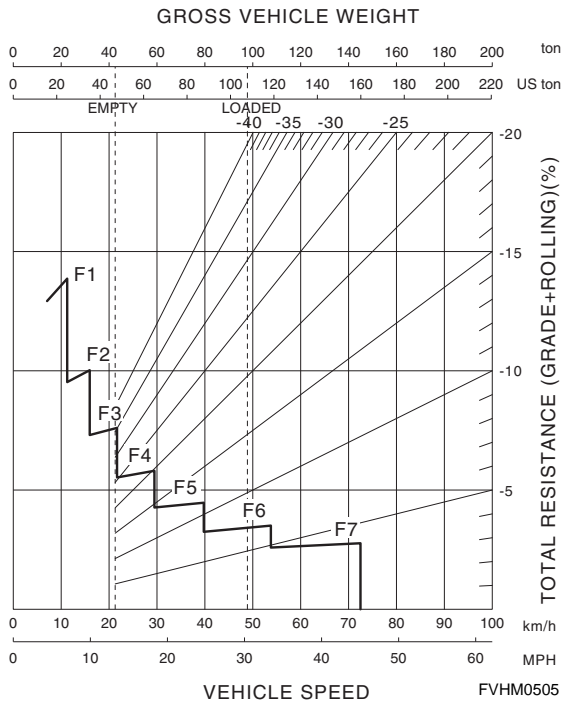

Travel Performance Curve

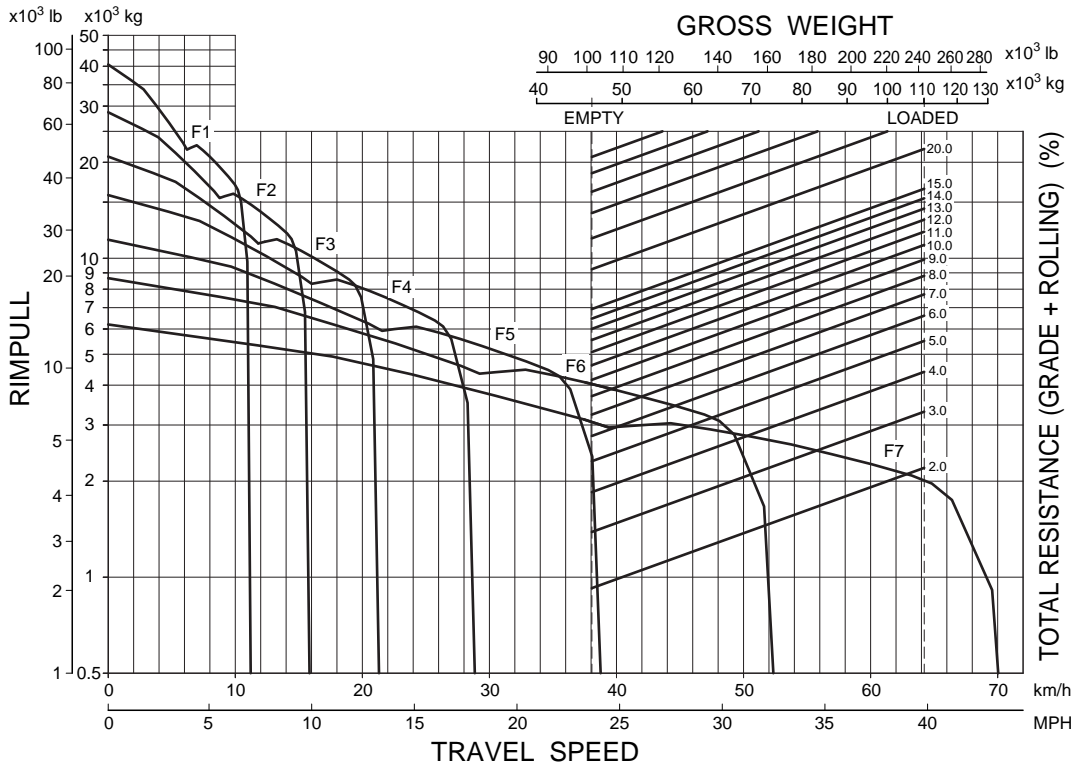

Brake performance

GRADE DISTANCE : CONTINUOUS DESCENT

GRADE DISTANCE : 450 m (1,500 ft)

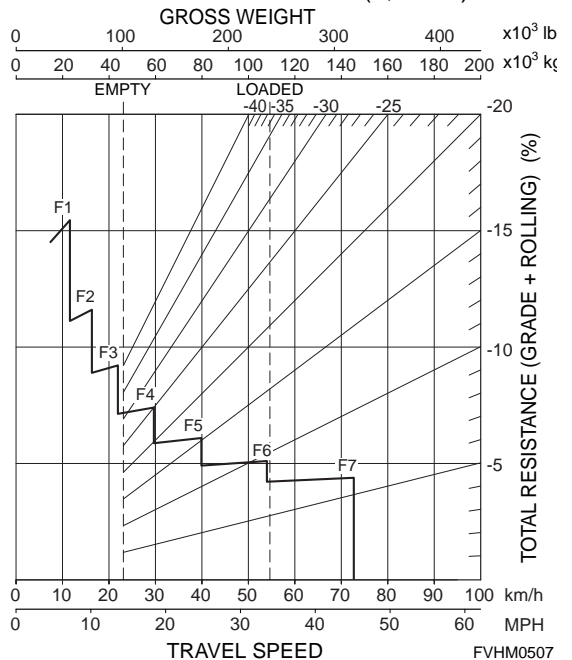
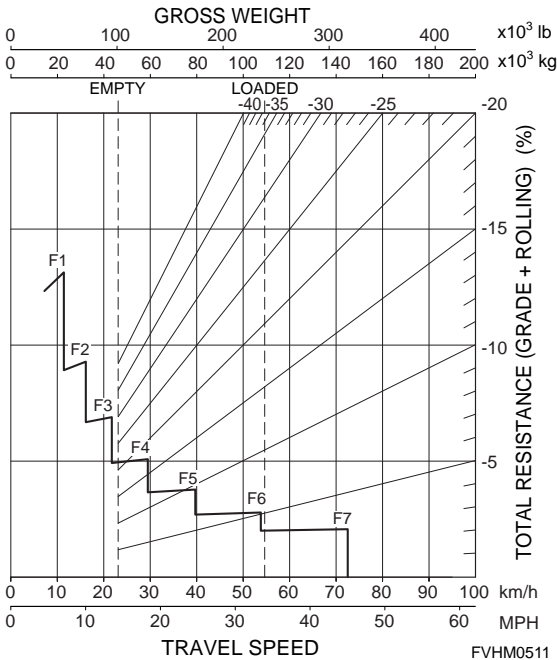

Brake performance

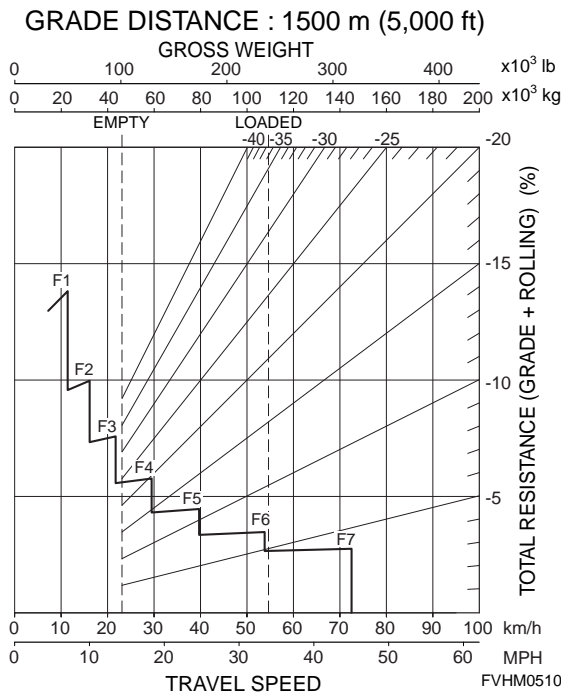
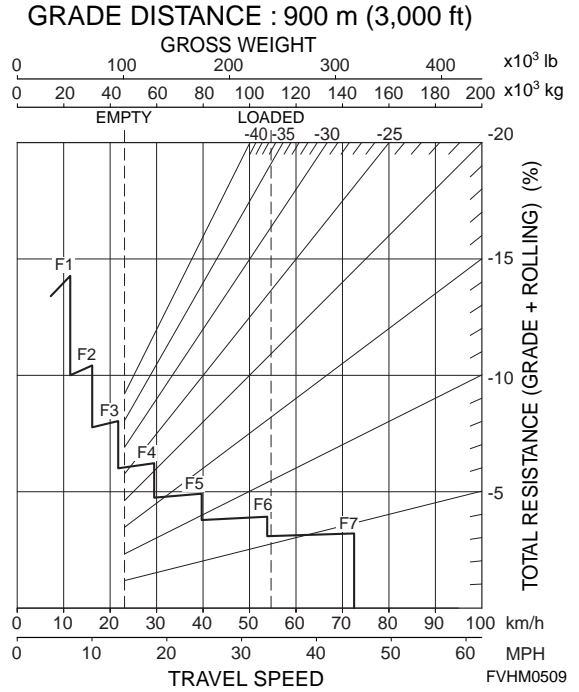
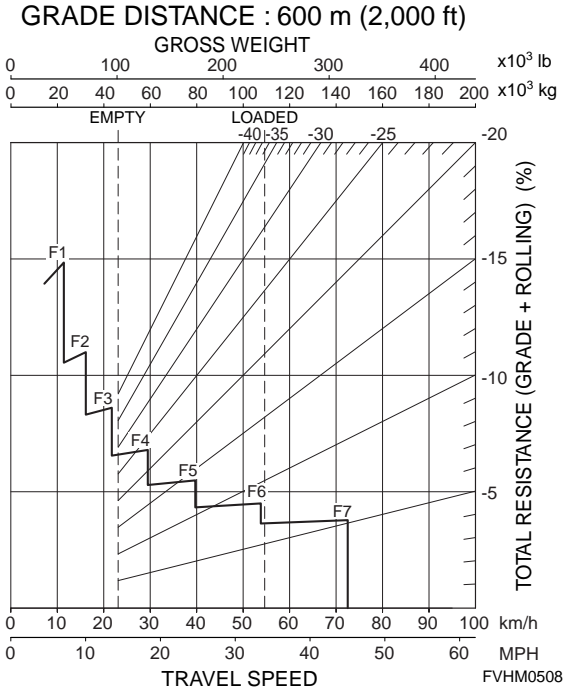

Travel Performance Curve
Power-mode

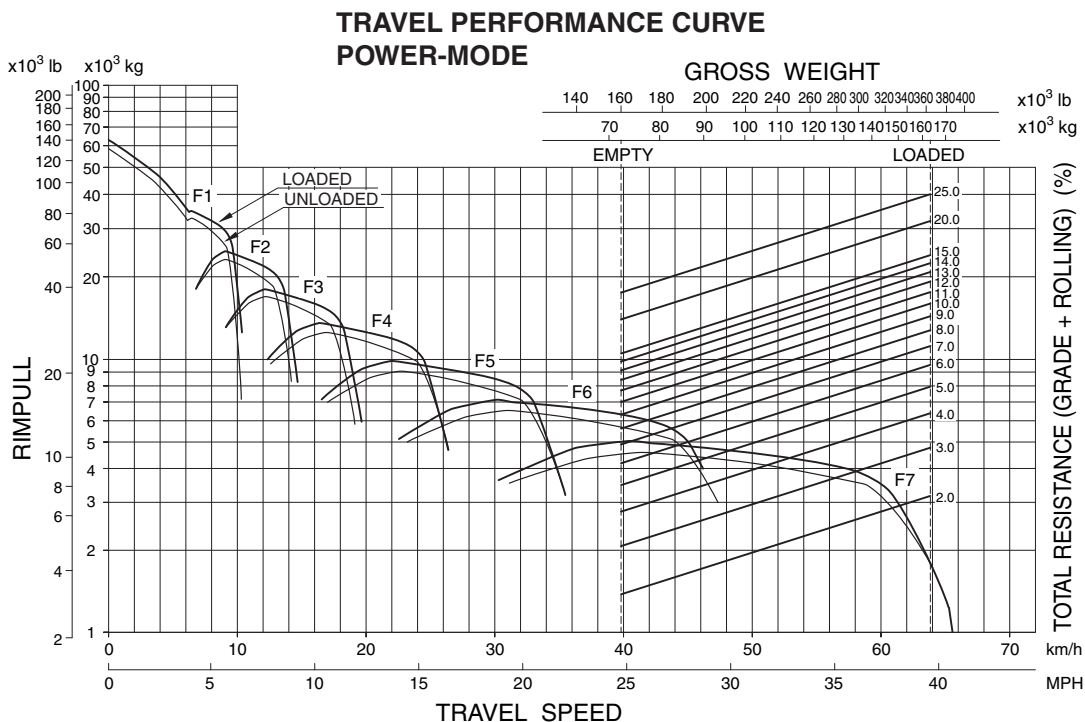

Travel Performance Curve
Economy-mode

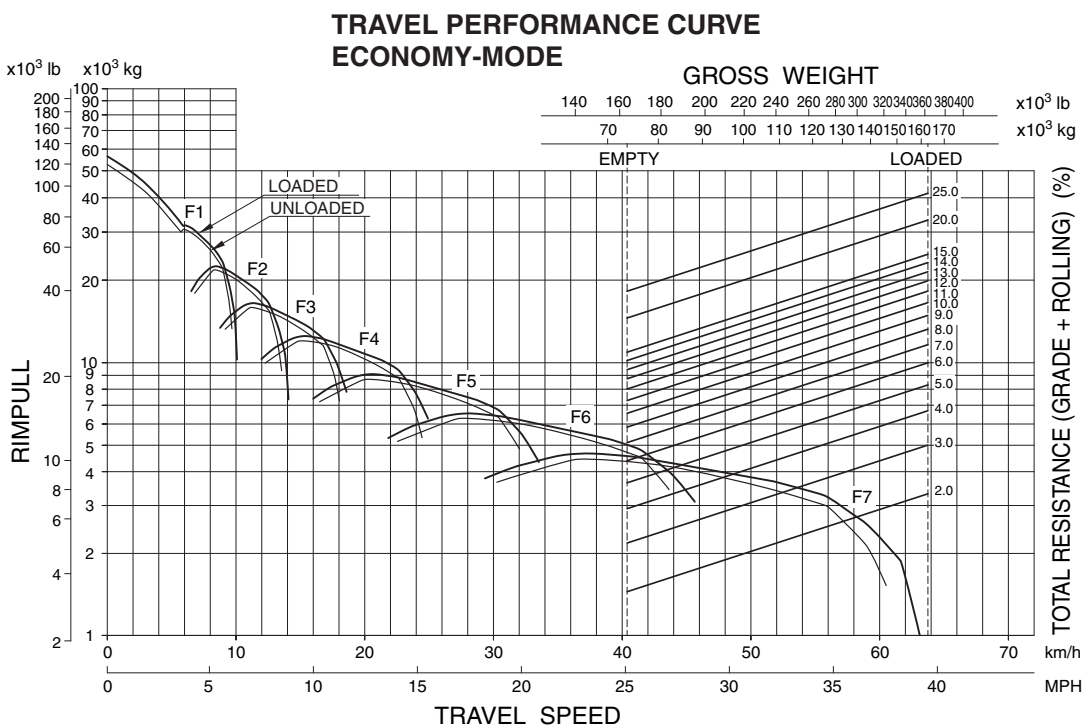

Brake performance

Grade distance : Continuous Descent

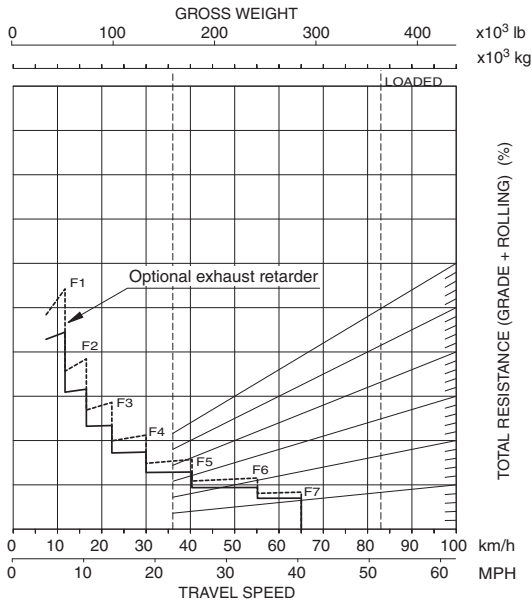

Grade distance : 450m (1,500 ft)

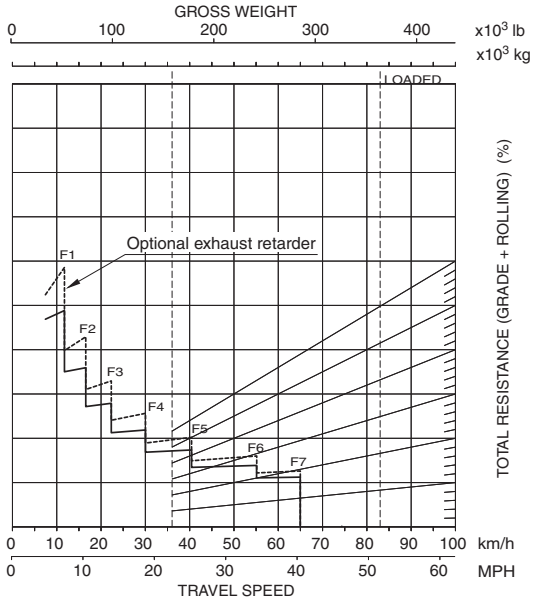

Grade distance : 600m (2,000 ft)

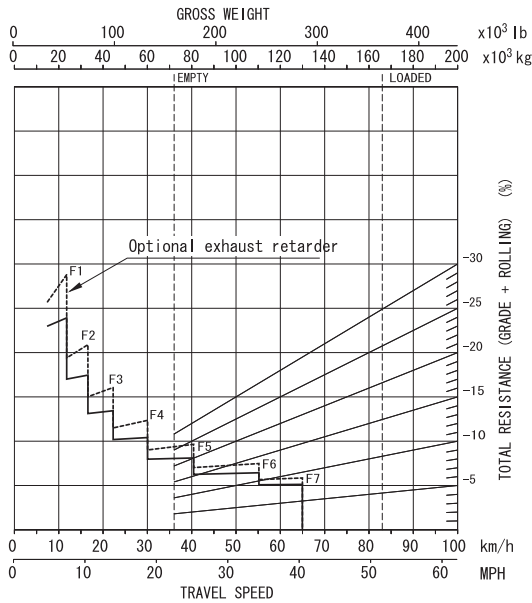

Brake performance

Grade distance : 900m (3,000 ft)

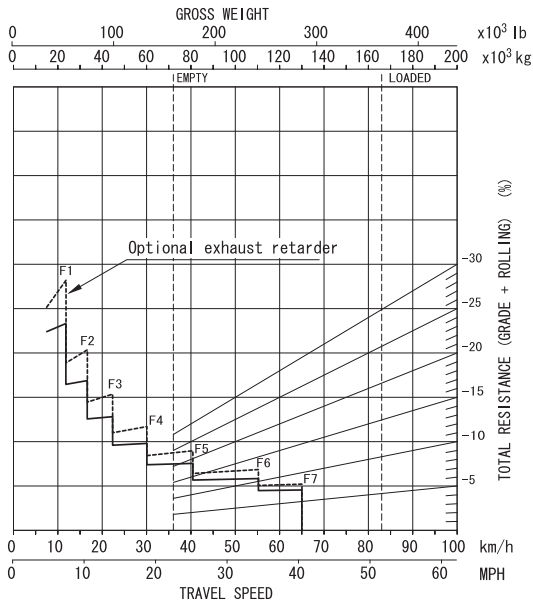

Grade distance : 1500m (5,000 ft)

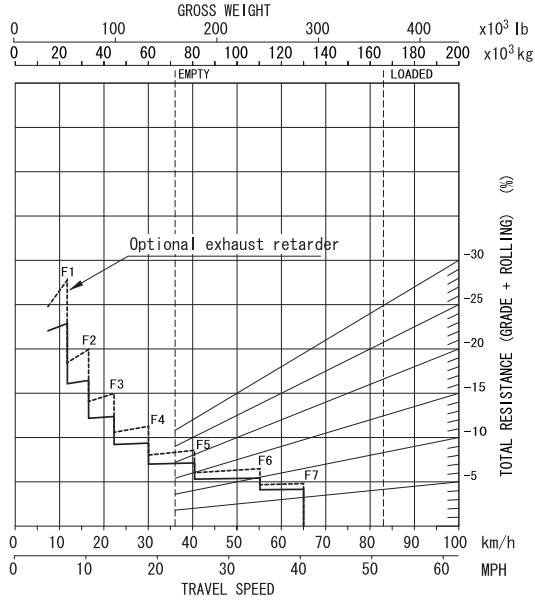

Travel performance

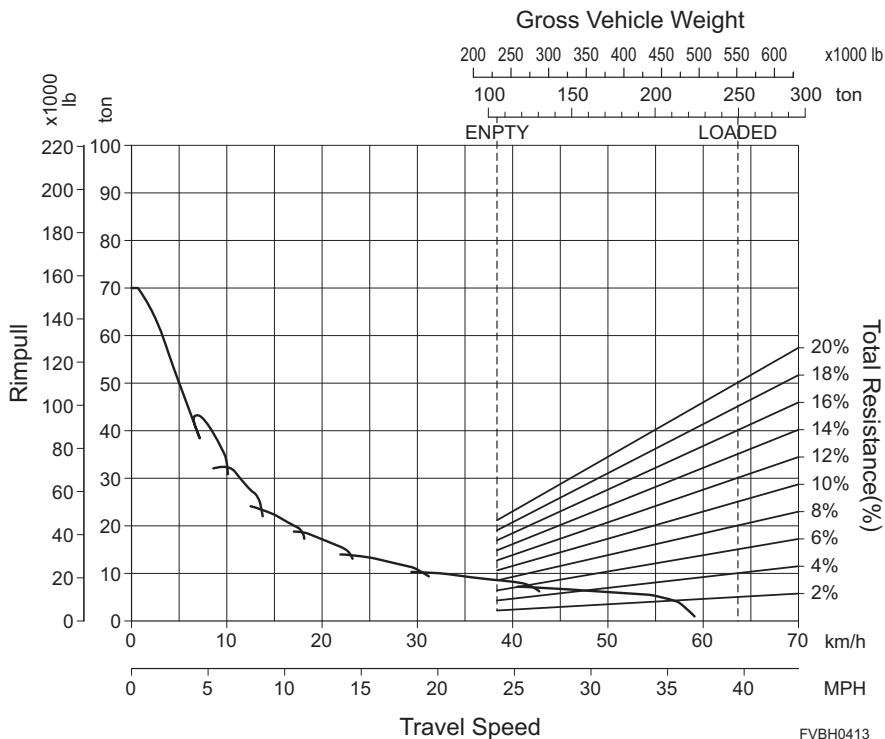

FVBH0413

Brake performance

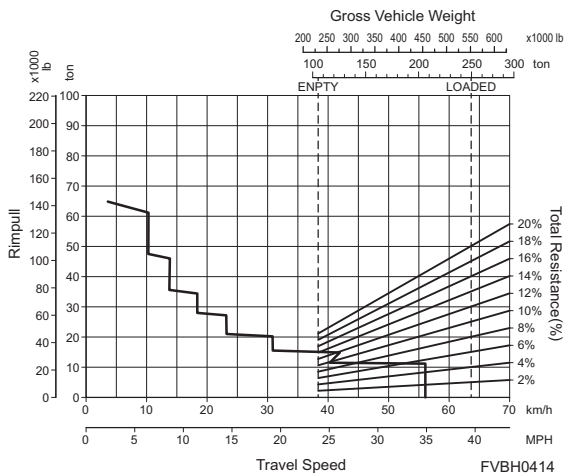

FVBH0414

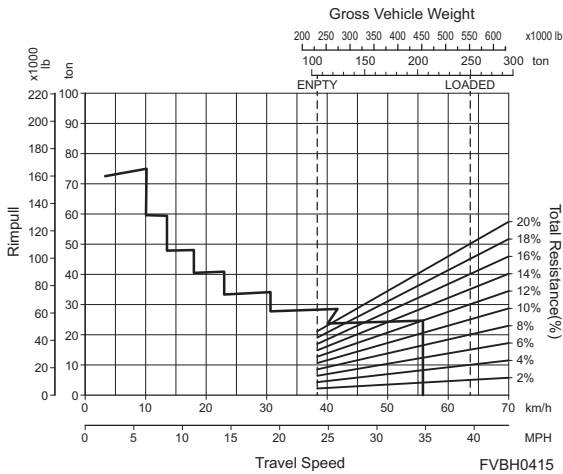

FVBH0415

Travel performance

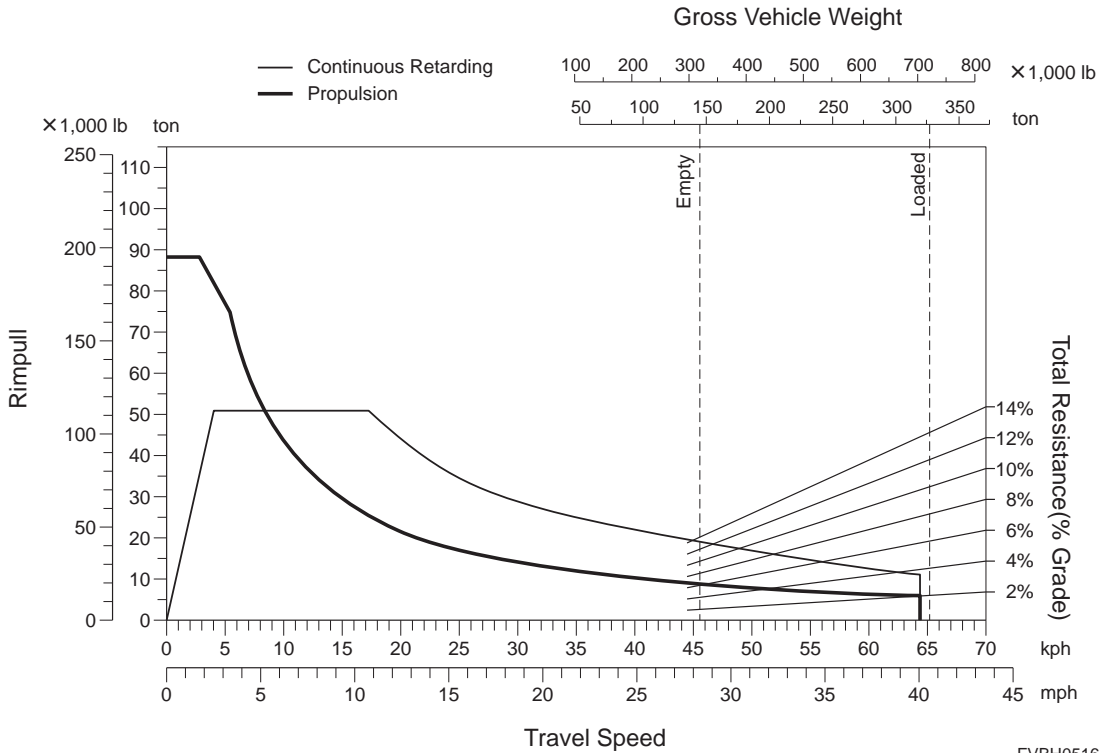

FVBH0516

How to use this Performance Chart:

1. Calculate the Total Resistance (%).

$$\text{Total Resistance (\%)} = \text{Grade Resistance (\%)} + \text{Rolling Resistance (\%)}$$
2. Calculate Rimpull Required.

$$\text{Rimpull (lb or kg)} = \text{Gross vehicle Weight (lb or kg)} \times \text{Total Resistance (\%)}$$
3. Locate the Point on the Rimpull Scale (lb or kg).
4. Read horizontally to the Performance Curve.
5. From the intersection at the curve, read vertically down to the speed scale (mph or km/h).

How to use this Retarding Chart:

1. Calculate the Total Resistance (%).

$$\text{Total Resistance (\%)} = \text{Grade Resistance (\%)} - \text{Rolling Resistance (\%)}$$
2. Calculate Retarding Force Required.

$$\text{Retarding Force (lb or kg)} = \text{Gross vehicle Weight (lb or kg)} \times \text{Total Resistance (\%)}$$
3. Locate the Point on the Retarding Force Scale (lb or kg).
4. Read horizontally to locate the two points intersecting the Retarding Curve.
5. Read vertically down to the speed scale.
 The two points represent the minimum and maximum downhill retarding speed (mph or km/h).

Travel performance

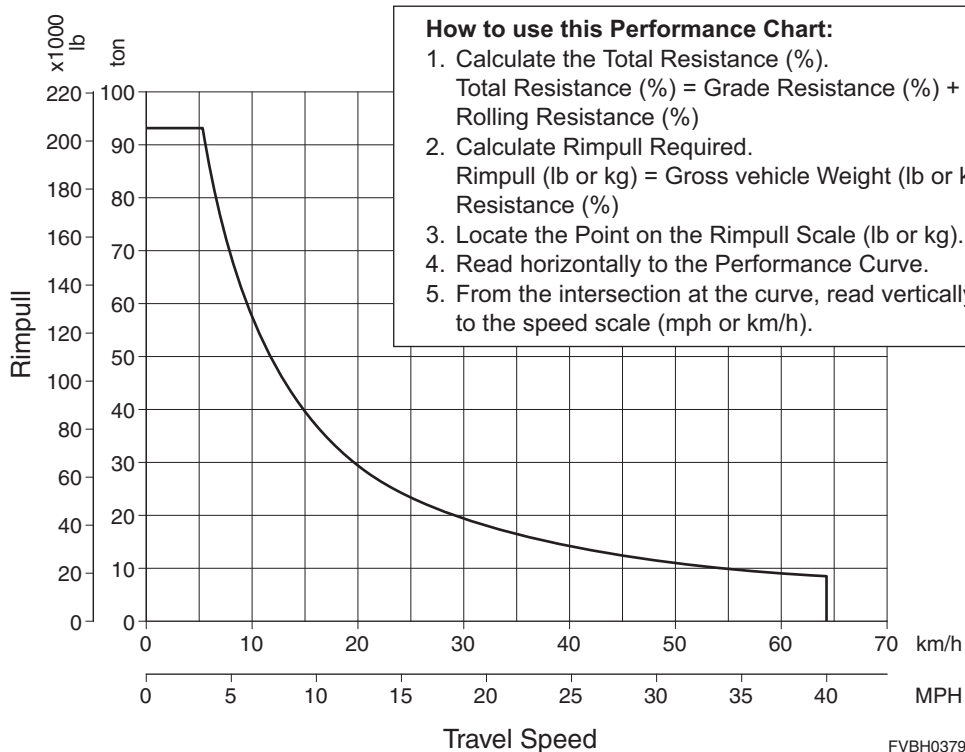

Brake performance

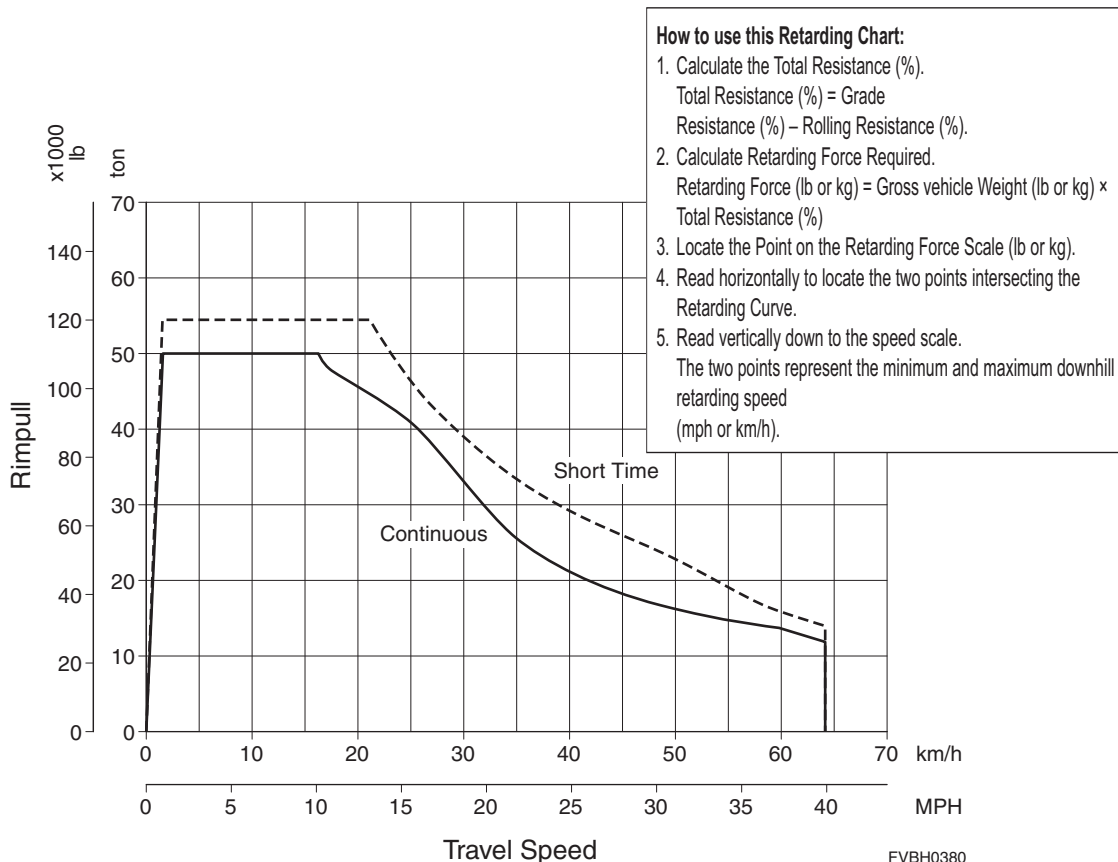

Travel and brake performance

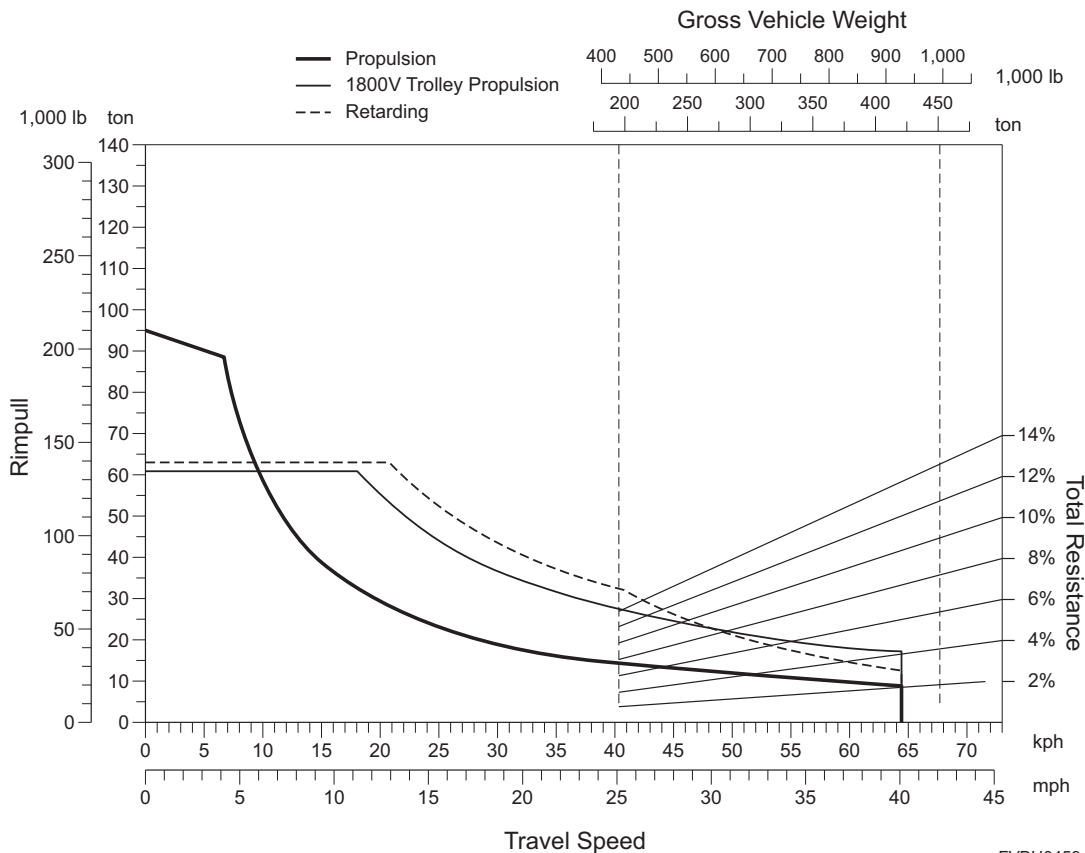

FVBH0459

How to use this Performance Chart:

1. Calculate the Total Resistance (%).
Total Resistance (%) = Grade Resistance (%) + Rolling Resistance (%)
2. Calculate Rimpull Required.
Rimpull (lb or kg) = Gross vehicle Weight (lb or kg) × Total Resistance (%)
3. Locate the Point on the Rimpull Scale (lb or kg).
4. Read horizontally to the Performance Curve.
5. From the intersection at the curve, read vertically down to the speed scale (mph or km/h).

How to use this Retarding Chart:

1. Calculate the Total Resistance (%).
Total Resistance (%) = Grade Resistance (%) – Rolling Resistance (%).
2. Calculate Retarding Force Required.
Retarding Force (lb or kg) = Gross vehicle Weight (lb or kg) × Total Resistance (%)
3. Locate the Point on the Retarding Force Scale (lb or kg).
4. Read horizontally to locate the two points intersecting the Retarding Curve.
5. Read vertically down to the speed scale.
The two points represent the minimum and maximum downhill retarding speed (mph or km/h).

Travel performance

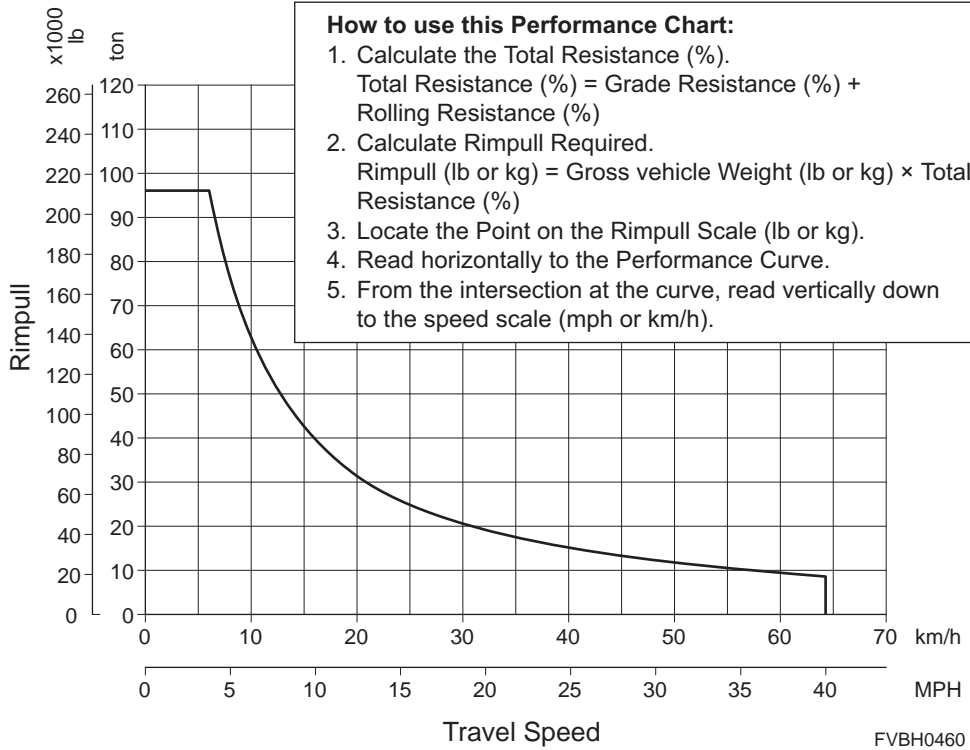

Brake performance

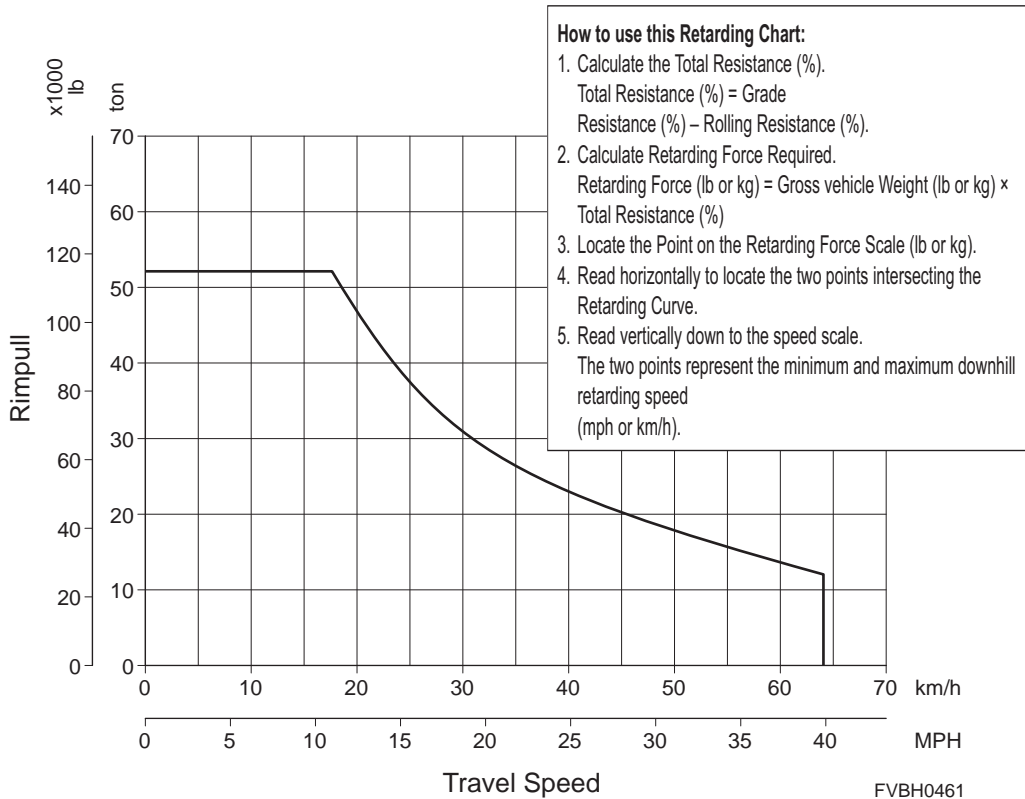

Travel performance

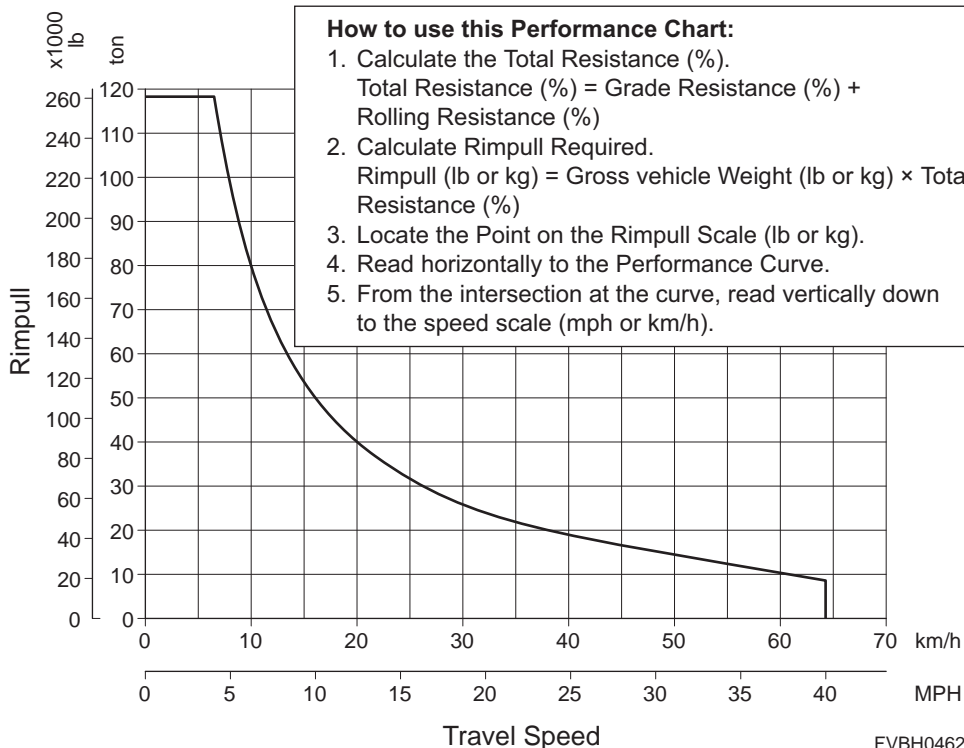

Brake performance

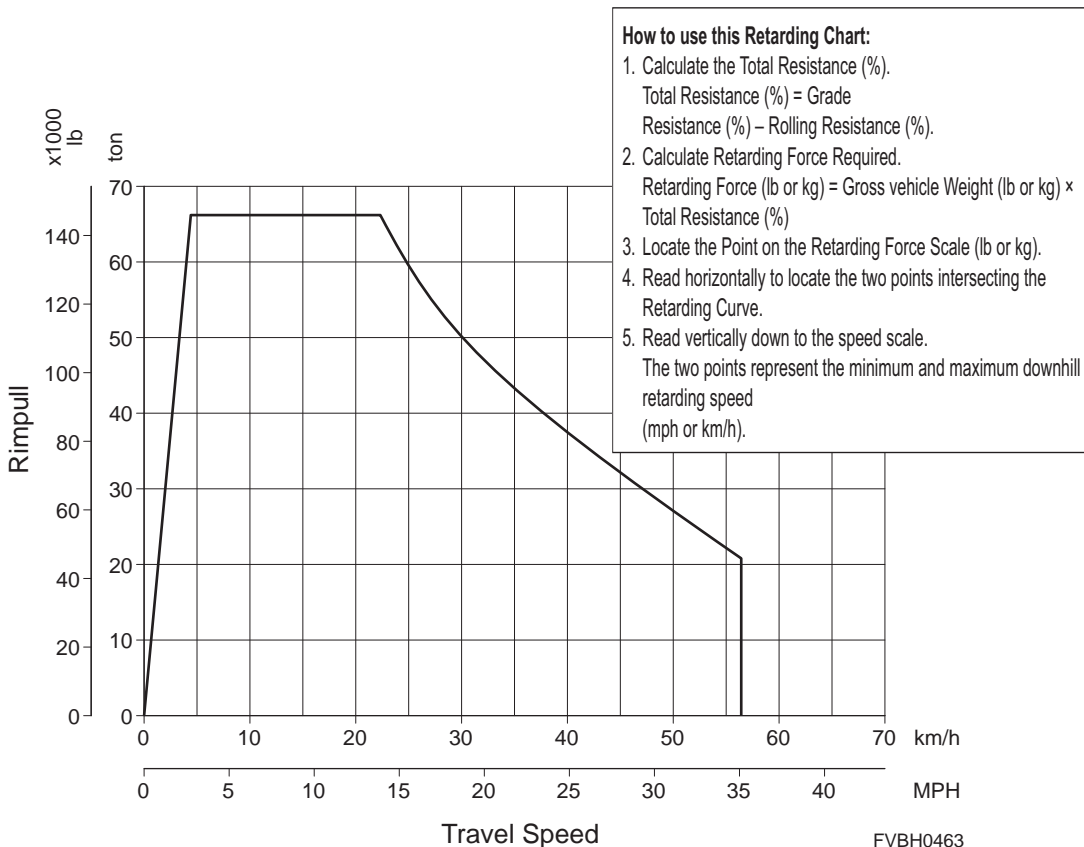

Travel and brake performance

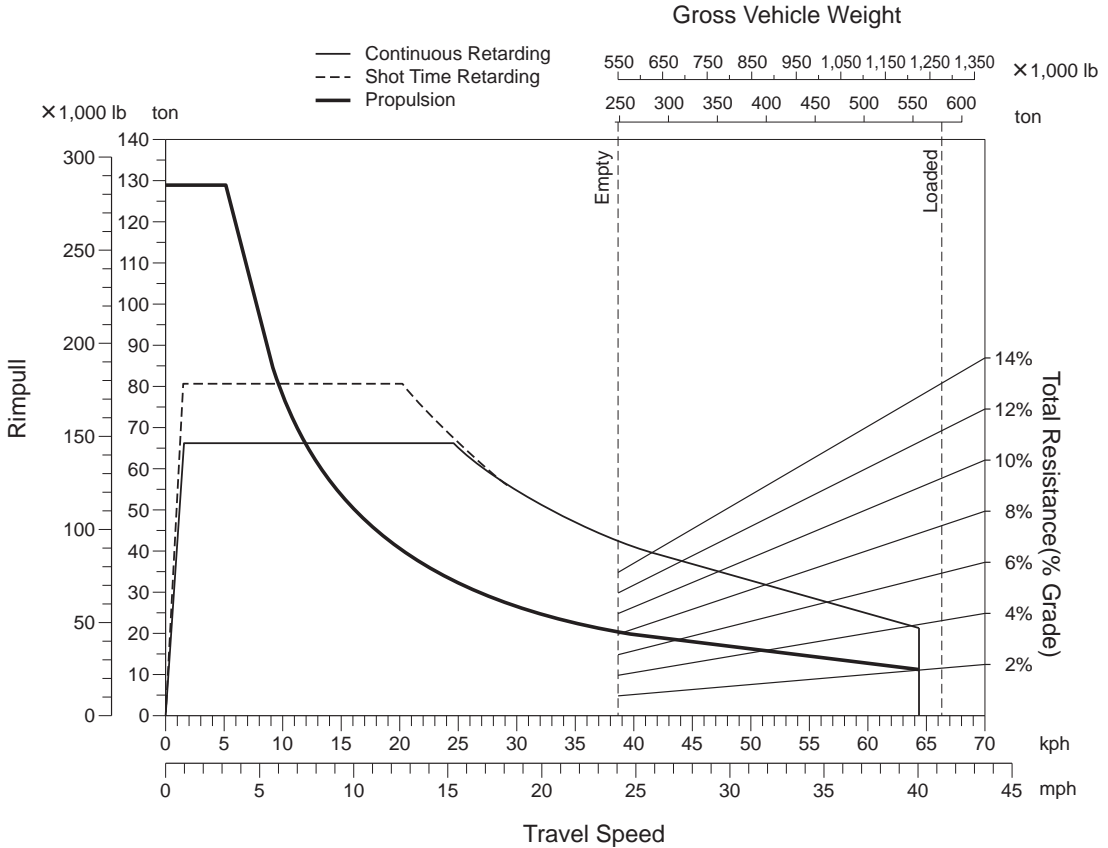

FVBH0513

How to use this Performance Chart:

1. Calculate the Total Resistance (%).
Total Resistance (%) = Grade Resistance (%) + Rolling Resistance (%)
2. Calculate Rimpull Required.
Rimpull (lb or kg) = Gross vehicle Weight (lb or kg) × Total Resistance (%)
3. Locate the Point on the Rimpull Scale (lb or kg).
4. Read horizontally to the Performance Curve.
5. From the intersection at the curve, read vertically down to the speed scale (mph or km/h).

How to use this Retarding Chart:

1. Calculate the Total Resistance (%).
Total Resistance (%) = Grade Resistance (%) – Rolling Resistance (%).
2. Calculate Retarding Force Required.
Retarding Force (lb or kg) = Gross vehicle Weight (lb or kg) × Total Resistance (%)
3. Locate the Point on the Retarding Force Scale (lb or kg).
4. Read horizontally to locate the two points intersecting the Retarding Curve.
5. Read vertically down to the speed scale.
The two points represent the minimum and maximum downhill retarding speed (mph or km/h).

Travel and brake performance

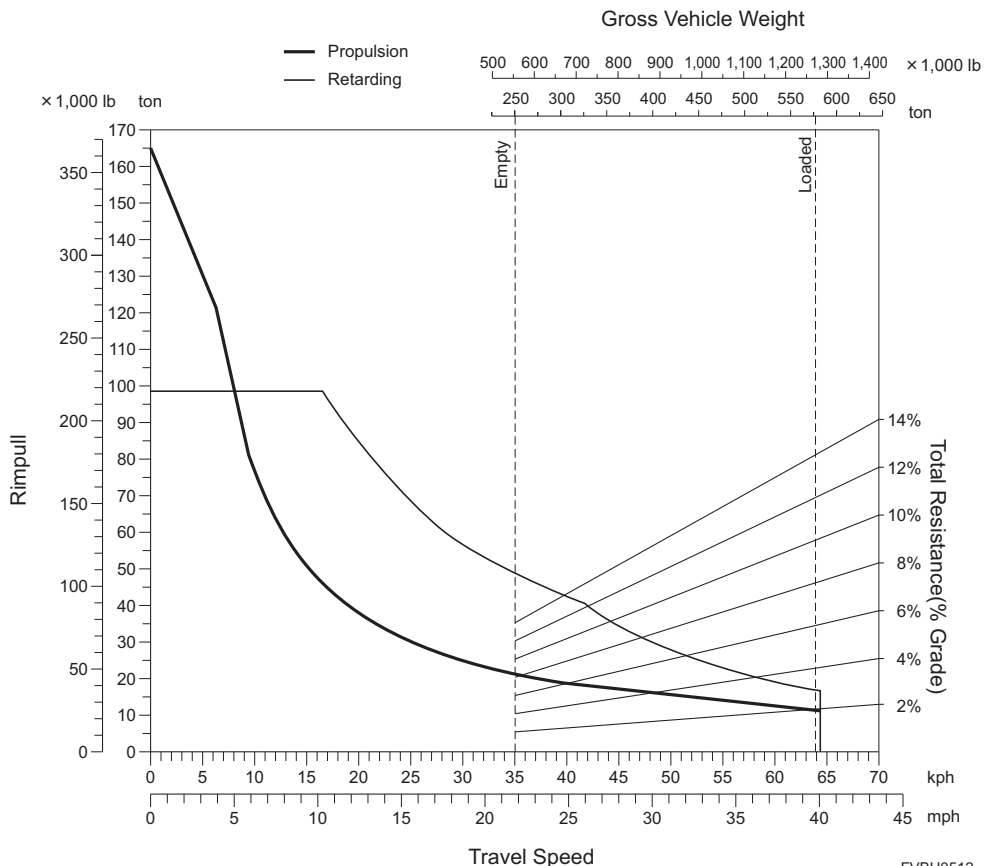

FVBH0512

How to use this Performance Chart:

1. Calculate the Total Resistance (%).
Total Resistance (%) = Grade Resistance (%) + Rolling Resistance (%)
2. Calculate Rimpull Required.
Rimpull (lb or kg) = Gross vehicle Weight (lb or kg) × Total Resistance (%)
3. Locate the Point on the Rimpull Scale (lb or kg).
4. Read horizontally to the Performance Curve.
5. From the intersection at the curve, read vertically down to the speed scale (mph or km/h).

How to use this Retarding Chart:

1. Calculate the Total Resistance (%).
Total Resistance (%) = Grade Resistance (%) – Rolling Resistance (%).
2. Calculate Retarding Force Required.
Retarding Force (lb or kg) = Gross vehicle Weight (lb or kg) × Total Resistance (%)
3. Locate the Point on the Retarding Force Scale (lb or kg).
4. Read horizontally to locate the two points intersecting the Retarding Curve.
5. Read vertically down to the speed scale.
The two points represent the minimum and maximum downhill retarding speed (mph or km/h).

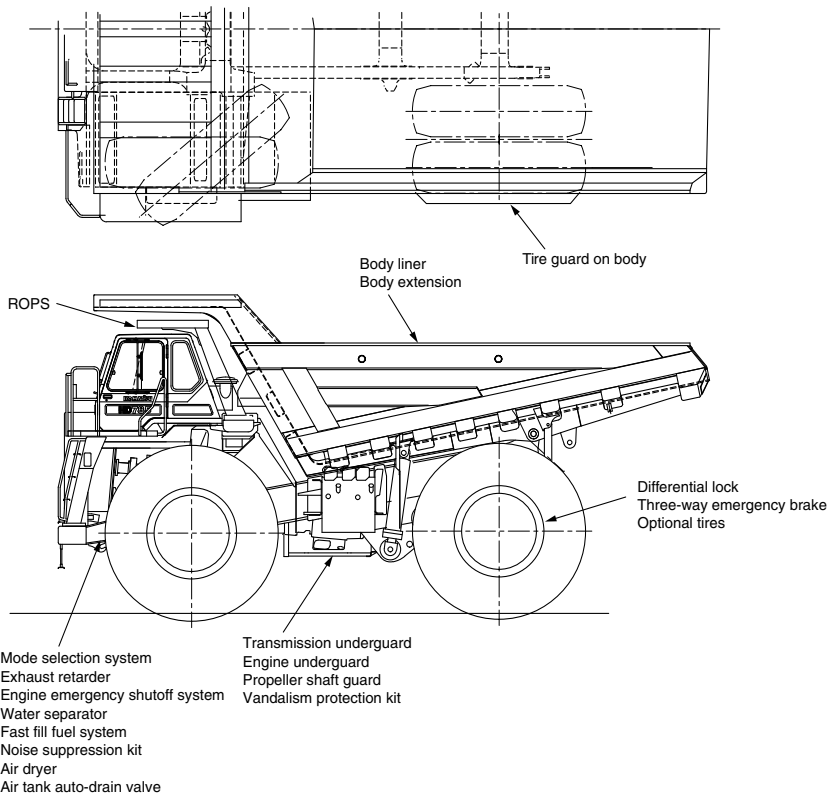
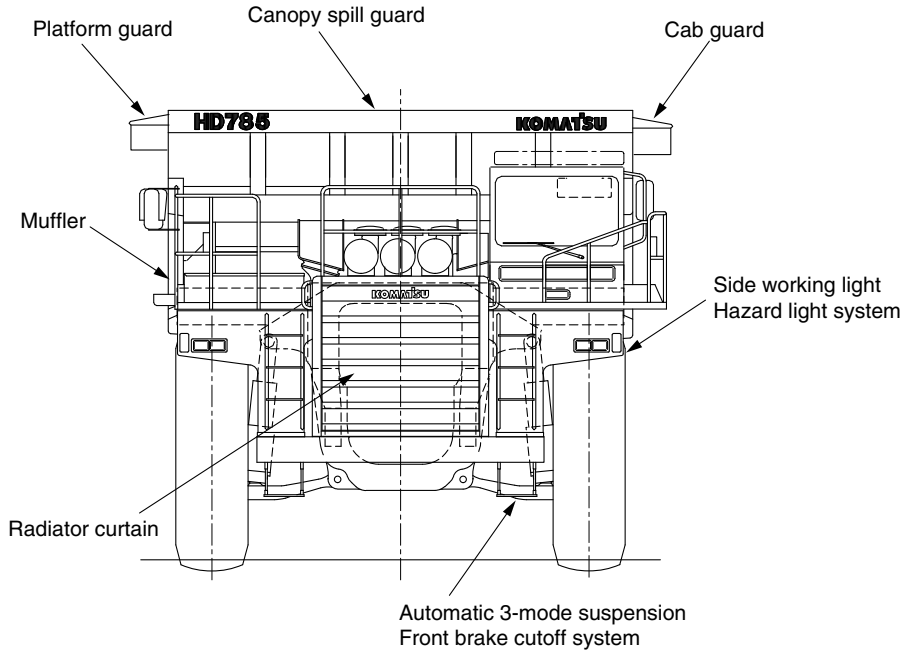

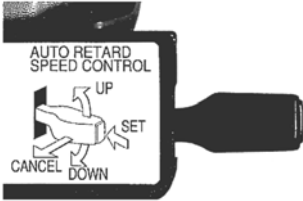
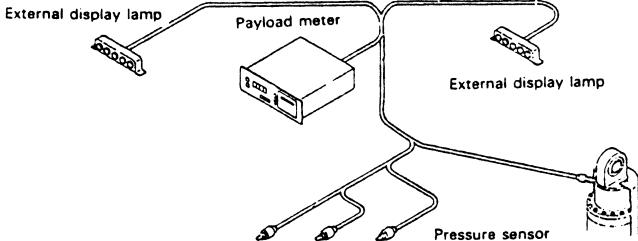
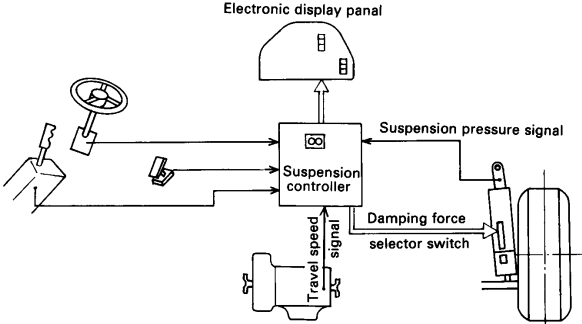
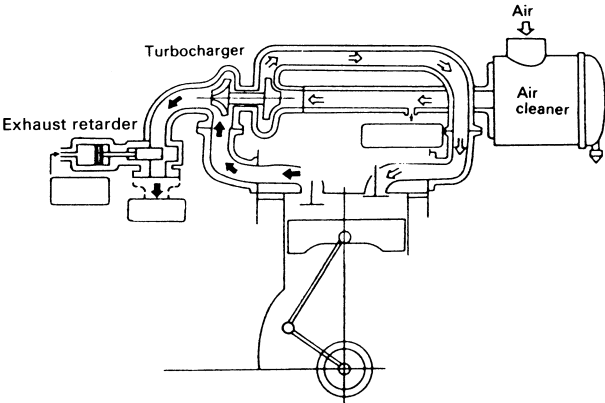
Description	Features
<p>PMC (power train management control)</p>	<ul style="list-style-type: none"> • Vehicle condition can be easily monitored to confirm functions or perform troubleshooting efficiently. • Stored data can be downloaded through customer provided personal computer with Komatsu PMC download software to transfer the data to customer maintenance/production database. • Memory card type Payload meter (PLM2) data can also be downloaded through the same PC connection port. (HD785)
<p>Auto Retard Speed Control (ARSC)</p> 	<ul style="list-style-type: none"> • Setting of desired downhill speed is possible • Fine adjustment of setting speed is possible within ± 5 km/h (3.1 MPH)
<p>Payload meter</p> 	<ul style="list-style-type: none"> • The payload meter measures and records the amount loaded, and also uses the external display lamps to show the present payload and to estimate the weight when the next bucket is loaded, thereby informing the loader operator. So it is possible to load the most suitable amount and to avoid overloading. • By knowing the production, it becomes possible to carry out efficiency control of combinations, and administration of economic use of the machines.
<p>Automatic three-mode suspension</p> 	<ul style="list-style-type: none"> • The suspension is controlled to give the optimum suspension characteristics for the travel conditions, so the riding comfort and travel stability are greatly improved. • The travel stability functions, such as anti-roll and anti-dive, prevent excessive stress from being brought to bear on the frame, thereby contributing to increased service life. • (The electronic display system must be installed.)
<p>Exhaust retarder</p> 	<ul style="list-style-type: none"> • Combination with the oil-cooled multiple disc retarder makes high-speed downhill travel possible, thereby improving working efficiency. • It is possible to increase the wear life of the service brake.
<p>Front brake cut off system</p>	<p>The operation of the front brake can be cancelled with a switch. This is effective in preventing slipping on job sites where the road surface is poor.</p>

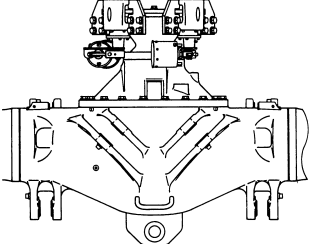
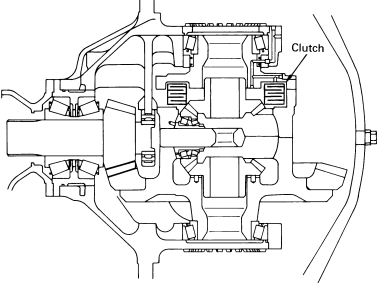
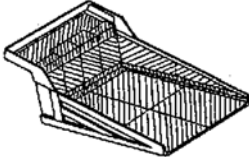
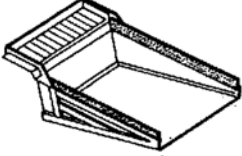
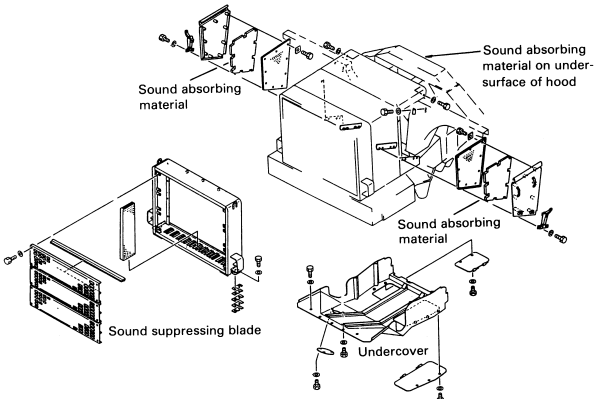
Description	Features
<p>Three-way emergency brake</p> 	<p>For safety, independent circuits are used for the brakes on the front and rear wheels, but if for any reason the service brake should lose power, the double-caliper parking brake is in another circuit, so it can always be used as an emergency brake to increase the safety (A two-way emergency brake is standard on the HD785-5, and a double caliper parking brake is installed.)</p>
<p>Differential lock</p> 	<p>This device controls the operation of the rear axle differential and is effective in preventing slipping and improving drawbar pull on soft ground.</p>
<p>Body liner</p> 	<p>A liner plate for the purpose of preventing wear or deformation of the body. There are two types of liner: the steel liner and the rubber liner. Their use must be distinguished according to the purpose. (See "Body selection")</p>
<p>Body extension</p> 	<p>This extends the height of the side of the dump body. This increases the capacity of the body to ensure the rated load (For example: the capacity of the HD325-5 is 32 tons) when handling loads with a low specific gravity. It is also used to prevent spillage of load caused by adverse travel conditions (rough road surface, uphill slope, downhill slope, road with curves).</p>
<p>Platform guard (See 4A-40)</p>	<p>This guard protects the right platform from rocks falling from the dump body.</p>
<p>Transmission under guard (See 4A-40)</p>	<p>This guard protects the transmission oil pan from flying stones when traveling.</p>
<p>Propeller shaft guard (See 4A-40)</p>	<p>This guard prevents secondary damage if the propeller shaft is broken.</p>
<p>Tire guard on body (See 4A-40)</p>	<p>When large diameter tires are installed, this guard protects the tires from rocks falling from the dump body. (This is necessary when large diameter tires are installed.)</p>
<p>ROPS (See 4A-40)</p>	<p>ROPS meeting SAE J1040C</p>
<p>Noise suppression kit</p> 	<p>This consists of both side covers of the engine compartment, undercover, sound absorbing blade, sound absorbing material on under-surface of hood and sound suppressing muffler. (The muffler must be installed)</p>

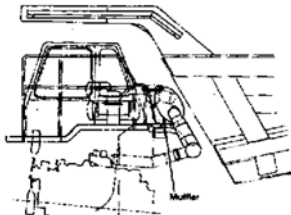
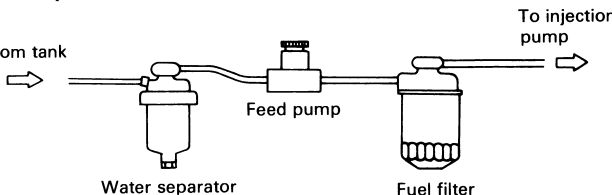
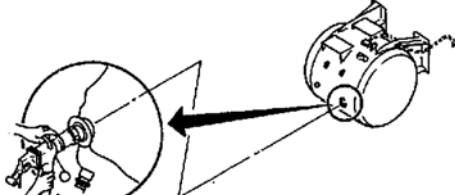
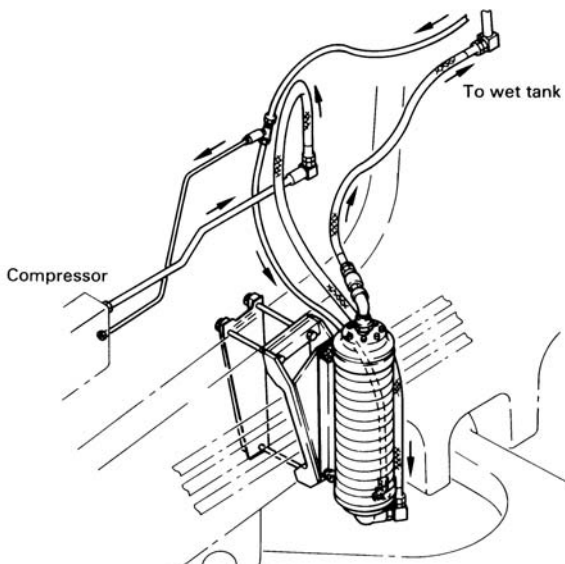
Description	Features
<p>Muffler (without body heating)</p> 	<p>This can reduce the exhaust noise regardless of body raising. This muffler is available for users who do not require body heating.</p>
<p>Radiator shutter</p>	<p>The radiator shutter is installed to make the rise in water temperature faster when starting in cold areas, and to prevent overcooling. It detects the water temperature and automatically opens or closes the shutter, so there is no time taken for installation or removal as with a radiator curtain.</p>
<p>Water separator</p>  <p>From tank → Water separator → Feed pump → Fuel filter → To injection pump</p>	<p>This removes water in the fuel, thereby maintaining engine reliability and durability. (Areas or environments where fuel management is insufficient.)</p>
<p>Fast-fill fuel system</p> 	<p>A quick charge coupler to match the WIGGINS quick charge system is installed to the fuel tank. (The user must provide the pump unit.)</p>
<p>Air dryer</p>  <p>Compressor → To wet tank</p>	<p>A fin-cooled type dryer is installed in the air circuit to remove the water in the circuit. This prevents problems caused by freezing of water in the air circuit and makes maintenance easier.</p>
<p>Air tank auto-drain valve</p>	<p>This automatically drains the water in the air tank, making maintenance easier. (To prevent water from freezing inside the tubes.)</p>
<p>Anti-lock Braking System (ABS)</p>	<p>This system prevents the tire lock under slippery condition while applying service brake and gives safety drive of the truck.</p>
<p>Automatic Spin Regulator (ASR)</p>	<p>Since ASR automatically prevents the rear wheels from slipping singly on soft ground, etc., proper drive force is obtained.</p>

TIRE SELECTION

Tire availability

Komatsu Dump Trucks employ the tubeless tire only.

Every tire size is classified into E3 or E4 codes.

Either E3 or E4 code had CR, GP or HR characteristics to meet specific operating conditions.

The relation between the tire characteristics and operating conditions is shown in the table.

Model	Tires size	Code	Remark
HD255-5	16.00-25-28PR	E-3, E-4	
	16.00-25-32PR	E-3, E-4	
	16.00 R25	E-3, E-4	
HD325-7 HD325-7R	18.00-33-32PR	E-3, E-4	
	18.00-33	E-3, E-4	
	18.00 R33	E-3, E-4	
HD325-6	18.00-33-32PR	E-3, E-4	
	18.00-33-28PR	E-3, E-4	
	18.00 R33	E-3, E-4	*
HD405-7 HD405-7R	18.00 R33	E-3, E-4	
HD405-6	18.00 R33	E-3, E-4	
HD465-7E0 HD465-7 HD465-7R	24.00-35-36PR	E-3, E-4	
	24.00 R35	E-3, E-4	
HD605-7E0 HD605-7R	24.00 R35	E-3, E-4	

Model	Tires size	Code	Remark
HD785-7	27.00 R49	E-3, E-4	
	31/90 R49		
HD1500-7	33.00 R51	E-4	
730E	37.00 R57	E-4	
830E	40.00 R57	E-4	
830E-AC	40.00 R57	E-4	
	46/90 R57	E-4	
860E-1K	50/80 R57	E-4	
	50/90 R57	E-4	
930E-4	53/80 R63	E-4	
930E-4SE	53/80 R63	E-4	
960E-2	56/80 R63	E-4	
960E-2K	56/80 R63	E-4	

*: USA source

NOTE: *When installing radial tires, please use the special rim for radial tire.

Tire characteristics and operating conditions

Characteristics	Haul Distance and Payload	Surface Condition							
		Rocks Scattered on Surface			Surface Ruggedness			Sub-base	
		Thin	Normal	Thick	Good	Normal	Bad	Normal	Soft
CR	Low TKPH (TMPH)		○	○		○	○	○	○
GP	Middle TKPH (TMPH)		○			○		○	
HR, SHRR	High TKPH (TMPH)	○			○			○	

TMPH RATING

Where the ambient temperature in an operating environment is high or where a long haul or high-speed drive is required, the standard tires are sometimes unsuitable because of their small TMPH.

Under the above operating conditions, it is recommended that the optimum tires be determined after obtaining TMPH by applying the formulas stated in the section 15 and referring to the following table.

NOTE: The TMPH rating is based on U.S. ton (not on metric ton)

$$\Delta \text{TMPH} = \Delta \text{TKPH} \div 1.46$$

TIRE SELECTION GUIDE FOR RIGID DUMP TRUCKS

Model	Tire size	Manufacturer*	Code	Pattern	Type	TKPH (TMPH)	Inflation pressure kgf/cm ² (PSI)	Structure		
HD255-5	16.00 – 25	BS	E-3	RL	2A	139 (95)	5.75 (82)	Bias		
		BS	E-4	RLS	2A	111 (76)	5.75 (82)	Bias		
	16.00 R25	BS	E-4	VRLS	3A	168 (115)	7 (100)	Radial		
		BS	E-4	VRLS	1A	146 (100)	7 (100)	Radial		
		BS	E-4	VRLS	2A	112 (77)	7 (100)	Radial		
		BS	E-4	VZTS			7 (100)	Radial		
		BS	E-4	VMTS	3A	179 (123)	7 (100)	Radial		
		BS	E-4	VMTS	1A	157 (108)	7 (100)	Radial		
	16.00 – 25	TOYO	E-3	G-18	SP	175 (120)	5.75 (82)	Bias		
			E-3	G-18	CR	145 (99)	5.75 (82)	Bias		
			E-4	G-18ET	SP	145 (99)	5.75 (82)	Bias		
			E-4	G-18ET	CR	124 (85)	5.75 (82)	Bias		
	16.00 – 25	YOKOHAMA	E-3	Y67	HR-H, HR-V	153 (105)	5.75 (82)	Bias		
			E-3	Y67	RE-R, RE-T	139 (95)	5.75 (82)	Bias		
			E-3	Y67	CP-S, CP-C	124 (85)	5.75 (82)	Bias		
			E-4	Y523	HR-H, HR-V	131 (90)	5.75 (82)	Bias		
			E-4	Y523	RE-R, RE-T	117 (80)	5.75 (82)	Bias		
			E-4	Y523	CP-S, CP-C	102 (70)	5.75 (82)	Bias		
	16.00 R25	YOKOHAMA	E-4	RB41	HR	162 (111)	7 (100)	Radial		
			E-4	RB41	SP	160 (110)	7 (100)	Radial		
E-4			RB41	CP	124 (85)	7 (100)	Radial			
16.00 R25	MICHELIN	E-3	XK	B	187 (128)	7 (100)	Radial			
		E-3	XR	B	204 (140)	7 (100)	Radial			
		E-4	XHD1	A4	105 (72)	7 (100)	Radial			
		E-4	XHD1	A	164 (112)	7 (100)	Radial			
		E-4	XHD1	B	175 (120)	7 (100)	Radial			
		E-4	XHD1	B	152 (104)	7 (100)	Radial			
16.00 – 25	GY	E-3	HRL-3A			5.75 (82)	Bias			
		E-3	RL-3+	2S, 4S		7 (100)	Radial			
16.00 R25	GY	E-4	RL-4B	4, 6S		7 (100)	Radial			
		E-4	RL-4J	6S		7 (100)	Radial			
		E-4	RL-4J			7 (100)	Radial			
HD325-6 HD405-6 HD325-7 HD325-7R HD405-7 HD405-7R	18.00 – 33	BS	E-3	RL	1A	212 (145)	5.75 (82)	Bias		
		BS	E-3	RL	2A	190 (130)	5.75 (82)	Bias		
		BS	E-4	ELS2	1A	182 (125)	5.75 (82)	Bias		
		BS	E-4	ELS2	2A	161 (110)	5.75 (82)	Bias		
	18.00 R33	BS	E-3	VEL	3A	307 (210)	7 (100)	Radial		
			E-3	VEL	1A	263 (180)	7 (100)	Radial		
			E-3	VEL	2A	213 (146)	7 (100)	Radial		
			E-4	VRLS	3A	246 (168)	7 (100)	Radial		
			E-4	VRLS	1A	211 (145)	7 (100)	Radial		
			E-4	VRLS	2A	170 (116)	7 (100)	Radial		
			E-4	VELS	2A		7 (100)	Radial		
			E-4	VMTP	2A		7 (100)	Radial		
			E-4	VZTS	2A		7 (100)	Radial		
			18.00 – 33	TOYO	E-3	G-18	SP	211 (145)	5.75 (82)	Bias
					E-3	G-18	CR	182 (125)	5.75 (82)	Bias
					E-4	G-18ET	SP	167 (114)	5.75 (82)	Bias
	E-4	G-18ET			CR	145 (99)	5.75 (82)	Bias		
	E-4	G-36ET			CR	145 (99)	5.75 (82)	Bias		
	E-4	G-36ET			CE	109 (75)	5.75 (82)	Bias		
	18.00 R33	TOYO	E-4	T-432	HR	218 (149)	7 (100)	Radial		
E-4			T-432	SP	167 (114)	7 (100)	Radial			
E-4			T-432	CR	124 (85)	7 (100)	Radial			
18.00 – 33	YOKOHAMA	E-3	Y67	HR-H	255 (175)	5.75 (82)	Bias			
		E-3	Y67	HR-V	280 (192)	5.75 (82)	Bias			
		E-3	Y67	RE-R	212 (145)	5.75 (82)	Bias			
		E-3	Y67	RE-T	233 (160)	5.75 (82)	Bias			
		E-3	Y67	CP-S	190 (130)	5.75 (82)	Bias			
		E-3	Y67	CP-S		5.75 (82)	Bias			

* Tire maker BS: BRIDGESTONE
GY: GOODYEAR

- NOTE1:** (1) The TKPH in the table is the value at 38°C (100°F) an ambient temperature. (The value as of February, 2000.) When the distance for the round trip exceeds 5 km, the tire life is governed by the travel conditions, so check with the tire maker for details of the TKPH when selecting the tires.
(2) The value for TKPH is reviewed from time to time by the tire maker, so consult the maker for the latest values.
(3) For details of the TKPH value and tire specifications for conditions not given in this table, please consult the tire maker.

NOTE2: Some tires in the above table cannot be selected for some destinations.

Tire Selection

RIGID DUMP TRUCKS

Model	Tire size	Manufacturer*	Code	Pattern	Type	TKPH (TMPH)	Inflation pressure kgf/cm ² (PSI)	Structure
HD325-6 HD405-6 HD325-7 HD325-7R HD405-7 HD405-7R	18.00 – 33	YOKOHAMA	E-4	Y523	HR-H	219 (150)	5.75 (82)	Bias
		YOKOHAMA	E-4	Y523	RH-V	240 (164)	5.75 (82)	Bias
		YOKOHAMA	E-4	Y523	RE-R	182 (125)	5.75 (82)	Bias
		YOKOHAMA	E-4	Y523	RE-T	197 (135)	5.75 (82)	Bias
		YOKOHAMA	E-4	Y523	CP-S	122 (84)	5.75 (82)	Bias
		YOKOHAMA	E-4	Y523	CP-C	153 (105)	5.75 (82)	Bias
		YOKOHAMA	E-4	Y523U	RE-R	168 (115)	5.75 (82)	Bias
		YOKOHAMA	E-4	Y523U	RE-T	183 (125)	5.75 (82)	Bias
		YOKOHAMA	E-4	Y523U	CP-S	117 (80)	5.75 (82)	Bias
	YOKOHAMA	E-4	Y523U	CP-C	146 (100)	5.75 (82)	Bias	
	18.00 R33	MICHELIN	E-3	XK	B	279 (191)	7 (100)	Radial
		MICHELIN	E-3	XR	B	305 (209)	7 (100)	Radial
		MICHELIN	E-4	XDT	A4	157 (108)	7 (100)	Radial
		MICHELIN	E-4	XDT	A	192 (132)	7 (100)	Radial
		MICHELIN	E-4	XDT	B	262 (179)	7 (100)	Radial
		MICHELIN	E-4	XKD1	A	157 (108)	7 (100)	Radial
		MICHELIN	E-4	X-QUARRY		122 (84)	7 (100)	Radial
		MICHELIN	E-4	XV	C	436 (299)	7 (100)	Radial
		MICHELIN	E-4	X-HAUL		262 (179)	7 (100)	Radial
	18.00 – 33	GY	E-3	HRL-3A			5.75 (82)	Bias
		GY	E-4	HRL-4B			5.75 (82)	Bias
	18.00 R33	GY	E-3	RL-3+	2S, 4S		7 (100)	Radial
		GY	E-4	RL-4B	4S, 6S		7 (100)	Radial
		GY	E-4	RL-4F	4S		7 (100)	Radial
		GY	E-4	RL-4J	4S, 6S		7 (100)	Radial
		GY	E-4	RL-4A	4S		7 (100)	Radial
	HD465-7 HD465-7E0 HD605-7E0 HD465-7R HD605-7R	24.00 – 35	BS	E-3	RL	1A	328 (225)	5.75 (82)
BS			E-3	RL	2A	291 (199)	5.75 (82)	Bias
BS			E-4	RLS	3A	394 (270)	5.75 (82)	Bias
BS			E-4	RLS	1A	277 (190)	5.75 (82)	Bias
BS			E-4	RLS	2A	234 (160)	5.75 (82)	Bias
24.00 R35		BS	E-3	VEL	3A	524 (359)	7 (100)	Radial
		BS	E-3	VEL	1A	448 (307)	7 (100)	Radial
		BS	E-3	VEL	2A	362 (248)	7 (100)	Radial
		BS	E-4	VRLS/VELS	3A	453 (310)	7 (100)	Radial
		BS	E-4	VRLS/VELS	1A	388 (266)	7 (100)	Radial
		BS	E-4	VRLS/VELS	2A	314 (215)	7 (100)	Radial
		BS	E-4	VMTS	3A	489 (335)	7 (100)	Radial
		BS	E-4	VMTS	1A	418 (286)	7 (100)	Radial
		BS	E-4	VMTS	2A	338 (232)	7 (100)	Radial
		BS	E-4	VMTS	1A	388 (266)	7 (100)	Radial
		BS	E-4	VMTS	2A	314 (215)	7 (100)	Radial
		24.00 – 35	TOYO	E-3	G-18	HR	371 (254)	5.75 (82)
TOYO			E-3	G-18	SP	327 (224)	5.75 (82)	Bias
TOYO			E-3	G-18	CR	284 (195)	5.75 (82)	Bias
TOYO			E-4	G-18ET	HR	298 (204)	5.75 (82)	Bias
TOYO			E-4	G-18ET	SP	269 (184)	5.75 (82)	Bias
TOYO			E-4	G-18ET	CR	225 (154)	5.75 (82)	Bias
TOYO			E-4	G-18ET	CE	211 (145)	5.75 (82)	Bias
24.00 R35		TOYO	E-4	T-433	HR	378 (259)	7 (100)	Radial
		TOYO	E-4	T-433	SP	284 (195)	7 (100)	Radial
		TOYO	E-4	T-433	CR	211 (145)	7 (100)	Radial
		TOYO	E-4	T-452	HR	349 (239)	7 (100)	Radial
	TOYO	E-4	T-452	SP	255 (175)	7 (100)	Radial	
	TOYO	E-4	T-452	CR	196 (134)	7 (100)	Radial	

* Tire maker BS: BRIDGESTONE
GY: GOODYEAR

- NOTE1:** (1) The TKPH in the table is the value at 38°C (100°F) an ambient temperature. (The value as of February, 2000.)
When the distance for the round trip exceeds 5 km, the tire life is governed by the travel conditions, so check with the tire maker for details of the TKPH when selecting the tires.
(2) The value for TKPH is reviewed from time to time by the tire maker, so consult the maker for the latest values.
(3) For details of the TKPH value and tire specifications for conditions not given in this table, please consult the tire maker.

NOTE2: Some tires in the above table cannot be selected for some destinations.

Tire Selection

RIGID DUMP TRUCKS

Model	Tire size	Manufacturer*	Code	Pattern	Type	TKPH (TMPH)	Inflation pressure kgf/cm ² (PSI)	Structure	
HD465-7 HD465-7E0 HD605-7E0 HD465-7R HD605-7R	24.00 – 35	YOKOHAMA	E-3	Y67	HR-H	379 (260)	5.75 (82)	Bias	
		YOKOHAMA	E-3	Y67	RE-R	314 (215)	5.75 (82)	Bias	
		YOKOHAMA	E-3	Y67	RE-T	343 (235)	5.75 (82)	Bias	
		YOKOHAMA	E-3	Y67	CP-C	277 (190)	5.75 (82)	Bias	
		YOKOHAMA	E-4	Y527	HR-H	321 (220)	5.75 (82)	Bias	
		YOKOHAMA	E-4	Y527	HR-V	353 (242)	5.75 (82)	Bias	
		YOKOHAMA	E-4	Y527	RE-R	263 (180)	5.75 (82)	Bias	
		YOKOHAMA	E-4	Y527	RE-T	292 (200)	5.75 (82)	Bias	
		YOKOHAMA	E-4	Y527	CP-S	175 (120)	5.75 (82)	Bias	
		YOKOHAMA	E-4	Y527	CP-C	226 (155)	5.75 (82)	Bias	
	24.00 R35	MICHELIN	E-3	XK	B	474 (325)	7 (100)	Radial	
		MICHELIN	E-3	XR	B	518 (355)	7 (100)	Radial	
		MICHELIN	E-4	XDT	A4	266 (182)	7 (100)	Radial	
		MICHELIN	E-4	XDT	A	326 (223)	7 (100)	Radial	
		MICHELIN	E-4	XDT	B	444 (304)	7 (100)	Radial	
		MICHELIN	E-4	XDT	C4	518 (355)	7 (100)	Radial	
		MICHELIN	E-4	XKD1	A4	207 (142)	7 (100)	Radial	
		MICHELIN	E-4	XKD1	A	266 (182)	7 (100)	Radial	
		MICHELIN	E-4	XKD1	B	385 (264)	7 (100)	Radial	
		MICHELIN	E-4	X-QUARRY		207 (142)	7 (100)	Radial	
		MICHELIN	E-4	X-QUARRY S		281 (192)	7 (100)	Radial	
		MICHELIN	E-4	XV	C	740 (507)	7 (100)	Radial	
		MICHELIN	E-4	X-HAUL		355 (243)	7 (100)	Radial	
		24.00 R35	GY	E-3	RL-3+	2S, 4S			
			GY	E-4	RL-4F	4S		7 (100)	Radial
	GY		E-4	RL-4B	4S, 6S		7 (100)	Radial	
	GY		E-4	RT-4J	4S, 6S		7 (100)	Radial	
	GY		E-4	RT-4A+	2S, 4S, 4S		7 (100)	Radial	
	HD785-7	27.00 – 49	BS	E-3	EL	3A	701 (480)	5.75 (82)	Bias
			BS	E-4	ELS	1A	409 (280)	5.75 (82)	Bias
			BS	E-4	ELS	2A	350 (240)	5.75 (82)	Bias
		27.00 R49	BS	E-3	VRL/VEL	3A	753 (516)	7 (100)	Radial
			BS	E-3	VRL/VEL	1A	644 (441)	7 (100)	Radial
BS			E-3	VRL/VEL	2A	521 (357)	7 (100)	Radial	
BS			E-4	VRLS	3A	600 (411)	7 (100)	Radial	
BS			E-4	VRLS	1A	513 (351)	7 (100)	Radial	
BS			E-4	VRLS	2A	415 (284)	7 (100)	Radial	
BS			E-4	VMTS	3A	702 (481)	7 (100)	Radial	
BS			E-4	VMTS	1A	600 (411)	7 (100)	Radial	
BS			E-4	VMTS	2A	486 (333)	7 (100)	Radial	
BS			E-4	VMTS	3A	636 (436)	7 (100)	Radial	
BS			E-4	VMTS	1A	544 (373)	7 (100)	Radial	
27.00 – 49		TOYO	E-3	G-18	HR	611 (418)	5.75 (82)	Bias	
		TOYO	E-4	G-18ET	HR	720 (493)	5.75 (82)	Bias	
		TOYO	E-4	G-18ET	SP	592 (405)	5.75 (82)	Bias	
		TOYO	E-4	G-18ET	CR	360 (210)	5.75 (82)	Bias	
		TOYO	E-4	G-18ET	CE	291 (199)	5.75 (82)	Bias	
27.00 R49		TOYO	E-4	T-432	HR	545 (373)	7 (100)	Radial	
		TOYO	E-4	T-432	SP	422 (289)	7 (100)	Radial	
		TOYO	E-4	T-432	CR	327 (224)	7 (100)	Radial	
		TOYO	E-4	T-433/T-452	HR	516 (353)	7 (100)	Radial	
		TOYO	E-4	T-433/T-452	SP	363 (269)	7 (100)	Radial	
		TOYO	E-4	T-433/T-452	CR	305 (209)	7 (100)	Radial	
27.00 R49		MICHELIN	E-3	XK	B	698 (478)	7 (100)	Radial	
		MICHELIN	E-3	XR	B	763 (523)	7 (100)	Radial	
		MICHELIN	E-4	XDT	A4	392 (268)	7 (100)	Radial	
		MICHELIN	E-4	XDT	A	480 (329)	7 (100)	Radial	
		MICHELIN	E-4	XDT	B4	567 (388)	7 (100)	Radial	
		MICHELIN	E-4	XDT	B	654 (448)	7 (100)	Radial	
		MICHELIN	E-4	XKD1/XDR	A4	305 (209)	7 (100)	Radial	
		MICHELIN	E-4	XKD1/XDR	A	392 (268)	7 (100)	Radial	
	MICHELIN	E-4	XKD1/XDR	B4	480 (329)	7 (100)	Radial		
MICHELIN	E-4	XKD1/XDR	B	567 (388)	7 (100)	Radial			

* Tire maker BS: BRIDGESTONE
GY: GOODYEAR

- NOTE1:** (1) The TKPH in the table is the value at 38°C (100°F) an ambient temperature. (The value as of February, 2000.)
When the distance for the round trip exceeds 5 km, the tire life is governed by the travel conditions, so check with the tire maker for details of the TKPH when selecting the tires.
(2) The value for TKPH is reviewed from time to time by the tire maker, so consult the maker for the latest values.
(3) For details of the TKPH value and tire specifications for conditions not given in this table, please consult the tire maker.

NOTE2: Some tires in the above table cannot be selected for some destinations.

Tire Selection

RIGID DUMP TRUCKS

Model	Tire size	Manufacturer*	Code	Pattern	Type	TKPH (TMPH)	Inflation pressure kgf/cm ² (PSI)	Structure
HD785-7	27.00 R49	GY	E-3	RL-3+	2, 4S, 6S		7 (100)	Radial
		GY	E-4	RT-4A+			7 (100)	Radial
		GY	E-4	RL-4A			7 (100)	Radial
		GY	E-4	RL-4H			7 (100)	Radial
HD1500-7	33.00 R51	BS	E-4	VMTS	3A	953 (653)	7 (100)	Radial
		BS	E-4	VMTS	1A	802 (549)	7 (100)	Radial
		BS	E-4	VMTS	2A	660 (452)	7 (100)	Radial
		BS	E-4	VMTP	1A	700 (479)	7 (100)	Radial
		BS	E-4	VMTP	2A	591 (405)	7 (100)	Radial
		BS	E-4	VRLS/VELS	3A	807 (553)	7 (100)	Radial
		BS	E-4	VRLS/VELS	1A	679 (465)	7 (100)	Radial
	33.00 R51	TOYO	E-4	T-431	HR	625 (428)	7 (100)	Radial
		TOYO	E-4	T-431	SP	582 (399)	7 (100)	Radial
		TOYO	E-4	T-431	CR	473 (324)	7 (100)	Radial
	33.00 R51	MICHELIN	E-4	XDT	A4	558 (382)	7 (100)	Radial
		MICHELIN	E-4	XDT	A	682 (467)	7 (100)	Radial
		MICHELIN	E-4	XDT	B4	806 (552)	7 (100)	Radial
		MICHELIN	E-4	XDT	B	930 (637)	7 (100)	Radial
		MICHELIN	E-4	XKD1/XDR	A	496 (340)	7 (100)	Radial
		MICHELIN	E-4	XKD1/XDR	B4	620 (425)	7 (100)	Radial
		MICHELIN	E-4	XKD1/XDR	B	744 (510)	7 (100)	Radial

* Tire maker BS: BRIDGESTONE
 GY: GOODYEAR

- NOTE1:** (1) The TKPH in the table is the value at 38°C (100°F) an ambient temperature. (The value as of February, 2000.)
 When the distance for the round trip exceeds 5 km, the tire life is governed by the travel conditions, so check with the tire maker for details of the TKPH when selecting the tires.
 (2) The value for TKPH is reviewed from time to time by the tire maker, so consult the maker for the latest values.
 (3) For details of the TKPH value and tire specifications for conditions not given in this table, please consult the tire maker.

NOTE2: Some tires in the above table cannot be selected for some destinations.

Tire Selection

RIGID DUMP TRUCKS

Model	Tire size	Manufacturer*	Code	Pattern	Type	TKPH (TMPH)	Inflation pressure kgf/cm ² (PSI)	Structure	
730E	37.00 R57	BS	E-4	VRLS/VELS	3A	1003 (687)	7 (100)	Radial	
		BS	E-4	VRLS/VELS	1A	845 (579)	7 (100)	Radial	
		BS	E-4	VRLS/VELS	2A	694 (475)	7 (100)	Radial	
		BS	E-4	VELSL	3A	1200 (822)	7 (100)	Radial	
		BS	E-4	VZTS	3A	1003 (687)	7 (100)	Radial	
		BS	E-4	VZTS	1A	845 (579)	7 (100)	Radial	
		BS	E-4	VZTS	2A	694 (475)	7 (100)	Radial	
	37.00 R57	TOYO	E-4	T-433	HR	1018 (697)	7 (100)	Radial	
		TOYO	E-4	T-433	SP	844 (578)	7 (100)	Radial	
		TOYO	E-4	T-433	CR	676 (463)	7 (100)	Radial	
	37.00 R57	MICHELIN	E-4	XKD1/XDR	A	678 (464)	7 (100)	Radial	
		MICHELIN	E-4	XKD1/XDR	B4	848 (581)	7 (100)	Radial	
		MICHELIN	E-4	XKD1/XDR	B	1018 (697)	7 (100)	Radial	
		MICHELIN	E-4	XKD1/XDR	C4	1145 (784)	7 (100)	Radial	
	830E-AC	40.00 – 57	TOYO	E-4	G-18ET	HR	948 (649)	5.75 (82)	Bias
TOYO			E-4	G-18ET	SP	693 (475)	5.75 (82)	Bias	
TOYO			E-4	G-18ET	CR	591 (405)	5.75 (82)	Bias	
40.00 – 57		YOKOHAMA	E-4	Y523	HR-H	715 (490)	5.75 (82)	Bias	
		YOKOHAMA	E-4	Y523	HR-V	788 (540)	5.75 (82)	Bias	
		YOKOHAMA	E-4	Y523	RE-R	598 (410)	5.75 (82)	Bias	
		YOKOHAMA	E-4	Y523	RE-T	657 (450)	5.75 (82)	Bias	
		YOKOHAMA	E-4	Y523	CP-S	409 (280)	5.75 (82)	Bias	
		YOKOHAMA	E-4	Y523	CP-C	511 (350)	5.75 (82)	Bias	
40.00 R57		MICHELIN	E-4	XKD1/XDR	A	768 (526)	7 (100)	Radial	
		MICHELIN	E-4	XKD1/XDR	B4	960 (658)	7 (100)	Radial	
		MICHELIN	E-4	XKD1/XDR	B	1152 (789)	7 (100)	Radial	
		MICHELIN	E-4	XKD1/XDR	C4	1296 (888)	7 (100)	Radial	
860E-1K		50/80 R57	MICHELIN	E-4	XKD1	A	922	6 (87)	Radial
			MICHELIN	E-4	XKD1	B4	1152	6 (87)	Radial
	MICHELIN		E-4	XKD1	B	1382	6 (87)	Radial	
	MICHELIN		E-5	XKD1	C4	1613	6 (87)	Radial	
	MICHELIN		E-4	XDR	B4	1168	6 (87)	Radial	
	MICHELIN		E-4	XDR	B	1285	6 (87)	Radial	
	MICHELIN		E-4	XDR	C4	1518	6 (87)	Radial	
	930E-4 930E-4SE		53/80 R63	BS	E-4	VRLS/VELS	3A	1408 (964)	7 (100)
BS		E-4		VRLS/VELS	1A	1150 (788)	7 (100)	Radial	
BS		E-4		VRLS/VELS	2A	974 (667)	7 (100)	Radial	
BS		E-4		VRLSA	3A	1512 (1036)	7 (100)	Radial	
BS		E-4		VRLSA	1A	1233 (845)	7 (100)	Radial	
BS		E-4		VRLSA	2A	1045 (716)	7 (100)	Radial	
960E-2 960E-2K		50/90 R57		BS	E-4	VELS/VRPS	E2A	884	6 (87)
	BS		E-4	VELS/VRPS	E1A	1092	6 (87)	Radial	
	BS		E-4	VELS/VRPS	E3A	1278	6 (87)	Radial	
	56/80 R63	MICHELIN	E-4	XDR	B4	1536	6 (87)	Radial	
		MICHELIN	E-4	XDR	B	1843	6 (87)	Radial	
		MICHELIN	E-4	XDR	C4	2150	6 (87)	Radial	
	59/80 R63	BS	E-4	VRDP	E2A	1160	7 (102)	Radial	
		BS	E-4	VRDP	E1A	1431	7 (102)	Radial	
		BS	E-4	VRDP	E3A	1675	7 (102)	Radial	

* Tire maker BS: BRIDGESTONE
GY: GOODYEAR

- NOTE1:** (1) The TKPH in the table is the value at 38°C (100°F) an ambient temperature. (The value as of February, 2000.) When the distance for the round trip exceeds 5 km, the tire life is governed by the travel conditions, so check with the tire maker for details of the TKPH when selecting the tires.
(2) The value for TKPH is reviewed from time to time by the tire maker, so consult the maker for the latest values.
(3) For details of the TKPH value and tire specifications for conditions not given in this table, please consult the tire maker.

NOTE2: Some tires in the above table cannot be selected for some destinations.

TIRE PATTERN

BRIDGESTONE



VELS



VRLS



VRLSA



VMTP



VZTS



VMTS



ELS2



RLS



RLS2



VEL

TOYO



G-18



G-18ET



G-36ET



T-431



T-433



T-452

4A-50

TIRE PATTERN

YOKOHAMA



Y-67



Y-523

MICHELIN



XDTA4



XDR A



X-QUARRY

GOODYEAR



HRL-3A



HRL-4B



EV-3+



GP-4C



RT-4A



GP-4B



RL-3+



RL-4J/4J II



RL-4H/4H II

1. Body selection

When selecting a dump body, it is necessary to consider the size of rocks, specific gravity of loaded materials, loading machine types, etc.

The chart below shows how to select the optimum dump body.

If similar dump trucks are working at specific job sites, check the dump body types used there to help make selection.

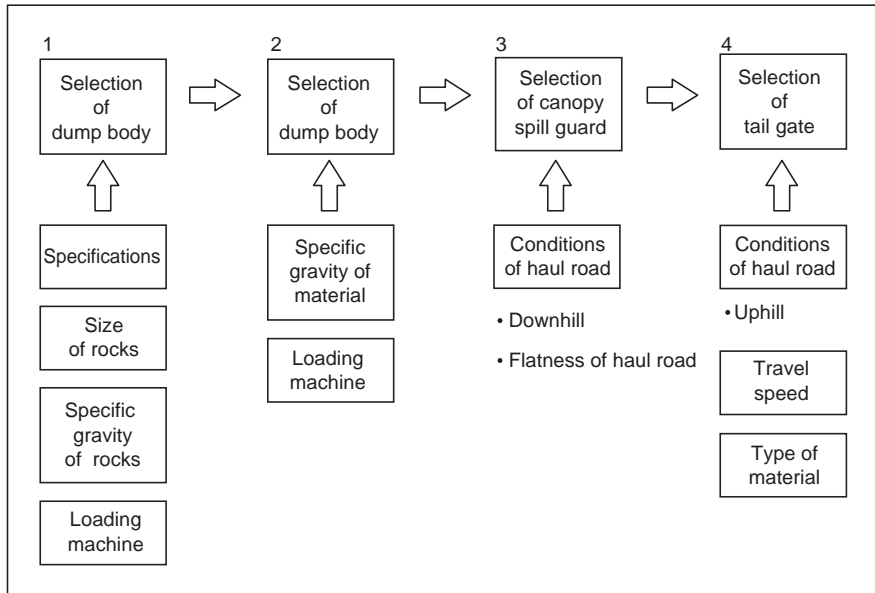

2. Features of each dump body

1) Liner-less body

[Features]

- The standard dump body is suitable for job sites where soil and sand is loaded. However, attach liners in advance for job sites where excessive wear is expected.
- Liners are not preinstalled.

[Application]

- Hauling of soil and sand.

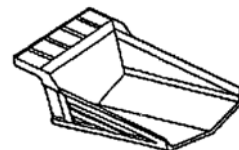

2) Rock body

[Features]

- The rock dump body is suitable for loading blasted rock in quarries, limestone mines, civil engineering sites, etc.
- The entire surface of inner dump body is lined steel liners.

[Application]

- Hauling rocks



			Liner-less body	Rock body
Body selection point	Durability of body		○	◎
	Operator comfort at loading		○	○
Propriety by loading machines	Wheel loader	Standard for size of rocks	Shock	○
			Noise	○
			Below 0.5 m or 0.16 ton	●
	Hydraulic excavator		Below 1.0 m or 1.3 ton	X
			Below 1.5 m or 4.4 ton	X
			Below 0.5 m or 0.16 ton	●
		Below 1.0 m or 1.3 ton	▲	
		Below 1.5 m or 4.4 ton	X	
			▲	

Remarks ○ : Ordinary ◎ : Excellent
 ● : Best X : Prohibited
 ▲ : Possible when loading height is lower than body top end.

3) Dump body for quarry (standard)

[Features]

- Large capacity dump body with increased strength is suitable for quarries.
- Ultra hard wear-resistant steel plate is employed for increased hardness.
- Suitable for job sites where the liner replacement interval is longer than 12,000 hours.

[Application]

- Hauling of limestone
- Hauling of soil and sand
- Hauling of soil containing rock

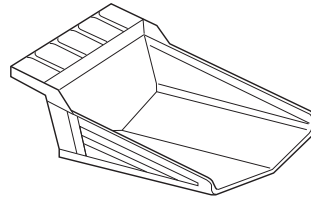

FVBH0491

4) Dump body with full liners (except sides) for quarry (option)

[Features]

- Suitable for job sites where the principal work is hauling of rock and the liner replacement interval is shorter than 8,000 hours.

[Application]

- Hauling of small to medium size rock (1 m (3'3") maximum)
- Hauling of rock that is hard to crush

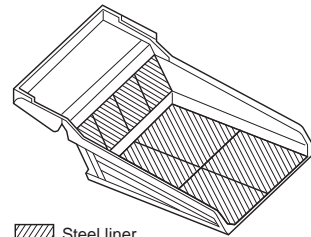

FVBH0493

3. Available body

Model			HD255-5	HD325-7R, HD325-7, HD325-6		HD405-7, HD405-6, HD405-7R
Body type			Standard body	Standard body	Rock body (OP)	Quarry body
Liner	Steel liner	Rock type	—	○	●	—
		Liner (option)	—	○	○	—
Body extension		200mm (7.9")	—	○	○	X
Canopy spill guard		150mm (5.9")	—	○	○	○
		250mm (9.8")	—	○	○	○

Model			HD465-7E0, HD465-7 HD465-7R		HD605-7E0, HD605-7R
Body type			Standard body	Rock body (OP)	Quarry body
Liner	Steel liner	Rock type	○	●	—
		Liner (option)	—	—	○
Body extension		200mm (7.9")	○	○	X
Canopy spill guard		150mm (5.9")	●	●	●
		200mm (7.9")	—	—	—
		250mm (9.8")	—	—	—
		300mm (11.8")	○	○	○

Model		HD785-7			
Body type			Standard body	Rock body (OP)	Light weight body (OP)
Liner	Steel liner	Rock type	○	●	—
		Liner	—	—	—
Body extension		200mm (7.9")	○	○	○
Canopy spill guard		200mm (7.9")	●	●	●
		300mm (11.8")	○	○	○

Remarks ● :Standard equipment for applicable body
 ○ :Optionally available
 x :Installation prohibited
 — :Not available
 * :Mini tailgate

4. Liner thickness of rock body and weight

HD325-7R/HD325-7/HD325-6

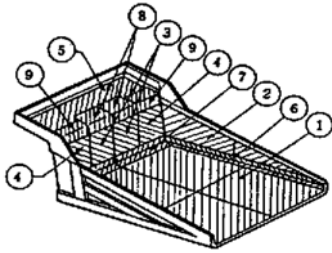

 : Steel liner

No.	Part	Plate thickness mm (in)
1	Bottom plate	19 (0.75)
2	Side plate	12 (0.47)
3	Front plate (center)	16 (0.63)
4	Front plate (side)	12 (0.47)
5	Canopy top plate	9 (0.35)
6	Corner (bottom-side)	12 (0.47)
7	Corner (bottom-front)	12 (0.47)
8	Canopy corner (center)	16 (0.63)
9	Canopy corner (side)	12 (0.47)
Liner weight kg (lb)		4235 (9,340)

HD405-7R/HD405-7/HD405-6 Liner (Option)

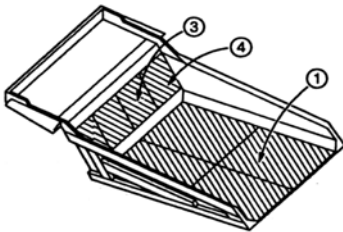

 : Steel liner

No.	Part	Plate thickness mm (in)
1	Bottom plate	14 (0.55)
2	Side plate	—
3	Front plate (center)	14 (0.55)
4	Front plate (side)	14 (0.55)
5	Canopy top plate	—
6	Corner (bottom-side)	—
7	Corner (bottom-front)	—
8	Canopy corner (center)	—
9	Canopy corner (side)	—
Liner weight kg (lb)		2070 (4,560)

HD465-7R/HD465-7E0/HD465-7

Rock body with 200 mm (7.9") body extension

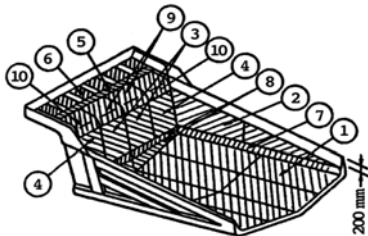

 : Steel liner

No.	Part	Plate thickness mm (in)
1	Bottom plate	19 (0.75)
2	Side plate	12 (0.47)
3	Front plate (center)	16 (0.63)
4	Front plate (side)	12 (0.47)
5	Canopy top plate	9 (0.35)
6	Canopy top plate (front)	6 (0.24)
7	Corner (bottom-side)	12 (0.47)
8	Corner (bottom-front)	12 (0.47)
9	Canopy corner (center)	16 (0.63)
10	Canopy corner (side)	12 (0.47)
Liner weight kg (lb)		5950 (13,120)

HD605-7R/HD605-7E0 Liner (Option)

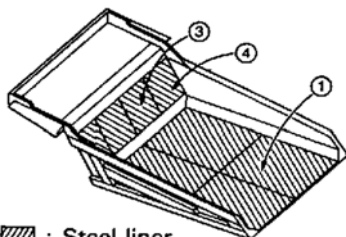

 : Steel liner

No.	Part	Plate thickness mm (in)
1	Bottom plate	14 (0.55)
2	Side plate	—
3	Front plate (center)	14 (0.55)
4	Front plate (side)	14 (0.55)
5	Canopy top plate	—
6	Corner (bottom-side)	—
7	Corner (bottom-front)	—
8	Canopy corner (center)	—
9	Canopy corner (side)	—
Liner weight kg (lb)		2610 (5,750)

HD785-7
Rock body

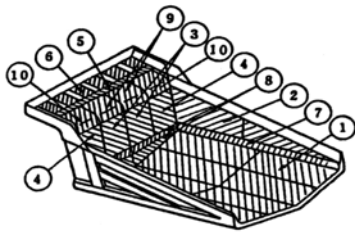

 : Steel liner

No.	Part	Plate thickness mm (in)
1	Bottom plate	19 (0.75)
2	Side plate	12 (0.47)
3	Front plate (center)	16 (0.63)
4	Front plate (side)	12 (0.47)
5	Canopy top plate	9 (0.35)
6	Canopy top plate (front)	6 (0.24)
7	Corner (bottom-side)	12 (0.47)
8	Corner (bottom-front)	12 (0.47)
9	Canopy corner (center)	16 (0.63)
10	Canopy corner (side)	12 (0.47)
Liner weight kg (lb)		7895 (17,405)

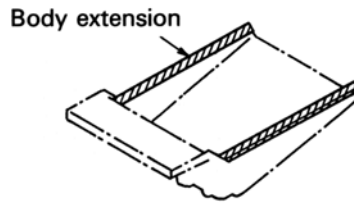

5. Body extension selection

Body extension and specifications

Extension	Item	HD255-5	HD325-7R HD325-7 HD325-6	HD405-7R HD405-7 HD405-6	HD465-7R HD465-7E0 HD465-7	HD605-7R HD605-7E0
Without body extension	Body capacity m ³ Struck/heaped (yd ³)	13.2/17.7 (17.3/23.2)	18.0/24.0 (23.5/31.4)	20.0/27.3 (26.2/35.7)	25.0/34.2 (32.7/44.7)	29.0/40.0 (37.9/52.3)
	Loading height mm (ft.in)	2975 (9'9")	3200 (10'6")	3430 (11'3")	3600 (11'10")	3860 (12'8")
200 mm (7.9")	Body capacity m ³ Struck/heaped (yd ³)	—	20.0/27.0 (26.2/35.3)	—	*29.0/37.5 (37.9/49.1)	—
	Loading height mm (ft.in)	—	3400 (11'2")	—	3800 (12'6")	—
Installed tire size		16.00-25	18.00-33	18.00-R33	24.00-35	24.00-R35

Extension	Item	HD785-7				
Without body extension	Body capacity m ³ Struck/heaped (yd ³)	40.0/60.0 (52.3/78.5)				
	Loading height mm (ft.in)	4285 (14'1")				
200 mm (7.9")	Body capacity m ³ Struck/heaped (yd ³)	46.0/66.0 (60.2/86.3)				
	Loading height mm (ft.in)	4485 (14'9")				
Installed tire size		27.00-R49				

Remarks *:Standard equipment for HD465-7 rock body

Body extension selection table

HD325-6, HD325-7, HD325-7R

		Body capacity m ³ (ys ³)	Specific gravity (Loose condition)																			
			1.0	1.1	1.2	1.3	1.4	1.5	1.6	1.7	1.8	1.9	US ton/m ³									
			0.9	1.0	1.1	1.2	1.3	1.4	1.5	1.6	1.7	1.8	1.9	ton/m ³								
Standard body		24.0 (31.4)																				
Extension	200 mm (7.9")	27.0 (35.3)																				

HD465-7, HD465-7E0, HD465-7R

		Body capacity m ³ (ys ³)	Specific gravity (Loose condition)																			
			1.0	1.1	1.2	1.3	1.4	1.5	1.6	1.7	1.8	1.9	US ton/m ³									
			0.9	1.0	1.1	1.2	1.3	1.4	1.5	1.6	1.7	1.8	1.9	ton/m ³								
Standard body		34.2 (44.7)																				
Extension	200 mm (7.9")	37.5 (49.1)																				

HD785- 7

		Body capacity m ³ (ys ³)	Specific gravity (Loose condition)																			
			1.0	1.1	1.2	1.3	1.4	1.5	1.6	1.7	1.8	1.9	US ton/m ³									
			0.9	1.0	1.1	1.2	1.3	1.4	1.5	1.6	1.7	1.8	1.9	ton/m ³								
Standard body		60 (78.5)																				
Extension	200 mm (7.9")	66 (86.3)																				

FVBH0269

6. Canopy spill guard selection

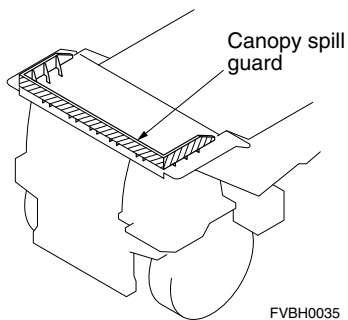

Canopy spill guards and specifications

Hight of additional spill guard to STD	Model		HD255-5	HD325-7R HD325-7 HD325-6	HD405-7R HD405-7 HD405-6	HD465-7R HD465-7E0 HD465-7	HD605-7R HD605-7E0	HD785-7
	Item							
	Standard spill guard height	mm (ft.in)	30 (1.1")	40 (1.6")	40 (1.6")	180 (7.1")	180 (7.1")	200 (7.9")
	Mounting method	—	Welded	Welded	Welded	Welded	Welded	Welded
	Over all height	mm (ft.in)	3625 (11'11")	4000 (13'2")	4000 (13'2")	4400 (14'5")	4400 (14'5")	5050 (16'7")
150 mm (5.9")	Mounting method	—	Bolt-on	Bolt-on	Bolt-on	—	—	—
	Over all height	mm (ft.in)	3775 (12'5")	4150 (13'7")	4150 (13'7")	—	—	—
250 mm (9.8")	Mounting method	—	Bolt-on	Bolt-on	Bolt-on	—	—	—
	Over all height	mm (ft.in)	3875 (12'7")	4250 (13'11")	4250 (13'11")	—	—	—
300 mm (11.8")	Mounting method	—	—	—	—	Welded	Welded	Welded
	Over all height	mm (ft.in)	—	—	—	4300 (14'1")	4300 (14'1")	5350 (17'7")

TRAVEL TIME (One way)

UNIT: MIN.

DISTANCE ONE WAY		AVERAGE TRAVEL SPEED KM/HR (MPH)											
		5	10	15	20	25	30	35	40	45	50	55	60
METERS	FEET	(3.1)	(6.2)	(9.3)	(12.4)	(15.5)	(18.6)	(21.7)	(24.9)	(28.0)	(31.1)	(34.2)	(37.3)
50	160	0.60	0.30	0.20	0.15	0.12	0.10	0.09	0.88	0.07	0.06	0.05	0.05
100	330	1.20	0.60	0.40	0.30	0.24	0.20	0.17	0.15	0.13	0.12	0.11	0.10
200	660	2.40	1.20	0.80	0.60	0.48	0.40	0.34	0.30	0.27	0.24	0.22	0.20
300	980	3.60	1.80	1.20	0.90	0.72	0.60	0.51	0.45	0.40	0.36	0.33	0.30
500	1640	6.00	3.00	2.00	1.50	1.20	1.00	0.86	0.75	0.67	0.60	0.55	0.50
1000	3280	12.00	6.00	4.00	3.00	2.40	2.00	1.71	1.50	1.33	1.20	1.09	1.00
1500	4920	18.00	9.00	6.00	4.50	3.60	3.00	2.57	2.25	2.00	1.80	1.64	1.50
2000	6560	24.00	12.00	8.00	6.00	4.80	4.00	3.43	3.00	2.67	2.40	2.18	2.00
3000	9840	36.00	18.00	12.00	9.00	7.20	6.00	5.14	4.50	4.00	3.60	3.27	3.00
5000	16410	60.00	30.00	20.00	15.00	12.00	10.00	8.57	7.50	6.67	6.00	5.45	5.00

Cycle time = Loading time + Hauling time + Dumping time + Return time + Spot & delay time

- Determine hauling and return time from the above table respectively.
- Loading time = (Loader cycle time) × (No. of cycles to fill dump truck)
- Average fixed time (dumping, spot & delay): 1.25 ~ 1.65 min.

Estimated Production (Metric ton per hour)

ESTIMATED CYCLE TIME (MIN.)	PAYLOAD (METRIC TON)									
	18	20	32	46	68	78	120	160	180	
3	360	400	640	920	1360	1560	2400	3200	3600	
6	180	200	320	460	680	780	1200	1600	1800	
9	120	133	213	307	453	520	800	1067	1200	
12	90	100	160	230	340	390	600	800	900	
15	72	80	128	184	272	312	480	640	720	
18	60	67	107	153	227	260	400	533	600	
21	51	57	91	131	194	223	343	457	514	
24	45	50	80	115	170	195	300	400	450	
27	40	44	71	102	151	173	267	356	400	
30	36	40	64	92	136	156	240	320	360	
35	31	34	55	79	117	134	206	274	309	
40	27	30	48	69	102	117	180	240	270	
45	24	27	43	61	91	104	160	213	240	
50	22	24	38	55	82	94	144	192	196	
55	20	22	35	50	74	85	131	175	196	
60	18	20	32	46	68	78	120	160	180	

* Actual production =

(Estimated production) × (Job efficiency)

Job efficiency (E)

Operation conditions	E
Good	0.83
Average	0.80
Rather poor	0.75
Poor	0.70

Estimated Production (U.S ton per hour)

ESTIMATED CYCLE TIME (MIN.)	PAYLOAD (U.S. TON)									
	20	22	35	51	75	86	132	176	198	
3	400	440	700	1020	1500	1720	2640	3520	3960	
6	200	220	350	510	750	860	1320	1760	1980	
9	133	147	233	340	500	573	880	1173	1320	
12	100	110	175	255	375	430	660	880	990	
15	80	88	140	204	300	344	528	704	792	
18	67	73	117	170	250	287	440	587	660	
21	57	63	100	146	214	246	377	503	566	
24	50	55	88	128	188	215	330	440	495	
27	44	49	78	113	167	191	293	391	440	
30	40	44	70	102	150	172	264	352	396	
35	34	38	60	87	129	147	226	302	339	
40	30	33	53	77	113	129	198	264	297	
45	27	29	47	68	100	115	176	235	264	
50	24	26	42	61	90	103	158	211	238	
55	22	24	38	56	82	94	144	192	216	
60	20	22	35	51	75	86	132	176	198	

SECTION **4B**

ARTICULATED DUMP TRUCKS

CONTENTS

Features 4B-2

Specifications 4B-7

Dimensions 4B-9

Use of Performance Curve 4B-11

Performance Curves:

HM300-3 4B-12

HM300-2, HM300-2R 4B-13

HM300-1 4B-14

HM350-2, HM350-2R 4B-15

HM350-1 4B-16

HM400-3 4B-17

HM400-2, HM400-2R 4B-18

HM400-1 4B-19

Ground Pressure 4B-20

Tire Selection 4B-23

Body Selection 4B-26

Ecology Features

EPA Tier 4 Interim and EU Stage 3B emissions certified engine

NOTE: For details, see the page of engine features (Section 11)
(HM300-3, HM400-3)

ecot3 (EPA Tier 3, EU Stage 3A certified engine)

Komatsu develops and produces all major components, such as engines, electronics and hydraulic components in house.

With this "Komatsu Technology", and adding customer feedback, Komatsu is achieving great advancements in technology.

To achieve high levels of productivity and ecology, Komatsu developed the main components with an advanced control system.

The result is a new generation of high performance and environment friendly machines.

(HM250-2, HM300-2, HM350-2 and HM400-2)



Fuel efficient electronic controlled engine

The engine is EPA Tier 3 and EU Stage 3A emission regulation certified. The engine is turbocharged and features Common Rail Injection System (CRI) and air-to-air aftercooling to maximize power, fuel efficiency and emission compliance.

To minimize noise and vibration, the engine is mounted to the main frame with rubber cushions.

(HM250-2, HM300-2, HM350-2 and HM400-2)

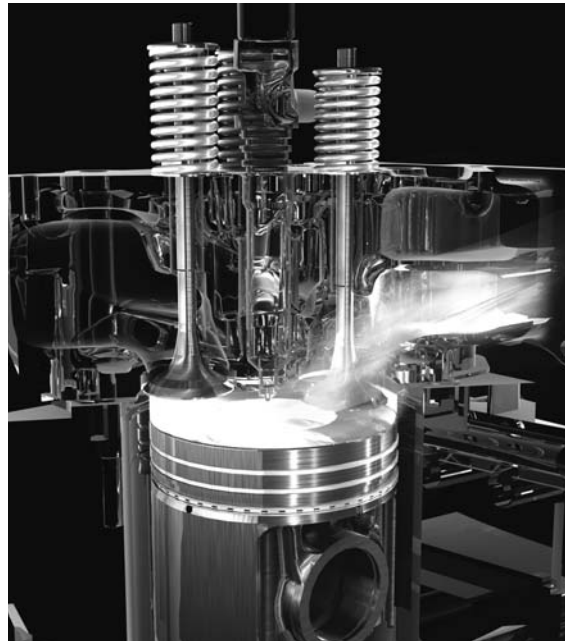

■ Comfortable operator environment

• Wide, Spacious Cab

The wide cab provides a comfortable space for the operator and a full size buddy seat. Large, electrically operated windows and the operator's seat positioned to the left side ensure superior visibility.

• Ergonomically Designed Cab

The ergonomically designed operator's compartment makes it very easy and comfortable for the operator to use all the controls.

• Viscous Cab Mounts

Viscous mounts reduce the noise transmitted to the cab and achieve a quiet noise level.

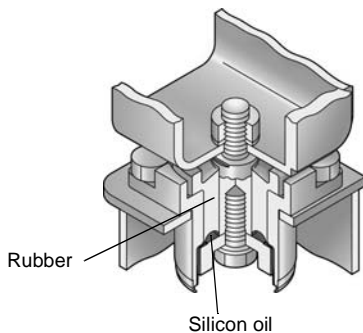

■ Easy maintenance

• Tilttable cab

The cab can be tilted rearward to provide easy maintenance/service for the engine and transmission.



• Extended Service Intervals

In order to minimize operating costs service intervals have been extended.

- Engine oil: 500 hours
- Transmission oil: 1000 hours
- Engine & transmission filters: 500 hours

• Hydropneumatic Suspension for All Terrain

The hydropneumatic suspension assures a comfortable ride even over rough terrain and ensures maximum productivity and operator confidence.

• Air Suspension Seat

The air suspension fabric covered seat which is adjustable to the operator's weight is provided as standard.

• Electric Body Dump Control Lever

The extra light lever makes dumping easier than ever.

• Supplementary Steering and Secondary Brakes

Supplementary steering and secondary brakes are standard features.

• Easy-to-See Instrument Panel

The instrument panel makes it easy to monitor critical machine functions. In addition a caution light warns the operator of any problems that may occur. Problems are recorded in the monitor and indicated as service codes.

This makes the machine very friendly and easy to service.

• Steering Wheel and Pedals

Low effort pedals reduce driver fatigue when working continuously for long periods. The tiltable, telescoping steering column enables operators to maintain the optimum driving position at all times.

• Fewer Grease Points

We have minimized the number of grease points by using maintenance-free rubber bushings and a lubrication-free oscillating hitch.

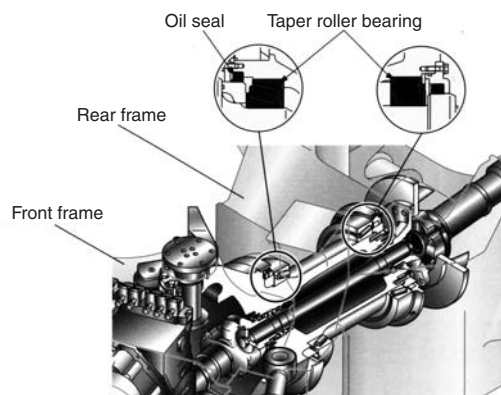

■ **High productivity**

● **High performance SAA6D125E-3 and SAA6D140E-3 Komatsu engines**

- Those engine delivers faster acceleration and higher travel speeds with the highest horsepower per ton in its class.
- The engines meets the USA EPA Tier 2 emission regulations.
- High torque at low speed, impressive acceleration and low fuel consumption ensure maximum productivity. (HM300-1, HM350-1 and HM400-1)

● **Interaxle & differential locking systems**

The full-time six-wheel drive system reduces slippage. A wet multiple-disc interaxle clutch also locks the three axles in unison for greater traction. The interaxle lock and differential locks can be switched on and off while the truck is traveling, thereby boosting productivity.

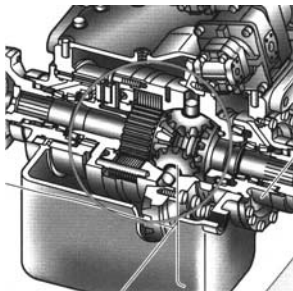

● **Komatsu designed electronically controlled transmission**

Komatsu designed Electronically Controlled transmission called K-ATOMiCS has been successfully employed in Komatsu's rigid dump trucks. The electronic clutch modulation system ensures proper clutch pressure when the clutch is engaged. The total control system controls both the engine and transmission by monitoring the vehicle conditions. This high technology system assures smooth shifts without shock.

● **Hydropneumatic suspension**

The hydropneumatic suspension has been proven on Komatsu's rigid dump trucks. The front axle suspension employs "De Dion" type design, allowing the machine to ride more smoothly over bumps. The rear-axles are mounted on a dynamic equalizer structure equipped with hydropneumatic suspension.

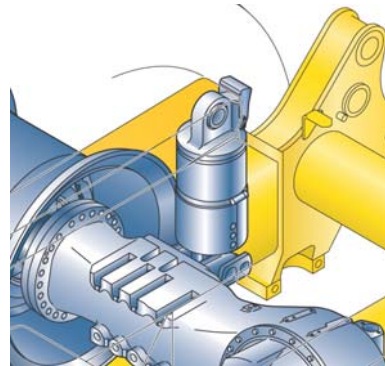

● **Large capacity body and box section frame structure**

The body is built of thick wear-resistant steel with a Brinell hardness of 400, and the body shape provides excellent load stability.

● **Articulated steering**

Fully hydraulic articulated steering offers low-effort operating performance and maneuverability. Small minimum turning radius provides the freedom to move about in confined areas.

● **Fully hydraulically controlled Wet multiple-disk brakes and retarder**

Wet multiple-disk brakes have been proven on Komatsu dump trucks and wheel loaders. They ensure highly reliable and stable brake performance. The large-capacity wet-multiple disk brakes also function as a highly responsive retarder which gives the operator great confidence while traveling downhill.

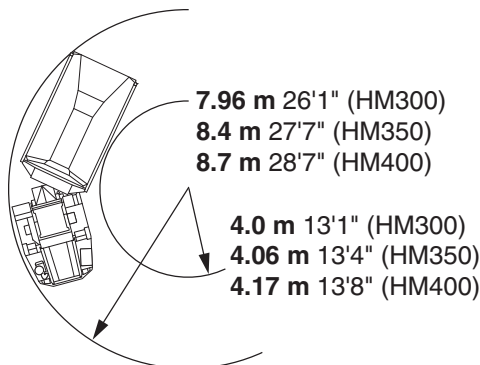

■ Information & communication technology

● ECO guidance

The energy saving operation is supported by "ECO Guidance" in real time.

This new model is equipped advanced ICT (Information & Communication Technology) devices such as multiple-purpose color monitor panel, which also provide the operator with energy saving machine operation guidance.



ECO guidance

● ECO gauge

The ECO gauge indicates the fuel consumption rate at the moment during operation.

Operating the machine by keeping the gauge within the green zone leads to the energy-saving operation.

* Fuel consumption rate depends on the work load and accelerator pedal operation.



ECO gauge

Fuel consumption gauge

● Energy saving operation guide & report

The operator can check the operation record, ECO Guidance record, and fuel consumption record.

The Operation Records indicates today's operation status of the machine.

The ECO Guidance Records displays the number of occurrences of each guidance message. During operation, it is requested to reduce the number of occurrences of each guidance message in order to achieved energy-saving operation.

The Average Fuel Consumption Logs graph the fuel consumption for recent 12 hours (based on service meter reading) and daily fuel consumption in the previous one week.



Average fuel consumption logs

■ Machine monitor

The machine monitor display various machine information and allows for various settings of the machine.

The LCD unit is a 7-inch color TFT-LCD and displays maintenance information, operation record, ECO guidance record, etc.

The switch panel is used to select various LCD unit screens and the air conditioner control screen.

By using the switch panel, you can display various user menus on the LCD unit screen and perform the settings of the machine.

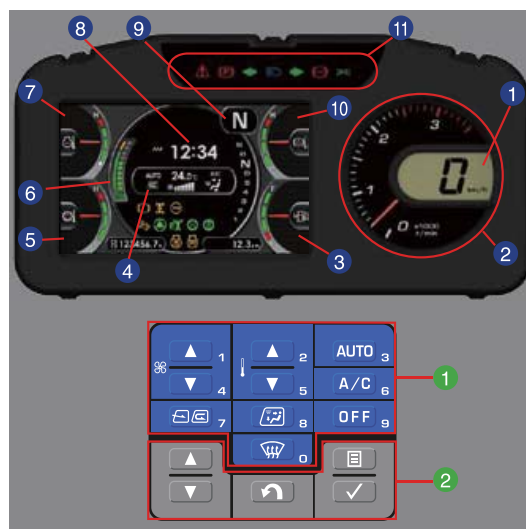

Machine monitor

- | | |
|--|-----------------------------------|
| 1 Speed meter | 7 Engine water temperature gauge |
| 2 Engine tachometer | 8 Time display |
| 3 Fuel gauge | 9 Shift indicator |
| 4 Air conditioner display | 10 Retarder oil temperature gauge |
| 5 Torque converter oil temperature gauge | 11 LED indicator |
| 6 ECO gauge | |

Switch panel

- | | |
|--|---------------------|
| 1 Air conditioner switches / Numeral key pad | 2 Function switches |
|--|---------------------|

(HM300-3, HM400-3)

■ Safety features

● **Komatsu traction control system (KTCS)**

Komatsu has developed various shoe/wheel slip control technologies including Shoe Slip Control (SSC) system for bulldozers, Automatic Spin Regulator (ASR) for rigid type off-highway dump trucks, etc. These technologies are refined and combined with newly developed slip control technologies for articulated dump trucks to produce the evolutionally-advanced traction control system.

New traction control system allows easy traveling on soft ground and slippery road only by operating the accelerator. This also provides much better turning performance than the conventional differential lock-up or the Limited Slip Differential (LSD).

(HM300-3, HM400-3)

● **Access safety**

A spike type hubby-faced antiskid plate is used for boarding the HM300-3/HM400-3. A guard rail around the engine hood has been added.

● **Short nose**

New layout of the cooling system allows for a shorter nose shape compared to the previous model increasing the field of view to the operator.

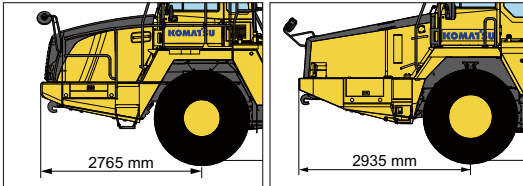
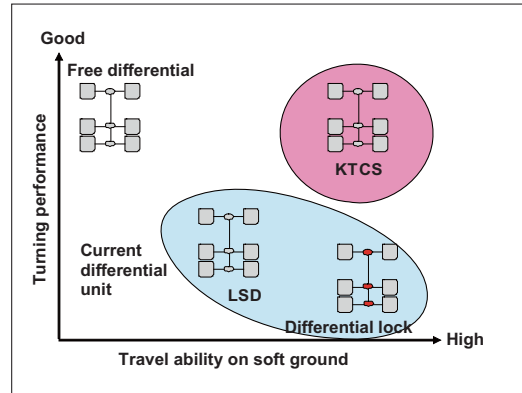

HM300-3

HM300-2

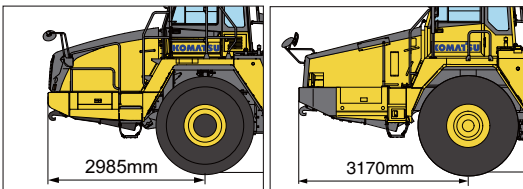

HM400-3

HM400-2



● **Color rear view camera and monitor**

The new color rear view camera & monitor are equipped as standard.

Specifications

ARTICULATED DUMP TRUCKS

Item		Model	◉HM300-3	●HM300-2	HM300-2R
WEIGHT:		kg (lb)			
Empty vehicle weight*			24910 (54,920)	24040 (53,000)	24040 (53,000)
Distribution (front)			14200 (31,310)	13414 (29,570)	13414 (29,570)
(center)			5730 (12,630)	5673 (12,510)	5673 (12,510)
(rear)			4980 (10,980)	4953 (10,920)	4953 (10,920)
Gross vehicle weight			52990 (116,820)	51420 (113,360)	51420 (113,360)
Distribution (front)			15370 (33,880)	15580 (34,350)	15580 (34,350)
(center)			19340 (42,640)	18150 (40,010)	18150 (40,010)
(rear)			18280 (40,300)	17690 (39,000)	17690 (39,000)
Gross horsepower		kW (HP)/RPM	248 (332)/2000	254 (340)/2000	254 (340)/2000
Net horsepower		kW (HP)/RPM	242 (324)/2000	246 (329)/2000	246 (329)/2000
HAULING CAPACITY:					
Maximum payload		m. ton (U.S. ton)	28.0 (31)	27.3 (30.1)	27.3 (30.1)
Heaped capacity (2:1)		m ³ (yd ³)	17.1 (22.4)	16.6 (21.7)	16.6 (21.7)
PERFORMANCE:					
Maximum speed		km/h (MPH)	58.6 (36.4)	58.6 (36.4)	58.6 (36.4)
Turning radius		m (ft.in)	8.1 (26'7")	7.96 (26'1")	7.96 (26'1")
ENGINE:					
Model			KOMATSU SAA6D125E-6	KOMATSU SAA6D125E-5	KOMATSU SAA6D125E-5
No. of cylinders- bore × stroke		mm (in)	125 × 150 (4.92 × 5.91)	6-125 × 150 (4.92 × 5.91)	6-125 × 150 (4.92 × 5.91)
Displacement		ltr. (in ³)	11.04 (674)	11.04 (674)	11.04 (674)
DIMENSION:			See DIMENSIONS		
TIRES:					
Front tire			23.5 R25 × 2	23.5 R25 × 2	23.5 R25 × 2
Center tire			23.5 R25 × 2	23.5 R25 × 2	23.5 R25 × 2
Rear tire			23.5 R25 × 2	23.5 R25 × 2	23.5 R25 × 2
CAPACITY:Fuel tank		ltr. (U.S. Gal)	388.3 (102.6)	384 (101.5)	384 (101.5)

* Weight includes lubricants, coolant, full fuel tank and standard body.

Item		Model	HM300-1	●HM350-2	HM350-2R
WEIGHT:		kg (lb)			
Empty vehicle weight*			22500 (49,600)	31060 (68,470)	31060 (68,470)
Distribution (front)			12770 (28,150)	17828 (39,300)	17828 (39,300)
(center)			5000 (11,020)	6709 (14,790)	6709 (14,790)
(rear)			4730 (10,430)	6523 (14,380)	6523 (14,380)
Gross vehicle weight			49875 (109,950)	63440 (139,860)	63440 (139,860)
Distribution (front)			14860 (10710)	20174 (44,480)	20174 (44,480)
(center)			17805 (39,250)	21696 (47,830)	21696 (47,830)
(rear)			17210 (37,940)	21570 (47,550)	21570 (47,550)
Gross horsepower		kW (HP)/RPM	250 (335)/2000	304 (408)/2000	304 (408)/2000
Net horsepower		kW (HP)/RPM	242 (324)/2000	294 (394)/2000	294 (394)/2000
HAULING CAPACITY:					
Maximum payload		m. ton (U.S. ton)	27.3 (30.1)	32.3 (35.6)	32.3 (35.6)
Heaped capacity (2:1)		m ³ (yd ³)	16.6 (21.7)	19.8 (25.9)	19.8 (25.9)
PERFORMANCE:					
Maximum speed		km/h (MPH)	59.0 (36.7)	57.1 (35.5)	57.1 (35.5)
Turning radius		m (ft.in)	7.96 (26'1")	8.6 (28'3")	8.6 (28'3")
ENGINE:					
Model			KOMATSU SAA6D125E-3	KOMATSU SAA6D140E-5	KOMATSU SAA6D140E-5
No. of cylinders- bore × stroke		mm (in)	6-125 × 150 (4.92 × 5.91)	6-140 × 165 (5.51 × 6.50)	6-140 × 165 (5.51 × 6.50)
Displacement		ltr. (in ³)	11.04 (674)	15.24 (930)	15.24 (930)
DIMENSION:			See DIMENSIONS		
TIRES:					
Front tire			23.5 R25 × 2	26.5 R25 × 2	26.5 R25 × 2
Center tire			23.5 R25 × 2	26.5 R25 × 2	26.5 R25 × 2
Rear tire			23.5 R25 × 2	26.5 R25 × 2	26.5 R25 × 2
CAPACITY:Fuel tank		ltr. (U.S. Gal)	382 (100.9)	493 (130.3)	493 (130.3)

* Weight includes lubricants, coolant, full fuel tank and standard body.

- EPA Tier 3 and EU Stage 3A model
- ◉ EPA Tier 4 Interim and EU Stage 3B model

Specifications

ARTICULATED DUMP TRUCKS

Item		Model	HM350-1	◉HM400-3	•HM400-2
WEIGHT:		kg (lb)			
Empty vehicle weight*			28550 (62,940)	33660 (74,210)	32460 (71,560)
Distribution (front)			15850 (34,920)	18990 (41,870)	17885 (39,430)
(center)			6350 (14,000)	7570 (16,690)	7400 (16,310)
(rear)			6350 (14,000)	7100 (15,650)	7175 (15,820)
Gross vehicle weight			60925 (134,320)	73740 (162,570)	69040 (152,210)
Distribution (front)			18545 (40,880)	21680 (47,800)	20022 (44,140)
(center)			21190 (46,720)	26100 (57,540)	24647 (54,340)
(rear)			21190 (46,720)	25960 (57,230)	24371 (53,730)
Gross horsepower		kW (HP)/RPM	298 (399)/2000	353 (473)/2000	338 (453)/2000
Net horsepower		kW (HP)/RPM	290 (389)/2000	350 (469)/2000	327 (438)/2000
HAULING CAPACITY:					
Maximum payload		m. ton (U.S. ton)	32.3 (35.6)	40 (44.1)	36.5 (40.0)
Heaped capacity (2:1)		m ³ (yd ³)	19.8 (25.9)	24.0 (31.4)	22.3 (29.2)
PERFORMANCE:					
Maximum speed		km/h (MPH)	57.0 (35.4)	55.9 (34.7)	58.5 (36.4)
Turning radius		m (ft.in)	8.4 (27'7")	8.8 (28'10")	8.7 (28'7")
ENGINE:					
Model			KOMATSU SAA6D140E-3	KOMATSU SAA6D140E-6	KOMATSU SAA6D140E-5
No. of cylinders- bore × stroke		mm (in)	6-140 × 165 (5.51 × 6.50)	140 × 165 (5.51 × 6.50)	6-140 × 165 (5.51 × 6.50)
Displacement		ltr. (in ³)	15.24 (930)	15.24 (930)	15.24 (930)
DIMENSION:			See DIMENSIONS		
TIRES:					
Front tire			26.5 R25 × 2	29.5 R25 × 2	29.5 R25 × 2
Center tire			26.5 R25 × 2	29.5 R25 × 2	29.5 R25 × 2
Rear tire			26.5 R25 × 2	29.5 R25 × 2	29.5 R25 × 2
CAPACITY:Fuel tank		ltr. (U.S. Gal)	495 (130.8)	518 (137)	493 (130.3)

Item		Model	HM400-2R	HM400-1	
WEIGHT:		kg (lb)			
Empty vehicle weight*			32460 (71,560)	30300 (66,800)	
Distribution (front)			17885 (39,430)	16790 (37,020)	
(center)			7400 (16,310)	6755 (14,890)	
(rear)			7175 (15,820)	6755 (14,890)	
Gross vehicle weight			69040 (152,210)	66875 (147,430)	
Distribution (front)			20022 (44,140)	19055 (42,010)	
(center)			24647 (54,340)	23910 (51,120)	
(rear)			24371 (53,730)	23910 (51,120)	
Gross horsepower		kW (HP)/RPM	338 (453)/2000	331 (444)/2000	
Net horsepower		kW (HP)/RPM	327 (438)/2000	321 (430)/2000	
HAULING CAPACITY:					
Maximum payload		m. ton (U.S. ton)	36.5 (40.0)	36.5 (40)	
Heaped capacity (2:1)		m ³ (yd ³)	22.3 (29.2)	22.3 (29.2)	
PERFORMANCE:					
Maximum speed		km/h (MPH)	58.5 (36.4)	58.6 (36.4)	
Turning radius		m (ft.in)	8.7 (28'7")	8.7 (28'7")	
ENGINE:					
Model			KOMATSU SAA6D140E-5	KOMATSU SAA6D140E-3	
No. of cylinders- bore × stroke		mm (in)	6-140 × 165 (5.51 × 6.50)	6-140 × 165 (5.51 × 6.50)	
Displacement		ltr. (in ³)	15.24 (930)	15.24 (930)	
DIMENSION:			See DIMENSIONS		
TIRES:					
Front tire			29.5 R25 × 2	29.5 R25 × 2	
Center tire			29.5 R25 × 2	29.5 R25 × 2	
Rear tire			29.5 R25 × 2	29.5 R25 × 2	
CAPACITY:Fuel tank		ltr. (U.S. Gal)	493 (130.3)	495 (130.8)	

* Weight includes lubricants, coolant, full fuel tank and standard body.

- EPA Tier 3 and EU Stage 3A model
- ◉ EPA Tier 4 Interim and EU Stage 3B model

Dimensions

ARTICULATED DUMP TRUCKS

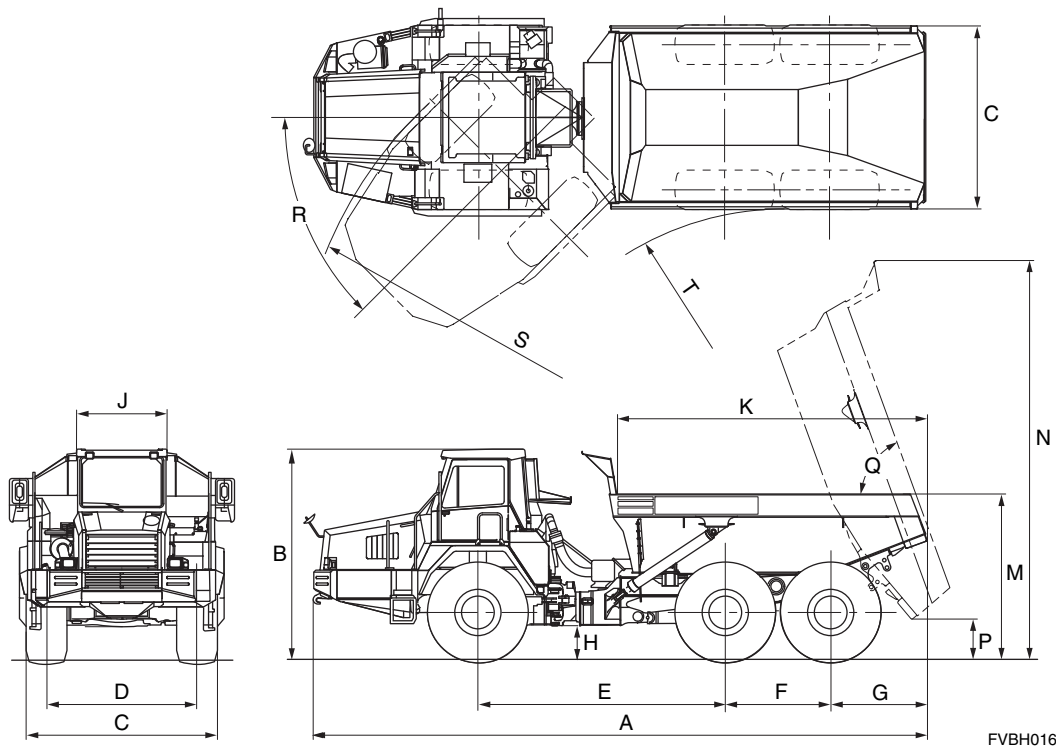

FVBH0162

Unit: mm (ft.in)

	HM300-3	HM300-2 HM300-2R	HM300-1	HM350-2 HM350-2R	HM350-1	HM400-3
Tires	23.5 R25	23.5-R25	23.5 R25	26.5R25	26.5 R25	29.5-R25
A	10275 (33'9")	10440 (34'3")	10095 (33'1")	11145 (36'7")	10730 (35'2")	11105 (36'5")
B	3510 (11'6")	3520 (11'7")	3500 (11'6")	3700 (12'1")	3595 (11'10")	3735 (12'3")
C	2900 (9'6")	2900 (9'6")	2900 (9'6")	3250 (10'8")	3250 (10'8")	3450 (11'4")
D	2280 (7'6")	2280 (7'6")	2280 (7'6")	2590 (8'6")	2590 (8'6")	2690 (8'10")
E	4100 (13'6")	4100 (13'5")	4100 (13'5")	4350 (14'3")	4350 (14'3")	4350 (14'3")
F	1710 (5'7")	1710 (5'7")	1710 (5'7")	1850 (6'1")	1850 (6'1")	1970 (6'6")
G	1700 (5'7")	1695 (5'7")	1695 (5'7")	1775 (5'10")	1645 (5'5")	1800 (5'11")
H	575 (1'11")	510 (1'8")	510 (1'8")	585 (1'11")	585 (1'11")	710 (2'4")
J	1665 (5'6")	1600 (5'3")	1600 (5'3")	1600 (5'3")	1600 (5'3")	1675 (5'6")
K	5250 (17'3")	5240 (17'2")	5240 (17'2")	5495 (18'0")	5510 (18'1")	5667 (18'7")
M	2830 (9'3")	2790 (9'2")	2790 (9'2")	2975 (9'9")	2840 (9'4")	3164 (10'5")
N	6440 (21'2")	6340 (21'1")	6445 (21'2")	7035 (23'1")	7035 (23'1")	7171 (23'6")
P	572 (1'11")	600 (2'0")	605 (2'0")	720 (2'4")	720 (2'4")	808 (2'8")
Q (deg.)	70°	70°	70°	70°	70°	70°
R (deg.)	45°	45°	45°	45°	45°	45°
S	8100 (26'7")	7960 (26'1")	7960 (26'1")	8600 (28'3")	8400 (27'7")	8800 (28'10")
T	4000 (13'1")	4010 (13'2")	4010 (13'2")	4200 (13'9")	4060 (13'4")	4170 (13'8")

Dimensions

ARTICULATED DUMP TRUCKS

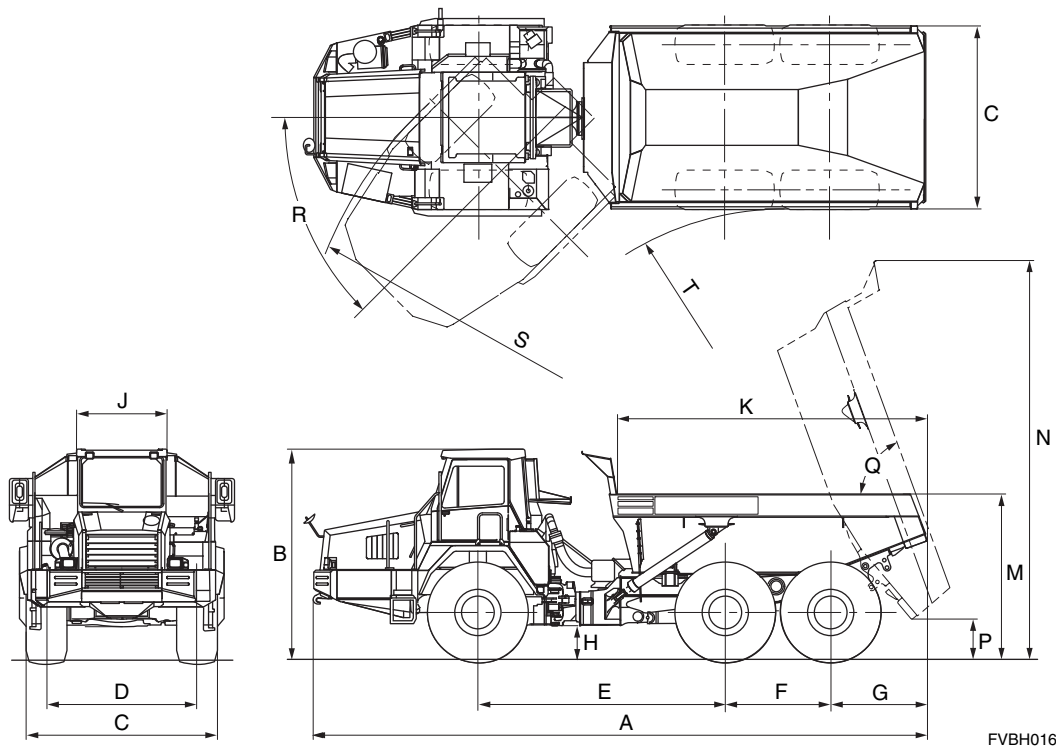

FVBH0162

Unit: mm (ft.in)

	HM400-2 HM400-2R	HM400-1			
Tires	29.5 R25	29.5 R25			
A	11310 (37'1")	11025 (36'2")			
B	3720 (12'2")	3700 (12'2")			
C	3450 (11'4")	3450 (11'4")			
D	2690 (8'10")	2690 (8'10")			
E	4350 (14'3")	4350 (14'3")			
F	1970 (6'6")	1970 (6'6")			
G	1820 (6'0")	1820 (6'0")			
H	605 (2'0")	620 (2'0")			
J	1600 (5'3")	1600 (5'3")			
K	5630 (18'6")	5640 (18'6")			
M	2970 (9'9")	2970 (9'9")			
N	7130 (23'5")	7130 (23'5")			
P	720 (2'4")	720 (2'4")			
Q (deg.)	70°	70°			
R (deg.)	45°	45°			
S	8700 (28'7")	8700 (28'7")			
T	4170 (13'8")	4170 (13'8")			

Use of travel performance curve

For assessing a vehicle's grade-ability, travel speed, rim pull, etc. First, draw a vertical line according to the vehicle's weight (A) and mark the point (B) corresponding to total resistance (the sum of rolling resistance and grade resistance). Next, draw a horizontal line from (B), then mark (C) where the line intersects the rim pull curve and read (E) for the rim pull. For travel speed (D), draw a vertical line downward from (C).

For instance, when traveling an 8% gradient and encountering a 5% rolling resistance, a vehicle with a 36.5 ton (40-U.S. ton) payload should have a rim pull of 8.5 tons (18,740 lb) and travel at a speed of 10 km/h (6.2 MPH) in forward 2nd gear.

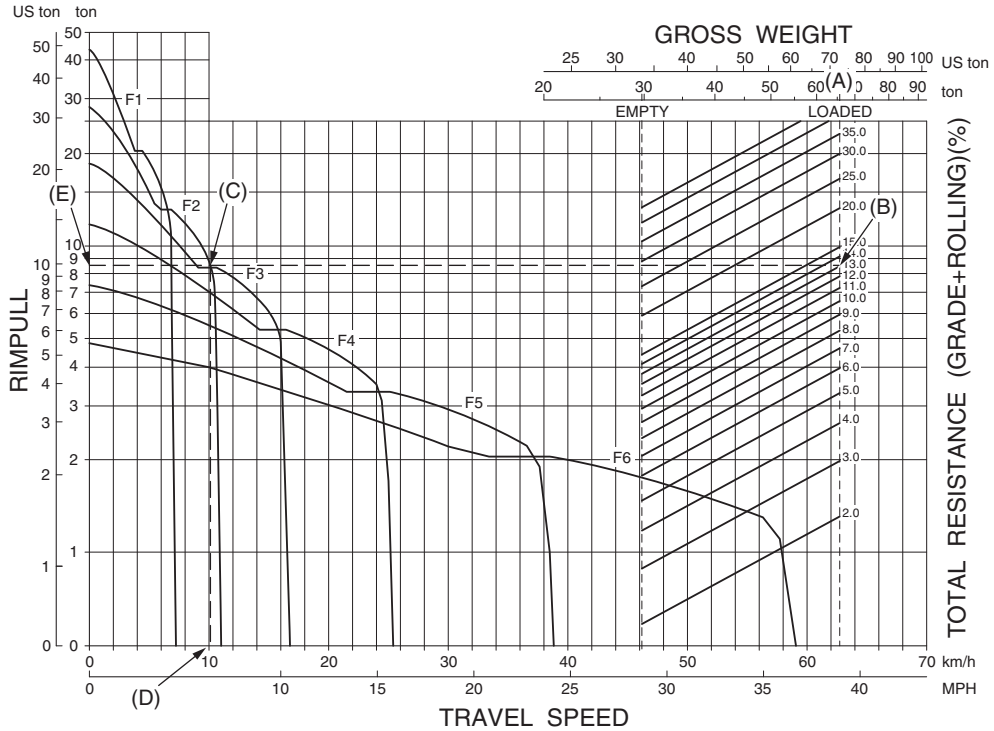

Travel Performance Curve

Power mode

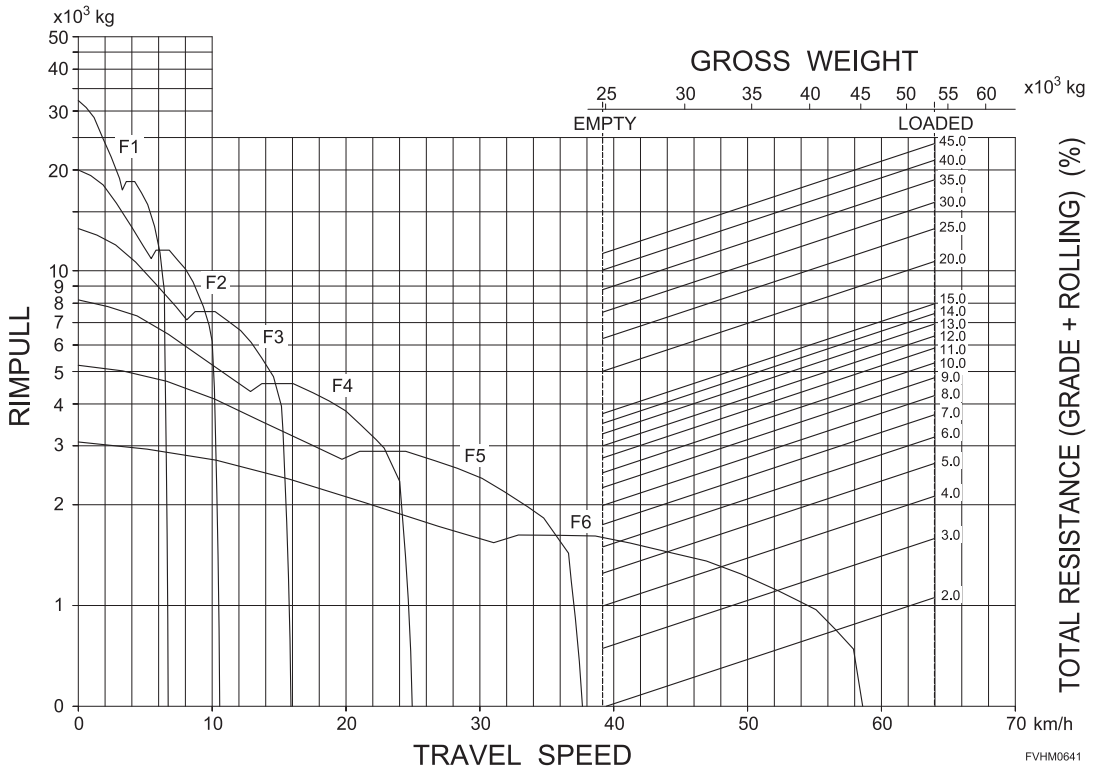

FVHM0641

Brake Performance

GRADE DISTANCE : CONTINUOUS DESCENT

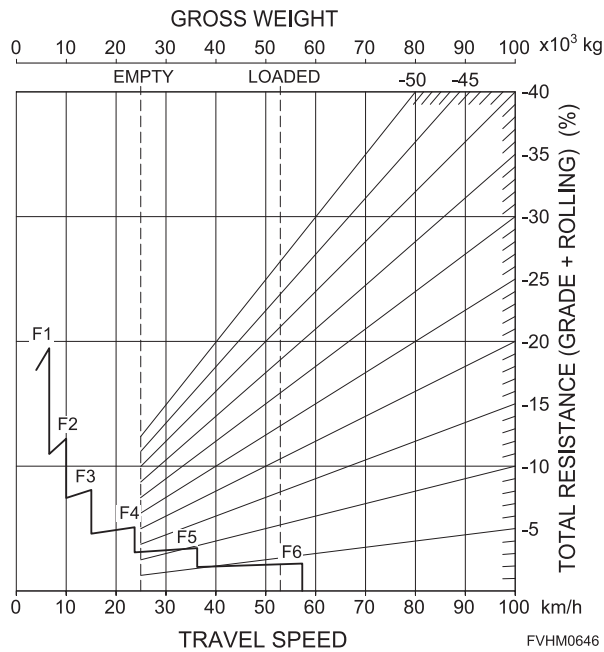

FVHM0646

Travel Performance Curve

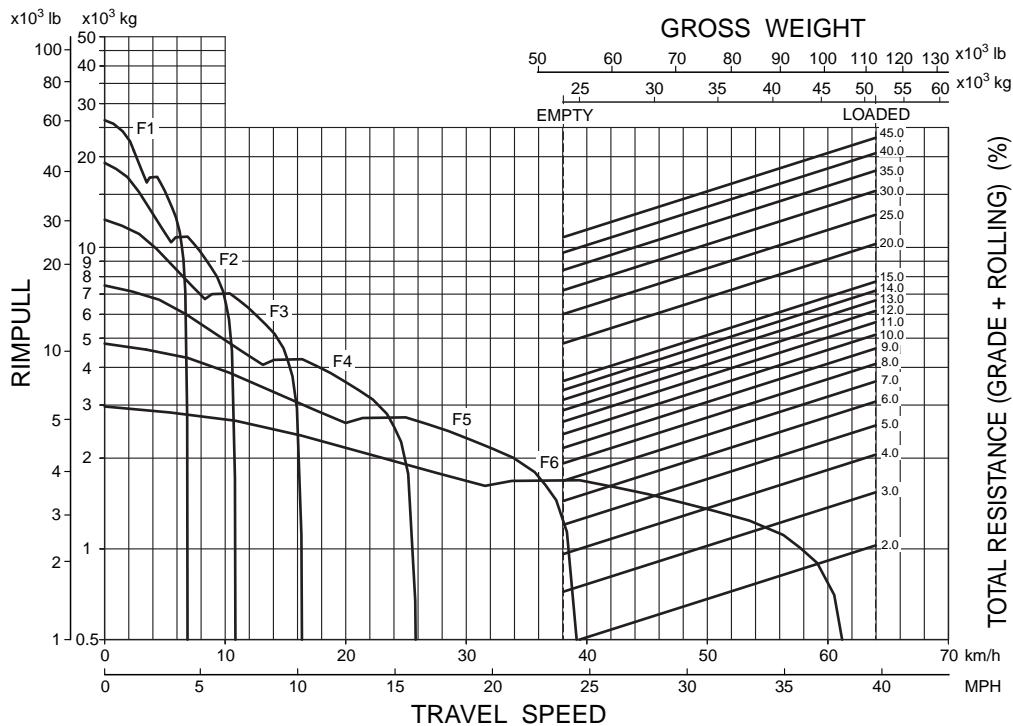

Brake performance

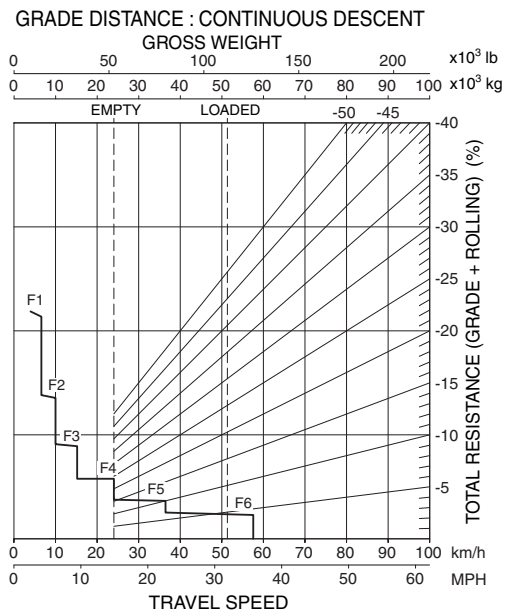

HM300-1 Performance Curves

ARTICULATED DUMP TRUCKS

Travel Performance Curve

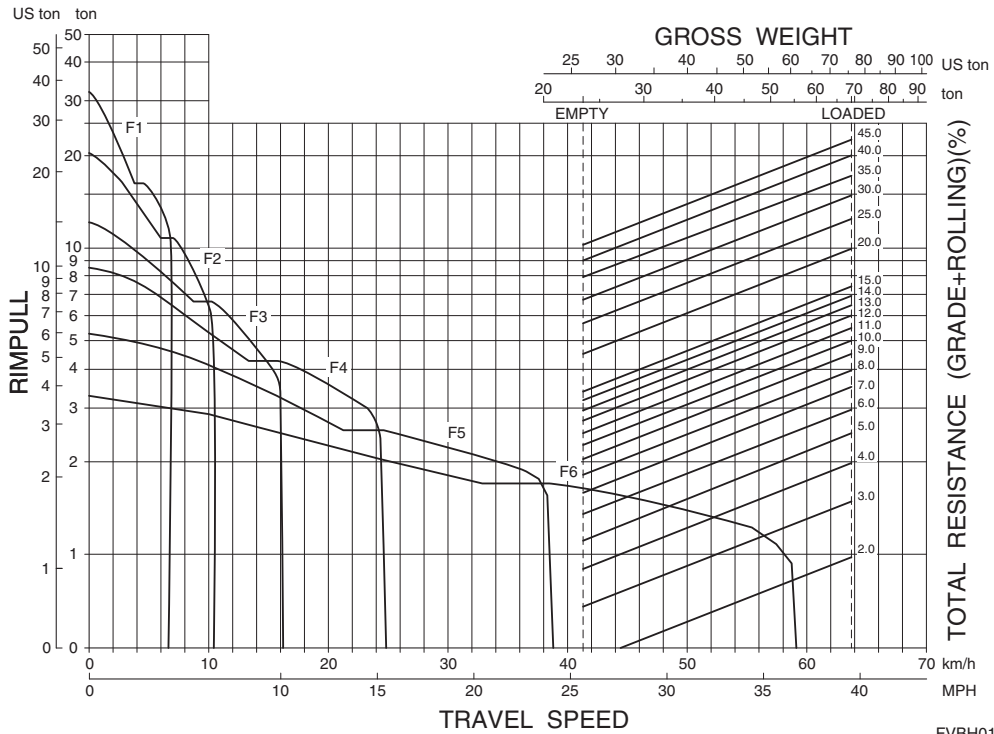

FVBH0164

Brake performance

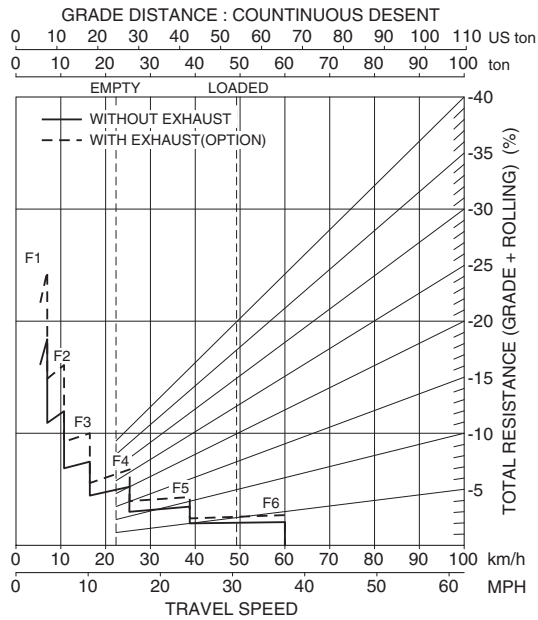

FVBH0165

Travel Performance Curve

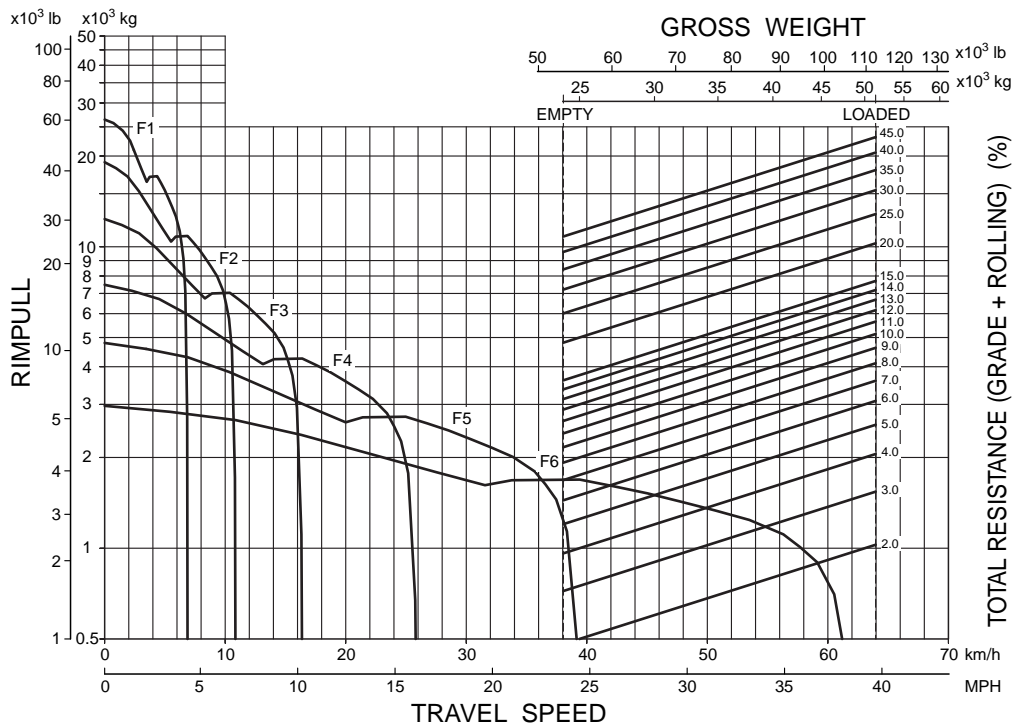

Brake performance

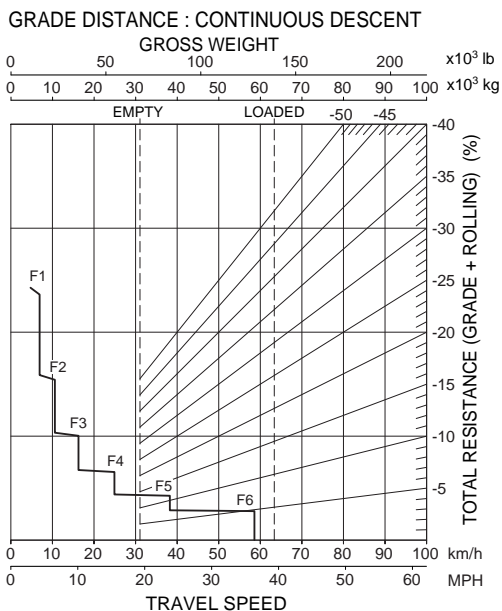

Travel Performance Curve

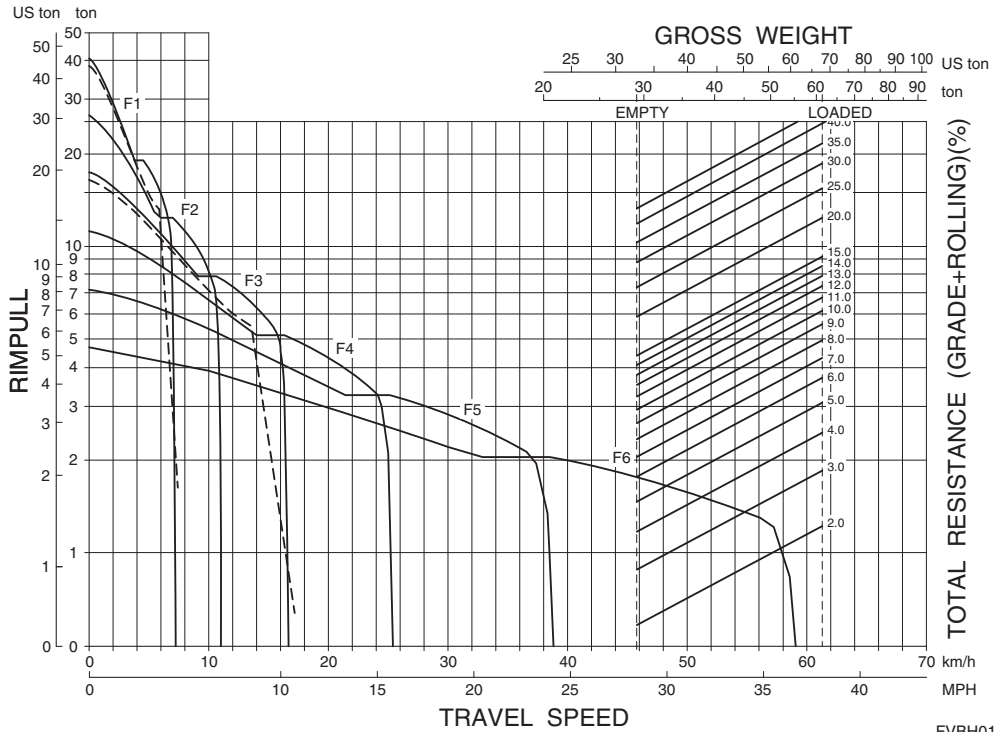

FVBH0166

Brake performance

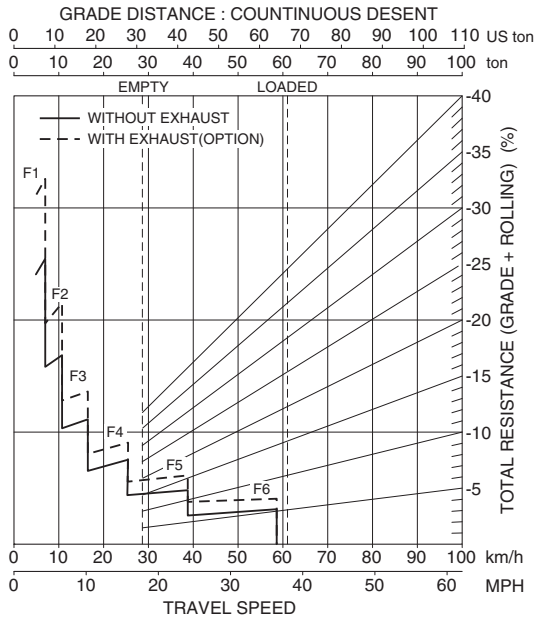

FVBH0167

Travel Performance Curve

Power mode

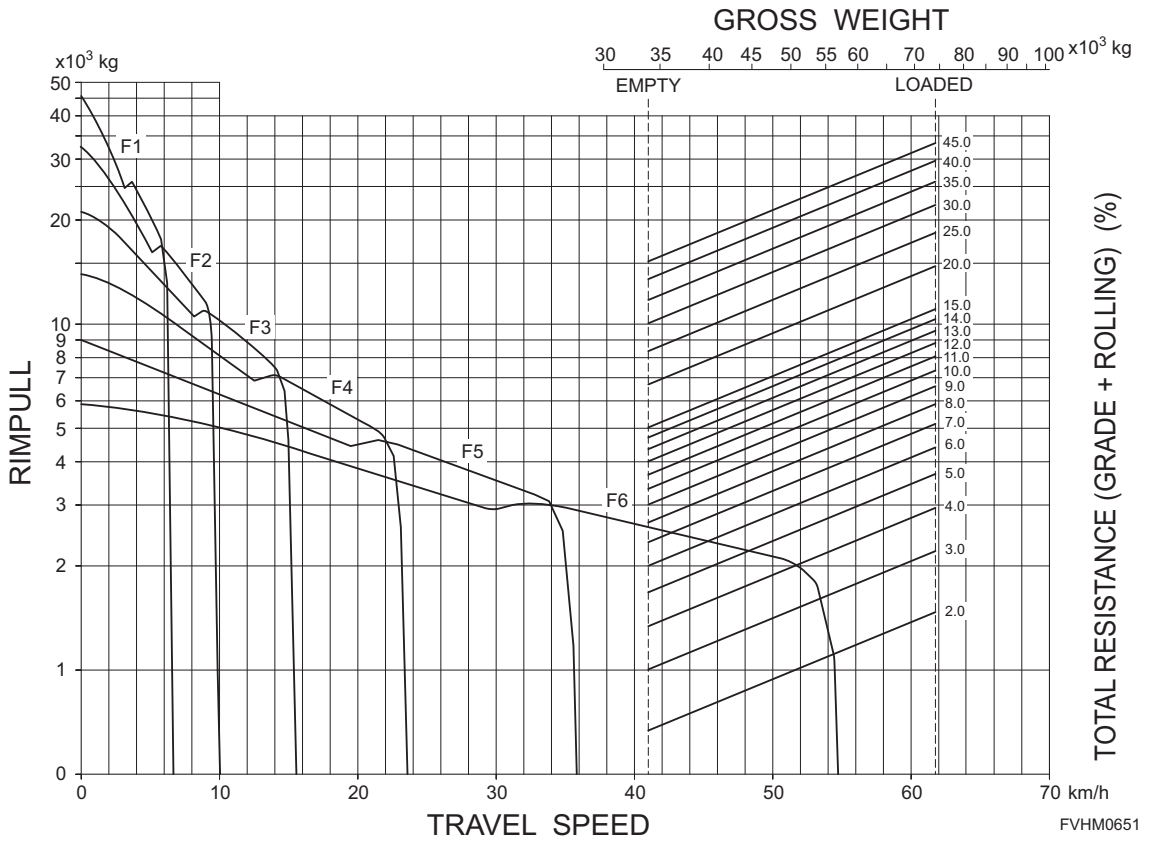

Brake Performance

GRADE DISTANCE : CONTINUOUS DESCENT

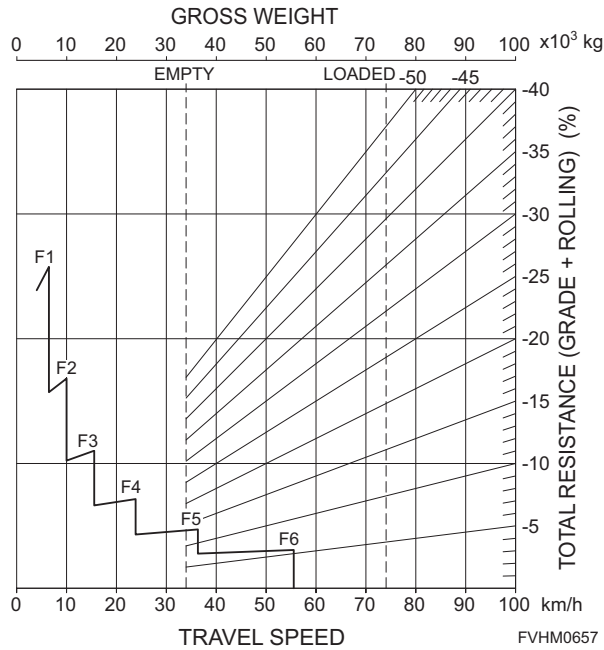

Travel Performance Curve

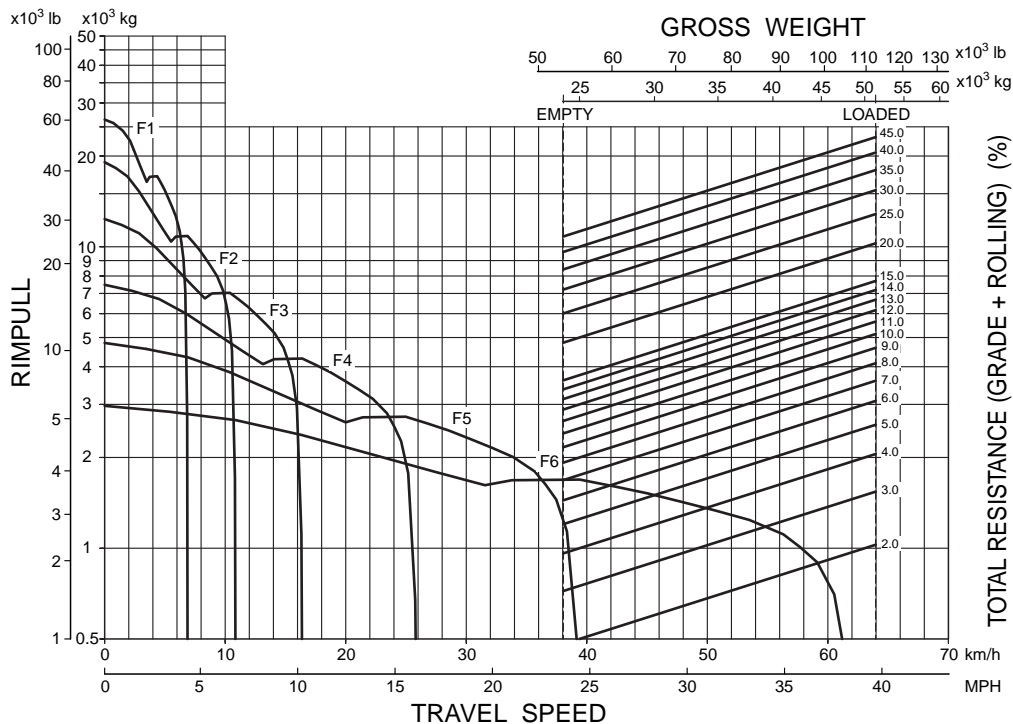

Brake performance

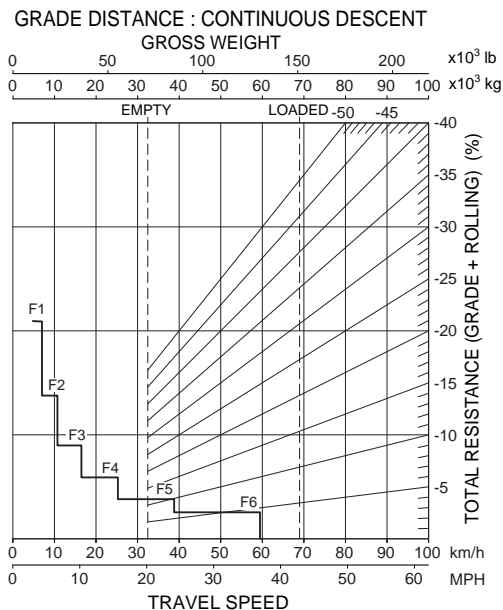

Travel Performance Curve

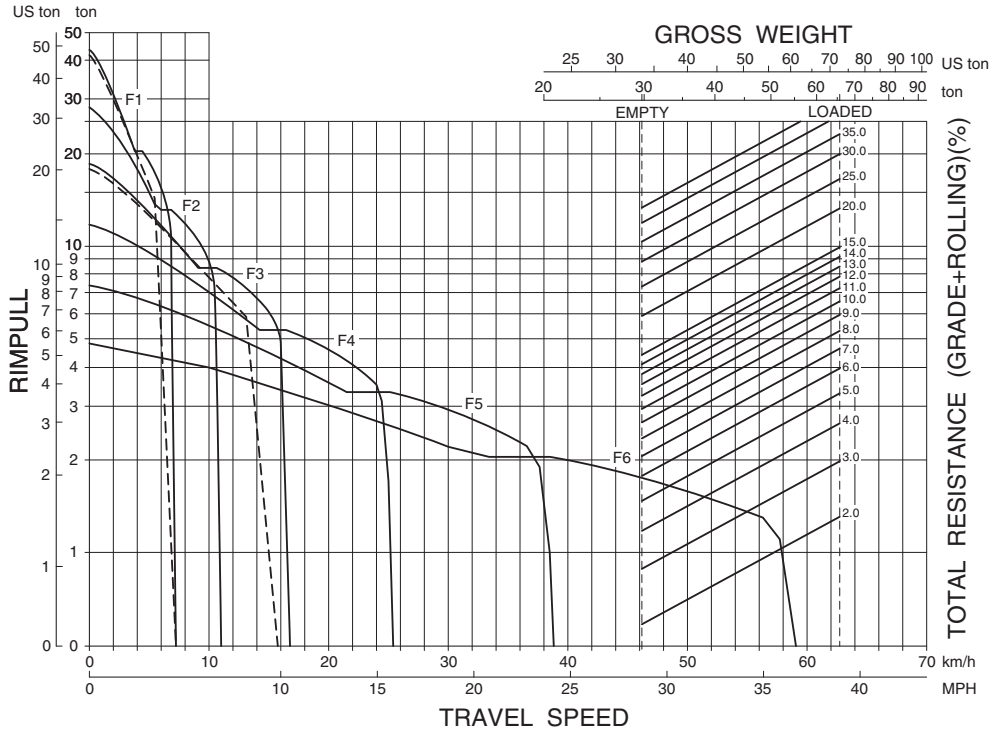

Brake performance

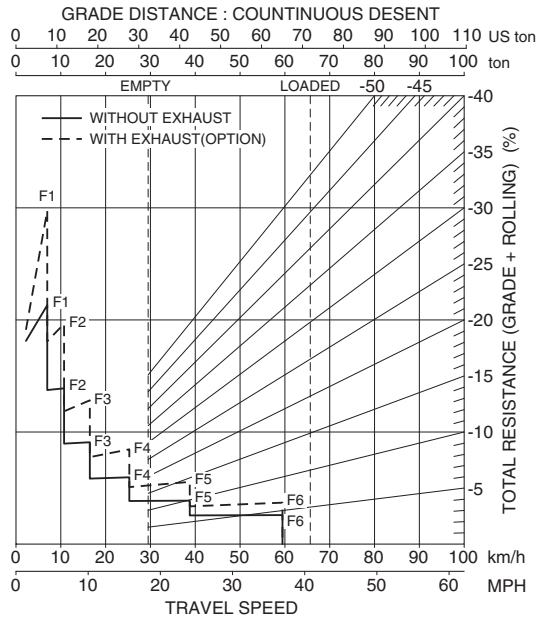

FVBH0169

Ground Pressure

ARTICULATED DUMP TRUCKS

Model		HM300-2, HM300-2R	HM300-3
Tire		750/65R25	750/65R25
WEIGHT:	kg (lb)		
Empty vehicle weight*		24620 (54,280)	24910 (54,920)
Distribution (front)		13650 (30,090)	14200 (31,310)
(center)		5850 (12,900)	5730 (12,630)
(rear)		5120 (11,290)	4980 (10,980)
Gross vehicle weight		52000 (114,640)	52990 (116,820)
Distribution (front)		15850 (34,940)	15370 (33,880)
(center)		18440 (40,650)	19340 (42,640)
(rear)		17710 (39040)	18280 (40,300)
GROUND CONTACT AREA:	cm ² (in ²)		
Empty:			
Front tire		2370 (367.4)	2412 (373.9)
Center tire		1060 (164.3)	1055 (163.5)
Rear tire		960 (148.8)	934 (144.8)
Loaded:			
Front tire		2640 (409.2)	2636 (408.6)
Center tire		2660 (412.3)	2664 (412.9)
Rear tire		2640 (409.3)	2657 (411.8)
GROUND PRESSURE:	kg/cm ² (PSI/kPa)		
Empty:			
Front tire		2.88 (41.0/282)	2.94 (41.8/288)
Center tire		2.76 (39.2/271)	2.72 (38.7/267)
Rear tire		2.67 (38.0/262)	2.66 (37.8/261)
Loaded:			
Front tire		3.00 (42.7/294)	2.92 (41.5/286)
Center tire		3.47 (49.3/340)	3.63 (51.6/356)
Rear tire		3.35 (47.6/329)	3.44 (48.9/337)

Model		HM300-1	
Tire		23.5R25	750/65R25
WEIGHT:	kg (lb)		
Empty vehicle weight*		22500 (49,600)	23545 (51,910)
Distribution (front)		12770 (28,150)	13125 (28,940)
(center)		5000 (11,020)	5345 (11,780)
(rear)		4730 (10,430)	5075 (11,190)
Gross vehicle weight		49875 (109,950)	50920 (112,260)
Distribution (front)		14860 (10,710)	15220 (33,550)
(center)		17805 (39,250)	18125 (39,960)
(rear)		17210 (37,940)	17575 (38,750)
GROUND CONTACT AREA:	cm ² (in ²)		
Empty:			
Front tire		1750 (271.3)	2150 (333.3)
Center tire		845 (131.0)	970 (150.4)
Rear tire		800 (124.0)	950 (147.3)
Loaded:			
Front tire		1960 (303.8)	2380 (368.9)
Center tire		2230 (345.7)	2575 (399.1)
Rear tire		2160 (334.8)	2510 (389.1)
GROUND PRESSURE:	kg/cm ² (PSI/kPa)		
Empty:			
Front tire		3.65 (51.9/357.9)	3.05 (43.4/299.1)
Center tire		2.96 (42.1/290.3)	2.76 (39.2/270.7)
Rear tire		2.96 (42.1/290.3)	2.67 (38.0/261.8)
Loaded:			
Front tire		3.79 (53.9/371.7)	3.20 (45.5/313.8)
Center tire		3.99 (56.7/391.3)	3.52 (50.1/345.2)
Rear tire		3.98 (56.6/390.3)	3.50 (49.8/343.2)

* Weight includes lubricants, coolant, full fuel tank and standard body.

Ground Pressure

ARTICULATED DUMP TRUCKS

Model		HM350-2, HM350-2R	
Tire		26.5R25	
WEIGHT:	kg (lb)		
Empty vehicle weight*		31200 (68,780)	
Distribution (front)		17920 (39,510)	
(center)		6730 (14,840)	
(rear)		6550 (14,440)	
Gross vehicle weight		63580 (140,170)	
Distribution (front)		20280 (44,710)	
(center)		21740 (47,930)	
(rear)		21560 (47,530)	
GROUND CONTACT AREA:	cm ² (in ²)		
Empty:	Front tire	2370 (367.4)	
	Center tire	1075 (166.6)	
	Rear tire	1030 (159.7)	
Loaded:	Front tire	2560 (396.8)	
	Center tire	2620 (406.1)	
	Rear tire	2580 (399.9)	
GROUND PRESSURE:	kg/cm ² (PSI/kPa)		
Empty:	Front tire	3.78 (53.8/371)	
	Center tire	3.13 (44.5/307)	
	Rear tire	3.18 (45.2/312)	
Loaded:	Front tire	3.96 (56.3/388)	
	Center tire	4.15 (59.0/407)	
	Rear tire	4.18 (59.4/410)	

Model		HM350-1	
Tire		26.5R25	800/65R29
WEIGHT:	kg (lb)		
Empty vehicle weight*		28550 (62,940)	30034 (66,210)
Distribution (front)		15850 (34,920)	16378 (36,110)
(center)		6350 (14,000)	6828 (15,050)
(rear)		6350 (14,000)	6828 (15,050)
Gross vehicle weight		60925 (134,320)	62409 (137,590)
Distribution (front)		18545 (40,880)	18973 (41,830)
(center)		21190 (46,720)	21718 (47,880)
(rear)		21190 (46,720)	21718 (47,880)
GROUND CONTACT AREA:	cm ² (in ²)		
Empty:	Front tire	2400 (372.0)	2662 (412.6)
	Center tire	1160 (179.8)	1707 (264.6)
	Rear tire	1160 (179.8)	1707 (264.6)
Loaded:	Front tire	2700 (418.5)	2932 (454.5)
	Center tire	2650 (410.8)	3170 (491.4)
	Rear tire	2650 (410.8)	3170 (491.4)
GROUND PRESSURE:	kg/cm ² (PSI/kPa)		
Empty:	Front tire	3.30 (46.9/323.6)	3.08 (43.8/302.0)
	Center tire	2.74 (39.0/268.7)	2.00 (28.4/196.1)
	Rear tire	2.74 (39.0/268.7)	2.00 (28.4/196.1)
Loaded:	Front tire	3.43 (48.8/336.4)	3.24 (46.1/317.8)
	Center tire	4.00 (56.9/392.3)	3.43 (48.8/336.4)
	Rear tire	4.00 (56.9/392.3)	3.43 (48.8/336.4)

* Weight includes lubricants, coolant, full fuel tank and standard body.

Ground Pressure

**ARTICULATED
DUMP TRUCKS**

Model		HM400-2, HM400-2R	HM400-3
Tire		29.5R25	29.5R25
WEIGHT:	kg (lb)		
Empty vehicle weight*		32590 (71,850)	33660 (34,210)
Distribution (front)		17960 (39,595)	18980 (41,840)
(center)		7440 (16,400)	7570 (16,690)
(rear)		7190 (15,850)	7110 (15,670)
Gross vehicle weight		69170 (152,490)	73740 (162,570)
Distribution (front)		20080 (44,270)	21680 (47,800)
(center)		24670 (54,390)	26100 (57,540)
(rear)		24420 (53,840)	25980 (57,280)
GROUND CONTACT AREA:	cm² (in²)		
Empty:	Front tire	3093 (479.4)	3123 (484.1)
	Center tire	1360 (210.8)	1416 (219.5)
	Rear tire	1330 (206.2)	1347 (208.8)
Loaded:	Front tire	3360 (520.8)	3527 (546.7)
	Center tire	3940 (610.7)	4188 (649.1)
	Rear tire	3840 (595.2)	4167 (645.9)
GROUND PRESSURE:	kg/cm² (PSI/kPa)		
Empty:	Front tire	2.90 (41.2/284)	3.04 (43.2/298)
	Center tire	2.74 (39.0/269)	2.67 (38.0/262)
	Rear tire	2.70 (38.4/265)	2.64 (37.5/259)
Loaded:	Front tire	2.99 (42.5/293)	3.07 (43.7/301)
	Center tire	3.13 (44.5/307)	3.12 (44.4/306)
	Rear tire	3.18 (45.2/312)	3.11 (44.2/305)

Model		HM400-1	
Tire		29.5R25	875/65R29
WEIGHT:	kg (lb)		
Empty vehicle weight*		30300 (66,800)	31260 (68,920)
Distribution (front)		16790 (37,020)	17110 (37,720)
(center)		6755 (14,890)	7075 (15,600)
(rear)		6755 (14,890)	7075 (15,600)
Gross vehicle weight		66875 (147,430)	67835 (149,550)
Distribution (front)		19055 (42,010)	19375 (42,710)
(center)		23910 (51,120)	24230 (53,420)
(rear)		23910 (51,120)	24230 (53,420)
GROUND CONTACT AREA:	cm² (in²)		
Empty:	Front tire	2570 (398.4)	3350 (519.3)
	Center tire	1170 (181.4)	2050 (317.8)
	Rear tire	1170 (181.4)	2050 (317.8)
Loaded:	Front tire	2900 (449.5)	3660 (567.3)
	Center tire	3300 (511.5)	3980 (616.9)
	Rear tire	3300 (511.5)	3980 (616.9)
GROUND PRESSURE:	kg/cm² (PSI/kPa)		
Empty:	Front tire	3.27 (46.5/320.7)	2.55 (36.3/250.1)
	Center tire	2.89 (41.1/283.4)	1.73 (24.6/169.7)
	Rear tire	2.89 (41.1/283.4)	1.73 (24.6/169.7)
Loaded:	Front tire	3.29 (46.8/322.6)	2.65 (37.7/259.9)
	Center tire	3.62 (51.5/355.0)	3.04 (43.2/298.1)
	Rear tire	3.62 (51.5/355.0)	3.04 (43.2/298.1)

* Weight includes lubricants, coolant, full fuel tank and standard body.

TIRE SELECTION GUIDE FOR ARTICULATED DUMP TRUCKS

HM300-1, HM300-2, HM300-2R, HM300-3

Tire size	Manu- facturer*	Pattern	Charac- teristics	Code	Star Rating	Inflation pressure	Applicable terrain	Feature
23.5 R25	BS	VKT	CR	E2	☆☆	4.5	Soft and muddy surfaces	Good traction and floatation
23.5 R25	BS	VLT	CR	E2	☆☆	4.5	Wet, soft and muddy surface	Rubber volume of tread ratio (VKT:1, VLT:1.25) Excellent maneuverability, traction and floatation
23.5 R25	GY	RL-2+		E2	☆☆	4.5		
23.5 R25	GY	GP-2B		E2	☆☆	4.5		Smoother ride and good traction
23.5 R25	MC	XADN		E2		4.5		
23.5 R25	TY	T-331	CR	E3	☆☆	4.5	Soft surface and hard soil field	High wear-resistance, cut and tip-resistance
750/65 R25	BS	VLT	CR	E2	☆☆	F:3.5 C,R:4.1	Wet, soft and muddy surface	Good traction and floatation
750/65 R25	GY	RL-2+		E2	☆☆	F:3.5 C,R:4.1		
750/65 R25	MC	XAD65-1		E3		F:3.5 C,R:4.1		

HM300-1 tire ground pressures

	Tire maker, type		BS, VLT	BS, VLT, wide			
	Tire size	—	23.5R25	750/G5R25			
Loaded	Empty	Front tire	kg/cm ² (PSI)	3.65 (51.9)	3.05 (43.4)		
		Center tire	kg/cm ² (PSI)	2.96 (42.1)	2.76 (39.2)		
		Rear tire	kg/cm ² (PSI)	2.96 (42.1)	2.67 (38.0)		
	Loaded	Empty	Front tire	kg/cm ² (PSI)	3.79 (53.9)	3.20 (45.5)	
			Center tire	kg/cm ² (PSI)	3.99 (56.7)	3.52 (50.1)	
			Rear tire	kg/cm ² (PSI)	3.99 (56.7)	3.50 (49.8)	

HM350-1, HM350-2, HM350-2R

Tire size	Manu- facturer*	Pattern	Charac- teristics	Code	Star Rating	Inflation pressure	Applicable terrain	Feature
26.5 R25	BS	VKT	CR	E2	☆☆	4.5	Soft and muddy surfaces	Good traction and floatation
26.5 R25	BS	VLT	CR	E2	☆☆	4.5	Soft and muddy surfaces	Rubber volume of tread ratio (VKT:1, VLT:1.25) Excellent maneuverability, traction and floatation
26.5 R25	BS	VLTS	CR	E4	☆☆	4.5	Soft and muddy surfaces	High wear-resistance, cut- resistance because of deep tread (STD:1, VLTS:1.5)
26.5 R25	GY	RL-2+		E2	☆☆	4.5		
26.5 R25	GY	GP-2B		E2	☆☆			
26.5 R25	GY	TL-3A+		E3	☆☆			
26.5 R25	GY	GP-4B AT		E4	☆☆			
26.5 R25	MC	XADN E3T		E3				
26.5 R25	MC	XADT E4T		E4		4.5		
26.5 R25	MC	XADN E3V		E3		4.5		
26.5 R25	TY	T-351		E3	☆☆		Soft surface and under ground	Good traction, anti-sideways slip and cut-resistance
800/65 R29	GY	GP-4D		E4	☆☆	4.0		

HM350-1 tire ground pressures

	Tire maker, type		BS, VLT	BS, VLT, wide		
	Tire size	—	26.5 R25	800/65 R29		
Loaded	Empty	Front tire	kg/cm ² (PSI)	3.35 (33.4)	3.08 (43.8)	
		Center tire	kg/cm ² (PSI)	2.82 (40.1)	2.00 (28.4)	
		Rear tire	kg/cm ² (PSI)	2.82 (40.1)	2.00 (28.4)	
Loaded	Empty	Front tire	kg/cm ² (PSI)	3.46 (49.2)	3.24 (46.1)	
		Center tire	kg/cm ² (PSI)	4.04 (57.4)	3.43 (48.8)	
		Rear tire	kg/cm ² (PSI)	4.04 (57.4)	3.43 (48.8)	

* Tire maker.....BS:BRIDGESTONE GY:GOODYEAR MC:MICHELIN TY:TOYO

Tire Selection

ARTICULATED DUMP TRUCKS

HM400-1, HM400-2, HM400-2R, HM400-3

Tire size	Manu- facturer*	Pattern	Charac- teristics	Code	Star Rating	Inflation pressure	Applicable terrain	Feature
29.5 R25	BS	VLTS	CR	E4	☆☆		Soft and muddy surfaces	High wear-resistance, cut-resistance
29.5 R25	BS	VKT	CR	E2	☆☆	3.8	Soft and muddy surfaces	Good traction and floatation
29.5 R25	BS	VLT		E2	☆☆	3.8	Soft and muddy surfaces	Good traction and floatation
29.5 R25	BS	VKT		E2	☆☆	3.8	Soft and muddy surfaces	Good traction and floatation
29.5 R25	GY	RL-2+		E2	☆☆	4.1		
29.5 R25	GY	GP-2B		E2	☆☆			
29.5 R25	GY	GP-4B AT		E4	☆☆			
29.5 R25	MC	XADN E3T		E3				
29.5 R25	MC	XADN E3V		E3				
29.5 R25	MC	XADT E4T		E4		4.0		
29.5 R25	TY	T-351		E3	☆☆		Soft surface and under ground	Good traction, anti-sideways slip and cut-resistance
875/65 R29	GY	GP-4D		E4	☆☆	4.5		
875/65 R29	MC	XAD65-1		E3		4.5		

HM400-1 tire ground pressures

	Tire maker, type		BS, VLT	BS, VLT, wide		
	Tire size	—	29.5 R25	875/65 R29		
Empty	Front tire	kg/cm ² (PSI)	3.27 (46.5)	2.56 (36.4)		
	Center tire	kg/cm ² (PSI)	2.89 (41.1)	1.73 (24.6)		
	Rear tire	kg/cm ² (PSI)	2.89 (41.1)	1.73 (24.6)		
Loaded	Front tire	kg/cm ² (PSI)	3.37 (47.9)	2.71 (38.5)		
	Center tire	kg/cm ² (PSI)	3.62 (51.5)	3.04 (43.2)		
	Rear tire	kg/cm ² (PSI)	3.62 (51.5)	3.04 (43.2)		

* Tire maker.....BS:BRIDGESTONE GY:GOODYEAR MC:MICHELIN TY:TOYO

TIRE PATTERN

BRIDGESTONE



GOODYEAR



MICHELIN



TOYO



1. Liner application

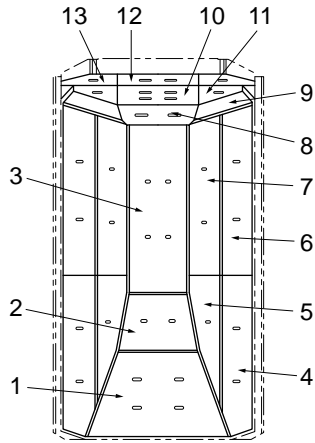

- Body top view -

FVBH0465

No.	Part	Plate thickness mm (in)		
		HM300-1	HM350-1	HM400-1
(1)	Bottom (end1)	14 (0.55)	16 (0.63)	16 (0.63)
(2)	Bottom (end2)	14 (0.55)	16 (0.63)	16 (0.63)
(3)	Bottom	14 (0.55)	16 (0.63)	16 (0.63)
(4)	Side (top-end)	12 (0.47)	12 (0.47)	12 (0.47)
(5)	Side (bottom-end)	14 (0.55)	16 (0.63)	16 (0.63)
(6)	Side (top-middle)	12 (0.47)	12 (0.47)	12 (0.47)
(7)	Side (bottom-middle)	14 (0.55)	16 (0.63)	16 (0.63)
(8)	Corner (bottom)	14 (0.55)	16 (0.63)	16 (0.63)
(9)	Corner (side)	12 (0.47)	12 (0.47)	12 (0.47)
(10)	Front (center)	12 (0.47)	12 (0.47)	12 (0.47)
(11)	Front (side)	8 (0.31)	8 (0.31)	8 (0.31)
(12)	Canopy (center)	8 (0.31)	8 (0.31)	8 (0.31)
(13)	Canopy (side)	8 (0.31)	8 (0.31)	8 (0.31)
Liner weight kg (lb)		2440 (5380)	2540 (5605)	2675 (5900)

No.	Part	Plate thickness mm (in)				
		HM300-2 (R)	HM350-2 (R)	HM400-2 (R)	HM300-3	HM400-3
(1)	Bottom (end1)	14 (0.55)	16 (0.63)	16 (0.63)	14 (0.55)	16 (0.63)
(2)	Bottom (end2)	14 (0.55)	16 (0.63)		14 (0.55)	16 (0.63)
(3)	Bottom	14 (0.55)	16 (0.63)	16 (0.63)	14 (0.55)	16 (0.63)
(4)	Side (top-end)	12 (0.47)	12 (0.47)	12 (0.47)	12 (0.47)	12 (0.47)
(5)	Side (bottom-end)	14 (0.55)	16 (0.63)	16 (0.63)	14 (0.55)	16 (0.63)
(6)	Side (top-middle)	12 (0.47)	12 (0.47)	12 (0.47)	12 (0.47)	12 (0.47)
(7)	Side (bottom-middle)	14 (0.55)	16 (0.63)	16 (0.63)	14 (0.55)	16 (0.63)
(8)	Corner (bottom)	14 (0.55)	16 (0.63)	16 (0.63)	14 (0.55)	16 (0.63)
(9)	Corner (side)	12 (0.47)	12 (0.47)	12 (0.47)	12 (0.47)	12 (0.47)
(10)	Front (center)	12 (0.47)	12 (0.47)	12 (0.47)	12 (0.47)	12 (0.47)
(11)	Front (side)	8 (0.31)	9 (0.35)	8 (0.31)	8 (0.31)	8 (0.31)
(12)	Canopy (center)	8 (0.31)	9 (0.35)	8 (0.31)	8 (0.31)	8 (0.31)
(13)	Canopy (side)	8 (0.31)	9 (0.35)	8 (0.31)	8 (0.31)	8 (0.31)
Liner weight kg (lb)		2440 (5380)	2515 (5545)	2710 (5975)	2032 (4480)	2710 (5975)

2. Body extension & tail gate

Tail Gate

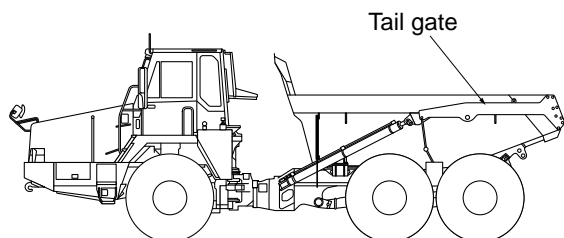

FVBH0466

Extension (+200 mm (7.9"))

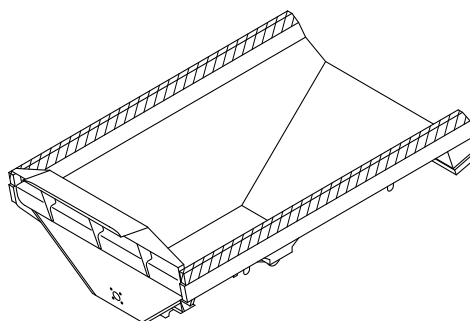

FVBH0467

Body capacity m³ (yd³)

		HM300-1	HM350-1	HM400-1
Standard body	Heaped	16.6 (21.7)	19.8 (25.9)	22.3 (29.2)
	Struck	12.9 (16.9)	14.6 (19.1)	16.5 (21.6)
With 200 mm (7.9") extension	Heaped	18.6 (24.3)	22.2 (29.0)	24.7 (32.3)
	Struck	15.1 (19.7)	17.6 (23.0)	19.3 (25.2)
With tail gate	Heaped	17.3 (22.6)	20.5 (26.8)	23.1 (30.2)
	Struck	13.4 (17.5)	15.0 (19.6)	17.0 (22.2)

		HM300-2 (R)	HM350-2 (R)	HM400-2 (R)
Standard body	Heaped	16.6 (21.7)	19.8 (25.9)	22.3 (29.2)
	Struck	12.9 (16.9)	14.6 (19.1)	16.5 (21.6)
With 200 mm (7.9") extension	Heaped	18.6 (24.3)	22.3 (29.2)	24.7 (32.3)
	Struck	15.1 (19.8)	17.9 (23.4)	19.3 (25.2)
With tail gate	Heaped	17.3 (22.6)	20.6 (26.9)	23.1 (30.2)
	Struck	13.4 (17.5)	15.1 (19.8)	17.0 (22.2)

		HM300-3	HM400-3
Standard body	Heaped	17.1 (22.4)	24.0 (31.4)
	Struck	13.4 (17.5)	18.2 (23.8)
With 200 mm (7.9") extension	Heaped	19.4 (25.4)	26.7 (24.9)
	Struck	15.8 (20.7)	21.6 (28.2)
With tail gate	Heaped	17.4 (22.8)	24.4 (31.9)
	Struck	13.7 (17.9)	18.7 (24.5)

CONTENTS

INDEX

SECTION **5**

MOTOR GRADERS Sec 5



MOTOR GRADERS

CONTENTS

Features	5-2
Specifications	5-4
Dimensions	5-6
Attachment Availability	5-7
Scarifier Specifications	5-8
Front Dozer Blade Specifications	5-10
Rear Mounted Ripper Specifications	5-11
Upper Attachments	5-12
Attachments and Options	5-13

■ **Wide product range**

Komatsu offers you a complete choice in every category :

- Machine size and weight.
- Engine power
- Rigid or articulated frame
- Transmission : Direct drive or HYDROSHIFT
- Blade length

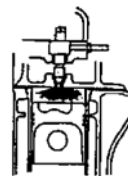

■ **High productivity**

- Komatsu's diesel engine delivers a strong horsepower and has a direct-injection system for fuel savings and cleaner exhaust.
- The HYDROSHIFT transmission ensures not only efficient power transmitting ability for reduced fuel costs, but also a single-lever speed control and F/R directional changes for easy operation.

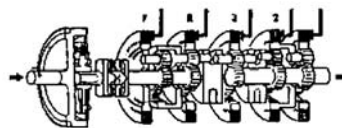

• **Hydraulic circuits with pilot checks valves**

Pilot check valves are built into the blade lift, front axle lean and frame articulation circuits.

This prevents drifting of these cylinders, and results in high finishing accuracy. These valves also help maintain the original equipment position and to prevent drift if the control lever is operated with the engine stopped.

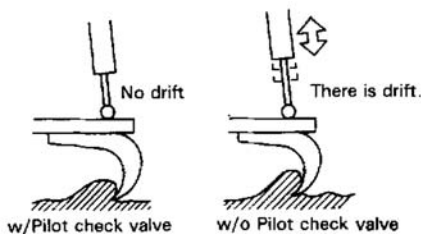

• **Wide working range**

Wide blade range, hydraulic blade side-shift, infinitely varied bank cut angle make machine ready for a real variety of operations.

The blade bank-cutting position can be controlled up to 90° on either side from the operator's seat.

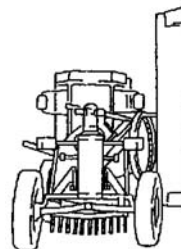

■ **Ideal weight distribution**

- Since the front wheels are loaded with the optimum weight distribution to prevent side slipping, outstanding operational stability is assured especially during operations that impose heavy side thrust on the machine.

■ **Easy operation / operator comfort**

• **Ergonomically arranged instrument and control levers**

Short-stroke levers and reduced-effort controls assure responsive, finger-touch control.

Ergonomic, human-engineered design includes logical arrangement of instruments and levers based on frequency of manipulation.

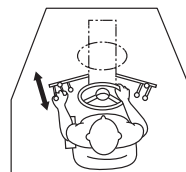
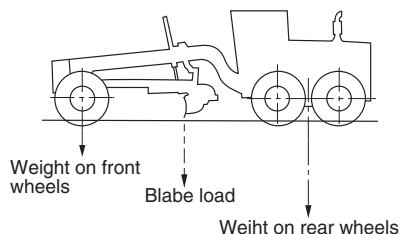

FVBH0015

■ **Max. uptime**

● **Non-spin differential**

Non-spin differential with automatic locking and unlocking can be installed as an option on the final drives, assuring the optimum in smooth steering.

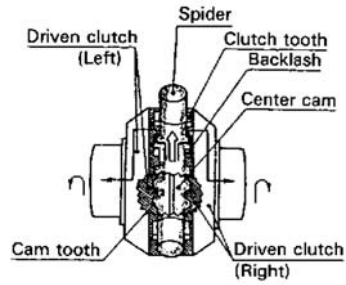

● **Air cleaner with automatic dust evacuator**

Dry-type air cleaner with automatic dust evacuator for longer element service.

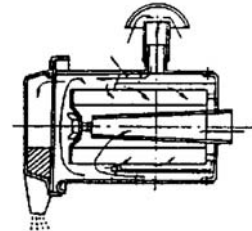

● **Spin-on type filters.**

Spin-on type engine oil filters and fuel filters for easy element replacement.

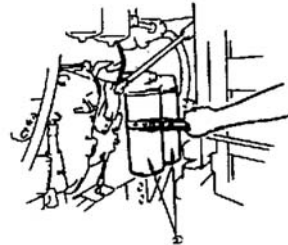

■ **Additional features for GD825A**

● **Tiltable steering post**

Since the left and right control lever wings and steering post are each separate and independently adjustable, the operator can adjust them to the optimum angle for convenience. During travel, the steering column may be tilted toward the operator for easy steering control.

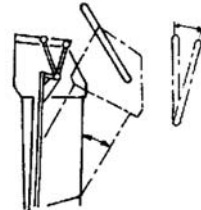

● **Fully adjustable operator seat**

Fully adjustable suspension seat offers more comfortable ride.

● **Oil cooled multiple-disc brake**

Powerful, adjustment free, oil-cooled multiple disc brakes are employed on all rear tandem wheels.

Since brake discs are oil-lubricated in the tandem cases, high cooling efficiency is maintained to prevent heat build - up during frequent, heavy-duty braking action.

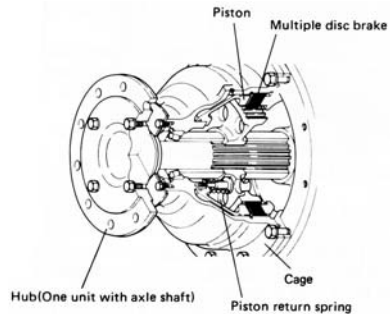

● **Lock / unlock differential gear**

The differential is equipped with an electric-over-hydraulic multiple-disc clutch can actuate differential lock or unlock simply by turning the switch on the console.

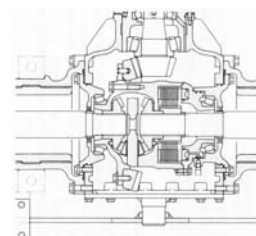

Specifications

MOTOR GRADERS

Item	Model	GD511A-1	•GD555-5	GD555-3***	•GD655-5
OPERATING WEIGHT*	kg (lb)	10800 (23,810)	15135 (33,370)	15740 (38,140)	15495 (34,160)
HORSEPOWER: SAE J1995: Gross ISO9249/SAE J1349: Net	kW (HP)/rpm kW (HP)/rpm		146 (196)/2000 144 (193)/2000	125 (167)/2000 119 (160)/2000	165 (221)/2100 163 (218)/2100
PERFORMANCE: Travel speeds:	km/h (MPH)				
Forward 1st		3.4 (2.1)	3.4 (2.1)	3.3 (2.1)	3.4 (2.1)
2nd		6.1 (3.8)	5.0 (3.1)	4.8 (3.0)	5.0 (3.1)
3rd		10.7 (6.6)	7.0 (4.3)	6.8 (4.2)	7.0 (4.3)
4th		14.1 (8.8)	10.2 (6.3)	9.8 (6.1)	10.2 (6.3)
5th		25.5 (15.8)	15.4 (9.6)	14.9 (9.3)	15.4 (9.6)
6th		44.5 (27.7)	22.3 (13.9)	21.6 (13.4)	22.3 (13.9)
7th		—	30.6 (19.0)	29.6 (18.4)	30.6 (19.0)
8th		—	44.3 (27.5)	42.9 (26.7)	44.3 (27.5)
Reverse (Max.)		54.4 (33.8)	40.3 (25.0)	39.1 (24.3)	40.3 (25.0)
Max. traction (Drawbar pull)	kg (lb)	6140 (13,535)	8800 (19,400)		9050 (19,950)
Min. turning radius**	mm (ft.in)	6600 (21'8")	7300 (23'11")	6800 (22'4")	7400 (24'3")
DIMENSIONS:					
Overall length	mm (ft.in)	7895 (25'11")	8995 (29'6")	8387 (27'6")	9205 (30'2")
Treads: Front	mm (ft.in)	2020 (6'8")	2070 (6'9")	2130 (7'0")	2070 (6'9")
Rear	mm (ft.in)	2020 (6'8")	2060 (6'9")	2130 (7'0")	2060 (6'9")
Articulation angle (each)	degree	27	25	23	25
ENGINE:					
Model		KOMATSU S6D95L	KOMATSU SAA6D107E-1	KOMATSU SAA6D102E-2	KOMATSU SAA6D107E-1
No. of cylinders- bore × stroke	mm (in)	6-95 × 115 (3.74 × 4.53)	6 -107 × 124 (4.21 × 4.88)	6 - 102 × 120 (4.02 × 4.72)	6 -107 × 124 (4.21 × 4.88)
Piston displacement	ltr. (in ³)	4.89 (298)	6.69 (408)	5.88 (359)	6.69 (408)
CAPACITY					
Fuel tank	ltr. (U.S. Gal)	227 (60.0)	416 (109.9)	340 (90)	416 (109.9)

Item	Model	•GD655-5***	GD663A-2	•GD675-5	GD705A-4
OPERATING WEIGHT*	kg (lb)	15860 (34,960)	13350 (29,430)	15955 (35,175)	17620 (38,580)
HORSEPOWER: SAE J1995: Gross ISO9249/SAE J1349: Net	kW (HP)/rpm kW (HP)/rpm	165 (221)/2100 163 (218)/2100		165 (221)/2100 163 (218)/2100	149 (200)/2000
PERFORMANCE: Travel speeds:	km/h (MPH)				
Forward 1st		3.4 (2.1)	3.7 (2.3)	3.4 (2.1)	3.9 (2.4)
2nd		5.0 (3.1)	6.6 (4.1)	5.0 (3.1)	5.2 (3.2)
3rd		7.0 (4.3)	11.3 (7.0)	7.0 (4.3)	7.6 (4.7)
4th		10.2 (6.3)	15.5 (9.6)	10.2 (6.3)	11.5 (7.1)
5th		15.4 (9.6)	27.6 (17.2)	15.4 (9.6)	15.0 (6.8)
6th		22.3 (13.9)	47.2 (29.3)	22.3 (13.9)	20.5 (12.7)
7th		30.6 (19.0)	-	30.6 (19.0)	30.0 (18.6)
8th		44.3 (27.5)	-	44.3 (27.5)	43.0 (26.7)
Reverse (Max.)		40.3 (25.0)	57.6 (35.8)	40.3 (25.0)	45.9 (28.5)
Max. traction (Drawbar pull)	kg (lb)		7550 (16,640)	9290 (20,490)	10180 (22,420)
Min. turning radius**	mm (ft.in)	7400 (24'3")	7100 (23'4")	7400 (24'3")	7500 (24'7")
DIMENSIONS:					
Overall length	mm (ft.in)	9205 (29'7")	8500 (27'11")	9205 (30'2")	9270 (30'5")
Treads: Front	mm (ft.in)	2160 (7'1")	2070 (6'10")	2170 (7'1")	2300 (7'7")
Rear	mm (ft.in)	2160 (7'1")	2070 (6'10")	2160 (7'1")	2300 (7'7")
Articulation angle(each)	degree	25	26	25	26
ENGINE:					
Model		KOMATSU SAA6D107E-1	KOMATSU 6D125	KOMATSU SAA6D107E-1	KOMATSU S6D125
No. of cylinders- bore × stroke	mm (in)	6 - 107 × 124 (4.21 × 4.88)	6 - 125 × 150 (4.92 × 5.91)	6 -107 × 124 (4.21 × 4.88)	6 -125 × 150 (4.9 × 5.9)
Piston displacement	ltr. (in ³)	6.69 (408)	11.04 (674)	6.69 (408)	11.05 (674)
CAPACITY					
Fuel tank	ltr. (U.S. Gal)	416 (110)	285 (75.3)	416 (109.9)	400 (105.7)

* Operating weight includes standard blade, standard tires, full fuel tank, lubricants, operator and standard equipment.

** At center of front outside tire, combining the use of full articulation, full front wheel steering and leaning.

*** Brazil source

- Tier 3 and Stage 3A model

Item	Model	GD755-5R	GD825A-2		
OPERATING WEIGHT*	kg (lb)	21650 (47,730)	26350 (58,090)		
HORSEPOWER: SAE J1995: Gross ISO9249/SAE J1349: Net	kW (HP)/rpm kW (HP)/rpm	216 (290)/2000 213 (286)/2000	209 (280)/2100		
PERFORMANCE: Travel speeds:	km/h (MPH)				
Forward 1st		5.1 (3.2)	4.0 (2.5)		
2nd		7.9 (4.9)	5.4 (3.4)		
3rd		9.5 (5.9)	8.0 (5.0)		
4th		12.1 (7.5)	11.5 (7.1)		
5th		14.9 (9.3)	15.8 (9.8)		
6th		19.1 (11.9)	21.4 (13.3)		
7th		29.2 (18.1)	31.3 (19.4)		
8th		45.0 (28.0)	44.9 (27.9)		
Reverse (Max.)		43.6 (27.1)	47.9 (29.8)		
Max .traction (Drawbar pull)	Kg (lb)	13700 (30,200)	14705 (32,420)		
Min. turning radius**	mm (ft.in)	7700 (22'8")	7900 (25'11") ^{*5}		
DIMENSIONS:					
Overall length	mm (ft.in)	9540 (31'4")	11470 (37'8")		
Treads: Front	mm (ft.in)	2300 (7'7")	2620 (8'7")		
Rear	mm (ft.in)	2300 (7'7")	2620 (8'7")		
Articulation angle (each)	degree	27	25		
ENGINE:					
Model		KOMATSU SAA6D125-5	KOMATSU S6D140E		
No. of cylinders- bore × stroke	mm (in)	6 - 125 × 150 (4.92 × 5.91)	6-140 × 165 (5.51 × 6.50)		
Piston displacement	ltr. (in ³)	11.04 (674)	15.24 (930)		
CAPACITY					
Fuel tank	ltr. (U.S. Gal)	400 (105.7)	500 (132.1)		

* Operating weight includes standard blade, standard tires, full fuel tank, lubricants, operator and standard equipment.

** At center of front outside tire, combining the use of full articulation, full front wheel steering and leaning.

*** USA version

^{*5} With differential

• Tier 3 and Stage 3A model

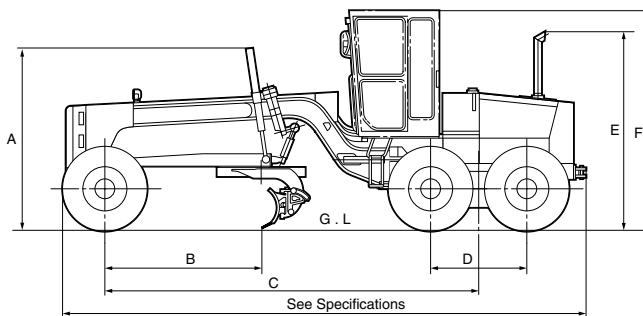

Item		Model	GD511A-1	GD555-5	GD555-3**	GD655-5	GD655-5**
BLADE:	Length	mm (ft.in)	3710 (12'2")	3710 (12'2")	3710 (12'2")	3710 (12'2")	3710 (12'2")
	Height*	mm (ft.in)	645 (2'1")	645 (2'1")	660 (2'2")	645 (2'1")	660 (2'2")
TIRES			13.00-24-8PR	14.00-24-10PR	14.00-24-12PR	14.00-24-10PR	17.5 R25
DIMENSIONS:							
A	Height to top of the blade lift cylinders	mm (ft.in)	2815 (9'3")				
B	Distance between center of front tires and blade edge	mm (ft.in)	2540 (8'4")	2380 (7'10")	2500 (8'2")	2580 (8'6")	2580 (8'6")
C	Wheelbase	mm (ft.in)	5780 (19')	6270 (20'7")	5850 (19'2")	6480 (21'3")	6480 (21'3")
D	Distance between centers of tandem wheels	mm (ft.in)	1535 (5'0")	1525 (5'0")	1535 (5'0")	1525 (5'0")	1525 (5'0")
E	Height to top of the stack	mm (ft.in)	3165 (10'5")	2997 (9'10")		2997 (9'10")	
F	Overall height:	mm (ft.in)					
	When installing the						
	-CANVAS CANOPY		3355 (11')				
	-ROPS CANOPY		3500 (11'6")				
	-ROPS CAB (Low)			3200 (10'6")	3121 (10'3")	3200 (10'6")	3200 (10'6")
	-ROPS CAB (High)		3485 (11'5")				
	-STEEL CAB		3340 (11')				
	Articulation angle	degree	27	25	23	25	25
	Width over tires:	mm (ft.in)					
	Front		2395 (7'10")	2495 (8'2")	2633 (8'8")	2495 (8'2")	2615 (8'7")
	Rear		2395 (7'10")	2485 (8'2")	2633 (8'8")	2485 (8'2")	2615 (8'7")
	Ground clearance	mm (ft.in)	365 (1'2")	390 (1'3")		390 (1'3")	

Item		Model	GD663A-2	GD675-5	GD705A-4	GD755-5R	GD825A-2
BLADE:	Length	mm (ft.in)	3710 (12'2")	4320 (14'2")	4320 (14'2")	4320 (14'2")	4878 (16')
	Height*	mm (ft.in)	645 (2'1")	645 (2'1")	700 (2'4")	700 (2'4")	850 (2'9")
TIRES			14.00-24-10PR	17.5 R25	16.00-24-12PR	16.00-24-16PR	23.5-25-12PR
DIMENSIONS:							
A	Height to top of the blade lift cylinders	mm (ft.in)			2900 (9'6")		3300 (10'10")
B	Distance between center of front tires and blade edge	mm (ft.in)	2600 (8'6")	2580 (8'6")	2900 (9'6")	2860 (9'5")	3100 (10'2")
C	Wheelbase	mm (ft.in)	6000 (19'8")	6480 (21'3")	6450 (21'2")	6750 (22'2")	7100 (23'4")
D	Distance between centers of tandem wheels	mm (ft.in)	1535 (5')	1525 (5'0")	1730 (5'8")	1653 (5'5")	1840 (6')
E	Height to top of the stack	mm (ft.in)	3130 (10'3")	2997 (9'10")	3365 (11')	3135 (10'3")	3490 (11'5")
F	Overall height:	mm (ft.in)					
	When installing the						
	-CANVAS CANOPY				3365 (11')		
	-ROPS CANOPY				3560 (11'8")		
	-ROPS CAB (Low)			3200 (10'6")		3535 (11'7")	—
	-ROPS CAB (High)				3560 (11'8")		3550 (11'8")
	-STEEL CAB		3360 (11'0")		3365 (11')		3550 (11'8")
	Articulation angle	degree	26	25	26	27	25
	Width over tires:	mm (ft.in)					
	Front		2470 (8'1")	2640 (8'8")	2800 (9'2")	2800 (9'2")	3310 (11'10")
	Rear		2470 (8'1")	2630 (8'8")	2800 (9'2")	2800 (9'2")	3310 (11'10")
	Ground clearance	mm (ft.in)	393 (1'3")	390 (1'3")	410 (1'4")	390 (1'3")	440 (1'5")

* Blade arc length

** Brazil source

● :Standard equipment
○ :Optional equipment

Item	Model	GD 511A-1	GD 555-5	GD 655-5	GD 663A-2	GD 675-5	GD 705A-4	GD 755-5R	GD 825A-2	
BLADE										
2.2 m (7.2 ft)										
2.5 m (8.2 ft)										
2.8 m (9.2 ft)										
3.05 m (10 ft)										
3.1 m (10.2 ft)										
3.4 m (11.2 ft)										
3.7 m (12.1 ft)		●	●	●	●					
4.0 m (13.1 ft)		○			○					
4.3 m (14.1 ft)		○	○	○	○	●	●	●		
4.9 m (16.1 ft)									●	
VARIABLE BLADE										
HYDRAULIC BLADE TIP CONTROL		○	●	●	○		●		●	
EXTENSION BLADE										
FRONT DOZER BLADE		○	○	○	○	○	○			
SCARIFIER										
5 teeth										
6 teeth										
7 teeth										
9 teeth		○	○	○						
11 teeth		○	○	○	○	○	○			
REPLACEBLE TIP TEETH FOR SCARIFIER										
REAR MOUNT RIPPER			○	○	○	○	○	○	○	
PUSH PLATE			○	○	○	○		○	○	

* USA version

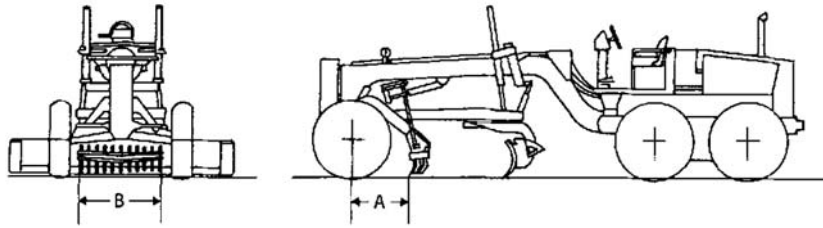

Item		Model	GD511A***		GD511A***	GD555-3
NO.OF TEETH			9		11	
ADDITIONAL WEIGHT:		kg (lb)	Standard Teeth		Standard Teeth	
To operating weight	+660 (+1,460) [+685 (+1,510)]		+665 (+1,470) [+690 (+1,520)]	+690 (+1,520) [+715 (+1,580)]	+565 (+1,250) [+575 (+1,270)]	
To front axle	+565 (+1,250) [+585 (+1,290)]		+570 (+1,260) [+590 (+1,300)]	+590 (+1,300) [+610 (+1,340)]	+470 (+1,040) [+475 (+1,050)]	
To rear axle	+95 (+210) [+100 (+220)]		+95 (+210) [+100 (+220)]	+100 (+220) [+105 (+230)]	+95 (+210) [+100 (+220)]	
DIMENSIONS: A: Distance between teeth and center of front tire		mm (ft.in)	970 (3'2")	850 (2'9")	970 (3'2")	1005 (3'4")
SCARIFIER LOAD*		kg (lb)	4440 (9,790)	4335 (9,560)	4470 (9,850)	5335 (11,760)
SCARIFIER RANGE:						
Digging angle	degree		61 ~ 74	51 ~ 64	61 ~ 74	63 ~ 78
Max. lift above ground	mm (ft.in)		340 (1'1") [530 (1'9")]	320 (1'1") [495 (1'7")]	340 (1'1") [530 (1'9")]	350 (1'2")
Max. digging depth	mm (ft.in)		260 (10.2") [290 (11.4")]	260 (10.2") [290 (11.4")]	260 (10.2") [290 (11.4")]	255 (10") [365 (1'2")]
SCARIFIER EQUIPMENT:			V-type, 2-stage adjustable		V-type, 2-stage adjustable	
Type						
Weight	kg (lb)		660 (1,460)	665 (1,470)	690 (1,520)	565 (1,250)
B: Digging width	mm (ft.in)		1065 (3'6")	1090 (3'7")	1325 (4'4")	1405 (4'7")
Tooth:						
As-installed	mm (in)		275 × 77 × 25 (10.8" × 3.0" × 1.0")	185 × 50 × 36.3 (7.3" × 2.0" × 1.4")	275 × 77 × 25 (10.8" × 3.0" × 1.0")	275 × 77 × 25 (10.8" × 3.0" × 1.0")
Height × width × thickness						

Item		Model	GD511A***	GD555-3	GD555-5	GD655-5 GD675-5
NO.OF TEETH			11			
ADDITIONAL WEIGHT:		kg (lb)	Point Teeth			
To operating weight	+695 (+1,530) [+720 (+1,590)]		+570 (+1,260) [+585 (+1,290)]	+645 (+1,420)	+645 (+1,420)	
To front axle	+595 (+1,310) [+615 (+1,360)]		+475 (+1,050) [+485 (+1,070)]	+565 (+1,250)	+565 (+1,250)	
To rear axle	+100 (+220) [+105 (+230)]		+95 (+210) [+100 (+220)]	+80 (+176)	+80 (+176)	
DIMENSIONS: A: Distance between teeth and center of front tire		mm (ft.in)	850 (2'9")	960 (3'2")	914 (3'0")	914 (3'0")
SCARIFIER LOAD*		kg (lb)	4265 (9,400)	5295 (11,670)	5510 (12,150)	5555 (12,250)
SCARIFIER RANGE:						
Digging angle	degree		51 ~ 64	53 ~ 69	51 ~ 68	51 ~ 68
Max. lift above ground	mm (ft.in)		340 (1'1") [530 (1'9")]	320 (1'1")	350 (1'2")	345 (1'2")
Max. digging depth	mm (ft.in)		260 (10.2") [290 (11.4")]	265 (10.4") [365 (1'2")]	205 (8.1")	210 (8.3")
SCARIFIER EQUIPMENT:			V-type, 2-stage adjustable		V-type, 2-stage adjustable	
Type						
Weight	kg (lb)		695 (1,530)	570 (1,260)	645 (1,420)	645 (1,420)
B: Digging width	mm (ft.in)		1350 (4'5")	1430 (4'8")	1430 (4'8")	1430 (4'8")
Tooth:						
As-installed	mm (in)		185 × 50 × 36.3 (7.3" × 2.0" × 1.4")	185 × 50 × 36.3 (7.3" × 2.0" × 1.4")	185 × 50 × 36.3 (7.3" × 2.0" × 1.4")	185 × 50 × 36.3 (7.3" × 2.0" × 1.4")
Height × width × thickness						

*: SCARIFIER LOAD: When the scarifier and rear tires support the machine's weight.

***: Including the scarifier bracket weight.

[] : When installing the adjustable type lifting rod

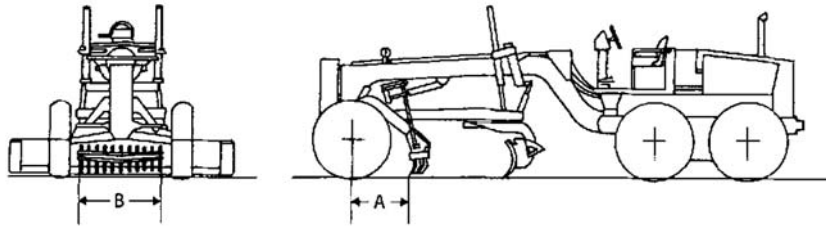

Item	Model	GD663A-2		GD705A-4	
NO.OF TEETH		11		11	
ADDITIONAL WEIGHT:	kg (lb)	Standard Teeth	Point Teeth	Standard Teeth	Point Teeth
To operating weight		+710 (+1,570)	+715 (+1,580)	+1040 (+2,290)	+1050 (+2,310)
To front axle		+615 (+1,360)	+620 (+1,370)	+880 (+1,940)	+890 (+1,960)
To rear axle		+95 (+210)	+95 (+210)	+160 (+350)	+160 (+350)
DIMENSIONS:					
A: Distance between teeth and center of front tire	mm (ft.in)	950 (3'1")	830 (2'9")	890 (2'11")	830 (2'9")
SCARIFIER LOAD*	kg (lb)	5380 (11,860)	5265 (11,610)	6690 (14,750)	6630 (14,620)
SCARIFIER RANGE:					
Digging angle	degree	61-74	51-64	54-67.5	49-63
Max. lift above ground	mm (ft.in)	350 (1'2")	330 (1'1")	630 (2'1")	610 (2'0")
Max. digging depth	mm (ft.in)	240 (9.4")	240 (9.4")	350 (1'2")	350 (1'2")
SCARIFIER EQUIPMENT:		V-type, 2-stage adjustable		V-type, 2-stage adjustable	
Type					
Weight	kg (lb)	710 (1,570)	715 (1,580)	1040 (2,290)	1050 (2,310)
B: Digging width	mm (ft.in)	1325 (4'4")	1350 (4'5")	1325 (4'4")	1350 (4'5")
Tooth:					
As-installed	mm (in)	275 × 77 × 25	185 × 50 × 36.3	265 × 77 × 25	185 × 50 × 36.3
Height × width × thickness		(10.8" × 3.0" × 1.0")	(7.3" × 2.0" × 1.4")	(10.4" × 3.0" × 1.0")	(7.3" × 2.0" × 1.4")

*: SCARIFIER LOAD: When the scarifier and rear tires support the machine's weight.

***: Including the scarifier bracket weight.

[] : When installing the adjustable type lifting rod.

Front Dozer Blade Specifications

MOTOR GRADERS

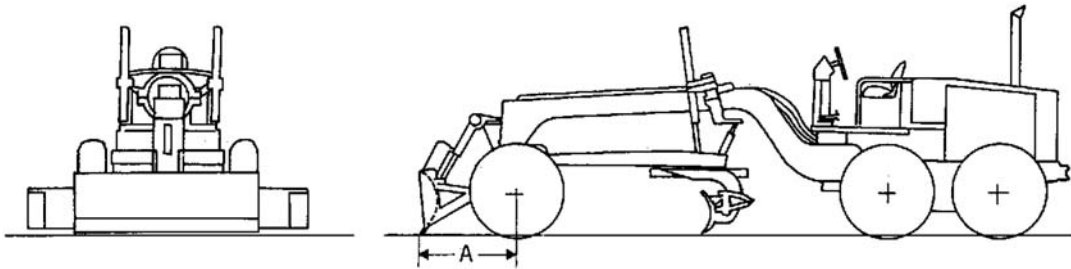

Item		Model	GD511A	GD555-5	GD655-5 GD675-5
ADDITIONAL WEIGHT:					
To operating weight	kg (lb)		+405 (+890)	+835 (+1,480)	+835 (+1,840)
To front axle			+500 (+1,100)	+965 (+2,130)	+965 (+2,130)
To rear axle			-95 (-210)	-130 (-290)	-130 (-290)
ADDITIONAL OVERALL LENGTH:					
A: Distance between blade edge and center of front tire	mm (ft.in)		1380 (4'6")	1445 (4'9")	1445 (4'9")
BLADE RANGE:					
Digging angle	degree		54.5	56	56
Max. lift above ground	mm (ft.in)		545 (1'9")	565 (1'10")	565 (1'10")
Max. digging depth	mm (ft.in)		165 (6.5")	138 (5.4")	138 (5.4")
BLADE EQUIPMENT:			Front arc, box section type, hydraulically controlled		
Type					
Weight	kg (lb)		826 (1,820)	835 (1,840)	835 (1,840)
Length	mm (ft.in)		2524 (8'3")	2500 (8'2")	2500 (8'2")
Height	mm (ft.in)		850 (2'9")	860 (2'10")	860 (2'10")

Item		Model	GD663A-2	GD705A-4
ADDITIONAL WEIGHT:				
To operating weight	kg (lb)		+170 (+375)	+970 (+2,140)
To front axle			+275 (+610)	+1100 (+2,450)
To rear axle			-105 (-230)	-140 (-310)
ADDITIONAL OVERALL LENGTH:				
A: Distance between blade edge and center of front tire	mm (ft.in)		1445 (4'9")	1610 (5'3")
BLADE RANGE:				
Digging angle	degree			55
Max. lift above ground	mm (ft.in)		548 (1'10")	555 (1'10")
Max. digging depth	mm (ft.in)		157 (6.2")	110 (4.3")
BLADE EQUIPMENT:			Front arc, box section type, hydraulically controlled	
Type				
Weight	kg (lb)		820 (1,810)	910 (2,010)
Length	mm (ft.in)		2524 (8'3")	2500 (8'2")
Height	mm (ft.in)		850 (2'9")	850 (2'9")

*: As the front counterweight is removed when installing the front blade, "Additional weight" differs from "Blade weight".

Rear Mounted Ripper Specifications

MOTOR GRADERS

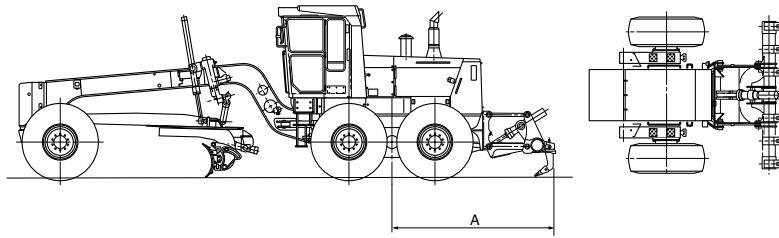



Item		Model	GD555-5	GD655-5 GD675-5	GD663A-2
ADDITIONAL WEIGHT:	To operating weight	kg (lb)	+1930 (+4,250)	+1930 (+4,250)	+1510 (+3,330)
	To front axle		+830 (+1,830)	+835 (+1,840)	+400 (+880)
	To rear axle		+1100 (+2,430)	+1095 (+2,410)	+1110 (+2,450)
ADDITIONAL OVERALL LENGTH:	A: Distance between ripper end and center of tandem wheel	mm (ft.in)	3168 (10'5")	3168 (10'5")	2974 (9'9")
	RIPPER RANGE:	degree	38	38	38
	Cutting angle	mm (ft.in)	555 (1'10")	555 (1'10")	580 (1'11")
	Max. lift above ground	mm (ft.in)	425 (1'5")	425 (1'5")	425 (1'5")
RIPPER EQUIPMENT:	Type		Parallelogram type, hydraulically controlled	Parallelogram type, hydraulically controlled	Parallelogram type, hydraulically controlled
	Weight	kg (lb)	950 (2,090)	950 (2,090)	950 (2,090)
	Beam length	mm (ft.in)	2303 (7'7")	2303 (7'7")	2303 (7'7")
	Shanks:				
	No. of shanks/Pitch	mm (ft.in)	3/1068 (3'6") 5/534 (1'9")	3/1068 (3'6") 5/534 (1'9")	3/1068 (3'6") 5/534 (1'9")
Teeth point type		Replaceable	Replaceable	Replaceable	

Item		Model	GD705A-4	GD755-5R	GD825A-2
ADDITIONAL WEIGHT:	To operating weight	kg (lb)	+2080 (+4,590)	+2730 (+6,020)	+2584 (+5,700)
	To front axle		+180 (+400)	+130 (+290)	-37 (-82)
	To rear axle		+1900 (+4,190)	+2600 (+5,730)	2621 (+5,780)
ADDITIONAL OVERALL LENGTH:	A: Distance between ripper end and center of tandem wheel	mm (ft.in)	3372 (11'1")	3347 (11'0")	3490 (11'5")
	RIPPER RANGE:	degree	38	38	42
	Cutting angle	mm (ft.in)	600 (2'0")	625 (2'1")	675 (2'3")
	Max. lift above ground	mm (ft.in)	380 (1'3")	390 (1'3")	480 (1'7")
RIPPER EQUIPMENT:	Type		Parallelogram type, hydraulically controlled	Parallelogram type, hydraulically controlled	Parallelogram type, hydraulically controlled
	Weight	kg (lb)	1410 (3,110)	1510 (3,330)	2014 (4,440)
	Beam length	mm (ft.in)	2740 (9'0")	2643 (8'8")	2064 (10'1")
	Shanks:				
	No. of shanks/Pitch	mm (ft.in)	3/1275 (4'2") 7/425 (1'5")	3/1245 (4'1") 7/415 (1'4")	3/1425 (4'8") 7/475 (1'7")
Teeth point type		Replaceable	Replaceable	Replaceable	

Item Model	Weight kg (lb)*					
	Canvas canopy	Steel cab	ROPS canopy		ROPS cab	
			Low profile	Full height	Low profile	Full height
GD511A-1	43 (95)	310 (680)	—	550 (1,210)	—	830 (1,830)
GD555-5	—	—	—	—	795 (1,750)	—
GD655-5	—	—	—	—	795 (1,750)	—
GD663A-2	43 (95)	310 (680)	—	550 (1,210)	—	830 (1,830)
GD675-5	—	—	—	—	795 (1,750)	—
GD705A-4	93 (205)	350 (770)	—	540 (1,190)	—	807 (1,780)
GD755-5R	—	—	—	—	860 (1,900)	—
GD825A-2	—	—	—	—	1,000 (2,205)	—

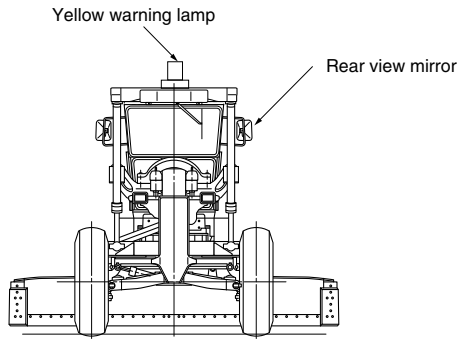
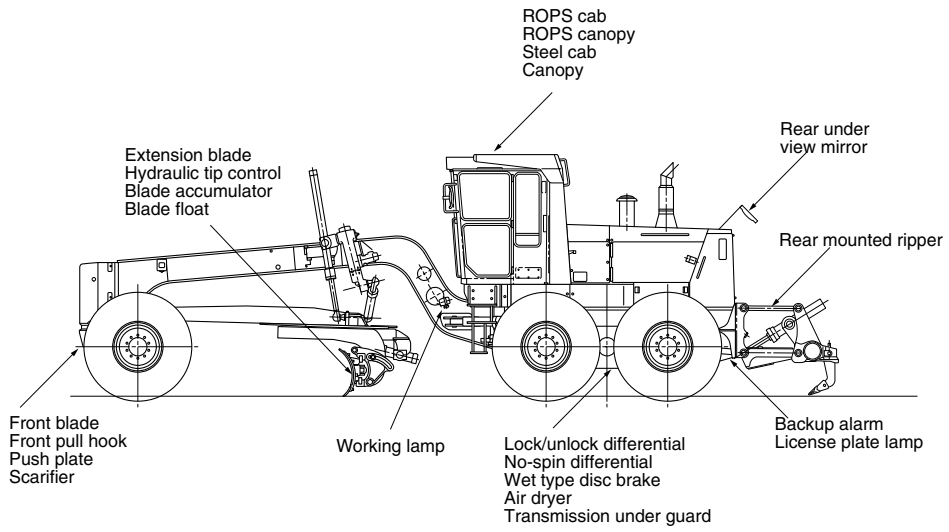
* With ROPS brackets

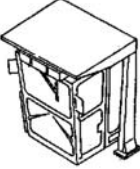
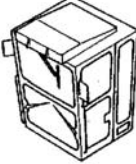
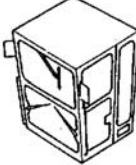
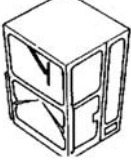

Description	Features
<p>ROPS (Roll Over Protective Structure) cab</p> 	<p>The combination of ROPS and a steel cab ensures safety in places where there is danger of the machine turning over and to protect the operator from wind, rain, cold, sand and sun. Low profile and full height cabs are available. Full height ROPS cab is 90 mm (3.5") higher than the low profile cab.</p>
<p>Deluxe steel cab (Type A)</p> 	<p>Consisting of a steel framework with glass doors, windshield and windows, it is completely enclosed and lined with noise - absorbing materials. (This cab is available for GD825A only.)</p>
<p>Standard steel cab (Type B)</p> 	<p>It consists of a steel framework with glass doors, windshield and windows. (This cab is available for all models excluding GD825A).</p>
<p>Simple steel cab (Type C)</p> 	<p>It consists of a steel framework with glass doors, windshield and windows. Upper front glass is fixed to cab frame. (This cab is available for all models excluding GD825A).</p>
<p>ROPS canopy</p> 	<p>This ensures safety in places where there is danger of the machine turning over and to protect the operator from the sun.</p>
<p>Canvas canopy, Steel canopy</p> 	<p>The simple steel frame is topped with a canvas canopy. This protects the operator from the sun.</p>

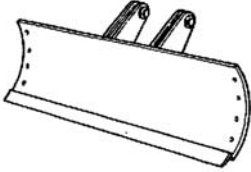
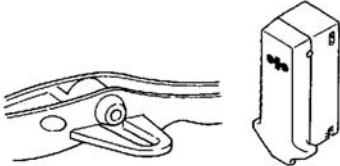
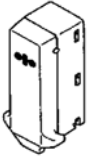
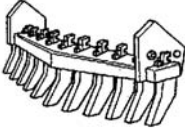
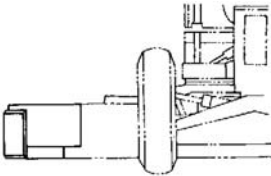
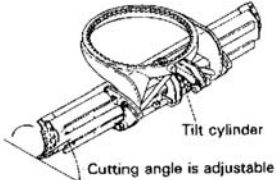
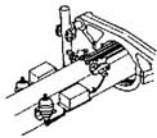
Description	Features
<p>Front blade</p> 	<p>It is an indispensable work tool for volume push - carry operations and for facilitating difficult spreading jobs involving large heaps of slabby or rocky materials unloaded from dump trucks.</p>
<p>Front pull hook</p> 	<p>Hook mounted front of the machine for towing. There are two kind of front hooks.</p> <ul style="list-style-type: none"> • Front weight with nails. • U - shape bracket welded on front axle. <p>If front attachments (for example front blade etc), are equipped, this hook is not available.</p>
<p>Push plate</p> 	<p>This is used for pushing trees down or pushing machine up in muddy terrain. This is used also as a counterweight to prevent the front wheels from coming off the ground during ripping operations.</p>
<p>Scarifier</p> 	<p>This attachment digs up hard ground, like asphalt, old pavement and frozen surfaces cannot be removed by the blade. The number of teeth used depends upon the ground hardness. High-strength alloy steel tips can be mounted on the teeth to prevent tooth wear and extend their service for economical performance.</p>
<p>Extension blade</p> 	<p>By extending the blade length on one side or on both sides, a larger operating width is obtained, so the work can be carried out with high efficiency. This can only be used for light duty operations such as leveling soil. It is not possible to carry out bank cutting with extension blade at the bottom.</p>
<p>Hydraulic blade tip control</p>  <p>Tilt cylinder Cutting angle is adjustable.</p>	<p>Adjusts the blade - cutting angle according to ground and travel - speed conditions. The angle is freely controlled with a lever operable from the operator's seat.</p>
<p>Blade accumulator</p> 	<p>To relieve the shock caused by load when using the blade. The load on the blade is kept constant without any need to operate the blade lift lever, so blade operations are easy.</p>

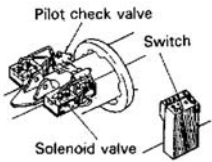
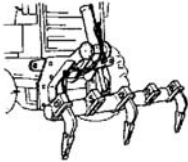
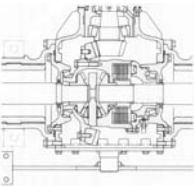
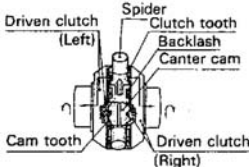
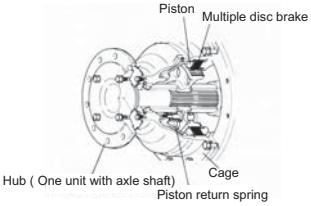
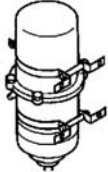
Description	Features
<p>Blade float</p> 	<p>By setting the hydraulic pressure inside the blade lift cylinder to 0, so that only the weight of the blade is applied to the digging surface, operations such as removing grass become easier.</p>
<p>Rear mounted ripper</p> 	<p>This attachment can be used to dig out rocks or hard ground not removable by scarifier. A push plate must be mounted at the same time, and the small front weight must be removed.</p>
<p>Lock / unlock differential gear</p> 	<p>The differential built in the final drive case provides the following precise operations. Excellent leveling even when the machine is turning a corner. Reduced turning radius. Reduced tire wear. By locking the differential, sufficient traction is obtained even in muddy terrain. Lock or unlock are selectable by turning a switch.</p>
<p>Non - spin differential</p> 	<p>Depending on the ground condition, the locking and unlocking are automatically switched. The advantages are the same as for the lock / unlock differential given above.</p>
<p>Wet type disc brake</p> 	<p>The brakes are sealed type, so no water or mud can get in. This ensures stable braking at all times. Oil lubrication means wear is kept to the minimum, so the brakes are maintenance free. The brakes are operated pneumatically, so a small operating effort of brake pedal gives secure braking. There are two brake circuits, so even if one of the air circuits should be damaged, it is still possible to brake the machine.</p>
<p>Air dryer</p> 	<p>The function of the air dryer is to remove the water vapor from the compressed air in the circuit. In this way it protects the components of the equipment and prevents problems in operation in cold areas.</p>
<p>Inspection lamp</p>	<p>This is used for inspection and maintenance at night.</p>
<p>Yellow warning lamp</p>	<p>Signifies that the machine is in operation.</p>
<p>License - plate lamp</p>	<p>Lamp for lighting license plate</p>

CONTENTS

INDEX

SECTION **6**

BACKHOE LOADERS Sec 6



SECTION **6**

BACKHOE LOADERS

CONTENTS

Features	6-2
Specifications	6-3
Dimensions	6-4

■ Built with proven HydrauMind excavator technology

- Komatsu's exclusive HydrauMind™ hydraulic system is the ultimate combination of power and precision creating one of the most productive backhoe loaders in the world.
 - Closed center Load Sensing System (CLSS)
 - Load Independent Flow Divider (LIFD) hydraulic valve block
 - 2 working modes for backhoe operations
 - Speed-Up function for loader operations

■ Superior lift capacities and breakout forces

- Komatsu's superior lift capacities and breakout forces are achieved exclusively through the HydrauMind hydraulic system.
- The front loader has superb breakout forces and lift capacity due in part to the unique design of the loader.

■ Komatsu's ergonomic innovations create the perfect operating environment.

- We ergonomically designed the controls offering ease of operation, using a hydraulic system that responds smoothly and precisely.
- The cab allows for all-around visibility and is extremely quiet.
- The ergonomically designed suspension seat is very comfortable and fully adjustable.

■ Multi-function loader control lever's cutting edge design allows for fingertip operation of all key loader functions.

- Transmission disconnect
- Auxiliary hydraulic control
- Rear differential lock
- Hydraulic speed up function
- Kick down (PS version only)

■ Low lever efforts allow for PPC-like feel during backhoe operation.

■ All-around visibility, compactness and maximum accessibility for maintenance.

■ Powered by a new generation of Komatsu engines.

The large cubic displacement of engines, ensures high torque and power, and above all, exceptional reliability.

■ Komatsu Backhoe Loaders use service brakes with multiple wet discs and independent circuits operated by two separate pedals.

■ A high steering angle combined with excellent maneuverability result in fast cycle times for the operator.

■ Komatsu's backhoe loaders are equipped with Power Shuttle transmissions and "Power shift" inverters.

■ Komatsu's Electronic Gear Management (EGM) system allows the operator to utilize the Powershift transmission in either manual or automatic mode.

The Komatsu Powershift transmission has been designed to safely allow the operator to perform all functions efficiently. In addition to offering two modes of operation, the Powershift comes standard with:

- Self diagnostics system
- Anti-theft system
- Engagement and automatic disengagement of four wheel drive
- Kick down switch

Item		Model	WB93R-5E0	WB93S-5E0	WB97R-5E0	WB97S-5E0
OPERATING WEIGHT*		kg (lb)	8070 (17,790)	8550 (18,850)	8160 (17,990)	8700 (19,180)
HORSEPOWER: SAE J1995: Gross ISO9249/SAE J1349: Net		kW (HP)/rpm kW (HP)/rpm m ³ (cu.yd)	74 (99.2)/2200 1.03 (1.35)	74 (99.2)/2200 1.10 (1.43)	74 (99.2)/2200 1.03 (1.35)	74 (99.2)/2200 1.10 (1.43)
LOADER BUCKET CAPACITY						
PERFORMANCE:						
Travel speeds:		km/h (MPH)				
Forward Working	1st		6 (3.7)	6 (3.7)	6.5 (4.0)	6.5 (4.0)
	2nd		10 (6.2)	10 (6.2)	11 (6.8)	11 (6.8)
	3rd	Travel	23 (14)	23 (14)	23 (14)	23 (14)
	4th		40 (25)	40 (25)	40 (25)	40 (25)
Reverse Working	1st		6 (3.7)	6 (3.7)	6.5 (4.0)	6.5 (4.0)
	2nd		10 (6.2)	10 (6.2)	11 (6.8)	11 (6.8)
	3rd	Travel	23 (14)	23 (14)	23 (14)	23 (14)
	4th		40 (25)	40 (25)	40 (25)	40 (25)
Turning radius* (Outside corner of bucket)		mm (ft.in)	4350 (14'3")	4770 (15'8")	4350 (14'3")	4770 (15'8")
DIMENSIONS*:						
Overall length***		mm (ft.in)	5817 (19'1")	5880 (19'4")	5933 (19'6")	5856 (19'3")
Overall width		mm (ft.in)	2320 (7'7")	2420 (7'11")	2320 (7'7")	2420 (7'11")
Overall height**		mm (ft.in)	2900 (9'6")	2820 (9'3")	2900 (9'6")	3009 (9'10")
Wheelbase		mm (ft.in)	2173 (7'2")	2215 (7'3")	2173 (7'2")	2215 (7'3")
Treads (front)		mm (ft.in)	1910 (6'3")	1950 (6'5")	1910 (6'3")	1950 (6'5")
Treads (rear)		mm (ft.in)	1800 (5'11")	1950 (6'5")	1800 (5'11")	1950 (6'5")
Articulation angle (each)		degree	—	—	—	—
ENGINE:						
Model			KOMATSU SAA4D104E-1	KOMATSU SAA4D104E-1	KOMATSU SAA4D104E-1	KOMATSU SAA4D104E-1
No. of cylinders- bore × stroke		mm (in)	4-104 × 132 (4.1 × 5.2)	4-104 × 132 (4.1 × 5.2)	4-104 × 132 (4.1 × 5.2)	4-104 × 132 (4.1 × 5.2)
Piston displacement		ltr. (cu.in)	4.485 (274)	4.485 (274)	4.485 (274)	4.485 (274)
CAPACITY:						
Fuel tank		ltr. (U.S. Gal)	150 (39.6)	150 (39.6)	150 (39.6)	150 (39.6)

* With standard tires and bucket

** Height to top of the cab

*** Transport length

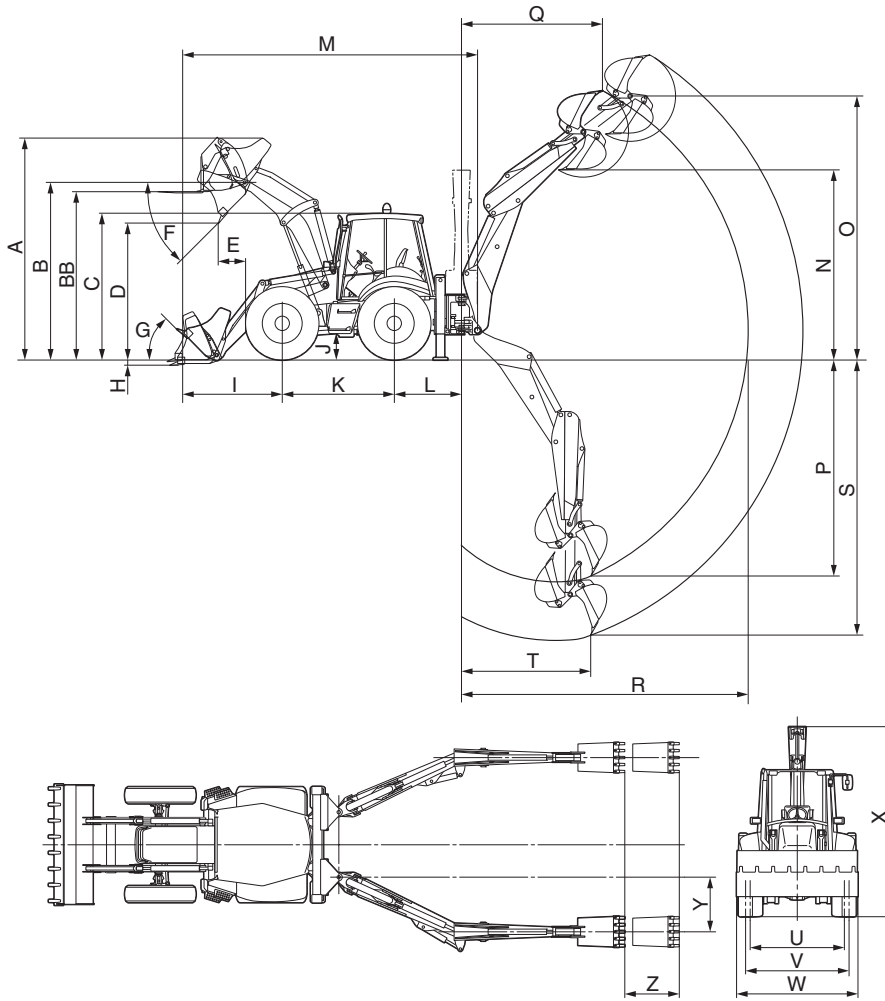

FVBH0330

	A mm (ft.in)	B mm (ft.in)	BB mm (ft.in)	C mm (ft.in)	D mm (ft.in)	E mm (ft.in)	F deg.	G deg.	H mm (ft.in)	I mm (ft.in)	J mm (ft.in)	K mm (ft.in)	L mm (ft.in)
WB93R-5E0	4298 (14'1")	3428 (11'3")	3182 (10'3")	2900 (9'6")	2778 (9'1")	724 (2'5")	43	45	137 (5.4")	2017 (6'7")	416 (1'4")	2173 (7'2")	1325 (4'4")
WB93S-5E0	4267 (14'0")	3480 (11'5")	3165 (10'5")	2960 (9'9")	2820 (9'3")	650 (2'2")	40	45	184 (7.2")	2056 (6'9")	450 (1'6")	2215 (7'3")	1325 (4'4")
WB97R-5E0	4298 (14'1")	3428 (11'3")	3182 (10'3")	2900 (9'6")	2778 (9'1")	724 (2'5")	43	45	137 (5.4")	2133 (7'0")	380 (1'3")	2173 (7'2")	1325 (4'4")
WB97S-5E0	4317 (14'2")	3530 (11'7")	3215 (10'7")	3009 (9'10")	2870 (9'5")	595 (1'11")	40	45	134 (5.3")	2143 (7'0")	455 (1'6")	2215 (7'3")	1325 (4'4")

	M mm (ft.in)	N mm (ft.in)	O mm (ft.in)	P mm (ft.in)	Q mm (ft.in)	R mm (ft.in)	S mm (ft.in)	T mm (ft.in)	U mm (ft.in)	V mm (ft.in)	W mm (ft.in)	X mm (ft.in)	Y mm (ft.in)	Z mm (ft.in)
WB93R-5E0	5817 (19'1")	3720 (12'2")	5792 (19'0")	4257 (14'0")	2554 (8'5")	5754 (18'11")	4977 (16'4")	1973 (6'6")	1800 (5'11")	1910 (6'3")	2320 (7'7")	3750 (12'4")	605 (2'0")	1140 (3'9")
WB93S-5E0	5880 (19'3")	3800 (12'6")	5830 (19'2")	4158 (13'8")	2454 (8'1")	5760 (18'11")	4850 (15'11")	1990 (6'6")	1950 (6'5")	1950 (6'5")	2420 (7'11")	3850 (12'8")	605 (2'0")	1140 (3'9")
WB97R-5E0	5933 (19'6")	3895 (12'9")	6011 (19'9")	4557 (14'11")	2760 (9'1")	6039 (19'10")	5270 (17'3")	1973 (6'6")	1800 (5'11")	1910 (6'3")	2320 (7'7")	3750 (12'4")	605 (2'0")	1240 (3'9")
WB97S-5E0	5856 (19'3")	4050 (13'3")	6100 (20'0")	4410 (14'6")	2655 (8'9")	6040 (19'10")	5050 (16'7")	1990 (6'6")	1950 (6'5")	1950 (6'5")	2420 (7'11")	3895 (12'9")	605 (2'0")	1240 (3'9")

CONTENTS

INDEX

SECTION **7**

SKID STEER LOADERS	Sec 7A
COMPACT TRACK LOADERS	Sec 7B

SECTION **7A**

SKID STEER LOADERS

CONTENTS

Features 7A-2
Specifications 7A-3
Dimensions 7A-4

- **Hydraulic servo controls**
Easier to use, they require very little effort, while ensuring extremely precise maneuvers.
- **Komatsu CLSS**
The hydraulic system, which automatically combines force and speed, ensures perfect control overall movements.
Double-adjustment travel pumps, with automatic power control device (A. P. C.) and axial piston engines with double travel speed, provide above-standard performance, ensuring exceptional versatility and rapidity.
- **Comfort**
The ease of operation, just two steps to reach the seat, the ergonomic access and the ample space inside the cab assure maximum operating comfort and maximum visibility.
- **Safety**
The wheelbase and axle distance ensure reduced tire wear and balanced weight distribution, for safe operation on any ground. The low profile of the engine hood guarantees excellent visibility on rear part of the machine.
- **Versatility**
The foot accelerator ensures greater control over power during operation.
Ready for use with any equipment, the base version features an auxiliary hydraulic circuit with proportional control.
- **Super flow version**
The Super Flow system increases the flow of oil available to the equipment, and features a draining system and electrical connections. The joysticks and proportional pedal make it possible to control all the system functions. A second hydraulic circuit is available for equipment that requires simultaneous movements.
- **Easy and quick maintenance**
The simple opening of the engine hood makes refilling and periodical checks easy. In addition, the tilting radiators can be easily reached by simply opening the rear door.
One lock only for the hood and the door, which together enclose and protect all service and refill points.
 - Pins with extended greasing intervals (250 hours)
 - Battery with charge gauge
 - Air filter with safety cartridge
 - Removable polyvinyl tank
 - See-through gas oil filter
 - Environmental-friendly draining systems
- **Tilting cab**
The combined tilting of the cab, engine hood and footboard (patented system) offers complete access to all the components and allows extraordinary maintenance operations to be performed from several positions.

Specifications

SKID STEER LOADERS

Item		Model	SK510-5	SK714-5	SK815-5	SK818-5
OPERATING WEIGHT*	kg (lb)		1855 (4,090)	2530 (5,580)	2890 (6,370)	2910 (6,415)
HORSEPOWER: ISO 9247 (net engine power)	kW (HP)/rpm		22.5 (30.2)/2800	33.6 (45.1)/2800	35.2 (47.2)/2800	33.6 (45.1)/2800
BUCKET CAPACITY	m ³ (cu.yd)		0.23 (0.30)	0.35 (0.46)	0.4 (0.52)	0.4 (0.52)
PERFORMANCE:						
Rated operating capacity	kg (lb)		455 (1,000)	650 (1,430)	700 (1,540)	870 (1,920)
Tipping load	kg (lb)		910 (2,010)	1300 (2,870)	1400 (3,090)	1740 (3,840)
Travel speeds:	km/h (MPH)					
Forward Working			10 (6.2)	10.5 (6.5)	10.5 (6.5)	10 (6.2)
Travel				16 (9.9)	16 (9.9)	16 (9.9)
Reverse Working			10 (6.2)	10.5 (6.5)	10.5 (6.5)	10 (6.2)
Travel				16 (9.9)	16 (9.9)	16 (9.9)
Turning radius* (Outside corner of bucket)	mm (ft.in)		1700 (5'7")	2100 (6'11")	2015 (6'7")	2015 (6'7")
DIMENSIONS*:						
Overall length	mm (ft.in)		2920 (9'7")	3200 (10'6")	3350 (11'0")	3350 (11'0")
Overall width	mm (ft.in)		1260 (4'2")	1550 (5'1")	1730 (5'8")	1730 (5'8")
Overall height**	mm (ft.in)		1925 (6'4")	1960 (6'5")	2000 (6'7")	2000 (6'7")
Wheelbase	mm (ft.in)		825 (2'8")	950 (3'1")	1050 (3'5")	1050 (3'5")
Treads (front and rear)	mm (ft.in)		1010 (3'4")	1250 (4'1")	1385 (4'7")	1385 (4'7")
ENGINE:						
Model			KOMATSU 3D84E-5KFC	KOMATSU 4D88E-5KFD	KOMATSU S4D84E-6BHFD	KOMATSU 4D88E-5KFD
No. of cylinders- bore × stroke	mm (in)		3-84 × 90 (3.31 × 3.54)	4-88 × 90 (3.46 × 3.54)	4-84 × 90 (3.31 × 3.54)	4-88 × 90 (3.46 × 3.54)
Piston displacement	ltr. (cu.in)		1.50 (91.5)	2.19 (134)	2.00 (122)	2.19 (134)
CAPACITY:						
Fuel tank	ltr. (U.S. Gal)		38.5 (10.2)	53 (14.0)	68 (18.0)	47 (12.4)

Item		Model	SK820-5			
OPERATING WEIGHT*	kg (lb)		2940 (6,480)			
HORSEPOWER: SAE	kW (HP)/rpm		35.2 (47.2)/2600			
BUCKET CAPACITY*	m ³ (cu.yd)		0.4 (0.52)			
PERFORMANCE:						
Rated operating capacity	kg (lb)		900 (1,980)			
Tipping load	kg (lb)		1800 (3,970)			
Travel speeds:	km/h (MPH)					
Forward Working			10.5 (6.5)			
Travel			16 (9.9)			
Reverse Working			10.5 (6.5)			
Travel			16 (9.9)			
Turning radius* (Outside corner of bucket)	mm (ft.in)		2015 (6'7")			
DIMENSIONS*:						
Overall length	mm (ft.in)		3350 (11'0")			
Overall width	mm (ft.in)		1730 (5'8")			
Overall height**	mm (ft.in)		2000 (6'7")			
Wheelbase	mm (ft.in)		1050 (3'5")			
Treads (front and rear)	mm (ft.in)		1385 (4'7")			
ENGINE:						
Model			KOMATSU S4D84E-6BMFD			
No. of cylinders- bore × stroke	mm (in)		4-84 × 90 (3.31 × 3.54)			
Piston displacement	ltr. (cu.in)		2.00 (122)			
CAPACITY:						
Fuel tank	ltr. (U.S. Gal)		68 (18.0)			

* With standard tires and bucket

** Height to top of the cab

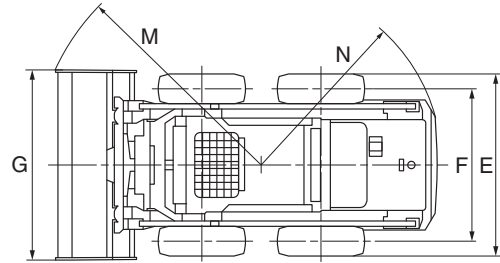
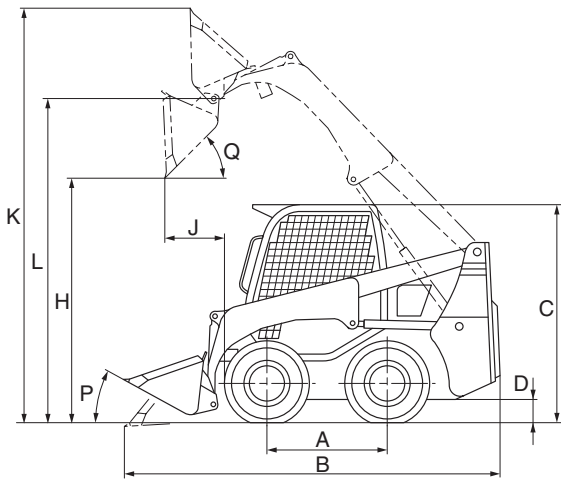

FVBH0216

Model		SK510-5	SK714-5	SK815-5	SK818-5
A: Wheel base	mm (ft.in)	825 (2'8")	950 (3'1")	1050 (3'5")	1050 (3'5")
B: Overall length	mm (ft.in)	2920 (9'7")	3200 (10'6")	3350 (11'0")	3350 (11'0")
C: Overall height	mm (ft.in)	1925 (6'4")	1960 (6'5")	2000 (6'6")	2000 (6'6")
D: Ground clearance	mm (in)	185 (7.3")	210 (8.3")	210 (8.3")	210 (8.26")
E: Width over tires	mm (ft.in)	1235 (4'1")	1520 (5'0")	1660 (5'5")	1660 (5'5")
F: Tread	mm (ft.in)	1010 (3'4")	1250 (4'1")	1385 (4'7")	1385 (4'5")
G: Bucket width	mm (ft.in)	1260 (4'2")	1550 (5'1")	1730 (5'8")	1730 (5'7")
H: Dumping clearance, max. height	mm (ft.in)	2080 (6'10")	2140 (7'0")	2190 (7'2")	2280 (7'5")
J: Reach at max. height	mm (ft.in)	410 (1'4")	510 (1'8")	530 (1'9")	775 (2'6")
K: Operating height (fully raised)	mm (ft.in)	3485 (11'5")	3630 (11'11")	3730 (12'3")	3820 (12'6")
L: Hinge pin height, max. height	mm (ft.in)	2710 (8'11")	2850 (9'4")	2920 (9'7")	3000 (9'10")
M: Turning radius at bucket corner	mm (ft.in)	1700 (5'7")	2100 (6'11")	2015 (6'7")	2015 (6'7")
N: Turning radius at rear tail corner	mm (ft.in)	1410 (4'8")	1340 (4'5")	1615 (5'4")	1665 (5'5")
P: Tilt back angle, carry position	degree	37	30	30	30
Q: Dump angle, max. height	degree	38	45	45	45

Model		SK820-5			
A: Wheel base	mm (ft.in)	1050 (3'5")			
B: Overall length	mm (ft.in)	3350 (11'0")			
C: Overall height	mm (ft.in)	2000 (6'7")			
D: Ground clearance	mm (in)	210 (8.3")			
E: Width over tires	mm (ft.in)	1660 (5'5")			
F: Tread	mm (ft.in)	1385 (4'6")			
G: Bucket width	mm (ft.in)	1730 (5'8")			
H: Dumping clearance, max. height	mm (ft.in)	2280 (7'5")			
J: Reach at max. height	mm (ft.in)	775 (2'7")			
K: Operating height (fully raised)	mm (ft.in)	3820 (12'6")			
L: Hinge pin height, max. height	mm (ft.in)	3000 (9'10")			
M: Turning radius at bucket corner	mm (ft.in)	2015 (6'7")			
N: Turning radius at rear tail corner	mm (ft.in)	1667 (5'6")			
P: Tilt back angle, carry position	degree	30			
Q: Dump angle, max. height	degree	45			

SECTION **7B**

**COMPACT TRACK
LOADERS**

CONTENTS

Features 7B-2
Specifications 7B-3
Dimensions 7B-4

- **Hydraulic servo-controls**

The PPC servo-controls make the machines extremely user friendly: natural movements and unique efficiency come with minimum effort. The right joystick controls the arm and the bucket, while the left one controls the transmission.

- **Versatility**

Thanks to the wide supporting surface the tracks offer, the CKs can efficiently work on any type of soil, including mud and snow, thus minimizing downtime related to bad weather. Furthermore, as the ground pressure is much lower than the one characterizing the wheeled versions, these machines can work at their best even on yielding soil, such as sand.

- **The tracks**

The tracks ensure exceptional stability and traction force on all types of soil. The wide base gives excellent stability to the machine and strongly reduces vibrations and increases operator comfort. The hard steel ensures high resistance to all parts which are most subject to wear, such as gears, rollers and idlers. At the same time, a bigger section and multiple rubber covered steel reinforcements ensure extended duration to the shoes.

- **Two speeds**

The second speed, which is standard, pushes the up to a 12 km/h top speed and drastically reduces the transfer times within the yard, thus increasing the productivity. The first speed is used while digging or climbing, whenever maximum drawbar pull is required.



Specifications

COMPACT TRACK LOADERS

Item	Model	CK20-1	CK25-1		
OPERATING WEIGHT*	kg (lb)	3750 (7,870)	3820 (8,420)		
HORSEPOWER: SAE	kW (HP)/rpm	51.8 (69.5)/2500	51.8 (69.5)/2500		
BUCKET CAPACITY*	m ³ (cu.yd)	0.4 (0.52)	0.4 (0.52)		
PERFORMANCE:					
Rated operating capacity	kg (lb)	930 (2,050)	1000 (2,200)		
Tipping load	kg (lb)	2660 (5,860)	2860 (6,310)		
Travel speeds:	km/h (MPH)				
Forward Working Travel		12.0 (7.5)	12.0 (7.5)		
Reverse Working Travel		12.0 (7.7)	12.0 (7.7)		
Turning radius* (Outside corner of bucket)	mm (ft.in)	2100 (6'11")	2100 (6'11")		
Ground pressure	kg/cm ² (PSI)	0.37 (5.26)	0.37 (5.26)		
DIMENSIONS*:					
Overall length	mm (ft.in)	3375 (11'1")	3375 (11'1")		
Overall width	mm (ft.in)	1730 (5'8")	1730 (5'8")		
Overall height**	mm (ft.in)	2070 (6'10")	2070 (6'10")		
Length of track on ground	mm (ft.in)	1450 (4'9")	1450 (4'9")		
Track gauge	mm (ft.in)	1350 (4'5")	1350 (4'5")		
Shoe width	mm (in)	320 (12.6)	320 (12.6)		
ENGINE:					
Model		KOMATSU 4D98E-2	KOMATSU 4D98E-2		
No. of cylinders- bore × stroke	mm (in)	4-98 × 110 (3.85 × 4.33)	4-98 × 110 (3.85 × 4.33)		
Piston displacement	ltr. (cu.in)	3.32 (203)	3.32 (203)		
CAPACITY:					
Fuel tank	ltr. (U.S. Gal)	64 (16.9)	64 (16.9)		

* With standard shoe and bucket

** Height to top of the cab

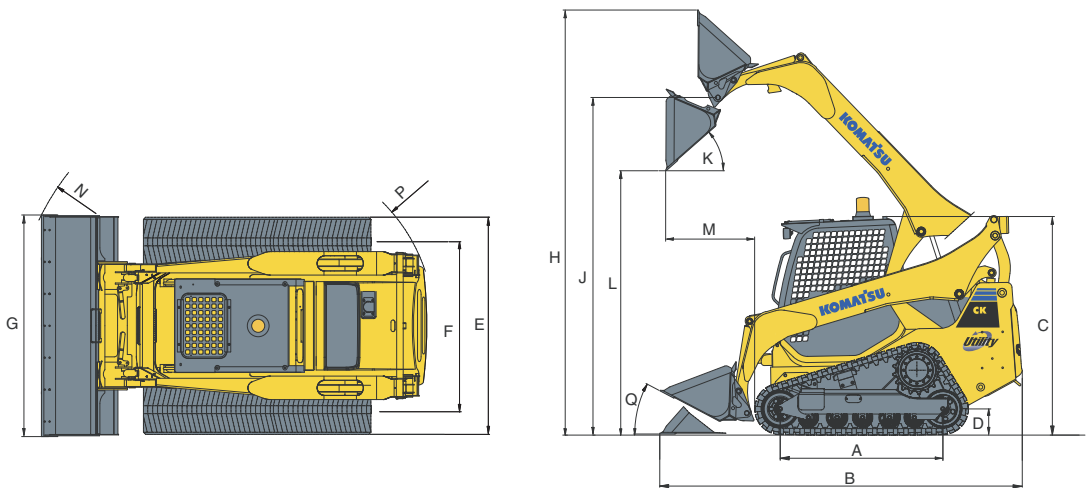

Item	Model	CK20-1	CK25-1		
A: Length of track on ground	mm (ft.in)	1450 (4'9")	1450 (4'9")		
B: Overall length	mm (ft.in)	3375 (11'1")	3375 (11'1")		
C: Overall height	mm (ft.in)	2070 (6'1")	2070 (6'1")		
D: Ground clearance	mm (in)	240 (9.4")	250 (9.8")		
E: Width over track	mm (ft.in)	1670 (5'6")	1670 (5'6")		
F: Track gauge	mm (ft.in)	1350 (4'5")	1350 (4'5")		
G: Bucket width	mm (ft.in)	1730 (5'8")	1730 (5'8")		
H: Operating height (fully raised)	mm (ft.in)	3750 (12'4")	3820 (12'6")		
J: Hinge pin height, max. height	mm (ft.in)	2960 (9'9")	3010 (9'11")		
K: Dump angle at max. height	degree	46	47		
L: Dumping clearance	mm (ft.in)	2190 (7'2")	2270 (7'5")		
M: Reach at max. height	mm (ft.in)	620 (2'0")	450 (1'6")		
N: Turning radius at bucket corner	mm (ft.in)	2100 (6'11")	2100 (6'11")		
P: Turning radius at rear tail corner	mm (ft.in)	1450 (4'9")	1530 (5'0")		
Q: Tilt back angle, carry position	degree	28	28		

CONTENTS

INDEX

SECTION **8**

**MOBILE CRUSHERS
& RECYCLERS Sec 8A**

MOBILE SOIL RECYCLERS Sec 8B

SECTION **8A**

**MOBILE CRUSHERS
& RECYCLERS**

CONTENTS

Benefits 8A-2
Features 8A-3
Type of Crushers/Recyclers 8A-4
Model and Application 8A-5
Specifications 8A-6
Dimensions 8A-7
Productivity 8A-8

Benefits Of Mobile Crusher & Recycler

1. Demolished wasted material (concrete, asphalt, brick, etc.) can be re-used effectively.
2. As the wasted material can be utilized again, the cost for purchasing new material can be saved.
3. The cost for hauling and dumping (of the wasted material) with trucks can be minimized.
4. Even when the processed material should be used outside, the transportation cost can be much saved. (because of the compactness of the material)
5. The elimination of the trucking also offers less generation of the exhaust gas.
6. The machine can be used whenever and wherever you like because of its mobility.

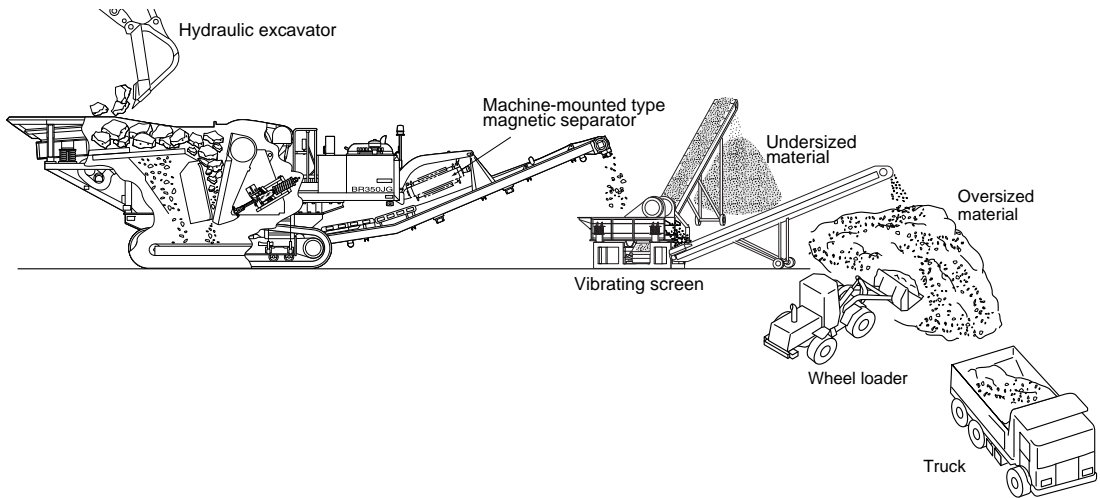

■ **Jaw crusher, with superior crushing force and reliability, is installed.
(BR100JG, BR380JG, BR580JG)**

- Natural rock, concrete, asphalt concrete, etc., can be crushed with strong force.

■ **Easy transportation and superb maneuverability**

- Compact crawler undercarriage is adopted, facilitating job site access/exit.

■ **Semi-Automatic Material Feeding Control is installed**

- The Komatsu original controller optimizes material feeding amount to the crusher.
- Plate feeder with speed controller keeps the operation of crusher uniform and stabilized. Thus, unmanned operation is possible.
(BR100JG, BR380JG, BR580JG)

■ **Simple control and easy operation**

- Raising/lowering of belt conveyor and removal of foreign materials are easy.
Crushing work is facilitated by preventive functions of macadam accumulation and debris clogging.
(BR100JG, BR380JG, BR580JG)

■ **Options for more effective system**

- Ample powered hydraulic-driven optional equipment is available, such as a magnetic separator (chassis mounted), vibratory screen and secondary/tertiary belt conveyors etc., to provide an effective system.

■ **Low-noise and low vibration design**

- Low-noise type engine; sound absorbing material; low-speed high-torque type hydraulic pump; soundproof muffler, etc., are adopted. Thus, overall noise level is low.

■ **Highly reliable hydraulic drive system**

- Crusher, feeder and belt conveyor are driven respectively by independent hydraulic pumps, assuring high reliability and easy maintenance.

Komatsu mobile crushers are classified into 3 types.

The jaw crusher can crush large blocks and is suitable for crushing concrete debris and natural stone. It has a swing jaw plate and fixed jaw plate. Those jaw plates crunch material.

The impact crusher is used for secondary crushing and granulation of asphalt, concrete debris, and natural stone. It produces round grains in many cases and is suitable for production of relatively fine grains. The blocks put in the impact crusher are thrown in the tangential direction by the blow bar of the rotor which is rotating at high speed and are crushed by collision with the impact plate. They are also crushed by collision with each other.

The shear shreds industrial waste as well as bulky domestic refuse to reduce its volume, thereby contributing to extending the service life of disposal sites.

[JAW CRUSHER]

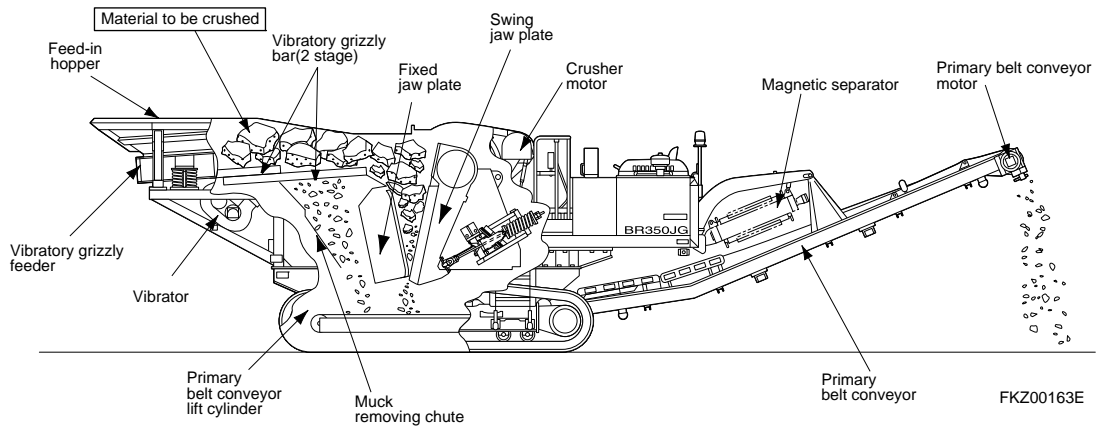

Item		Model	JAW CRUSHER		
			BR100JG-2	BR380JG-1E0	BR580JG-1
MATERIAL	CONCRETE		☉	☉	☉
	NATURAL ROCK, STONE		☉	☉	☉
	ASPHALT		○	○	
	WOOD, TIRE, URBAN WASTE				
MAXIMUM FEED SIZE mm	CONCRETE DEBRIS		600 × 500 × 300	1000 × 900 × 475	1200 × 950 × 600
	NATURAL ROCK, STONE		250 × 250 × 250	425 × 425 × 425	600 × 600 × 600
	CRUSHER OUTPUT		0-40 to 0-80** 0-50 to 0-80***	0-50 to 0-150** 0-50 to 0-150*4	0-55 to 0-200** 0-100 to 0-200***
	CRUSHING CAPACITY		18-56** 20-54***	60-175** 50-240*4	100-460** 130-400***
			mm		
			ton/h		

* Asphalt/concrete debris

** Concrete debris

*** Natural stone (Andesite)

*4 Natural stone (Sandstone)

NOTE: Crushing capacity contains muck.

Item	Model	Jaw crusher		
		BR100JG-2	BR380JG-1E0	BR580JG-1
OPERATING WEIGHT	kg (lb)	9900 (21,830)	34000 (74,960)	49000 (108,000)
HORSEPOWER:				
SAE J1995: Gross	kW(HP)/rpm		149 (200)/2050	262.5 (352)/1900
ISO9249/SAE J1349: Net	kW(HP)/rpm	40.5 (54)/2100	140 (187)/2050	257 (345)/1900
PERFORMANCE:				
Max. feed-in grain size	mm (in)	Concrete debris 600×500×300 (23.6×19.7×11.8)	Concrete debris 475×900×1000 (18.7×35.4×39.4)	600×950×1200 (23.6×37.4×47.2)
Travel speed	km/h (MPH)	2.5 (1.6)	3.0 (1.9)	3.0 (1.9)
CRUSHER:				
Crushing capacity Concrete debris	ton (U.S.ton)/h	18 ~ 56 (20 ~ 62)	60 ~ 175 (66 ~ 193)	110 ~ 460 (121 ~ 507)
Natural stones		20 ~ 54* (33 ~ 60)	50 ~ 240** (55 ~ 265)	180 ~ 400 (198 ~ 441)
ENGINE:				
Model		KOMATSU 4D95LE	KOMATSU SAA6D107E-1	KOMATSU SAA6D125E-5
No. of cylinders- bore × stroke	mm (in)	4-95×115 (3.74×4.53)	6-107×124 (4.21×4.88)	6-125×150 (4.92×5.91)
Piston displacement	ltr. (cu.in)	3.26 (199)	6.69 (408)	11.04 (674)
DIMENSIONS:				
Overall length*4	mm (ft.in)	8070 (26'6")	12500 (41'0")	14540 (47'8")
Overall height (transport)		2700 (8'10")	3200 (10'6")	3820 (12'6")
Overall width (transport)		2200 (7'3")	2810 (9'3")	3090 (10'2")
Length of track on ground		2115 (6'11")	3275 (10'9")	3700 (12'2")
Track gauge		1700 (5'7")	2280 (7'6")	2480 (8'2")
CAPACITY:				
Fuel tank	ltr. (U.S. Gal)	130 (34.3)	400 (106)	650 (172)
Hydraulic tank		90 (23.8)	209 (55.2)	248 (65.5)
Applicable base machine (Engine/undercarriage)		PC60-7/PC58UU-3	PC200-7	

- * Andesite
- ** Sand stones
- *** Concrete debris
- *4 Including conveyor

NOTE: Crushing capacity is the sum of crushed volume and muck removal by the Vibratory Grizzly Feeder.

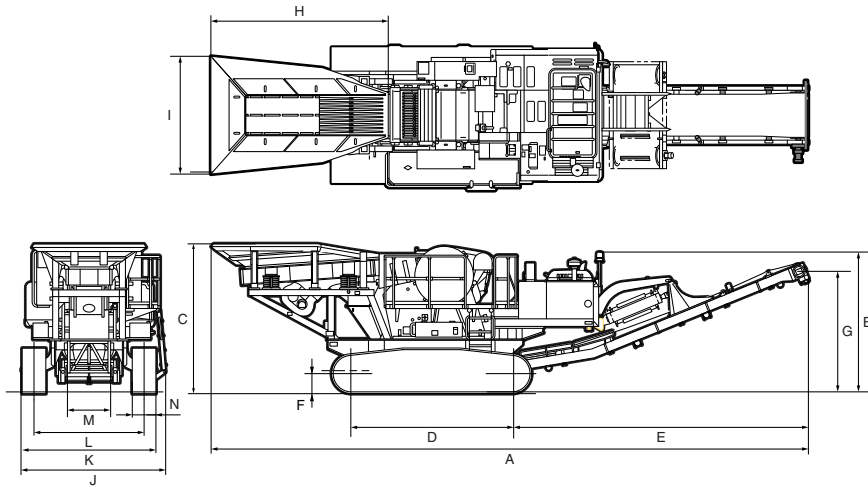

Unit: mm (ft.in)

	BR100JG-2	BR380JG-1E0	BR580JG-1
A	8070 (26'6")	12500 (41'0")	14540 (47'8")
	8070* (26'6")	12500* (41'0")	14495* (47'7")
B	2700 (8'10")	3200 (10'6")	3465 (11'4")
C	2515* (8'3")	3200* (10'6")	3365* (11'0")
	2515 (8'3")	3200 (10'6")	3820 (12'6")
D	2115 (6'11")	3275 (10'9")	3700 (12'2")
E	3795 (12'5")	6080 (20'0")	7060 (23'2")
F	205 (8")	300 (12")	200 (7.9")
G	1500 (4'11")	2800 (9'2")	3000 (9'10")
H	2165 (7'1")	3770 (12'4")	4400 (14'5")
I	1840 (6')	2500 (8'2")	2625 (8'7")
J	2345 (7'8")	—	—
	2200* (7'3")	—	—
K	2100 (6'11")	2780 (9'1")	2980 (9'9")
L	1700 (5'7")	2280 (7'6")	2480 (8'2")
M	600 (24")	1050 (41.3")	1050 (41.3")
N	400 (16")	500 (20")	500 (20")

* at transportation

Calculation of the production capacity of a mobile crusher varies largely with the type of the crusher, properties of supplied material and rocks, quantity of muck in the material, clearance of discharge setting, rotation speed of the crusher, and size of the products required by the customer, etc.

The following are the basic elements for calculation of production capacity of each crusher.

■ Relationship between elements for calculation of production capacity of jaw crusher

Production capacity	Large > Small		Remarks
Clearance of discharge setting	Wide	Narrow	
Hardness of material	Soft	Hard	Hard material may crush easily
Ratio of muck in material (in crusher)	Low	High	
Wetness of material	Dry	Wet	
Impurities in material	Less	Many	
Supply rate in crusher	–	High	Efficiency becomes highest when supply rate is 60 – 70% of volume of crusher.
Size of material	Small	Large	

* When recommending production capacity, confirm the properties of the rock samples from the customer's quarry by crushing them actually.

SECTION **8B**

**MOBILE SOIL
RECYCLERS**

CONTENTS

Features 8B-2
Specifications 8B-3
Dimensions 8B-4

- Waste soil in the course of various construction job site can be processed on site, allowing the soil to be recycled.
- Costs for waste soil disposing, new materials and transportation can be greatly reduced by on site recycling.

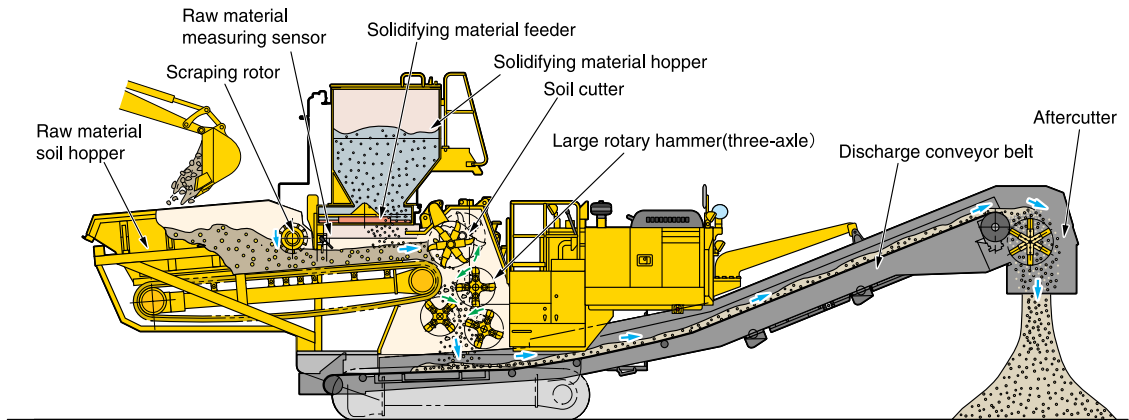

Specifications

MOBILE SOIL RECYCLERS

Item	Model	BZ210
OPERATING WEIGHT	kg (lb)	20500 (45,190)
HORSEPOWER	kW (HP)/RPM	107 (144)/1950
MIXER PERFORMANCE:		
Processing capacity	m ³ /h (cu.yd/h)	40 - 150 (52 -196)
Mixing method		Soil cutter and triple rotary hammer
Row material soil hopper volume	m ³ (cu.yd)	2.0 (2.6)
Max. material size	mm (in)	200 (7.9")
Solidifying material hopper capacity	m ³ (cu.yd)	3.0 (3.9)
Solidifying material feed adjustment range	kg/m ³ (lb/cu.yd)	9 - 400 (15 - 674)
ENGINE:		KOMATSU
Model		SAA6D102E
No. of cylinder- bore × stroke	mm (in)	6-102 × 120 (4.02 × 4.72)
Piston displacement	ltr. (cu.in)	5.88 (359)
DIMENSIONS:		
Overall length*		13210 (43'4")
Overall height (transport)	mm (ft.in)	4560 (15'0")
Overall width (transport)		2850 (9'4")
Length of track on ground		2750 (9')
Track gauge		2350 (7'9")
CAPACITY:		
Fuel tank	ltr. (U.S. Gal)	400 (107)
Hydraulic tank		240 (63)

* Including conveyer

Dimensions

MOBILE SOIL RECYCLERS

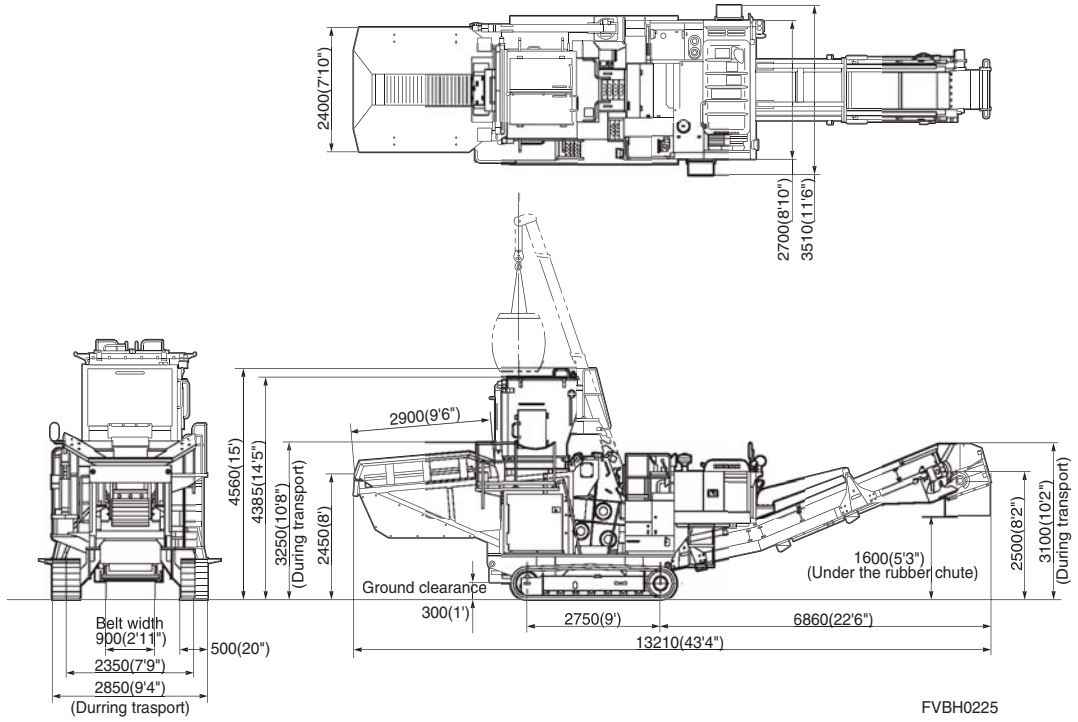

CONTENTS

INDEX

SECTION **9**

FOREST MACHINES	Sec 9
HARVESTERS	Sec 9A
FORWARDERS	Sec 9B
TRACKED FELLER BUNCHERS & HARVESTERS	Sec 9C
HARVESTER HEADS	Sec 9D

SECTION **9**

FOREST MACHINES

CONTENTS

Forest Machines by Komatsu Forest	9-2
---	-----

Komatsu Forest AB is an international group with its head office and technology center in Umea, Sweden. Komatsu Forest produces the Komatsu brand of forestry machines and is one of the world's largest manufacturers of forestry machines. Komatsu Forest has approximately 1,300 employees and is represented on all markets where mechanized forestry is used. The company includes the two manufacturing units Komatsu Forest AB Sweden and Komatsu Forest LLC USA. Komatsu Forest has its own sales companies in Australia, Brazil, Finland, Norway, the United Kingdom, USA, Sweden and Germany. Komatsu Forest AB is owned by the Japanese company Komatsu Ltd.

For more information about Komatsu Forest and Valmet products, visit: www.komatsuforest.com



SECTION **9A**

HARVESTERS

CONTENTS

Features	9A-2
Specifications	9A-3
Dimensions	9A-4
Installation Kit for Komatsu Harvester Heads	9A-5

- **Powerful and efficient engine**

Specially developed engines for forest machines. Six-cylinders turbo diesel with electronic common rail fuel injection which produces a rapid response to increased loads. As it has been specially developed for forest machines, it delivers maximum torque even at low revs. The engines has also been provided with optimized cooling with a computer-controlled fan that detects the temperature. This results in maximum performance combined with reduced fuel consumption. 941 engine fulfils EPA Tier 3 and EU Stage 3A requirements. 901, 911 and 931 fulfill EPA Tier 4 Interim and EU Stage 3B requirements utilizing SCR exhaust after treatment technology.

- **Fast and maneuverable crane**

The cranes are simple and robust and have hydraulic or parallel action. A design with a low centre of gravity and a centrally positioned crane gives an excellent stability. The stabilizer in the rear axle is connected to the cabs and the cranes leveling. With the more lightweight harvester heads the cranes achieves a reach up to 11 meters.

- **Operator comfort**

Leveling produces extremely operator-friendly cabs, where the operator is always sitting flat. This consequently generates extraordinarily good ergonomics, which enable the driver to retain concentration throughout the shift without becoming tired. The slewing cab and the side-mounted crane means that the harvester head is always in focus and the visibility perfect. Low engine noise also contributes to the excellent comfort.

- **Easy maintenance**

The machines are extremely operationally reliable, which minimize the stoppages. They are also easy to maintain and just about all service work can be carried out from ground level. Daily service and checkpoints are naturally easily accessible. Machines are often equipped with centralised greasing system for maximum utilisation of the components which increase durability of the products.

- **Excellent control and information system**

The control and information system, MaxiXplorer, links together the office, the machine and industry in an effective chain. Maxi covers a large number of different programs, for example for machine control, price list management, GIS, production and working info.



901 TX 6WD



911



931



941

Specifications

HARVESTERS

Item		Model	901TX.1	911.5	931.1
OPERATING WEIGHT (approx.) 6WD		kg (lb)	16800 (37,040)	17300 (38,140)	19400 (42,770)
HORSEPOWER (DIN) Gross		kW (HP)/rpm	150 (204)/1900	170 (228)/1700	193 (259)/1700
PERFORMANCE:					
Traction force		kN kgf (lbf)	152 15500 (34,180)	162 16520 (36,430)	175 17850 (39,350)
Travel speed		km/h (MPH) Hi Lo	0 – 25 (15.5) —	0 – 25 (15.5) —	0 – 25 (15.5) —
ENGINE:					
Model			AGCO SISU Power 66AWI	AGCO SISU Power 74AWI	AGCO SISU Power 74AWI
Torque		Nm/rpm	950/1200-1500	1000/1200-1500	1100/1500
HYDRAULIC SYSTEM:					
Hydraulic pump			Variable capacity	Variable capacity	Variable capacity
Max. flow		ltr. (U.S.Gal)/min.	270 (71.3)	310 (81.9)	313 (91)/1650
Working pressure		MPa (PSI)	24.8 (3597)	25 (3625)	27 (3916)
CRANE (BOOM):					
Model			CRH16/CRH16DT	CRH18/CRH18DT	CRH22;9.8m/8.5m
Reach with harvester head		m (ft.in)	10/11 (32'10"/36'1")	10/11 (32'10"/36'1")	9.8/8.5 (32'2"/27'11")
Lifting moment, gross		kNm (lbf-ft)	170 (125,386)	186.0 (137,190)	217 (160,100)
Slewing torque, gross		kNm (lbf-ft)	40.8 (30,110)	40.8 (30,090)	47 (34,670)
WHEEL & AXLES					
Front			650/45 × 24.5 710/40 × 24.5	600/55 × 26.5 710/45 × 26.5	600/55 × 26.5 710/45 × 26.5
Rear			650/45 × 24.5 710/45 × 24.5	600/65 × 34 700/55 × 34 710/55 × 34	600/65 × 34 700/55 × 34
CAPACITY (Refilled)					
Fuel tank		ltr. (U.S. Gal)	370 (98)	370 (98)	370 (98)
Application Harvester Head			Komatsu 340 Komatsu 350.1	Komatsu 350.1 Komatsu 360.2 Komatsu 365	Komatsu 360.2 Komatsu 365 Komatsu 370.2

Item		Model	941.1		
OPERATING WEIGHT (approx.) 6WD		kg (lb)	23500 (51,800)		
HORSEPOWER (DIN) Gross		kW (HP)/rpm	210 (285)/1600		
PERFORMANCE:					
Traction force		kN kgf (lbf)	190 19370 (42,700)		
Travel speed		km/h (MPH) Hi Lo	0 – 25 (15.5) —		
ENGINE:					
Model			AGCO SISU Power 84CTA		
Torque		Nm/rpm	1300/1500		
HYDRAULIC SYSTEM:					
Hydraulic pump			Variable capacity		
Max. flow		ltr. (U.S.Gal)/min.	346 (91)		
Working pressure		MPa (PSI)	26 (3843)		
CRANE (BOOM):					
Model			CRH24;10m/CRH24;8m		
Reach with harvester head		m (ft.in)	10/8.1 (32'10"/26'7")		
Lifting moment, gross		kNm (lbf-ft)	273 (201,300)		
Slewing torque, gross		kNm (lbf-ft)	51 (37,600)		
WHEEL & AXLES					
Front			650/65 × 26.5 750/55 × 26.5		
Rear			700/70 × 34		
CAPACITY (Refilled)					
Fuel tank		ltr. (U.S. Gal)	550 (145)		
Application Harvester Head			Komatsu 370.2 Komatsu 370E		

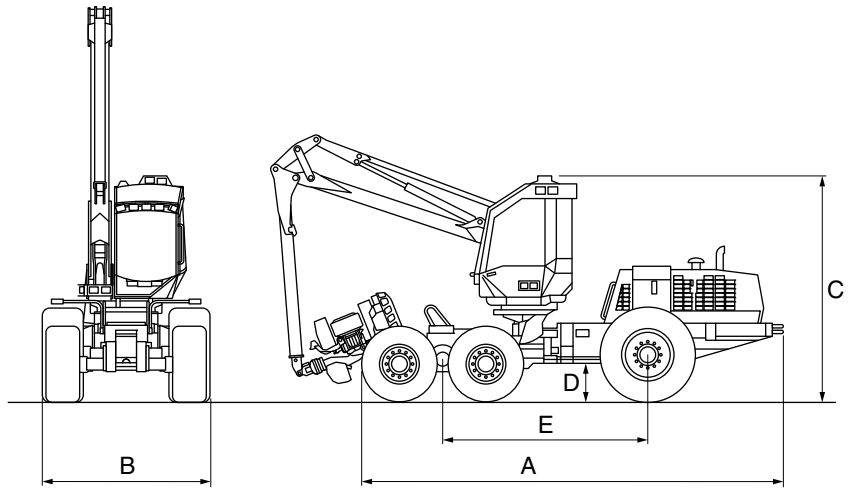

FVBH0366

Item		Model	901TX.1	911.5	931.1	941.1
A Length		mm (ft.in)	7065 (23'2")	7170 (23'6")	7360 (24'2")	8075 (26'6")
B Width	Min.	mm (ft.in)	2735 (9'0")	2730 (8'11")	2730 (8'11")	2980 (9'9")
	Max.	mm (ft.in)	2895 (9'6")	2940 (9'8")	2940 (9'8")	3180 (10'5")
C Height		mm (ft.in)	3735 (12'3")	3740 (12'3")	3910 (12'10")	3995 (13'1")
D Ground clearance		mm (ft.in)	635 (2'1")	650 (2'2")	665 (2'2")	650 (2'2")
E Wheel base		mm (ft.in)	3500 (11'6")	3500 (11'6")	3700 (12'2")	4025 (13'2")

Installation kit for Komatsu harvester heads on Komatsu PC200, PC210 and PC228

Komatsu installation system makes it easy to fit harvester heads to excavators. The kit provides a well-proven and complete solution that easily and inexpensively transforms an excavator into an efficient forestry machine.

The system is especially designed for Komatsu excavators and works with all harvester heads in the Komatsu 300 series. The kit includes complete installation instructions, with hydraulics and electrical diagrams. The thorough documentation ensures high reliability and simplifies troubleshooting.

The installation kit provides rapid access to all necessary components, including the mounting adapter, the hydraulic lines and the electrical circuits. In addition, the kit includes important details for increased operator safety.



MEMO

A series of horizontal dashed lines for writing.

SECTION **9B**

FORWARDERS

CONTENTS

Features 9B-2
Specifications 9B-3
Dimensions 9B-5

- **Powerful engines and a great pulling force**

Six-cylinders (four in 830.3 and 840TX) turbo diesel with electronic common rail fuel injection. The engines has been specially designed for tough forest work and delivers a powerful torque even at lower revs. This produces good traction even with a full load, with an impressive pulling force. 830.3 and 840TX engines fulfil EPA Tier 3 and EU Stage 3A requirements. 855, 865 and 895 fulfill EPA Tier 4 Interim and EU Stage 3B requirements utilizing SCR exhaust after treatment technology.

- **High stability and mobility**

Komatsu well-known, back-to-front center pivot, with the steering joint in the front frame and the articulation in the rear frame provide the machine with extraordinary stability. Very good off-road properties means full use of the machines speed, even in sensitive forests. It creeps forward, following its tracks back and forth, and does not cut corners. The very low centre of gravity, high ground clearance and external dimensions, all contribute to the machines accessibility.

- **Outstanding loader**

Strong and fast loaders with up to 8.5 m (27'11") reach. Great reliability is ensured by the outer boom and lift cylinders, the hose routing and the hose routing between the machine and the crane. Crane maneuvering is smooth thanks to limit dampening. The crane tip solution, Komatsu ProTec means a completely protected hose passage in the crane tip between the crane and grapple and a braking technique that effectively dampens grapple swing.

- **Impressive load capacity**

Komatsu forwarders are true workmates and real pack mules with right qualities to guarantee high productivity. The chassis is of a sturdy design, dimensioned for high tonnages. The load capacity is up to 20 tons and equipped the bunk system, LoadFlex, provides an extra 1.4 m (4'7") bunk width.

- **Optimized comfort**

The cabs are ergonomically designed down to smallest detail. Visibility is always good, whether loading, driving or unloading. Everything is close at hand for the operator, even though the cab is unusually spacious inside. Komatsu cabs are known for low noise and vibration levels. A good operator environment allows operators to concentrate better throughout their work shifts and remain highly productive.

- **Intelligent control and information system**

Komatsu forwarders are fitted with the intelligent and easy-to-use MaxiXplorer control system. It controls all interaction between the machine, the transmission and the crane and ensures that the operator always get the most out of the machine. Operating data collection and production reports are included in the system, which even provides information about forwarders status, running time and total production volume.



830



840TX 8WD/6WD



855 8WD/6WD



865 8WD/6WD

Item		Model	830.3	840TX	855
OPERATING WEIGHT (approx.) 6WD 8WD		kg (lb)	— 10500 (23,150)	13800 (30,420) 14800 (32,630)	15900 (35,030) 17700 (39,020)
HORSEPOWER (DIN) Gross		kW (HP)/rpm	107 (145)/2000	129 (175)/2000	150 (201)/1500-1900
PERFORMANCE: Gross load Bunk area		kgf (lbf) m ² (sq ft)	9000 (19,850) 3.4 - 4.1 (36.6 - 44)	12000 (26,460) 3.2 - 4.1 (34.4 - 44.1)	13000 (28,660) 3.2 - 4.1 (34.4 - 44.1)
Traction power		kN	110	155	164
Travel speed		kgf (lbf) km/h (MPH)	11220 (24,730) 0 - 25 (15)	15810 (34,860) 0 - 23 (14.3)	16720 (36,855) 0 - 20/23 (12.5/14.3)*
ENGINE: Model Torque		Nm/rpm	AGCO SISU Power 44CWA 600/1400	AGCO SISU Power 49CWA 750/1500	AGCO SISU Power 66AWI 950/1200 - 1500
HYDRAULIC SYSTEM: Hydraulic pump Max. flow Working pressure		ltr. (U.S.Gal)/ min. MPa (PSI)	Variable capacity 170 (45) 23.5 (3,410)	Variable capacity 290 (76.6) 23.5 (3,410)	Variable capacity 290 (76.6) 23.5 (3,410)
LOADER AND GRAPLE Loader Lifting torque, gross Slewing torque, gross Reach Grapple		kNm (lbf-ft) kNm (lbf-ft) m (ft.in)	CRF5 74 (54,600) 22 (16,150) 6.85 (22'6") Komatsu G25	CRF 8.1 106.1 (78,300) 28.7 (21,170) 7.8 (25'7") Komatsu G28	CRF 8.1 106.1 (78,300) 28.7 (21,170) 7.8 (25'7") Komatsu G28
WHEEL & AXLES 6WD front 6WD rear 8WD front 8WD rear Turning radius		6WD 8WD mm (ft.in)	— — 600/50 × 22.5 650/45 × 22.5 700/45 × 22.5 710/40 × 22.5 — 6656 (21'10")	— — 710/40 × 24.5 650/45 × 24.5 710/40 × 24.5 650/45 × 24.5 — 7662 (25'2")	— — 600/65 × 34 700/55 × 34 710/55 × 34 600/55 × 26.5 710/45 × 26.5 600/55 × 26.5 710/45 × 26.5 600/55 × 26.5 710/45 × 26.5 — 8200 (26'11")
CAPACITY (Refilled) Fuel tank		ltr. (U.S.Gal)	100 (26.4)	160 (42.3)	165 (43.6)

* Without/with steering wheel

Item		Model	865	890.3	
OPERATING WEIGHT (approx.) 6WD 8WD		kg (lb)	17100 (37,700) 18900 (41,670)	16800 (37,040) 19100 (42,110)	
HORSEPOWER (DIN) Gross		kW (HP)/rpm	158 (212)/1500-1900	170 (231)/1700	
PERFORMANCE: Gross load Bunk area		kgf (lbf) m ² (sq ft)	15000 (33,070) 3.3 - 4.5 (35.5 - 48.4)	18000 (39,680) 5.6 - 6.0 (60.3- 64.6)	
Traction power		kN	193	207	
Travel speed		kgf (lbf) km/h (MPH)	19670 (39150) 0 - 20/23 (12.5/14.3)*	21100 (46535) 0 - 25 (15.5)	
ENGINE: Model Torque		Nm/rpm	AGCO SISU Power 74AWI 1000/1500	AGCO SISU Power 74CTA 1000/1500	
HYDRAULIC SYSTEM: Hydraulic pump Max. flow Working pressure		ltr. (U.S.Gal)/ min. MPa (PSI)	Variable capacity 290 (76.6) 26 (3,770)	Variable capacity 340 (89.8) 23.5 (3,410)	
LOADER AND GRAPLE Loader Lifting torque, gross Slewing torque, gross Reach Grapple		kNm (lb-ft) kNm (lb-ft) m (ft.in)	CRF11 126 (92900) 28.7 (21170) 7.8 (25'7") Komatsu G28	CRF14 155 (114300) 41.3 (30460) 7.5 (24'7") Komatsu G36	
WHEEL & AXLES 6WD front 6WD rear 8WD front 8WD rear Turning radius		6WD 8WD	600/65 x 34 700/55 x 34 710/55 x 34 600/55 x 26.5 710/45 x 26.5 600/55 x 26.5 710/45 x 26.5 600/55 x 26.5 710/45 x 26.5 — 8248 (27'1")	700/70 x 34 650/65 x 26.5 750/55 x 26.5 750/55 x 30.5 650/65 x 26.5 750/55 x 26.5 750/45 x 30.5 650/65 x 26.5 750/55 x 26.5 750/45 x 30.5 9147 (30'0") 9295 (30'6")	
CAPACITY (Refilled) Fuel tank		ltr. (U.S.Gal)	165 (43.6)	210 (55.5)	

* Without/with steering wheel

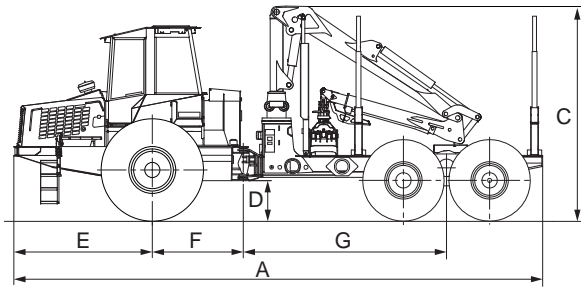
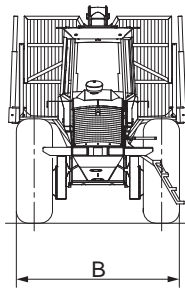

FVBH0361

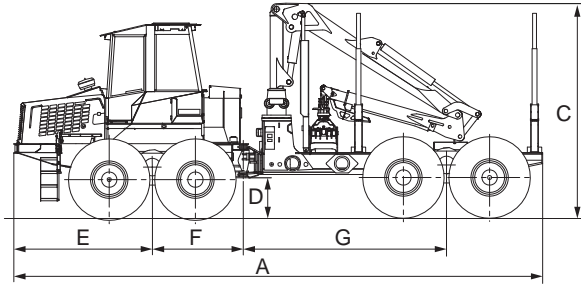
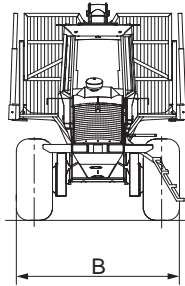

FVBH0362

Item	Model	830.3 (8W)	840TX (6W)	840TX (8W)	855 (6W)
A Length	mm (ft.in)	8122 (26'8")	9020 (29'7")	9020 (29'7")	9829 (32'3")
B Width	mm (ft.in)	2600 (8'6")	2890 (9'6")	2890 (9'6")	2690 (8'10")
C Height	mm (ft.in)	3526 (11'7")	3783 (12'5")	3783 (12'5")	3844 (12'7")
D Ground clearance	mm (ft.in)	622 (2'0")	656 (2'2")	656 (2'2")	643 (2'1")
E From front to front axle	mm (ft.in)	2409 (7'11")	2250 (7'5")	2250 (7'5")	2669 (8'9")
F From front to axle to waist	mm (ft.in)	1850 (6'1")	1670 (5'6")	1670 (5'6")	1750 (5'9")
G From waist to back axle	mm (ft.in)	2300 (7'7")	2997 (9'10")	2997 (9'10")	3296 (10'10")

Item	Model	855 (8W)	865 (6W)	865 (8W)	890.3 (6W)
A Length		9829 (32'3")	9829 (32'3")	9829 (32'3")	9710 (31'10")
B Width	mm (ft.in)	2656 (8'9")	2690 (8'10")	2756 (9'1")	2990 (9'10")
C Height	mm (ft.in)	3844 (12'7")	3844 (12'7")	3844 (12'7")	3950 (13'0")
D Ground clearance	mm (ft.in)	677 (2'3")	643 (2'1")	677 (2'3")	740 (2'5")
E From front to front axle	mm (ft.in)	2669 (8'9")	2669 (8'9")	2669 (8'9")	2540 (8'4")
F From front to axle to waist	mm (ft.in)	1750 (5'9")	1750 (5'9")	1750 (5'9")	1670 (5'6")
G From waist to back axle		3296 (10'10")	3296 (10'10")	3296 (10'10")	3730 (12'3")

Item	Model	890.3 (8W)			
A Length		9710 (31'10")			
B Width	mm (ft.in)	2990 (9'10")			
C Height	mm (ft.in)	3970 (13'0")			
D Ground clearance	mm (ft.in)	760 (2'6")			
E From front to front axle	mm (ft.in)	2540 (8'4")			
F From front to axle to waist	mm (ft.in)	1670 (5'6")			
G From waist to back axle		3730 (12'3")			

MEMO

A series of horizontal dashed lines for writing.

SECTION **9C**

**TRACKED FELLER
BUNCHERS &
HARVESTERS**

CONTENTS

Features 9C-2
Specifications 9C-3
Dimensions 9C-4

- Unique set back boom design offers a greater working range. Numerous boom options ranging from 6.53m - 9.42m (21'5" - 30'11"), providing excellent stability and a wide cutting sweep for long reach harvesting or felling. Configuration options designed to best suit application demands include: 8 hydraulic systems, 2 booms, 4 arms.
- A powerful Cummins 300hp Tier 3 engine delivers excellent hydraulic performance. An auto-reversing fan helps keep the radiator free of debris. An auxiliary hydraulic oil cooler with temperature controlled fan cools only when needed, saving power and fuel.
- Service features: Swing out doors for good component access. Remote mounted engine oil filter. 24V vacuum pump prevents oil spill during hydraulic system maintenance. Equipped with engine monitoring system.
- Nothing performs like Komatsu's closed loop track drive design. The XT series can simultaneously travel, reach, cut, and swing without compromising between travel and work equipment.
- A well equipped, comfortable cab is designed for efficiency. Controls are positioned to minimize operator fatigue. Large tinted windows provide a commanding view of the work area (an optional sky window is available). Non-glare surfaces eliminate eye strain and keep the operator fresh during long shifts.
- Easy-to-use IQAN digital control system provides smooth machine performance for felling or harvesting configurations. Built-in machine protection systems have active self diagnostics and troubleshooting capability. Joy stick controls are adjustable and programmable allowing operators the flexibility to fine tune their own response characteristics.
- The XT leveling machine's heavy duty two cylinder system provides simultaneous front/rear/side leveling. The leveling cylinders are protected inside the carbody (center frame) which has a flat underside to minimize hang up on stumps and rocks.
- Undercarriage features: Large Komatsu final drives. Komatsu 8.5" (216mm) pitch track → XT430/XT430L. Komatsu 9.0" (230mm) pitch track → XT445/XT450L. Grease sealed track rollers. Integrated welded roller guards with track shoe support. Large track roller debris openings. Choice of track support slides or carrier rollers.

Specifications

**TRACKED FELLER BUNCHERS
& HARVESTERS**

Item	Model	XT430-2	XT430L-2	XT445L-2	XT450L-2
BASE MACHINE WEIGHT	kg (lb)	27660 (60,990)	27290 (60,165)	30390 (67,000)	31520 (69,490)
HORSEPOWER (DIN) Gross	kW (HP)/rpm	224 (300)/2000	224 (300)/2000	224 (300)/2000	224 (300)/2800
PERFORMANCE: Tractive effort Travel speed Swing torque	kgf (lbf) km/h (MPH) kgm (ft-lbs)	28010 (61,775) 4.8 (3.0) 6512 (47,100)	28010 (61,775) 4.8 (3.0) 6512 (47,100)	33710 (74,315) 5.3 (3.3) 6512 (47,100)	33710 (74,315) 5.3 (3.3) 6512 (47,100)
LIFTING CAPACITY (w/o att.) at 3.05 m (10') at 4.57 m (15') at 6.1 m (20')	kg (lb)	11000 (24,250) 8255 (18,200) 5216 (11,500)	11000 (24,250) 8255 (18,200) 5216 (11,500)	11000 (24,250) 8255 (18,200) 5216 (11,500)	11000 (24,250) 8255 (18,200) 5216 (11,500)
ENGINE: Model Torque	kgm (ft-lbs)/rpm	Cummins QSC8.3 138.2 (1000)/1500	Cummins QSC8.3 138.2 (1000)/1500	Cummins QSC8.3 138.2 (1000)/1500	Cummins QSC8.3 138.2 (1000)/1500
HYDRAULIC SYSTEM: Hydraulic pump Max. flow	ltr. (U.S.Gal)/ min.	Variable capacity	Variable capacity	Variable capacity	Variable capacity
Track shoe width/ Ground pressure 600 mm (23.6") single grouser 600 mm (23.6") double grouser 700 mm (27.6") single grouser 700 mm (27.6") double grouser 900 mm (35.4") triple grouser	kg/cm ² (PSI)	0.54 (7.74) — — 0.48 (6.8)	0.57 (8.16) — — 0.50 (7.16)	0.61 (8.74) — 0.54 (7.62) — —	0.64 (9.07) — 0.56 (7.9) — —
CAPACITY (Refilled) Fuel tank	ltr. (U.S.Gal)	852 (225)	700 (185)	700 (185)	1362 (360)

* : With 370 Heavester head

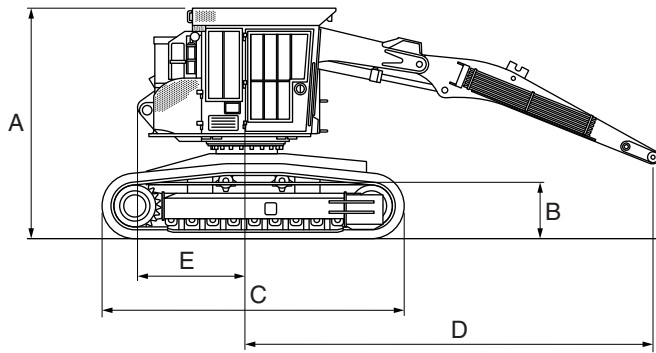

FVBM0363

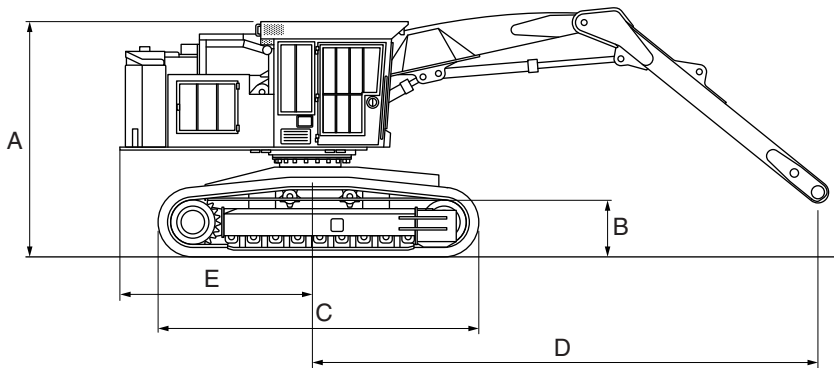

FVBH0364

Item	Model	XT430-2	XT430L-2	XT445L-2	XT450L-2
Overall width	mm (ft.in)				
	STD 600 mm (23.6") shoe	3140 (10'4")	2935 (9'8")	3140 (10'4")	3170 (10'5")
	OPT 700 mm (27.6") shoe	3240 (10'8")	3035 (10'0")	3240 (10'8")	3270 (10'9")
A Overall height	mm (ft.in)	3595 (11'10")	3775 (12'5")	3850 (12'8")	3880 (12'9")
B Ground clearance	mm (ft.in)	730 (2'5")	730 (2'5")	810 (2'8")	810 (2'8")
C Track length	mm (ft.in)	4915 (16'1")	4590 (15'1")	4770 (15'8")	4770 (15'8")
D Reach max.	mm (ft.in)	6530 (21'5")	6530 (21'5")	6530 (21'5")	6530 (21'5")
E Tail swing radius	mm (ft.in)	1470 (4'10")	1470 (4'10")	1470 (4'10")	1470 (4'10")

SECTION **9D**

HARVESTER HEADS

CONTENTS

Specifications and Dimentions 9D-2



Harvester head

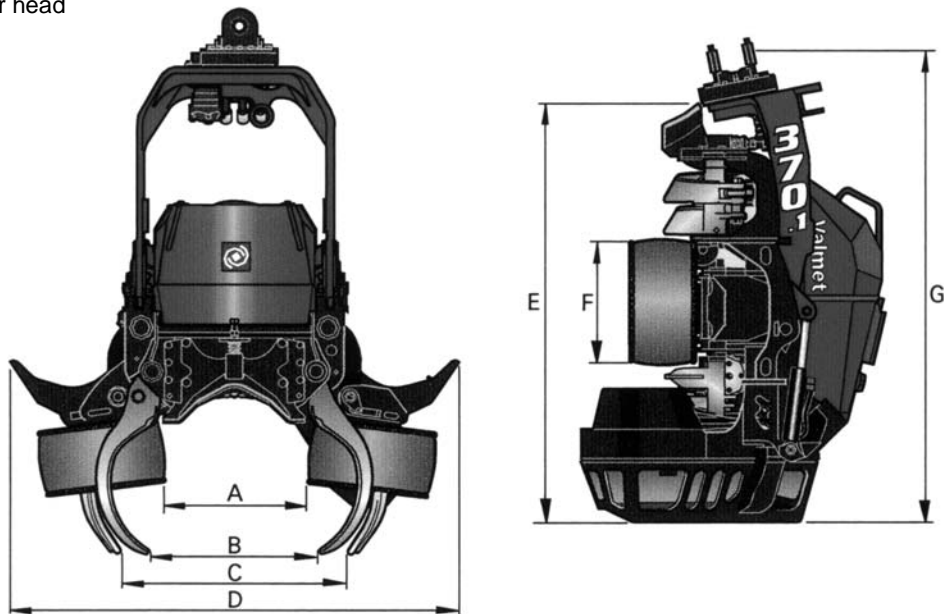

Item	Model	340	350.1	360.2	365
WEIGHT Incl. topping saw	kg (lb)	760 (1,675)	960 (2,116)	1245 (2,744)	1200 (2,646)
Feed force (gross)	kN kgf (lbf)	18 1835 (4,045)	16,5 - 25,3 1680 - 2580 (3,710 - 5,690)*	25.3 2580 (5,690)	23.5 - 28.3 2400 - 2890 (5,306 - 6,362)
Feed speed	m/s (ft/s)	0 - 5 (0 - 16.4)	0 - 5 (0 - 16.4)	0 - 5 (0 - 16.4)	0 - 5 (0 - 16.4)
DIMENSIONS:					
Cutting diameter	mm (in)	530 (20.9")	600 (23.6")	650 (25.6")	650 (25.6")
A Roller opening, max.		420 (16.5")	520 (20.5")	550 (21.7")	650 (25.6")
B Opening upper knives		450 (17.7")	600 (23.6")	640 (25.2")	625 (24.6")
C Opening lower knives		—	—	—	700 (27.6")
D Width max.		1130 (44.5")	1400 (55.1")	1720 (67.7")	1720 (67.7")
E Height to vertical knife		1225 (48.2")	1290 (50.8")	1650 (65.0")	1540 (60.6")
F Roller diameter		—	395 (15.5")	460 (18.1")	470 (18.5")
G Height including rotator		1575 (62.0")	1440 (56.7")	1800 (70.9")	1720 (67.7")

Item	Model	370.2	370E	378	378E
WEIGHT Incl. topping saw	kg (lb)	1470 (3,241)	1600 (3,527)**	2060 (4,541)	1850 (4,078)
Feed force (gross)	kN kgf (lbf)	28.3 - 30.8* 2875 - 3130 (6,340 - 6,900)	21 - 30.8* 2400-3500 (5,280 - 7,710)	36.3/39.6 3700/4040 (8,160/8,905)	26.6 2710 (5,980)
Feed speed	m/s (ft/s)	0 - 5 (0 - 16.4)	0 - 5 (0 - 16.4)	0 - 4.5 (14.8)	0 - 6 (0 - 20)
DIMENSIONS:					
Cutting diameter	mm (in)	700 (27.6")	700 (27.6")	700 (27.6")	650 (25.6")
A Roller opening, max.		600 (23.6")	600 (23.6")	650 (25.6")	645 (25.4")
B Opening upper knives		640 (25.2")	640 (25.2")	675(28.0")	725 (28.5")
C Opening lower knives		750 (29.5")	750 (29.5")	—	—
D Width max.		1950 (76.8")	1950 (76.8")	1650 (65.0")	1560 (61.4")
E Height to vertical knife		1780 (70.1")	1780 (70.1")	—	1650 (65.0")
F Roller diameter		547 (21.5")	547 (21.5")	450 (17.7")	460 (18.1")
G Height including rotator		1920 (75.6")	2080 (81.9")	1995 (78.5")	2000 (78.7")

* Depending on feed roller motor

** Topping saw is discontinued.

Harvester head

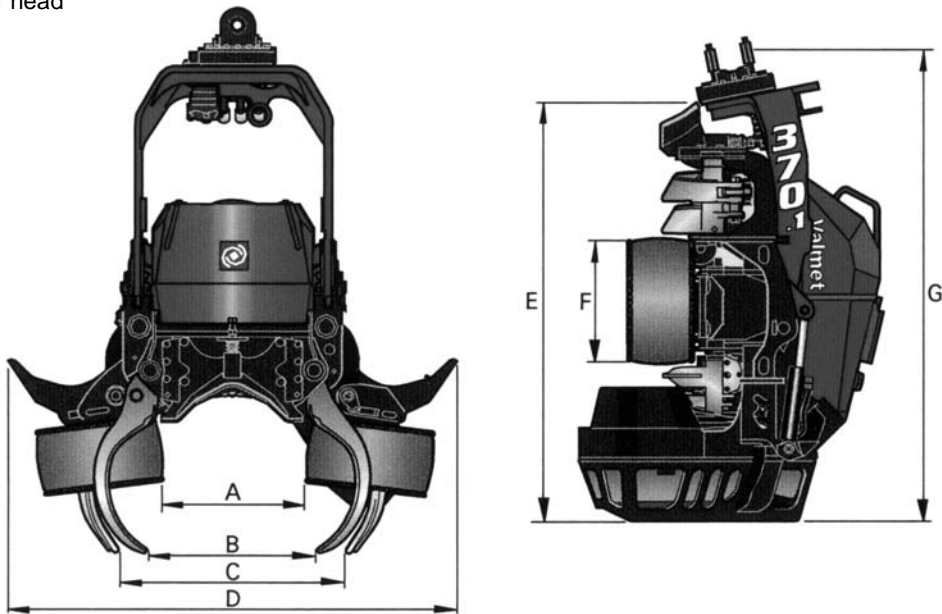

Item	Model	378P	398		
WEIGHT	kg (lb)	1780 (3,924)	2785 (6,140)		
Incl. topping saw					
Feed force (gross)	kN kgf (lbf)	26.6 2710 (5,980)	40 4077 (9000)		
Feed speed	m/s (ft/s)	0 - 6 (0 - 20)	0 - 5 (0 - 16.4)		
DIMENSIONS:					
Cutting diameter	mm (in)	610 (24.0")	780 (31")		
A Roller opening, max.		645 (25.4")	—		
B Opening upper knives		670 (26.4")	800 (32")		
C Opening lower knives		—	—		
D Width max.		1570 (61.8")	1800 (71")		
E Height to vertical knife		—	2025 (80")		
F Roller diameter		460 (18.1")	500 (19.7")		
G Height including rotator		1505 (59.3")	2440 (97")		

* Depending on feed roller motor

** Topping saw is discontinued.

Felling head

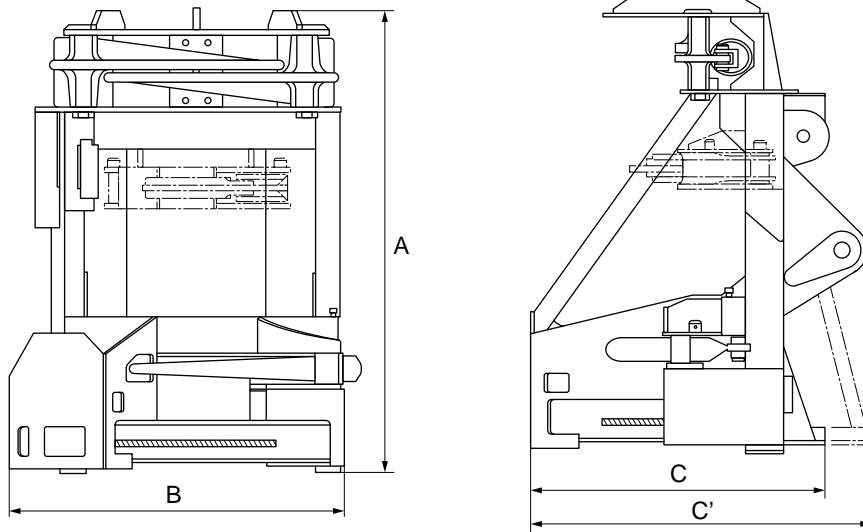

FVBH0458

Item	Model	233	
SPECIFICATIONS			
Bar saw weight	kg (lb)	1640 (3,616)	
Optional accumulator	kg (lb)	159 (350)	
Optional lateral tilt	kg (lb)	231 (510)	
Cutting capacity	mm (in)	609 (28"), 838 (33")	
Cycle time	sec	2 - 7	
Saw bar length	mm (in)	914 (36") or 1092 (43")	
HYDRAULICS			
Hydraulic requirement	ltr (U.S. Gal)/min	132 (35) - 227 (60)	
System pressure	kg/cm ² (PSI)	175 (2,500) - 257 (3,650)	
DIMENSIONS:			
A: Height	mm (in)	1880 (74")	
B: Width	mm (in)	1359 (53.5")	
C: Length	mm (in)	28" Capacity: 1219 (48")	
C': Length	mm (in)	33" Capacity: 1384 (54.5")	

CONTENTS

INDEX

SECTION **10**

GENERATOR SETS Sec 10



SECTION **10**

GENERATOR SETS

CONTENTS

Features	10-2
Specifications	10-3

1. New Engine

Komatsu "Air-to-Air Aftercooled Engine" has been introduced. (Except for EGS45-5 to EGS300-6 , and EGS650-6)

- High Output (Performance)
- Low Fuel Consumption
- Low Noise
- Lighter Weight and Compactness
- Longer Oil Change Interval
- Easy Maintenance
- High Quality, High Reliability, High Durability

2. Easy Operation and Control

2-1.Engine & Generator control panel is arranged in one box, and located in front of Generator.
So the operator can monitor the operating status easily by viewing the meters.

Advantage:

- Simple : Minimized control equipment and wiring
- Easy Maintenance

2-2.Compact Engine Control Unit

EGS Series generators have a compact engine control unit (1 box type) for easy operation and maintenance.

Advantage and Functions

- Microprocessor : Control status and factor are programmed in Microprocessor.
- High Reliability : Engine control circuit is integrated in printed boards.
- Easy selection : A Mode Key Switch for Off / Auto / Manual
- Built-in AMF function : Auto Start / Stop, Cranking with attempts and Cool running are Standard Function.
- Iconic, Symbols and LED : Operating process and Alarm condition can be monitored.

3. High qualified electricity with Brushless, Self-excited AC Alternator

- Maintenance-Free : Brushless, Direct coupling with engine
- High Electric Characteristic : Standard 2/3 pitch windings avoid excessive neutral currents.
- Excellent Voltage Build-Up : Originally designed excited field system and high efficient steel
- Stable Voltage Regulation : Built-in type Automatic Voltage regulator (AVR)
- High Efficient Cooling : Class H insulation with forced air-circulation
- Permanent Magnet Generator (PMG) (Optional) : PMG systems provides constant excitation
- Voltage Adjustment (Optional accessory by model) : The voltage can be adjusted manually.
- Dual Voltage (Optional) : Two kinds of voltage can be given.

4. Safe Running (Protection)

- MCCB (Molded Case Circuit Breaker) can be opened by Over Current automatically.
- The engine can be stopped by High coolant temperature / Low oil pressure automatically
- The engine can be stopped by Over speed .
- Engine stop system : Energized in Run mode
The engine can be stopped automatically in case of the following condition.
(1) Over speed, (2) High coolant temperature, (3) Low oil pressure, (4) Emergency button is pushed.

5. Various Generator Type

EGS Series Generator has 4 types.

- (1) Bonnet & Soundproof type with Control panel and MCCB : For single operation at residential area
- (2) Non Bonnet type with Control panel and MCCB : For single operation in the room
- (3) Non Bonnet type with Engine control panel : For parallel operation in the room

* Typical Generator Type

Open type for Single operation

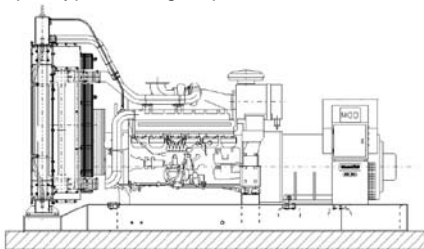

Bonnet & Soundproof type

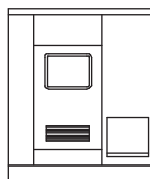
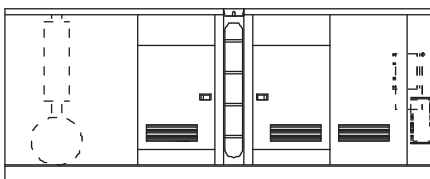

Item	Model	EGS45BS-6				EGS65BS-6				EGS120BS-6														
	Bonnet & Soundproof Type	EGS45-6				EGS65-6				EGS120-6														
GENERATOR																								
Rated output	Frequency	50 Hz				60 Hz				50 Hz				60 Hz										
	Prime Output	kVA	kW	kVA	kW	kVA	kW	kVA	kW	kVA	kW	kVA	kW	kVA	kW									
	Standby Output	35	28	41	33	50	40	58	46	100	80	118	94	39	31	45	36	55	44	63	51	110	88	129
ENGINE																								
Model		Komatsu 4D95LE-2				Komatsu S4D95LE-2				Komatsu S6D102E-1														
Horsepower kW (HP)	Prime (at 1500, 1800 RPM)	31.1 (41.7) 36.7 (49.2)				44.8 (60.1) 51.8 (69.4)				92.7 (124) 104.4 (140)														
	Standby (at 1500, 1800 RPM)	34.8 (46.6) 40.2 (53.9)				49.3 (66.1) 58.4 (78.3)				107.4 (144) 121.4 (163)														
No. of cylinders		4 - inline				4 - inline				6 - inline														
Bore × stroke mm (in)		95 × 115 (3.74 × 4.53)				95 × 115 (3.74 × 4.53)				102 × 120 (4.02 × 4.72)														
Piston displacement ltr. (cu.in)		3.26 (199)				3.26 (199)				5.88 (3.59)														
Aspiration		Natural				Turbocharged				Turbocharged														
Electric system	Starter motor	12 V – 2.2 kW				12 V – 2.2 kW				24 V – 4.5 kW														
	Alternator	12 V – 35 A				12 V – 35 A				24 V – 25 A														
	Battery	12 V – 100 Ah × 1				12 V – 100 Ah × 1				12 V – 100 Ah × 2														
GENERATOR SET																								
Capacity ltr. (U.S. Gal)	Coolant	10.3 (2.72)				10.3 (2.72)				19 (5.02)														
	Lubricant	8.0 (2.11)				8.5 (2.25)				22 (5.81)														
	Fuel tank Bonnet & Soundproof Type	150 (39.6)				150 (39.6)				200 (52.8)														
Dry weight* kg (lb)	Fuel Tank Open (Option)	150 (39.6)				150 (39.6)				200 (52.8)														
	Bonnet & Soundproof Type	1200 (2,650)				1200 (2,650)				1900 (4,190)														
	Open Type	800 (1,760)				800 (1,760)				1300 (2,870)														
Dimensions (L × W × H) mm (ft.in)	Bonnet & Soundproof Type	2600 × 850 × 1340 (8'6" × 2'9" × 4'5")				2600 × 850 × 1400 (8'6" × 2'9" × 4'7")				3400 × 950 × 1750 (11'2" × 3'1" × 5'9")														
	Open Type	1800 × 880 × 1800 (5'11" × 2'11" × 5'11")				1800 × 880 × 1800 (5'11" × 2'11" × 5'11")				2200 × 950 × 1520 (7'3" × 3'1" × 5'0")														

Item	Model	EGS160BS-7				EGS240BS-6				EGS300BS-6														
	Bonnet & Soundproof Type	EGS160-7				EGS240-6				EGS300-6														
GENERATOR																								
Rated output	Frequency	50 Hz				60 Hz				50 Hz				60 Hz										
	Prime Output	kVA	kW	kVA	kW	kVA	kW	kVA	kW	kVA	kW	kVA	kW	kVA	kW									
	Standby Output	129	103	155	124	200	160	238	190	276	221	303	242	145	116	173	138	220	176	261	209	304	243	333
ENGINE																								
Model		Komatsu SAA6D102E-2				Komatsu S6D125-1				Komatsu SA6D125-2														
Horsepower kW (HP)	Prime (at 1500, 1800 RPM)	113 (151) 134 (180)				172 (230) 204 (273)				238 (319) 261 (350)														
	Standby (at 1500, 1800 RPM)	128 (171) 152 (204)				189 (253) 225 (301)				262 (351) 287 (385)														
No. of cylinders		6 - inline				6 - inline				6 - inline														
Bore × stroke mm (in)		102 × 120 (4.02 × 4.72)				125 × 150 (4.92 × 5.91)				125 × 150 (4.92 × 5.91)														
Piston displacement ltr. (cu.in)		5.88 (3.59)				11.04 (673)				11.04 (673)														
Aspiration		Turbocharged Air to Air Aftercooled				Turbocharged				Turbocharged Aftercooled														
Electric system	Starter motor	24 V – 4.5 kW				24 V – 5.5 kW				24 V – 5.5 kW														
	Alternator	24 V – 25 A				24 V – 35A				24 V – 35A														
	Battery	12 V – 120 Ah × 2				12 V – 150 Ah × 2				12 V – 150 Ah × 2														
GENERATOR SET																								
Capacity ltr. (U.S. Gal)	Coolant	25 (6.6)				59 (15.6)				60 (15.9)														
	Lubricant	22 (5.8)				30 (7.93)				40 (10.6)														
	Fuel tank Bonnet & Soundproof Type	230 (60.8)				570 (151)				570 (151)														
Dry weight* kg (lb)	Fuel Tank Open (Option)	230 (60.8)				470 (124)				470 (124)														
	Bonnet & Soundproof Type	2200 (4,850)				4000 (8,820)				4400 (9,700)														
	Open Type**	1600 (3,530)				2200 (4,850)				2700 (5,950)														
Dimensions (L × W × H) mm (ft.in)	Bonnet & Soundproof Type	3770 × 950 × 1750 (12'4" × 3'1" × 5'9")				4040 × 1590 × 2170 (13'3" × 5'3" × 7'1")				4040 × 1590 × 2170 (13'3" × 5'3" × 7'1")														
	Open Type**	2570 × 950 × 1600 (8'5" × 3'1" × 5'3")				2880 × 1120 × 1630 (9'5" × 3'8" × 5'4")				3000 × 1120 × 1680 (9'10" × 3'8" × 5'6")														

* Including coolant water and lubricant oil

Item	Model	EGS360BS-6				EGS380BS-6				EGS500BS-6			
	Bonnet & Soundproof Type	EGS360-6				EGS380-6				EGS500-6			
GENERATOR													
Rated output	Frequency	50 Hz		60 Hz		50 Hz		60 Hz		50 Hz		60 Hz	
	Prime Output	kVA	kW	kVA	kW	kVA	kW	kVA	kW	kVA	kW	kVA	kW
		Standby Output	—	—	360	288	350	280	—	—	—	—	505
ENGINE													
Model		Komatsu SAA6D125-P380				Komatsu SAA6D125-P400				Komatsu SAA6D140-P460			
Horsepower kW (HP)	Prime (at 1500, 1800 RPM)	—		310 (415)		298 (400)		—		—		430 (577)	
	Standby (at 1500, 1800 RPM)	—		341 (457)		328 (440)		—		—		474 (635)	
No. of cylinders		6 - inline				6 - inline				6 - inline			
Bore × stroke mm (in)		125 × 150 (4.92 × 5.91)				125 × 150 (4.92 × 5.91)				140 × 165 (5.51 × 6.50)			
Piston displacement ltr. (cu.in)		11.04 (673)				11.04 (673)				15.24 (930)			
Aspiration		Turbocharged Air to Air Aftercooled				Turbocharged Air to Air Aftercooled				Turbocharged Air to Air Aftercooled			
Electric system	Starter motor	24 V – 7.5 kW				24 V – 7.5 kW				24 V – 7.5 kW			
	Alternator	24 V – 35A				24 V – 35A				24 V – 35A			
	Battery	12 V – 150 Ah × 2				12 V – 150 Ah × 2				12 V – 200 Ah × 2			
GENERATOR SET													
Capacity ltr. (U.S. Gal)	Coolant	70 (18.5)				70 (18.5)				72 (19.0)			
	Lubricant	62 (16.4)				62 (16.4)				74 (19.6)			
	Fuel tank Bonnet & Soundproof Type	570 (151)				570 (151)				600 (159)			
	Fuel Tank Open (Option)	470 (124)				470 (124)				600 (159)			
Dry weight kg (lb)	Bonnet & Soundproof Type	4800 (10,580)				5000 (11,020)				6300 (13,890)			
	Open Type	2800 (6,170)				3000 (6,610)				3700 (8,160)			
Dimensions (L × W × H) mm (ft.in)	Bonnet & Soundproof Type	4340 × 1590 × 2200 (14'3" × 5'3" × 7'3")				4340 × 1590 × 2200 (14'3" × 5'3" × 7'3")				5040 × 1870 × 2200 (16'6" × 6'2" × 7'3")			
	Open Type	3300 × 1120 × 1785 (10'10" × 3'8" × 5'10")				3300 × 1120 × 1790 (10'10" × 3'8" × 5'10")				3500 × 1410 × 1840 (11'6" × 4'8" × 6'0")			

Item	Model	EGS630BS-6				EGS760BS-6				EGS850BS-6			
	Bonnet & Soundproof Type	EGS630-6				EGS760-6				EGS850-6			
GENERATOR													
Rated output	Frequency	50 Hz		60 Hz		50 Hz		60 Hz		50 Hz		60 Hz	
	Prime Output	kVA	kW	kVA	kW	kVA	kW	kVA	kW	kVA	kW	kVA	kW
		Standby Output	500	400	—	—	—	—	758	606	705	564	—
ENGINE													
Model		Komatsu SAA6D140-P580				Komatsu SAA6D170-P740				Komatsu SAA6D170-P800			
Horsepower kW (HP)	Prime (at 1500, 1800 RPM)	430 (577)		—		—		639 (856)		597 (800)		—	
	Standby (at 1500, 1800 RPM)	474 (635)		—		—		703 (942)		656 (880)		—	
No. of cylinders		6 - inline				6 - inline				6 - inline			
Bore × stroke mm (in)		140 × 165 (5.51 × 6.50)				170 × 170 (6.69 × 6.69)				170 × 170 (6.69 × 6.69)			
Piston displacement ltr. (cu.in)		15.24 (930)				23.15 (1413)				23.15 (1413)			
Aspiration		Turbocharged Air to Air Aftercooled				Turbocharged Air to Air Aftercooled				Turbocharged Air to Air Aftercooled			
Electric system	Starter motor	24 V – 7.5 kW				24 V – 11 kW				24 V – 11 kW			
	Alternator	24 V – 35A				24 V – 35A				24 V – 35A			
	Battery	12 V – 200 Ah × 2				12 V – 200 Ah × 2				12 V – 200 Ah × 2			
GENERATOR SET													
Capacity ltr. (U.S. Gal)	Coolant	102 (26.9)				145 (38.3)				145 (38.3)			
	Lubricant	77 (20.3)				147 (38.8)				147 (38.8)			
	Fuel tank Bonnet & Soundproof Type	600 (159)				750 (198)				750 (198)			
	Fuel Tank Open (Option)	600 (159)				750 (198)				750 (198)			
Dry weight kg (lb)	Bonnet & Soundproof Type	6500 (14,330)				9400 (20,720)				9700 (21,380)			
	Container & Soundproof	—				—				9000 (19,840)			
	Open Type	3900 (8,600)				5700 (12,570)				6000 (13,230)			
Dimensions (L × W × H) mm (ft.in)	Bonnet & Soundproof Type	5040 × 1870 × 2200 (16'6" × 6'2" × 7'3")				5730 × 2050 × 2550 (18'10" × 6'9" × 8'4")				5730 × 2050 × 2550 (18'10" × 6'9" × 8'4")			
	Open Type	3500 × 1510 × 1850 (11'6" × 4'11" × 6'1")				4000 × 1690 × 1960 (13'1" × 5'6" × 6'5")				4100 × 1690 × 1960 (13'5" × 5'6" × 6'5")			

Item	Model	EGS1000BS-7				EGS1050BS-7				EGS1200BS-6							
	Bonnet & Soundproof Type	—				—				EGS1200BS-6C							
	Container & Soundproof	—				—				EGS1200BS-6CT							
	Open Type	EGS1000-7				EGS1050-7				EGS1200-6							
GENERATOR																	
Rated output	Frequency	50 Hz				60 Hz				50 Hz				60 Hz			
	Prime Output	kVA	kW	kVA	kW	kVA	kW	kVA	kW	kVA	kW	kVA	kW	kVA	kW		
		—	—	920	736	860	688	—	—	1000	800	—	—	—	—		
Standby Output	—	—	1000	800	915	732	—	—	1100	880	—	—	—	—			
ENGINE																	
Model		Komatsu SAA6D170E-P910				Komatsu SAA6D170E-P970				Komatsu SAA12V140-P1150							
Horsepower kW (HP)	Prime (at 1500, 1800 RPM)	—				772 (1035)				723 (969)				861 (1154)			
	Standby (at 1500, 1800 RPM)	—				858 (1150)				769 (1031)				947 (1269)			
No. of cylinders		6 - inline				6 - inline				12 Vee							
Bore × stroke mm (in)		170 × 170 (6.69 × 6.69)				170 × 170 (6.69 × 6.69)				140 × 165 (5.51 × 6.50)							
Piston displacement ltr. (cu.in)		23.15 (1413)				23.15 (1413)				30.48 (1860)							
Aspiration		Turbocharged Air to Air Aftercooled				Turbocharged Air to Air Aftercooled				Turbocharged Air to Air Aftercooled							
Electric system	Starter motor	24 V – 11 kW				24 V – 11 kW				24 V – 7.5 kW × 2							
	Alternator	24 V – 35A				24 V – 35A				24 V – 35A							
	Battery	12 V – 200 Ah × 4				12 V – 200 Ah × 4				12 V – 200 Ah × 4							
GENERATOR SET																	
Capacity ltr. (U.S. Gal)	Coolant	183 (48.3)				183 (48.3)				238 (62.9)							
	Lubricant	141 (37.3)				141 (37.3)				157 (41.5)							
	Fuel tank Bonnet & Soundproof Type	1300 (343)				1300 (343)				1350 (357)							
	Fuel Tank Container	—				—				1500 (396)							
	Fuel Tank Open (Option)	900 (238)				900 (238)				850 (225)							
	Bonnet & Soundproof Type	10300 (24,030)				10500 (23,150)				13600 (29,980)							
Dry weight kg (lb)	Container & Soundproof	—				—				17000 (37,480)							
	Open Type	6400 (14,770)				6600 (14,550)				7400 (16,310)							
	Bonnet & Soundproof Type	5830 × 1990 × 2540 (19'2" × 6'6" × 8'4")				5830 × 1990 × 2540 (19'2" × 6'6" × 8'4")				7540 × 2340 × 3200 (24'9" × 7'8" × 10'6")							
Dimensions (L × W × H) mm (ft.in)	Container & Soundproof	—				—				12200 × 2440 × 2900 (40'0" × 8'0" × 9'6")							
	Open Type	4120 × 1790 × 2080 (13'6" × 5'10" × 6'10")				4120 × 1790 × 2080 (13'6" × 5'10" × 6'10")				4170 × 2090 × 2260 (13'8" × 6'10" × 7'5")							

CONTENTS

INDEX

SECTION **11**

ENGINES Sec 11



SECTION **11**

ENGINES

CONTENTS

Features	11-2
Specifications	11-5
Engine Used in KOMATSU Machines by Engine Model	11-6
High Altitude Deration	11-8

High quality:

The Komatsu diesel engine is a true achievement of our total engine production system—from casting all the way through machining processes using Komatsu-made machine tools to the final steps of assembly.

Proven reliability

The Komatsu diesel engine is matched with our heavy-duty construction equipment to create a powerful combination of unbeatable performance and high durability.

Economical operations:

The Direct injection system and special fuel-minimizing design of Komatsu diesel engines provide maximum economy. Low lubricant consumption is also a remarkable advantage.

Compact design:

Advanced design and an efficient production system make Komatsu diesel engines compact and lightweight, enhancing their versatility.

Low-noise operation:

Ideal designs keep engine noise and vibration to a minimum.

Wider applications:

A wide range of optional equipment offers a variety of applications to meet specific customer requirements.

Low emission engine (EPA Tier 3 and EU Stage 3A emissions certified.):

Komatsu engine meets the emission regulations of North America, Europe, Japan, etc. by employing the advanced technologies. The followings are examples of the technologies.

High-pressure injection system

Fuel is sprayed more finely to prevent increase of NO_x and particulate matter by heightening the fuel pressure injected into the cylinder.

Air-cooled aftercooler

Intake air temperature pressurized by the turbocharger is lowered largely by the air-cooled aftercooler having high cooling capacity to prevent increase of NO_x caused by high combustion temperature and increase the intake air density for less fuel consumption.

Optimized shape of combustion chamber by use of FCD piston

The shape of the combustion chamber is optimized by employing an FCD piston having high strength and the air flow speed is heightened by improving the shape of the air intake passage. With these technologies, particulate matter is reduced.

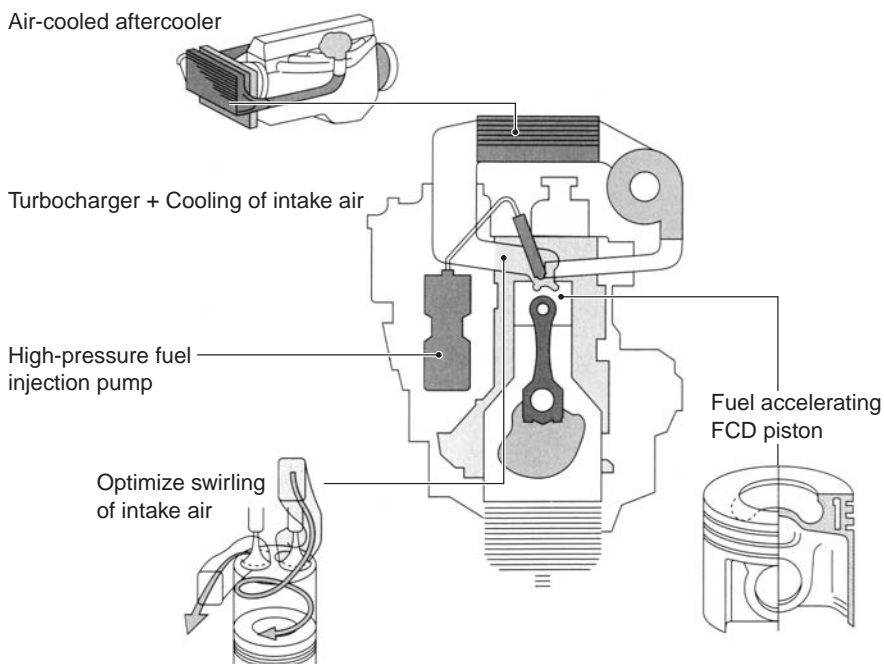
Komatsu low-emission diesel engine

Komatsu's new engine technology (EPA Tier 4 Interim and EU Stage 3B emissions certified.)

Newly designed Komatsu Variable Geometry Turbocharger (KVGT)

A newly designed variable geometry turbocharger features Komatsu proprietary technology that varies the air-flow and delivers optimum air quantity to the engine combustion chamber under all speed and load conditions. The result is cleaner exhaust gas and improved fuel economy while maintaining power and performance. (SAA6D107E-2, SAA6D114E-5, SAA6D125E-6, SAA6D140E-6)

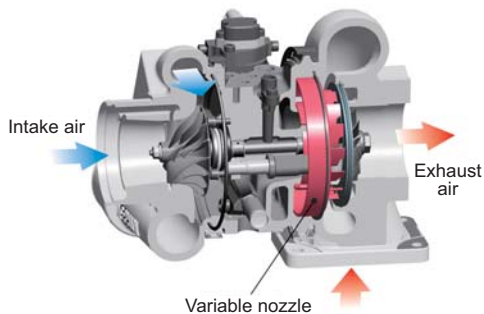

Newly designed Variable Flow Turbocharger (VFT)

A newly designed variable flow turbocharger features simple and reliable technology that varies the intake air-flow. Exhaust turbine wheel speed is controlled by flow control valve and it enables to deliver optimum air quantity to the engine combustion chamber under all speed and load conditions. The result is cleaner exhaust gas while maintaining power and performance. (SAA4D95LE-6)

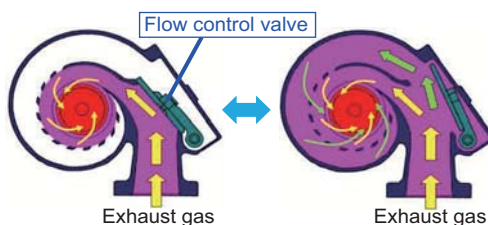

Newly designed Komatsu Diesel Particulate Filter (KDPF)

Komatsu has designed and developed a high efficiency diesel particulate filter that captures more than 90% of PM. Passive and active regeneration is initiated automatically by the engine controller as needed to burn the particulates while the engine is running allowing uninterrupted machine operation. A special oxidation catalyst with fuel injection system eliminates the need for a traditional fuel burner thereby reducing maintenance costs and increasing reliability. (SAA6D107E-2, SAA6D114E-5, SAA6D125E-6, SAA6D140E-6)

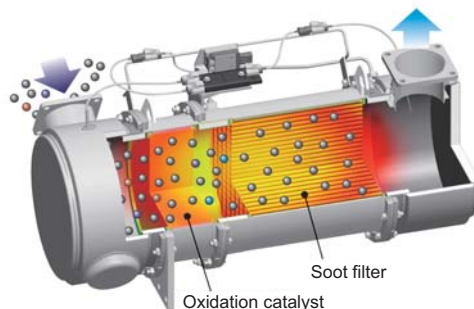

Newly designed Komatsu Diesel Oxidation Catalyst (KDOC)

Komatsu has designed and developed a simple and high efficiency diesel oxidation catalyst. This system enables to eliminate the need of the PM regeneration and to simplify the engine control system. High performance exhaust noise silencer is also integrated and it contributes the engine noise reduction. (SAA4D95LE-6)

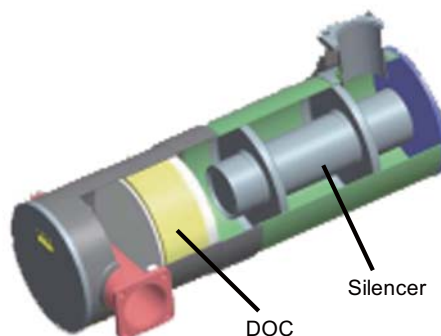

Heavy duty High Pressure Common Rail (HPCR) Fuel Injection System

Computer controlled heavy duty HPCR system delivers a precise quantity of pressurized fuel into the engine combustion chamber using multiple injections to achieve complete fuel burn and reduce exhaust emissions. Fuel injector life has been improved through the use of ultra-hard wear resistant materials such as diamond-like carbon.

(SAA4D95LE-6, SAA6D107E-2, SAA6D114E-5, SAA6D125E-6, SAA6D140E-6)

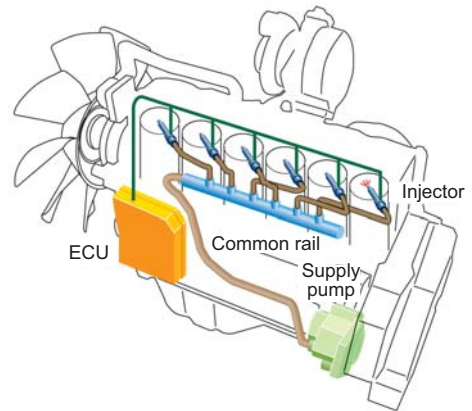

Larger more robust cooled Exhaust Gas Recirculation (EGR) System

Cooled EGR, a technology well-proven in existing Komatsu engines, has increased capacity to further reduce NOx to Tier 4 levels. Larger more robust components ensure reliable performance during the demanding work conditions of construction equipment.

(SAA4D95LE-6, SAA6D107E-2, SAA6D114E-5, SAA6D125E-6, SAA6D140E-6)

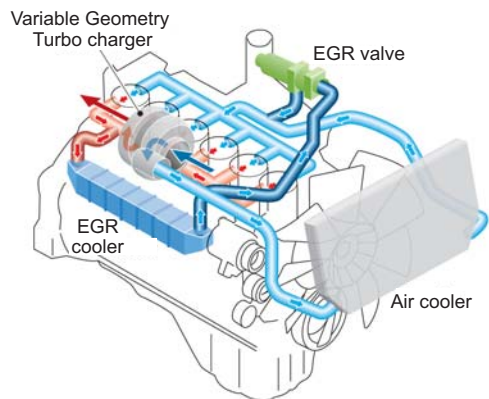

Redesigned combustion chamber at top of piston

The fuel/air combustion chamber located at the top of the engine piston has a new shape designed to improve combustion and further reduce NOx, PM, fuel consumption and noise. (SAA4D95LE-6, SAA6D107E-2, SAA6D114E-5, SAA6D125E-6, SAA6D140E-6)

Komatsu Closed Crankcase Ventilation (KCCV)

Oil mist trap efficiency is significantly increased from previous "Breather"s, from around 50% trap efficiency to 95% trap efficiency. Almost oil mist free crankcase gas (blow-by gas) is delivered back to the intake.

(SAA4D95LE-6, SAA6D107E-2, SAA6D114E-5, SAA6D125E-6, SAA6D140E-6)



Main Engines Mounted on the Komatsu machines						
MODEL	HORSEPOWER (GROSS) kW (HP)/RPM	CONFIGURA- TION	ASPIRA- TION*	FUEL INJECTION SYSTEM**	DISPLACEMENT ltr. (in ³)	BORE × STROKE mm (in)
4D95LE-2	48.5 (66)/2600	4In-Line	NA	DI	3.26 (199)	95 × 115 (3.74 × 4.53)
S4D95LE-3	63.3 (86)/2600	4In-Line	T	DI	3.26 (199)	95 × 115 (3.74 × 4.53)
SAA4D95LE-5	74.3 (100)/2400	4In-Line	TAA	DI	3.26 (199)	95 × 115 (3.74 × 4.53)
SAA4D95LE-6	73.4 (101)/2600	4In-Line	TAA	DI	3.26 (199)	95 × 115 (3.74 × 4.53)
SAA6D95LE-1	114 (154)/3000	6In-Line	TAA	DI	4.89 (298)	95 × 115 (3.74 × 4.53)
4D102E-1	52 (69)/2500	4In-Line	NA	DI	3.92 (239)	102 × 120 (4.02 × 4.72)
S4D102E-1	74 (99)/2500	4In-Line	T	DI	3.92 (239)	102 × 120 (4.02 × 4.72)
SA4D102E-1	81 (108)/2500	4In-Line	TA	DI	3.92 (239)	102 × 120 (4.02 × 4.72)
SAA4D102E-2	99 (133)/2200	4In-Line	TAA	DI	3.92 (239)	102 × 120 (4.02 × 4.72)
6D102E-1	74 (99)/2250	6In-Line	NA	DI	5.88 (359)	102 × 120 (4.02 × 4.72)
S6D102E-1	123 (165)/2500	6In-Line	T	DI	5.88 (359)	102 × 120 (4.02 × 4.72)
SA6D102E-2	86 (115)/2300	6In-Line	TA	DI	5.88 (359)	102 × 120 (4.02 × 4.72)
SAA6D102E-2	160 (215)/2000	6In-Line	TAA	DI	5.88 (359)	102 × 120 (4.02 × 4.72)
SAA6D102E-2	166 (225)/2200	6In-Line	TAA	DI	6.69 (408)	107 × 124 (4.21 × 4.88)
SAA4D107E-1	110.3 (148)/2200	4In-Line	TAA	DI	4.46 (272)	107 × 124 (4.21 × 4.88)
SAA6D107E-1	166 (222)/2200	6In-Line	TAA	DI	6.69 (408)	107 × 124 (4.21 × 4.88)
S6D108E-2	136 (182)/2500	6In-Line	T	DI	7.145 (436)	108 × 130 (4.25 × 5.12)
SA6D108E-2	180 (242)/2500	6In-Line	TA	DI	7.145 (436)	108 × 130 (4.25 × 5.12)
SAA6D108E-2	199 (266)/2600	6In-Line	TAA	DI	7.145 (436)	108 × 130 (4.25 × 5.12)
S6D114E-1	153 (205)/2200	6In-Line	T	DI	8.27 (505)	114 × 135 (4.49 × 5.31)
SA6D114E-1	176 (236)/1750	6In-Line	TA	DI	8.27 (505)	114 × 135 (4.49 × 5.31)
SA6D114E-2	165.5 (222)/2200	6In-Line	TA	DI	8.27 (505)	114 × 135 (4.49 × 5.31)
SAA6D114E-1	172 (230)/2200	6In-Line	TAA	DI	8.27 (505)	114 × 135 (4.49 × 5.31)
SAA6D114E-2	190 (254)/2200	6In-Line	TAA	DI	8.27 (505)	114 × 135 (4.49 × 5.31)
SAA6D114E-3	213 (286)/2000	6In-Line	TAA	DI	8.27 (505)	114 × 135 (4.49 × 5.31)
SAA6D114E-5	202 (275)/1950	6In-Line	TAA	DI	8.85 (540)	114 × 144.5 (4.49 × 5.09)
6D125E-2	133 (179)/2200	6In-Line	NA	DI	11.04 (674)	125 × 150 (4.92 × 5.91)
S6D125E-2	188 (252)/2200	6In-Line	T	DI	11.04 (674)	125 × 150 (4.92 × 5.91)
SA6D125E-3	220 (296)/2000	6In-Line	TA	DI	11.04 (674)	125 × 150 (4.92 × 5.91)
SAA6D125E-3	276 (370)/2200	6In-Line	TAA	DI	11.04 (674)	125 × 150 (4.92 × 5.91)
SAA6D125E-5	302 (406)/2100	6In-Line	TAA	DI	11.04 (674)	125 × 150 (4.92 × 5.91)
SAA6D125E-6	302 (410)/2000	6In-Line	TAA	DI	11.04 (674)	125 × 150 (4.92 × 5.91)
S6D140E-2	294 (394)/2100	6In-Line	T	DI	15.24 (930)	140 × 165 (5.51 × 6.50)
SA6D140E-2	327 (438)/2100	6In-Line	TA	DI	15.24 (930)	140 × 165 (5.51 × 6.50)
SA6D140E-3	316 (423)/2100	6In-Line	TA	DI	15.24 (930)	140 × 165 (5.51 × 6.50)
SAA6D140E-2	390 (523)/2100	6In-Line	TAA	DI	15.24 (930)	140 × 165 (5.51 × 6.50)
SAA6D140E-3	397 (532)/2100	6In-Line	TAA	DI	15.24 (930)	140 × 165 (5.51 × 6.50)
SAA6D140E-5	441 (592)/2000	6In-Line	TAA	DI	15.24 (930)	140 × 165 (5.51 × 6.50)
SAA6D140E-6	353 (480)/2000	6In-Line	TAA	DI	15.24 (930)	140 × 165 (5.51 × 6.50)
SA12V140-1	783 (1050)/2100	12V	TA	DI	30.5 (1861)	140 × 165 (5.51 × 6.50)
SDA12V140E-1	671 (899)/2000	12V	TAA	DI	30.5 (1861)	140 × 165 (5.51 × 6.50)
SA12V170E-2	917 (1229)/1800	12V	TA	DI	46.3 (2825)	170 × 170 (6.69 × 6.69)
SA6D170E-3	427 (573)/1800	6In-Line	TA	DI	23.15 (1413)	170 × 170 (6.69 × 6.69)
SAA6D170E-3	713 (956)/2000	6In-Line	TAA	DI	23.15 (1413)	170 × 170 (6.69 × 6.69)
SAA6D170E-5	560 (750)/2000	6In-Line	TA	DI	23.15 (1413)	170 × 170 (6.69 × 6.69)
SAA12V140E-3	895 (1200)/1900	12V	TAA	DI	30.5 (1861)	140 × 165 (5.51 × 6.50)
QSK60	2019 (2700)/1900	16V	TAA	DI	60.2 (3674)	159 × 190 (6.26 × 7.48)

- * Aspiration
 NA: Natural Aspiration
 T: Turbocharged
 TA: Turbocharged and after-cooled
 TAA: Turbocharged and after-cooled (air cooled)
- ** Fuel Injection System
 DI: Direct Injection
 PC: Pre-combustion
 TC: Turbulence-chamber

**Engines Used in KOMATSU
Machines by Engine Model**

ENGINES

Engine Model	Machine					
	Bulldozer	Excavator		Wheel Loader	Dump Truck	Other
3D67E-2A		PC14R-3 PC18MR-3	PC16R-3			
3D76E-6		PC20MR-3 PC26MR-3	PC22MR-3			
3D82AE-6		PC27MR-3				
S4D87E-1		PC56-7				
3D88E-6		PC30MR-3	PC35MR-3			
4D88E-6		PC45MR-3	PC55MR-3	WA50-6		
4D98E-3		PC80MR-3				
4D95LE-2	D21A-8E0 D21P-8E0					EGS45-6 BR100JG-2
4D95-LEW-5				WA65-6 WA70-6		
S4D95LE-2						EGS65-6
SAA4D95LE-3		PC110-7 PC130F-7	PC130-7			
SAA4D95LE-5	D31EX/PX-22 D37EX/PX-22	PC78US-8 PC60-8 PC138US-8 PW98MR-8	PC88MR-8 PC70-8 PC130-8 PC118MR-8	WA150-6 WA150PZ-6		
SAA4D95LE-6	D37EX/PX-23 D39EX/PX-23	PC138USLC-10				
S6D95L-1						GD511A-1
S4D102E-1				WA120-3		
SAA4D102E-2		PC160LC-7		WA150-5		
SAA4D104E-1						WB93R-5 WB93S-5 WB97R-5 WB97S-5
S6D102E-2				WA180-3		EGS120-6
SA6D102E-2				WA320-3CU		
SAA6D102E-2		PC200-7 PC220/LC-7	PC270-7	WA200/PT-5 WA250/PT-5 WA320-5		BZ210
SAA4D107E-1	D39EX/PX-22	PC160LC-8 PC190LC/NLC-8	PW148-8 PW160-8	WA200PZ-6 WA200-6		
SAA4D107E-1-A		HB205-1	HB215LC-1			
SAA6D107E-1	D51EX/PX-22 D61EX/PX-15E0	PC200/LC-8 PC220/LC-8 PC210/LC/NLC-8 PC230NHD-8 PC270/LC-8 PW200-7	PC200/LC-8M0 PC220/LC-8M0 PC228US/USLC-8 PC240LC-8 PW180-7 PW220-7	WA250-6 WA320-6 WA320PZ-6 WA380-6 WA380Z-6 WA380-7		GD555-5 GD655-5 GD675-5 BR380JG-1E0
SAA6D107E-2	D61EX/PX-23	PC210/LC-10 PC240LC/NLC-10	PC290LC/NLC-10			
S6D108-1				WA380-3		
S6D114E-1	D68ESS-12					
SA6D114E-2	D63E-12					
SAA6D114E-2		PC300/LC-7 PC360-7	PC350/LC-7	WA380-5		
SAA6D114E-3	D65EX/PX-16	PC300/LC-8	PC350LC-8	WA430-6		
SAA6D114E-5	D65EX/PX-17 D65WX-17	PC360LC/NLC-10 PC390LC-10				
6D125						GD663A-2
S6D125-1				WA470-3		GD705A-4
S6D125-2	D85ESS-2					
S6D125E-2	D85C-21 D85ESS-2A					
SAA6D125E-3		PC400/LC-7	PC450/LC-7	WA430-5 WA470-5 WA470-5	HM300-1 HM350-1 HD255-5	
SAA6D125E-5	D85EX/PX-15E0 D85EX/PX-15R0	PC400/LC-8 PC400/LC-8R OC550LC-8	PC450/LC-8 PC450/LC-8R	WA470-6 WA480-6	HM300-2 HM300-2R	BR580JG-1
SAA6D125E-6		PC490LC-10		WA470-7	HM300-3	
S6D140E-2						GD825A-2

**Engines Used in KOMATSU
Machines by Engine Model**

ENGINES

Engine Model	Machine					
	Bulldozer	Excavator		Wheel Loader	Dunp Truck	Other
SA6D140-2	D155C-1 D355C-3					
SA6D140E-2	D155A-5					
SA6D140E-3		PC600/LC-7		WA500-3		
SAA6D140E-3		PC750-7 PC800-7			HD325-6 HM400-1 HD405-6	
SAA6D140E-5	D155A-6 D155AX-6 D275A-5R D275AX-5E0	PC600/LC-8R1 PC650LC-8E0 PC700LC-8E0 PC800/LC-8E0 PC850-8E0	PC600/LC-8E0 PC650LC-8R PC700LC-8R PC800/LC-8R1	WA500-6 WA500-6R	HD325-7 HM350-2 HD325-7R HM350-2R HD405-7 HM400-2 HD405-7R	
SAA6D140E-6	D155AX-7			WA500-7	HM400-3	
SDA6D140E-3	D275A-5					
SA6D170E-3	D375A-5					
SAA6D170E-3		PC1250-7		WA600-3 WA700-3	HD465-7 HD605-7	WD600-3
SAA6D170E-5	D375A-6 D375A-6R D375A-5R	PC1250/LC-8	PC1250-8R	WA600-6 WA600-6R	HD465-7R HD605-7R HD465-7E0 HD605-7E0	WD600-6
SA12V140-1				WA800-3 WA900-3		WD900-3
SAA12V140E-3	D475A-5E0	PC2000-8		WA800-3E0 WA900-3E0	HD785-7	
SAA12V140E-5	D475A-5E0 SD					
SA12V170E-3	D575A-3 D575A-3 SD					
SSA12V159		PC3000-6 (Tier 1)	PC5500-6 (Tier 1)			
SSA12V159E-2		PC3000-6 (Tier 2)	PC5500-6 (Tier 2)			
SDA12V160					HD1500-7 (Tier 1)	
SDA16V159					730E	
SDA16V159E-2					HD1500-7 (Tier 2)	
SDA16V160		PC4000-6 (Tier 1)			830E-AC	
SDA16V160E-2		PC4000-6 (Tier 2)	PC8000-6 (Tier 2)			
SSDA16V160					860E-1K 930E-4	
SSDA16V160E-2				WA1200-6		
SSDA18V170					930E-4SE 960E-2 960E-2K	

Fueling deration rate

	ENGINE	0 ~ 750 m (0 ~ 2500 ft.)	750 ~ 1500 m (2500 ~ 5000 ft.)	1500 ~ 2300 m (5000 ~ 7500 ft.)	2300 ~ 3000 m (7500 ~ 10000 ft.)	3000 ~ 3800 m (10000 ~ 12500 ft.)	3800 ~ 4600 m (12500 ~ 15000 ft.)
D31EX/PX-22	SAA4D95LE-5	100	100	100	100	97	97
D37EX/PX-22*	SAA4D95LE-5	100	100	100	100	97	97
D37EX/PX-23*	SAA4D95LE-6	100	100	100	100	99	98
D39EX/PX-22*	SAA4D107E-1	100	100	100	98	97	85
D39EX/PX-23*	SAA4D95LE-6	100	100	100	97	93	87
D51EX/PX-22*	SAA6D107E-1	100	100	100	—	—	—
D61EX/PX-15E0*	SAA6D107E-1	100	100	100	—	—	—
D61EX/PX-23*	SAA6D107E-2	100	100	100	—	—	—
D63E-12	SA6D114E-2	100	100	100	100	—	—
D65EX-12	SA6D125E-3	100	100	100	100	100	96
D65EX/PX-16*	SAA6D114E-3	100	100	100	100	97	—
D65EX/PX-17*	SAA6D114E-5	100	100	100	95	85	—
D68ESS-12	S6D114E-1	100	100	100	100	95	81
D85ESS-2	S6D125-2	100	100	100	100	100	96
D85EX/PX-15E0*	SAA6D125E-5	100	100	100	100	100	100
D85EX/PX-15R*	SAA6D125E-5	100	100	100	100	100	100
D155A-5	SA6D140E-2	100	100	100	100	97	86
D155A-6*	SAA6D140E-5	100	100	100	—	—	—
D155AX-6*	SAA6D140E-5	100	100	100	—	—	—
D155AX-7*	SAA6D140E-6	100	100	100	100	—	—
D275A-5	SDA6D140E-3	100	100	100	100	100	90
D275A-5R	SAA6D140E-5	100	100	100	100	98	93
D275AX-5E0*	SAA6D140E-5	100	100	100	100	96	90
D375A-5*	SA6D170E-3	100	100	100	93	84	78
D375A-5R*	SAA6D170E-5	100	100	100	100	96	92
D375A-6*	SAA6D170E-5	100	100	97	92	87	80
D375A-6R*	SAA6D170E-5	100	100	100	100	95	89
D475A-5E0**	SAA12V140E-3	100	100	100	98	97	94
D475/ASD-5E0**	SAA12V140E-3	100	100	100	98	97	94
D575A-3	SA12V170-1	100	100	100	100	—	—
D575A-3 SD	SA12V170-1	100	100	100	100	—	—
PC60-8	SAA4D95LE-5	100	100	100	100	—	—
PC70-8	SAA4D95LE-5	100	100	100	100	—	—
PC78US-8*	SAA4D95LE-5	100	100	100	100	—	—
PC88MR-8*	SAA4D95LE-5	100	100	100	100	—	—
PC110-7	SAA4D95LE-3	100	100	100	100	95	90
PC118MR-8	SAA4D95LE-5	100	100	100	100	95	90
PC130-8*	SAA4D95LE-5	100	100	100	100	95	90
PC130-7	SAA4D95LE-3	100	100	100	100	95	90
PC138US-8*	SAA4D95LE-5	100	100	100	100	95	90
PC138USLC-10	SAA4D95LE-6	100	100	100	100	100	96
PC160LC-8*	SAA4D107E-1	100	100	100	100	—	—
PC160LC-7	SAA4D102E-2	100	100	100	95	90	80
PC190LC/NLC-8*	SAA4D107E-1	100	100	100	100	—	—
HB205/215LC-1*	SAA4D107E-1-A	100	88	82	80	—	—
PC200/LC-8*	SAA6D107E-1	100	100	100	100	100	95
PC200/LC-8M0*	SAA4D107E-1	100	100	100	100	100	95
PC200/LC-7	SAA6D102E-2	100	100	100	100	90	85
PC210/LC-10*	SAA6D107E-2	100	100	100	—	—	—
PC210/LC/NLC-8*	SAA6D107E-1	100	100	100	100	100	95
PC220/LC-8*	SAA6D107E-1	100	100	100	100	99	92
PC220/LC-8M0*	SAA6D107E-1	100	100	100	100	99	92
PC220/LC-7	SAA6D102E-2	100	100	100	100	90	85
PC228US/USLC-8*	SAA6D107E-1	100	100	100	100	100	95
PC230NHD-8*	SAA6D107E-1	100	100	100	100	99	92

- NOTE:**
- (1) The percentages listed above are for standard machines.
 - (2) These values at each altitude range indicate the percentage of the fueling deration rate against standard fueling calibration. 100 percent means that no fuel derate is required.
 - (3)*: With automatic altitude deration
 - (4) *: Automatic deration depending on altitude and turbo inlet air temperature (ambient temperature) is applied only to SAA12V140E-3.
 - (5) This deration rate is for reference. Please contact to OEM for actual rate, for it will be obtained by ambient temperature and altitude of the operation site.

	ENGINE	0 ~ 750 m (0 ~ 2500 ft.)	750 ~ 1500 m (2500 ~ 5000 ft.)	1500 ~ 2300 m (5000 ~ 7500 ft.)	2300 ~ 3000 m (7500 ~ 1000 ft.)	3000 ~ 3800 m (10000 ~ 12500 ft.)	3800 ~ 4600 m (12500 ~ 15000 ft.)
PC240LC/NLC-10*	SAA6D107E-2	100	100	100	—	—	—
PC240LC-8*	SAA6D107E-1	100	100	100	100	99	92
PC270/LC-8*	SAA6D107E-1	100	100	100	100	92	76
PC270-7	SAA6D102E-2	100	100	100	95	90	85
PC290LC/NLC-10*	SAA6D107E-2	100	100	100	—	—	—
PC300/LC-7,PC350/LC-7	SAA6D114E-2	100	100	100	93	82	75
PC300/350/LC-8*	SAA6D114E-3	100	100	100	93	—	—
PC360LC/NLC-10*	SAA6D114E-5	100	100	100	99	87	76
PC360-7	SAA6D114E-2	100	100	100	93	82	75
PC390LC-10*	SAA6D114E-5	100	100	100	99	87	76
PC400/LC-7,PC450-7	SAA6D125E-3	100	100	100	100	95	90
PC400/450/LC-8*	SAA6D125E-5	100	100	98	95	87	82
PC400/450/LC-8R*	SAA6D125E-5	100	100	100	99	92	82
PC490LC-10*	SAA6D125E-6-A	100	100	97	93	—	—
PC550LC-8*	SAA6D125E-5-A	100	100	98	95	87	82
PC600/LC-8*	SAA6D140E-5	100	100	100	100	96	88.5
PC600/LC-8Çq1*	SAA6D140E-5	100	100	100	100	97	89
PC650LC-8R*	SAA6D140E-5	100	100	100	100	97	89
PC600Æ650/LC-8E0*	SAA6D140E-5	100	100	100	100	96	88.5
PC600/LC-7	SAA6D140E-3	100	100	100	92	85	78
PC700LC-8E0*	SAA6D140E-5	100	100	100	100	96	88.5
PC700LC-8R*	SAA6D140E-5	100	100	100	100	97	89
PC750*800-7	SAA6D140E-3	100	100	100	100	100	93
PC800*850/LC-8E0*	SAA6D140E-5	100	100	98	92	84	76
PC800*850-8R1*	SAA6D140E-5	100	100	100	100	96	88
PC1250-7*	SAA6D170E-3	100	100	100	100	100	93
PC1250/LC-8*	SAA6D170E-5	100	100	98	95	89	81
PC1250-8R*	SAA6D170E-5	100	100	100	100	94	89
PC2000-8**	SAA12V140E-3	100	100	100	100	94	89
PC3000-6	SAA12V159	100	100	100	100	92	84
PC4000-6	SDA16V160	100	100	100	100	100	92
PC5500-6	SSA12V159	100	100	100	100	92	84
PC8000-6	SDA16V160	100	100	100	100	96	86
HD255-5	SAA6D125E-3	100	100	100	100	94	87
HD325-6,HD405-6	SAA6D140E-3	100	100	100	100	97	86
HD325-7,HD405-7*	SAA6D140E-5	100	100	100	98	92	82
HD325-7R,HD405-7R*	SAA6D140E-5	100	100	100	100	96	89
HD465-7,HD605-7*	SAA6D170E-3	100	100	100	100	94	86
HD465-7E0,HD605-7E0*	SAA6D170E-5	100	100	97	92	85	79
HD465-7R,HD605-7R*	SAA6D170E-5	100	100	100	100	93	88
HD785-7**	SAA12V140E-3	100	100	100	98	95	86
HD1500-7	SDA12V160	100	100	100	100	100	98-88
	SDA16V159E-2	100	100	100-96	96-86	86-76	76-66
730E	SSA16V159	100	100	100	100-92	92-82	82-72
	SDA16V159E-2	100	100	100	100-92	92-82	82-72
830E-1AC	SDA16V160	100	100	100-92	92-82	82-72	72-62
	SDA16V160E-2	100	100	100-92	92-82	82-72	72-62
860E-1K	SSDA16V160	100	100	100	100	98	98-88
	SSDA16V160E-2	100	100	100	100	98	98-88
930E-4	SSDA16V160	100	100	100	100	98	98-88
	SSDA16V160E-2	100	100	100	100	98	98-88
930E-4SE	SSDA18V170	100	100	100	100	100	100
960E,960E-2K	SSDA18V170	100	100	100	100	100	100
HM300-1	SAA6D125E-3	100	100	100	100	93	86
HM300-2*	SAA6D125E-5	100	100	100	93	85	78
HM300-2R*	SAA6D125E-5	100	100	100	100	95	86

- NOTE:**
- (1) The percentages listed above are for standard machines.
 - (2) These values at each altitude range indicate the percentage of the fueling deration rate against standard fueling calibration. 100 percent means that no fuel derate is required.
 - (3)*: With automatic altitude deration
 - (4)**: Automatic deration depending on altitude and turbo inlet air temperature (ambient temperature) is applied only to SAA12V140E-3.
 - (5) This deration rate is for reference. Please contact to OEM for actual rate, for it will be obtained by ambient temperature and altitude of the operation site.

	ENGINE	0 ~ 750 m (0 ~ 2500 ft.)	750 ~ 1500 m (2500 ~ 5000 ft.)	1500 ~ 2300 m (5000 ~ 7500 ft.)	2300 ~ 3000 m (7500 ~ 1000 ft.)	3000 ~ 3800 m (10000 ~ 12500 ft.)	3800 ~ 4600 m (12500 ~ 15000 ft.)
HM300-3*	SAA6D125E-6	100	100	100	100	—	—
HM350-1	SAA6D140E-3	100	100	100	100	100	100
HM350-2*	SAA6D140E-5	100	100	100	100	99	93
HM350-2R*	SAA6D140E-5	100	100	100	100	100	100
HM400-1	SAA6D140E-3	100	100	100	100	100	100
HM400-2*	SAA6D140E-5	100	100	100	100	99	93
HM400-2R*	SAA6D140E-5	100	100	100	100	100	94
HM400-3	SAA6D140E-6	100	100	100	98	—	—
WA150-5	SAA4D102E-2	100	100	100	100	86	75
WA150-6*	SAA4D95LE-5	100	100	94	89	80	71
WA150PZ-6*	SAA4D95LE-5	100	100	94	89	80	71
WA200-5	SAA6D102E-2	100	100	100	99	91	86
WA200-6*	SAA4D107E-1	100	100	100	91	83	69
WA200PZ-6*	SAA4D107E-1	100	100	100	91	83	69
WA250-5	SAA6D102E-2	100	100	100	93	86	81
WA250-6*	SAA6D107E-1	100	100	100	100	100	100
WA250PZ-6*	SAA6D107E-1	100	100	100	100	100	100
WA320-3 CUSTOM	SA6D102E-2	100	100	100	—	—	—
WA320-5	SAA6D102E-2	100	100	100	82	78	65
WA320-6*	SAA6D107E-1	100	100	100	90	84	78
WA320PZ-6*	SAA6D107E-1	100	100	100	90	84	78
WA380-3	S6D108-1	100	100	100	—	—	—
WA380-5	SAA6D114E-2	100	100	100	96	87	80
WA380-6*	SAA6D107E-1	100	100	100	100	90	75
WA380Z-6*	SAA6D107E-1	100	100	100	100	90	75
WA380-7*	SAA6D107E-2	100	100	100	—	—	—
WA430-5	SAA6D125E-3	100	100	100	100	100	95
WA430-6*	SAA6D114E-3	100	100	100	93	87	—
WA470-3	S6D125-1	100	100	100	100	93	86
WA470-5	SAA6D125E-3	100	100	100	100	100	93
WA470-6*	SAA6D125E-5	100	100	100	100	94	88
WA470-7*	SAA6D125E-6	100	100	100	100	—	—
WA480-6*	SAA6D125E-5	100	100	100	90	84	78
WA500-3	SA6D140E-3	100	100	100	98	91	85
WA500-6*	SAA6D140E-5	100	100	100	—	—	—
WA500-6R*	SAA6D140E-5	100	100	100	100	95	86
WA500-7*	SAA6D140E-6	100	100	100	100	—	—
WA600-3	SAA6D170E-3	100	100	100	95	88	83
WA600-6*	SAA6D170E-5	100	100	97	92	86	80
WA600-6R*	SAA6D170E-5	100	100	100	100	95	90
WA700-3*	SAA6D170E-3	100	100	96.5	92	84	76
WA800-3, WA900-3	SA12V140-1	100	100	100	95	90	80
WA800-3E0**	SAA12V140E-3	100	100	100	98	92	83
WA900-3E0**	SAA12V140E-3	100	100	100	95	88	78
WA1200-6	SSDA16V160E-2	100	100	100	100	100	88
WD600-3	SAA6D170E-3	100	100	100	95	88	83
WD600-6	SAA6D170E-5	100	100	97	92	86	80
WD900-3	SA12V140-1	100	100	100	95	90	80
GD511A-1	S6D95L-1	100	100	100	95	—	—
GD555-3	SAA6D102E-2	100	100	100	97	90	82
GD555-5*	SAA6D107E-1	100	100	100	100	98	89
GD655-5*	SAA6D107E-1	100	100	100	94	89	85
GD663A-2	6D125-1	100	100	100	100	100	—
GD675-5*	SAA6D107E-1	100	100	100	94	89	85
GD705A-4	S6D125-1	100	100	100	100	100	96

- NOTE:**
- (1) The percentages listed above are for standard machines.
 - (2) These values at each altitude range indicate the percentage of the fueling deration rate against standard fueling calibration. 100 percent means that no fuel derate is required.
 - (3)*: With automatic altitude deration
 - (4)**: Automatic deration depending on altitude and turbo inlet air temperature (ambient temperature) is applied only to SAA12V140E-3.
 - (5) This deration rate is for reference. Please contact to OEM for actual rate, for it will be obtained by ambient temperature and altitude of the operation site.

	ENGINE	0 ~ 750 m (0 ~ 2500 ft.)	750 ~ 1500 m (2500 ~ 5000 ft.)	1500 ~ 2300 m (5000 ~ 7500 ft.)	2300 ~ 3000 m (7500 ~ 10000 ft.)	3000 ~ 3800 m (10000 ~ 12500 ft.)	3800 ~ 4600 m (12500 ~ 15000 ft.)
GD755-5R*	SAA6D125E-5	100	100	100	100	94	90
GD825A-2	S6D140E-2	100	100	100	100	100	94

- NOTE:**
- (1) The percentages listed above are for standard machines.
 - (2) These values at each altitude range indicate the percentage of the fueling deration rate against standard fueling calibration. 100 percent means that no fuel derate is required.
 - (3)*: With automatic altitude deration
 - (4) : Automatic deration depending on altitude and turbo inlet air temperature (ambient temperature) is applied only to SAA12V140E-3.
 - (5) This deration rate is for reference. Please contact to OEM for actual rate, for it will be obtained by ambient temperature and altitude of the operation site.

CONTENTS

INDEX

SECTION **12**

TIRES Sec 12



SECTION **12**

TIRES

CONTENTS

Tire Classifications 12-2

Tire Manufacturer's Designation 12-3

Tire Knowledge:

Tire size designation 12-4

Structure and function of tire 12-4

Comparison of bias and radial tires 12-7

Tread pattern 12-8

Depth of tread groove on rock-type tires 12-8

TKPH (TMPH) 12-8

Tire characteristics 12-9

Tire identification 12-10

Tire Selection 12-11

Service	TRA classification	Tread	Use
Earthmover	E-1	Rib	For front wheels of dump trucks
	E-2	Traction	For scrapers used on sandy ground and soft soil where traction is necessary.
	E-3	Rock	For dump trucks and scrapers used where resistance against external damage and abrasion is important.
	E-4	Rock Deep Tread	For scrapers and dump trucks used where resistance against external damage and abrasion is required.
	E-7	Flotation	For carry-all scrapers stronger than E3, used where only flotation is needed.
Grader	G-1	Rib	For front wheels of graders.
	G-2	Traction	For rear wheels of graders used where traction is necessary.
	G-3	Rock	For rear wheels of graders used where resistance against external damage and abrasion is necessary, rather than traction.
Loader	L-2	Traction	For loaders and dozers used on sandy ground where traction is necessary.
	L-3	Rock	For loaders and dozers used on mountain sand and on rocks where resistance against external damage and abrasion is necessary.
	L-4	Rock Deep Tread	For loaders and dozers used where resistance against external damage and abrasion is required to be stronger than those of L3.
	L-4S	Smooth Deep Tread	For loaders and dozers used where resistance against external damage and abrasion is required to be stronger than those of L-3S.
	L-5	Rock Extra-Deep Tread	For loaders and dozers used where resistance against external damage and abrasion is required to be stronger than L4.
	L-5S	Smooth Extra-Deep Tread	For loaders used where resistance against external damage and abrasion is required to be stronger than that of L-4S.
Compactor	G-1	Smooth Tread	For Tire rollers
Log-skidder	G-1	Intermediate	For skidder

**Tire Manufacturer's
Designation**

TIRES

TIRE PATTERN

TRA classification	Maker				
	BRIDGESTONE	MICHELIN	TOYO	GOODYEAR	YOKOHAMA
E1		XRIB			
E2	*VKT, VHS VSB, VFT ●VLT	XGC, XHC, XLB XMP, XS, XVC XNOPLUS Indice E		●GP-2B ●RL-2+	
E3	*VEL, *L317 *RL, *WL *VL2, ●VMT ●VSTL	●XADN XAD65, XHAD XKB, XTS, XRB XRDN	●T-332, ●T-351 ●T-352, *G-18	●GP-3D, ●TL-3A+ *HRL-3A, *EV-3+ *RL-3+	●RT31, ●RL31 ●RB31 *Y-38, *Y-67
E4	*VELS, *VRLS *VRLSA, *ELS2 *RLS, *VMTP *VZTP, *VMTS *RLS2, *VALS ●VLTS	*X-QUARRY *XDTA4 *XDRA ●XADT XDC, XDM, XHD1 XHAUL, XKD1 XRS, XZH	*T-431, *T-433 *T-451, *T-452 *T-452A, *T-452B *T-453, *G-18ET *G-36ET *G-36ETB	●GP-4BAT ●GP-4D *HRL-4B, *GP-4C *RT-4A, *GP-4B *RL-4J/4J II *RL-4H/4H II *RL-4A, *RL-4B	*RB41, *Y-523 *Y-530, *Y-523U
E7	VSJ, AL, SCP2	XRIB, XS			
G1	RG		R-3		Y-37
G2	VKT, FG, GL	XGLA2, XMPS XSNOPPLUS, XTLA	G-15, G-15A G-57S		RT21, Y-103 Y-25, Y420
G3		XHA, XHAD, XHF XLD, XRA, XRDN			Y-67
G4		XLDD1, XRD1			
G5		XLDD2			
L2	FG	XM27, XM37 XGLA2, XMPS XTLA XSNOPPLUS	G-15, G-15A G-22		Y103
L3	VSTL, TL VL2, VL2A VMT, RL	XHA, XHAD, XHF XKA, XLD, XRA XRDN, XZSL STABIL'X XZSL	T-332, T-351 T-352, G-39 G-18, G-18A G-18S, G-62		RT31, RL31, RB31 Y-575, Y-67 Y-526
L4	NL, RLS RLS2	XRD1A XDD1A XMINED1 XKD1, XLDD1	G-64, T-453 G-18ET		Y-545, Y-67ET Y-522, Y-69ET Y-69KET, Y-69U
L5	VSDL, VSDT DL DL2, DL2A	XLDD2A XMINED2 XRD2	G-65A, S-26 G-65, S-26 G-25, G-55		Y-524, Y524Z Y69KSET, Y-69SET Y-525, Y-69U

* : For Rigid Dump Truck

● : For Articulated Dump Truck

1. TIRE SIZE DESIGNATION

Indicating dimensions of tire:

Generally speaking the designation of tires refers to their size in inches and their ply rating (PR). The size of a tire means the width of and the diameter of the rim (inside diameter of tire), while the ply rating shows the strength of the carcass.

1. Tire width (cross-sectional width)
2. Tire height
3. Cross-sectional height
4. Rim diameter
5. Tire outside diameter

Bias	Nominal tire width 24.00	-	Nominal rim diameter 49	-	Ply rating 48PR
Radial	Nominal tire width 24.00	-	Nominal rim diameter 49	-	Star mark ★ ★

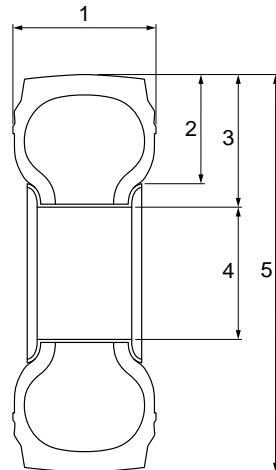

FVBH0367

Nowadays the ply rating shows the strength of the tire; it no longer shows the number of layers of cord cloth. Originally the term "ply" did in fact refer to the number of layers of cord cloth, and was therefore an indication of the tire strength. But with the development of new materials, the original cotton cord cloth changed first to rayon and has now been replaced by nylon or steel wire.

This has made it possible to greatly increase the strength without increasing the number of layers of material. Consequently the term "ply rating" has come to be used to indicate the strength of the tire rather than to express the actual number of plies.

Stars (*, **, ***) are used to indicate the strength of radial tires.

2. STRUCTURE AND FUNCTION OF TIRE

2-1 Conventional Tire

a) Tread

The tread compound used is resistant to abrasions and cuts. Tread patterns give the tire good traction, longer serviceability and higher resistance to cutting.

b) Breaker

Extra layers of rubber-coated cord are placed between the outer plies and the tread. They prevent cuts reaching the ply cords through tread, and absorb shocks.

c) Plies

A tire is composed of several layers of plies, coated on both sides by a rubber compound. These maintain inflation pressure of the tires supporting load. These plies are made of high tensile nylon cord.

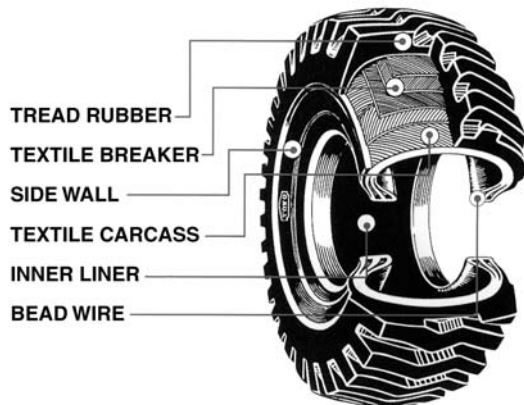

The term "Ply Rating", according to the Tire and Rim Association (TRA), is defined as follows:

"A given tire with its maximum recommended load when used in specific type service. It is an index of tire strength and does not necessarily represent the number of cord plies in the tire."

d) Inner liner

The inner liner is a rubber layer covering the inside from bead to bead of a tubeless tire, corresponding to the tube of an ordinary tube tire. It prevents the loss of inflation pressure of the tire.

e) Beads

Beads are the parts which fix the tire to the rim. All plies are tied into bundles of steel wire. The beads fit on the rim perfectly, preventing the tire from slipping out of the rim contour while the vehicle is in motion.

f) O-Ring (rim packing)

When the tire is inflated this rubber ring prevents air breaking through gaps in the rim.

g) Side-walls

Side-walls are covers made of a flexible rubber compound to protect the sides of the tire. Side-walls are designed to cushion the plies from shocks and cuts, and to flex and bend without cracking, under ordinary usage.

h) Tubes and Flaps

Function of the tube is to retain air or inert gases under pressure within the cord body. The flap protects the tube from damage by the rim and tire beads.

2-2 Shredded Wire Under Tread Tire

Shredded wire under tread tire has a special rubber layer strengthened by the shredded wire between the tread and breaker. The shredded wire rubber-layer has the following benefits.

- (1) Protects against cuts, not only reducing repair expenses, but improving the overall performance of vehicles.
- (2) Prevents small cuts from spreading.
- (3) Prevents penetration into the tire of water, dust, mud and pebbles, which can lead to cut-separation.
- (4) Cut-free strength ensures a greater number of recaps.

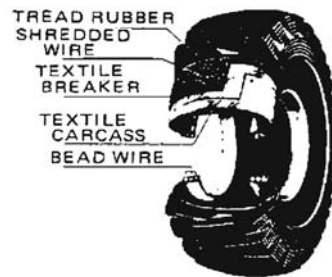

Fig.3 Construction of shredded wire under tread tire

2-3 Steel Breaker Tire

Rock pattern tires often feature breaker material. The breaker was changed from nylon to steel in order to resist cuts and cut bursts.

- (1) Tread cuts do not extend to bursting.
- (2) Puncturing of tires is reduced.
- (3) There is less carcass damage to the tire so that tire can be re-treaded many times.

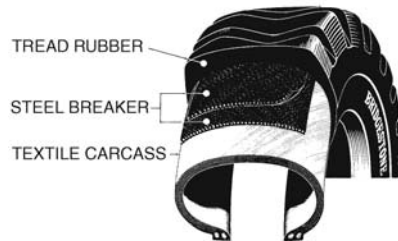

Fig.4 Construction of steel breaker tire

2-4 Side Steel Breaker Tire

In this tire the steel breaker is extended to the side-wall of the tire to protect it against side damage. The construction is similar to that described above.

2-5 Radial Tire

The crown is stabilized by a belt made up of several plies.

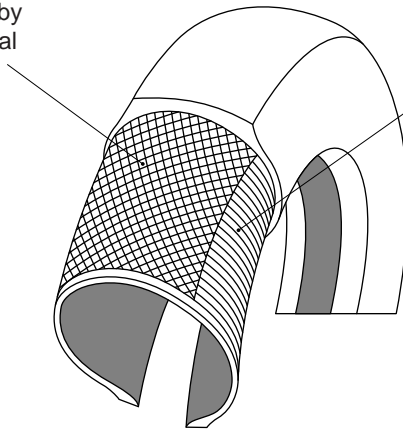

The casing has only one radial ply.

FVBH0370

The side-wall and tread areas function separately. The tread is unaffected by the flexing of the side-walls, so there is:

- less deformation of the tire contact areas on the ground ;
- less friction with the ground.

There is no movement between casing plies.

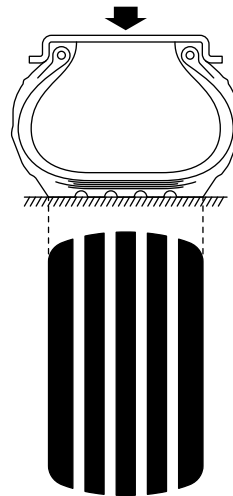

FVBH0371

3. COMPARISON OF BIAS AND RADIAL TIRES

3-1 Structure and features of tires

	Structure of radial tires	Structure of bias tires
Carcass	The carcass cord faces in a radial direction (at 90° across the tire). • There is one layer (ply)	The carcass cord faces at bias (angle to the tire). • Several plies are placed on top of each other and at an angle to each other.
Side wall	Only a single ply is used, so the side wall is flexible. • To improve the resistance of the side wall to cuts, the carcass is turned up.	The plies are placed on top of each other at an angle, so the side wall is thick.
Tread	To distribute the load around the circumference there is a steel belt layer which gives the tread high rigidity.	A breaker is used to protect the carcass and to prevent the tread and carcass from separating (Normally, a nylon breaker is used. Steel breakers are not suited for high speed travel.)
Bead	Single bead structure	There are multiple plies, so there are also multiple beads. (For dump trucks, there are normally three).
Tire inflation pressure	Because of the structure of the tire, the inflation pressure is higher than with bias tires.	Normally 5 - 7 kg/cm ²

3-2 Suitable tire

Feature required	Suitable		
	Radial	Bias	
Wear life	○		
High speed travel (heat resistance)	○		
Cut resistance	Penetration resistance	○	
	Sidecut resistance		○
Fuel consumption	○		
Travelability (traction, flotation) Riding comfort	○		
	○		
Cost	Initial cost		○
	Operating cost	○	

4. TREAD PATTERN

The tread pattern can be divided broadly into the type in Fig. 1, which has no circumferential groove in the tread center, the type in Fig. 2, which has transversal grooves, and the type in Fig. 3, which has a block pattern. Generally speaking, the first type provides excellent resistance to cutting and wear, while the second type provides excellent traction on slippery surfaces. The block pattern is typical of radial tires giving good all round performance.

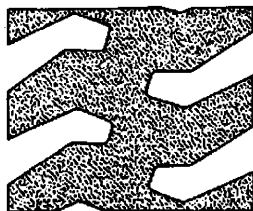

Fig. 1

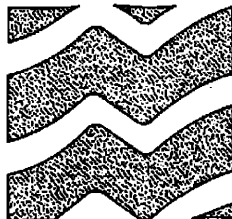

Fig. 2

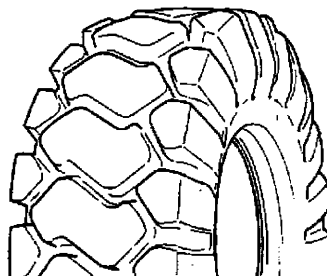

Fig. 3

5. DEPTH OF TREAD GROOVE ON ROCK-TYPE TIRES

There are the following depths of grooves for dump truck tires. The main feature of the deep groove tire is the large amount of wear tolerance.

Table 2-2

Category of groove depth	TRA code	General use	Groove depth
General groove	E3	Hard soil, general	100
Deep groove	E4	When it is necessary to have greater resistance to external damage and resistance to wear than with E 3.	Approx. 150

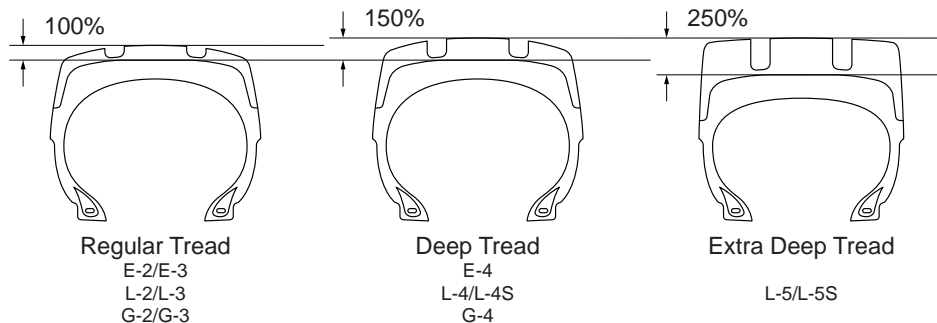

6. TKPH (TMPH)

The primary task of heavy-duty tires is to haul heavy loads faster and over longer distances. This heavy load hauling inevitably results in heat built-up inside the tires, and tires have limitation of temperature.

If this limitation is reached, deterioration of the tire will begin at an early stage of operation. Accordingly, it is necessary when selecting tires, to determine the amount of work will keep the tire within a safe range to avoid over-heating when a vehicle is operated under given conditions.

The amount of work done under the given conditions and within a safe range is shown as the "TON-KILO-PER-HOUR" ("TON-MILE-PER-HOUR") which can be determined by the following formula:

TKPH(TMPH) = (Average tire load) × (Average speed)

Average tire load = 1/2 (tire load when vehicle carries no load + tire load when vehicle is loaded)

Average speed = $\frac{\text{round trip distance} \times \text{number of job cycles per day}}{\text{total hours of operation per day}}$

- Total hours of operation include recess and dead time.

7. TIRE CHARACTERISTICS

The optimum tires should be selected for their applicable operation or job and terrain conditions depending on the cutting (wear) resistance and heat resistance. These resistant qualities are indicated as follows:

(1) CR (cutting resistance)

Excellent durability against cuts and wear due to excess road crown, imbedded or loose rocks, sharp objects, etc.

(2) HR (Heat resistance)

A resistant quality against the internal heat generation makes a machine suitable for long hauls.

(3) GP (General purpose)

Tires having medium degree of the above resistant qualities, CR and HR.

(4) Shredded wire under tread and steel breaker types

These types of tires are made more durable against cuts than the CR with special precautions to limit tire wear and cutting by incorporating the layer of steel cord between tread and casing, or by providing a cord - reinforced rubber interlay between the tire cover and plies to shield the plies against penetration by sharp objects.

Selection of tires to match required characteristics (tire structure, quality of rubber)

Specification	Tread rubber quality			Structure		
	Standard	Heat resistance	Cut resistance	Nylon breaker	Steel breaker	Side steel breaker
Wear resistance	○	△	⊙	○	○	○
Cut resistance	Tread	○	△	○	⊙	⊙
	Side	○	○	○	○	⊙
Heat resistance	○	⊙	△	○	△	△
Traction, flotation	○	○	○	○	○	○

⊙ : Excellent ○ : Good △ : Fair

Because of the structure and quality of the rubber used for the tread, cut resistance and wear resistances are mutually opposite to heat resistance, so when selecting tires, always check the TKPH.

Depending on the tire, super heat-resistant (SHR) and super cut-resistant (SCR) tread rubber are available, so ask your tire distributor for details of tires that are not listed in the operation manual.

8. TIRE IDENTIFICATION

Tire characteristics	BRIDGESTONE	MICHELIN	YOKOHAMA	TOYO
CR (Cut-resistant)	2A (cut-resistant) 2V* (Special cut-resistance) 2Z* (Special cut-resistance)	A4 A	CP (Cut protected) CP-C (Cut protected specification) CP-S (Cut protected and reinforced specification)	CR (Cut-resistant)
GP (General purpose)	1A (Standard)	B4 B	REG (Regular) PE-R (Regular specification) RE-T (Regular heat-resistant specification)	SP (Standard purpose)
HR (Heat-resistant)	3A (Heat-resistant)	C4 C	HR (Heat resistant) HR-H (Heat-resistant specification) HR-V (Heat-resistant and reinforced specification)	HR (Heat resistant)

* Bias tire only

Code identification for MICHELIN tires

Type A4: Particularly resistant to cuts, tread tearing and abrasion on very rough surfaces.

Type A: Particularly resistant to cuts, tread tearing and abrasion at average speeds which are higher than those for A4 (above).

Type B4: Compromise solution between abrasion resistance and average speed on rough surfaces. (available in sizes 49 inch rim diameter and above)

Type B: Higher resistance to internal heat generation on surfaces which are not particularly rough.

Type C4: For running on long cycles at high speeds on well maintained roads.

Type C: Very high resistance to high average speeds on long cycles run on well maintained roads

Code identification for GOODYEAR

Compound Code	Compound Type
2	Ultra Heat Resistant
3	Heat Resistant
4	Abrasion Resistant
6	Ultra Abrasion Resistant

Construction Code	Construction Type
S	Standard
H	Heavy Duty
HR	Heavy High Speed
HW	Extra Heavy Duty

Selecting tires suitable to working conditions (Structure of tire and quality of rubber)

Examples of procedure for selecting tires of dump truck and wheel loader

		Procedure for selecting tires		
Dump truck	(1) Carrying material in mine (limestone) or stone crushing pit (RDT, ADT)	Tires generate little heat Tires have high chance to be cut	⇒ Cut resistance Abrasion resistance	⇒ Deep-groove (E-4) Cut-resistant rubber Steel breaker
	(2) Carrying material in mine (coal, iron ore, etc.) (RDT, ADT)	Tires generate much heat Tires have medium chance to be cut Working speed is high	⇒ Heat resistance Abrasion resistance Cut resistance	⇒ General-groove, deep-groove E3, E4 Heat-resistant tread rubber Radial structure
	(3) Carrying material in dam construction or civil engineering field (RDT, ADT)	Tires generate much heat Tires have medium chance to be cut	⇒ Heat resistance Abrasion resistance Cut resistance	⇒ General-groove, deep-groove (E3, E4) Heat-resistant tread rubber Radial structure
	(4) Carrying material on soft (muddy) ground (ADT)	Tires generate little heat Tires have high chance to be cut Ground pressure is low	⇒ Cut resistance High floating performance Abrasion resistance	⇒ General-groove, deep-groove (E3, E4) Heat-resistant tread rubber Radial structure
Wheel loader	(1) Mining and collecting natural stones	Tires generate little heat Tires have high chance to be cut Abrasion life is short	⇒ Cut resistance Abrasion resistance	⇒ Deep-groove or ultra deep-groove (L-4, L-5) Cut-resistant tread rubber General-groove (L3) + Steel breaker or side steel breaker
	(2) Loading products of mine or stone crushing pit	Tires generate little heat Tires have low chance to be cut Abrasion life is long	⇒ Durability of carcass Crack resistance (Deterioration)	⇒ General-groove (L3)
	(3) Loading and carrying sand and gravel	Tires generate little heat Tires have little chance to be cut Abrasion life is long	⇒ Durability of carcass Crack resistance Traction	⇒ General-groove (L3) Traction (L-2)
	(4) Load and carry operation	Tires generate much heat Tires have little chance to be cut Abrasion life is long	⇒ Heat resistance Crack resistance	⇒ Heat-resistant tread rubber General-groove (L3) Traction (L-2)

NOTE: Some tires in the above table cannot be selected for some destinations.

MEMO

A series of horizontal dashed lines for writing.

CONTENTS

INDEX

SECTION **13**

FOR SEVERE ENVIRONMENTS Sec 13A

FOR MINING Sec 13B

SECTION **13A**

**FOR SEVERE
ENVIRONMENTS**

CONTENTS

Introduction	13A-2
Recommendation for Low Grade Fuel Usage	13A-3
Recommendation for Sandy and Dusty Terrain Condition	13A-4
Recommendation for High Altitude	13A-5
Recommendation for Cold and Extremely Cold Weather Area	13A-7
Tropical Weather Specification	13A-9

KOMATSU products are designed to meet various application requirements in a wide range of natural environment and social situations on the globe. For operation under extremely severe environmental conditions, where the mere standard spec is inadequate, KOMATSU offer a variety of options for special application to be added to or substituted for the standard spec so as to reach the full potential of the machine even in such conditions.

Machine operating conditions that require special care are as follows:

- Fuel quality: (1) areas where low grade fuel is generally used
- Ambient air quality: (2) areas where sand/dust will be thickly blown up
- Altitude: (3) areas at very high altitudes
- Ambient air temperature: (4) areas whose climate is cold or frigid, (5) tropical regions

In this chapter, why such special care is necessary and what are in the special spec are explained with typical examples.

It is recommended to consult KOMATSU through the distributor for actual choice of a spec for such special application.

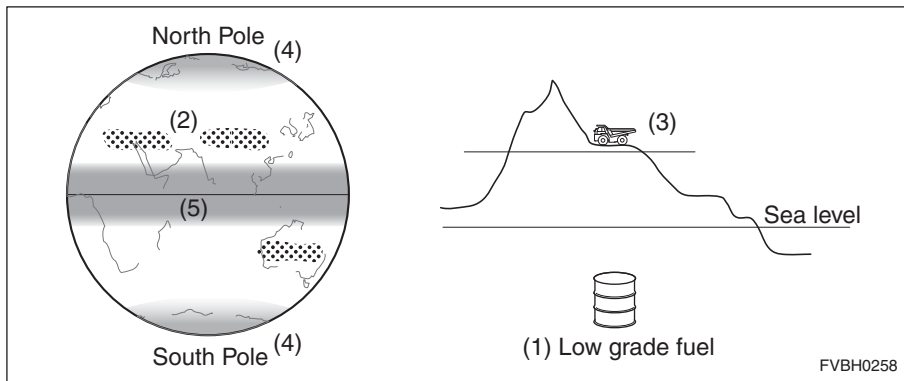

The quality of fuel depends on the districts and fuel suppliers. In addition, if the fuel is stored under bad condition, its quality may be lowered.

1) Dirt

Since dirt in the fuel clogs the filter quickly, it can lower the engine power. In addition, it can lower circulation of the fuel and wear the internal parts of the injection pump quickly. To solve this problem, a filter of finer mesh should be used or the number of filters should be increased.

(Additional fuel filter for low grade fuel)

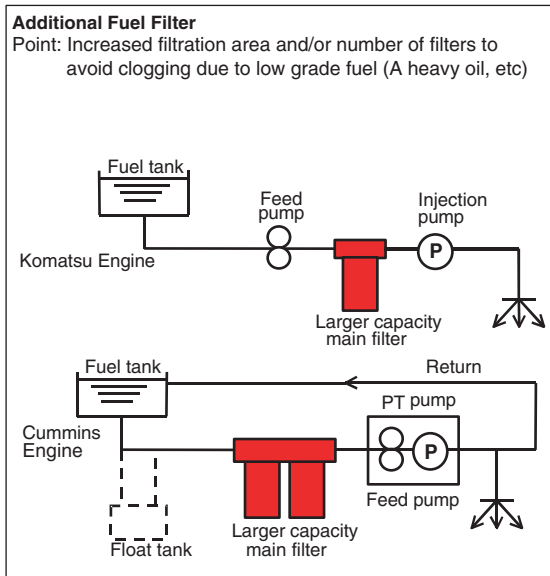

This figure shows an example.
It is not applicable to every model.

2) Water

Water in fuel rusts the fuel piping. In addition, it lowers lubrication performance, and that wear the sliding parts of the injector, injection pump, etc. To solve this problem, a water separator should be installed.

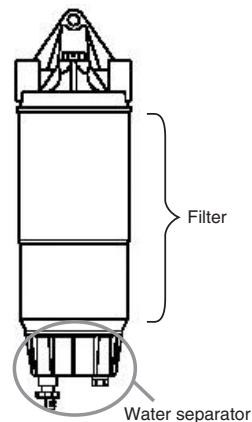
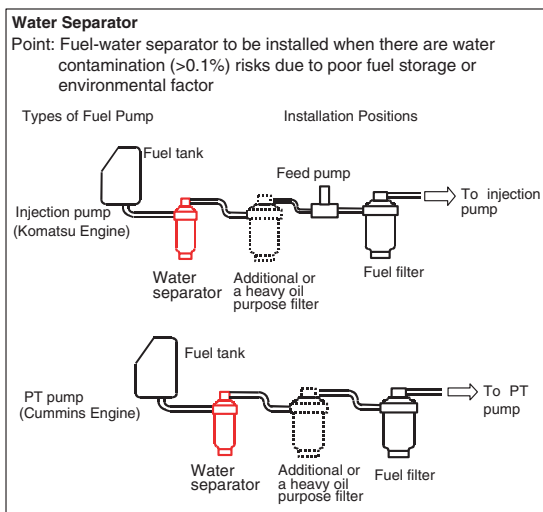

Example) Filter and water separator unit

3) Sulfur

If fuel contains sulfur, sulfuric acid is produced and it accelerates internal corrosion. If it is obliged to use fuel containing sulfur by 0.5% or more, use high TBN (Total Base Number) oil.
If fuel containing sulfur is used, the oil is deteriorated quickly and it should be replaced at shorter intervals.
For detail, see MAINTENANCE in the Operation & Maintenance manual.

Recommendation for Sandy and Dusty Terrain Condition

FOR SEVERE ENVIRONMENTS

This specification should be applied to not only sandy terrain but also dusty terrain. It is essential when the view range is 0 meter.

1) Quick clogging of air cleaner

If the air cleaner is clogged quickly, the engine power lowers, the exhaust temperature rises, and wear of the internal parts of the engine is accelerated. If the exhaust temperature rises above the allowable level, the cylinder head may crack and the valves may melt.

In addition, the rotating parts are worn quickly and the radiator core fins are also worn quickly by the collision of grains of sand. The radiator dust-proof grid is prepared to prevent quick wear of the radiator core fins. It is not necessary, however, if the hydraulic suction fan is installed.

2) Cyclone-type pre-cleaner

While the dust accumulated in the conventional US pre-cleaner must be removed by hand, the dust swirled and sucked into TURBO-II and Enginaire (as example) are discharged automatically by a centrifugal force.

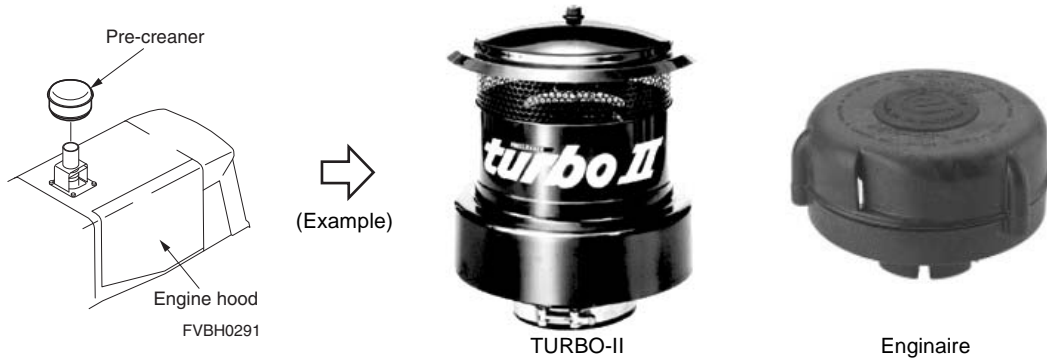

3) 5-stage dust indicator

The 5-stage dust indicator shows how much the air cleaner is clogged and if the air cleaner can be used again after it is cleaned.

(Example)

Conventional type



OK/NG (not OK)
display only

New type



New part number: 08672-01000
(Current part number: 600-184-1920)
<The main unit and connectors are set.>

Negative pressure display part
The clogging state is self-evident from the five stages scale displayed on the yellow display unit.

The air cleaner element must be replaced with new one after it is cleaned 6 times. If this new indicator is used, however, the air cleaner element can be replaced according to its clogging condition. As a result, the maintenance cost can be reduced.

As altitude is increased, air is more rarefied (atmospheric oxygen is reduced) and the quantity of fuel is increased for the quantity of air. As a result, combustion becomes incomplete and the exhaust temperature rises. The rise of the exhaust temperature can cause a serious engine trouble such as melting of the valves. In addition, the air resistance decreases and the turbocharger speed rises extremely and its lifespan is shortened remarkably.

- 1) The fuel injection rate must be reduced to secure a proper air-fuel ratio for combustion. If a mechanical injection pump is employed, it must be readjusted mechanically. If fuel is controlled electronically, the software of the engine controller must be changed.
- 2) Turbocharger
 - 1) The turbocharger may need to be replaced with one equipped with an over-speed prevention device.
 - 2) The turbocharger may need to be replaced with a water-cooled one to prevent shortening of its lifespan caused by high temperature.
 (Example: Water-cooled turbocharger)

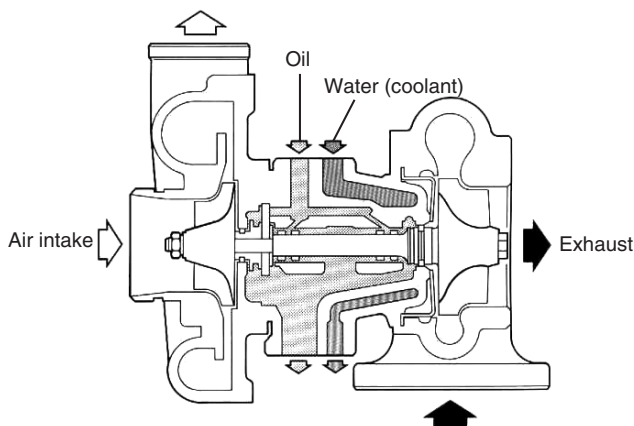

3) Pressurized hydraulic tank

As the atmospheric pressure lowers, the hydraulic oil may be aerated, and that may cause cavitation in pumps. To prevent this problem, a pressurizing system may be required.

(Example: Pressurization of hydraulic tank of HD785-5)

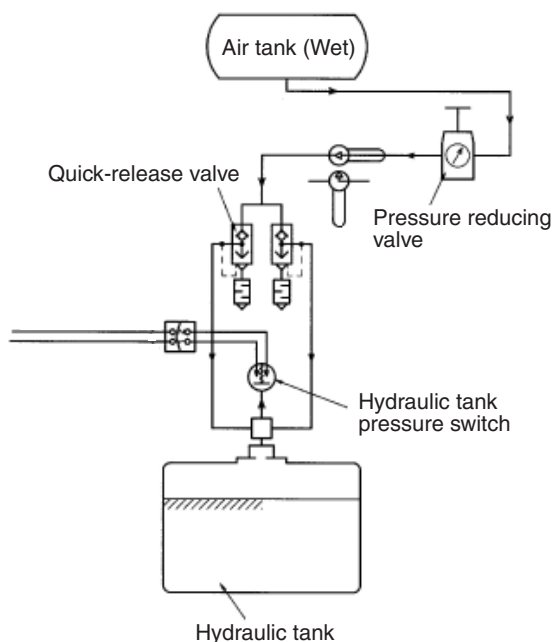

It is reported that simple pressurization with a conventional tank cap is sufficient for a machine equipped with a hydraulic tank at a high position like a hydraulic excavator. Necessity of pressurizing system must be checked for each model.

(Example: HD785-5 with high altitude specification)

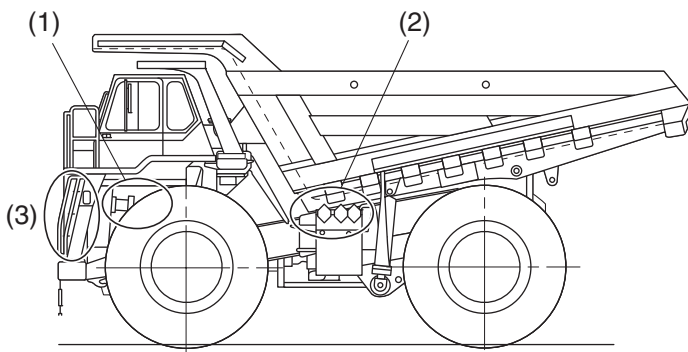

FVBH0299

1) Change of engine specifications

- Improvement of turbocharger

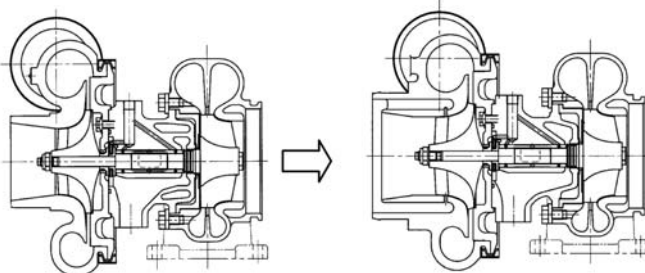

Current turbocharger

Improved turbocharger
Inlet circulation type

- Derating of engine output
Fuel injection derating: 20%

2) Pressurization of hydraulic tank

The hydraulic tank is pressurized with air to prevent cavitation caused by lowering of suction pressure of the hydraulic pumps.

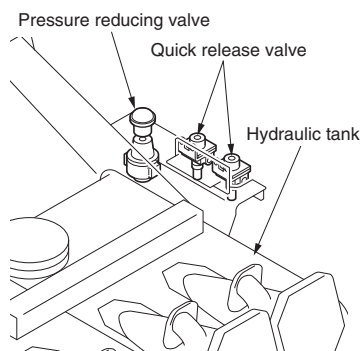

FVBH0292

3) Pressurization of radiator

The radiator cap is replaced to prevent lowering of boiling point at high altitude.

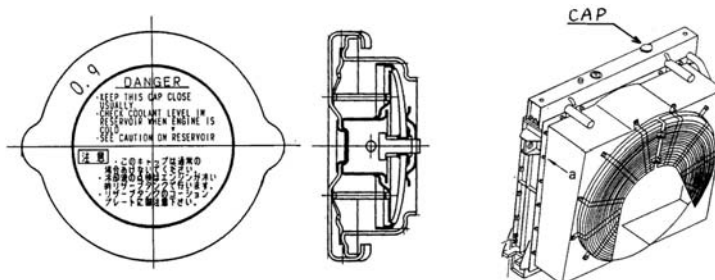

Standard specification: 0.7 kg/cm² -> High-altitude specification: 0.9 kg/cm²

Recommendation for Cold and Extremely Cold Weather Area

FOR SEVERE ENVIRONMENTS

In a cold district or a cold season, the engine does not start easily because of the low temperature. The reasons for this phenomenon is that the battery lowers in function and cannot supply a necessary current and the resistance to rotation increases as the viscosity of the lubricating oil of the power train and hydraulic oil increases. In addition, if the temperature lowers below -20°C , the oil in the track rollers and final drive solidifies. As a result, the floating seals are dragged and the O-rings are broken, and that can cause internal breakage.

To solve these problems, the following measures are necessary.

(Example)

Part	Spec	Cold weather	Extremely cold weather	Note	Purpose
	Minimum ambient temp.	$-30 \sim -20^{\circ}\text{C}$	$-50 \sim -30^{\circ}\text{C}$		
Battery (☆1) Starting motor Alternator		Large-capacity Large-capacity Large-capacity	Large-capacity Large-capacity Large-capacity	Cable	Improvement of startability (On drive side)
Measures to prevent overcooling • Reversible fan		Necessary	Necessary	Since hydraulic driven fan can rotate in reverse, reversible fan is not necessary.	Prevention of lowering of power
• Radiator curtain • Radiator shutter • Ktilting		Necessary Unnecessary Unnecessary	Necessary Necessary Necessary		
Reduction of dragging torque • Oil pan heater (☆2) • Combustion heater (☆3)		Unnecessary Unnecessary	Necessary Necessary		Improvement of startability (Lowering of resistance on driven side)
Undercarriage • Employment of seals coated with nylon • Employment of oil which does not solidify even at -55°C		Necessary Necessary	Necessary Necessary		Prevention of breakage of undercarriage caused by solidification of oil

(Example) D275A-5 with extremely cold weather specification (cold weather specification for CIS)

1) Warmth keeping for easy engine start

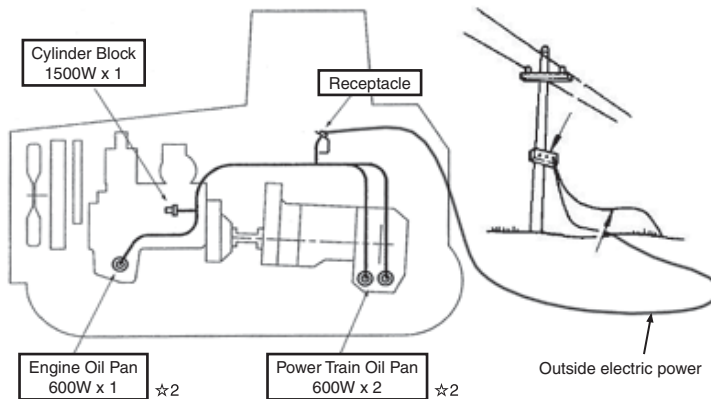

2) Preheating system for low-temperature start

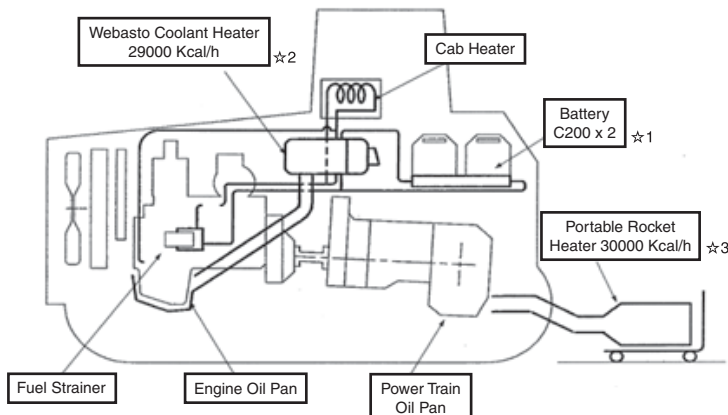

**Recommendation for Cold and
Extremely Cold Weather Area**

**FOR SEVERE
ENVIRONMENTS**

**Arctic Temperature Requirements for the Komatsu Hydraulic Mining Shovels
PC 3000 / PC 4000 / PC 5500 / PC8000**

Elements	Temperature down to -25°C	Temperature down to -40°C	Temperature down to -50°C
High stress steel structure	X	manufacture's check ISO V-notch test 27 J at -40°C	manufacture's certificate ISO V-notch test 27 J at -50°C
Castings and forgings	X	manufacture's check ISO V-notch test 27 J at -40°C	manufacture's certificate ISO V-notch test 27 J at -50°C
Screws and bolts	X	material change	material change
Electric cable	X	material change	material change
Batteries	X	preheating	preheating
Hoses	X	X	ICE-Champion flange sealings changed
Engine start	ether start	preheating + ether start	preheating + ether start low idle adjusted to 1100 rpm
Engine coolant	X	preheating	preheating
Engine oil	X	preheating	preheating
Hydraulic oil	X	preheating	preheating
Pump drive gear boxes	X	preheating	preheating
Cab base electric cabinet	X	preheating	preheating
Cab	X	preheating	preheating
Machinery house	X	X	preheating closed from below air-inlet and - outlet reduced
Sealings	X	partly material change	partly material change
Cylinder	X	material change of bolts	material change of sealings and scraper
Travel motor	X	X	preheating by hydraulic circuit

X = standard delivery (no changes)

If the machine is used in a jobsite where the atmospheric temperature exceeds +40°C and rises up to +50°C, the temperature of the coolant and lubricating oil may rise above the allowable limit. Under this condition, the engine and power train overheat and the lifespan of each part is shortened.

1) Large-sized radiator cooling fans

It is necessary to cool the coolant and lubricating oil properly. (Example: HD785-5, HD985-5)

2) Antifreeze

Antifreeze is not necessary naturally. Since fresh water is used, the heat balance is improved about 4°C. Corrosion resistor must be added and replaced periodically, however, to prevent rusting of inside of the engine.

It is also important for protection of the engine to use soft water such as city water, since water in rivers and ponds is hard in many cases.

Some large-sized models for Australia can operate up to +55°C.

(Example) PC1800-6 with +55°C specification

1) Large-sized radiator cooling fan

- Increase of oil cooler capacity
- Increase of radiator capacity
- Increase of fan diameter and speed
- Improvement of air flow in engine hood (Addition of perforated cover for door on pump side and duct on radiator side)

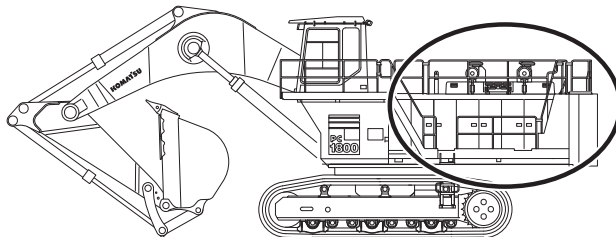

FVPM2967A

2) Muffler mounted on outside

3) Air cleaner mounted on outside

4) Heat resistant alternator

5) Additional PTO cooler (installed in front of radiator)

- 2) Muffler mounted on outside 3) Air cleaner mounted on outside

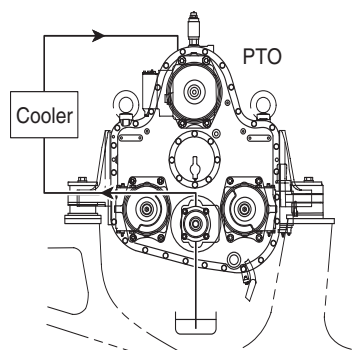
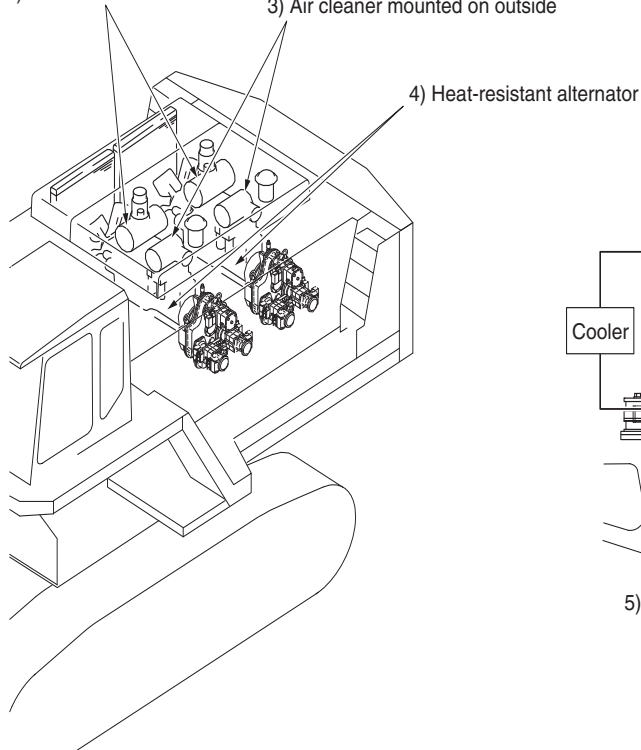

5) Additional PTO cooler (Installed in front of radiator)

FVBH0293

MEMO

A series of horizontal dashed lines for writing.

SECTION 13B

FOR MINING

CONTENTS

What is HAT?	13B-2
How to Read HAT Output?	13B-2
Haulage Analysis Tool	13B-4
WA900/HD785	13B-4
WA900HL/HD1500	13B-5
WA1200/730E	13B-6
WA1200HL/830E	13B-7
PC1250SP/HD605	13B-8
PC2000/HD785	13B-9
PC3000/HD1500	13B-10
PC4000/730E	13B-11
PC5500/830E	13B-12
PC8000/930E	13B-13

What is HAT?

- The Haulage Analysis Tool (HAT) v4.0 software program generates haulage fleet performance results in both graphical and digital formats.
- Built-in sensitivity analysis allows the user to study productivity and cost variability as Round Trip Travel Time and Truck Fleet Size change, which can be of value when identifying the proper fleet configuration for variable application conditions.

How to Read HAT Output?

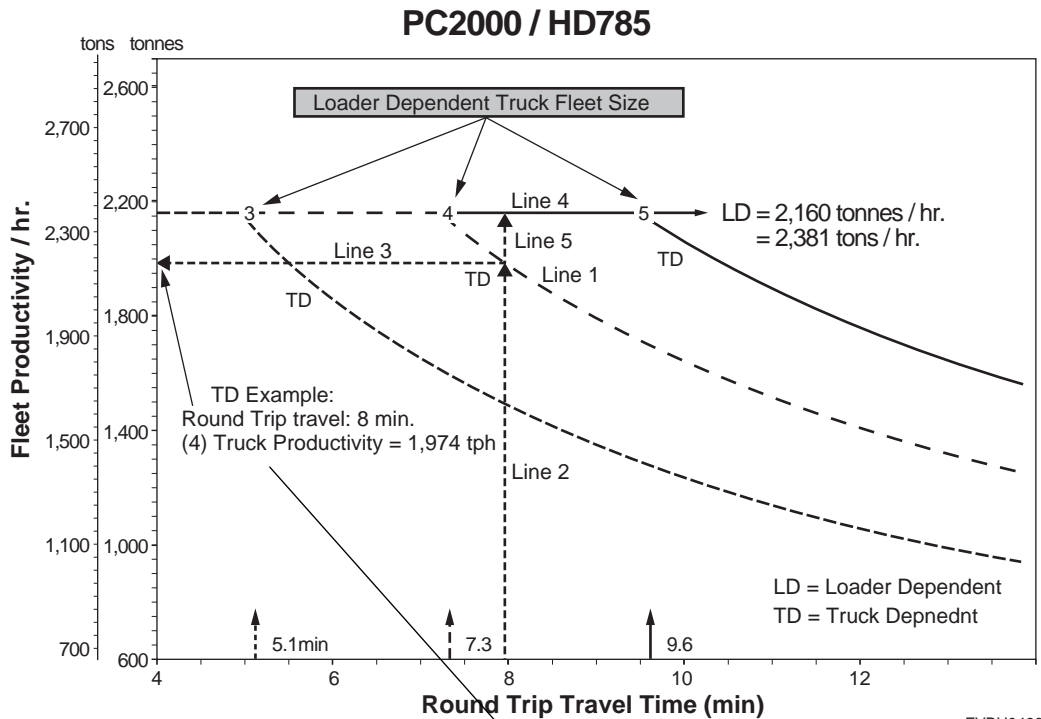

FVBH0496

Parameter:

Loading Tool = PC2000
Hauling Tool = HD785

Material Density (kg / lcm) = 1,780
Material Swell (%) = 30%
Bucket Size (lcm) = 12
Bucket Fill (%) = 95%
Cycle Time (sec) = 30
No. of Passes = 4
Truck Payload (tonnes) = 81
Truck Spot Time (sec) = 15
Efficiency (min / hr) = 60

lcm: loose cubic meter

tph		FLEET PERFORMANCE		
		3 Trucks	4	5
RTTT (min)	3	2,160	2,160	2,160
	4	2,160	2,160	2,160
	6	1,857	2,160	2,160
	8	1,480	1,974	2,160
	10	1,230	1,641	2,051

Loader Dependent - LD
Truck Dependent - TD

How to obtain productivity in a Truck Dependent (TD) application:

Graphical Method:

- 1) For a given Round Trip Travel Time figure, draw a vertical line to the curved line (tail) that represents the desired fleet size. (Example: an 8 minute Travel Time and a (4) truck haulage fleet, see Line 2 and Line 1 respectively).
- 2) Draw a horizontal line left from the intersection of Line 1 and Line 2. Where this line intersects the vertical axis is the productivity of the fleet in this application. (Example: see Line 3, 1,974 tph).

Matrix Method:

- 1) Within the matrix, for any given Round Trip Travel Time and Haulage Fleet Size configuration, a white cell represents Truck Dependent Productivity. (Example: an 8 minute Travel Time and a (4) truck haulage Fleet = 1,974 tph).

How to determine productivity in a Loader Dependent (LD) application:

Graphical Method:

- 1) Loader Dependent productivity is constant and is displayed at the right end of Line 4. (Example: 2,160 tonnes / hr.).

Matrix Method:

- 1) Within the matrix, any productivity in a shaded cell represents a Loader Dependent Application. (Example: 2,160 tonnes / hr.).

How to determine the number of trucks required for a Loader Dependent Application:

- 1) For any Round Trip Travel Time, draw a vertical line to Line 4. (Example: 8 minute Round Trip Travel Time, see Line 5).
- 2) The Loader Dependent Fleet Size value to the right of this intersection represents the fleet size in this application. (Example: 5 trucks).

How to obtain the productivity of a Single Truck:

Truck Dependent Application:

1. First follow the steps to obtain Truck Dependent Fleet Productivity.
Divide the Truck Dependent Fleet Productivity by the number of trucks to determine Single Truck productivity. (Example: 1,974 tph ÷ (4) Trucks = 494 tph).

Loader Dependent Application:

1. First follow the steps to obtain Loader Dependent Fleet Productivity.
Divide the Loader Dependent Fleet Productivity by the number of trucks to determine Single Truck productivity. (Example: 2,160 tph ÷ (5) Trucks = 432 tph).
Note: In a Loader Dependent Application, the productivity of a single truck includes wait time at the loader.

WA900 / HD785

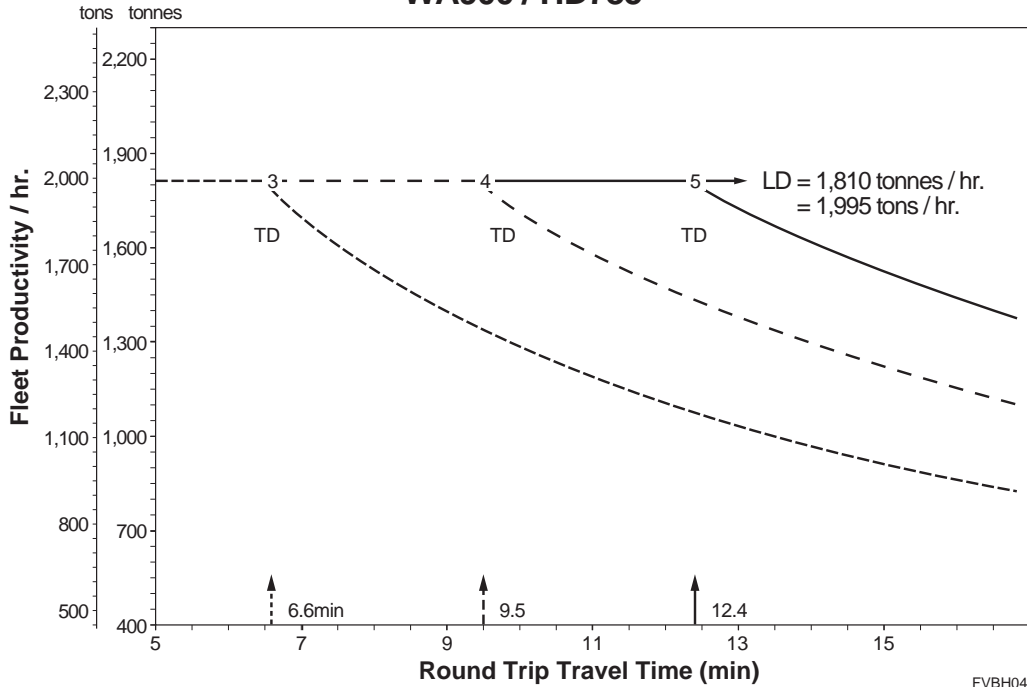

Parameter:

Loading Tool = WA900
Hauling Tool = HD785

Material Density (kg / lcm) = 1,780
Material Swell (%) = 30%
Bucket Size (lcm) = 13
Bucket Fill (%) = 95%
Cycle Time (sec) = 40
No. of Passes = 4
Truck Payload (tonnes) = 88
Truck Spot Time (sec) = 15
Efficiency (min / hr) = 60

tph		FLEET PERFORMANCE		
		3 Trucks	4	5
RTTT (min)	2	1,810	1,810	1,810
	4	1,810	1,810	1,810
	6	1,810	1,810	1,810
	8	1,530	1,810	1,810
	11	1,187	1,582	1,810

Loader Dependent - LD
Truck Dependent - TD

WA900HL / HD1500

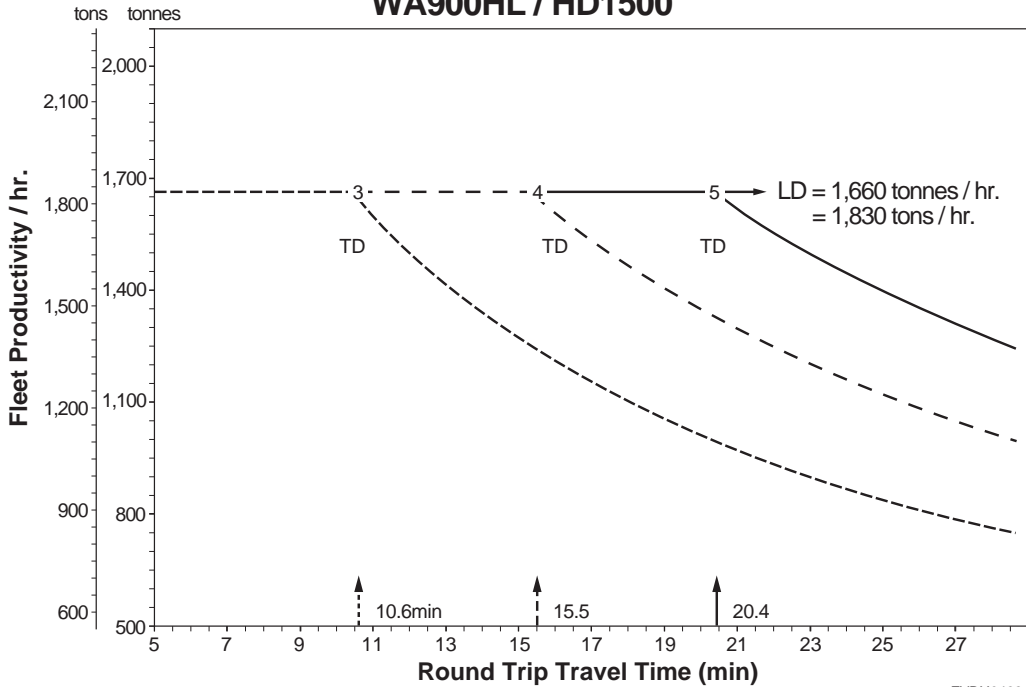

Parameter:

Loading Tool = WA900 HL
 Hauling Tool = HD1500

Material Density (kg / lcm) = 1,780
 Material Swell (%) = 30%
 Bucket Size (lcm) = 11.5
 Bucket Fill (%) = 95%
 Cycle Time (sec) = 40
 No. of Passes = 7
 Truck Payload (tonnes) = 136
 Truck Spot Time (sec) = 15
 Efficiency (min / hr) = 60

tph		FLEET PERFORMANCE		
		3 Trucks	4	5
RTTT (min)	6	1,660	1,660	1,660
	10	1,660	1,660	1,660
	15	1,265	1,660	1,660
	19	1,048	1,398	1,660
	24	863	1,151	1,439

Loader Dependent - LD
 Truck Dependent - TD

WA1200 / 730E

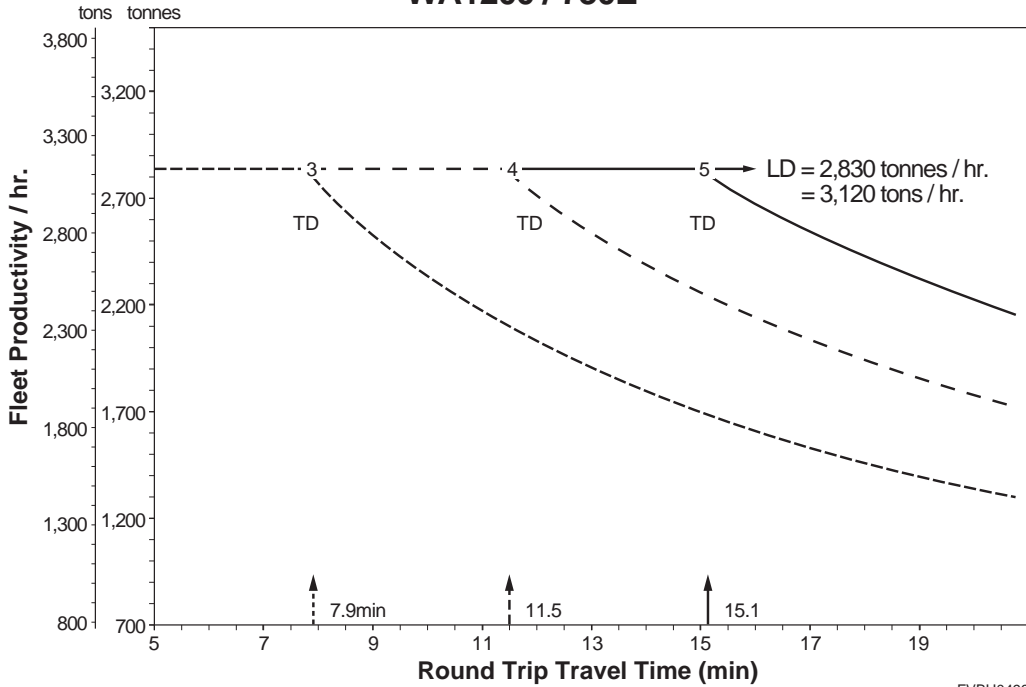

FVBH0499

Parameter:

Loading Tool = WA1200
 Hauling Tool = 730E

Material Density (kg / lcm) = 1,780
 Material Swell (%) = 30%
 Bucket Size (lcm) = 20
 Bucket Fill (%) = 95%
 Cycle Time (sec) = 40
 No. of Passes = 5
 Truck Payload (tonnes) = 169
 Truck Spot Time (sec) = 15
 Efficiency (min / hr) = 60

tph		FLEET PERFORMANCE		
		3 Trucks	4	5
RTTT (min)	6	2,830	2,830	2,830
	9	2,531	2,830	2,830
	12	2,026	2,701	2,830
	15	1,688	2,251	2,830
	18	1,447	1,930	2,412

Loader Dependent - LD
 Truck Dependent - TD

WA1200HL / 830E

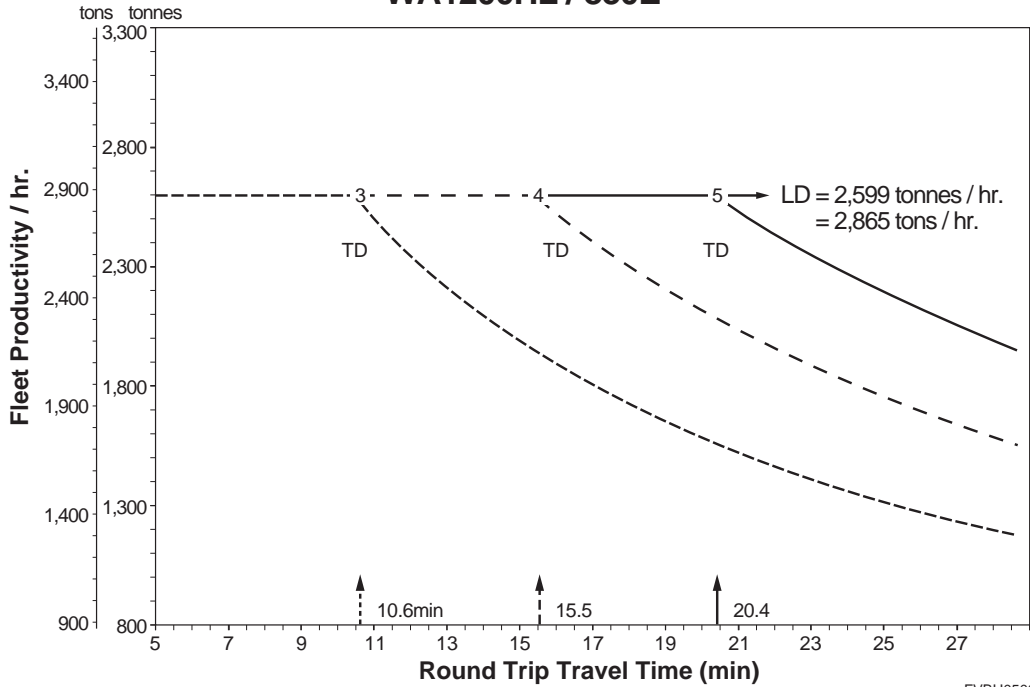

FVBH0500

Parameter:

Loading Tool = WA1200HL
Hauling Tool = 830E

Material Density (kg / lcm) = 1,780
Material Swell (%) = 30%
Bucket Size (lcm) = 18
Bucket Fill (%) = 95%
Cycle Time (sec) = 40
No. of Passes = 7
Truck Payload (tonnes) = 213
Truck Spot Time (sec) = 15
Efficiency (min / hr) = 60

tph		FLEET PERFORMANCE		
		3 Trucks	4	5
RTTT (min)	6	2,599	2,599	2,599
	10	2,599	2,599	2,599
	15	1,981	2,599	2,599
	19	1,642	2,189	2,599
	24	1,352	1,803	2,254

Loader Dependent - LD
Truck Dependent - TD

PC1250SP / HD605

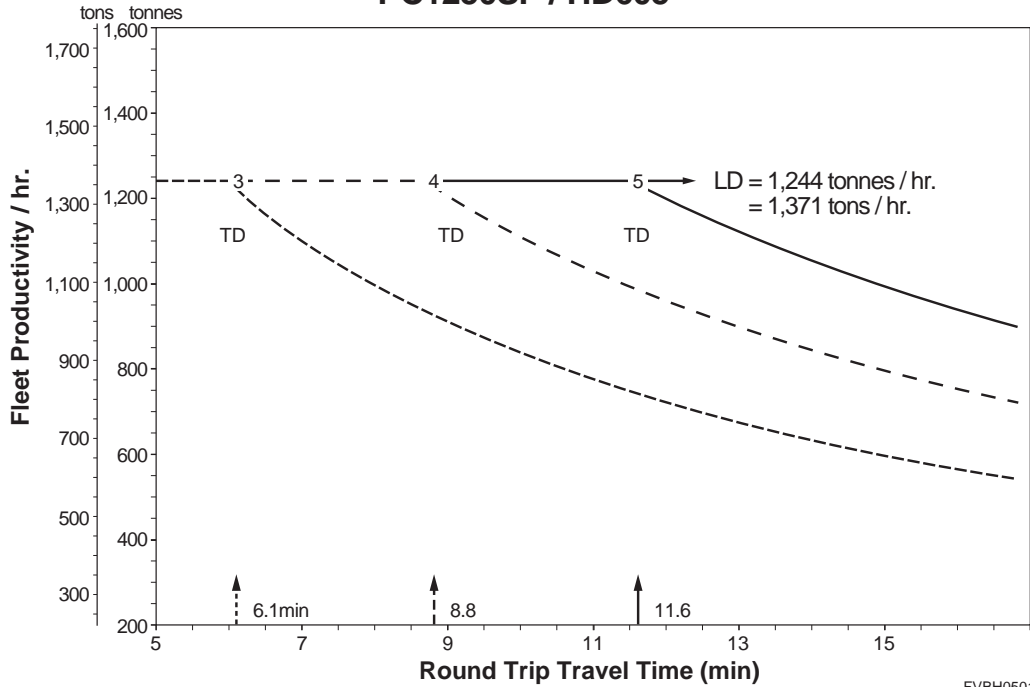

FVBH0501

Parameter:

Loading Tool = PC1250SP
Hauling Tool = HD605

Material Density (kg / lcm) = 1,780
Material Swell (%) = 30%
Bucket Size (lcm) = 6.7
Bucket Fill (%) = 95%
Cycle Time (sec) = 30
No. of Passes = 5
Truck Payload (tonnes) = 57
Truck Spot Time (sec) = 15
Efficiency (min / hr) = 60

tph		FLEET PERFORMANCE		
		3 Trucks	4	5
RTTT (min)	2	1,244	1,244	1,244
	4	1,244	1,244	1,244
	6	1,244	1,244	1,244
	8	991	1,244	1,244
	11	769	1,025	1,244

Loader Dependent - LD

Truck Dependent - TD

PC2000 / HD785

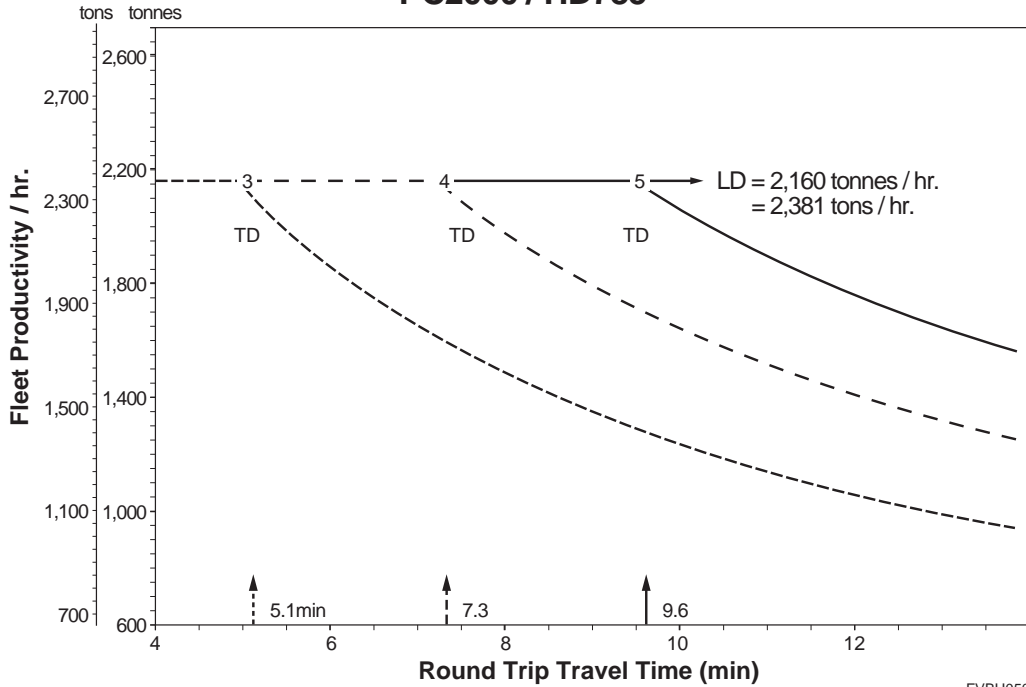

FVBH0502

Parameter:

Loading Tool = PC2000
 Hauling Tool = HD785

Material Density (kg / lcm) = 1,780
 Material Swell (%) = 30%
 Bucket Size (lcm) = 12
 Bucket Fill (%) = 95%
 Cycle Time (sec) = 30
 No. of Passes = 4
 Truck Payload (tonnes) = 81
 Truck Spot Time (sec) = 15
 Efficiency (min / hr) = 60

tph		FLEET PERFORMANCE		
		3 Trucks	4	5
RTTT (min)	3	2,160	2,160	2,160
	4	2,160	2,160	2,160
	6	1,857	2,160	2,160
	8	1,480	1,974	2,160
	11	1,230	1,641	2,051

Loader Dependent - LD
 Truck Dependent - TD

PC3000 / HD1500

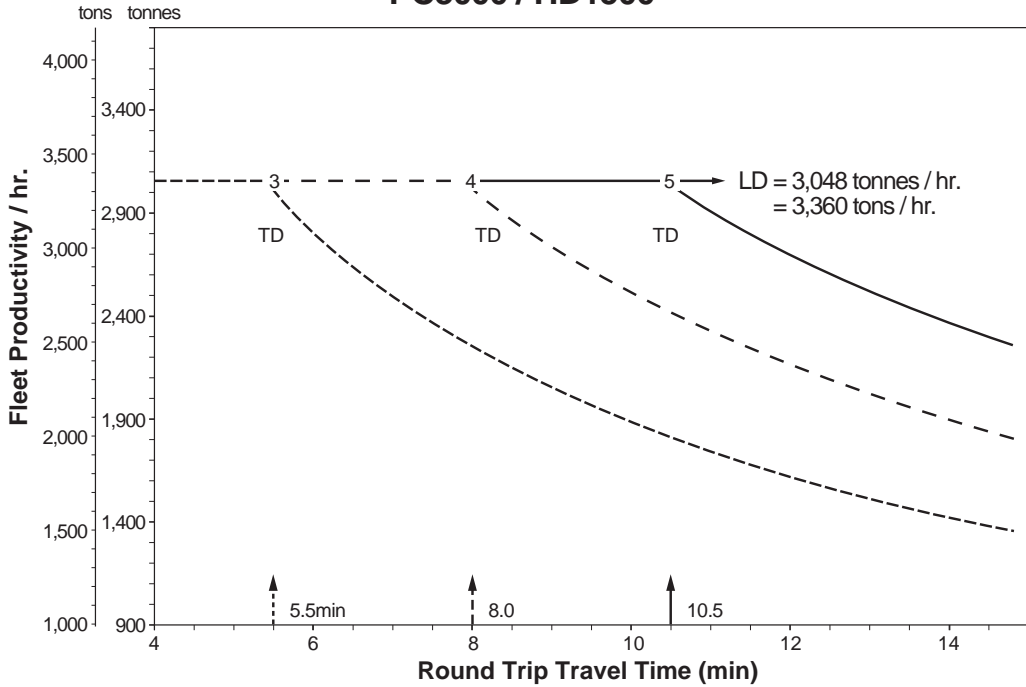

FVBH0503

Parameter:

Loading Tool = PC3000
Hauling Tool = HD1500

Material Density (kg / lcm) = 1,780
Material Swell (%) = 30%
Bucket Size (lcm) = 15
Bucket Fill (%) = 95%
Cycle Time (sec) = 27
No. of Passes = 5
Truck Payload (tonnes) = 127
Truck Spot Time (sec) = 15
Efficiency (min / hr) = 60

tph		FLEET PERFORMANCE		
		3 Trucks	4	5
RTTT (min)	2	3,048	3,048	3,048
	4	3,048	3,048	3,048
	6	2,805	3,048	3,048
	8	2,252	3,003	3,048
	10	1,881	2,509	3,048

Loader Dependent - LD
Truck Dependent - TD

PC4000 / 730E

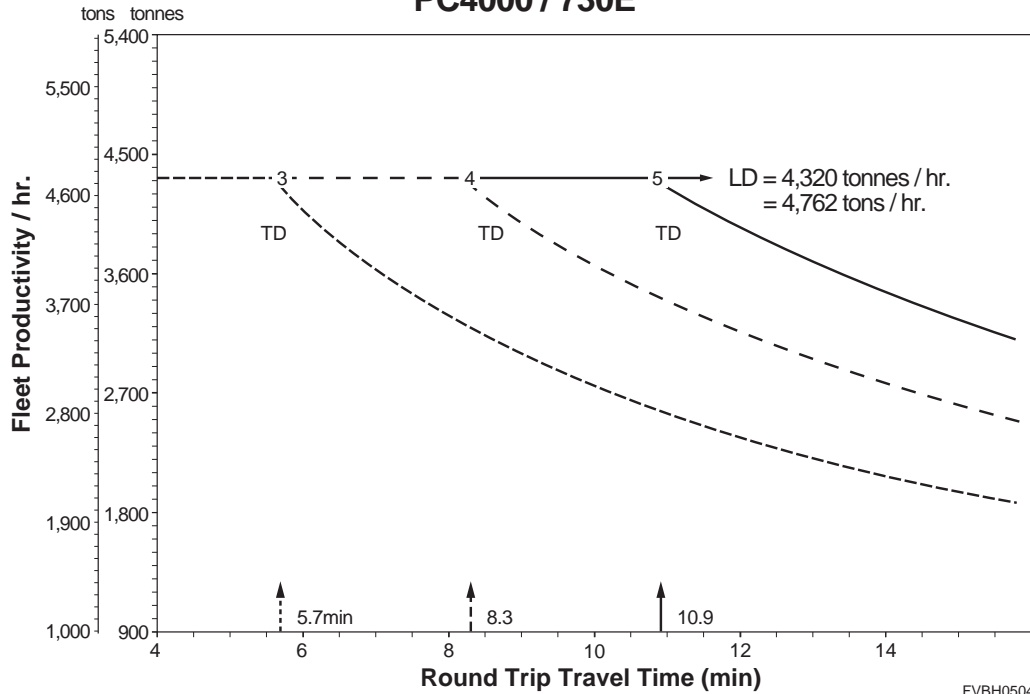

FVBH0504

Parameter:

Loading Tool = PC4000
 Hauling Tool = 730E

Material Density (kg / lcm) = 1,780
 Material Swell (%) = 30%
 Bucket Size (lcm) = 22
 Bucket Fill (%) = 95%
 Cycle Time (sec) = 28
 No. of Passes = 5
 Truck Payload (tonnes) = 186
 Truck Spot Time (sec) = 15
 Efficiency (min / hr) = 60

tph		FLEET PERFORMANCE		
		3 Trucks	4	5
RTTT (min)	2	4,320	4,320	4,320
	4	4,320	4,320	4,320
	6	4,075	4,320	4,320
	8	3,277	4,320	4,320
	10	2,741	3,654	4,320

■ Loader Dependent - LD
 □ Truck Dependent - TD

PC5500 / 830E

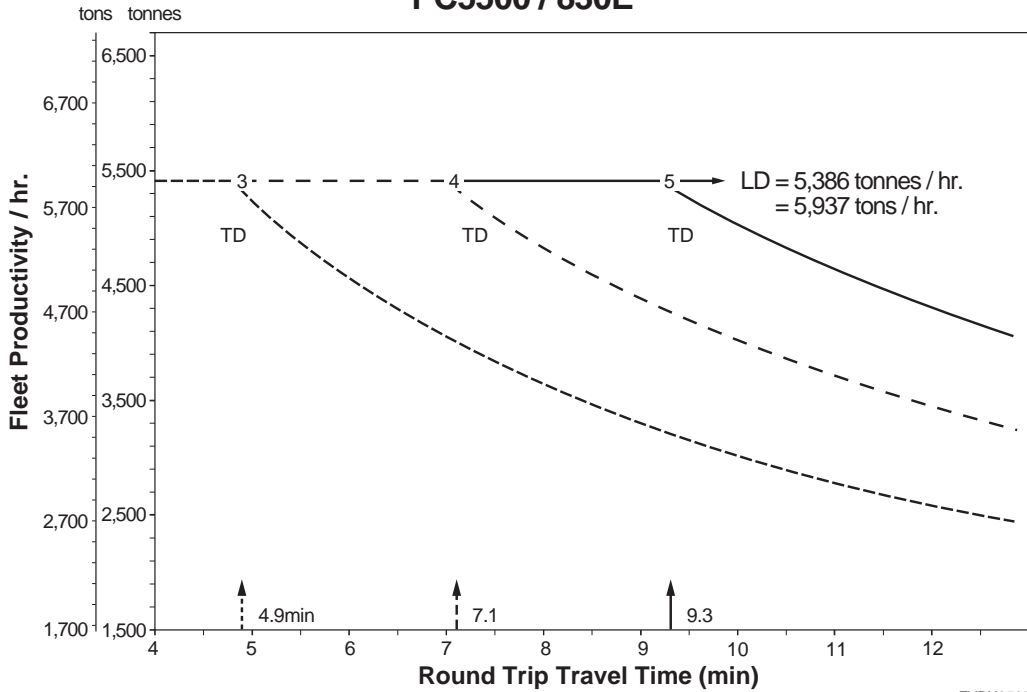

Parameter:

Loading Tool = PC5500
Hauling Tool = 830E

Material Density (kg / lcm) = 1,780
Material Swell (%) = 30%
Bucket Size (lcm) = 29
Bucket Fill (%) = 95%
Cycle Time (sec) = 29
No. of Passes = 4
Truck Payload (tonnes) = 196
Truck Spot Time (sec) = 15
Efficiency (min / hr) = 60

tph		FLEET PERFORMANCE		
		3 Trucks	4	5
RTTT (min)	3	5,386	5,386	5,386
	4	5,386	5,386	5,386
	6	4,523	5,386	5,386
	8	3,600	4,800	5,386
	9	3,267	4,356	5,386

Loader Dependent - LD
Truck Dependent - TD

PC8000 / 930E

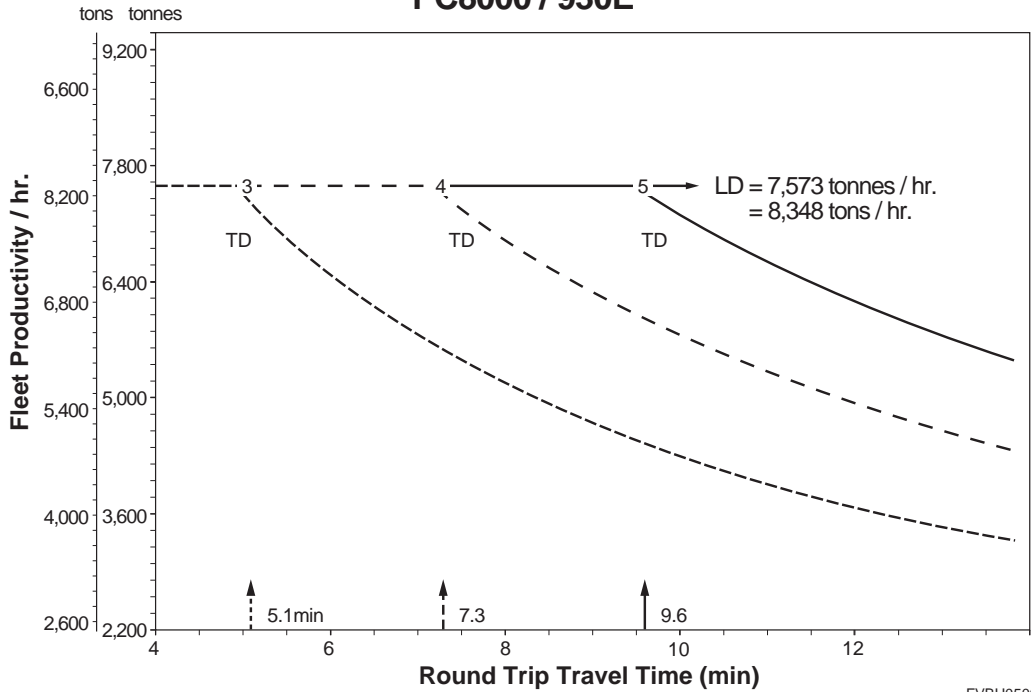

Parameter:

Loading Tool = PC8000
Hauling Tool = 930E

Material Density (kg / lcm) = 1,780
Material Swell (%) = 30%
Bucket Size (lcm) = 42
Bucket Fill (%) = 95%
Cycle Time (sec) = 30
No. of Passes = 4
Truck Payload (tonnes) = 284
Truck Spot Time (sec) = 15
Efficiency (min / hr) = 60

tph		FLEET PERFORMANCE		
		3 Trucks	4	5
RTTT (min)	3	7,573	7,573	7,573
	4	7,573	7,573	7,573
	6	6,512	7,573	7,573
	8	5,190	6,920	7,573
	10	4,314	5,752	7,190

Loader Dependent - LD
Truck Dependent - TD

MEMO

A series of horizontal dashed lines for writing.

CONTENTS

INDEX

SECTION **14**

PRODUCTIVITY Sec 14A
EARTHMOVING DATA Sec 14B

SECTION **14A**

PRODUCTIVITY

CONTENTS

Calculation of Production	14A-2
Bulldozers	14A-4
Dozer Shovels, Wheel Loaders	14A-6
Hydraulic Excavators	14A-9
Dump Trucks	14A-13
Motor Graders	14A-20
Compactors	14A-21

Table 1 Earth volume conversion factor (f)

Nature of earth	Initial	Conditions of earth to be moved		
		Bank condition	Loosened condition	Compacted condition
Sand	(A)	1.00	1.11	0.95
	(B)	0.90	1.00	0.86
	(C)	1.05	1.17	1.00
Sandy clay	(A)	1.00	1.25	0.90
	(B)	0.80	1.00	0.72
	(C)	1.11	1.39	1.00
Clay	(A)	1.00	1.43	0.90
	(B)	0.70	1.00	0.63
	(C)	1.11	1.59	1.00
Gravelly soil	(A)	1.00	1.18	1.08
	(B)	0.85	1.00	0.91
	(C)	0.93	1.09	1.00
Gravel	(A)	1.00	1.13	1.03
	(B)	0.88	1.00	0.91
	(C)	0.97	1.10	1.00
Solid or rugged gravel	(A)	1.00	1.42	1.29
	(B)	0.70	1.00	0.91
	(C)	0.77	1.10	1.00
Broken limestone, sandstone and other soft rocks	(A)	1.00	1.65	1.22
	(B)	0.61	1.00	0.74
	(C)	0.82	1.35	1.00
Broken granite, basalt and other hard rocks	(A)	1.00	1.70	1.31
	(B)	0.59	1.00	0.77
	(C)	0.76	1.30	1.00
Broken rocks	(A)	1.00	1.75	1.40
	(B)	0.57	1.00	0.80
	(C)	0.71	1.24	1.00
Blasted bulky rocks	(A)	1.00	1.80	1.30
	(B)	0.56	1.00	0.72
	(C)	0.77	1.38	1.00

(A) Bank condition (B) Loosened condition (C) Compacted condition

2. Job efficiency (E)

When planning a project, the hourly productivity of the machines needed in the project is the standard productivity under ideal conditions multiplied by a certain factor. This factor is called job efficiency.

Job efficiency depends on many factors such as topography, operator's skill, and proper selection and disposition of machines. Time out of an hour machine use is actually used.

It is very difficult to estimate a value for job efficiency due to the many factors involved. Therefore, efficiency is given in the following section as a rough guide.

BULLDOZERS**(DOZING)**

The hourly production of a bulldozer when excavating or dozing can be obtained by using the following formula:

$$Q = q \times \frac{60}{C_m} \times e \times E$$

where **Q** : Hourly production (m³/hr; yd³/hr) **q** : Production per cycle (m³; yd³)
C_m : Cycle time (in minutes) **e** : Grade factor
E : Job efficiency

1. Production per cycle (q)

For dozing operations, the production per cycle is theoretically calculated as follows:

$$q = q_1 \times a \quad q_1 : \text{Blade capacity (m}^3\text{; yd}^3\text{)} \quad a : \text{Blade fill factor}$$

When calculating the standard productivity of a bulldozer, the figure used for the volume of earth hauled in each cycle, was taken as blade capacity. In fact, production per cycle differs with the type of soil, so the blade fill factor is used to adjust this figure. See Table 2 to select the factor.

Table 2 Blade Fill Factor (a)

Dozing conditions		Blade fill factor (a)
Easy dozing	Full blade of soil can be dozed as completely loosened soil. Low water content, no-compacted sandy soil, general soil, stockpile material.	1.1 ~ 0.9
Average dozing	Soil is loose, but impossible to doze full blade of soil. Soil with gravel, sand, fine crushed rock.	0.9 ~ 0.7
Rather difficult dozing	High water content and sticky clay, sand with cobbles, hard dry clay and natural ground.	0.7 ~ 0.6
Difficult dozing	Blasted rock, or large pieces of rock	0.6 ~ 0.4

2. Cycle time (C_m)

The time needed for a bulldozer to complete one cycle (dozing, reversing and gear shifting) is calculated by the following formula:

$$C_m (\text{min.}) = \frac{D}{F} + \frac{D}{R} + Z$$

where **D** : Haul distance (m; yd) **F** : Forward speed (m/min.; yd./min.)
R : Reverse speed (m/min.; yd./min.) **Z** : Time required for gear shifting (min.)

(1) Forward speed/reverse speed

As a rule a speed range of 3-5 km/h for forward, and 5-7 km/h for reverse should be chosen.

(2) Time required for gear shifting

	Time required for gear shifting
Direct-drive type	0.10 min.
TORQFLOW (Torque converter type)	0.05 min.

3. Grade factor (e)

Production is affected by the grade of the ground when dozing.

The grade factor can be selected in the right hand side graph.

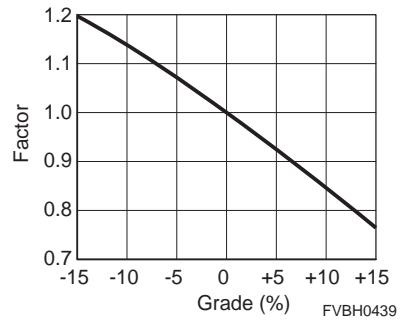

4. Job efficiency (E)

The following table gives typical job efficiency as a rough guide. To obtain the actual production figure, determine the efficiency in accordance with actual operating conditions. Time out of an hour machine use is actually used.

Operating conditions	Job efficiency
Good	0.83
Average	0.75
Rather poor	0.67
Poor	0.58

(RIPPING)

Ripping production varies greatly according to such conditions as the properties of the rock, the method of operation, and the operator's skill. Therefore, it is difficult to estimate. However, from available data, the relationship as shown on the ripper section can be seen between seismic velocity and production.

(RIPPING AND DOZING)

In normal ripping operations, ripping and dozing operations are carried out repeatedly in turn. The combined production for ripping and dozing operations is calculated using the following formula.

$$Q = \frac{QR \times QD}{QR + QD}$$

Where Q = Ripping and dozing production (m³/hr ; yd³/hr)

QR = Ripping production (m³/hr ; yd³/hr)

QD = Dozing production (m³/hr ; yd³/hr)

When making the calculation, it is necessary to use the same unit (natural rock position, loose rock condition, soil condition) for production QR and QD.

DOZER SHOVELS AND WHEEL LOADERS

(LOADING)

Generally, the hourly production can be obtained by using the following formula:

$$Q = q \times \frac{60}{Cm} \times E$$

where **Q** : Hourly production (m³ /hr; yd³ /hr) **q** : Production per cycle (m³; cu.yd³)
Cm : Cycle time (min.) **E** : Job efficiency

1. Production per cycle (q)

$$q = q_1 \times K$$

Where **q₁** : The heaped capacity given in the specifications sheet

K : Bucket fill factor The actual volume in the bucket differs depending on the type of loading material.
 Bucket fill factor is used for that reason.

(1) Bucket fill factor

Table 3 Bucket fill factor

Loading condition	Wheel loader	Dozer shovel
A: Easy loading	1.0 ~ 1.1	1.0 ~ 1.1
B: Average loading	0.85 ~ 0.95	0.95 ~ 1.0
C: Rather difficult loading	0.8 ~ 0.85	0.9 ~ 0.95
D: Difficult loading	0.75 ~ 0.8	0.85 ~ 0.9

Table 4 Loading conditions

Operation conditions		Remarks
Easy loading (A)	Loading from a stockpile or from rock excavated by another excavator, bucket can be filled without any need for digging power. Sand, sandy soil, with good water content conditions.	<ul style="list-style-type: none"> Loading sand or crushed rock products Soil gathering such as loading of soil dozed by a bulldozer.
Average loading (B)	Loading of loose stockpiled soil more difficult to load than category A but possible to load an almost full bucket. Sand, sandy soil, clayey soil, clay, unscreened gravel, compacted gravel, etc. Or digging and loading of soft soil directly in natural ground condition.	Digging and loading of sandy natural ground.
Rather difficult loading (C)	Difficult to load a full bucket. Small crushed rock piled by another machine. Finely crushed rock, hard clay, sand mixed with gravel, sandy soil, clayey soil and clay with poor water content conditions.	Loading of small crushed rock
Difficult loading (D)	Difficult to load bucket, large irregular shaped rocks forming big air pockets. Rocks blasted with explosives, boulders, sand mixed with boulders, sandy soil, clayey soil, clay, etc.	Loading of blasted rock

2. Cycle time (Cm)

The following tables show the standard cycle time according to loading method and operating conditions.

It is possible to shorten a cycle time still more than the standard cycle time by minimizing moving distance.

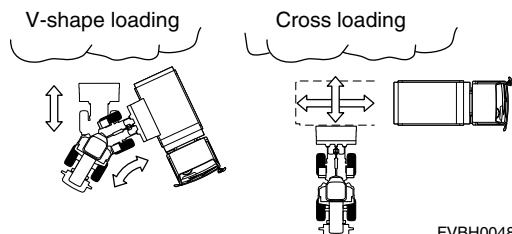

FVBH0048

(1) V-shape loading

Table 5 Average cycle time for wheel loader

Unit: min.

Loading conditions		Bucket size		
		~ 3 m ³	3.1 ~ 5 m ³	5.1 m ³ ~
A	Easy	0.45	0.55	0.65
B	Average	0.55	0.65	0.70
C	Rather difficult	0.70	0.70	0.75
D	Difficult	0.75	0.75	0.80

Table 6 Average cycle time for dozer shovel

Unit: min.

Loading conditions		Bucket size	
		~ 3 m ³	3.1 ~ 5 m ³
A	Easy	0.55	0.60
B	Average	0.60	0.70
C	Rather difficult	0.75	0.75
D	Difficult	0.80	0.80

(2) Cross loading

Table 7 Average cycle time for wheel loader

Unit: min.

Loading conditions		Bucket size		
		~ 3 m ³	3.1 ~ 5 m ³	5.1 m ³ ~
A	Easy	0.40	0.50	0.60
B	Average	0.50	0.60	0.65
C	Rather difficult	0.65	0.65	0.70
D	Difficult	0.70	0.75	0.75

Table 8 Average cycle time for dozer shovel

Unit: min.

Loading conditions		Bucket size	
		~ 3 m ³	3.1 ~ 5 m ³
A	Easy	0.55	0.60
B	Average	0.60	0.70
C	Rather difficult	0.75	0.75
D	Difficult	0.80	0.80

3. Job efficiency (E)

The following table gives typical job efficiency as a rough guide. To obtain the actual production figure, determine the efficiency in accordance with actual operating conditions.

Operating conditions	Job efficiency
Good	0.83
Average	0.80
Rather poor	0.75
Poor	0.70

(LOAD AND CARRY)

$$Q = q \times \frac{60}{Cm} \times E$$

where **Q** : Hourly production (m³/hr; yd³/hr)
Cm : Cycle time (min.)

q : Production per cycle (m³; yd³)
E : Job efficiency

1. Production per cycle (q)

$$q = q_1 \times K$$

where **q₁** : The heaped capacity given in the specifications sheet
K : Bucket fill factor

(1) Bucket fill factor

In a load and carry operation, fully heaped bucket causes soil spillage from bucket during hauling, so partially heaped bucket is recommendable.

Use a bucket fill factor of 0.7 ~ 0.9.

2. Cycle time (Cm)

$$Cm = \frac{D}{\frac{1000VF}{60}} + \frac{D}{\frac{1000VR}{60}} + Z$$

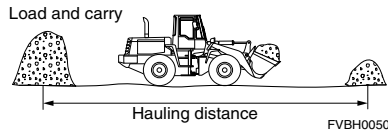

Where **D** : Hauling distance (m, yd)
VR: Return speed (km/hr; MPH)

VF: Travel speed with load (km/hr; MPH)
Z : Fixed time (min)

(1) Travel speed for wheel loader

Operation conditions		Speed km/hr(MPH)	
		Loaded	Empty
Good	Hauling on well compacted flat road, few bumps in road surface, no meeting other machines, can concentrate on L & C.	10 ~ 23 (6.2 ~ 14)	11 ~ 24 (6.8 ~ 15)
Average	Few bumps on road surface, flat road, some auxiliary work carrying large lumps of rock.	10 ~ 18 (6.2 ~ 11)	11 ~ 19 (6.8 ~ 12)
Rather poor	Bumps in road surface, high rate of auxiliary work.	10 ~ 15 (6.2 ~ 9.3)	10 ~ 16 (6.2 ~ 10)
Poor	Large bumps in road, meeting other machines, difficult to carry out smooth work, large amount of auxiliary work.	9 ~ 12 (5.6 ~ 7.5)	9 ~ 14 (5.6 ~ 8.7)

(2) Fixed time (Z)

$$Z = t_1 + t_2 + t_3 + t_2$$

where **Z** : 0.60 ~ 0.75 (min.)
t₂ : Turning time (0.15 min.)

t₁ : Loading time (0.20 ~ 0.35 min.)
t₃ : Dumping time (0.10 min.)

3. Job efficiency (E)

The following table gives typical job efficiency as a rough guide. To obtain the actual production figure, determine the efficiency in accordance with actual operating conditions.

Operating conditions	Job efficiency
Good	0.83
Average	0.80
Rather poor	0.75
Poor	0.70

HYDRAULIC

(CONSTRUCTION APPLICATION)

$$Q = q \times \frac{3600}{C_m} \times E$$

where **Q** : Hourly production (m³ /hr; yd³ /hr) **q** : Production per cycle (m³; yd³)
C_m : Cycle time (sec.) **E** : Job efficiency

1. Production per cycle (q)

$$q = q_1 \times K$$

where **q₁** : Bucket capacity (heaped) (m³; yd³) **K** : Bucket fill factor

(1) Bucket fill factor

The bucket fill factor varies according to the nature of material.

A suitable factor can be selected from the table, taking into consideration the applicable excavating conditions.

Table 9 Bucket fill factor (Backhoe)

~ PC2000	Excavating Conditions	Bucket fill factor
Easy	Excavating natural ground of clayey soil, clay, or soft soil	1.1 ~ 1.2
Average	Excavating natural ground of soil such as sandy soil and dry soil	1.0 ~ 1.1
Rather difficult	Excavating natural ground of sandy soil with gravel	0.8 ~ 0.9
Difficult	Loading blasted rock	0.7 ~ 0.8

Table 10 Bucket fill factor (Loading shovel)

~ PC2000	Excavating Conditions	Bucket fill factor
Easy	Loading clayey soil, clay, or soft soil	1.0 ~ 1.1
Average	Loading loose soil with small diameter gravel	0.95 ~ 1.0
Rather difficult	Loading well blasted rock	0.90 ~ 0.95
Difficult	Loading poorly blasted rock	0.85 ~ 0.90

2. Cycle time (Cm)

Cycle time = Excavating time + swing time (loaded) + dumping time + swing time (empty)

However, here we use **cycle time = (standard cycle time) × (conversion factor)**

The standard cycle time for each machine is determined from the following table.

Table 11 Standard cycle time for backhoe

Unit: sec

Model	Range	Swing angle		Model	Range	Swing angle	
		45° ~ 90°	90° ~ 180°			45° ~ 90°	90° ~ 180°
PC78		10 ~ 13	13 ~ 16	PC270, PC290		15 ~ 18	18 ~ 21
PW148		11 ~ 14	14 ~ 17	PC300, PC350		15 ~ 18	18 ~ 21
PC130, PC138US		11 ~ 14	14 ~ 17	PC400, PC450		16 ~ 19	19 ~ 22
PC160		13 ~ 16	16 ~ 19	PC600, PC700		17 ~ 20	20 ~ 23
PW160, PW180		13 ~ 16	16 ~ 19	PC750, PC800, PC850		18 ~ 21	21 ~ 24
PC190		13 ~ 16	16 ~ 19	PC1250		22 ~ 25	25 ~ 28
PC200, PC210, PC228US		13 ~ 16	16 ~ 19	PC2000		24 ~ 27	27 ~ 30
PW200, 220		14 ~ 17	17 ~ 20				
PC220, PC230, PC240		14 ~ 17	17 ~ 20				

Table 12 Standard cycle time for loading shovel

Model	sec
PC400	16 ~ 20
PC600, PC750, PC800	18 ~ 22
PC1250	20 ~ 24
PC2000	27 ~ 31

Table 13 Conversion factor for excavator

Digging condition $\left(\frac{\text{Digging depth}}{\text{Specified max. digging depth}} \right)$	Dumping condition			
	Easy (Dump onto spoil pile)	Normal (Large dump target)	Rather difficult (Small dump target)	Difficult (Small dump target requiring maximum dumping reach)
Below 40%	0.7	0.9	1.1	1.4
40 ~ 75%	0.8	1	1.3	1.6
Over 75%	0.9	1.1	1.5	1.8

3. Job efficiency (E)

The following table gives typical job efficiency as a rough guide. To obtain the actual production figure, determine the efficiency in accordance with actual operating conditions.

Operating conditions	Job efficiency
Good	0.83
Average	0.75
Rather poor	0.67
Poor	0.58

(MINING APPLICATION)

The production for Mining Shovels should be calculated on loaded trucks per hour

Hourly production = loaded truck per hour x truck capacity x time utilisation

$$Qh = Tn \times Tq \times E$$

Theoretical loaded trucks per hour = $3600 \text{ sec} / (\text{Loading time per truck} + \text{spotting time per truck})$

$$Tn = 3600 / (tT + tsp)$$

Loading time per truck = (truck size/bucket capacity) rounded x cycle time

$$tT = (Tq / (Bc \times K \times \text{loose density})) \text{ rounded} \times tc$$

Gh = hourly production (ton/hr; US ton/hr)

Tn = number of loaded trucks per hour

Tq = truck capacity (ton; US ton)

E = time utilisation per hour (%)

tT = truck loading time (sec)

tsp = truck spotting time (sec)

Bc = bucket capacity (m³; cu.yd)

K = bucket fill factor (%)

tc = cycle time (sec)

Yearly production = (hours per year - service hours) x availability x mine efficiency

$$QY = Qh \times (hy - hs) \times Sa \times M$$

QY = yearly production

hy = theoretical hours per year (hr)

hs = service hour per year (hr)

Sa = mining shovel availability (%)

M = mine efficiency (%)

1. Cycle time (tc)

The following tables give a rough guide line for estimating a production.

Attention:

- 1) Cycle times are average figures and for diggable material only
- 2) With skilled operator only
- 3) Every 10 degrees more swing will increase the cycle time by 1 second
- 4) Cycle times for standard attachments only
- 5) Following cycle times are without commitment, due to different job side conditions

(1) Backhoe

Model	Digging conditions			Backhoe application
	Easy	Average	Severe	
PC3000	23 ~ 25	26 ~ 28	29 ~ 31	<ul style="list-style-type: none"> • Truck on lower level • Average swing 45°
PC4000	23 ~ 26	27 ~ 29	30 ~ 32	
PC5500	24 ~ 27	28 ~ 30	31 ~ 33	
PC8000	25 ~ 28	29 ~ 31	32 ~ 34	

Model	Digging conditions			Backhoe application
	Easy	Average	Severe	
PC3000	32 ~ 35	36 ~ 38	39 ~ 41	<ul style="list-style-type: none"> • Truck on upper level • Average swing 120° • Optimized working depth 4-5 m (13'1"-16'5")
PC4000	33 ~ 36	37 ~ 39	40 ~ 42	
PC5500	34 ~ 37	38 ~ 40	41 ~ 43	
PC8000	35 ~ 38	39 ~ 41	42 ~ 44	

Model	Digging conditions			Backhoe application
	Easy	Average	Severe	
PC3000	26 ~ 29	30 ~ 32	33 ~ 35	<ul style="list-style-type: none"> • Split bench application • Average swing 90°-120°
PC4000	27 ~ 30	31 ~ 33	34 ~ 36	
PC5500	28 ~ 31	32 ~ 34	35 ~ 37	
PC8000	29 ~ 32	33 ~ 35	36 ~ 38	

(2) Front shovel

Model	Digging conditions			Front shovel application
	Easy	Average	Severe	
PC3000	24 ~ 26	27 ~ 29	30 ~ 32	<ul style="list-style-type: none"> • Truck on same level • Average swing 60°
PC4000	24 ~ 27	28 ~ 30	31 ~ 33	
PC5500	25 ~ 28	29 ~ 31	32 ~ 34	
PC8000	26 ~ 29	30 ~ 32	33 ~ 35	

2. Time utilisation per hour (E)

The following table gives typical time utilisation as a rough guide. To obtain the actual production figure, determine the value in accordance with actual operating conditions.

Operating conditions	Time utilisation
Good	0.83
Average	0.75
Rather poor	0.67
Poor	0.58

3. Bucket fill factor (K)

The bucket fill factor varies according to the nature of material.

A suitable factor can be selected from the table, taking into consideration the applicable excavating conditions.

Bucket fill factor (Backhoe)

PC2000 ~ PC8000	Excavating Conditions	Bucket fill factor
Easy	Excavating natural ground of clayey soil, clay, or soft soil	1.0
Average	Excavating natural ground of soil such as sandy soil and dry soil	0.95
Severe	Excavating natural ground of sandy soil with gravel Loading blasted rock	0.9

Bucket fill factor (Front shovel)

PC2000 ~ PC8000	Excavating Conditions	Bucket fill factor
Easy	Loading clayey soil, clay, or soft soil	1.0
Average	Loading loose soil with small diameter gravel	0.95
Severe	Loading well blasted rock Loading poorly blasted rock	0.9

DUMP TRUCKS

When carrying out operations using a suitable number of dump trucks of suitable capacity to match the loader, the operating efficiency is calculated in the following order:

1. Estimating the cycle time

The cycle time of a dump truck consists of the following factors.

- (1) Time required for loader to fill dump truck
- (2) Hauling time
- (3) Time required for unloading (dumping) plus time expended for standby until unloading is started.
- (4) Time required for returning
- (5) Time required for dump truck to be positioned for loading and for the loader to start loading

Accordingly, the cycle time = (1) + (2) + (3) + (4) + (5)

The cycle time is calculated as follows:

Cycle time of dump truck (Cmt)

$$Cmt = n \times Cms + \frac{D}{V_1} + t_1 + \frac{D}{V_2} + t_2$$

(1) (2) (3) (4) (5)

- (1) : Loading time
- (2) : Hauling time
- (3) : Dumping time
- (4) : Returning time
- (5) : Spot and delay time

Where, n: Number of cycles required for loader to fill dump truck

$$n = C_1 / (q_1 \times K)$$

C₁ : Rated capacity of dump truck (m³, yd³)

q₁ : Bucket capacity of loader (m³, yd³)

K : Bucket fill factor of loader

Cms: Cycle time of loader (min)

D: Hauling distance of dump truck (m, yd)

V₁: Average speed of loaded truck (m/min, yd/min)

V₂: Average speed of empty truck (m/min, yd/min)

t₁: Time required for dumping + time required for standby until dumping is started (min)

t₂: Time required for truck to be positioned and for loader to start loading (min)

1) Loading time

The time required for a loader to load a dump truck is obtained by the following calculation.

Loading time = Cycle time (Cms) × No. of cycles to fill dump truck (n)

a) Cycle time of loader (Cms)

The cycle time of a loader is dependent on the type of loader (excavator, crawler type loader, wheel loader, etc.)

For the cycle time of loaders, refer to the section pertaining to the estimation of the production of loaders.

b) Number of cycles required for loader to fill dump truck full (n)

The payload of a dump truck depends on its capacity or weight.

Where the payload is determined by the capacity, $n = \frac{\text{Rated capacity (m}^3, \text{yd}^3\text{) of dump truck}}{\text{Bucket capacity (m}^3, \text{yd}^3\text{)} \times \text{bucket fill factor}}$

Where the payload is determined by the weight, $n = \frac{\text{Rated capacity (m}^3, \text{yd}^3\text{) of dump truck}}{\text{Bucket capacity (m}^3, \text{yd}^3\text{)} \times \text{bucket fill factor} \times \text{specific weight}}$

- * The bucket capacity and the body capacity, as a general rule, refer to heaped capacity but may be used to refer to struck capacity depending on the nature of materials to be handled.
- * The bucket fill factor is determined by the nature of soil to be excavated or loaded. In case of dozer shovels or wheel loaders, a suitable factor can be selected from among those given in Table 3, 9, 10 according to the applicable loading condition.

2) Material hauling time and returning time

The time taken to haul a load and return empty, can be calculated by dividing the haul road into sections according to the rolling resistance and grade resistance, as follows.

a) Rolling resistance and grade resistance

As described above, the haul road is divided into several sections according to the rolling resistance and grade resistance. All of these rolling resistance and grade resistance values are summed up, resulting in the totals for each resistance.

The rolling resistance for the haul road conditions can be selected by referring to Table 14. The grade resistance can be obtained by averaging the gradients in all sections, which is converted (from degrees to percent). Table 15 indicates the grade resistance values (%) converted from the angles of gradients.

Table 14 Rolling resistance

Haul road conditions	Rolling resistance
Well-maintained road, surface is flat and firm, properly wetted, and does not sink under weight of vehicle	2%
Same road conditions as above, but surface sinks slightly under weight of vehicle	3.5%
Poorly maintained, not wetted, sinks under weight of vehicle	5.0%
Badly maintained, road base not compacted or stabilized, forms ruts easily	8.0%
Loose sand or gravel road	10.0%
Not maintained at all, soft, muddy, deeply rutted	15 to 20%

Table 15 Grade resistance (%) converted from angle (°) of gradient

Angle	% (sin α)	Angle	% (sin α)	Angle	% (sin α)
1	1.8	11	19.0	21	35.8
2	3.5	12	20.8	22	37.5
3	5.2	13	22.5	23	39.1
4	7.0	14	24.2	24	40.2
5	8.7	15	25.9	25	42.3
6	10.5	16	27.6	26	43.8
7	12.2	17	29.2	27	45.4
8	13.9	18	30.9	28	47.0
9	15.6	19	32.6	29	48.5

b) Selection of the travel speed

The speed range suited to the resistance, and the maximum speed, can be obtained by using the Travel Performance Curve appears in the spec sheet.

To use, first draw a vertical line according to the vehicle's weight (A) and mark the point (B) corresponding to total resistance (the sum of rolling resistance and grade resistance).

Next, draw a horizontal line from (B), then mark (C) where the line intersects the rimpull curve and read (E) for the rimpull. For travel speed (D), draw a vertical line downward from (C). For instance, when traveling a 8% gradient and encountering a 5 % rolling resistance, a vehicle with a maximum payload should have a rimpull of 8 tons (8.8 ton) and travel at a speed of 15.0 km/h (9.3 MPH) in forward 2nd gear.

Fig. 1 KOMATSU HD325 Dump Truck Travel Performance Curve

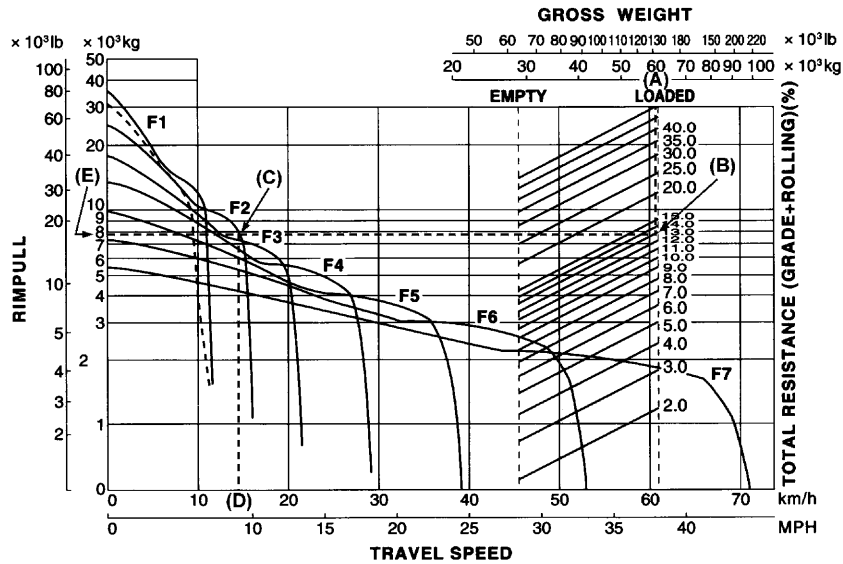

The maximum speed thus obtained is a theoretical value, and in order to convert this maximum speed to a practicable average speed, the speed should be multiplied by a speed factor. An applicable speed factor can be selected from the following table.

How to select a speed factor

If a truck is to start off downhill, gear shifting to a desired speed can be accomplished in a short time. In such a case, a rather higher value should be used in each range of factors. On the other hand, if a truck is to start off on a level road or uphill, it will take a comparatively long time for gear-shifting to a desired speed to be accomplished and thus, the lower factor value should be selected in an applicable range of factors.

Table 16 Speed factors

Distance of each section of haul road, m	When making a standing start	When running into each section
0 - 100	0.25 - 0.50	0.50 - 0.70
100 - 250	0.35 - 0.60	0.60 - 0.75
250 - 500	0.50 - 0.65	0.70 - 0.80
500 - 750	0.60 - 0.70	0.75 - 0.80
750 - 1000	0.65 - 0.75	0.80 - 0.85
1000 -	0.70 - 0.85	0.80 - 0.90

Thus, the average speed can be obtained in the following manner:

The average speed =
Maximum vehicle speed obtained from the travel performance curve × (Speed factor)

The above average speed is applicable in ordinary driving conditions. If there is any factor retarding the vehicle speed, an applicable factor should be used.

The following can be cited as factors retarding a vehicle speed.

- Vehicles passing each other on a narrow road
- Sharp curve or many curves in the road
- Points giving poor visibility
- Narrow bridges or at railway crossings, intersections of roads
- Extreme differences in rolling resistance
- Pot-holes on the road
- Un-experienced or unskilled operators

These factors should be eliminated wherever possible.

c) Hauling time

If the hauling distance in each section is divided by the average speed given in the preceding paragraph, the hauling time in each section will be obtained. If all of these times (for hauling and returning) are added together, they will give the total hauling and returning time.

Hauling time and returning time in each section

$$= \frac{\text{Length of section (m)}}{\text{Average speed (m/min.)}}$$

d) Vehicle speed limitation for a downhill run

Calculation of a vehicle speed as described in Paragraphs a) to c) is effected with the total resistance in 0 or in a plus value. If the total resistance is a minus value, the vehicle speed will ordinarily be limited by the retarder function with a given distance.

In the case of the HD325 dump truck, the maximum speed at which the truck can safely go down a hill can be obtained in the brake performance curve in Fig. 2. (Grade distance continuous).

For example, assume the total resistance is -14% (gradient resistance is -16% plus rolling resistance +2%) on the "continuous grade" graph. First, draw a vertical line from the total vehicle weight(A) so that it crosses the slanted line of 14% total resistance(B). From(B), draw a horizontal line to the left and it will cross the stair curve at (C).

Finally, draw a vertical line from(C) and read(D) the maximum speed for driving safely down the slope. In this case, a vehicle with a 32-ton payload should travel at approximately 30 km/h (18.6 MPH) in forward 4th gear.

Fig. 2 HD325 Brake Performance (Grade distance continuous)

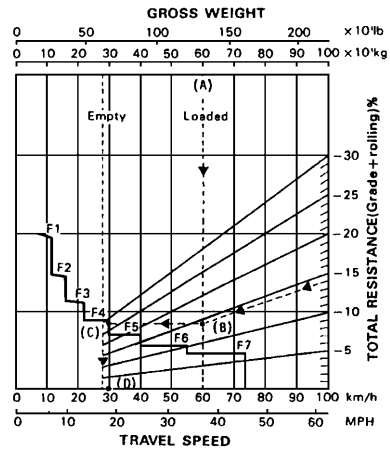

3) Dumping time

This is the period from the time when the dump truck enters the dumping area, to the time when the dump truck starts its return journey after completing the dumping operation. The length of the dumping time depends on the operating conditions, but average dumping times for favorable average and unfavorable conditions are given by the following table.

However, particularly adverse conditions giving rise to extremely long dumping times are excluded.

Operating conditions	t ₁ , min.
Favorable	0.5 to 0.7
Average	1.0 to 1.3
Unfavorable	1.5 to 2.0

4) Time required for the truck to be positioned and for the loader to begin loading.

The time taken for the truck to be positioned and for the loader to begin loading also depends on the operating conditions. As a general rule, a suitable time can be selected from the table at right.

Operating conditions	t ₂ , (min.)
Favorable	0.1 to 0.2
Average	0.25 to 0.35
Unfavorable	0.4 to 0.5

As has so far been described, the cycle time of a dump truck can be estimated by using the values for factors obtained according to paragraph 1) to 4).

2. Estimating the number of dump trucks required (M)

The quantity of dump trucks required for use in combination with a loader working at its maximum operating efficiency can be estimated by the following formula:

$$M = \frac{\text{Cycle time of a dump truck}}{\text{Loading time}} = \frac{Cmt}{n \times Cms}$$

Where, n : Number of cycles required for a loader to fill a dump truck
 Cms : Cycle time of loader (min)
 Cmt : Cycle time of dump truck (min)

3. Estimating the productivity of dump trucks

The total hourly production P of several dump trucks where they are doing the same job simultaneously is estimated by the following formula:

$$P = C \times \frac{60}{Cmt} \times E_t \times M$$

Where, P : Hourly production (m³/h;yd³/hr)
 E_t : Job efficiency of dump truck
 M : Q'ty of dump trucks in operation
 C : Production per cycle C = n × q₁ × K
 Where, n : Number of cycles required for loader to fill dump truck
 q₁ : Bucket capacity of loader (m³, yd³)
 K : Bucket fill factor of loader
 Cmt : Cycle time of dump truck

Table 16 gives typical job efficiency as a rough guide.

To obtain the actual production figure, determine the efficiency in accordance with actual operating conditions.

Table 16 Job efficiency of dump truck (E_t)

Operating conditions	Job efficiency
Good	0.83
Average	0.80
Rather poor	0.75
Poor	0.70

4. Combined use of dump trucks and loaders

When dump trucks and loaders are used in combination, it is most desirable that the operating capacity of the dump trucks be equal to that to the loaders. That is, conditions satisfying the following equation are most desirable. Consequently, if the value of the left equation is larger, the group of dump trucks has a surplus capacity. On the other hand, if the value of the right equation is larger, the group of loaders has a surplus capacity.

$$C \times \frac{60}{Cmt} \times E_t \times M \geq q_1 \times K \times \frac{60}{Cms} \times E_s$$

Where, Cms : Cycle time of a loader (min) E_s : Job efficiency of loader
 q₁ : Bucket capacity (heaped (m³; yd³)) K : Bucket fill factor

The left equation has already been described. The right equation has the following meaning.

EXAMPLE

• A HD325, working in combination with a WA600, is hauling excavated material to a spoil-bank 500 meters away.
What is the hauling capacity of the HD325?

Working conditions for dump truck:

Haul distance: flat road: 450 m
 slope: 50 m
 gradient of slope: 10%

Speed limits:
 For safety purposes, the following maximum speeds should not be exceeded.

Haul road condition:
 Road with sunken surface, not wetted, poorly maintained.

Type of soil:
 Sandy clay (loose density 1.6 tons/ m³)

Job efficiency:
 0.83 (good operating conditions)

		Speed
Flat	Loaded	40 km/h
	Unloaded	60 km/h
Uphill	Loaded	20 km/h
	Unloaded	40 km/h
Downhill	Loaded	20 km/h
	Unloaded	40 km/h

Wheel Loader: Bucket capacity : 5.4m³ (7.1cu.yd)
 Cycle time : 0.65 min
 Bucket fill factor : 0.9
 Job efficiency : 0.83

Answer

(a) Cycle time (Cmt)

(i) Loading time

Cycle time of loader Cms = 0.65 min
 Number of cycles required for loader to fill dump truck

$$n = \frac{\text{Rated capacity of dump truck}}{\text{Bucket capacity} \times \text{bucket fill factor} \times \text{loose density}} = \frac{32 \text{ tons (max. payload)}}{5.4 \text{ m}^3 \times 0.9 \times 1.6} = 4.12$$

n is taken to be 4.

Loading time = n × Cms = 4 × 0.65 = 2.60 min.

(ii) Hauling time and returning time

The hauling distance is divided up and the time taken to cover each section should be calculated.

Hauling:	1 Flat	330 m	Returning:	4 Flat	120 m
	2 Uphill	50 m		5 Downhill	50 m
	3 Flat	120 m		6 Flat	330 m

Net weight of dump truck (unloaded): 27,200 kg (figure in specifications)

Loaded weight :

$$\begin{aligned} \text{Weight when loaded} &= n \times \text{bucket capacity} \times \text{bucket fill factor} \times \text{loose specific gravity} \times 1,000 \\ &= 4 \times 5.4 \text{ m}^3 \times 0.9 \times 1.6 \times 1,000 = 31,104 \text{ kg} \end{aligned}$$

Weight of loaded dump truck= 27,200 kg + 31,104 kg = 58,304 kg

Using the Travel Performance Curve and Brake Performance Curve, the maximum speed for each section can be calculated.

The values for HD325 can be calculated from PERFORMANCE CURVE on the section 7A.

The result is shown in the table below and the table of Hauling time and Returning time is 3.00 min.

Calculation of Hauling time and Returning time

		Dis- tance	Grade Resis- tance	Rolling Resis- tance	Total Resis- tance	Speed Range	Max. Travel Speed	Speed Factor	Ave. Speed	Time Taken
Hauling (Loaded)	Flat	330	0	5%	5%	F5	36 km/h (600 m/min)	0.50	300.0 m/min	1.10 min
	Uphill	50	10 %	5%	15%	F2	11 km/h (183 m/min)	0.60	109.8 m/min	0.46
	Flat	120	0	5%	5%	F5	36 km/h (600 m/min)	0.60	300.0 m/min	0.40
Returning (Unloaded)	Flat	120	0	5%	5%	F6	53 km/h (883 m/min)	0.35	309.1 m/min	0.39
	Down- hill	50	-10 %	5%	-5%	F6	*40 km/h (667 m/min)	0.70	466.9 m/min	0.11
	Flat	330	0	5%	5%	F6	53 km/h (883 m/min)	0.70	618.1 m/min	0.54
Total										3.00 min

*: In the Brake Performance Curve (Fig. 2), the figure for total resistance is given as -5%. This means that when driving unloaded and using the speed range F6 as shown in the diagram, it is enough to press the accelerator pedal and keep within the speed limit.

(iii) Dumping time and standby time

$$t_1 = 1.15 \text{ min. (average)}$$

(iv) Time required for the dump truck to be positioned for loading, and for the loader to start loading

$$t_2 = 0.3 \text{ min. (average)}$$

(v) Cycle time

$$C_{mt} = 2.60 + 3.00 + 1.15 + 0.3 = 7.05 \text{ min.}$$

(b) Estimating the production of dump truck

$$P = C \times \frac{60}{C_{mt}} \times E_t = 19.44 \times \frac{60}{7.05} \times 0.83 = 137.3 \text{ m}^3/\text{h}$$

$$C = n \times \text{bucket capacity} \times \text{bucket fill factor} = 4 \times 5.4 \times 0.9 = 19.44 \text{ m}^3$$

MOTOR GRADERS

The motor grader is used for many purposes such as maintaining roads, final finishing for earthmoving projects, trenching and bank cutting.

Therefore there are many methods of expressing its operating capacity.

1. Calculating the hourly operating area (m²/h)

$$Q_A = V \times (L_e - L_o) \times 1000 \times E$$

Where **Q_A** : Hourly operating area (m²/hr) **V** : Working speed (km/hr)
L_e : Effective blade length (m) **L_o** : Width of overlap (m)
E : Job efficiency

NOTE: Graders usually operate on long stretches, so the time required for gear shifting or turning can be ignored.

1) Working speed (V)

- Road repair : 2 to 6 km/h
- Bank finishing: 1.6 to 2.6km/h
- Field grading : 1.6 to 4 km/h
- Trenching : 1.6 to 4 km/h
- Snow-removal: 7 to 25 km/h
- Leveling : 2 to 8 km/h

2) Effective blade length (L_e), width of overlap (L_o)

Since the blade is normally angled when cutting or grading the surface, the effective blade length depends on the angle.

The width of overlap is usually 0.3 m. Following table gives the values to be used when applying the formula.

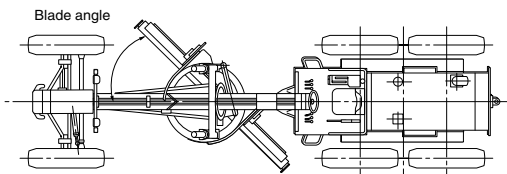

Blade length (m)	Effective blade length (m)	
	Blade angle 60°	Blade angle 45°
2.2	1.9	1.6
2.5	2.2	1.8
2.8	2.4	2.0
3.05	2.6	2.2
3.1	2.7	2.2
3.4	2.9	2.4
3.7	3.2	2.6
4.0	3.5	2.8
4.3	3.7	3.0
4.9	4.2	3.5

3) Job efficiency (E)

The following table gives typical job efficiency as a rough guide. To obtain the actual production figure, determine the efficiency in accordance with actual operating conditions.

Operating conditions	Job efficiency
Road repair, leveling	0.8
Snow-removal (V-type plow)	0.7
Spreading, grading	0.6
Trenching, snow-removal	0.5

2. When calculating the time required to finish a specific area.

$$T = \frac{N \times D}{V \times E}$$

Where **T** = Working time (h) **N** = Number of trips
D = Working distance (km) **V** = Working speed (km/hr)
E = Job efficiency

Number of trips (N)

When a grader is operating in a job site, and leveling parallel strips, the number of trips can be calculated by using the following formula:

$$N = \frac{W}{Le - Lo} \times n$$

Where W : Total width to be leveled (m)

Le : Effective blade length (m)

Lo : Width of overlap (m)

n : Number of grading required to finish the surface to the required flatness.

SOIL COMPACTORS

There are two ways of expressing the productivity of compactors: by the volume of soil compacted, and by the area compacted.

1. Expressing productivity by the volume of soil compacted.

When calculating the productivity by the volume of soil compacted, the following formula is used.

$$Q = \frac{W \times V \times H \times 1000 \times E}{N}$$

Where

Q = Hourly production (m³/hr)(volume of soil compacted)

V = Operating speed (km/hr)

W = Effective compaction width per pass (m)

H = Compacted thickness for one layer (m)

N = Number of compaction (number of passes by compactor)

E = Job efficiency

1) Operating speed (V)

As a general rule the following values are used.

Road roller	about 2.0 km/hr
Tire roller	about 2.5 km/hr
Vibration roller	about 1.5 km/hr
Soil compactor	4 - 10 km/hr
Tamper	about 1.0 km/hr

2) Effective compaction width (W)

Type of Equipment	W
Macadam roller	Driving wheel width - 0.2 m
Tandem roller	Driving wheel width - 0.2 m
Soil compactor	(Driving wheel width × 2) - 0.2 m
Tire roller	Outside-to-outside distance of most outside tires - 0.3 m
Large vibratory roller	Roller width - 0.2 m
Small vibratory roller	Roller width - 0.1 m
Bulldozer	(Width of track shoe × 2) - 0.3 m

3) Compacted thickness for one layer (H)

Compacted thickness is determined from compaction specifications or from the results of tests, but as a general rule, it is 0.2 ~ 0.5 m in loosened soil.

Number of trips (N)

When a grader is operating in a job site, and leveling parallel strips, the number of trips can be calculated by using the following formula:

$$N = \frac{W}{Le - Lo} \times n$$

Where W : Total width to be leveled (m) Le : Effective blade length (m)
Lo : Width of overlap (m)
n : Number of grading required to finish the surface to the required flatness.

SECTION **14B**

EARTHMOVING DATA

CONTENTS

Soil Classification	14B-2
Hauling Performance of Construction Machines:	
Introduction	14B-4
Inherent Machine Capability	14B-4
Elements Limiting the Inherent Machine Capability	14B-5
Machine Capabilities Required for Earthmoving Operations	14B-7
Summary and Application	14B-9
Trafficability	14B-11
Machines and Site Planning	14B-12

SOIL CLASSIFICATION FOR EARTH-MOVING OPERATIONS

Various classifications have been established properly for soil depending on the purposes of earth-moving operations. Generally speaking, however, detailed classifications of soil are not required for the ordinary earth-moving operations.

Rather, attention is required to be given to whether the soil to be handled is of special ores or contains special clay minerals.

Hereinafter is described the knowledge necessary for earth work planning prior to such operations as digging, loading, hauling, pushing (spreading), rolling compaction, etc., on ordinary terrain.

- * Data (figures) to be given hereinafter vary largely depending on various operating and environmental conditions. Consequently, before starting the earth work, tests should be conducted to obtain correct data for operations.

Some knowledge of the weight data per unit volume of materials of their major ingredients is important for their handling or hauling in mines, etc.. The specific weight data of some major types of soil and ingredients are given below.

WEIGHT DATA OF MATERIALS

Material		Specific Gravity (ton/m ³)	
		Bank	Crushed (Loose)
Basalt		2.95	1.7
Bauxite		1.9	1.42
Caliche		2.26	1.25
Carnotite, uranium ore		2.2	1.63
Cinders		0.86	0.56
Clay		1.8	1.45
Clay & gravel		2.0	1.45
Coal	Anthracite	1.3	1.0
	Bituminous	0.59 ~ 0.89	0.53 ~ 0.65
Decomposed Rock - 75% Rock, 25% Earth 50% Rock, 50% Earth 25% Rock, 75% Earth		2.0	1.75
		2.1	1.75
		2.2	1.65
Earth - Dry Wet Loam		1.8	1.4
		2.0	1.6
		1.54	1.25
Granite		2.8	1.6
Gravel		2.17	1.93
Gypsum		3.17	1.81
Hematite, iron ore		3.5	2.0
Limestone		2.8	1.6
Magnetite, iron ore		5.05	2.9
Peat	Dry	0.60 ~ 0.70	0.40 ~ 0.50
	Wet	1.80 ~ 2.00	1.10 ~ 1.20
Pyrite, iron ore		3.03	2.85
Sand - Dry Dump Wet		1.6	1.42
		1.9	1.69
		2.08	1.84
Sand & clay	Loose	2.02	1.6
	Compacted	—	2.4
Sand & gravel	Dry	1.93	1.72
	Wet	2.23	2.02
Sandstone		2.7	1.55
Slag		2.94	1.75
Snow	Dry	—	0.13
	Wet	—	0.52
Stone		2.67	1.6
Taconite		2.36 ~ 2.7	1.63 ~ 1.9
Top soil		1.37	0.95
Trap rock		2.50 ~ 2.70	1.60 ~ 1.80

ROCK TYPES AND COMPRESSION STRENGTHS

○ No cracks □ Some cracks
△ Few cracks × Many cracks

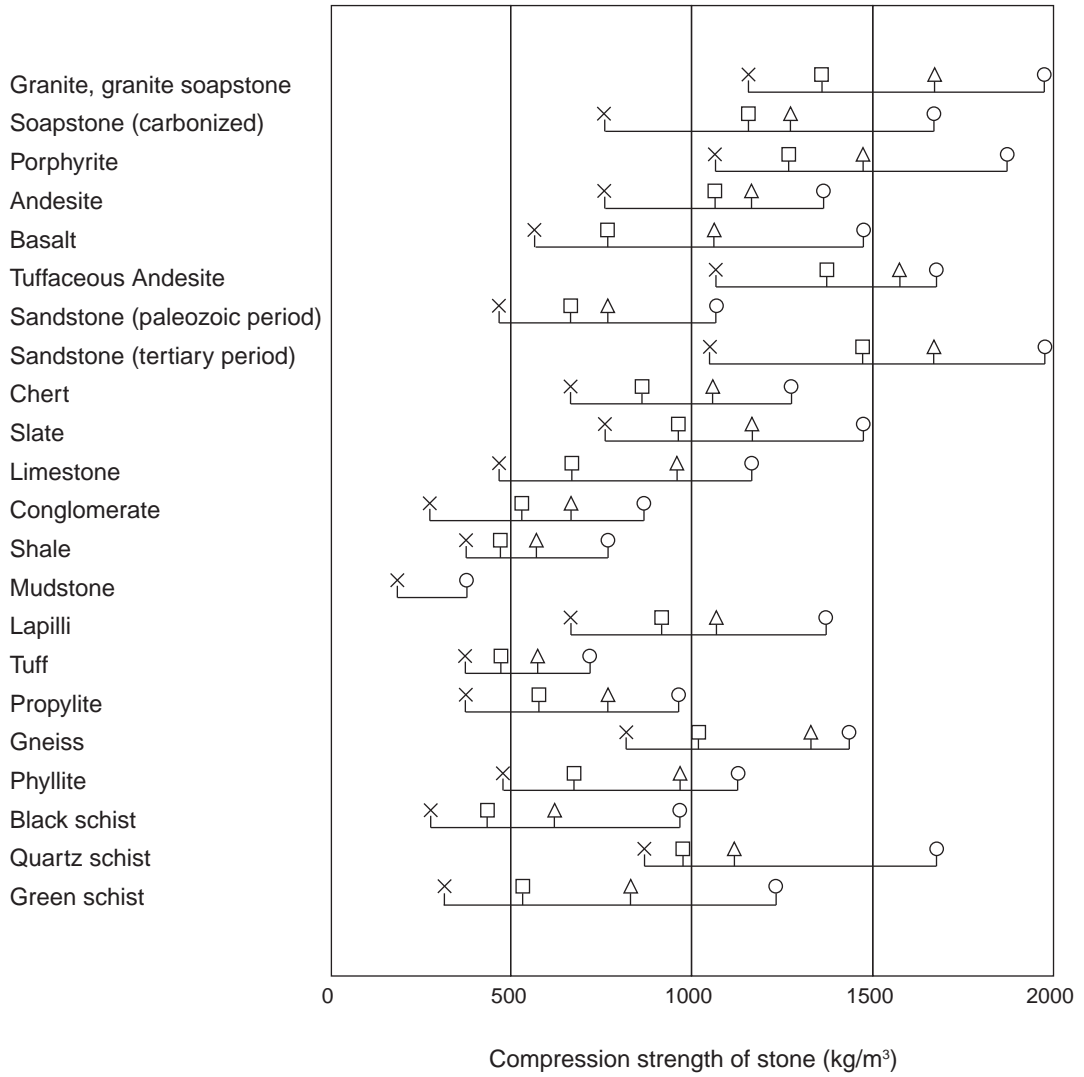

HAULING PERFORMANCE OF CONSTRUCTION MACHINES

INTRODUCTION

"What Model or type of a tractor is most suitable to pull this trailer?" "Is this bulldozer capable of going up this hill while pulling that scraper loaded full?"

In order to give explicit answers to these questions, it is necessary to have the right understanding of the hauling performance of vehicles.

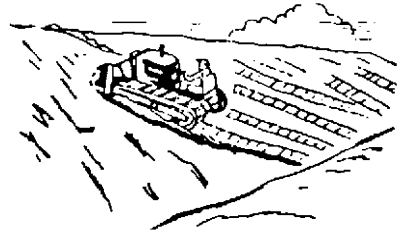
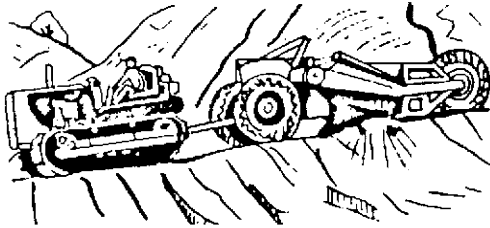

For easy understanding, let us explain the hauling performance with the following machine capabilities and related elements.

- (1) The inherent machine capability
- (2) Elements limiting the inherent machine capability
- (3) Machine capabilities required for earthmoving operations

INHERENT MACHINE CAPABILITY

1. What is the inherent machine capability?

a) Output power

The engine horsepower of a construction machine is the most essential power of those developed by the machine itself. This can be estimated by multiplying one element (traction force) by another element (a travel speed). Accordingly, where the engine of a machine develops a rated power; the smaller the travel speed, the larger the traction force or drawbar pull will be. On the contrary, the larger the travel speed, the smaller the drawbar pull.

b) Gear-shifting

Gear-shifting is effected to determine the optimum drawbar pull and travel speed required for accomplishing a given job. Therefore, a machine has several gears to be selected by shifting for the optimum travel speed.

2. Direct-drive type tractor

The table below gives the drawbar pull and travel speeds of a direct-drive type bulldozer.

Gear-shifting	Travel speed km/h	Rated drawbar pull kg	Max. drawbar pull kg
F1	2.5	27600	34500
F2	3.5	19700	—
F3	4.9	14100	—
F4	6.4	10780	—
F5	8.9	7670	—
F6	12.9	5350	—

The rated drawbar pull is such a traction force that can be developed at the rated engine power and the rated revolutions (rpm). The rated drawbar pull is normally estimated by taking into account the travelling resistance (which will be explained later) and the mechanical loss of power in its line from the engine to the sprockets.

The maximum drawbar pull is the maximum traction force that can be developed by a machine and is estimated from the maximum engine torque. In other words, the maximum drawbar pull of a machine can be developed by the lugging ability of its prime mover and is practically obtained in a low gear. Consequently, the maximum drawbar pull is shown only at F1 on the specifications.

3. TORQFLOW-drive type tractor

In a TORQFLOW-drive type tractor, the relationships between the travel speeds and drawbar pull are obtained from the combined performance between the engine and the torque converter.

In a TORQFLOW-drive machine, it is difficult to relate both the drawbar pull and travel speeds directly to the engine revolutions. Thus, the hauling performance is indicated by curves. The graph at right gives the hauling performance curves of the TORQFLOW-drive type bulldozer.

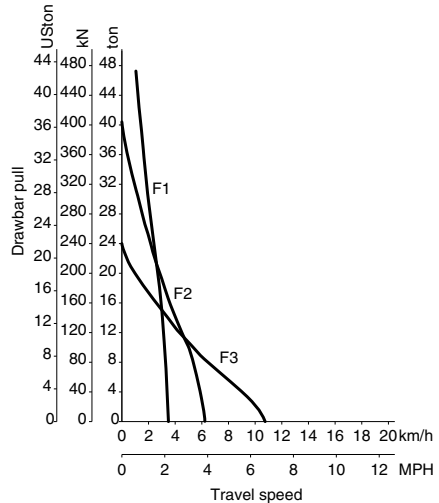

ELEMENTS LIMITING THE INHERENT MACHINE CAPABILITY

1. What are the elements limiting the inherent machine capability or power? These are;

a) Traction between the undercarriage (tracks or wheels) and the road surface.

b) Altitude

Altitude in b) will be described in a separate issue and herein is examined the problem of traction between the undercarriage and the road surface.

2. Traction between the undercarriage and road surface

"When a motor vehicle cannot be moved due to slipping on the snow-covered road, what should be done to move the vehicle?"

The answers are;

<u>Solution</u>	<u>Reason</u>
(1) Add load to the driving wheels.	⇒ The traction force is increased with the added load.
(2) Install chain to the wheel tires or replace the tires with the spiked type.	⇒ The undercarriage is made so as to develop more traction.
(3) Scatter sand or spread straw mats on the road surface.	⇒ The critical traction force is increased by the higher coefficient of traction.

The above facts can also be applied to a crawler tractor. Now, let us look at the coefficient of cohesion and the critical traction force or traction used in the above table.

The critical traction is the maximum traction available depending on the cohesive condition of the road surface. This can be estimated by the following formula.

$$F_d = \mu d \cdot G_d$$

Where, F_d : Critical traction (kg)
 μd : Coefficient of traction
 G_d : Weight imposed on the driving wheels (kg)

The coefficient of traction depends on the condition of the road surface. Any applicable coefficient of traction can be selected from among those given in the table below.

	Tractor w/pneumatic tires	Crawler tractor
Dry concrete	0.95	0.45
Dry macadam road	0.70	
Wet macadam road	0.65	
Dry unpaved plain road	0.60	0.90
Dry ground	0.55	0.90
Wet ground	0.45	0.85
Dry loose terrain	0.40	0.60
Loose gravel	0.36	0.25
Loose sand	0.27	0.30
Muddy ground	0.25	0.25
Packed snow	0.20	0.15
Ice	0.12	0.12

Weight to be imposed on the driving wheels can be determined by referring to the table below

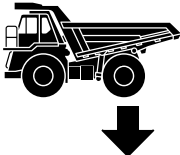
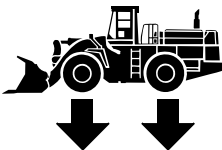
Crawler type tractor	2-wheel drive machine	4-wheel drive machine
		
Total weight of tractor	Weight imposed on the driving wheels	Total weight of tractor

Example (1) Assume that the D155 tractor pulling a towed compactor must do compaction in a dry, loose terrain. What is the critical drawbar pull?

Solution: The operating weight of the D155 tractor is 26730 kg. Then, $F_d = 0.60 \times 26730 = 16040$ kg

Example (2) What are the values of the drawbar pull which the D50A-15 bulldozer can develop at F1 and F2 in a dry, loose terrain?

Solution: The operating weight of the D50A-15 bulldozer is 11400 kg. Its critical drawbar pull is $11400 \times 0.60 = 6840$ kg.

The rated drawbar pull indicated in its specifications is 8280 kg at F1 or 5920 kg at F2.

Consequently

at F1: The rated drawbar pull is 8280kg, but the tracks will start shoe slip at the drawbar pull beyond 6840kg, making it impossible for its drawbar pull to be utilized to the full. Thus, the critical drawbar pull practically available is 6840 kg.

at F2: The rated drawbar pull is 5920kg. Thus, the drawbar pull can be utilized to the full.

MACHINE CAPABILITIES REQUIRED FOR EARTHMOVING OPERATIONS

1. What are the elements limiting the machine capabilities required for earthmoving operations?

When a truck is traveling on the road or going uphill, the following phenomena will be encountered as a matter of course.

<u>Phenomenon</u>	<u>Influential element</u>
(1) The travel speed of a truck with load on the flat road should vary when the same truck with the same load travels on the rugged or rutted surface.	⇒ Rolling resistance
(2) When traveling on the flat road or going uphill in the same operating gear, the travel speed should vary as a matter of course.	⇒ Grade resistance

2. Rolling resistance

When a vehicle is traveling on the ground or road, the retarding force of ground against wheels or tracks should take place. Such a resistance varies depending on the ground or road surface conditions.

The rolling resistance is measured in the ratio to the vehicle weight and can be estimated by the following formula.

$$W_r = \mu_r \cdot G$$

Where, W_r : Rolling resistance (kg) μ_r : Coefficients of rolling resistance
 G : Vehicle operating weight

The coefficient of rolling resistance can be selected from among those given in the table below, according to the ground or road surface conditions.

The coefficient of rolling resistance can be selected from among those given in the table below, according to the ground or road surface conditions.

Type and conditions of ground	μ_r (%)		
	Vehicle w/iron wheel treads	Crawler tractor	Tractor w/pneumatic tires wheels
Iron truck	1.0		
Concrete floor	2.0	2.8	2.3
Macadam road	2.9	3.3	2.8
Wood pavement	2.5		
Dry unpaved plain road	4.5	4.6	3.5
Firm terrain	10.0	5.5	4.0
Dry, loose terrain	11.5	6.5	4.5
Soft terrain	16.0	8.0	9.0
Loose gravel	15.0	9.0	12.0
Loose sand	15.0	9.0	12.0
Muddy ground		12.0	16.0
Packed snow			3.7
Ice			2.0

In a crawler tractor, too, the rolling resistance should vary depending on the type of applied soil. The representative values of rolling resistance, however, are taken into account in preparing the curves for drawbar pull and hauling performance of crawler tractors. Therefore, the varying rolling resistance may practically be ignored.

Example (3) What is the rolling resistance of the D85-12 tractor to pull the RS12 scraper (empty).
The ground surface is in a soft terrain.

Solution: The weight of an RS12 scraper (empty) is 10500 kg
The rolling resistance = $0.09 \times 10500 = 945\text{kg}$

Example (4) What is the rolling resistance of the D155 tractor to pull the RS24 scraper loaded full.
The ground surface is in a dry loose terrain.

Solution: The net weight of an RS24 is 18000 kg
The maximum payload is 34080 kg
The gross weight is 52080 kg
Thus, the rolling resistance = $0.045 \times 52080 = 2340\text{ kg}$

3. Grade resistance

The grade resistance is the retarding force of gravity to be encountered when a vehicle is going uphill.
The grade resistance can be estimated by the following formula.

$$W_s = G \cdot \sin \alpha$$

Where, W_s : Grade resistance (kg)

G : Operating weight of a vehicle (kg)

α : Angle formed with the horizon (degree)

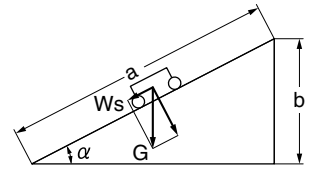

FVBH0041

A grade (degree) and $\sin \alpha$ can be selected from among those given in the table below.

Grade resistance (%) converted from angle (°) of gradient

Grade resistance (%) converted from angle (°) of gradient

Angle	% ($\sin \alpha$)	Angle	% ($\sin \alpha$)	Angle	% ($\sin \alpha$)
1	1.8	11	19.0	21	35.8
2	3.5	12	20.8	22	37.5
3	5.2	13	22.5	23	39.1
4	7.0	14	24.2	24	40.2
5	8.7	15	25.9	25	42.3
6	10.5	16	27.6	26	43.8
7	12.2	17	29.2	27	45.4
8	13.9	18	30.9	28	47.0
9	15.6	19	32.6	29	48.5
10	17.4	20	34.2	30	50.0

Example (5) What is the grade resistance against the D50A-15 angledozer going uphill at 15° ?

Solution: The operating weight of the D50A-15 angledozer is 11400 kg. Thus, the grade resistance will be $11400 \times 0.259 = 2950\text{ kg}$

4. Hauling resistance

The hauling resistance is the grand total of the rolling resistance, grade resistance, accelerating resistance and air resistance. However, construction machines are slow in the travel speed. Normally, the hauling resistance of construction machines may be considered to be the total of the rolling resistance and grade resistance.

The grade resistance acts so as to retard the uphill traveling of a vehicle, whereas the grade resistance acts so as to accelerate the downhill traveling. The above relationships can be indicated as follows:

Conditions

Uphill traveling
Traveling on flat, level surface
Downhill traveling

Haul resistance

Rolling resistance + grade resistance
Rolling resistance.
Rolling resistance – grade resistance

Example (6) What is the hauling resistance against the D60-6 tractor going uphill at 4° in a dry, loose terrain, while pulling an RS08 scraper with maximum load?

Solution: The gross weight of the RS08 with maximum load is 18870 kg.
The rolling resistance factor is 0.045. Thus, the rolling resistance is $0.045 \times 18870 = 850$ kg
The weight of the D60-6 tractor is 12550 kg.
The gross weight of the RS08 is 18870 kg.
Then, the total weight of both machines is 31420 kg
Consequently, the grade resistance is $0.07 \times 31420 = 2200$ kg.
Thus, the hauling resistance is $850 + 2200 = 3050$ kg.

SUMMARY AND APPLICATION

1. Summary

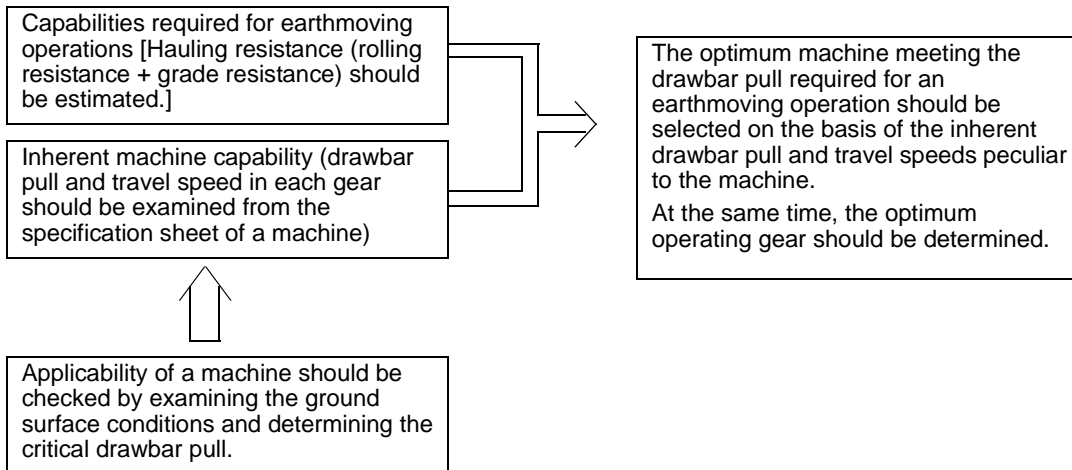

2. Application

Example (7) Assume that the D65 tractor is used to pull a wheeled wagon (the empty weight: 17 tons) with a 50-ton load in a dry, loose terrain.
What are the operating gears and the corresponding approx. travel speeds available on a flat, level ground? What is the degree of a hill climbable under the same condition?

Solution: The rolling resistance

Weight of the wagon (empty): 17000 kg Payload: 50000 kg
Total weight: 67000 kg Coefficient of rolling resistance: 0.045
Consequently the rolling resistance against the wagon is $67000 \times 0.045 = 3015$ kg

Operating gears and travel speeds on flat, level ground

From the hauling performance curves below, the operating gears and travel speeds at a 3015 kg drawbar pull are:

approx. 9.0 km/h at F3 or

approx. 6.0 km/h at F2

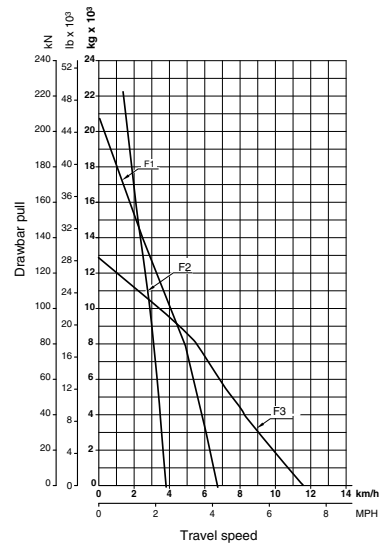

Critical drawbar pull

The operating weight of D65 tractor: 12750 kg

Coefficient of traction: 0.60

Consequently, the critical drawbar pull is $12750 \times 0.60 = 7650$ kg

Degree of a climbable hill (gradeability)

Tractor weight + wagon weight + pay load = $12750 + 17000 + 50000 = 79750$ kg

The grade resistance retarding per angle of grade is $79750 \times 0.018 = 1435$ kg

Consequently,

$$\text{Gradeability} \left(\frac{\text{Critical drawbar pull} - \text{rolling resistance}}{\text{Grade resistance per angle of grade}} \right) \text{ will be } \frac{7650 - 3015}{1435} = 3.2 \text{ (degree)}$$

The explanations made so far on the travelling or hauling performance of construction machines pertain only to the traveling of individual machines and the pulling of towed vehicles by tractors. For instance where a tractor pulls a scraper, it can be judged whether the tractor can be used for this purpose, but it can not be determined whether the tractor can perform a digging or a loading operation under the same conditions as mentioned above. Operators or field-superintendents are requested to keep it in mind that such a judgement should be based on the operators' accumulated experiment or on the reference for such operating combinations or cooperation among towing tractors and towed vehicles as recommended by KOMATSU.

TRAFFICABILITY

Operating efficiency of a construction machine depends largely on the ground surface on which the machine travels. In clay, loam or clayey soil high in water or moisture content, the bearing force of soil is low and a "kneading" phenomenon is liable to occur. Consequently, there are cases where a construction machine cannot be operated because of the type and conditions of soil. The degree of the traveling capability of a construction machine is called the traffic-ability.

In general, traffic-ability is indicated by a cone index No. (The method of measuring a cone index No. will be described later.)

The larger the cone index number becomes, the higher the traffic-ability of the machine will become. In other words, on the soil larger in cone index No., a construction machine will be able to travel easier.

The minimum cone index numbers required for various types of construction machines to perform digging, hauling operations, etc. are given below.

Cone index No.	Type of construction machine	Ground pressure (kg/cm ²)
Below 2	Ultra swamp bulldozer (PL class)	0.15 ~ 0.25
2 to 4	Swamp bulldozer (P Class)	0.2 ~ 0.3
4 to 5	Small-size bulldozer (D20 ~ D31)	0.3 ~ 0.6
5 to 7	Medium-size bulldozer (D41~D75S)	0.6 ~ 0.8
7 to 10	Large-size bulldozer (D85 ~ D575) & towed scraper	0.7 ~ 1.5
10 to 13	Motor scraper	
15 & more	Dump truck	

NOTE:

In determining a cone index, apply the cone penetrometer at 3 or 4 points at least to average the variations in the measured values.

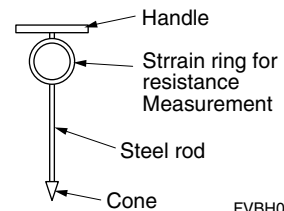

FVBH0042

* Cone index numbers (qc)

A cone index number is measured by means of a cone penetrometer in a cone penetration test.

A rod with a cone at the tip is pushed into the soil by hand.

The pressure required to advance the cone at a slow constant rate is known as the penetration resistance.

The penetration resistance is read out on the dial gauge.

Thereby, the shearing strength of soil can be estimated.

Then, a cone index number can be obtained by referring the estimated shearing strength to the conversion table attached to the meter.

1. Blasting and bench width

Minimum bench width should be at least twice the cutting face height.

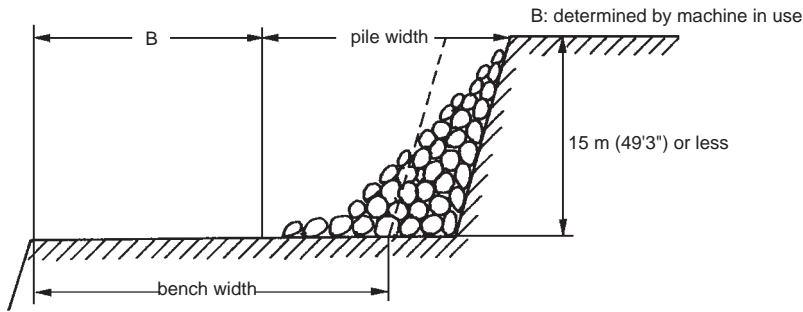

2. Machine and bench width

2.1 Excavator loading to the dump truck

Bench width must be at least three times the dump truck's turning radius.

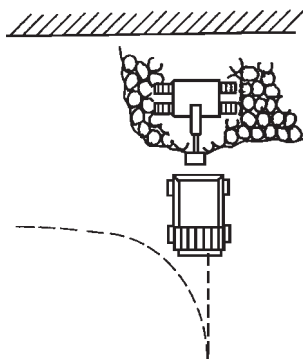

Model	Min. turning radius m (ft.in)	Bench width m (ft.in)
HD255	7 (23')	21 (68'11")
HD325	7.2 (23'7")	22 (72'2")
HD405	7.2 (23'7")	22 (72'2")
HD465	8.5 (27'11")	26 (85'4")
HD605	8.5 (27'11")	26 (85'4")
HD785	10.1 (33'2")	30 (98'5")
HD1500	12.2 (40')	37 (121'5")
730E	14.0 (45'11")	42 (137'10")
830E	14.2 (46'7")	43 (141'1")
860E	15.5 (50'10")	47 (154'2")
930E	15.2 (48'9")	46 (150'11")
960E	16.0 (52'6")	48 (157'6")

2.2 Wheel loader loading to the dump truck

Bench width must be at least three times the wheeled loader's length.

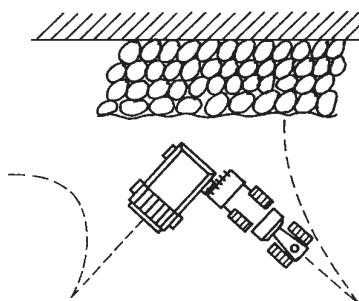

Model	Wheel loader length m (ft.in)	Bench width m (ft.in)
WA500	9.9 (32'6")	30 (98'5")
WA600	12.0 (39'4")	36 (118'1")
WA700	12.5 (41')	38 (124'8")
WA800	14.1 (46'3")	43 (141'1")
WA900	14.5 (47'7")	44 (144'4")
WA1200	19.1 (62'8")	56 (183'9")

3. Haul road planning

3.1 Dump truck width and haul road size

The width dump truck haul road must have sufficient room to accommodate the model of dump truck planned for use on the site.

In order to accommodate one lane in each direction, with trucks going 30 km/h (18.6 MPH), the haul road must be at least four times the truck width

Dump truck width and haul road size

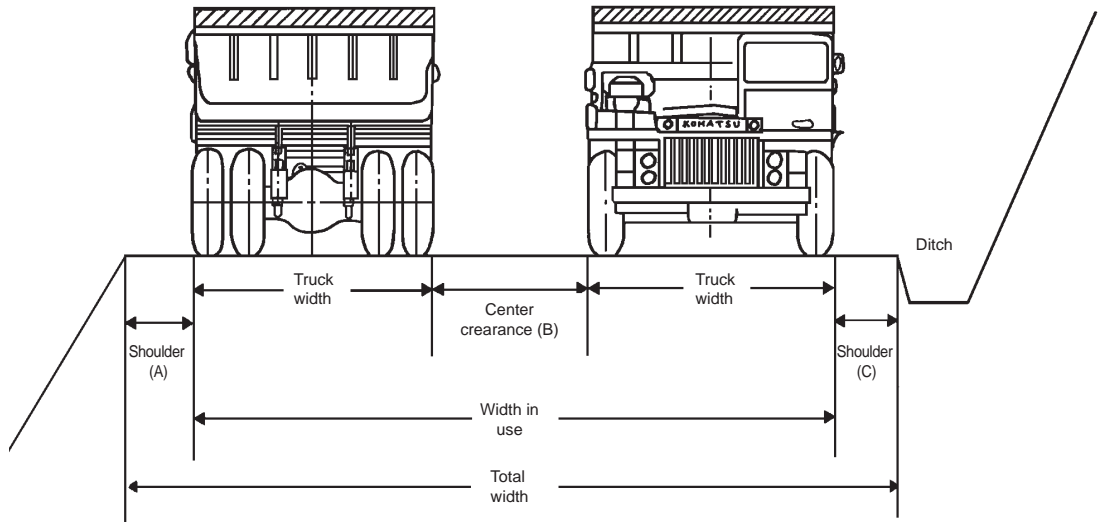

Model	Speed km/h (MPH)	Center clearance (B) m (ft.in)	Downhill shoulder (A) m (ft.in)	Uphill shoulder (C) m (ft.in)	Total road width m (ft.in)
HD255-5	20 (12.4)	2.0 (6'7")	2.0 (6'7")	1.0 (3'3")	11.4 (37'5")
Truck width	30 (18.6)	2.5 (8'2")	2.0 (6'7")	1.5 (4'11")	12.4 (40'8")
3.2 m (10'6")	40 (24.9)	3.0 (9'10")	2.0 (6'7")	1.5 (4'11")	12.9 (42'4")
HD325-6	20 (12.4)	3.0 (9'10")	2.0 (6'7")	1.5 (4'11")	13.8 (45'3")
Truck width	30 (18.6)	3.0 (9'10")	3.0 (9'10")	1.5 (4'11")	14.9 (48'11")
3.7 m (12'2")	40 (24.9)	3.5 (11'6")	3.0 (9'10")	2.0 (6'7")	15.9 (52'2")
HD405-6	20 (12.4)	3.0 (9'10")	2.0 (6'7")	1.5 (4'11")	13.8 (45'3")
Truck width	30 (18.6)	3.0 (9'10")	3.0 (9'10")	1.5 (4'11")	14.9 (48'11")
3.7 m (12'2")	40 (24.9)	3.5 (11'6")	3.0 (9'10")	2.0 (6'7")	15.9 (52'2")
HD465-7	20 (12.4)	3.0 (9'10")	3.0 (9'10")	1.5 (4'11")	16.7 (54'10")
Truck width	30 (18.6)	3.5 (11'6")	3.0 (9'10")	2.0 (6'7")	17.7 (58'1")
4.6 m (15'1")	40 (24.9)	3.5 (11'6")	3.5 (11'6")	2.5 (8'2")	18.7 (61'4")
HD605-7	20 (12.4)	3.0 (9'10")	3.0 (9'10")	1.5 (4'11")	16.7 (54'10")
Truck width	30 (18.6)	3.5 (11'6")	3.0 (9'10")	2.0 (6'7")	17.7 (58'1")
4.6 m (15'1")	40 (24.9)	3.5 (11'6")	3.5 (11'6")	2.5 (8'2")	18.7 (61'4")
HD785-7	20 (12.4)	3.5 (11'6")	3.5 (11'6")	2.5 (4'11")	20.5 (67'3")
Truck width	30 (18.6)	4.0 (13'1")	4.5 (14'9")	2.5 (6'7")	22.0 (72'2")
5.48 m (18'0")	40 (24.9)	4.5 (14'9")	4.5 (14'9")	3.0 (8'2")	23.0 (75'6")
HD1500	20 (12.4)	3.5 (11'6")	3.5 (11'6")	2.5 (8'2")	21.7 (71'2")
Truck width	30 (18.6)	4.0 (13'1")	4.5 (14'9")	2.5 (8'2")	23.2 (76'1")
6.1 m (20'0")	40 (24.9)	4.5 (14'9")	4.5 (14'9")	3.0 (9'10")	24.2 (79'5")

Model	Speed km/h (MPH)	Center clearance (B) m (ft.in)	Downhill shoulder (A) m (ft.in)	Uphill shoulder (C) m (ft.in)	Total road width m (ft.in)
730E	20 (12.4)	3.5 (11'6")	4.0 (13'1")	2.5 (8'2")	24.5 (80'5")
Truck width	30 (18.6)	4.0 (13'1")	5.0 (16'5")	2.5 (8'2")	26.0 (85'4")
7.25 m (23'9")	40 (24.9)	4.5 (14'9")	5.0 (16'5")	3.0 (9'10")	27.0 (88'7")
830E	20 (12.4)	3.5 (11'6")	4.0 (13'1")	2.5 (8'2")	24.5 (80'5")
Truck width	30 (18.6)	4.0 (13'1")	5.0 (16'5")	2.5 (8'2")	26.0 (85'4")
7.26 m (23'10")	40 (24.9)	4.5 (14'9")	5.0 (16'5")	3.0 (9'10")	27.0 (88'7")
860E	20 (12.4)	4.0 (13'1")	4.0 (13'1")	2.5 (8'2")	27.2 (89'3")
Truck width	30 (18.6)	4.5 (14'9")	5.0 (16'5")	2.5 (8'2")	28.7 (94'2")
8.33 m (27'4")	40 (24.9)	5.0 (16'5")	5.0 (16'5")	3.0 (9'10")	29.7 (97'5")
930E-3	20 (12.4)	4.0 (13'1")	4.0 (13'1")	2.5 (8'2")	27.9 (91'6")
Truck width	30 (18.6)	4.5 (14'9")	5.0 (16'5")	2.5 (8'2")	29.4 (96'6")
8.69 m (20'6")	40 (24.9)	5.0 (16'5")	5.0 (16'5")	3.0 (9'10")	30.4 (99'9")

3.2 Haul road grade

For best fuel efficiency and safety against slippage, etc, the road's grade should ideally be under 10%.

CONTENTS

INDEX

SECTION **15**

OWNING & OPERATING COSTS Sec 15

SECTION **15**

OWNING & OPERATING COSTS

CONTENTS

Estimation of the Owning & Operating Costs:

Owning Cost	15-2
Operating Cost	15-4
Example of Calculation	15-6
Application and Operating Conditions Table	15-9
Fuel Consumption	15-10
Lubricant Consumption	15-19
Tire Life	15-23
Optimum Fleet Recommendation (OFR) Software Program	15-24
Komatsu Information on Reliability and Durability	15-25

Estimation of the Owning & Operating Costs

Along with the trend for mechanization adopted for economical and satisfactory job accomplishment, equipment costs now occupy a large proportion of the overall construction cost. Therefore, the estimation of the equipment costs has become more important. Success or failure in a contract for a construction job is virtually dependent on the estimates of the equipment costs. In other words, careful consideration of the equipment costs is of prime importance, if a contractor is to fulfill the contract at a profit. Unless estimates are made properly, there will occur cases where a construction job cannot be accomplished at a profit.

There are two types of equipment costs: owning costs and operating costs. Owning costs refer to the costs incurred even if the machine is not working. They include depreciation, interest, taxes and insurance. Operating costs are the costs incurred in actually operating the machine. They include costs for repair, fuel, lubricants, tires, special items (consumable parts such as ground engaging tool) and operator's wages.

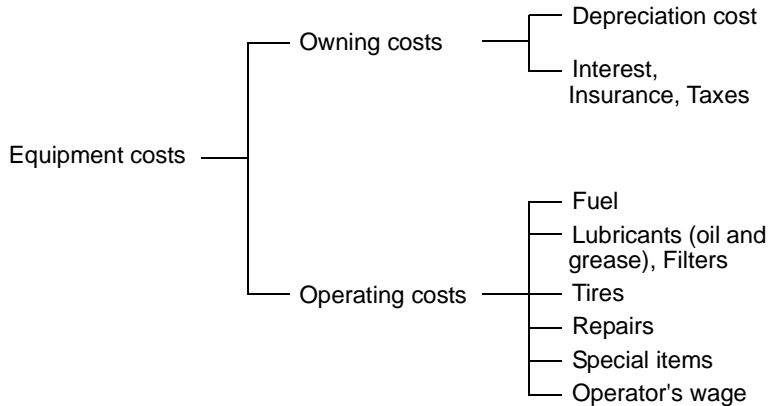

We would like to explain **one method** of estimating the owning and operating costs of construction equipment in this handbook.

The owning and operating costs of construction equipment can vary widely because they are influenced by many factors: the type of work the machine does, local prices of material, labor, fuel and lubricants, interest rates, etc. Accordingly it is very dangerous to estimate the costs relying entirely on an established form of calculation method.

In this Manual, however, we will make approximate estimates of general application of the equipment costs. Accordingly, if users want more accurate values of the costs, we hope that they will make estimates by taking into account their own reference data and territorial or environmental conditions.

Depreciation period, and repair and periodic maintenance cost are especially affected by specific application and type of work. Therefore, if you need those data, we suggest that you contact the local Komatsu distributor with necessary information.

The equipment owning and operating costs are calculated in units of \$/m³, \$/m² or \$/h, etc., depending on the type of construction work. The costs in \$/m³ or \$/m² are obtained by dividing the cost in \$/h by production (m³/h) and thus, it is recommended that the owning and operating costs be calculated in the unit of \$/h as generally accepted.

1. Owning cost

The equipment owning cost is the expense required, as a matter of course, for the purchase and possession of the equipment as a property of its owner and consists of the following two items.

- (1) Depreciation**
- (2) Interest, insurance and taxes**

1-1. Depreciation

In general, depreciation is a tax term referring to the legally permitted decline in value from the original purchase price of equipment, and is an assessable property (expressed in units of years). Depreciation referred to herein is a business practice for conserving the investment in the form of purchased equipment, in other words, for making preparations in a systematic manner for the fund necessary for replacing the existing equipment with new or any other equipment.

$$\text{Depreciation} = \frac{\text{Net Depreciation Value}}{\text{Depreciation Period in Hours}}$$

Net depreciation value means Original purchase price minus Resale or Trade-in price.

The depreciation period varies considerably according to the equipment operating conditions. It is also affected by the speed of fund collection desired by the user, environmental and economic conditions in its applied territory. Furthermore, it goes without saying that maintenance of equipment is a significant

factor in determining the economical life of the equipment. Proper maintenance will extend the life of equipment. On the other hand, poor or improper maintenance will shorten the life. There is the legal depreciation period in each country for tax purpose. However, in the business, it is rather usual to employ the equipment owning period as the depreciation period. The equipment owning period is strongly affected by the economical life of the equipment (Years or hours for which the equipment can be used gainfully).

When you need to estimate the value of the economical life for a specific product, please consult your distributor or Komatsu representative. They can suggest you with the appropriate values from their experience and the data they have. (The former handbook contained the depreciation period, but they are removed because the straight numbers sometimes mislead the readers.)

The net depreciation value is the net amount to be considered in the depreciation of equipment.

In case of crawler-type tractors, their purchase prices are used to calculate the net depreciation value. In wheel type equipment, their tire values should be deducted from the purchase prices, because, unlike the undercarriages of crawler-type equipment, tires wear out earlier than the equipment chassis proper, and tires are not cheap. Further, there is a possibility of tires becoming unserviceable suddenly in unexpected accidents. Hence, it is necessary in tire depreciation to include their degrees of wear into the operating cost.

Resale or trade-in values

At the time of resale or trade-in, construction machines have a value.

Some users will hope that in terms of book value the machine will depreciate completely within the depreciation period. Other users will hope that the residual value expressed as resale value or trade-in value will be left. For these users the resale value or trade-in value is an important factor in reducing the capital invested. This value is also a factor when deciding to purchase a new machine.

The resale value or trade-in value changes greatly according to the territory. Therefore the conditions in that territory must be considered when determining these values. However, major factors in deciding resale value or trade-in value are the hours of operation, nature of work and working environment. The real resale value or trade-in value cannot be decided simply, but when a realistic value is decided it is subtracted from the purchase price to give the Net Depreciation value. It is then possible to obtain the depreciation from the Net Depreciation Value.

1-2. Interest, insurance and taxes

Whether or not purchased equipment is actually in operation, its users must pay interest, insurance and taxes. Interest refers to the interest on the investment, when the investment is covered by the user's own fund or to the interest on the debt, when the investment is covered by a debt. In either case, the interest will be an equal amount.

Insurance and taxes are imposed on the annual residual values of the equipment, which requires knowledge of depreciation as prescribed by the tax law. The depreciation rate or the depreciation period (whether it is a fixed amount or a fixed rate) vary according to the country. For the correct values of insurance and taxes on the residual value in a country, the calculation formulas established in that country must be used.

Interest, insurance and taxes are imposed on the residual value that is the difference between the purchase price and the depreciated amount. This residual value decreases every year. However, when the user calculates owning & operating costs, it is convenient to consider interest, insurance and taxes as a constant amount paid out each year. For this reason, the machine will be considered here to depreciate by a constant annual amount. A calculation is made of the average value of the residual value at the beginning of each year within the depreciation period, and interest, insurance and taxes are imposed on this value. By dividing this value by the number of hours the user expects to operate the machine in one year, the hourly value can be calculated.

This can be calculated by using the following formula.

$$\text{Interest, insurance, tax} = \frac{\text{Factor} \times \text{Delivered price} \times \text{Annual rates}}{\text{Annual use in hours}}$$

The annual rates are the total of those of interest, insurance and tax.

The factor can be obtained by using Table 1 or can be calculated by the following formula.

$$\text{Factor} = 1 - \frac{(n-1)(1-r)}{2n}$$

Estimation of The Owning & Operating Costs

OWNING & OPERATING COSTS

where **n**: Depreciation period

$$r: \text{Trade-in value rate} = \frac{\text{Machine worth at trade-in or resale time}}{\text{Delivered price}}$$

(Example)

Delivered price: \$100,000

Annual rates: 15%

Annual use in hours: 2,000 hrs

Trade-in value: \$25,000

Depreciation period (n) : 4 years

Solution

$$r = \frac{25,000}{100,000} = 0.25$$

$$\text{Factor} = 1 - \frac{(4 - 1)(1 - 0.25)}{2 \times 4} = 0.72$$

When obtaining the factor by using Table 1.
Enter $r = 0.25$ in Table 1
Move vertically to $n = 4$ line and horizontally to left axis.
Applicable factor is 0.72

$$\text{Interest, insurance, tax} = \frac{0.72 \times \$100,000 \times 0.15}{2,000} = \$3.59$$

Table 1 Factor of Interest, Insurance, Taxes

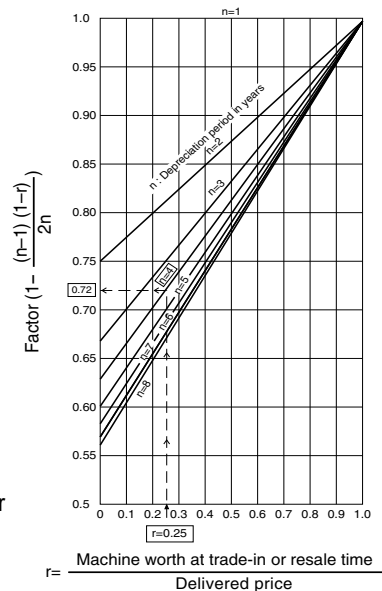

2. Operating cost

The equipment operating costs are proportional to the time that the equipment works. Items considered in this category are as follows:

- (1) Fuel
- (2) Lubricants (oil and grease), Filters and Periodic Maintenance Labor
- (3) Tires
- (4) Repair Cost
- (5) Special items (Ground engaging tools)
- (6) Operator's wage

2-1. Fuel

More definite fuel consumption data should be measured in the field.

It is possible, however, to anticipate the actual or approximate consumption values according to the actual operating conditions without measuring the consumption. **Table 3** gives the hourly fuel consumption values for KOMATSU construction machines. In this table, the average values are given, provided that the job conditions are classified into three different ranges of application. If a user has data on certain operating conditions, more correct or realistic values will be obtained by applying these data in similar operating conditions, provided that the equipment is limited to the same type as that used in the user's data.

To estimate hourly fuel cost, select the job condition based on application and find hourly fuel consumption.

$$\text{Hourly fuel cost} = \text{Hourly fuel consumption} \times \text{Local unit price of fuel}$$

2-2. Lubricants (oil and grease), filters and periodic maintenance labor

It is possible to measure the consumption of lubricants and grease in the same manner as the fuel consumption. The consumption values of lubricants and grease are also obtained by calculation on the basis of lubrication intervals, but they are affected greatly by the type of machines and their operating conditions, which makes it difficult to specify the consumption suited for various machines and their operating conditions. **Table 4** gives the data based on the oil use per hour for your reference.

$$\text{Hourly Lubricant Consumption} = \text{Oil replacement amount (liter)} \div \text{Oil change interval (hour)}$$

Prices of lubricants vary in countries or areas and, therefore, the local price (price in that country or area) should be used.

In KOMATSU construction machines, filter replacement intervals are standardized for each machine model. Thus, the cost of filter can be calculated from the local price of filter and the replacement interval. The hourly filter cost is the total of the hourly costs for each type of filter.

(Example)

$$\text{Hourly cost of filter A} = \frac{\text{Number of filters A} \times \text{Local price of filter A}}{\text{Replacement interval of filter A}}$$

The same method is used for calculating the hourly filter cost of other filters. For quick estimation, hourly filter costs are about 50% of hourly lubricant costs. If they are used in the dusty terrain, the calculated value should be multiplied by a proper factor.

If necessary, we suggest you to contact the local Komatsu distributor with necessary information to get the assistance for estimating them.

2-3. Tires

As has been described in Depreciation, tires are in the category of consumable parts and tires are generally expensive. Therefore, it is better to include the tire cost as an individual item in the operating costs. Tire cost is calculated by the following formula.

$$\text{Hourly tire cost} = \frac{\text{Tire price}}{\text{Estimated life}}$$

As tire prices vary in each country or area, the price of tires actually bought by a user should be applied. It is difficult to indicate definitely the tire life, because the tire life is affected by many factors. However, the general measurements for the life expectancy of tires can be indicated on the basis of past experience and data obtained from the tire manufacturers. Refer to **Table 4**.

In this table, the approximate life values are given for three different types of conditions. The optimum value for a certain ground condition is one of those obtained by a user in experience on similar ground conditions. When recapped tires are to be used, their prices and life expectancy must be changed correspondingly.

2-4. Repair cost

Components or parts of a machine will in due course wear and sometimes fail. To keep a machine in a properly maintained condition, these components or parts must be replaced. It is natural for the repair cost of a machine to start from a small amount and gradually increase with time as the machine is operated. The repair cost of a machine can be estimated actually as described above with respect to the machine operating time. However, in general, repair cost is considered as an average of total repair costs throughout the service life of a machine. In other words, it is based on the concept that part of repair cost to be paid later should be laid aside in advance.

Repair costs are more greatly affected by the machine operating conditions than by any other cost items. It depends greatly on the job, operating techniques or operator's skill, proper maintenance, etc. In a specific job application, calculation for repair cost should be made on the basis of the data accumulated in the past. If such data are not available, the calculation should be made with due consideration of experience.

Repair Cost are affected by specific application and type of work as well. Therefore, we suggest that you contact the local Komatsu distributor with necessary information for the repair cost estimation.

2-5. Special items (Ground engaging tools)

In the objects of repair, the repair costs include the machine and its attachments. Some parts of a machine wear faster than others. These parts are the ground engaging tools and not included in the category of repair but in a group of special items. Life expectancy of ripper points, ripper shanks and shank protector is given in **Table 5**.

2-6. Operator wages

Operator hourly wages vary according to the country and area. Thus, the wages actually paid by users should be used.

3. Example of calculation

PC200 is delivered for \$92,811 at a job site.

Applications:

Mass excavation or trenching where machine digs all the time in natural bed clay soils. Some traveling and steady, full throttle operation.

Net Depreciation Value

Since the machine is a crawler-type, tires are not involved. This owner knows from experience that at trade-in time, the machine will be worth approximately 10% of its delivered price 4 years from now.

Trade-in value is \$9,281

Net depreciation value = \$92,811 – \$9,281 = \$83,530

Owning cost

Depreciation:

Putting 10,000 hours as the example depreciation period.

$$\text{Depreciation} = \frac{\$83,530}{10,000} = \$8.35$$

Interest, Insurance, Taxes

Owner plans to use machine during 4 years and about 2,500 hours per year.

$$\text{Trade-in value rate}(r) = \frac{\$9,281}{\$92,811} = 0.1$$

Calculate the Factor according to depreciation period and trade-in value rate, which is 0.66.

Enter the annual rates of interest, insurance and taxes and total them, which is 0.14 as an example.

$$\text{Interest, insurance, taxes cost} = \frac{0.66 \times \$92,811 \times 0.14}{2,500} = \$3.43$$

Add up the depreciation cost and interest, insurance, taxes cost for total owning.

Operating cost

Fuel: See Table 3.

The intended application is in medium range. The estimated fuel consumption from table is 12.5 liter/hour.

Cost of fuel in this area is \$0.2/liter.

$$\text{Consumption} \times \text{Unit cost} = 12.5 \text{ liter/hr} \times \$0.2/\text{liter} = \$2.5$$

Lubricants, Filters and Periodic Maintenance labor:

Use local Komatsu distributor's estimation. (For calculation example: use \$0.39)

Tires are not involved, since the machine is crawler type.

Repair Cost

Use local Komatsu distributor's estimation. (For calculation example: use \$3.30)

Repairs = \$3.30

Since the machine does not have fast wear parts like ripper points of bulldozer or cutting edge of motor grader, special item can be disregarded.

Operator hourly wage in this area is \$16.00.

Add up the fuel cost, lubricant grease filter costs, repair cost and operator's hourly wage for operating cost.

Total hourly owning and operating costs

Add up the total owning cost and total operating cost.

Estimation of The Owning & Operating Costs

OWNING & OPERATING COSTS

Example

Estimated Owning and Operating Costs :

Machine & Model :	Hydraulic Excavator PC200	
Attachments :	Standard bucket 0.8m ³ (SAE heaped)	
Delivered Price (including attachments) :		\$ 92,811
Less Tire Price :		
Front :	_____	
Rear :	_____	
Total Tire Price :	_____	
Delivered Price Less Tire :	_____	
Trade-in Value or Resale Value (optional) :	_____	\$ 9,281
Net Depreciation Value :	_____	\$ 83,530

Owning costs

Depreciation :

$$\frac{\text{Net Depreciation Value}}{\text{Depreciation Period in Hours}} = \frac{\$ 83,530}{10,000} = \underline{\hspace{2cm}} \quad \$ 8.35$$

Interest, Insurance, Taxes :

Depreciation Period : 4 Years

$$\text{Trade-in value rate (r)} = \frac{\text{Trade-in Value or Resale Value}}{\text{Delivered Price}} = \frac{9,281}{92,811} = 0.1$$

$$\text{Factor} = 1 - \frac{(n - 1)(1 - r)}{2n} = 1 - \frac{(4 - 1)(1 - 0.1)}{2 \times 4} = 0.66$$

Annual Rates : (Int. _____ % + Ins. _____ % + Taxes _____ % = _____ %) + 100 = 0.14

Approximate Annual Use : _____ Hours

$$\frac{\text{Factor} \times \text{Delivered Price} \times \text{Annual Rates}}{\text{Annual Use in Hours}} = \frac{0.66 \times 92,811 \times 0.14}{2,500} = \underline{\hspace{2cm}} \quad \$ 3.43$$

Total Owning Costs \$ 11.78

Operating costs

	Consumption	Unit cost		
Fuel :	12,5 liter / hr	\$ 0.2 / liter	x	= \$ 2.50

Lubricants, Filters and Periodic Maintenance Labor
(Ask your local Komatsu distributor) example = \$ 0.39

Tires
 $\frac{\text{Tire Price}}{\text{Estimated Life}} = \underline{\hspace{2cm}} = \underline{\hspace{2cm}}$

Repair Cost
(Ask your local Komatsu distributor) = \$ 3.30

Special items _____

Operator's Hourly Wage \$ 16.00

Total Operating Costs : \$ 22.19

Total hourly owning and operating costs

\$ 33.97

Estimation of The Owning & Operating Costs

OWNING & OPERATING COSTS

Blank sheet

Estimated Owning and Operating Costs :

Machine & Model : _____
 Attachments : _____
 Delivered Price (including attachments) : _____
 Less Tire Price : _____
 Front : _____
 Rear : _____
 Total Tire Price : _____
 Delivered Price Less Tire : _____
 Trade-in Value or Resale Value (optional) : _____
 Net Depreciation Value : _____

Owning costs

Depreciation :

$$\frac{\text{Net Depreciation Value}}{\text{Depreciation Period in Hours}} = \text{_____} = \text{_____}$$

Interest, Insurance, Taxes :

Depreciation Period : _____ Years

$$\text{Trade-in value rate (r)} = \frac{\text{Trade-in Value or Resale Value}}{\text{Delivered Price}} = \text{_____} = \text{_____}$$

$$\text{Factor} = 1 - \frac{(n - 1)(1 - r)}{2n} = \text{_____}$$

Annual Rates : (Int. _____ % + Ins. _____ % + Taxes _____ % = _____ %) ÷ 100 = _____

Approximate Annual Use : _____ Hours

$$\frac{\text{Factor} \times \text{Delivered Price} \times \text{Annual Rates}}{\text{Annual Use in Hours}} = \text{_____} \times \text{_____} = \text{_____}$$

Total Owning Costs _____

Operating costs

Consumption

Unit cost

Fuel : _____ x _____ = _____

Lubricants, Filters and Periodic Maintenance Labor

(Ask your local Komatsu distributor)

Tires

$$\frac{\text{Tire Price}}{\text{Estimated Life}} = \text{_____} = \text{_____}$$

Repair Cost

(Ask your local Komatsu distributor)

Special items _____

Operator's Hourly Wage _____

Total Operating Costs : _____

Total hourly owning and operating costs

Estimation of The Owning & Operating Costs

OWNING & OPERATING COSTS

The following tables show application and operating conditions in three categories. Condition 1 is the light duty for machine, conditions 2 is the average and Condition 3 is the severe duty. It is the guide line and can be used with fuel and tire life tables to assist to select fuel and tire costs.

Table 2-1 Application and Operating Conditions

	Condition 1	Condition 2	Condition 3
Crawler type tractors	<ul style="list-style-type: none"> • Pulling scrapers, agricultural implements. • Spreading work. 	<ul style="list-style-type: none"> • Digging, dozing, ripping of soft rock, clay, most material. • Scraper pushing • Skidding • Land clearing 	<ul style="list-style-type: none"> • Digging, dozing, ripping of hard rock.
Dozer shovels	<ul style="list-style-type: none"> • Loading of light material from stock pile with substantial Idle time. 	<ul style="list-style-type: none"> • Continuous loading from stock pile. • Light excavation and loading. 	<ul style="list-style-type: none"> • Bank excavation and loading. • Loading of blasted material.
Pipelayers	<ul style="list-style-type: none"> • Operation on stable ground, a little incline of machine. 	<ul style="list-style-type: none"> • Mainly pipe laying operation. 	<ul style="list-style-type: none"> • Operation on poor ground, or on hard rock.
Hydraulic excavators	<ul style="list-style-type: none"> • Slope finishing, light material digging, and other light-duty operation. 	<ul style="list-style-type: none"> • Mainly excavating and loading. • Breaker operation. 	<ul style="list-style-type: none"> • Excavation of hard bank.

Table 2-2 Application and Operating Conditions

	Condition 1	Condition 2	Condition 3
Rigid dump trucks	<ul style="list-style-type: none"> • Level or favorable well-maintained haul road. 	<ul style="list-style-type: none"> • Various operation at mine, quarry and construction site. 	<ul style="list-style-type: none"> • Remarkable overloading • Steep or rough (poor) haul roads. • High load factor. (See Fuel Consumption in this section)
Articulated dump trucks	<ul style="list-style-type: none"> • Level or favorable well-maintained haul road. 	<ul style="list-style-type: none"> • Steep, rough or muddy haul condition 	<ul style="list-style-type: none"> • Remarkable overloading • Remarkable steep, rough or muddy haul road
Motor graders	<ul style="list-style-type: none"> • Finishing and other light-duty operations. 	<ul style="list-style-type: none"> • Mainly road maintenance, repair and construction. • Snow removal 	<ul style="list-style-type: none"> • Maintenance or repair of hard surface road, remarkable scarifying and or ripping operation.
Compactors	<ul style="list-style-type: none"> • Spreading and compaction of sandy soil. 	<ul style="list-style-type: none"> • Spreading and compaction of various types of soil with some rocks. • Break-down of comparatively small wooden items. 	<ul style="list-style-type: none"> • Spreading and compaction of rocky material, high impact conditions. • Break-down of lumber, electrical equipment, industrial products.
Wheel loaders	<ul style="list-style-type: none"> • Loading of light material from stock pile • Operation with substantial truck waiting time. 	<ul style="list-style-type: none"> • Continuous loading from stock pile • Light-duty excavation and loading. 	<ul style="list-style-type: none"> • Bank excavation and loading. • Loading of blasted rock.
Wheel dozers	<ul style="list-style-type: none"> • Light surface finishing • Spreading light material 	<ul style="list-style-type: none"> • Average surface finishing • Digging and dozing soft earth 	<ul style="list-style-type: none"> • Digging and dozing hard earth

Table 3 Hourly Fuel Consumption

Construction
(1) Bulldozers

Machine	Range Amount	Low		Medium		High	
		U.S. Gal/hr.	ltr./hr.	U.S. Gal/hr.	ltr./hr.	U.S. Gal/hr.	ltr./hr.
D21A, P-8E0		0.4 ~ 0.85	1.6 ~ 3.2	0.85 ~ 1.3	3.2 ~ 4.8	1.3 ~ 1.7	4.8 ~ 6.4
D31EX, PX-22		0.9 ~ 1.8	3.3 ~ 6.7	1.8 ~ 2.6	6.7 ~ 10.0	2.6 ~ 3.5	10.0 ~ 13.3
D37EX, PX-22		1.0 ~ 2.0	3.8 ~ 7.6	2.0 ~ 3.0	7.6 ~ 11.4	3.0 ~ 4.0	11.4 ~ 15.1
D37EX, PX-23		0.9 ~ 1.8	3.4 ~ 6.8	1.8 ~ 2.7	6.8 ~ 10.2	2.7 ~ 3.6	10.2 ~ 13.6
D39EX, PX-22		1.2 ~ 2.4	4.5 ~ 8.9	2.4 ~ 3.5	8.9 ~ 13.4	3.5 ~ 4.7	13.4 ~ 17.9
D39EX, PX-23		1.1 ~ 2.1	4.0 ~ 8.0	2.1 ~ 3.2	8.0 ~ 12.1	3.2 ~ 4.3	12.1 ~ 16.1
D51EX, PX-22		1.4 ~ 2.8	5.2 ~ 10.5	2.8 ~ 4.1	10.5 ~ 15.7	4.1 ~ 5.5	15.7 ~ 21.0
D61EX, PX-15E0		1.7 ~ 3.4	6.4 ~ 12.9	3.4 ~ 5.1	12.9 ~ 19.3	5.1 ~ 6.8	19.3 ~ 25.7
D61EX, PX-23		1.5 ~ 3.1	5.8 ~ 11.6	3.1 ~ 4.6	16.9 ~ 17.4	4.6 ~ 6.1	17.4 ~ 23.2
D63E-12		1.8 ~ 3.7	6.9 ~ 13.9	3.7 ~ 5.5	13.9 ~ 20.8	5.5 ~ 7.3	20.8 ~ 27.7
D65E, P-12		2.1 ~ 4.1	7.8 ~ 15.6	4.1 ~ 6.2	15.6 ~ 23.4	6.2 ~ 8.2	23.4 ~ 31.1
D65EX, PX, WX-16		1.8 ~ 3.6	6.9 ~ 13.8	3.6 ~ 5.5	13.8 ~ 20.7	5.5 ~ 7.3	20.7 ~ 27.6
D65EX, PX, WX-17		1.8 ~ 3.6	6.9 ~ 13.8	3.6 ~ 5.5	13.8 ~ 20.7	5.5 ~ 7.3	20.7 ~ 27.6
D68ESS-12		1.8 ~ 3.7	6.9 ~ 13.9	3.7 ~ 5.5	13.9 ~ 20.8	5.5 ~ 7.3	20.8 ~ 27.7
D85ESS-2,2A		2.2 ~ 4.4	8.4 ~ 16.8	4.4 ~ 6.7	16.8 ~ 25.2	6.7 ~ 8.9	25.2 ~ 33.6
D85EX,PX-15E0		2.5 ~ 5.1	9.6 ~ 19.2	5.1 ~ 7.6	19.2 ~ 28.8	7.6 ~ 10.1	28.8 ~ 38.4
D85EX,PX-15R		2.5 ~ 4.9	9.4 ~ 18.7	4.9 ~ 7.4	18.7 ~ 28.1	7.4 ~ 9.9	28.1 ~ 37.5
D155A-5		3.0 ~ 5.9	11.3 ~ 22.5	5.9 ~ 8.9	22.5 ~ 33.8	8.9 ~ 11.9	33.8 ~ 45.1
D155A-6		3.3 ~ 6.6	12.5 ~ 25.0	6.6 ~ 9.9	25.0 ~ 37.5	9.9 ~ 13.2	37.5 ~ 50.0
D155AX-6		3.0 ~ 6.0	11.4 ~ 22.8	6.0 ~ 9.0	22.8 ~ 34.2	9.0 ~ 12.0	34.2 ~ 45.6
D155AX-7		3.0 ~ 6.0	11.4 ~ 22.8	6.0 ~ 9.0	22.8 ~ 34.2	9.0 ~ 12.0	34.2 ~ 45.6
D275A-5		7.7 ~ 10.9	29.2 ~ 41.3	10.9 ~ 14.1	41.3 ~ 53.5	14.1 ~ 17.4	53.5 ~ 65.7
D275A, AX-5E0		7.7 ~ 10.9	29.2 ~ 41.3	10.9 ~ 14.1	41.3 ~ 53.5	14.1 ~ 17.4	53.5 ~ 65.7
D275A-5R		7.6 ~ 10.8	28.8 ~ 40.8	10.8 ~ 13.9	40.8 ~ 52.8	13.9 ~ 17.1	52.8 ~ 64.8
D375A-5		10.6 ~ 15.0	40.2 ~ 56.9	15.0 ~ 19.5	56.9 ~ 73.7	19.5 ~ 23.9	73.7 ~ 90.4
D375A-5R		9.3 ~ 13.2	35.3 ~ 50.0	13.2 ~ 17.1	50.0 ~ 64.7	17.1 ~ 21.0	64.7 ~ 79.4
D375A-6		11.3 ~ 16.0	42.8 ~ 60.6	16.0 ~ 20.7	60.6 ~ 78.5	20.7 ~ 25.4	73.7 ~ 90.4
D375A-6R		10.4 ~ 14.7	39.2 ~ 55.6	14.7 ~ 19.0	55.6 ~ 71.9	19.0 ~ 23.3	71.9 ~ 88.3
D475A-5E0,-5SDE0		15.5 ~ 21.9	58.5 ~ 82.9	21.9 ~ 28.3	82.9 ~ 107.3	28.3 ~ 34.8	107.3 ~ 131.7
D575A-3		20.2 ~ 28.7	76.6 ~ 108.5	28.7 ~ 37.1	108.5 ~ 140.4	37.1 ~ 45.5	140.4 ~ 172.3
D575A-3SD		22.0 ~ 31.2	83.4 ~ 118.1	31.2 ~ 40.4	118.1 ~ 152.9	40.4 ~ 49.6	152.9 ~ 187.6

Low: Work where machine spend most of daily working hours idling or traveling with no load.

Medium: Average earth moving, scraper hauling, easy pushing
Object materials; Not hard to dig

High: Ripping, heavy pushing
Continuous use with engine at full throttle
Object materials; Blasted rock

(2) Pipelayers

Machine	Range Amount	Low		Medium		High	
		U.S. Gal/hr.	ltr./hr.	U.S. Gal/hr.	ltr./hr.	U.S. Gal/hr.	ltr./hr.
D85C-21		2.4 ~ 3.2	9 ~ 12	3.4 ~ 4.2	13 ~ 16	4.2 ~ 5.0	16 ~ 19
D155C-1		3.4 ~ 4.5	13 ~ 17	5.3 ~ 6.3	20 ~ 24	6.9 ~ 7.9	26 ~ 30
D355C-3		4.2 ~ 5.3	16 ~ 20	5.8 ~ 6.9	22 ~ 26	7.4 ~ 8.5	28 ~ 32

Construction

(3) Hydraulic excavators

Machine	Range Amount	Low		Medium		High	
		U.S. Gal/hr	ltr./hr	U.S. Gal/hr	ltr./hr	U.S. Gal/hr	ltr./hr
PC20MR-3	0.21 ~ 0.29	1.1 ~ 1.6	0.29 ~ 0.45	1.6 ~ 2.3	0.45 ~ 0.77	2.3 ~ 3.9	
PC27MR-3	0.34 ~ 0.48	1.3 ~ 1.8	0.48 ~ 0.71	1.8 ~ 2.7	0.71 ~ 1.19	2.7 ~ 4.5	
PC30MR-3	0.37 ~ 0.53	1.4 ~ 2.0	0.53 ~ 0.77	2.0 ~ 2.9	0.77 ~ 1.29	2.9 ~ 4.9	
PC35MR-3	0.37 ~ 0.53	1.4 ~ 2.0	0.53 ~ 0.79	2.0 ~ 3.0	0.79 ~ 1.32	3.0 ~ 5.0	
PC45MR-3	0.50 ~ 0.71	1.9 ~ 2.7	0.71 ~ 1.06	2.7 ~ 4.0	1.06 ~ 1.74	4.0 ~ 6.6	
PC55MR-3	0.50 ~ 0.71	1.9 ~ 2.7	0.71 ~ 1.06	2.7 ~ 4.0	1.06 ~ 1.74	4.0 ~ 6.6	
PC60-8	0.6 ~ 0.9	2.4 ~ 3.4	0.9 ~ 1.4	3.4 ~ 5.2	1.4 ~ 2.3	5.2 ~ 8.6	
PC70-8	0.8 ~ 1.1	2.9 ~ 4.1	1.1 ~ 1.6	4.1 ~ 6.1	1.6 ~ 2.7	6.1 ~ 10.2	
PC78US-8	0.6 ~ 0.9	2.4 ~ 3.5	0.9 ~ 1.4	3.5 ~ 5.2	1.4 ~ 2.3	5.2 ~ 8.7	
PC88MR-8	0.8 ~ 1.1	2.9 ~ 4.1	1.1 ~ 1.6	4.1 ~ 6.1	1.6 ~ 2.7	6.1 ~ 10.2	
PC110-7	1.1 ~ 1.6	4.1 ~ 5.9	1.6 ~ 2.3	5.9 ~ 8.8	2.3 ~ 3.9	8.8 ~ 14.6	
PC130, F-7	1.1 ~ 1.6	4.1 ~ 5.9	1.6 ~ 2.3	5.9 ~ 8.8	2.3 ~ 3.9	8.8 ~ 14.6	
PC130-8	1.1 ~ 1.5	4.1 ~ 5.8	1.5 ~ 2.3	5.8 ~ 8.7	2.3 ~ 3.8	8.7 ~ 14.5	
PC138US, USLC-10	1.0 ~ 1.4	3.8 ~ 5.4	1.4 ~ 2.1	5.4 ~ 8.1	2.1 ~ 3.6	8.1 ~ 13.5	
PC138US-8	1.1 ~ 1.5	4.1 ~ 5.8	1.5 ~ 2.3	5.8 ~ 8.7	2.3 ~ 3.8	8.7 ~ 14.5	
PC160LC-8	1.4 ~ 1.9	5.1 ~ 7.3	1.9 ~ 2.9	7.3 ~ 11.0	2.9 ~ 4.8	11.0 ~ 18.3	
PC190LC, NLC-8	1.4 ~ 1.9	5.1 ~ 7.3	1.9 ~ 2.9	7.3 ~ 11.0	2.9 ~ 4.8	11.0 ~ 18.3	
PC200, LC-7	1.6 ~ 2.4	6.2 ~ 8.9	2.4 ~ 3.5	8.9 ~ 13.4	3.5 ~ 5.9	13.4 ~ 22.3	
PC200, LC-8	1.6 ~ 2.2	5.9 ~ 8.5	2.2 ~ 3.4	8.5 ~ 12.7	3.4 ~ 5.6	12.7 ~ 21.2	
PC200, LC-8M0	1.4 ~ 2.0	5.4 ~ 7.7	2.0 ~ 3.1	7.7 ~ 11.6	3.1 ~ 5.1	11.6 ~ 19.3	
PC210, LC-10	1.4 ~ 2.0	5.3 ~ 7.6	2.0 ~ 3.1	7.6 ~ 11.4	3.1 ~ 5.1	11.4 ~ 19.0	
HB205, 215LC-1	1.3 ~ 1.9	5.0 ~ 7.1	1.9 ~ 2.8	7.1 ~ 10.6	2.8 ~ 4.7	10.6 ~ 17.7	
PC220, LC-7	2.0 ~ 2.9	7.5 ~ 10.8	2.9 ~ 4.3	10.8 ~ 16.2	4.3 ~ 7.1	16.2 ~ 26.9	
PC220, LC-8	1.9 ~ 2.7	7.1 ~ 10.3	2.7 ~ 4.1	10.3 ~ 15.4	4.1 ~ 6.8	15.4 ~ 25.6	
PC220, LC-8M0	1.8 ~ 2.6	7.0 ~ 10.0	2.6 ~ 4.0	10.0 ~ 15.0	4.0 ~ 6.6	15.0 ~ 25.0	
PC228US, USLC-8	1.7 ~ 2.4	6.3 ~ 9.0	2.4 ~ 3.6	9.0 ~ 13.5	3.6 ~ 5.9	13.5 ~ 22.5	
PC240LC, NLC-10	1.8 ~ 2.6	6.8 ~ 9.7	2.6 ~ 3.9	9.7 ~ 14.6	3.9 ~ 6.4	14.6 ~ 24.4	
PC270-7	2.1 ~ 3.1	8.1 ~ 11.6	3.1 ~ 4.6	11.6 ~ 17.4	4.6 ~ 7.7	17.4 ~ 29.0	
PC270, LC-8	2.1 ~ 3.1	8.1 ~ 11.6	3.1 ~ 4.6	11.6 ~ 17.4	4.6 ~ 7.7	17.4 ~ 28.9	
PC290LC-10	2.1 ~ 3.0	7.9 ~ 11.3	3.0 ~ 4.5	11.3 ~ 16.9	4.5 ~ 7.4	16.9 ~ 28.2	
PC300, LC-7, PC350LC-7	2.9 ~ 4.1	10.8 ~ 15.4	4.1 ~ 6.1	15.4 ~ 23.1	6.1 ~ 10.2	23.1 ~ 38.5	
PC300, LC-8, PC350LC-8	2.8 ~ 4.0	10.6 ~ 15.1	4.0 ~ 6.0	15.1 ~ 22.7	6.0 ~ 10.0	22.7 ~ 37.9	
PC360LC, NLC-10	2.6 ~ 3.8	10.0 ~ 14.3	3.8 ~ 5.7	14.3 ~ 21.5	5.7 ~ 9.5	21.5 ~ 35.8	
PC400, LC-7, PC450LC-7	5.1 ~ 6.8	19.3 ~ 25.7	6.8 ~ 8.5	25.7 ~ 32.1	8.5 ~ 12.7	32.1 ~ 48.2	
PC400, LC-8, PC450LC-8	5.1 ~ 6.8	19.3 ~ 25.7	6.8 ~ 8.5	25.7 ~ 32.1	8.5 ~ 12.7	32.1 ~ 48.2	
PC400, LC-8R, PC450LC-8R	5.1 ~ 6.8	19.3 ~ 25.7	6.8 ~ 8.5	25.7 ~ 32.1	8.5 ~ 12.7	32.1 ~ 48.2	
PC490, LC, NLC-10	5.0 ~ 6.7	19.1 ~ 25.5	6.7 ~ 8.4	25.5 ~ 31.9	8.4 ~ 12.6	31.9 ~ 47.8	
PC550LC-8	5.2 ~ 6.9	19.5 ~ 26.0	6.9 ~ 8.6	26.0 ~ 32.5	8.6 ~ 12.9	32.5 ~ 48.7	
PC600, LC-7	5.2 ~ 8.2	23.4 ~ 31.2	8.2 ~ 10.3	31.2 ~ 39.0	10.3 ~ 16.5	39.0 ~ 62.4	
PC600, LC-8E0, PC650LC-8E0	6.5 ~ 8.6	24.5 ~ 32.7	8.6 ~ 10.8	32.7 ~ 40.8	10.8 ~ 17.3	40.8 ~ 65.3	
PC600, LC-8R1	6.5 ~ 8.6	24.5 ~ 32.7	8.6 ~ 10.8	32.7 ~ 40.8	10.8 ~ 17.3	40.8 ~ 65.3	
PC700LC-8E0, R	6.5 ~ 8.6	24.5 ~ 32.7	8.6 ~ 10.8	32.7 ~ 40.8	10.8 ~ 17.3	40.8 ~ 65.3	
PC750, LC-7, PC800-7	6.7 ~ 9.0	25.6 ~ 34.1	9.0 ~ 11.3	34.1 ~ 42.6	11.3 ~ 18.0	42.6 ~ 68.2	
PC800, LC-8E0, PC850LC-8E0	6.7 ~ 8.9	25.2 ~ 33.7	8.9 ~ 11.1	33.7 ~ 42.1	11.1 ~ 17.8	42.1 ~ 67.3	
PC800, LC-8R, PC850LC-8R	6.7 ~ 8.9	25.2 ~ 33.7	8.9 ~ 11.1	33.7 ~ 42.1	11.1 ~ 17.8	42.1 ~ 67.3	
PC1250, SP-7	9.5 ~ 12.7	36.0 ~ 48.0	12.7 ~ 15.8	48.0 ~ 59.9	15.8 ~ 25.3	59.9 ~ 95.9	
PC1250, LC, SP-8	9.4 ~ 12.6	35.7 ~ 47.6	12.6 ~ 15.7	47.6 ~ 59.6	15.7 ~ 25.2	59.6 ~ 95.3	
PC1250, LC, SP-8R	9.0 ~ 12.1	34.2 ~ 45.7	12.1 ~ 15.1	45.7 ~ 57.1	15.1 ~ 24.1	57.1 ~ 91.3	
PC2000-8	12.6 ~ 16.8	47.7 ~ 63.6	16.8 ~ 21.0	63.6 ~ 79.5	21.0 ~ 33.6	79.5 ~ 127.1	

Low: Intermittent work with job efficiency less than 65 %
Material; Easy to excavate

Medium: Digging and loading 65 - 80 % of machine operation hours
Material; Not easy to excavate

High: Work with job efficiency more than 80 %
Direct excavation needed sometimes.

Fuel Consumption

OWNING & OPERATING COSTS

Model	Fuel consumption			
	Easy	Average	Rather difficult	Difficult
PC3000-6	161 (42.5)	172 (45.4)	184 (48.6)	208 (55.0)
PC4000-6	228 (60.2)	244 (64.5)	260 (68.7)	293 (77.4)
PC5000-6	306 (80.8)	328 (86.7)	350 (92.5)	393 (103.8)
PC8000-6	515 (136.1)	552 (145.8)	589 (155.6)	662 (174.9)

Construction

(4) Off-highway dump trucks

Machine	Range	Low		Medium		High	
	Amount	U.S. Gal/hr	ltr./hr	U.S. Gal/hr	ltr./hr	U.S. Gal/hr	ltr./hr
HD255-5		3.4 ~ 5.0	12.7 ~ 19.0	5.0 ~ 6.7	19.0 ~ 25.4	6.7 ~ 9.2	25.4 ~ 34.9
HD325-6		5.0 ~ 7.5	18.8 ~ 28.3	7.5 ~ 10.0	28.3 ~ 37.7	10.0 ~ 13.7	37.7 ~ 51.8
HD325-7		4.8 ~ 7.2	18.0 ~ 27.1	7.2 ~ 9.9	27.1 ~ 37.4	9.9 ~ 13.6	37.4 ~ 51.5
HD325-7R		4.7 ~ 7.1	17.9 ~ 26.8	7.1 ~ 9.8	26.8 ~ 37.2	9.8 ~ 13.6	37.2 ~ 51.4
HD405-6		5.0 ~ 7.5	18.8 ~ 28.3	7.5 ~ 10.0	28.3 ~ 37.7	10.0 ~ 13.7	37.7 ~ 51.8
HD405-7		4.8 ~ 7.2	18.0 ~ 27.1	7.2 ~ 9.9	27.1 ~ 37.4	9.9 ~ 13.6	37.4 ~ 51.5
HD405-7R		4.7 ~ 7.1	17.9 ~ 26.8	7.1 ~ 9.8	26.8 ~ 37.2	9.8 ~ 13.6	37.2 ~ 51.4
HD465-7		7.6 ~ 11.4	28.7 ~ 43.0	11.4 ~ 15.2	43.0 ~ 57.4	15.2 ~ 20.8	57.4 ~ 78.9
HD465-7E0		7.0 ~ 10.5	26.4 ~ 39.8	10.5 ~ 14.2	39.8 ~ 53.7	14.2 ~ 20.6	53.7 ~ 78.1
HD465-7R		6.9 ~ 10.4	26.3 ~ 39.5	10.4 ~ 14.1	39.5 ~ 53.5	14.1 ~ 20.6	53.5 ~ 78.1
HD605-7E0		7.0 ~ 10.5	26.4 ~ 39.8	10.5 ~ 14.2	39.8 ~ 53.7	14.2 ~ 20.6	53.7 ~ 78.1
HD465-7R		6.9 ~ 10.4	26.3 ~ 39.5	10.4 ~ 14.1	39.5 ~ 53.5	14.1 ~ 20.6	53.5 ~ 78.1
HD785-7		10.2 ~ 15.2	38.5 ~ 57.7	15.2 ~ 20.4	57.7 ~ 77.3	20.4 ~ 28.6	77.3 ~ 108.2
HD1500-7 (SDA12V160 Tier 1)		14.8 ~ 18.6	56.2 ~ 70.3	18.6 ~ 26.0	70.3 ~ 98.4	26.0 ~ 35.7	98.4 ~ 135.0
HD1500-7* (SDA16V159E Tier 2)		15.6 ~ 19.5	59.0 ~ 73.7	19.5 ~ 27.3	73.7 ~ 103.2	27.3 ~ 37.4	103.2 ~ 141.5
730E		19.1 ~ 23.8	72.2 ~ 90.2	23.8 ~ 33.4	90.2 ~ 126.3	33.4 ~ 45.8	126.3 ~ 173.2
830E-AC (SDA16V160 Tier 1)		24.8 ~ 31.0	93.9 ~ 117.4	31.0 ~ 43.4	117.4 ~ 164.4	43.4 ~ 59.6	164.4 ~ 225.4
830E-AC (SDA16V160 Tier 2)		25.8 ~ 32.2	97.6 ~ 122.0	32.2 ~ 45.2	122.0 ~ 170.9	45.2 ~ 61.9	170.9 ~ 234.3
860E-1K (SSDA16V160 Tier 1)		26.8 ~ 33.5	101.4 ~ 126.8	33.5 ~ 46.9	126.8 ~ 177.5	46.9 ~ 64.3	177.5 ~ 243.5
860E-1K (SSDA16V160 Tier 2)		27.2 ~ 33.9	102.8 ~ 128.5	33.9 ~ 47.5	128.5 ~ 179.9	47.5 ~ 65.2	179.9 ~ 246.7
930E-4 (SSDA16V160 Tier 1)		26.8 ~ 33.5	101.4 ~ 126.8	33.5 ~ 46.9	126.8 ~ 177.5	46.9 ~ 64.3	177.5 ~ 243.5
930E-4 (SSDA16V160 Tier 2)		27.2 ~ 33.9	102.8 ~ 128.5	33.9 ~ 47.5	128.5 ~ 179.9	47.5 ~ 65.2	179.9 ~ 246.7
930E-4SE		35.2 ~ 44.3	134.1 ~ 167.6	44.3 ~ 62.0	167.6 ~ 234.7	62.0 ~ 85.0	234.7 ~ 321.8
960E-2 (SSDA18V170 Tier 1)		33.8 ~ 42.3	128.0 ~ 160.0	42.3 ~ 59.2	160.0 ~ 224.1	59.2 ~ 81.2	224.1 ~ 307.3
960E-2 (SSDA18V170 Tier 2)		35.2 ~ 44.3	134.1 ~ 167.6	44.3 ~ 62.0	167.6 ~ 234.7	62.0 ~ 85.0	234.7 ~ 321.8
960E-2K (SSDA18V170 Tier 1)		33.8 ~ 42.3	128.0 ~ 160.0	42.3 ~ 59.2	160.0 ~ 224.1	59.2 ~ 81.2	224.1 ~ 307.3
960E-2K (SSDA18V170 Tier 2)		35.2 ~ 44.3	134.1 ~ 167.6	44.3 ~ 62.0	167.6 ~ 234.7	62.0 ~ 85.0	234.7 ~ 321.8

CONDITIONS:

- Low : High ratio of loading time to cycle time, good haul road conditions
Low truck job efficiency
- Medium : Medium ratio of traveling time to cycle time, medium load factor of truck, and medium haul road conditions and grade
Total resistance; Over 2 % through 10 %
- High : High ratio of traveling time to cycle time, tough load factor of truck, severe haul road conditions and grade
Total resistance; 10 % and above
- * : USA source

Construction

(5) Articulated dump trucks

Range Machine	Low		Medium		High	
	U.S. Gal/hr	ltr./hr	U.S. Gal/hr	ltr./hr	U.S. Gal/hr	ltr./hr
HM300-1	3.4 ~ 5.1	12.8 ~ 19.3	5.1 ~ 6.8	19.3 ~ 25.7	6.8 ~ 9.3	25.7 ~ 35.3
HM300-2	3.5 ~ 5.2	13.1 ~ 19.7	5.2 ~ 6.9	19.7 ~ 26.2	6.9 ~ 9.5	26.2 ~ 36.1
HM300-2R	3.5 ~ 5.2	13.1 ~ 19.7	5.2 ~ 6.9	19.7 ~ 26.2	6.9 ~ 9.5	26.2 ~ 36.1
HM300-3	2.8 ~ 4.4	10.6 ~ 16.8	4.4 ~ 5.6	16.8 ~ 21.3	5.6 ~ 8.9	21.3 ~ 33.7
HM350-1	4.1 ~ 6.1	15.4 ~ 23.1	6.1 ~ 8.1	23.1 ~ 30.8	8.1 ~ 11.2	30.8 ~ 42.3
HM350-2	4.4 ~ 6.6	16.5 ~ 24.8	6.6 ~ 8.7	24.8 ~ 33.1	8.7 ~ 12.0	33.1 ~ 45.5
HM350-2R	4.4 ~ 6.6	16.5 ~ 24.8	6.6 ~ 8.7	24.8 ~ 33.1	8.7 ~ 12.0	33.1 ~ 45.5
HM400-1	4.5 ~ 6.7	17.0 ~ 25.5	6.7 ~ 9.0	25.5 ~ 34.0	9.0 ~ 12.4	34.0 ~ 46.8
HM400-2	4.6 ~ 7.0	17.6 ~ 26.4	7.0 ~ 9.3	26.4 ~ 35.2	9.3 ~ 12.8	35.2 ~ 48.3
HM400-2R	4.6 ~ 7.0	17.6 ~ 26.4	7.0 ~ 9.3	26.4 ~ 35.2	9.3 ~ 12.8	35.2 ~ 48.3
HM400-3	4.4 ~ 5.5	16.7 ~ 21.0	5.5 ~ 7.9	21.0 ~ 29.9	7.9 ~ 11.8	29.9 ~ 44.7

CONDITIONS:

Low : Long loading time, downhill travel with load, travel on well maintained road

Medium : Normal loading time , uphill travel with load (normal grade), travel on well maintained road

High : Short loading time, uphill travel with load (steep grade), travel on normally maintained road

Construction

(6) Wheel loaders

Range Machine Amount	Low		Medium		High	
	U.S. Gal/hr	ltr./hr	U.S. Gal/hr	ltr./hr	U.S. Gal/hr	ltr./hr
WA150-5	1.2 ~ 1.7	4.5 ~ 6.3	1.7 ~ 2.1	6.3 ~ 7.9	2.1 ~ 2.9	7.9 ~ 11.0
WA150, PZ-6	1.2 ~ 1.7	4.7 ~ 6.5	1.7 ~ 2.2	6.5 ~ 8.2	2.2 ~ 3.0	8.2 ~ 11.4
WA200-5	1.6 ~ 2.2	5.9 ~ 8.3	2.2 ~ 2.7	8.3 ~ 10.4	2.7 ~ 3.8	10.4 ~ 14.5
WA200,PZ-6	1.6 ~ 2.2	5.9 ~ 8.3	2.2 ~ 2.7	8.3 ~ 10.4	2.7 ~ 3.8	10.4 ~ 14.4
WA250-5	1.8 ~ 2.6	7.0 ~ 9.8	2.6 ~ 3.2	9.8 ~ 12.3	3.2 ~ 4.3	12.3 ~ 16.2
WA250, PZ-6	1.8 ~ 2.5	6.9 ~ 9.6	2.5 ~ 3.2	9.6 ~ 12.1	3.2 ~ 4.2	12.1 ~ 15.9
WA320-3 (Custom)	2.6 ~ 3.6	9.8 ~ 13.7	3.6 ~ 4.5	13.7 ~ 17.2	4.5 ~ 6.0	17.2 ~ 22.7
WA320-5	2.2 ~ 3.0	8.2 ~ 11.5	3.0 ~ 3.8	11.5 ~ 14.5	3.8 ~ 5.0	14.5 ~ 19.1
WA320, PZ-6	2.2 ~ 3.0	8.2 ~ 11.5	3.0 ~ 3.8	11.5 ~ 14.4	3.8 ~ 5.0	14.4 ~ 19.0
WA380-3	3.0 ~ 4.2	11.4 ~ 16.0	4.2 ~ 5.3	16.0 ~ 20.1	5.3 ~ 7.0	20.1 ~ 26.5
WA380-5	2.9 ~ 4.0	10.8 ~ 15.2	4.0 ~ 5.0	15.2 ~ 19.1	5.0 ~ 6.6	19.1 ~ 25.1
WA380,Z-6	2.4 ~ 3.4	9.1 ~ 12.8	3.4 ~ 4.3	12.8 ~ 16.1	4.3 ~ 5.8	16.1 ~ 22.1
WA380-7	2.1 ~ 2.9	7.9 ~ 11.1	2.9 ~ 3.7	11.1 ~ 14.0	3.7 ~ 5.1	14.0 ~ 19.2
WA430-5	3.3 ~ 4.6	12.5 ~ 17.6	4.6 ~ 5.8	17.6 ~ 22.1	5.8 ~ 7.7	22.1 ~ 29.1
WA430-6	2.8 ~ 4.1	10.7 ~ 15.4	4.1 ~ 5.1	15.4 ~ 19.2	5.1 ~ 6.8	19.2 ~ 25.8
WA470-3	4.0 ~ 5.5	15.0 ~ 21.0	5.5 ~ 6.9	21.0 ~ 26.3	6.9 ~ 9.2	26.3 ~ 34.7
WA470-5	3.5 ~ 4.8	13.1 ~ 18.3	4.8 ~ 6.1	18.3 ~ 23.0	6.1 ~ 8.0	23.0 ~ 30.3
WA470-6*	2.9 ~ 4.1	11.0 ~ 15.5	4.1 ~ 5.1	15.5 ~ 19.3	5.1 ~ 7.1	19.3 ~ 27.0
WA470-7	2.7 ~ 3.8	10.2 ~ 14.4	3.8 ~ 4.7	14.4 ~ 17.9	4.7 ~ 6.6	17.9 ~ 25.1
WA480-6*	3.1 ~ 4.3	11.6 ~ 16.2	4.3 ~ 5.4	16.2 ~ 20.4	5.4 ~ 7.8	20.4 ~ 29.6
WA500-3	5.5 ~ 7.7	20.9 ~ 29.3	7.7 ~ 9.8	29.3 ~ 37.0	9.8 ~ 12.9	37.0 ~ 48.8
WA500-6	4.9 ~ 6.9	18.7 ~ 26.2	6.9 ~ 8.7	26.2 ~ 33.1	8.7 ~ 12.0	33.1 ~ 45.6
WA500-6R	4.9 ~ 6.9	18.7 ~ 26.2	6.9 ~ 8.7	26.2 ~ 33.1	8.7 ~ 12.0	33.1 ~ 45.6
WA500-7	4.6 ~ 6.4	17.4 ~ 24.3	6.4 ~ 8.1	24.3 ~ 30.7	8.1 ~ 11.3	30.7 ~ 42.6
WA600-3	8.2 ~ 11.5	31.1 ~ 43.5	11.5 ~ 14.5	43.5 ~ 54.9	14.5 ~ 19.2	54.9 ~ 72.5
WA600-6	7.9 ~ 10.6	30.0 ~ 40.2	10.6 ~ 12.7	40.2 ~ 51.9	13.7 ~ 18.9	51.9 ~ 71.6
WA600-6R	7.9 ~ 10.6	30.0 ~ 40.2	10.6 ~ 12.7	40.2 ~ 51.9	13.7 ~ 18.9	51.9 ~ 71.6
WA700-3	10.3 ~ 14.5	39.1 ~ 54.8	14.5 ~ 18.3	54.8 ~ 69.1	18.3 ~ 24.1	69.1 ~ 91.3
WA800-3	11.8 ~ 16.5	44.6 ~ 62.5	16.5 ~ 20.8	62.5 ~ 78.9	20.8 ~ 31.4	78.9 ~ 119.0
WA800-3E0	11.8 ~ 16.5	44.6 ~ 62.5	16.5 ~ 20.8	62.5 ~ 78.9	20.8 ~ 31.4	78.9 ~ 119.0
WA900-3	12.3 ~ 17.2	46.5 ~ 65.1	17.2 ~ 21.7	65.1 ~ 82.1	21.7 ~ 28.7	82.1 ~ 124.0
WA900-3E0	12.5 ~ 17.5	47.3 ~ 66.2	17.5 ~ 22.1	66.2 ~ 83.5	22.1 ~ 33.3	83.5 ~ 126.1
WA1200-6	26.9 ~ 37.7	102.0 ~ 142.7	37.7 ~ 47.6	142.7 ~ 180.1	47.6 ~ 59.6	180.1 ~ 225.4

CONDITIONS:

- Low : Light utility, work with considerable amount of idling
- Medium : Non-stop operation over a long distance
Operation according to a basic loader cycle with frequent idling
- High : Non-stop operation according to a basic loader cycle
- * : With large-capacity torque convertor

(7) Wheel dozers

Range Machine Amount	Low		Medium		High	
	U.S. Gal/hr	ltr./hr	U.S. Gal/hr	ltr./hr	U.S. Gal/hr	ltr./hr
WD600-3	8.6 ~ 12.0	32.4 ~ 45.3	12.0 ~ 15.1	45.3 ~ 57.2	15.1 ~ 19.9	57.2 ~ 75.5
WD600-6	7.8 ~ 10.9	29.4 ~ 41.1	10.9 ~ 13.7	41.1 ~ 51.9	13.7 ~ 18.1	51.9 ~ 68.5
WD900-3	13.5 ~ 18.9	51.2 ~ 71.7	18.9 ~ 23.9	71.7 ~ 90.5	23.9 ~ 31.6	90.5 ~ 119.5

CONDITIONS:

- Low : Work where machine spend most of operation hours idling or traveling with no load
- Medium : Average earth moving, scraper hauling, easy pushing
- High : Heavy pushing
Continuous operation

**Construction
(8) Motor graders**

Machine	Range	Low		Medium		High	
	Amount	U.S. Gal/hr	ltr./hr	U.S. Gal/hr	ltr./hr	U.S. Gal/hr	ltr./hr
GD511A-1		2.0 ~ 3.2	7.5 ~ 12.0	3.2 ~ 4.4	12.0 ~ 16.5	4.4 ~ 5.5	16.5 ~ 21.0
GD555-3		2.3 ~ 3.7	8.8 ~ 14.0	3.7 ~ 5.1	14.0 ~ 19.3	5.1 ~ 6.5	19.3 ~ 24.6
GD555-5		2.7 ~ 4.3	10.1 ~ 16.2	4.3 ~ 5.9	16.2 ~ 22.3	5.9 ~ 7.5	22.3 ~ 28.4
GD655-5		3.0 ~ 4.8	11.5 ~ 18.3	4.8 ~ 6.7	18.3 ~ 25.2	6.7 ~ 8.5	25.2 ~ 32.1
GD663A-2		2.1 ~ 3.4	8.0 ~ 12.8	3.4 ~ 4.6	12.8 ~ 17.6	4.6 ~ 5.9	17.6 ~ 22.4
GD675-5		3.0 ~ 4.8	11.5 ~ 18.3	4.8 ~ 6.7	18.3 ~ 25.2	6.7 ~ 8.5	25.2 ~ 32.1
GD705A-4		2.5 ~ 4.0	9.5 ~ 15.1	4.0 ~ 5.5	15.1 ~ 20.8	5.5 ~ 7.0	20.8 ~ 26.5
GD755-5R		3.7 ~ 5.9	14.0 ~ 22.5	5.9 ~ 8.2	22.5 ~ 30.9	8.2 ~ 10.4	30.9 ~ 39.3
GD825A-2		3.7 ~ 6.0	14.1 ~ 22.6	6.0 ~ 8.2	22.6 ~ 31.0	8.2 ~ 10.4	31.0 ~ 39.5

CONDITIONS:

- Low: Minor road maintenance, leveling, traveling with no load
- Medium: Average road maintenance, scarifying, light snow removal
- High: Heavy pushing, continuous operation

Table 3 Hourly Fuel Consumption

Mining

(1) Bulldozers

Range Machine Amount	Low		Medium		High	
	U.S. Gal/hr	ltr./hr	U.S. Gal/hr	ltr./hr	U.S. Gal/hr	ltr./hr
D275A-5	9.3 ~ 12.8	35.3 ~ 48.5	12.8 ~ 17.5	48.5 ~ 66.1	17.5 ~ 21.0	66.1 ~ 79.4
D275AX-5E0	9.5 ~ 12.8	35.8 ~ 48.3	12.8 ~ 17.5	48.3 ~ 66.1	17.5 ~ 20.8	66.2 ~ 78.7
D275A-5R	9.3 ~ 12.7	35.3 ~ 48.2	12.7 ~ 17.5	48.2 ~ 66.2	17.5 ~ 21.0	66.2 ~ 79.4
D375A-5	12.9 ~ 17.5	48.7 ~ 66.2	17.5 ~ 24.1	66.2 ~ 91.2	24.1 ~ 29.0	91.2 ~ 109.9
D375A-5R	12.2 ~ 16.7	46.3 ~ 63.2	16.7 ~ 23.0	63.2 ~ 86.9	23.0 ~ 27.7	86.9 ~ 105.0
D375A-6	13.1 ~ 18.0	49.6 ~ 68.2	18.0 ~ 24.6	68.2 ~ 93.0	24.6 ~ 29.5	93.0 ~ 111.6
D375A-6R	12.6 ~ 17.4	47.8 ~ 65.7	17.4 ~ 23.7	65.7 ~ 89.6	23.7 ~ 28.4	89.6 ~ 107.5
D475A-5E0, ASD-5E0	18.0 ~ 24.7	68.0 ~ 93.5	24.7 ~ 33.7	93.5 ~ 127.5	33.7 ~ 40.4	127.5 ~ 153.0
D575A-3	24.2 ~ 33.3	91.6 ~ 125.9	33.3 ~ 45.4	125.9 ~ 171.7	45.4 ~ 54.4	171.7 ~ 206.0
D575A-3SD	26.2 ~ 36.0	99.1 ~ 136.3	36.0 ~ 49.1	136.3 ~ 185.8	49.1 ~ 58.9	185.8 ~ 223.0

CONDITIONS:

- Low : Machine movement is mainly consisting of idle running or traveling unloaded
- Medium : Average earth moving, scraper hauling or easy pushing operation
Ripping ratio more than 50%
- High : Ripping, heavy pushing, and operation continued without rest at full horsepower

(2) Hydraulic excavators

Range Machine Amount	Low		Medium		High	
	U.S. Gal/hr	ltr./hr	U.S. Gal/hr	ltr./hr	U.S. Gal/hr	ltr./hr
PC1250, LC, SP-7	9.9 ~ 14.9	37.6 ~ 56.3	14.9 ~ 19.8	56.3 ~ 75.1	19.8 ~ 26.5	75.1 ~ 100.2
PC1250, LC, SP-8	10.1 ~ 14.7	38.1 ~ 55.8	14.7 ~ 19.8	55.8 ~ 74.9	19.8 ~ 26.4	74.9 ~ 100.1
PC1250, SP-8R	9.5 ~ 13.8	35.8 ~ 52.4	13.8 ~ 18.5	52.4 ~ 70.2	18.5 ~ 24.8	70.2 ~ 93.9
PC2000-8	12.5 ~ 18.7	47.2 ~ 70.8	18.7 ~ 29.4	70.8 ~ 94.4	29.4 ~ 33.2	94.4 ~ 125.8

CONDITIONS:

- Low : Digging account for less than 50% in daily working hours
Loading of low density materials
Unnecessary for big digging force
- Medium : Digging account for 60-85% in daily working hours
After blasting or after dozing
Small rock suitable for the bucket size
- High : Digging account for more than 85% in daily work hours
Direct digging
Heavy duty digging after blasting

Model	Fuel consumption			
	Easy	Average	Rather difficult	Difficult
PC3000-6	161 (42.5)	172 (45.4)	184 (48.6)	208 (55.0)
PC4000-6	228 (60.2)	244 (64.5)	260 (68.7)	293 (77.4)
PC5000-6	306 (80.8)	328 (86.7)	350 (92.5)	393 (103.8)
PC8000-6	515 (136.1)	552 (145.8)	589 (155.6)	662 (174.9)

Mining

(3) Off-highway dump trucks

Machine	Range	Low		Medium		High	
	Amount	U.S. Gal/hr	ltr./hr	U.S. Gal/hr	ltr./hr	U.S. Gal/hr	ltr./hr
HD785-7		9.9 ~ 17.3	37.3 ~ 65.5	17.3 ~ 22.1	65.5 ~ 83.6	22.1 ~ 26.8	83.6 ~ 101.6
HD1500-7 (SDA12V160 Tier 1)		14.8 ~ 18.6	56.2 ~ 70.3	18.6 ~ 26.0	70.3 ~ 98.4	26.0 ~ 35.7	98.4 ~ 135.0
HD1500-7* (SDA16V159E Tier 2)		15.6 ~ 19.5	59.0 ~ 73.7	19.5 ~ 27.3	73.7 ~ 103.2	27.3 ~ 37.4	103.2 ~ 141.5
730E		19.1 ~ 23.8	72.2 ~ 90.2	23.8 ~ 33.4	90.2 ~ 126.3	33.4 ~ 45.8	126.3 ~ 173.2
830E-AC (SDA16V160 Tier 1)		24.8 ~ 31.0	93.9 ~ 117.4	31.0 ~ 43.4	117.4 ~ 164.4	43.4 ~ 59.6	164.4 ~ 225.4
830E-AC (SDA16V160 Tier 2)		25.8 ~ 32.2	97.6 ~ 122.0	32.2 ~ 45.2	122.0 ~ 170.9	45.2 ~ 61.9	170.9 ~ 234.3
860E-1K (SSDA16V160 Tier 1)		26.8 ~ 33.5	101.4 ~ 126.8	33.5 ~ 46.9	126.8 ~ 177.5	46.9 ~ 64.3	177.5 ~ 243.5
860E-1K (SSDA16V160 Tier 2)		27.2 ~ 33.9	102.8 ~ 128.5	33.9 ~ 47.5	128.5 ~ 179.9	47.5 ~ 65.2	179.9 ~ 246.7
930E-4 (SSDA16V160 Tier 1)		26.8 ~ 33.5	101.4 ~ 126.8	33.5 ~ 46.9	126.8 ~ 177.5	46.9 ~ 64.3	177.5 ~ 243.5
930E-4 (SSDA16V160 Tier 2)		27.2 ~ 33.9	102.8 ~ 128.5	33.9 ~ 47.5	128.5 ~ 179.9	47.5 ~ 65.2	179.9 ~ 246.7
930E-4SE		35.2 ~ 44.3	134.1 ~ 167.6	44.3 ~ 62.0	167.6 ~ 234.7	62.0 ~ 85.0	234.7 ~ 321.8
960E-2 (SSDA18V170 Tier 1)		33.8 ~ 42.3	128.0 ~ 160.0	42.3 ~ 59.2	160.0 ~ 224.1	59.2 ~ 81.2	224.1 ~ 307.3
960E-2 (SSDA18V170 Tier 2)		35.2 ~ 44.3	134.1 ~ 167.6	44.3 ~ 62.0	167.6 ~ 234.7	62.0 ~ 85.0	234.7 ~ 321.8
960E-2K (SSDA18V170 Tier 1)		33.8 ~ 42.3	128.0 ~ 160.0	42.3 ~ 59.2	160.0 ~ 224.1	59.2 ~ 81.2	224.1 ~ 307.3
960E-2K (SSDA18V170 Tier 2)		35.2 ~ 44.3	134.1 ~ 167.6	44.3 ~ 62.0	167.6 ~ 234.7	62.0 ~ 85.0	234.7 ~ 321.8

CONDITIONS:

Low : Variable travel times with the majority of the travel time attributed to segments with total resistance less than 4%
Abnormal operating efficiency with significant periods of wait time or delays

Medium : Average travel times with a balance between travel time along routes in excess of 10% total resistance and routes less than 4% in total resistance
Normal operating efficiency with occasional periods of wait time or delays

High : Long travel times with the majority of the travel time attributed to road segments in excess of 10% total resistance
Highly efficient applications with minimum delay or wait periods

* : USA source

Mining

(4) Wheel loaders

Machine	Range	Low		Medium		High	
	Amount	U.S. Gal/hr	ltr./hr	U.S. Gal/hr	ltr./hr	U.S. Gal/hr	ltr./hr
WA800-3		12.4 ~ 17.4	47.1 ~ 66.0	17.4 ~ 22.0	66.0 ~ 83.2	22.0 ~ 33.2	83.2 ~ 125.7
WA800-3E0		12.2 ~ 17.0	46.3 ~ 64.4	17.0 ~ 21.6	64.4 ~ 81.7	21.6 ~ 32.8	81.7 ~ 124.1
WA900-3		12.9 ~ 18.1	48.9 ~ 68.5	18.1 ~ 22.8	68.5 ~ 86.5	22.8 ~ 34.5	86.5 ~ 130.5
WA900-3E0		12.5 ~ 17.4	47.4 ~ 65.9	17.4 ~ 22.3	65.9 ~ 84.4	22.3 ~ 33.9	84.4 ~ 128.3
WA1200-6		26.9 ~ 37.7	102.0 ~ 142.7	37.7 ~ 47.6	142.7 ~ 180.1	47.6 ~ 59.6	180.1 ~ 225.4

CONDITIONS:

Low : Low production aggregate truck loading, large amount of idling time

Medium : Loading to stock-pile dump trucks
Short time waiting hours for dump trucks

High : Continuous loading
Short time waiting hours for dump trucks
Digging hard bank
Takes a lot of time for digging
Load and carry operation with high productivity

(5) Wheel dozers

Machine	Range	Low		Medium		High	
	Amount	U.S. Gal/hr	ltr./hr	U.S. Gal/hr	ltr./hr	U.S. Gal/hr	ltr./hr
WD600-3		9.2 ~ 12.9	34.8 ~ 48.8	12.9 ~ 16.2	48.8 ~ 61.5	16.2 ~ 21.5	61.5 ~ 81.3
WD600-6		8.7 ~ 12.1	32.8 ~ 45.9	12.1 ~ 15.3	45.9 ~ 58.0	15.3 ~ 20.2	58.0 ~ 76.6
WD900-3		12.5 ~ 17.5	47.2 ~ 66.1	17.5 ~ 22.0	66.1 ~ 83.4	22.0 ~ 29.1	83.4 ~ 110.1

CONDITIONS:

Low : Cleaning a surface of a hauling road, ground around large shovels and hoppers (collecting fallen stones).

Medium : Stock piling
Dozing of crushing rock

High : Reclamation
Dozing after digging
Pusher using scraper

(6) Motor graders

Machine	Range	Low		Medium		High	
	Amount	U.S. Gal/hr	ltr./hr	U.S. Gal/hr	ltr./hr	U.S. Gal/hr	ltr./hr
GD825A-2		4.0 ~ 6.5	15.3 ~ 24.5	6.5 ~ 8.9	24.5 ~ 33.7	8.9 ~ 11.3	33.7 ~ 42.9

CONDITIONS:

Low : Traveling Finishing
Grading of light materials

Medium : Light duty road maintenance
Scarifying

High : Ripping
Heavy duty road maintenance

Table 4 Approx. Hourly Lubricants Consumption *
(* Oil replacement (liter) ÷ Oil change interval (hour))

(1) Bulldozers

Application Unit Q'TY	*(1) Crank case		*(2) Transmission		Final Drives		Hydraulic Control		Grease	
	US Gal	Liter	US Gal	Liter	US Gal	Liter	US Gal	Liter	lb	kg
D31EX, PX-22	0.006	0.022	—	—	0.002	0.007	0.008	0.03	0.04	0.02
D37EX, PX-22	0.006	0.022	—	—	0.002	0.007	0.008	0.03	0.04	0.02
D37EX, PX-23	0.006	0.022	—	—	0.002	0.007	0.0085	0.032	0.04	0.02
D39EX PX-22	0.008	0.03	—	—	0.002	0.007	0.008	0.03	0.04	0.02
D39EX PX-23	0.006	0.022	—	—	0.002	0.007	0.008	0.03	0.04	0.02
D51EX, PX-22	0.01	0.04	—	—	0.002	0.008	0.0085	0.032	0.04	0.02
D61EX, PX-15E0	0.015	0.058	0.018	0.069	0.015	0.057	0.007	0.028	0.04	0.02
D61EX, PX-23	0.014	0.054	—	—	0.004	0.016	0.0135	0.051	0.04	0.02
D63E-12	0.01	0.038	0.02	0.075	0.015	0.057	0.006	0.024	0.04	0.02
D65EX, PX-16	0.015	0.056	0.013	0.048	0.013	0.048	0.007	0.028	0.04	0.02
D65EX, PX, WX-17	0.013	0.05	0.013	0.048	0.012	0.044	0.007	0.028	0.04	0.02
D68ESS-12A	0.01	0.038	0.02	0.075	0.015	0.057	0.006	0.024	0.04	0.02
D85EX-15E0	0.02	0.076	0.016	0.06	0.014	0.052	0.01	0.036	0.04	0.02
D85PX-15E0	0.02	0.076	0.016	0.06	0.019	0.072	0.01	0.036	0.04	0.02
D85EX-15R	0.02	0.076	0.016	0.06	0.014	0.052	0.01	0.036	0.04	0.02
D85PX-15R	0.02	0.076	0.016	0.06	0.019	0.072	0.01	0.036	0.04	0.02
D155A-5	0.021	0.08	0.016	0.06	0.032	0.12	0.013	0.05	0.07	0.03
D155A-6	0.02	0.074	0.018	0.07	0.016	0.062	0.012	0.046	0.07	0.03
D155AX-6	0.02	0.074	0.024	0.09	0.016	0.062	0.012	0.046	0.07	0.03
D155AX-7	0.02	0.074	0.024	0.09	0.016	0.062	0.012	0.046	0.07	0.03
D275A-5	0.029	0.11	0.024	0.09	0.021	0.08	0.021	0.08	0.09	0.04
D275A-5R	0.026	0.1	0.024	0.09	0.01	0.04	0.017	0.065	0.09	0.04
D275AX-5E0	0.026	0.1	0.024	0.09	0.01	0.04	0.017	0.065	0.09	0.04
D375A-5	0.032	0.12	0.04	0.15	0.019	0.07	0.016	0.06	0.09	0.04
D375A-5R	0.045	0.172	0.04	0.15	0.016	0.061	0.018	0.069	0.09	0.04
D375A-6, D375A-6R	0.045	0.172	0.04	0.15	0.016	0.061	0.017	0.065	0.09	0.04
D475A-5E0	0.064	0.242	0.055	0.21	0.02	0.075	0.022	0.085	0.11	0.05
D575A-3	0.137	0.52	0.093	0.35	0.042	0.16	0.04	0.15	0.13	0.06

*(1) Includes lubricant oil of compressor for Portable Air Compressor

*(2) Includes oils in the torque converter, main clutch and steering cases, differential, etc.

(2) Hydraulic excavators

Application Unit Q'TY	*(1) Crank case		Transmission or Swing Machinery		*(2) Final Drives		Hydraulic Control		Grease	
	US Gal	Liter	US Gal	Liter	US Gal	Liter	US Gal	Liter	lb	kg
Machine Model										
PC18MR-3, PC20MR-3	0.002	0.007	—	—	0.0003	0.001	0.003	0.010	0.04	0.02
PC27MR-3	0.004	0.014	—	—	0.0003	0.001	0.003	0.010	0.04	0.02
PC30MR-3, PC35MR-3	0.004	0.014	—	—	0.0003	0.001	0.003	0.010	0.04	0.02
PC45MR-3, PC55MR-3	0.004	0.015	—	—	0.0005	0.002	0.003	0.010	0.04	0.02
PC60-8, PC70-8	0.006	0.023	0.0005	0.002	0.0005	0.002	0.0032	0.012	0.09	0.04
PC78US-8	0.006	0.022	0.0005	0.002	0.0005	0.002	0.0032	0.012	0.09	0.04
PC88MR-8	0.006	0.022	0.0008	0.003	0.0005	0.002	0.003	0.011	0.09	0.04
PC130-8	0.006	0.022	0.0008	0.003	0.0011	0.004	0.0048	0.018	0.11	0.05
PC138US-8	0.006	0.022	0.0008	0.003	0.0011	0.004	0.0037	0.014	0.11	0.05
PC138US-10	0.006	0.023	0.0008	0.003	0.0011	0.004	0.0037	0.014	0.11	0.05
PC160LC-8	0.008	0.032	0.0013	0.005	0.0008	0.003	0.0063	0.024	0.11	0.05
PC190LC-8	0.008	0.032	0.0013	0.005	0.0013	0.005	0.007	0.028	0.11	0.05
PC200/LC-8, PC210/LC-8	0.012	0.046	0.0018	0.007	0.0008	0.003	0.007	0.027	0.15	0.07
PC200/LC-8M0	0.012	0.046	0.0018	0.007	0.0011	0.004	0.007	0.027	0.15	0.07
PC210/LC-10	0.012	0.046	0.0018	0.007	0.0013	0.005	0.007	0.027	0.15	0.07
PC220/LC-8	0.012	0.046	0.0021	0.008	0.0013	0.005	0.007	0.027	0.15	0.07
PC220/LC-8M0	0.012	0.046	0.0018	0.007	0.0013	0.005	0.0066	0.025	0.15	0.07
PC228US/LC-8	0.012	0.046	0.0018	0.007	0.0013	0.005	0.0066	0.025	0.15	0.07
PC240LC-10	0.012	0.046	0.0018	0.007	0.0013	0.005	0.007	0.026	0.15	0.07
PC270/LC-8	0.012	0.046	0.0021	0.008	0.0024	0.009	0.007	0.026	0.15	0.07
PC290LC-10	0.012	0.046	0.0021	0.008	0.0021	0.008	0.007	0.026	0.15	0.07
PC300/LC-7, PC350/LC-7	0.019	0.070	0.0037	0.014	0.0026	0.010	0.011	0.040	0.22	0.10
PC300/LC-8, PC350/LC-8	0.019	0.070	0.0045	0.017	0.0024	0.009	0.010	0.038	0.22	0.10
PC360LC-10	0.019	0.070	0.0045	0.017	0.0024	0.009	0.010	0.038	0.22	0.10
PC400/LC-7, PC450/LC-7	0.020	0.08	0.007	0.027	0.0034	0.013	0.013	0.050	0.26	0.12
PC400/LC-8, PC450/LC-8	0.020	0.074	0.0053	0.020	0.0029	0.011	0.013	0.050	0.26	0.12
PC400/LC-8R, P450/LC-8R	0.020	0.074	0.0053	0.020	0.0029	0.011	0.013	0.050	0.26	0.12
PC490LC-10	0.020	0.076	0.0053	0.020	0.0029	0.011	0.013	0.050	0.26	0.12
PC600/LC-8E0	0.021	0.080	0.0069	0.026	0.0026	0.010	0.019	0.072	0.35	0.16
PC600/LC-8R1	0.021	0.080	0.0069	0.026	0.0026	0.010	0.019	0.072	0.35	0.16
PC700LC-8E0	0.021	0.080	0.0069	0.026	0.0026	0.010	0.019	0.072	0.35	0.16
PC700LC-8R	0.021	0.080	0.0069	0.026	0.0026	0.010	0.019	0.072	0.35	0.16
PCPC750-7, PC800-7	0.032	0.120	0.013	0.050	0.0053	0.020	0.024	0.090	0.35	0.16
PC800-8E0, PC850-8E0	0.028	0.106	0.013	0.049	0.0053	0.020	0.025	0.094	0.35	0.16
PC800-8R1, PC850-8R1	0.028	0.106	0.013	0.049	0.0053	0.020	0.025	0.094	0.35	0.16
PC1250-7	0.032	0.120	0.013	0.050	0.006	0.022	0.037	0.140	0.40	0.18
PC1250-8, PC1250-8R	0.045	0.172	0.013	0.049	0.0055	0.021	0.035	0.134	0.44	0.20
PC2000-8	0.063	0.24	0.016	0.060	0.022	0.085	0.069	0.260	0.18	0.08

*(1) Includes lubricant of PTO case.

*(2) Includes lubricant of differential gear box.

	Total Capacities Per Excavator					Total Consumption Per Excavator (Including oil change volume)				
	Engine ltr. (US Gal)	PTO ltr. (US Gal)	Hydraulic Reservoir ltr. (US Gal)	Slew gears ltr. (US Gal)	Travel gears ltr. (US Gal)	Engine Oil ltr/h (US Gal/h)	Hydraulic Oil ltr/h (US Gal/h)*	Gear Oil ltr/h (US Gal/h)**	Central Lubrication kg/h (lb/h)	Slew ring gear Lubrication kg/h (lb/h)
PC3000-6 SSA12V159	190 (50.2)	90 (23.8)	2900 (766)	83 (21.9)	135 (35.7)	0.8 (0.21)	0.53 (0.14)	0.10 (0.026)	0.14 (0.31)	0.035 (0.08)
PC3000E-6	—	90 (23.8)	2900 (766)	83 (21.9)	135 (35.7)	—	0.53 (0.14)	0.10 (0.026)	0.14 (0.31)	0.035 (0.08)
PC4000-6 SDA16V160	866*** (229)	150 (39.6)	3900 (1030)	166 (43.9)	310 (81.9)	1.1 (0.29)	0.72 (0.19)	0.21 (0.055)	0.16 (0.35)	0.04 (0.09)
PC4000E-6	—	150 (39.6)	3900 (1030)	166 (43.9)	310 (81.9)	—	0.72 (0.19)	0.21 (0.055)	0.16 (0.35)	0.04 (0.09)
PC5500-6 2 x SSA12V159	380*** (100)	190 (50.2)	3800 (1004)	166 (43.9)	237 (62.6)	1.6 (0.42) 1.8*** (0.48)	0.70 (0.21)	0.20 (0.053)	0.18 (0.40)	0.05 (0.11)
PC5500E-6	—	153 (40.4)	3800 (1004)	166 (43.9)	237 (62.6)	—	0.70 (0.21)	0.19 (0.05)	0.18 (0.40)	0.05 (0.11)
PC8000-6 2 x SDA16V160	2214*** (585)	240 (63.4)	8350 (2206)	249 (65.8)	780 (206)	2.2*** (0.58)	1.53 (0.40)	0.43 (0.114)	0.20 (0.44)	0.06 (0.13)
PC8000E-6	—	240 (63.4)	8350 (2206)	100 (26.4)	900 (238)	—	1.53 (0.40)	0.42 (0.11)	0.20 (0.44)	0.06 (0.13)

* 10% of oil change volume between oil change intervals plus volume of oil change (latest every 6000 h)

** 2% of oil change volume between oil change interval (3000 h) plus volume of oil change

*** Including oil management system

(3) Off-highway dump trucks

Application Unit Q'TY	*(1) Crank case		*(2) Transmission		*(3) Final Drives		*(4) Hydraulic Control		Grease	
	US Gal	Liter	US Gal	Liter	US Gal	Liter	US Gal	Liter	lb	kg
HD255-5	0.02	0.076	0.018	0.07	0.002	0.016	0.011	0.04	0.04	0.02
HD325-6	0.029	0.11	0.024	0.09	0.016	0.06	0.019	0.07	0.04	0.02
HD325-7	0.026	0.10	0.024	0.09	0.01	0.038	0.009	0.033	0.04	0.02
HD325-7R	0.026	0.10	0.024	0.09	0.01	0.038	0.009	0.033	0.04	0.02
HD405-6	0.029	0.11	0.024	0.09	0.016	0.06	0.009	0.033	0.04	0.02
HD405-7	0.026	0.10	0.024	0.09	0.01	0.038	0.009	0.033	0.04	0.02
HD405-7R	0.026	0.10	0.024	0.09	0.01	0.038	0.009	0.033	0.04	0.02
HD465-7E0	0.042	0.16	0.057	0.215	0.018	0.069	0.008	0.031	0.04	0.02
HD465-7	0.042	0.16	0.057	0.215	0.018	0.069	0.008	0.031	0.04	0.02
HD465-7R	0.042	0.16	0.057	0.215	0.018	0.069	0.008	0.031	0.04	0.02
HD605-7E0	0.042	0.16	0.057	0.215	0.018	0.069	0.008	0.031	0.04	0.02
HD605-7R	0.042	0.16	0.057	0.215	0.018	0.069	0.008	0.031	0.04	0.02
HD785-7	0.069	0.26	0.054	0.205	0.035	0.133	0.012	0.044	0.07	0.03
HM300-1	0.019	0.07	0.021	0.08	0.013	0.05	0.008	0.03	0.04	0.02
HM300-2, HM300-2R	0.02	0.074	0.021	0.08	0.013	0.049	0.008	0.03	0.04	0.02
HM300-3	0.019	0.07	0.021	0.08	0.0124	0.047	0.007	0.026	0.04	0.02
HM350-1	0.029	0.11	0.032	0.12	0.019	0.07	0.013	0.05	0.04	0.02
HM350-2, HM350-2R	0.026	0.1	0.03	0.115	0.019	0.071	0.012	0.045	0.04	0.02
HM400-1	0.029	0.11	0.032	0.12	0.021	0.08	0.013	0.05	0.04	0.02
HM400-2, HM400-2R	0.026	0.1	0.03	0.115	0.020	0.075	0.012	0.045	0.04	0.02
HM400-3	0.026	0.1	0.033	0.125	0.018	0.07	0.011	0.042	0.04	0.02

*(1) Includes lubricant oil of compressor for Portable Air Compressor

*(2) Includes oils in the torque converter, main clutch and steering cases, differential, etc.

*(3) Includes oils in the differential case of Dump Truck

*(4) Includes oils in the brake cooling tank

(4) Wheel loaders and Wheel dozers

Application Unit Q'TY	*(1) Crank case		*(2) Transmission		Axle		*(3) Hydraulic Control		Grease	
	US Gal	Liter	US Gal	Liter	US Gal	Liter	US Gal	Liter	lb	kg
WA120-3	0.006	0.024	0.006	0.024	0.004	0.014	0.006	0.021	0.02	0.01
WA150-5	0.007	0.025	0.001	0.004	0.004	0.0143	0.006	0.024	0.02	0.01
WA150-6, WA150PZ-6	0.006	0.023	0.001	0.004	0.004	0.0143	0.006	0.024	0.02	0.01
WA180-3	0.011	0.043	0.006	0.024	0.004	0.014	0.006	0.021	0.02	0.01
WA200-5	0.010	0.039	0.0013	0.005	0.005	0.019	0.008	0.029	0.02	0.01
WA200-6, WA200PZ-6	0.008	0.031	0.0013	0.005	0.005	0.018	0.008	0.029	0.02	0.01
WA250-5	0.010	0.039	0.0016	0.006	0.005	0.018	0.009	0.034	0.02	0.01
WA250-6, WA250PZ-6	0.012	0.046	0.0013	0.005	0.005	0.018	0.009	0.034	0.02	0.01
WA320-3 Custom	0.010	0.040	0.007	0.028	0.006	0.024	0.015	0.058	0.02	0.01
WA320-5	0.010	0.039	0.002	0.007	0.006	0.024	0.012	0.045	0.02	0.01
WA320-6, WA320PZ-6	0.012	0.046	0.002	0.007	0.006	0.024	0.012	0.045	0.02	0.01
WA380-3	0.015	0.056	0.011	0.040	0.008	0.032	0.018	0.069	0.02	0.01
WA380-5	0.017	0.064	0.014	0.054	0.010	0.038	0.017	0.065	0.02	0.01
WA380-6, WA380Z-6	0.012	0.046	0.010	0.038	0.011	0.040	0.018	0.070	0.02	0.01
WA380-7	0.012	0.046	0.014	0.054	0.011	0.040	0.020	0.076	0.02	0.01
WA430-5	0.020	0.076	0.014	0.054	0.012	0.045	0.017	0.065	0.02	0.01
WA430-6	0.016	0.060	0.014	0.054	0.012	0.045	0.018	0.070	0.02	0.01
WA470-3	0.020	0.076	0.016	0.06	0.017	0.065	0.025	0.096	0.02	0.01
WA470-5	0.020	0.076	0.014	0.054	0.014	0.052	0.025	0.095	0.02	0.01
WA470-6**	0.020	0.076	0.017	0.065	0.0153	0.058	0.023	0.087	0.02	0.01
WA470-7	0.020	0.076	0.017	0.065	0.015	0.057	0.023	0.087	0.02	0.01
WA480-6**	0.020	0.076	0.017	0.065	0.016	0.059	0.023	0.087	0.02	0.01
WA500-3	0.020	0.074	0.016	0.062	0.021	0.078	0.023	0.088	0.04	0.02
WA500-6, WA500-6R	0.020	0.074	0.020	0.076	0.022	0.084	0.045	0.169	0.04	0.02
WA500-7	0.020	0.074	0.019	0.071	0.025	0.095	0.045	0.169	0.04	0.02
WA600-3	0.032	0.120	0.029	0.110	0.033	0.124	0.046	0.173	0.04	0.02
WA600-6, WA600-6R	0.045	0.172	0.022	0.083	0.041	0.155	0.059	0.222	0.04	0.02
WA700-3	0.027	0.104	0.028	0.105	0.083	0.315	0.062	0.235	0.04	0.02
WA800-3	0.070	0.264	0.037	0.140	0.095	0.360	0.096	0.363	0.04	0.02
WA800-3E0	0.069	0.260	0.037	0.140	0.095	0.360	0.096	0.363	0.04	0.02
WA900-3	0.070	0.264	0.037	0.140	0.095	0.360	0.096	0.363	0.04	0.02
WA900-3E0	0.069	0.260	0.037	0.140	0.095	0.360	0.096	0.363	0.04	0.02
WA1200-6	0.148	0.560	0.079	0.300	0.177	0.670	0.180	0.680	0.04	0.02
WD600-3	0.032	0.120	0.029	0.110	0.033	0.124	0.029	0.108	0.04	0.02
WD600-6	0.045	0.172	0.022	0.083	0.041	0.155	0.059	0.222	0.04	0.02
WD900-3	0.070	0.264	0.037	0.140	0.095	0.360	0.096	0.363	0.04	0.02

*(1) Includes lubricant oil of compressor for Portable Air Compressor
 *(2) Includes oils in the torque converter, main clutch and steering cases, differential, etc.
 *(3) Includes oils in the brake cooling tank
 ** With large-capacity torque convertor

(5) Motor graders

Application Unit Q'TY	*(1) Crank case		*(2) Transmission		*(3) Final Drives and Axle		Hydraulic Control		Grease	
	US Gal	Liter	US Gal	Liter	US Gal	Liter	US Gal	Liter	lb	kg
GD511A-1	0.010	0.036	0.009	0.034	0.006	0.024	0.008	0.030	0.04	0.02
GD555-5	0.012	0.046	0.012	0.045	0.024	0.091	0.009	0.035	0.04	0.02
GD655-5	0.012	0.046	0.012	0.045	0.024	0.091	0.009	0.035	0.04	0.02
GD663A-2	0.032	0.12	0.009	0.035	0.023	0.086	0.008	0.030	0.04	0.02
GD675-5	0.024	0.092	0.012	0.045	0.024	0.091	0.009	0.035	0.04	0.02
GD705A-4	0.025	0.096	0.006	0.024	0.036	0.137	0.008	0.030	0.04	0.02
GD755-5R	0.02	0.076	0.013	0.05	0.034	0.128	0.007	0.026	0.09	0.04
GD825A-2	0.018	0.068	0.007	0.025	0.040	0.152	0.021	0.080	0.09	0.04

*(1) Includes lubricant oil of compressor for Portable Air Compressor
 *(2) Includes oils in the torque converter, main clutch and steering cases, differential, etc.
 *(3) Includes oils in the tandem case of Motor Grader

Table 4 Approximate Tire Life

Machine	Easy Condition	Medium Condition	Severe Condition
Off-Highway Dump Trucks	4,000 ~ 6,000	2,000 ~ 4,000	1,000 ~ 2,000
Articulated Dump Trucks	7,000	5,000	3,000
Motor Graders	3,000	2,000	1,000
Wheel Loaders	4,000 ~ 6,000	2,000 ~ 4,000	1,000 ~ 2,000
Wheel Dozers	3,000	2,000	1,000
Hydraulic Excavators	3,000	2,000	1,000
	Traveling on well-maintained roads, or in silt or sand, tire wear is normal.	Traveling on gravelly surfaces, tire wear is normal but occasionally cut by rocks.	Tire wear mostly due to rock-cut, liable to puncture frequently.

The life varies with brand and material. Tires may be used above or below the tire life expectancy given in this table.

Table 5 Approximate Usable Hours of Special Items

Item	Easy Range	Medium Range	Severe Range
Ripper Point	150	30	15
Shank Protector	1,500	450	150
Shank	7,000	3,500	2,000

Fleet Recommendation & Application Engineering

Optimum Fleet Recommendation (OFR) software program OFR V6.31 is available for Komatsu distributors. The OFR is able to simulate and recommend optimum fleet for the targeted production with followings.

1. Machine selection based on site conditions and production target.
2. Estimation of each machine's production.
3. Estimation of owning and operating costs.
4. Estimation of production cost.



Available machine type in the database

1. Dump truck
2. Wheel loader
3. Hydraulic excavator
4. Bulldozer
5. Mobile crusher & recycler

Report contents

1. Production condition, object material, cost data
2. Optimum machine combination
3. Production
4. Number of units
5. Production cost

For Customer

Please contact the nearest Komatsu distributor with your specific conditions, application and requirements. Distributor's application engineer will support your fleet evaluation.

Required information. *1

1. Ore type, material density, production target (per year, per hour, operational days, shifts).
2. Haul road profile. (Please ask application engineering support from distributor)

*1 The required information listed above is the most basic items for estimation. To get accurate estimation result, distributor may ask additional information to provide.

Repair and Maintenance Cost Estimation

For the estimation of Repair and Maintenance cost, repair and maintenance cost estimating software WebKIRD V3.2 (Komatsu Information on Reliability and Durability) is available for Komatsu distributors. By using this software, distributor can calculate Repair and Maintenance cost for Komatsu equipment with local conditions such as followings.

1. Parts price (Each country has different import duty, transportation charge and etc.)
2. Hourly labor charges
3. Lubricants prices
4. Repairing methods (Repair option
 - Rebuild
 - REMAN (Komatsu component exchange)
5. Man- hours
6. Component and system replacement intervals per operating conditions
 - Application
 - Environments
 - Handling materials (Ore type)
 - Operating methods



For Customer

Please contact the nearest Komatsu distributor with your specific model, application and requirements.

MEMO

A series of horizontal dashed lines for writing.

CONTENTS

INDEX

SECTION **16**

UNIT CONVERSION TABLES Sec 16



SECTION **16**

**UNIT CONVERSION
TABLES**

CONTENTS

Unit Conversion Tables 16-2

a. Length

Centimeter (cm)	Meter (m)	Inch (in)	Foot (ft)	Yard (yd)	Mile (M)	Kilometer (km)
1	0.01	0.3937	0.03281	0.01094	1	1.6093
100	1	39.37	3.281	1.0936	0.6214	1
2.540	0.0254	1	0.8333	0.02778		
30.48	0.3048	12	1	0.3333		
91.44	0.9144	36	3	1		

b. Space

Sq. meter (m ²)	Sq. Inch (in ²)	Sq. foot (ft ²)	Sq. yard (yd ²)
1	1550	10.764	1.1960
0.0 ₃ 6452	1	0.0 ₂ 6944	0.0 ₃ 7716
0.09290	144	1	0.11111
0.8361	1296	9	1

c. Volume

Cu. meter(m ³)	Cu. inch(in ³)	Cu. foot(ft ³)	Cu. yard(yd ³)	Imperial Gal	U.S. Gal	Cu. Inch	Liter
1	61024	35.31	1.3079	1	1.201	177.4	4.546
0.0 ₁ 639	1	0.0 ₃ 5787	0.0 ₁ 2143	0.8327	1	231	3.785
0.02832	1728	1	0.037037	0.0 ₂ 3605	0.0 ₂ 4329	1	0.01639
0.76455	46656	27	1	0.2200	0.2642	61.02	1

d. Weight

Kilogram (kg)	Pound (lb)	Metric Ton (French Ton)	Short Ton (U.S. Ton)	Long Ton (English Ton)	Newton (N)
1	2.2046	0.001	0.0011023	0.0 ₃ 9842	9.80665
0.4536	1	0.0 ₃ 4536	0.0 ₃ 5	0.0 ₃ 4464	4.448
1000	2204.6	1	1.1023	0.9842	9806.65
907.1	2000	0.9072	1	0.8929	8896.5
1016	2240	1.016	1.120	1	9964
0.10197	0.2248	0.0 ₃ 1019	0.0 ₃ 1124	0.0 ₃ 1004	1

e. Pressure

BAR	Kilogram/sq.cm (kg/cm ²)	Pound/sq.in (PSI)	Long ton/sq.ft (Ton/ft ²)	Pascal (Pa)
1	1.0197	14.50	0.9324	100000
0.9807	1	14.22	0.9144	98066.5
0.06895	0.07031	1	0.06429	6895
1.0725	1.0937	15.56	1	107250
0.00001	0.00001020	0.000145	0.0000932	1

f. Velocity

m/sec	km/h	ft/sec.	MPH
1	3.6	3.281	2.237
0.2778	1	0.9113	0.6214
0.3048	1.097	1	0.6818
0.4470	1.609	1.467	1

g. Horsepower

PS	HP	kW	kg.m/s	kCal
1	0.986	0.736	75	0.1757
1.014	1	0.746	76.07	0.1782
1.3592	1.3405	1	101.97	0.2389
0.01333	0.01315	0.009807	1	0.002343
5.6902	5.611	4.186	426.9	1

h. Torque

kg.m	ft.lb	N.m
1	7.233	9.807
0.1383	1	1.356
0.1020	0.7375	1

i. Temperature

32°F = 0°C, -459.67°F = -273.15°C, 1°F = 0.5556°C

°F	°C	°F	°C	°F	°C	°F	°C		
-450	-267.78	5	-15.00	55	12.78	150	65.56		
-400	-240.00	10	-12.22	60	15.56	200	93.33		
-350	-212.22	15	-9.44	65	18.33	250	121.11		
-300	-184.44	20	-6.67	70	21.11	300	148.89		
-250	-156.67	25	-3.89	75	23.89	350	176.67		
-200	-128.89	30	-1.11	80	26.67	400	204.44		
-150	-101.11	35	1.67	85	29.44	450	232.22		
-100	-73.33	40	4.44	90	32.22	500	260.00		
-50	-45.56	45	7.22	95	35.00	550	287.78		
0	-17.78	50	10.00	100	37.78	600	315.56		
°F	1	2	3	4	5	6	7	8	9
°C	0.556	1.111	1.667	2.222	2.778	3.333	3.889	4.444	5
Example: To convert 92°F into °C 90°F = 32.22°C, 2°F = 1.111°C, 90°F+2°F = 33.33°C									

j. Angles of Gradient

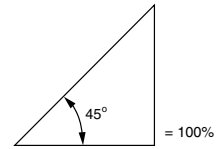

Angles of gradient	%	Angles of gradient	%	%	Angles of gradient	%	Angles of gradient
1°	1.75	26°	48.77	1	0°34'	26	14°34'
2	3.49	27	50.95	2	1°00'	27	15°07'
3	5.24	28	53.17	3	1°43'	28	15°39'
4	6.99	29	55.43	4	2°18'	29	16°10'
5	8.75	30	57.74	5	2°52'	30	16°42'
6	10.51	31	60.09	6	3°26'	31	17°13'
7	12.28	32	62.49	7	4°00'	32	17°45'
8	14.05	33	64.94	8	4°34'	33	18°16'
9	15.84	34	67.45	9	5°09'	34	18°47'
10	17.63	35	70.02	10	5°43'	35	19°17'
11	19.44	36	72.65	11	6°17'	36	19°48'
12	21.26	37	75.35	12	6°51'	37	20°18'
13	23.09	38	78.13	13	7°25'	38	20°48'
14	24.93	39	80.98	14	7°58'	39	21°18'
15	26.80	40	83.91	15	8°32'	40	21°48'
16	28.67	41	86.93	16	9°05'	41	22°18'
17	30.57	42	90.04	17	9°39'	42	22°47'
18	32.49	43	93.25	18	10°12'	43	23°16'
19	34.43	44	96.57	19	10°45'	44	23°45'
20	36.40	45	100.00	20	11°19'	45	24°14'
21	38.39	46	103.35	21	11°52'	46	24°42'
22	40.40	47	107.24	22	12°24'	47	25°10'
23	42.45	48	111.06	23	12°57'	48	25°39'
24	44.52	49	115.04	24	13°30'	49	26°06'
25	46.63	50	119.08	25	14°02'	50	26°34'

A			
Air dryer.....	4A-43		
Altitude deration.....	11-8		
Angle dozer.....	1B-2		
Arm crowd force.....	2A-96		
Asphalt debris.....	8A-5		
Attachment and options			
Motor graders.....	5-13		
Rigid dump trucks.....	4A-40		
Attachment availability			
Motor graders.....	5-7		
Wheel loaders.....	3A-144		
Attachments of excavator			
Backhoe dredger.....	2H-4		
Car scrap handler.....	2G-6		
Clamshell buckets.....	2C-2		
Demolition high reach.....	2F-4		
Demolition two piece boom.....	2F-10		
Ditch cleaning buckets.....	2C-2		
High-mount cab.....	2G-5		
Lifting magnet.....	2G-6		
Magnet fork.....	2G-6		
Orange grapple.....	2G-6		
Ripper bucket.....	2C-2		
Scrap handling machine.....	2G-2		
Single-shank rippers.....	2C-2		
Slope finishing buckets.....	2C-2		
Super long front.....	2C-5		
Telescopic arm (sliding type).....	2C-4		
Trapezoidal buckets.....	2C-2		
Attachments of motor grader			
Front dozer blade.....	5-10		
Rear mounted ripper.....	5-11		
Scarifier.....	5-8		
Attachments of wheel loader			
Dumping fork spec.....	3A-176		
High lift boom spec.....	3A-186		
Log grapple spec.....	3A-178		
Lumber fork spec.....	3A-177		
Lumber grapple spec.....	3A-175		
Automatic three-mode suspension.....	4A-41		
Automatic retard speed control.....	4A-41		
B			
Beads.....	12-5		
Bench height.....	2A-120		
Bench width.....	14B-12		
Blade accumulator.....	5-15		
Blade availability.....	1B-4		
Blade fill factor.....	14A-4		
Blade float.....	5-16		
Blade selection.....	1B-2		
Body extension.....	4A-42, 4A-57		
Body liner.....	4A-42, 4A-53		
Body selection.....	4A-52		
Bolt-on cutting edge.....	3A-152		
Bolt-on teeth.....	3A-152		
Brake performance curve			
HD255-5.....	4A-13		
HD325-7, HD325-7R.....	4A-15		
HD325-6.....	4A-17		
HD405-7, HD405-7R.....	4A-19		
HD405-6.....	4A-21		
HD465-7E0, HD465-7R.....	4A-23		
HD465-7.....	4A-25		
HD605-7E0, HD605-7R.....	4A-27		
HD785-7.....	4A-29		
HD1500-7.....	4A-32		
730E.....	4A-33		
830E-AC.....	4A-34		
860E-1K.....	4A-35		
930E-4.....	4A-36		
930E-4SE.....	4A-37		
960E-2.....	4A-38		
960E-2K.....	4A-39		
HM300-3.....	4B-12		
HM300-2, HM300-2R.....	4B-13		
HM300-1.....	4B-14		
HM350-2, HM350-2R.....	4B-15		
HM350-1.....	4B-16		
HM400-3.....	4B-17		
HM400-2, HM400-2R.....	4B-18		
HM400-1.....	4B-19		
Breaker.....	12-4		
Breakout force.....	3A-141		
Bucket and arm combinations			
Excavators, backhoes.....	2A-97		
Wheel-type excavators.....	2E-9		
Bucket capacity.....	3A-141		
Bucket capacity definition.....	2A-94		
Bucket capacity rating.....	2A-94		
Bucket digging force.....	2A-96		
Bucket fill factor			
Excavators, backhoes.....	2A-128		
Wheel loaders.....	3A-195		
Bucket features.....	3A-151		
Bucket load.....	3A-141		
Bucket selection			
Excavators, backhoes.....	2A-95		
Wheel loaders.....	3A-156		
Bucket width.....	2A-96		
C			
Calculation of production.....	14A-2		
Canopy spill guard.....	4A-59		
Carcass.....	12-5		
Carry position.....	3A-143		
Chip bucket.....	2C-3, 3A-151		
Coal bucket.....	2C-3		
Coal dozer.....	1B-3		
Component dimensions and weights			
Excavators, backhoes.....	2A-60		
Hydraulic loading shovels.....	2D-11		
Concrete debris.....	8A-5		
Cone index numbers (qc).....	14B-11		
Conventional tire.....	12-4		
Conversion tables.....	16-2		
Cross loading.....	14A-6		
D			
Depreciation.....	15-2		
Design tread-depth.....	12-8		
Differential lock.....	4A-42		
Digging force			
Excavators, backhoes.....	2A-49, 2A-96		
Hydraulic loading shovels.....	2D-10		
Wheel-type excavators.....	2E-7		
Dimensions			
Articulated dump trucks.....	4B-9		
Backhoe loaders.....	6-4		
Excavators, backhoes.....	2A-35		
Forwarders.....	9B-5		
Harvesters.....	9A-4		
Hydraulic loading shovels.....	2D-8		
Motor graders.....	5-6		
Rigid dump trucks.....	4A-9		
Tracked feller bunchers.....	9C-4		

INDEX

- Wheel dozers 3B-4
Wheel loaders 3A-27
Wheel-type excavators 2E-5
Drawbar pull vs. travel speed 1A-18
Dual tiltdozer 1B-2, 1B-19
Dumping clearance and reach 3A-143
Dumping fork 3A-176
- ## E
- Earth volume conversion factor 14A-2
EGR (Exhaust Gas Recirculation) 11-4
Elements limiting the inherent machine capability 14B-5
Engines used in KOMATSU machine 11-3
Estimating rippability 1C-13
Estimated production
 Bulldozers 1B-27
 Excavators, backhoes 2A-128
 Hydraulic loading shovels 2D-26
 Rigid dump trucks 4A-60
 Rippers 1C-13
 Wheel loaders 3A-195
Estimating the owning & operating costs 15-2
Exhaust retarder 4A-41
Extension blade 5-15
Extension fork 3A-173
- ## F
- 5-stage dust indicator 13A-4
Features
 Articulated dump trucks 4B-2
 AVANCE series (Wheel loaders) 3A-2
 Bulldozers 1B-2
 Backhoe loaders 6-2
 Compact track loaders 7B-2
 Crawler-type tractors 1A-2
 Dash-8 series 2A-5
 Dash-7 series 2A-6
 Dash-10 series 2A-3
 Engines 11-2
 Fork equipment 3A-172
 Forwarders 9B-2
 Generator sets 10-2
 Harvesters 9A-2
 Hydraulic loading shovels 2D-2
 Mobile crushers & recyclers 8A-3
 Mobile soil recyclers 8B-2
 Motor graders 5-2
 Rigid dump trucks 4A-2
 Pipelayers 1E-2
 Rippers 1C-2
 Rubber crawler 2A-9
 Skid steer loaders 7A-2
 Tracked feller bunchers 9C-2
 Wheel dozers 3B-2
 Wheel loaders 3A-2
 Wheel-type excavators 2E-2
Felling head 9D-4
Front blade 5-15
Front pull hook 5-15
Fuel consumption 15-10
Fueling deration rate 11-8
- ## G
- General purpose bucket 3A-151
Grade factor 14A-5
 Bulldozers 1B-27
Grade resistance 14B-8
- Ground pressure
 Articulated dump trucks 4B-20
 Excavators, backhoes 2A-85
 Crawler-type tractors 1A-23
- ## H
- Harvester head 9A-5
Haulage analysis tool (HAT) 13B-2
Hauling performance of construction machines 14B-4
Hauling resistance 14B-8
Heaped capacity 2A-94
Heat resistance spec. 2H-5
Heavy-duty bucket 3A-151
Hensley teeth 2A-113
High altitude deration 11-8
HPCR (Heavy duty High Pressure
 Common Rail) 11-4
Hydraulic cycle times 3A-142
- ## I
- Inboard work spec. 2H-2
Inherent machine capability 14B-4
Inner liner 12-4
Insurance 15-3
Interest 15-3
- ## J
- Jaw crusher 8A-4
Job efficiency
 Bulldozers 1B-27
 Excavators, backhoes 2A-128
 Rigid dump trucks 4A-60
 Wheel loaders 3A-195
- ## K
- KCCV (Komatsu Closed Crankcase Ventilation) 11-4
KDOC (Komatsu Diesel Oxidation Catalyst) 11-3
KDPF (Komatsu Diesel Particulate Filter) 11-3
KIRD 15-25
KMAX and XS teeth
 Excavators, backhoes 2A-112
 Wheel loaders 3A-153
KVGT (Komatsu Variable Geometry
 Turbocharger) 11-3
- ## L
- Lifting capacity
 Excavators, backhoes 2B-2
 Wheel-type excavators 2E-11
Light material bucket 3A-151
Liner-less body 4A-52
Load and carry 14A-7
Loader definition 3A-141
Loading shovel buckets 2D-24
Loading work 3A-174
Lock/unlock differential gear 5-16
Log grapple 3A-172
Log selection work 3A-174
Log-lumber fork 3A-172
Log-lumber grapple 3A-172
Logger performance 3A-180
Lubricant consumption 15-19
Lumber fork 3A-172
Lumber grapple 3A-172

INDEX

M

Machine capabilities required for earthmoving operations	14B-7
Model selection.....	2A-119
Multi-coupler.....	3A-173
Multi-purpose bucket	
Wheel loaders.....	3A-151

N

Non-spin differential.....	5-16
----------------------------	------

O

Operating weight	3A-141
Operating costs	15-4
Operator wages	15-5
O-ring (rim packing).....	12-5
Output rating.....	10-3
Owning cost.....	15-2
Optimum fleet recommendation (OFR)	15-24

P

Payload meter	4A-41
Performance data	
Wheel loaders.....	3A-27
Pick-up selection	3A-174
Pipe grapple	3A-172
PMC (power train management control).....	4A-41
Plies.....	12-4
Power angle-tiltdozer.....	1B-2, 1B-12
Pressurized hydraulic tank	13A-5
Pull-out selection	3A-174
Push plate.....	5-15

R

Radial tire	12-7
Radiator shutter	4A-43
Rake dozer	1B-3
Rear protector.....	1F-3
Repair cost	15-5
Resale or trade-in values.....	15-3
Ripper point selection.....	1C-10
Ripper selection.....	1C-9
Rock body.....	4A-52
Rolling gusset.....	3A-173
Rolling resistance	14B-7
ROPS canopy.....	5-14
Rubber pad shoe.....	2A-9
Rubber shoe	2A-9

S

Scarifier	5-15
Scooping.....	3A-174
Semi-U-tiltdozer	1B-2
Shoe application	
Crawler-type tractor	1A-26
Excavators, backhoes.....	2A-81
Shoe selection	
Crawler-type tractors	1A-27
Excavators, backhoes.....	2A-80
Shredded wire under tire tread	12-5
Side dump bucket	
Wheel loaders.....	3A-151
Side steel breaker tire.....	12-5
Side-walls	12-5
SIGMADOZER	1B-3
Single grouser shoe.....	1A-27
Skeleton bucket.....	3A-151

Snow shoe.....	1A-27
Soil classification for earthmoving operations	14B-2
Specifications	
Articulated dump trucks.....	4B-7
Backhoe loaders.....	6-3
Bulldozers	
Angle dozer.....	1B-10
Coal dozer	1B-26
Power angle-tiltdozer	1B-12
Power-tilt power-pitch dozer	1B-9
Semi-U-tiltdozer	1B-16
SIGMADOZER.....	1B-20
Straight-tiltdozer.....	1B-7
Trimming dozer.....	1F-7
U-tiltdozer	1B-22
Compact track loaders.....	7B-3
Crawler-type tractors	1A-9
Engines.....	11-5
Excavators, backhoes	2A-12
Forwarders	9B-3
Generator sets.....	10-3
Harvesters	9A-3
Hydraulic loading shovels.....	2D-4
Mobile crushers & recyclers	8A-6
Mobile soil recyclers	8B-3
Motor graders	5-4
Pipelayers.....	1E-3
Rigid dump trucks.....	4A-5
Rippers	
Giant ripper	1C-7
Multi-shank ripper (Rigid type).....	1C-3
Multi-shank ripper (Variable type).....	1C-5
Skid steer loaders.....	7A-3
Tracked feller bunchers	9C-3
Towing winchs	1D-2
Wheel dozers.....	3B-3
Wheel loaders.....	3A-16
Wheel-type excavators	2E-3
Spade-nose rock bucket.....	3A-151
Static tipping load	3A-142
Steel breaker tire	12-5
Straight-tiltdozer	1B-2
Straight dozer	1B-2
Struck capacity	2A-94
Sulfer	13A-3
Swamp shoe.....	1A-27

T

Teeth selection	2A-112
Three-way emergency brake.....	4A-42
Tip radius.....	2A-96
Tip-type teeth	3A-152
Tire availability	
Wheel loaders.....	3A-187
Tire characteristics	12-9
Tire classifications	12-2
Tire ground pressures	4B-20
Tire identification	12-10
Tire life.....	15-23
Tire manufacturer's designation	12-3
Tire selection	
Articulated dump tracks.....	4B-23
Rigid dump trucks.....	4A-44
Tire size designation	12-4
Tire pattern	4A-50, 4B-25
TKPH (TMPH)	12-8
TMPH rating	4A-44
TORQFLOW drive type tractor.....	14B-5
Trafficability	14B-11

INDEX

Travel performance curve

Rigid dump trucks

HD255-5.....	4A-13
HD325-7, HD325-7R.....	4A-15
HD325-6.....	4A-17
HD405-7, HD405-7R.....	4A-19
HD405-6.....	4A-21
HD465-7E0, HD465-7R.....	4A-23
HD465-7.....	4A-25
HD605-7E0, HD605-7R.....	4A-27
HD785-7.....	4A-29
HD1500-7.....	4A-32
730E.....	4A-33
830E-AC.....	4A-34
860E-1K.....	4A-35
930E-4.....	4A-36
930E-4SE.....	4A-37
960E-2.....	4A-38
960E-2K.....	4A-39

Articulate dump trucks

HM300-3.....	4B-12
HM300-2, HM300-2R.....	4B-13
HM300-1.....	4B-14
HM350-2, HM350-2R.....	4B-15
HM350-1.....	4B-16
HM400-3.....	4B-17
HM400-2, HM400-2R.....	4B-18
HM400-1.....	4B-19

Travel time

Rigid dump trucks.....	4A-60
Tread.....	12-4
Tread pattern.....	12-8
Trimming blade.....	1F-3
Trimming operation in vessel.....	1F-2
Triple grouser shoe.....	1A-27
Tubes and flaps.....	12-5

U

U-tiltadozer.....	1B-3
Use of brake performance curve.....	4A-12
Use of travel performance curve	
Rigid dump trucks.....	4A-12
Upper attachment	
Crawler-type tractors.....	1A-31
Motor graders.....	5-12

V

V-shape loading.....	14A-7
VFT (Variable Flow Turbocharger).....	11-3

W

Water separator.....	4A-43, 13A-3
Wet type disc brake.....	5-16
Working range	
Excavators backhoes.....	2A-49
Hydraulic loading shovels.....	2D-10
Wheel-type excavators.....	2E-7